



website <http://www.lgservice.com>  
e-mail <http://www.lgservice.com/techsup.html>

LG

ENGLISH

ITALIANO

ESPAÑOL

FRANÇAIS

DEUTSCH

# **MULTI V™** System Heat Pump Indoor Unit **INSTALLATION MANUAL**

**MODELS: B1/B2 Series**

**Type: Ceiling Concealed Duct - Low Static**

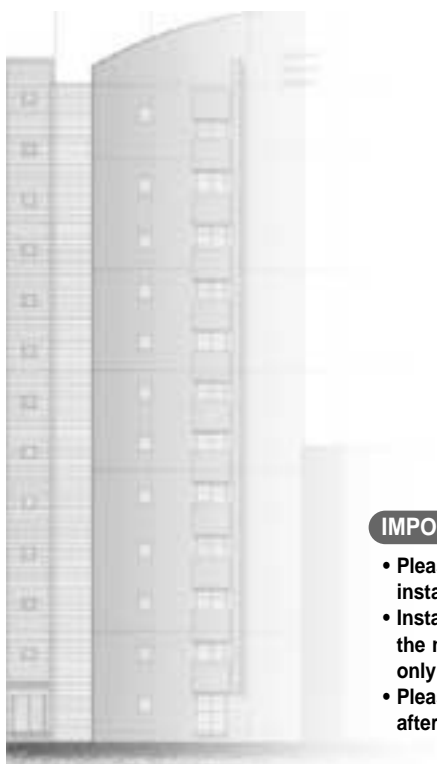

## IMPORTANT

- Please read this installation manual completely before installing the product.
- Installation work must be performed in accordance with the national wiring standards by authorized personnel only.
- Please retain this installation manual for future reference after reading it thoroughly.

# TABLE OF CONTENTS

<b>Installation Requirements</b>	<b>Required Parts</b>	<b>Required Tools</b>
<b>Safety Precautions</b> .....3		
<b>Introduction</b> .....6		
<b>Installation</b>		
Selection of the best location .....7	<input type="checkbox"/> Four type "A" screws <input type="checkbox"/> Connecting cable	<input type="checkbox"/> Level gauge <input type="checkbox"/> Screw driver <input type="checkbox"/> Electric drill <input type="checkbox"/> Hole core drill
Ceiling opening dimension and hanging bolt location .....8	<input type="checkbox"/> Pipes: Gas side Liquid side (Refer to Product Data) <input type="checkbox"/> Insulation materials <input type="checkbox"/> Additional drain pipe	<input type="checkbox"/> Flaring tool set <input type="checkbox"/> Specified torque wrenches (different depending on model No.) <input type="checkbox"/> Spanner .....Half union
Indoor Unit Installation .....9		
Wiring Connection .....9		<input type="checkbox"/> A glass of water <input type="checkbox"/> Screw driver
Part name and functions .....10		<input type="checkbox"/> Hexagonal wrench <input type="checkbox"/> Gas-leak detector <input type="checkbox"/> Vacuum pump <input type="checkbox"/> Gauge manifold
Checking the Drainage .....11		<input type="checkbox"/> Owner's manual <input type="checkbox"/> Thermometer
Two Thermistor system .....16		
E.S.P.(External Static Pressure) Setting .....17		
How to Set E.S.P? .....18		

# Safety Precautions



To prevent injury to the user or other people and property damage, the following instructions must be followed.

- Be sure to read before installing the air conditioner.
- Be sure to observe the cautions specified here as they include important items related to safety.
- Incorrect operation due to ignoring instruction will cause harm or damage. The seriousness is classified by the following indications.

**⚠ WARNING** This symbol indicates the possibility of death or serious injury.

**⚠ CAUTION** This symbol indicates the possibility of injury or damage to properties only.

- Meanings of symbols used in this manual are as shown below.

	<b>Be sure not to do.</b>
	<b>Be sure to follow the instruction.</b>

## ⚠ WARNING

### ■ Installation

**Do not use a defective or under-rated circuit breaker. Use this appliance on a dedicated circuit.**

- There is risk of fire or electric shock.

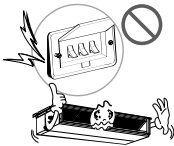

**For electrical work, contact the dealer, seller, a qualified electrician, or an Authorized Service Center.**

- Do not disassemble or repair the product. There is risk of fire or electric shock.



**Always ground the product.**

- There is risk of fire or electric shock.

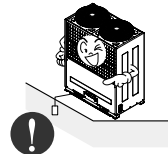

**Install the panel and the cover of control box securely.**

- There is risk of fire or electric shock.



**Always install a dedicated circuit and breaker.**

- Improper wiring or installation may cause fire or electric shock.



**Use the correctly rated breaker or fuse.**

- There is risk of fire or electric shock.



## Safety Precautions

**Do not modify or extend the power cable.**

- There is risk of fire or electric shock.

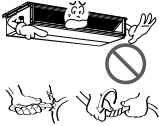

**Do not let the air conditioner run for a long time when the humidity is very high and a door or a window is left open.**

- Moisture may condense and wet or damage furniture.



**Be cautious when unpacking and installing the product.**

- Sharp edges could cause injury. Be especially careful of the case edges and the fins on the condenser and evaporator.



**For installation, always contact the dealer or an Authorized Service Center.**

- There is risk of fire, electric shock, explosion, or injury.



**Do not install the product on a defective installation stand.**

- It may cause injury, accident, or damage to the product.



**Be sure the installation area does not deteriorate with age.**

- If the base collapses, the air conditioner could fall with it, causing property damage, product failure, and personal injury.

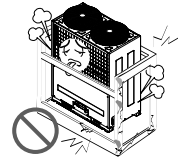

## ■ Operation

**Do not store or use flammable gas or combustibles near the product.**

- There is risk of fire or failure of product.



**CAUTION**

**Installation**

**Always check for gas (refrigerant) leakage after installation or repair of product.**

- Low refrigerant levels may cause failure of product.

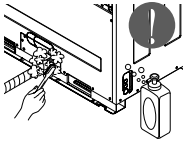

**Install the drain hose to ensure that water is drained away properly.**

- A bad connection may cause water leakage.

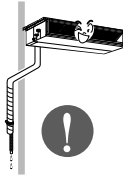

**Keep level even when installing the product.**

- To avoid vibration or water leakage.

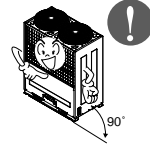

**Do not install the product where the noise or hot air from the outdoor unit could damage the neighborhoods.**

- It may cause a problem for your neighbors.



**Use two or more people to lift and transport the product.**

- Avoid personal injury.



**Do not install the product where it will be exposed to sea wind (salt spray) directly.**

- It may cause corrosion on the product. Corrosion, particularly on the condenser and evaporator fins, could cause product malfunction or inefficient operation.

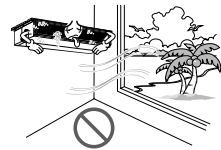

# Introduction

## Symbols Used in this Manual



This symbol alerts you to the risk of electric shock.



This symbol alerts you to hazards that could cause harm to the air conditioner.

**NOTICE**

This symbol indicates special notes.

## Features

### B1/B2 Series : Low static Duct type

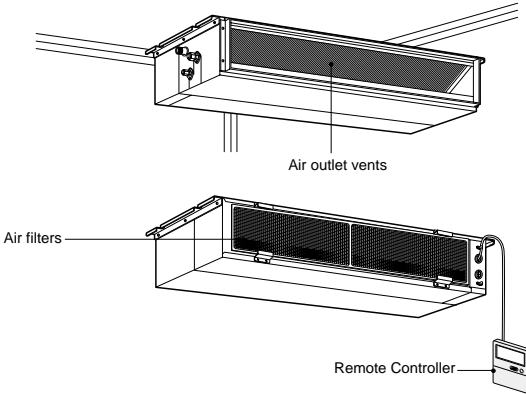

# Installation

## Selection of the best location

### Indoor unit

Install the air conditioner in the location that satisfies the following conditions.

- The place shall easily bear a load exceeding four times the indoor unit's weight.
- The place shall be able to inspect the unit as the figure.
- The place where the unit shall be leveled.
- The place shall easily connect with the outdoor unit.
- The place where the unit is not affected by an electrical noise.
- The place where air circulation in the room will be good .
- There should not be any heat source or steam near the unit

Confirm the positional relationship between the unit and suspension bolts.

- Installation the ceiling opening to clean the filter or service under the product.

(Length: mm)

Model	A	B
7/9/12k	600	900
18/24k	600	1100

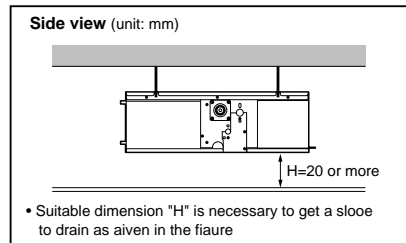
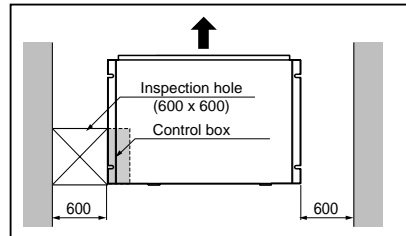

### B1/B2 Series : Low static Duct type

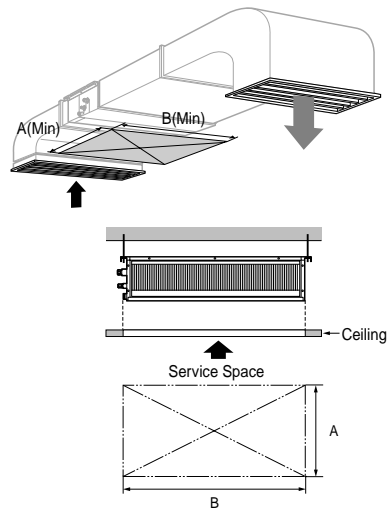

## Ceiling dimension and hanging bolt location

### Installation of Unit

Install the unit above the ceiling correctly.

#### CASE 1

##### POSITION OF SUSPENSION BOLT

- Apply a joint-canvas between the unit and duct to absorb unnecessary vibration.
- Apply a filter Accessory at air return hole.

(Unit:mm)

Dimension \ Capacity	A	B	C	D	E	F	G	H	I	J
7/9/12k BTU/h	850	900	383	575	93	190	21	795	163	820
18/24k BTU/h	1130	1180	383	575	93	190	21	1065	163	1100

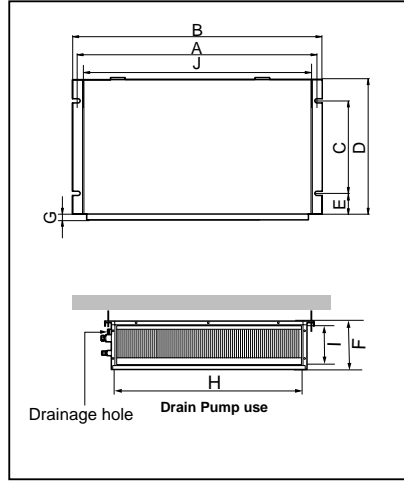

#### CASE 2

- Install the unit leaning to a drainage hole side as a figure for easy water drainage.

##### POSITION OF CONSOLE BOLT

- A place where the unit will be leveled and that can support the weight of the unit.
- A place where the unit can withstand its vibration.
- A place where service can be easily performed.

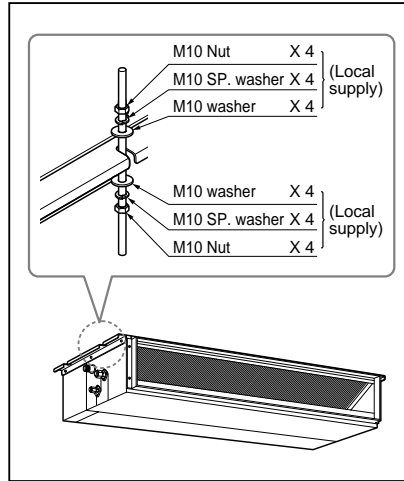

## Indoor Unit Installation

- Select and mark the position for fixing bolts.
- Drill the hole for set anchor on the face of ceiling.

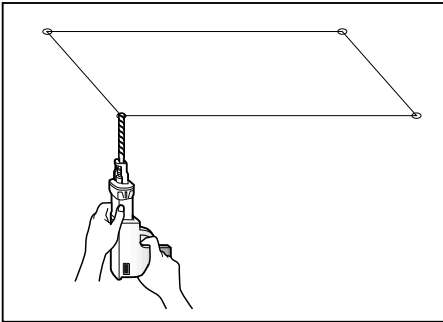

**CAUTION :** Tighten the nut and bolt to prevent unit falling.

- Insert the set anchor and washer onto the suspension bolts for locking the suspension bolts on the ceiling.
- Mount the suspension bolts to the set anchor firmly.
- Secure the installation plates onto the suspension bolts (adjust level roughly) using nuts, washers and spring washers.

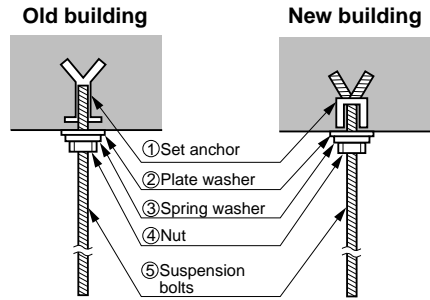

## Wiring Connection

Connect the wires to the terminals on the control board individually according to the outdoor unit connection.

- Ensure that the color of the wires of outdoor unit and the terminal No. are the same as those of indoor unit respectively.

### B1/B2 Series

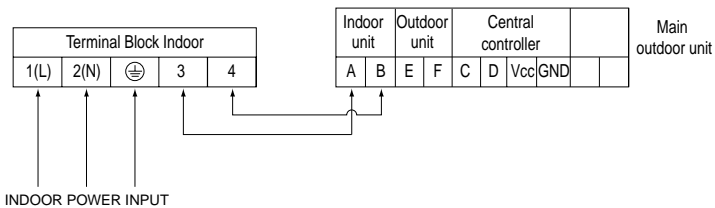

**WARNING :** Make sure that the screws of the terminal are free from looseness.

**Part name and functions**

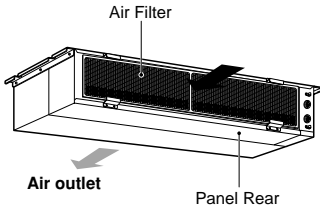

- Low static duct type in case of suction from back side.

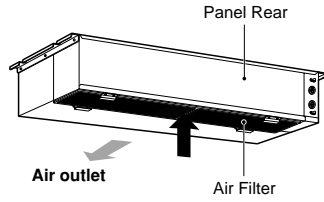

- Low static duct type in case of suction from bottom side.

**INSULATION, OTHERS**

Insulate the joint and tubes completely.

**THERMAL INSULATION**

All thermal insulation must comply with local requirement.

**INDOOR UNIT**

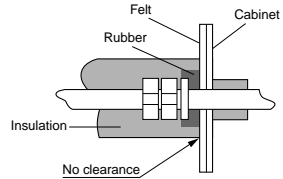
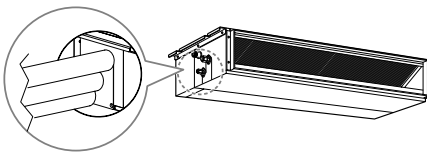
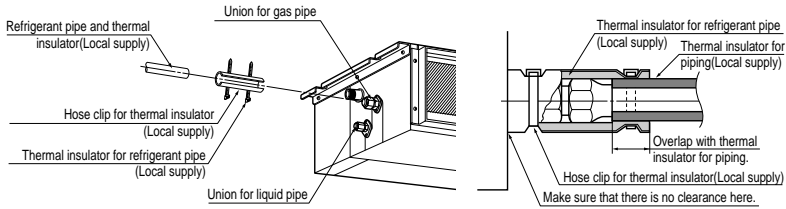

**TEST AND CHECK**

■ **After all workings are finished, check the working and operation.**

- Air distribution ..... Is the air circulation good?
- Drain ..... Is the drainage smoothly and no sweating?
- Gas leakage ..... Is the piping connection correctly?
- Wiring ..... Is the wiring connection correctly?
- Lock-bolt ..... Is the lock-bolt of compressor loosened?
- Insulation ..... Is the unit fully insulated?
- Ground ..... Is the unit safely grounded?

**Checking the Drainage**

**1. Remove the Air Filter.**

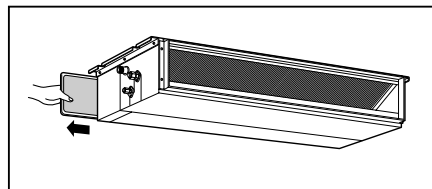

**2. Check the drainage.**

- Spray one or two glasses of water upon the evaporator.
- Ensure that water flows drain hose of indoor unit without any leakage.

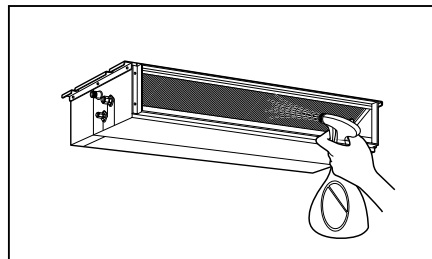

## CAUTION

1. **Install declination** of the indoor unit is very **important for the drain** of the duct type air conditioner.
2. Minimum thickness of the insulation for the connecting pipe shall be 19mm.

### Front of view

- The unit must be horizontal or declined to the drain hose connected when finished installation.

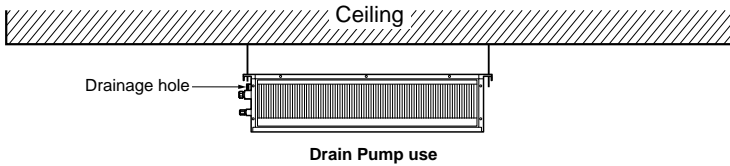

## Drain Piping

- Drain piping must have down-slope (1/50 to 1/100): be sure not to provide up-and-down slope to prevent reversal flow.
- During drain piping connection, be careful not to exert extra force on the drain port on the indoor unit.
- The outside diameter of the drain connection on the indoor unit is 32mm.

Piping material: Polyvinyl chloride pipe VP-25 and pipe fittings

- Be sure to install heat insulation on the drain piping.

Heat insulation material: Polyethylene foam with thickness more than 8 mm.

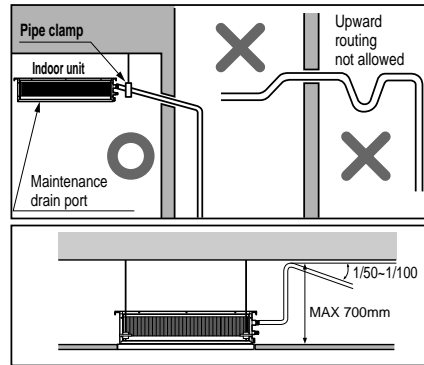

### Drain test

The air conditioner uses a drain pump to drain water.  
Use the following procedure to test the drain pump operation:

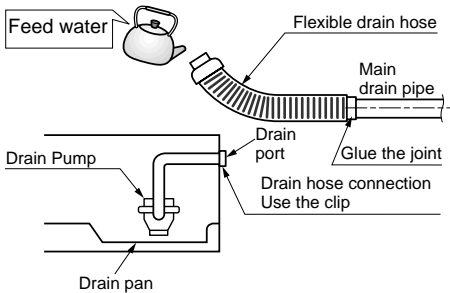

- Connect the main drain pipe to the exterior and leave it provisionally until the test comes to an end.
- Feed water to the flexible drain hose and check the piping for leakage.
- Be sure to check the drain pump for normal operating and noise when electrical wiring is complete.
- When the test is complete, connect the flexible unit drain hose to the drain port on the indoor unit.



**CAUTION :** The supplied flexible drain hose should not be curved, neither screwed. The curved or screwed hose may cause a leakage of water.

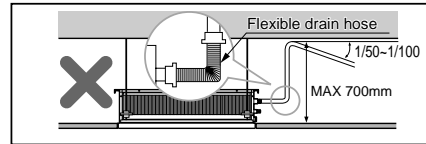

**CAUTION:**

After the confirmation of the above conditions, prepare the wiring as follows:

- 1) Never fail to have an individual power specialized for the air conditioner. As for the method of wiring, be guided by the circuit diagram posted on the inside of control box cover.
- 2) Provide a circuit breaker switch between power source and the unit.
- 3) The screws which fasten the wiring in the casing of electrical fittings are liable to come loose from vibrations to which the unit is subjected during the course of transportation. Check them and make sure that they are all tightly fastened. (If they are loose, it could give rise to burn-out of the wires.)
- 4) Specification of power source
- 5) Confirm that electrical capacity is sufficient.
- 6) Be sure that the starting voltage is maintained at more than 90 percent of the rated voltage marked on the name plate.
- 7) Confirm that the cable thickness is as specified in the power sources specification. (Particularly note the relation between cable length and thickness.)
- 8) Never fail to equip a leakage breaker where it is wet or moist.
- 9) The following troubles would be caused by voltage drop-down.
  - Vibration of a magnetic switch, damage on the contact point, fuse breaking, disturbance by the normal function of an overload protection device.
  - Proper starting power is not given to the compressor.

## HAND OVER

Teach the customer the operation and maintenance procedures, using the operation manual. (air filter cleaning, temperature control, etc.)

## INSTALLATION OF REMOTE CONTROL BOX

Install the remote control box and cord correctly.

### POINT OF REMOTE CONTROLLER INSTALLATION

- Although the room temperature sensor is in the indoor unit, the remote control box should be installed in such places away from direct sunlight and high humidity.

### INSTALLATION OF THE REMOTE CONTROL BOX

- Select places that is not splashed by water.
- Select control position after receiving customer approval.
- The room temperature sensor of the thermostat for temperature control is built in the indoor unit.
- This remote controller equipped with liquid crystal display. If this position is higher or lower, display is difficult to see.  
(The standard height is 1.2~1.5m high)

### ROUTING OF THE REMOTE CONTROL CORD

- Keep the remote control cord away from the refrigerant piping and the drain piping.
- To protect the remote control cord from electrical noise, place the cord at least 5cm away from other power cables. (Audio equipment, Television set, etc)
- If the remote control cord is secured to a wall, provide a trap at the top of the cord to prevent water droplets from running.

### ELECTRICAL WIRING TO THE INDOOR UNIT

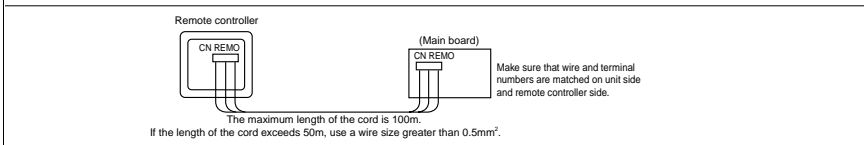

### DISASSEMBLING OF THE REMOTE CONTROLLER

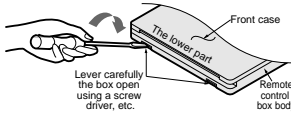

### WHEN THE REMOTE CONTROL BOX IS INSTALLED WITH THE CORD EXPOSED.

#### PROCEDURE OF INSTALLATION

- Fix the under plate on the wall by self tapping screws
- Make a slit (Part A) at the top side of the remote control box by nipper.
- Rout the cord as shown in the following figure. In this case, push the cord into the around of case(Part B).
- Hook the remote control unit on the under plate.

### WHEN THE REMOTE CONTROL BOX IS INSTALLED WITH THE CORD BURIED.

#### PROCEDURE OF INSTALLATION

- Fix the under plate on the switch box by screws(Local supply). In this case, fit the under plate on the wall, and be careful of deformation.
- Receive the remote control cord in the switch box.
- Hook the remote control unit on the under plate.

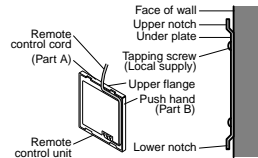
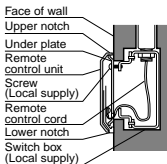

#### FIXING OF REMOTE CONTROL CORD

- Fix the cord clamps on the wall by  $\phi 3$  tapping screws(Local supply).
- Fix the remote control cord.

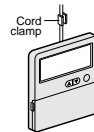

## WIRED REMOTE CONTROLLER INSTALLATION

- Since the room temperature sensor is in the remote controller, the remote controller box should be installed in a place away from direct sunlight, high humidity and direct supply of cold air to maintain proper space temperature. Install the remote controller about 5ft(1.5m) above the floor in an area with good air circulation at an average temperature.

### Do not install the remote controller where it can be affected by:

- Drafts, or dead spots behind doors and in corners.
- Hot or cold air from ducts.
- Radiant heat from sun or appliances.
- Concealed pipes and chimneys.
- Uncontrolled areas such as an outside wall behind the remote controller.
- This remote controller is equipped with a seven segment LED. display. For proper display of the remote controller LED's, the remote controller should be installed properly as shown in Fig.1. (The standard height is 1.2~1.5 m from floor level.)

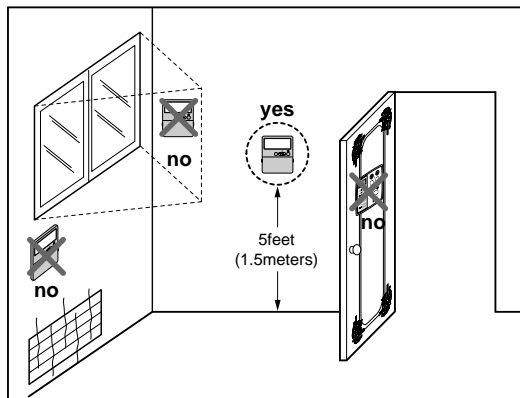
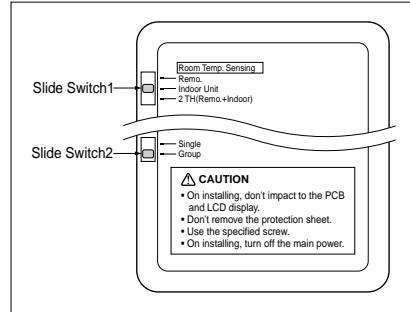

Fig.1 Typical locations for remote controller

## Two Thermistor system

- Open the rear cover of Remote Controller to set up the mode.
- Selectable options are three as follows.
  - Remo: Sensing the room Temperature.
  - Indoor Unit: Sensing the intake air into indoor Unit.
  - 2 TH: Sensing the lower temperature of the two thermistors.
- To set up the mode, adjust the slide switch to desired mode position on installing.



# E.S.P.(External Static Pressure) Setting

Open the rear cover of the wired remote-controller to set the mode.  
Select one of three selectable modes as follows.

## ■ Without Zone System

1. Position V-H, F-H:
  - This position sets the maximum E.S.P as a default set.
2. Position V-L:
  - This position sets the minimum E.S.P as a default set.

## ■ With Zone System

1. Position V-H:
  - Maximum E.S.P setting & Fan speed is varied according to the state of dampers by micom.
2. Position F-H:
  - Maximum E.S.P setting & Fan speed doesn't vary according to the opening & Closing of dampers.
3. Position V-L:
  - Minimum E.S.P setting & Fan speed is varied according to the state of dampers by micom.

\*Maximum: 9K/12K-8mmAq

Minimum: All-0mmAq

**Move the slide switch to set position.**

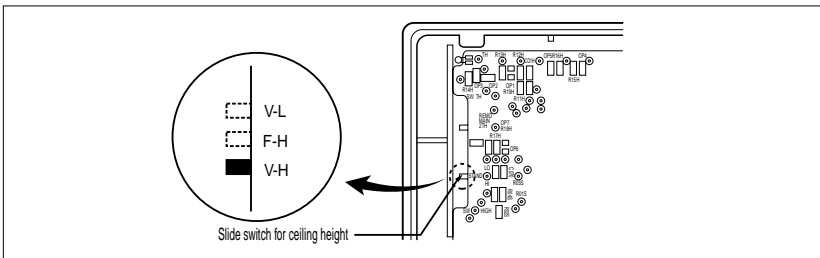

**Close the rear cover and check if it works normally.**



### CAUTION:

- Select the position after checking duct work and E.S.P of the unit.
- Manufactured in the position F-H.

# How to Set E.S.P?

## Procedure of RPM change:

Ex) External Static pressure is 4mmAq for Model Name "ARNU12GB1G1, ARNU24GB2G1"

- To protect the unit, compressor is designed to be off during E.S.P. setting.

- 1** Push the "On/Off" button.  
The unit will start.

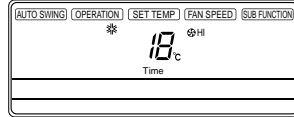

- 2** Push the "Timer" and "Wind" button simultaneously for more than 3 seconds.

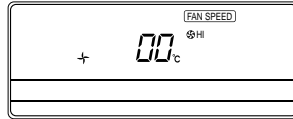

- 3** Push the "Up" of "Down" button for E.S.P adjustment.  
And, adjust the number which you want. (In this example, the number is "190". Refer to the table 1 or 2 on the next page.)

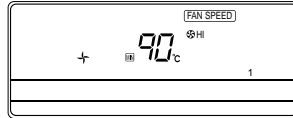
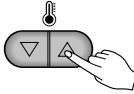

**NOTICE** The range of selection is from 1~254. Since, the display is two Digit only.  
If the range selection is above 100 then the third digit will appear in the screen as shown.

- 4** Shift the fan speed mode by pressing the fan speed button.  
And then, Adjust numbers of next steps by repeating the stage 3.  
(In this example, the numbers are "220" and "235" respectively)



- 5** Push the "Timer" and "Wind" button simultaneously for more than 3 seconds.  
Then, Wind Data is memorized by the EEPROM of the main PCB.

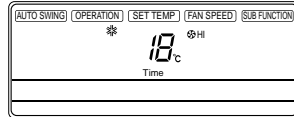
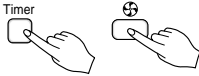

**[Table.1] B1/B2 Series**

Static Pressure(mmAq)		0	1	2	3	4
Model Name	Step(Hi/Med/Lo)	Setting Value				
7k	8.5CMM	75	84	94	103	114
	7.5CMM	69	77	88	99	110
	6.5CMM	62	71	83	95	106
9k	9.5CMM	82	90	99	109	118
	8.5CMM	75	84	94	104	114
	7.5CMM	69	77	88	99	110
12k	10.5CMM	89	96	103	113	122
	9.5CMM	82	90	99	109	118
	8.5CMM	75	84	94	104	114
18k	16CMM	95	103	110	117	125
	14CMM	84	93	101	109	117
	12CMM	75	84	93	103	113
24k	19CMM	110	117	125	129	-
	17CMM	100	107	115	115	127
	15CMM	90	97	105	114	122

