



website <http://www.lgservice.com>  
e-mail <http://www.lgeservice.com/techsup.html>

LG

# LG Ventilator

## ***INSTALLATION MANUAL***

### **IMPORTANT**

- Please read this installation manual completely before installing the product.
- Installation work must be performed in accordance with the national wiring standards by authorized personnel only.
- Please retain this installation manual for future reference after reading it thoroughly.

# TABLE OF CONTENTS

## **Installation Requirements**

**Safety Precaution**.....3

**Introduction** .....9

    Symbols Used in  
    this manual .....9

    Feature Dimension  
    Diagram .....9

**Installation** ..... 11

    Installation Map ..... 11

    Installation of Main Body ...13

    Connection of Duct.....13

    Electric Work ..... 14

    Method to Connect  
    Power Cord ..... 15

**How to Connect  
Remote Controller**..... 16

    Feature Dimension of  
    Remote Controller ..... 16

    Installation Size ..... 16

**Trial Operation** ..... 18

    Method to Operate and  
    Select Air Volume ..... 18

    Ventilation  
    Mode Setting ..... 19

    Rapid Ventilation/Power  
    Saving Ventilation.....20

**In Case of Finding a Problem  
at a Trial Operation** .....21

## **Required Parts**

- Screws
- Nuts
- Ceiling Fixing Bolt(M10~12)
- Washer
- Aluminium Tape
- Screws

## **Required Tools**

- Screw Driver
- Spanner
- Cutter
- Cutter
- Screw Driver

# Safety Precautions



To prevent injury to the user or other people and property damage, the following instructions must be followed.

- Incorrect operation due to ignoring instruction will cause harm or damage. The seriousness is classified by the following indications.

**⚠ WARNING** This symbol indicates the possibility of death or serious injury.

**⚠ CAUTION** This symbol indicates the possibility of injury or damage.

- Meanings of symbols used in this manual are as shown below.

	<b>Be sure not to do.</b>
	<b>Be sure to follow the instruction.</b>

## ⚠ WARNING

### ■ Installation

**Do not use a defective or underrated circuit breaker. Use this appliance on a dedicated circuit.**

- There is risk of fire or electric shock.

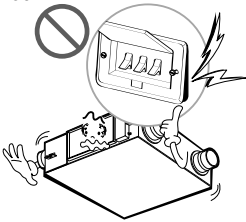

**For electrical work, contact the dealer, seller, a qualified electrician, or an Authorized Service Center.**

- Do not disassemble or repair the product. There is risk of fire or electric shock.



**Always ground the product.**

- There is risk of fire or electric shock.

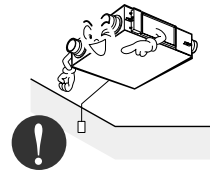

**Install the panel and the cover of control box securely.**

- There is risk of fire or electric shock.

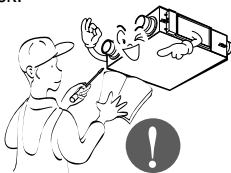

**Always install a dedicated circuit and breaker.**

- Improper wiring or installation may cause fire or electric shock

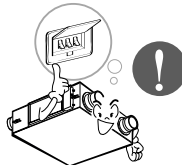

**Use the correctly rated breaker or fuse.**

- There is risk of fire or electric shock.

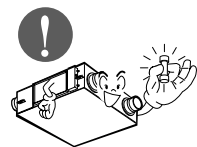

*Safety Precautions*

**Do not modify or extend the power cable.**

- There is risk of fire or electric shock.

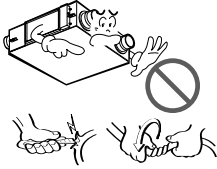

**Do not install, remove, or re-install the unit by yourself (customer).**

- There is risk of fire, electric shock, explosion, or injury.



**Be cautious when unpacking and installing the product.**

- Sharp edges could cause injury.

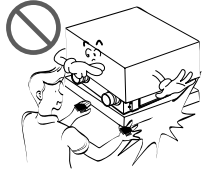

**For installation, always contact the dealer or an Authorized Service Center.**

- There is risk of fire, electric shock, explosion, or injury.

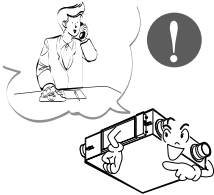

**Do not install the product on a defective installation stand.**

- It may cause injury, accident, or damage to the product.



**Do not let the product run for a long time when the humidity is very high and a door or a window is left open.**

- Moisture may condense and wet or damage furniture.

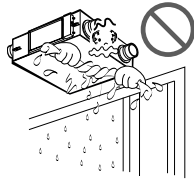

**For re-installation of the installed product, always contact the dealer or an Authorized Service Center.**

- There is risk of fire, electric shock, explosion or injury.



**Do not open the maintenance cover of the main body during operation.**

- Otherwise, it may cause electrical shock.

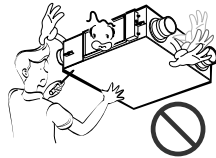

**Use the outdoor air suction hole with the net installed to ensure that birds could not come in.**

- Remove estrange things like the bird's nest. Otherwise, it may cause scarcity of indoor oxygen.

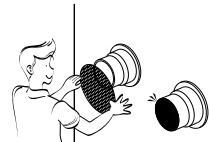

Install the outdoor air suction hole at a place where exhaust air is not directly suctioned.

- Otherwise, it may cause pollute indoor air and so result in obstacle of health.

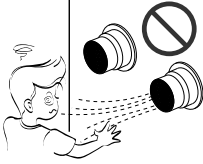

Do not install this product in a refrigerated warehouse, heated swimming pool or other location where the temperature and humidity are significantly different.

- There is risk of electrical shock, malfunctioning.

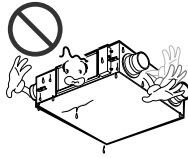

Install this product in an environment where the temperature ranges from  $-10^{\circ}\text{C}$  to  $+45^{\circ}\text{C}$  and the relative humidity is less than 80%. It condensation is expected to form, heat up the fresh outside air using a duct heater etc.

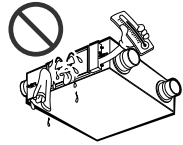

Install this product in and environments where the outside air intake meets the following conditions: temperature range is between  $-15^{\circ}\text{C}$  and  $+40^{\circ}\text{C}$  and the relative humidity is 80% or less.

Use the designated electrical wires for the terminal board connections, and connect the wires securely so that they will not become disconnected. (Failure to ensure proper connections may cause fire.)

When passing metal ducts through wooden buildings clad with metal laths, wire laths or metal, these ducts must be installed in such a way that they will not make electrical contact with the metal laths, wire laths or metal sheets. (Power leakage can cause ignition)

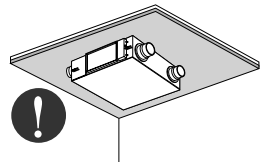
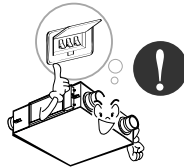
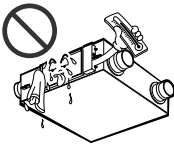

## ■ Operation

Avoid fire equipment

- There is risk of fire.



When the product is soaked (flooded or submerged), contact an Authorized Service Center.

- There is risk of fire or electric shock.

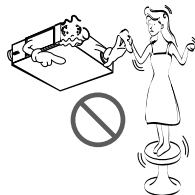

Don't touch a dedicated circuit or breaker with wet hands.

- There is risk of electric shock.

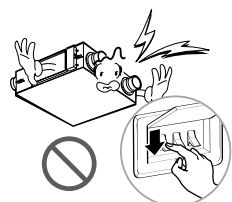

**When the product is not be used for a long time, disconnect the power supply plug or turn off the breaker.**

- There is risk of product damage or failure, or unintended operation.

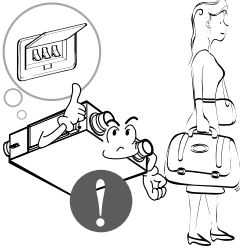

**Do not store or use flammable gas or combustibles near the product.**

- There is risk of fire or failure of product.

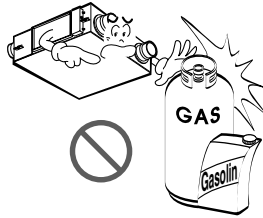

**When flammable gas leaks, turn off the gas and open a window for ventilation before turn the product on.**

- Do not use the telephone or turn switches on or off. There is risk of explosion or fire

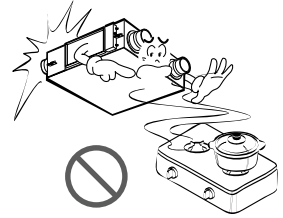

**Be cautious that water could not enter the product.**

- There is risk of fire, electric shock, or product damage.

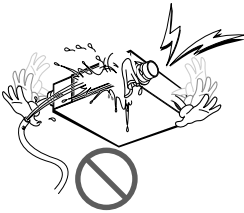

**Turn the breaker off when cleaning or maintaining the product.**

- There is risk of electric shock.



**The outside ducts must be tilted at a gradient (1/30 or more) down toward the outdoor area from the ventilator unit, and properly insulated. (The entry of rain water may cause power leaks, fire or damage to household property.)**

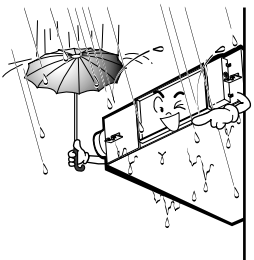

**Glove should be worn when doing the installation work. (There is risk of injury.)**



# CAUTION

## ■ Installation

**Don't connect the ground wire to the window frame or water cock.**

- There is risk of electric shock.

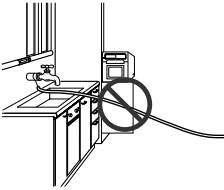

**Do not install the product at a smoky and oily place like kitchen or factory.**

- Otherwise, oil may adhere to the filter or heating exchanger and cause trouble.

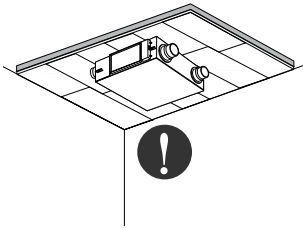

**Install the product in an insulated space from outdoor air.**

- In case of installing the product outside of the insulated layer, dewing occurs inside of the main body in winter. And it causes electrical shock or falling of condensed water.

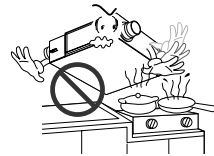

**Keep level even when installing the product.**

- To avoid vibration or water leakage.

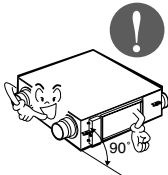

**Use two or more people to lift and transport the product.**

- Avoid personal injury.

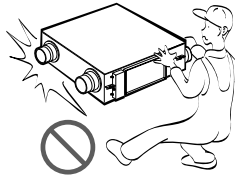

**Do not install the product where it will be exposed to sea wind (salt spray) directly.**

- It may cause corrosion on the product. Corrosion, particularly on the condenser and evaporator fins, could cause product malfunction or inefficient operation.

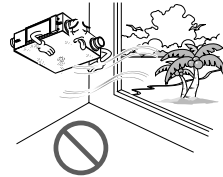

## ■ Operation

**Use a soft cloth to clean. Do not use harsh detergents, wax or thinner, etc.**

- Otherwise, color or surface of the product may deteriorate.

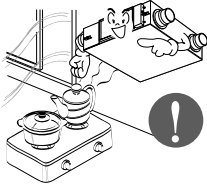

**Clean the filter and the heat exchanger regularly and use the gloves for cleaning.**

- Adhering to a mass of dust may cause the deterioration of air volume.

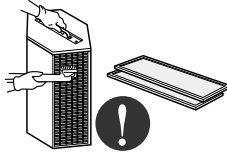

**Do not use the product for special purposes, such as preserving foods, works of art, etc. It is a consumer ventilator, not a precision refrigeration system.**

- There is risk of damage or loss of property.

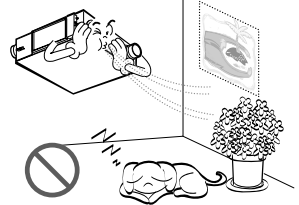

**Do not block the inlet or outlet of air flow.**

- It may cause product failure.

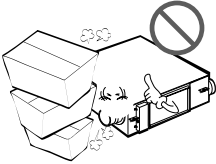

**Do not step on or put anything on the product.**

- There is risk of personal injury and failure of product.

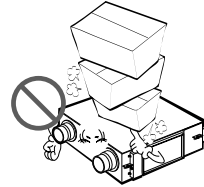

# Introduction

## Symbols used in this Manual



This symbol alerts you to the risk of electric shock.



This symbol alerts you to hazards that could cause harm to the product.

**NOTICE**

This symbol indicates special notes.

## Feature Dimension Diagram

Application tools : 100/150 CMH(28/42 L/s)

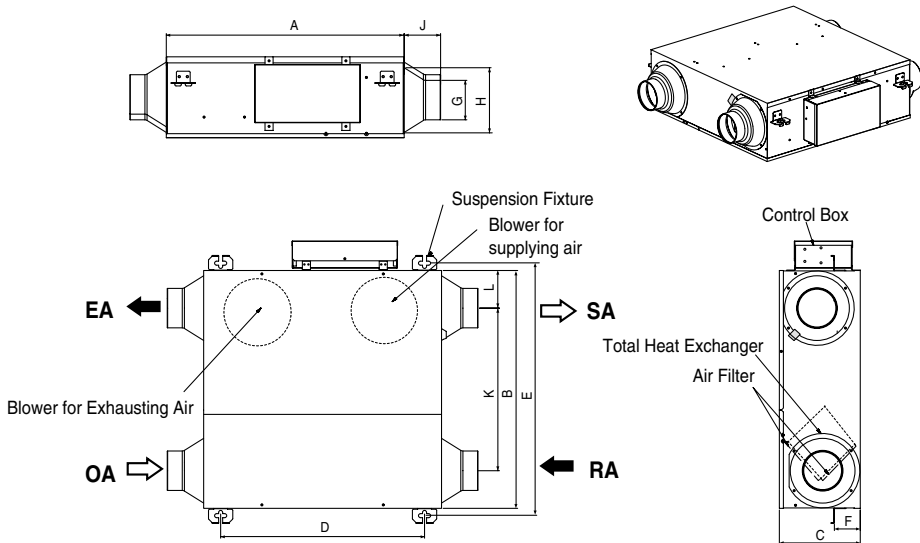

Unit: mm

Application tools	Figure			Pitch of Suspension Fixture			Nominal Diameter	Duct Connection Flange			Duct Pitch		Weight (kg)
	A	B	C	D	E	F		G	H	J	K	L	
100/150CMH (28/42 L/s)	590	590	204	504	624.2	64	100	97.5	160	90	402	93	24

**Application tool : 250 CMH(69 L/s)**

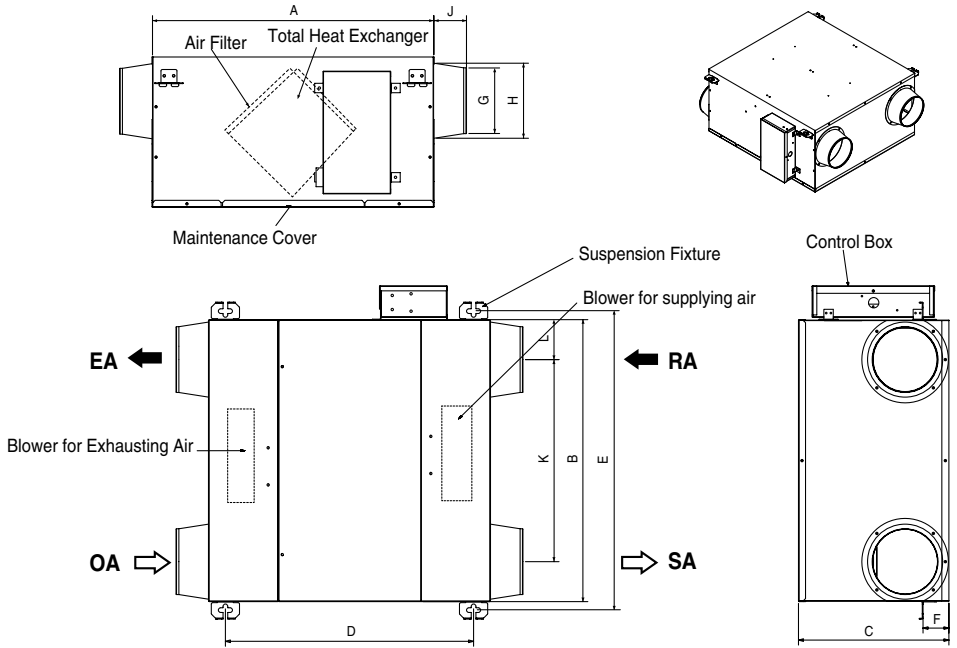

Unit: mm

Application tools	Figure			Pitch of Suspension Fixture			Nominal Diameter	Duct Connection Flange			Duct Pitch		Weight (kg)
	A	B	C	D	E	F		G	H	J	K	L	
250CMH (69 L/s)	640	596	320	568	636.2	55	150	140	160	70	430	84	27

# Installation

## Installation Map

Application tools : 100/150 CMH(28/42 L/s)

### ■ A PLANE FIGURE

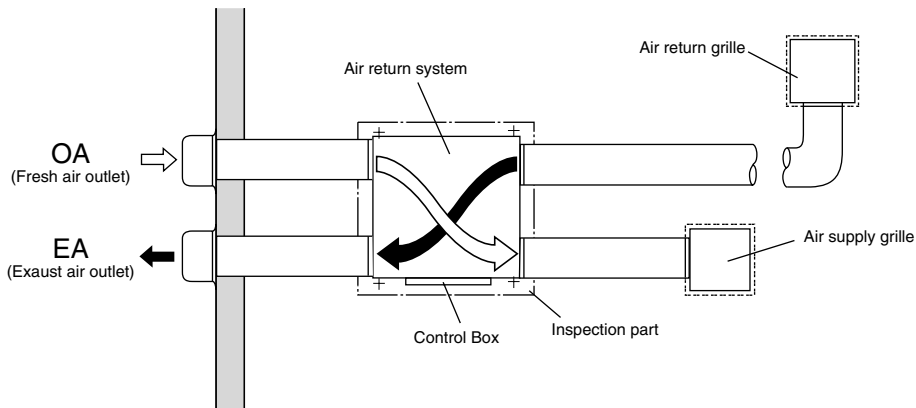

### ■ A FRONT VIEW

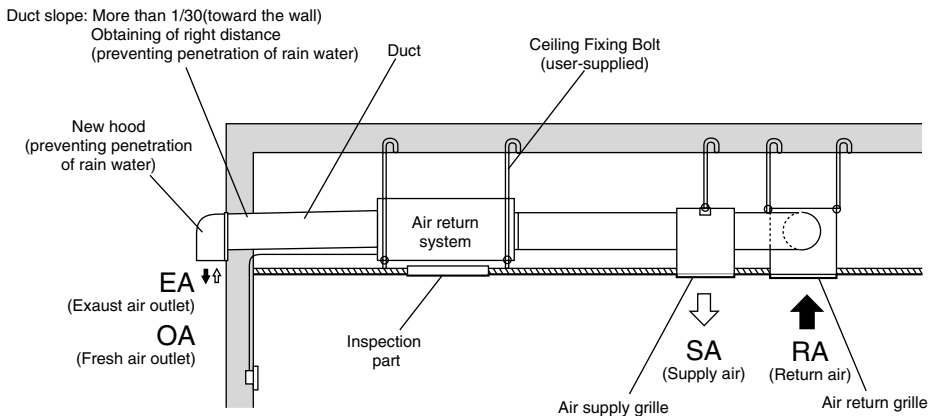

[Unit : mm]

Application tools	A	B	C
100/150CMH (28/42 L/s)	504	624.2	100

**Application tools : 250 CMH(69 L/s)**

**■ THREE DIMENSION VIEW**

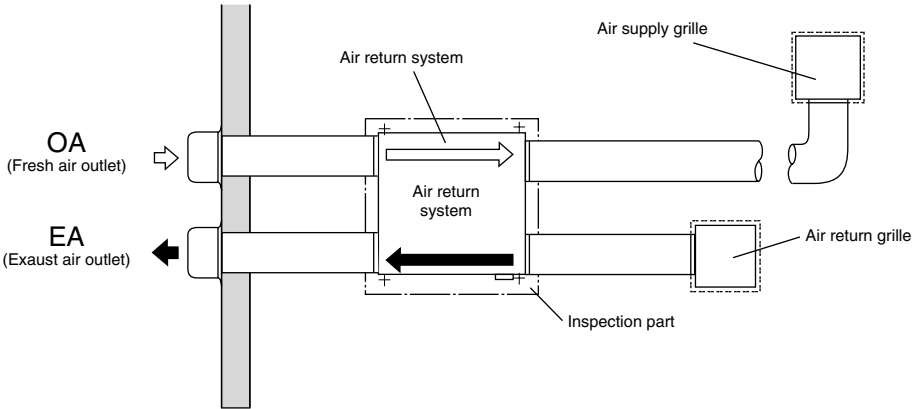

**■ INSTALLATION OF MAINTENANCE COVER**

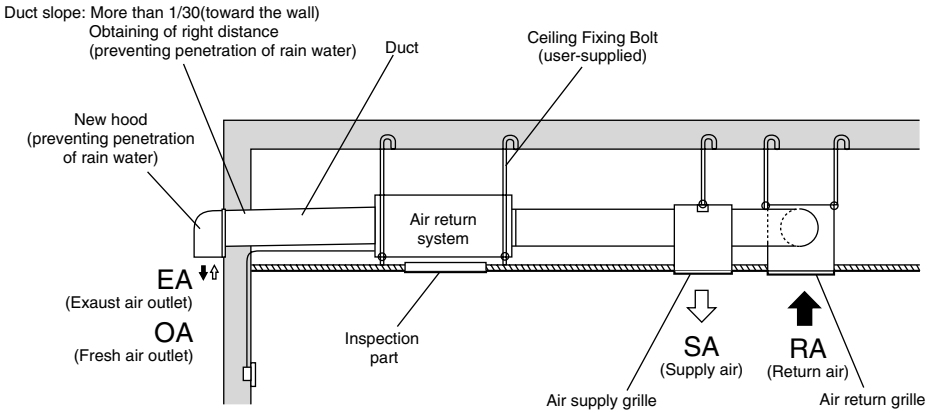

[Unit : mm]

Application tools	A	B	C
250CMH (69 L/s)	568	636.2	150

## Installation of Main Body

### Assembly of Washer, Nut

Tighten the commercial washer nut (more than 21mm for the outside diameter of M10, to the commercial ceiling fixing bolt (M10) as shown in the left figure.

- For the ceiling fixing bolt, perform work less than 50mm under the ceil fixing bracket.

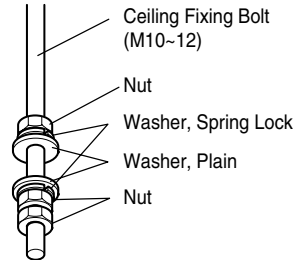

## Connection of Duct

1. After securely connect the duct with the duct connection flange, wrap it with a commercial aluminium tape so that air cannot be leaked.
2. Adjust the duct from the ceiling so that no force is applied to the main body of the ventilation system.
3. Always use two ducts at the outdoor with the heat insulating material for prevention of dewing.

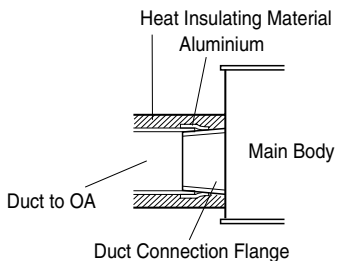
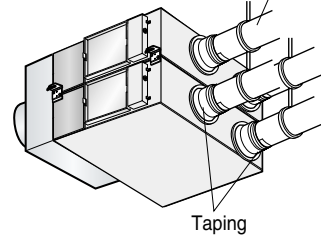
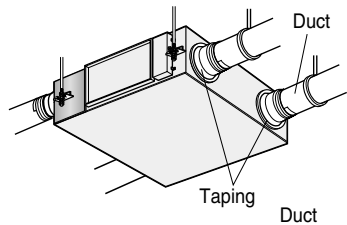

### CAUTION:

- Check that there are no foreign materials (paper, vinyl, etc) or cutoff powders in the duct before connecting the duct.
- Take care so that shock may not be applied to the damper plate within the main body when performing the duct connection work.
- It is recommended to perform adiabatic treatment even to the duct pipe at the indoor side where ambient temperature is expected when the main body of the ventilation system for cooling in summer.
- Take care so that work may not be performed as in the left figure. Otherwise, it may cause reduction of air volume or abnormal noise.



Rapid Bending



Excessive Bending

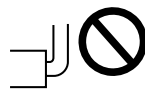

Too Close Bending to Outlet

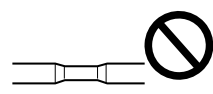

Rapid Reduction of Duct Diameter

# Electric work

• Circuit Diagram

Electric work method is different in respect of the system configuration. Perform electrical works to various parts required.

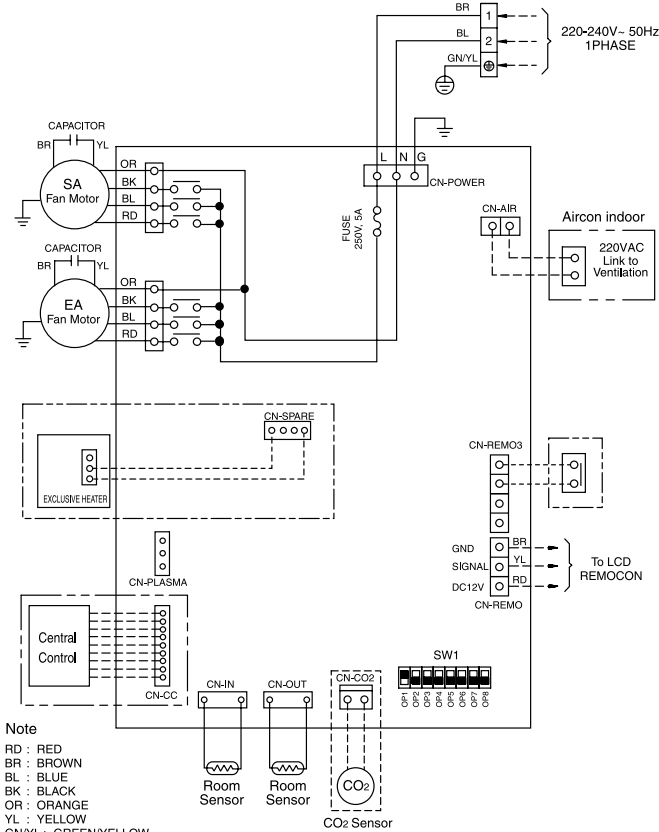

Note  
 RD : RED  
 BR : BROWN  
 BL : BLUE  
 BK : BLACK  
 OR : ORANGE  
 YL : YELLOW  
 GN/YL : GREEN/YELLOW

⚠ WARNING
<ul style="list-style-type: none"> <li>• There is risk of electric shock due to failure or electric leakage.</li> <li>• Always ground the product.</li> <li>• You can install the product by referring to owner's manual.</li> </ul>

INFORMATION
<ul style="list-style-type: none"> <li>• You need to buy a dedicated circuit separately.</li> <li>• ----- Field Wiring</li> </ul>

P/NO : 3854A20230M



- WARNING:**
- There is risk of electric shock due to failure or electric leakage.
  - Always ground the product.
  - You can install the product by referring to owner's manual.

- INFORMATION:**
- You need to buy a dedicated circuit separately.
  - A bold dot line indicates a wiring on the spot.

## Method to Connect Power Cord

### 1. Release two screws and then open the cover of the control box.

- With reference to the above wiring diagram, accurately connect the main power cords into the terminal block.

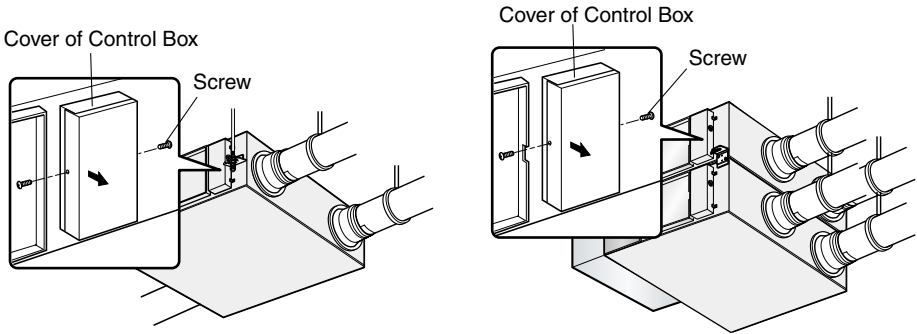

### 2. After inserting the power cord into the bushing, fully insert it into the terminal block for connection.

- Fix the power cords with the clamp.
- Make sure that the power cords may not be removed by pulling them.

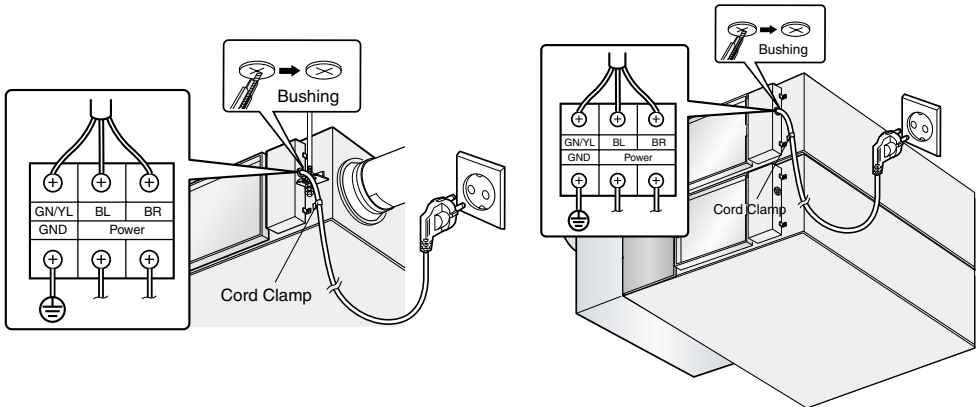

# How to connect Remote Controller

## Feature Dimension of Remote Controller(AZLRAD0)

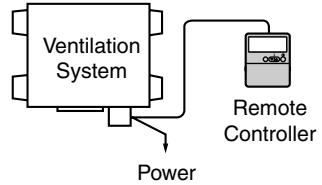
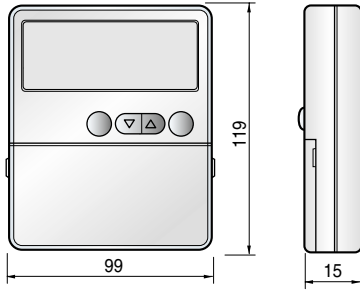

## Installation Size

### 1. Separation of Case

- Separate the remote controller fixing panel from the wiring remote controller and fix it at a desired place. (Appropriate installation height of the remote controller is 1.5m.)

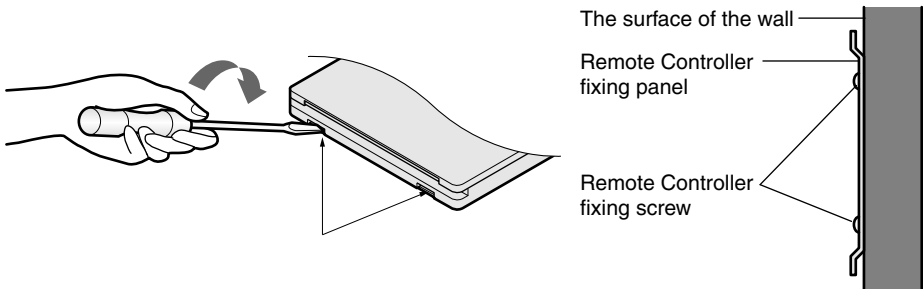

## 2. Wiring

- Connect wire to the Remote Controller.  
(Remote controller needs to be bought separately.)

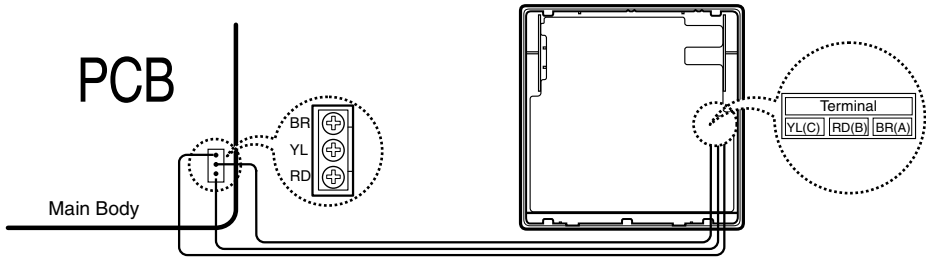

## 3. Adhesion of Remote Controller

- Make a hole connecting cable of an installation panel.

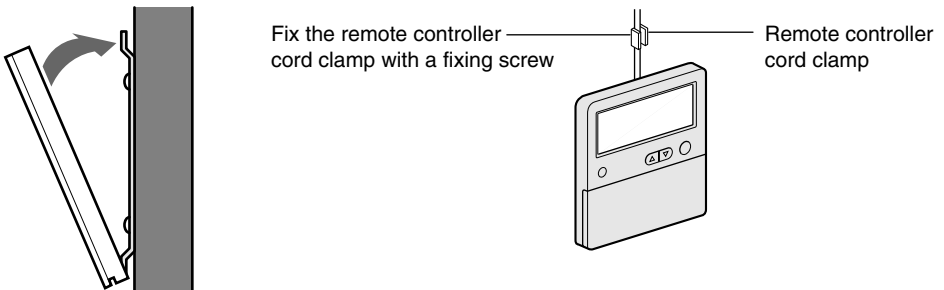

# Trial Operation

## Method to operate and select air volume

- Every function is not available by a kind of models.

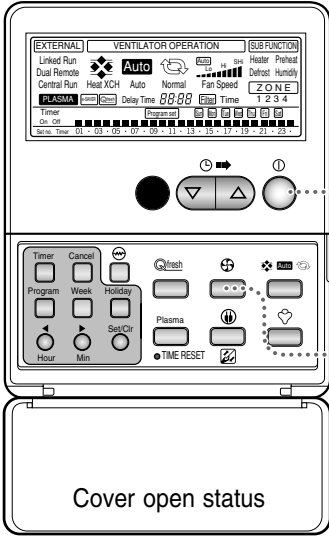

Cover open status

### Operation selection

Press the Operation/Stop button.

- The ventilation system operates  
If you press the Operation/Stop button of the main power.  
If you press it again, the ventilation system stops.



### Blowing operation

Select the desired air volume by pressing the Air volume Select button.

- You can select the air volume in the order of **Low** → **High** → **Super High** → **Auto** whenever you press the Air volume Select button.
- The initially set Air volume in operation is '**High**'.

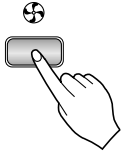

# Ventilation Mode Setting

- Every function is not available by a kind of models.

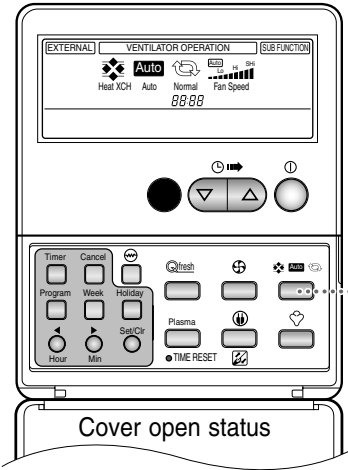

Select the desired operation mode by pressing the Ventilation Mode button.

- You can select the Operation Mode in the order of **Total Heat** → **Auto** → **Normal** whenever you press the Ventilation Mode button.

Select Mode	Display Window	Functions
1. The Ventilation via Total Heat Exchange mode	<p>Heat XCH</p>	<p>Mode that supply/exhaust air is ventilated via the Total heat exchanger.</p> <p>Appropriate for use in summer/winter when temperature difference between indoor/outdoor air is severe (See 'Characteristics').</p>
2. The Auto mode	<p>Auto</p>	<p>Automatically operates in the optimum ventilation mode by measuring the indoor/outdoor air of the ventilation system.</p> <p>* Searches the optimum status by operation mode or setting temperature of ventilator as well as by indoor/outdoor temperature of the ventilation system in link of Multi-V. (Only for some models)</p>
3. Normal Ventilation	<p>Normal</p>	<p>Mode that exhaust air is ventilated without the Total heat exchanger.</p> <p>Appropriate for use in spring/autumn or in case of the high indoor pollution degree(See 'Characteristics').</p>

## Rapid Ventilation/Power Saving Ventilation

- Every function is not available by a kind of models.

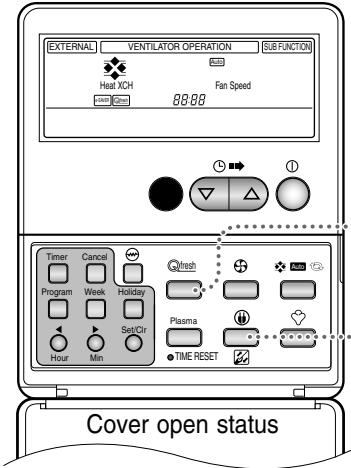

### Rapid Ventilation

Press the **[Rapid Ventilation]** button.

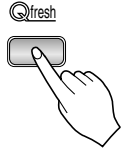

- Operation for preventing the polluted indoor air or moisture from extending to other rooms.
  - Supply Air fan : Low.
  - Exhaust fan : Super High
- **[Rapid]** is indicated on the remote controller and the air volume is indicated "Auto".
- ✳ It is better to use Rapid Ventilation function when the indoor pollution degree is high.
- Adjustable to Inflow Prevention operation in the initial installation Inflow prevention operation means function to improve pleasantness by preventing inflow of outdoor smell or moisture by more increasing Supply Air volume than Exhaust air volume.
  - Supply Air fan : Super high
  - Exhaust fan : Low

For more information, contact the professional installation agent.

### Power Saving Ventilation

Press the **[e-Saver]** button.

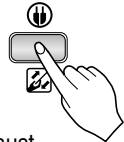

- Operation to achieve saving of power by searching for the best efficient operation point.
- Promote discharge of CO<sub>2</sub> by more Exhaust Air volume than supply Air volume.
- **[e-Saver]** is indicated on the remote controller and the air volume indicates 'Auto'.

## In case of finding a problem at a trial operation

Symptom	Counter-measures
<p>The product doesn't work though you press the 'ON' switch.</p>	<ul style="list-style-type: none"> <li>• Checking the power(rated power 1 phase, 230V, the diameter <math>\varnothing</math>0.6~<math>\varnothing</math>2.0, capacity of breaker)</li> </ul>
	<ul style="list-style-type: none"> <li>• Isn't the fuse connected?</li> </ul>
	<ul style="list-style-type: none"> <li>• Are the PCB and Remote Controller rightly connected?</li> </ul>
<p>The fan doesn't run</p>	<ul style="list-style-type: none"> <li>• Is the outdoor temperature the limit temperature? (Less than -15°C, more than 45°C)</li> </ul>
	<ul style="list-style-type: none"> <li>• In case of the limit temperature                             <ul style="list-style-type: none"> <li>- Switch on Option No. 7.</li> <li>- Repower the product and check whether it works or not.</li> <li>- Switch off Option No. 7. and repower the product once again.</li> </ul> </li> </ul>



