



website <http://www.lgservice.com>

LG

***MULTI V***<sup>TM</sup> System  
**MINI**  
Outdoor Unit **R410A**  
***INSTALLATION MANUAL***

**MODELS: ARUN Series ARUV Series**  
**(1Ø, 220~240V, 50Hz / 1Ø, 220V, 60Hz)**

**IMPORTANT**

- Please read this installation manual completely before installing the product.
- Installation work must be performed in accordance with the national wiring standards by authorized personnel only.
- Please retain this installation manual for future reference after reading it thoroughly.

ENGLISH

ITALIANO

ESPAÑOL

FRANÇAIS

DEUTSCH

PORTUGUESE

# TABLE OF CONTENTS

Safety Precautions.....	3
Installation Process .....	7
Outdoor Units Information .....	8
Before installation.....	9
Select the Best Location .....	10
Installation Space.....	11
Installation .....	15
Refrigerant piping .....	18
Electrical Wiring.....	37
Test Run.....	52
Caution For Refrigerant Leak.....	63
Installation guide at the seaside.....	65

# Safety Precautions



To prevent injury to the user or other people and property damage, the following instructions must be followed.

- Incorrect operation due to ignoring instruction will cause harm or damage. The seriousness is classified by the following indications.

**⚠ WARNING** This symbol indicates the possibility of death or serious injury.

**⚠ CAUTION** This symbol indicates the possibility of injury or damage to properties only.

- Meanings of symbols used in this manual are as shown below.

	<b>Be sure not to do.</b>
	<b>Be sure to follow the instruction.</b>

## ⚠ WARNING

### ■ Installation

**Have all electric work done by a licensed electrician according to "Electric Facility Engineering Standard" and "Interior Wire Regulations" and the instructions given in this manual and always use a special circuit.**

- If the power source capacity is inadequate or electric work is performed improperly, electric shock or fire may result.

**Always ground the product.**

- There is risk of fire or electric shock.

**For re-installation of the installed product, always contact a dealer or an Authorized Service Center.**

- There is risk of fire, electric shock, explosion, or injury.

**Do not store or use flammable gas or combustibles near the air conditioner.**

- There is risk of fire or failure of product.

**Prepare for strong wind or earthquake and install the unit at the specified place.**

- Improper installation may cause the unit to topple and result in injury.

**Ask the dealer or an authorized technician to install the air conditioner.**

- Improper installation by the user may result in water leakage, electric shock, or fire.

**Always install a dedicated circuit and breaker.**

- Improper wiring or installation may cause fire or electric shock.

**Do not install, remove, or re-install the unit by yourself (customer).**

- There is risk of fire, electric shock, explosion, or injury.

**Use the correctly rated breaker or fuse.**

- There is risk of fire or electric shock.

**Do not install the product on a defective installation stand.**

- It may cause injury, accident, or damage to the product.

**When installing and moving the air conditioner to another site, do not charge it with a different refrigerant from the refrigerant specified on the unit.**

- If a different refrigerant or air is mixed with the original refrigerant, the refrigerant cycle may malfunction and the unit may be damaged.

**Do not reconstruct to change the settings of the protection devices.**

- If the pressure switch, thermal switch, or other protection device is shorted and operated forcibly, or parts other than those specified by LGE are used, fire or explosion may result.

**Ventilate before operating air conditioner when gas leaked out.**

- It may cause explosion, fire, and burn.

**Securely install the cover of control box and the panel.**

- If the cover and panel are not installed securely, dust or water may enter the outdoor unit and fire or electric shock may result.

**If the air conditioner is installed in a small room, measures must be taken to prevent the refrigerant concentration from exceeding the safety limit when the refrigerant leaks.**

- Consult the dealer regarding the appropriate measures to prevent the safety limit from being exceeded. Should the refrigerant leak and cause the safety limit to be exceeded, hazards due to lack of oxygen in the room could result.

## ■ Operation

---

**Do not damage or use an unspecified power cord.**

- There is risk of fire, electric shock, explosion, or injury.

**Use a dedicated outlet for this appliance.**

- There is risk of fire or electrical shock.

**Be cautious that water could not enter the product.**

- There is risk of fire, electric shock, or product damage.

**Do not touch the power switch with wet hands.**

- There is risk of fire, electric shock, explosion, or injury.

**When the product is soaked (flooded or submerged), contact an Authorized Service Center.**

- There is risk of fire or electric shock.

**Be cautious not to touch the sharp edges when installing.**

- It may cause injury.

**Take care to ensure that nobody could step on or fall onto the outdoor unit.**

- This could result in personal injury and product damage.

**Do not open the inlet grille of the product during operation. (Do not touch the electrostatic filter, if the unit is so equipped.)**

- There is risk of physical injury, electric shock, or product failure.

**CAUTION**
**■ Installation****Always check for gas (refrigerant) leakage after installation or repair of product.**

- Low refrigerant levels may cause failure of product.

**Keep level even when installing the product.**

- To avoid vibration or water leakage.

**Use power cables of sufficient current carrying capacity and rating.**

- Cables that are too small may leak, generate heat, and cause a fire.

**Keep the unit away from children. The heat exchanger is very sharp.**

- It can cause the injury, such as cutting the finger. Also the damaged fin may result in degradation of capacity.

**Do not install the product where the noise or hot air from the outdoor unit could damage the neighborhoods.**

- It may cause a problem for your neighbors.

**Do not install the unit where combustible gas may leak.**

- If the gas leaks and accumulates around the unit, an explosion may result.

**Do not use the product for special purposes, such as preserving foods, works of art, etc. It is a consumer air conditioner, not a precision refrigeration system.**

- There is risk of damage or loss of property.

**When installing the unit in a hospital, communication station, or similar place, provide sufficient protection against noise.**

- The inverter equipment, private power generator, high-frequency medical equipment, or radio communication equipment may cause the air conditioner to operate erroneously, or fail to operate. On the other hand, the air conditioner may affect such equipment by creating noise that disturbs medical treatment or image broadcasting.

**Do not install the product where it is exposed to sea wind (salt spray) directly.**

- It may cause corrosion on the product. Corrosion, particularly on the condenser and evaporator fins, could cause product malfunction or inefficient operation.

**■ Operation****Do not use the air conditioner in special environments.**

- Oil, steam, sulfuric smoke, etc. can significantly reduce the performance of the air conditioner or damage its parts.

**Make the connections securely so that the outside force of the cable may not be applied to the terminals.**

- Inadequate connection and fastening may generate heat and cause a fire.

**Do not block the inlet or outlet.**

- It may cause failure of appliance or accident.

**Be sure the installation area does not deteriorate with age.**

- If the base collapses, the air conditioner could fall with it, causing property damage, product failure, or personal injury.

**Install and insulate the drain hose to ensure that water is drained away properly based on the installation manual.**

- A bad connection may cause water leakage.

**Be very careful about product transportation.**

- Only one person should not carry the product if it weighs more than 20 kg.
- Some products use PP bands for packaging. Do not use any PP bands for a means of transportation. It is dangerous.
- Do not touch the heat exchanger fins. Doing so may cut your fingers.
- When transporting the outdoor unit, suspending it at the specified positions on the unit base. Also support the outdoor unit at four points so that it cannot slip sideways.

**Safely dispose of the packing materials.**

- Packing materials, such as nails and other metal or wooden parts, may cause stabs or other injuries.
- Tear apart and throw away plastic packaging bags so that children may not play with them. If children play with a plastic bag which was not torn apart, they face the risk of suffocation.

**Do not touch any of the refrigerant piping during and after operation.**

- It can cause a burn or frostbite.

**Do not directly turn off the main power switch after stopping operation.**

- Wait at least 5 minutes before turning off the main power switch. Otherwise it may result in water leakage or other problems.

**Use a firm stool or ladder when cleaning or maintaining the air conditioner.**

- Be careful and avoid personal injury.

**Turn on the power at least 6 hours before starting operation.**

- Starting operation immediately after turning on the main power switch can result in severe damage to internal parts. Keep the power switch turned on during the operational season.

**Do not operate the air conditioner with the panels or guards removed.**

- Rotating, hot, or high-voltage parts can cause injuries.

**Auto-addressing should be done in condition of connecting the power of all indoor and outdoor units. Auto-addressing should also be done in case of changing the indoor unit PCB.**

**Do not insert hands or other objects through the air inlet or outlet while the air conditioner is plugged in.**

- There are sharp and moving parts that could cause personal injury.

# Installation Process

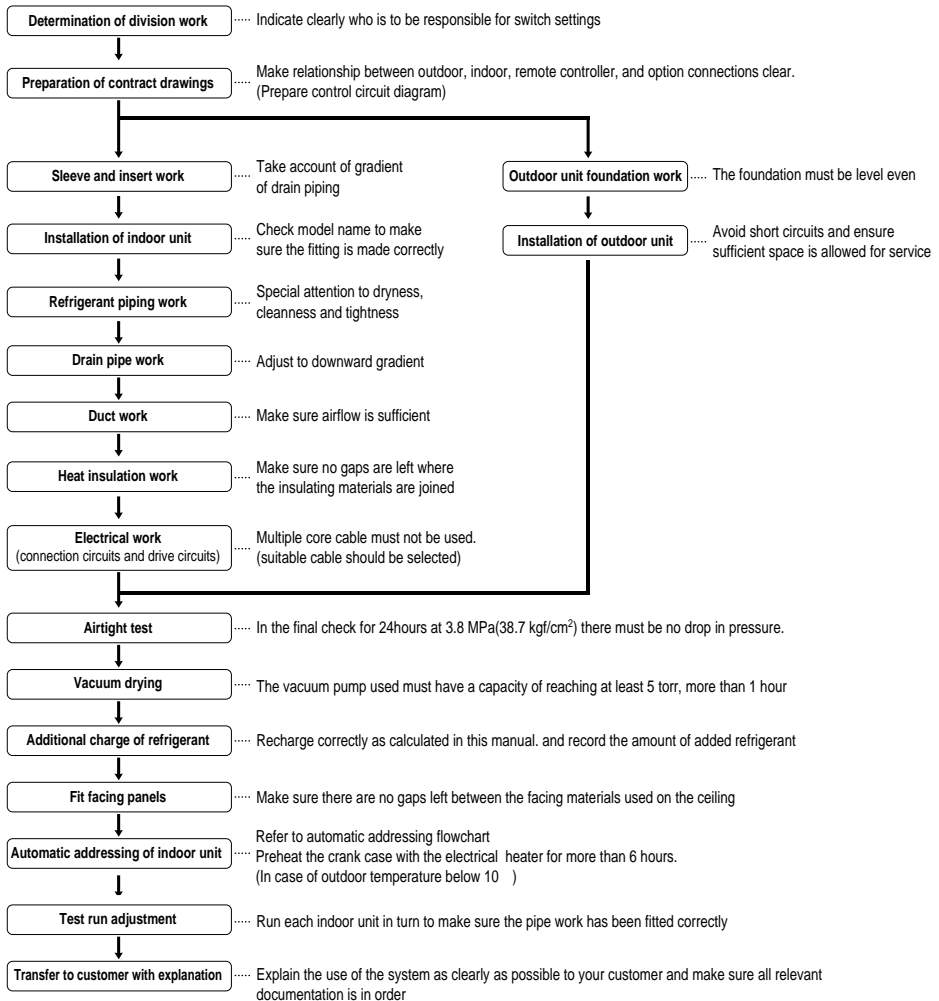

## ⚠ CAUTION

- The above list indicates the order in which the individual work operations are normally carried out but this order may be varied where local conditions warrants such change.
- The wall thickness of the piping should comply with the relevant local and national regulations for the designed pressure 3.8MPa.
- Since R410A is a mixed refrigerant, the required additional refrigerant must be charged in its liquid state.(If the refrigerant is charged in its gaseous state, its composition changes and the system will not work properly.)

## Outdoor Units Information

### CAUTION

Ratio of the connectable Indoor Units to the Outdoor: Within 50 ~ 130%

Ratio of running Indoor Units to the Outdoor: Within 10 ~ 100%

A combination operation over 100% cause to reduce each indoor unit capacity.

### Power Supply: Outdoor Unit (1Ø, 220~240V, 50Hz/1Ø, 220V, 60Hz)

System(HP)			4	5	6
Model			ARUN40GS2 ARUV40GS2	ARUN50GS2 ARUV50GS2	ARUN60GS2 ARUV60GS2
Refrigerant	Product charge	kg	3.7	3.7	3.7
	CF(Correction Factor)	kg	-0.5	0	0
Max. Connectable No. of Indoor Units			6	8	9
Net Weight	kg		118	118	118
Dimensions (WxHxD)	mm		950x1,380x330	950x1,380x330	950x1,380x330
	inch		37.4x54.3x13	37.4x54.3x13	37.4x54.3x13
Connecting Pipes	Liquid Pipes[mm(inch)]		9.52(3/8)	9.52(3/8)	9.52(3/8)
	Gas Pipes[mm(inch)]		15.88(5/8)	15.88(5/8)	19.05(3/4)

### Connectable Indoor Unit

**MULTI V<sub>mini</sub>** should be connected with "2 series" indoor unit only.

Ex) ARNU07GSEA2

## Before Installation

### Environment-friendly Alternative Refrigerant R410A

- The refrigerant R410A has the property of higher operating pressure in comparison with R22. Therefore, all materials have the characteristics of higher resisting pressure than R22 ones and this characteristic should be also considered during the installation. R410A is an azeotrope of R32 and R125 mixed at 50:50, so the ozone depletion potential (ODP) of R410A is 0. These days the developed countries have approved it as the environment-friendly refrigerant and encouraged to use it widely to prevent environment pollution.

#### **!** CAUTION:

- The wall thickness of the piping should comply with the relevant local and national regulations for the designed pressure 3.8MPa
- Since R410A is a mixed refrigerant, the required additional refrigerant must be charged in its liquid state.
- If the refrigerant is charged in its gaseous state, its composition changes and the system will not work properly.
- Do not place the refrigerant container under the direct rays of the sun to prevent it from exploding.
- For high-pressure refrigerant, any unapproved pipe must not be used.
- Do not heat pipes more than necessary to prevent them from softening.
- Be careful not to install wrongly to minimize economic loss because it is expensive in comparison with R22.

### Transporting the Unit

- When carrying the suspended, unit pass the ropes between legs of base panel under the unit.
- Always lift the unit with ropes attached at four points so that impact is not applied to the unit.
- Attach the ropes to the unit at an angle of 40° or less.
- Use only accessories and parts which are of the designated specification when installing.

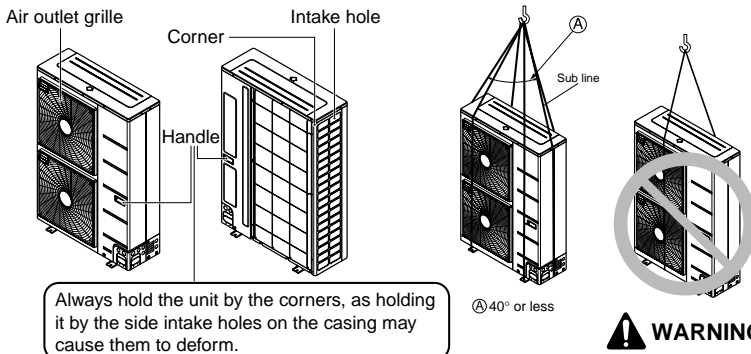

#### **!** CAUTION:

##### Be very careful while carrying the product.

- Do not have only one person carry product if it is more than 20 kg.
- PP bands are used to pack some products. Do not use them as a mean for transportation because they are dangerous.
- Do not touch heat exchanger fins with your bare hands. Otherwise you may get a cut in your hands.
- Tear plastic packaging bag and scrap it so that children cannot play with it. Otherwise plastic packaging bag may suffocate children to death.
- When carrying in Outdoor Unit, be sure to support it at four points. Carrying in and lifting with 3-point support may make Outdoor Unit unstable, resulting in a fall.

## Select the Best Location

1. Select space for installing outdoor unit, which will meet the following conditions:
  - No direct thermal radiation from other heat sources
  - No possibility of annoying neighbors by noise from unit
  - No exposition to strong wind
  - With strength which bears weight of unit
  - Note that drain flows out of unit when heating
  - With space for air passage and service work shown next
  - Because of the possibility of fire, do not install unit to the space where generation, inflow, stagnation, and leakage of combustible gas is expected.
  - Avoid unit installation in a place where acidic solution and spray (sulfur) are often used.
  - Do not use unit under any special environment where oil, steam and sulfuric gas exist.
  - It is recommended to fence round the outdoor unit in order to prevent any person or animal from accessing the outdoor unit.
  - If installation site is area of heavy snowfall, then the following directions should be observed.
    - Make the foundation as high as possible.
    - Fit a snow protection hood.
2. Select installation location considering following conditions to avoid bad condition when additionally performing defrost operation.
  - Install the outdoor unit at a place well ventilated and having a lot of sunshine in case of installing the product at a place with a high humidity in winter (near beach, coast, lake, etc).  
(Ex) Rooftop where sunshine always shines.
  - Performance of heating will be reduced and preheat time of the indoor unit may be lengthened in case of installing the outdoor unit in winter at following location:
    - Shade position with a narrow space
    - Location with much moisture in neighboring floor.
    - Location with much humidity around.
    - Location where ventilation is good.It is recommended to install the outdoor unit at a place with a lot of sunshine as possible as.
    - Location where water gathers since the floor is not even.
3. When installing the outdoor unit in a place that is constantly exposed to a strong wind like a coast or on a high story of a building, secure a normal fan operation by using a duct or a wind shield.
  - Install the unit so that its discharge port faces to the wall of the building.  
Keep a distance 500mm or more between the unit and the wall surface.
  - Supposing the wind direction during the operation season of the air conditioner, install the unit so that the discharge port is set at right angle to the wind direction.

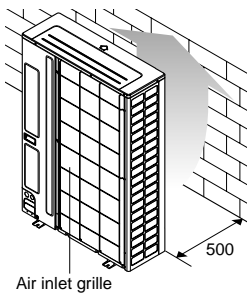

Turn the air outlet side toward the building's wall, fence or windbreak screen.

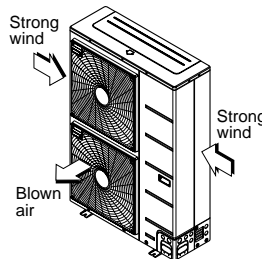

Set the outlet side at a right angle to the direction of the wind.

# Installation Space

- The following values are the least space for installation.  
If any service area is needed for service according to field circumstance, obtain enough service space.
- The unit of values is mm.

## ■ In case of obstacles on the suction side

### 1. Stand alone installation

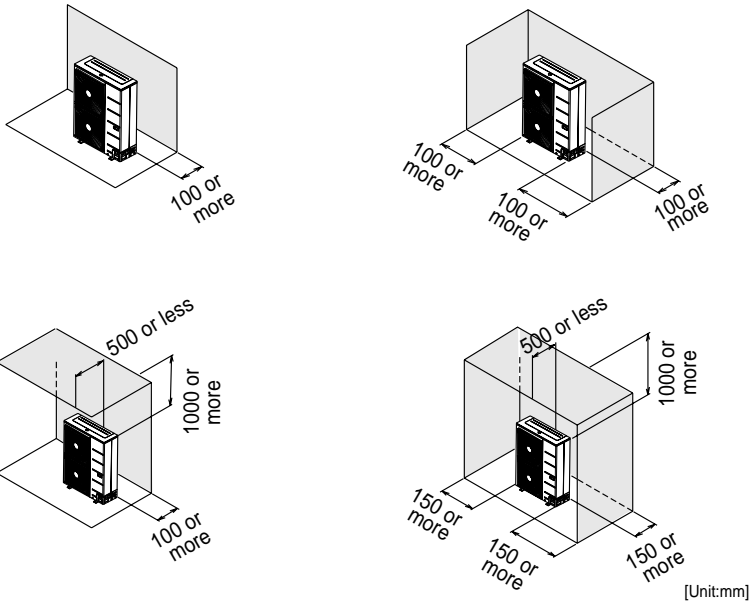

### 2. Collective installation

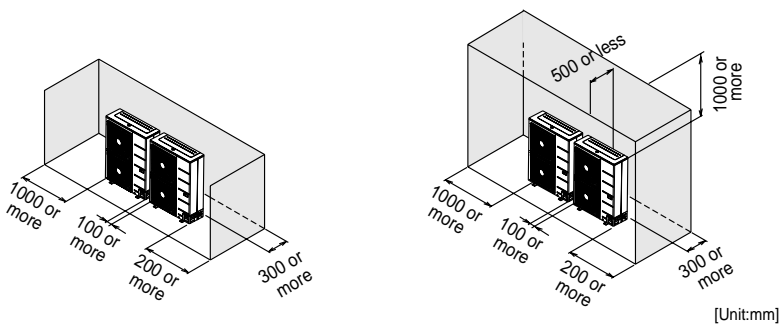

■ In case of obstacles on the discharge side

1. Stand alone installation

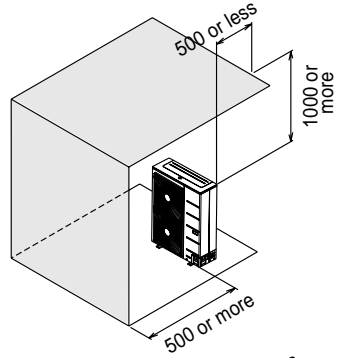
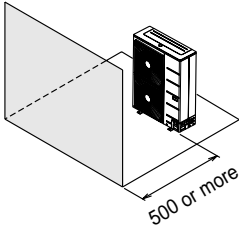

2. Collective installation

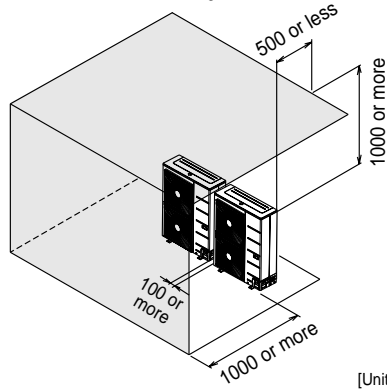
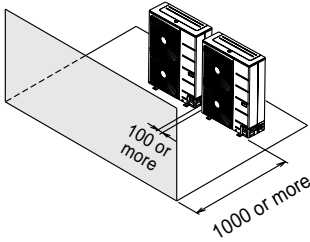

[Unit:mm]

■ In case of obstacles on the suction and the discharge side

○ Obstacle height of discharge side is higher than the unit

1. Stand alone installation

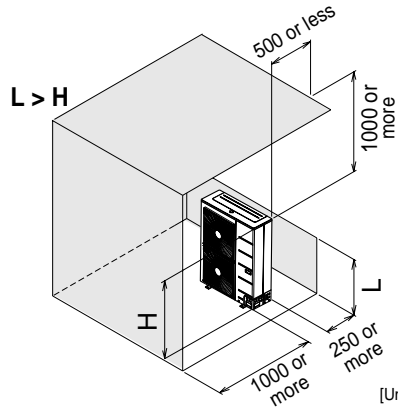
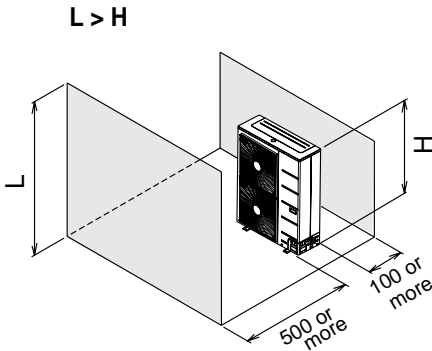

[Unit:mm]

2. Collective installation

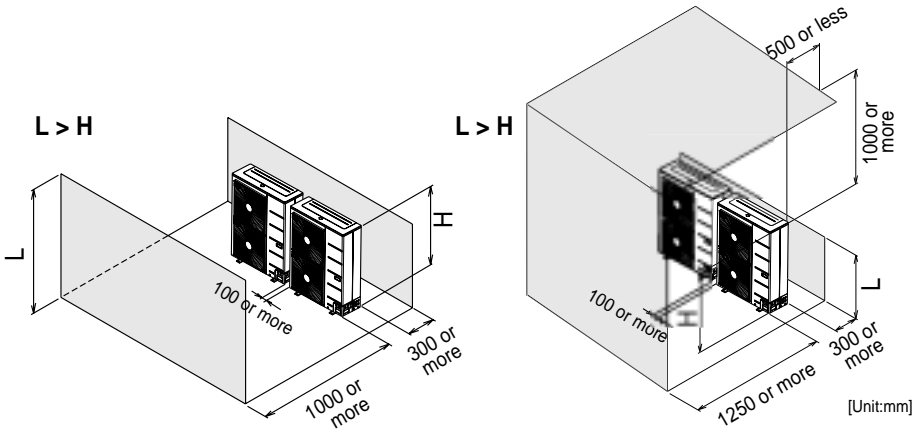

Obstacle height of discharge side is lower than the unit

1. Stand alone installation

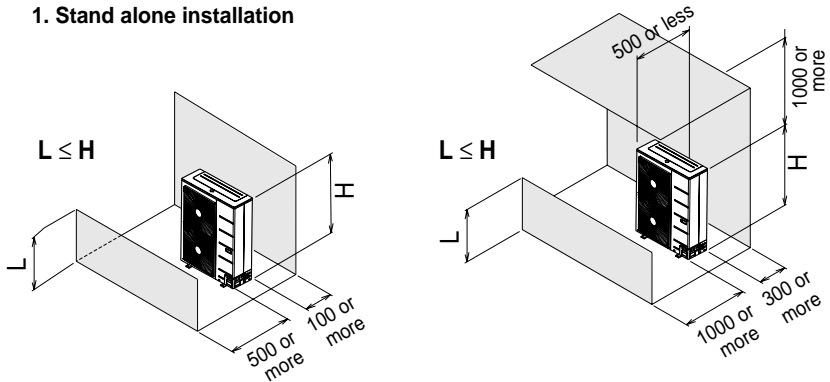

2. Collective installation

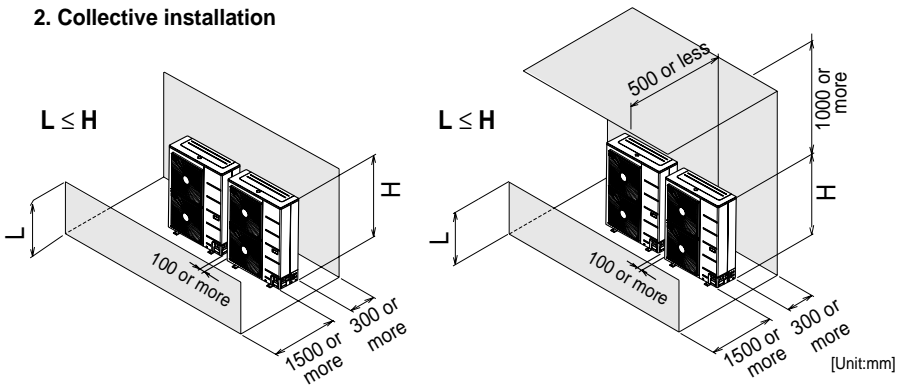

## Collective / Continuous Installation for roof top use

Space required for collective installation and continuous installation: When installing several units, leave space between each block as shown below considering passage for air and people.

### 1. One row of stand alone installation

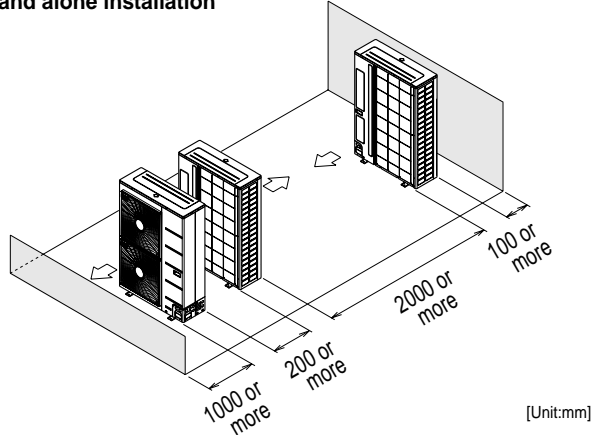

### 2. Rows of collective installation (2 or more)

- L should be smaller than H

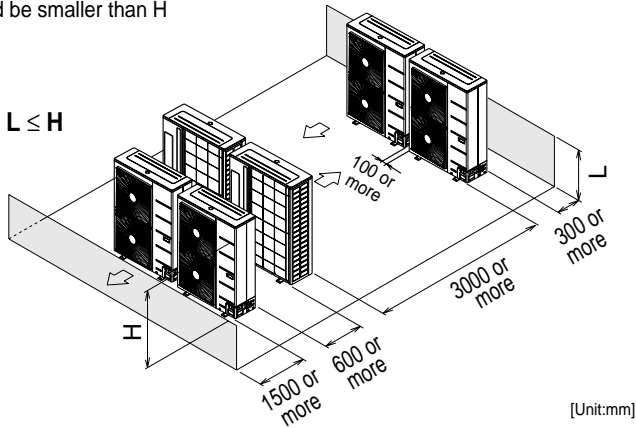

### Seasonal wind and cautions in winter

- Sufficient measures are required in a snow area or severe cold area in winter so that product can be operated well.
- Get ready for seasonal wind or snow in winter even in other areas.
- Install a suction and discharge duct not to let in snow or rain.
- Install the outdoor unit not to come in contact with snow directly. If snow piles up and freezes on the air suction hole, the system may malfunction. If it is installed at snowy area, attach the hood to the system.
- Install the outdoor unit at the higher installation console by 50cm than the average snowfall (annual average snowfall) if it is installed at the area with much snowfall.

1. The height of H frame must be more than 2 times the snowfall and its width shall not exceed the width of the product. (If width of the frame is wider than that of the product, snow may accumulate)
2. Don't install the suction hole and discharge hole of the Outdoor Unit facing the seasonal wind.

# Installation

## Foundation for Installation

- Check the strength and level of the installation ground so that the unit will not cause any operating vibration or noise after installation.
- Fix the unit securely by means of the foundation bolts. (Prepare 4sets of M12 foundation bolts, nuts and washers each which are available on the market.)
- It is best to screw in the foundation bolts until their length are 20mm from the foundation surface.

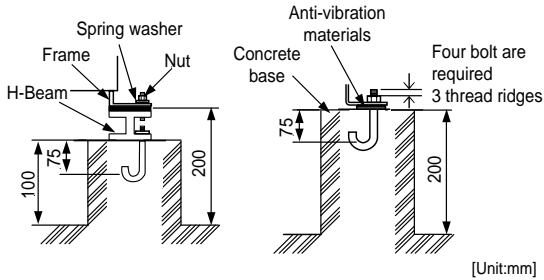

**Foundation bolt executing method**

If it is necessary to prevent the unit from falling over, install as shown in the figure.

- Prepare all 4 wires as indicated in the drawing
- Unscrew the top plate at the 4 location indicated A and B
- Put the screws through the nooses and screw them back tight

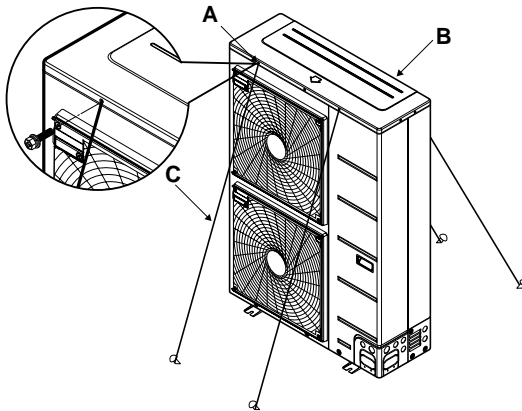

A : Location of the 2 fixation holes on the front side of the unit

B : Location of the 2 fixation holes on the rear side of the unit

## Preparation of Piping

Main cause of gas leakage is defect in flaring work. Carry out correct flaring work in the following procedure.

### 1) Cut the pipes and the cable.

- Use the accessory piping kit or the pipes purchased locally.
- Measure the distance between the indoor and the outdoor unit.
- Cut the pipes a little longer than measured distance.
- Cut the cable 1.5m longer than the pipe length.

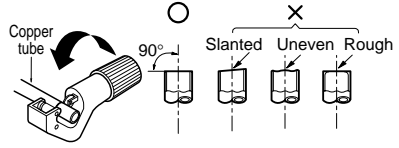

### 2) Burrs removal

- Completely remove all burrs from the cut cross section of pipe/tube.
- Put the end of the copper tube/pipe to downward direction as you remove burrs in order to avoid to let burrs drop in the tubing.

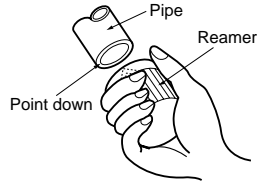

### 3) Flaring work

- Carry out flaring work using flaring tool as shown right.

Indoor unit [kW(Btu/h)]	Pipe		Unit : mm (inch)	
	Gas	Liquid	"A"	
<5.6(19,100)	12.7(1/2)	6.35(1/4)	1.6~1.8 (0.63~0.71)	1.1~1.3 (0.43~0.51)
<16.0(54,600)	15.88(5/8)	9.52(3/8)	1.6~1.8 (0.63~0.71)	1.5~1.7 (0.59~0.67)
<22.4(76,400)	9.52(3/4)	9.52(3/8)	1.9~2.1 (0.75~0.83)	1.5~1.7 (0.59~0.67)

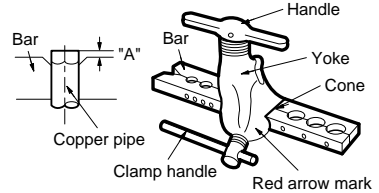

Firmly hold copper tube in a bar(or die) as indicated dimension in the table above.

### 4) Check

- Compare the flared work with figure right.
- If flare is noted to be defective, cut off the flared section and do flaring work again.

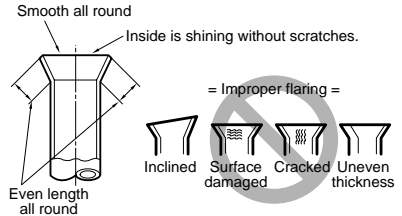

## FLARE SHAPE and FLARE NUT TIGHTENING TORQUE

### Precautions when connecting pipes

- See the following table for flare part machining dimensions.
- When connecting the flare nuts, apply refrigerant oil to the inside and outside of the flares and turn them three or four times at first. (Use ester oil or ether oil.)
- See the following table for tightening torque. (Applying too much torque may cause the flares to crack.)
- After all the piping has been connected, use nitrogen to perform a gas leak check.

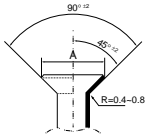
Pipe size	Tightening Torque(kgf-cm)	A(mm)	flare shape
9.52	340~420	12.6~13.0	
12.7	550~660	15.8~16.2	
15.88	630~820	19.0~19.4	

### CAUTION

**Always use a charge hose for service port connection.**

**After tightening the cap, check that no refrigerant leaks are present.**

**When loosening a flare nut, always use two wrenches in combination, When connecting the piping, always use a spanner and torque wrench in combination to tighten the flare nut.**

**When connecting a flare nut, coat the flare(inner and outer faces) with oil for R410A(PVE) and hand tighten the nut 3 to 4 turns as the initial tightening.**

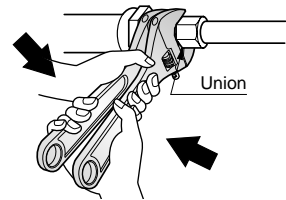

## HEAT INSULATION

1. Use the heat insulation material for the refrigerant piping which has an excellent heat-resistance (over 120°C).

2. Precautions in high humidity circumstance:

This air conditioner has been tested according to the "ISO Conditions with Mist" and confirmed that there is not any default. However, if it is operated for a long time in high humid atmosphere (dew point temperature: more than 23°C), water drops are liable to fall. In this case, add heat insulation material according to the following procedure:

- Heat insulation material to be prepared... EPDM (Ethylene Propylene Diene Methylene)-over 120°C the heat-resistance temperature.
- Add the insulation over 10mm thickness at high humidity environment.

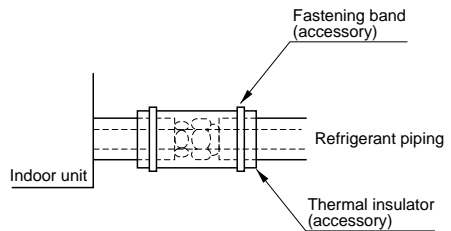

# Refrigerant Piping

## ■ Connecting the pipes to the outdoor unit

### 1. Liquid pipe

- Align the center of the pipings and sufficiently tighten the flare nut with fingers.
- Finally, tighten the flare nut with torque wrench until the wrench clicks.
  - When tightening the flare nut with torque wrench, ensure the direction for tightening follows the arrow on the wrench.

Outside diameter		Torque
mm	inch	kgf-m
Ø9.52	3/8	3.4-4.2

### 2. Gas pipe

- Braze suitable field piping with service valve of gas pipe.

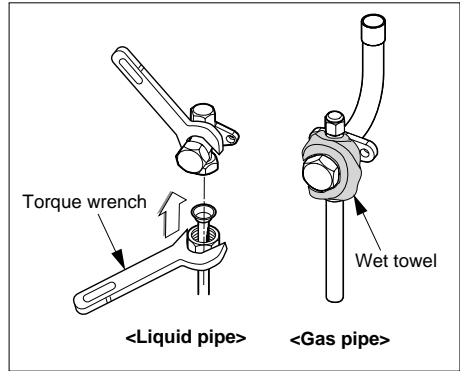

## ⚠ CAUTION

Take care so that there is no thermal damage on the service valves of the outdoor unit. (Especially packing part of service port.) Wrap the service valve with a wet towel when brazing it as shown figure above.

## ■ Possible direction for field piping

- For the units with capacity more than 42 kBtu/h, the installation piping is connectable in four directions. (refer to figure 1)
- When connecting in a downward direction, knock out the knockout hole of the base pan. (refer to figure 2)

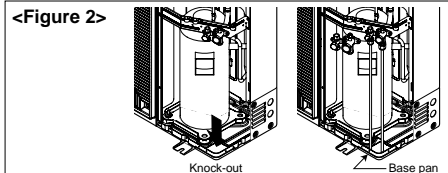
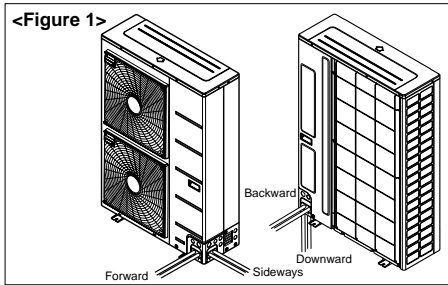

## ■ Preventing foreign objects from entering (Figure3)

- Plug the pipe through-holes with putty or insulation material (procured locally) to stop up all gaps, as shown in the figure 3.
- Insects or small animals entering the outdoor unit may cause a short circuit in the electrical box.

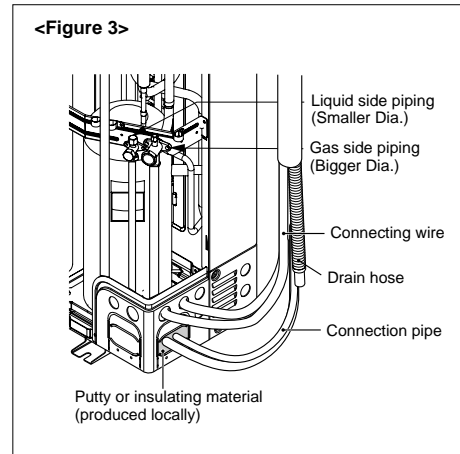

## ⚠ CAUTION

- Make sure that pipe doesn't contact with the compressor terminal cover and comp bolt.
- Always insulate the liquid and gas-side field piping and branch.

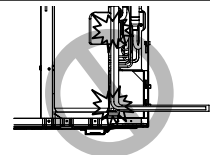

## Cautions for Handling Service Valve

- The service valves are closed at shipment from the factory



### CAUTION

Make sure to keep the valve open during operation

The names of parts of the service valve are shown in the figure.

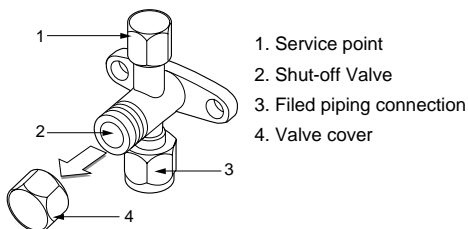

- since the side boards may be deformed if only a torque wrench is used when loosening or tightening flare nuts, always lock the shut-off valve with a wrench and then use a torque wrench. Do not place wrenches on the valve cover.

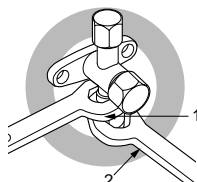
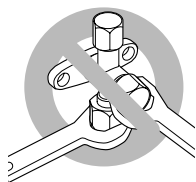

Do not apply force on the valve cover, this may result in a refrigerant leak.

## How to Use the Shut-Off Valve

Use hexagonal wrenches 4mm or 6mm

### • Opening the valve

- Place the hexagonal wrench on the valve bar and turn counter-clockwise.
- Stop when the valve bar no longer turns. It is now open.

### • Closing the valve

- Place the hexagonal wrench on the valve bar and turn clockwise.
- Stop when the valve bar no longer turns. It is now closed.

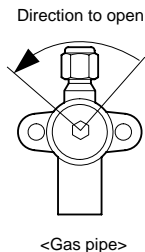
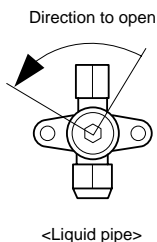

**Caution**

1. Use the following materials for refrigerant piping.
  - Material: Seamless phosphorous deoxidized copper pipe
  - Wall thickness : Comply with the relevant local and national regulations for the designed pressure 3.8MPa. We recommend the following table as the minimum wall thickness.

Outer diameter [mm]	6.35	9.52	12.7	15.88	19.05	22.2	25.4	28.58	31.8	34.9	38.1	41.3
Minimum thickness [mm]	0.8	0.8	0.8	0.99	0.99	0.99	0.99	0.99	1.1	1.21	1.35	1.43

2. Commercially available piping often contains dust and other materials. Always blow it clean with a dry inert gas.
3. Use care to prevent dust, water or other contaminants from entering the piping during installation.
4. Reduce the number of bending portions as much as possible, and make bending radius as big as possible.
5. Always use the branch piping set shown below, which are sold separately.

Y branch		Header		
		4 branch	7 branch	10 branch
ARBLN01621	ARBLN03321	ARBL054	ARBL057	ARBL1010
ARBLN07121	ARBLN14521	ARBL104	ARBL107	ARBL2010

6. If the diameters of the branch piping of the designated refrigerant piping differs, use a pipe cutter to cut the connecting section and then use an adapter for connecting different diameters to connect the piping.
7. Always observe the restrictions on the refrigerant piping (such as rated length, difference in height, and piping diameter).  
Failure to do so can result in equipment failure or a decline in heating/cooling performance.
8. A second branch cannot be made after a header. (These are shown by ⊘.)

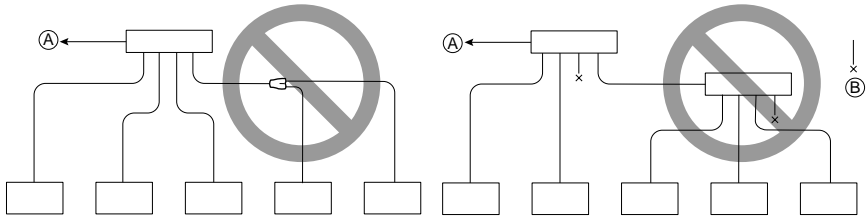

- (A) To Outdoor Unit
- (B) Sealed Piping

9. The Multi V will stop due to an abnormality like excessive or insufficient refrigerant. At such a time, always properly charge the unit. When servicing, always check the notes concerning both the piping length and the amount of additional refrigerant.
10. Never use refrigerant to perform an air purge. Always evacuate using a vacuum pump.
11. Always insulate the piping properly. Insufficient insulation will result in a decline in heating/cooling performance, drip of condensate and other such problems.
12. When connecting the refrigerant piping, make sure the service valves of the Outdoor Unit is completely closed (the factory setting) and do not operate it until the refrigerant piping for the Outdoor and Indoor Units has been connected, a refrigerant leakage test has been performed and the evacuation process has been completed.
13. Always blow nitrogen into pipe which is brazed. Always use a non-oxidizing brazing material for brazing the parts and do not use flux. If not, oxidized film can cause clogging or damage to the compressor unit and flux can harm the copper piping or refrigerant oil.

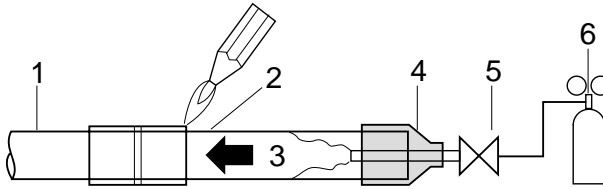

1	Refrigerant piping	4	Taping
2	Pipe to be brazed	5	Valve
3	Nitrogen	6	Pressure-reducing valve

### WARNING

**When installing and moving the air conditioner to another site, be sure to make recharge refrigerant after perfect evacuation.**

- If a different refrigerant or air is mixed with the original refrigerant, the refrigerant cycle may malfunction and the unit may be damaged.
- After selecting diameter of the refrigerant pipe to suit total capacity of the indoor unit connected after branching, use an appropriate branch pipe set according to the pipe diameter of the indoor unit and the installation pipe drawing.

### WARNING

**Do not use anti-oxidants when brazing the pipe joints. Residue can clog pipes and break equipment.**

**Selection of Refrigerant Piping**

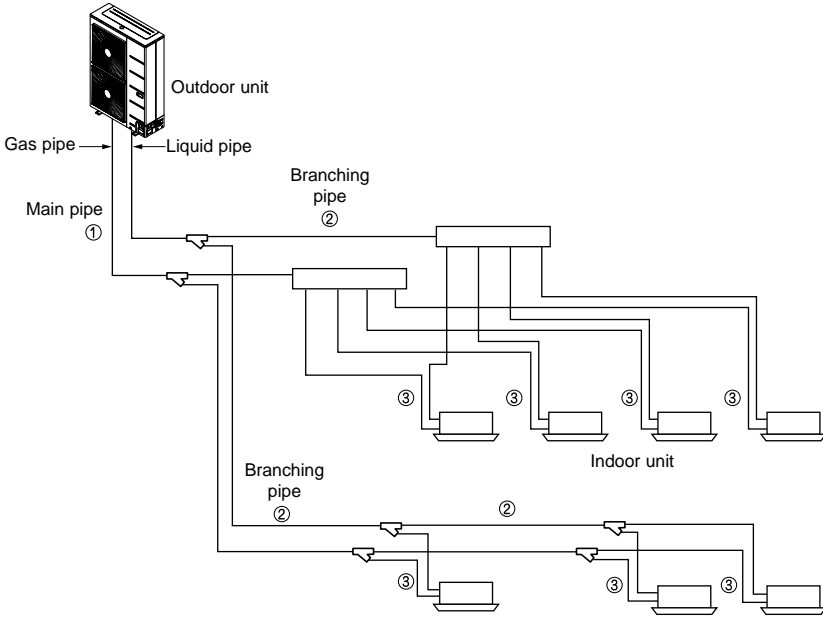

No.	Piping parts	Name	Selection of pipe size															
①	Outdoor unit ↓ 1st branching section	Main pipe	<table border="1"> <thead> <tr> <th colspan="3">Size of main pipe</th> </tr> <tr> <th>Outdoor unit capacity type</th> <th>Liquid pipe [mm(inch)]</th> <th>Gas pipe [mm(inch)]</th> </tr> </thead> <tbody> <tr> <td>4 HP</td> <td>Ø9.52(3/8)</td> <td>Ø15.88(5/8)</td> </tr> <tr> <td>5 HP</td> <td>Ø9.52(3/8)</td> <td>Ø15.88(5/8)</td> </tr> <tr> <td>6 HP</td> <td>Ø9.52(3/8)</td> <td>Ø19.05(3/4)</td> </tr> </tbody> </table>	Size of main pipe			Outdoor unit capacity type	Liquid pipe [mm(inch)]	Gas pipe [mm(inch)]	4 HP	Ø9.52(3/8)	Ø15.88(5/8)	5 HP	Ø9.52(3/8)	Ø15.88(5/8)	6 HP	Ø9.52(3/8)	Ø19.05(3/4)
Size of main pipe																		
Outdoor unit capacity type	Liquid pipe [mm(inch)]	Gas pipe [mm(inch)]																
4 HP	Ø9.52(3/8)	Ø15.88(5/8)																
5 HP	Ø9.52(3/8)	Ø15.88(5/8)																
6 HP	Ø9.52(3/8)	Ø19.05(3/4)																
②	Branching section ↓ Branching section	Branching pipe	<table border="1"> <thead> <tr> <th colspan="3">Pipe size of between branching sections</th> </tr> <tr> <th>Indoor unit capacity[kW(Btu/h)]</th> <th>Liquid pipe [mm(inch)]</th> <th>Gas pipe [mm(inch)]</th> </tr> </thead> <tbody> <tr> <td>≤ 5.6(19,100)</td> <td>Ø6.35(1/4)</td> <td>Ø12.7(1/2)</td> </tr> <tr> <td>&lt; 16.0(54,600)</td> <td>Ø9.52(3/8)</td> <td>Ø15.88(5/8)</td> </tr> <tr> <td>&lt; 22.4(76,400)</td> <td>Ø9.52(3/8)</td> <td>Ø19.05(3/4)</td> </tr> </tbody> </table>	Pipe size of between branching sections			Indoor unit capacity[kW(Btu/h)]	Liquid pipe [mm(inch)]	Gas pipe [mm(inch)]	≤ 5.6(19,100)	Ø6.35(1/4)	Ø12.7(1/2)	< 16.0(54,600)	Ø9.52(3/8)	Ø15.88(5/8)	< 22.4(76,400)	Ø9.52(3/8)	Ø19.05(3/4)
Pipe size of between branching sections																		
Indoor unit capacity[kW(Btu/h)]	Liquid pipe [mm(inch)]	Gas pipe [mm(inch)]																
≤ 5.6(19,100)	Ø6.35(1/4)	Ø12.7(1/2)																
< 16.0(54,600)	Ø9.52(3/8)	Ø15.88(5/8)																
< 22.4(76,400)	Ø9.52(3/8)	Ø19.05(3/4)																
③	Branching section ↓ Indoor unit	Indoor unit connecting pipe	<table border="1"> <thead> <tr> <th colspan="3">Connecting pipe size of indoor unit</th> </tr> <tr> <th>Indoor unit capacity[kW(Btu/h)]</th> <th>Liquid pipe [mm(inch)]</th> <th>Gas pipe [mm(inch)]</th> </tr> </thead> <tbody> <tr> <td>≤ 5.6(19,100)</td> <td>Ø6.35(1/4)</td> <td>Ø12.7(1/2)</td> </tr> <tr> <td>&lt; 16.0(54,000)</td> <td>Ø9.52(3/8)</td> <td>Ø15.88(5/8)</td> </tr> </tbody> </table>	Connecting pipe size of indoor unit			Indoor unit capacity[kW(Btu/h)]	Liquid pipe [mm(inch)]	Gas pipe [mm(inch)]	≤ 5.6(19,100)	Ø6.35(1/4)	Ø12.7(1/2)	< 16.0(54,000)	Ø9.52(3/8)	Ø15.88(5/8)			
Connecting pipe size of indoor unit																		
Indoor unit capacity[kW(Btu/h)]	Liquid pipe [mm(inch)]	Gas pipe [mm(inch)]																
≤ 5.6(19,100)	Ø6.35(1/4)	Ø12.7(1/2)																
< 16.0(54,000)	Ø9.52(3/8)	Ø15.88(5/8)																

## Allowable Length/Height Difference of Refrigerant Piping

### ■ Y Branch Method

#### Example : 5 Indoor Units connected

- Ⓐ : Outdoor Unit
- Ⓑ : 1st branch (Y branch)
- Ⓒ : Indoor Units

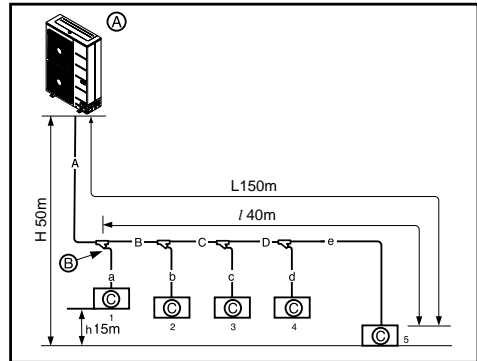

#### ○ Total pipe length = $A+B+C+D+a+b+c+d+e \leq 300\text{m}$

<b>L</b>	Longest pipe length	Equivalent pipe length
	$A+B+C+D+e \leq 150\text{m}$	* $A+B+C+D+e \leq 175\text{m}$
<b>l</b>	Longest pipe length after 1st branch	
	$B+C+D+e \leq 40\text{m}$	
<b>H</b>	Difference in height(Outdoor Unit ↔ Indoor Unit)	
	$H \leq 50\text{m}$ ( 40m : Outdoor Unit is lower than Indoor Units)	
<b>h</b>	Difference in height (Indoor Unit ↔ Indoor Unit)	
	$h \leq 15\text{m}$	

- \* : Assume equivalent pipe length of Y branch to be 0.5m, that of header to be 1m, calculation purpose
- \*\* : Indoor Unit should be installed at lower position than the header

■ Header Method

Example : 6 Indoor Units connected

- Ⓐ : Outdoor Unit
- Ⓑ : 1st branch
- Ⓒ : Indoor Units
- Ⓓ : Sealed piping

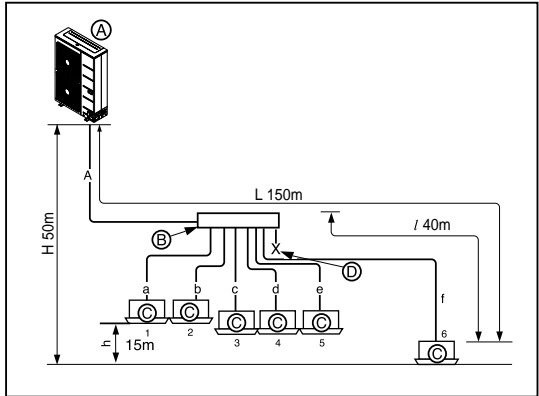

Ⓒ Total pipe length =  $A+a+b+c+d+e+f \leq 300m$

<b>L</b>	Longest pipe length	* Equivalent pipe length
	$A+f \leq 150m$	$A+f \leq 175m$
<b>l</b>	Longest pipe length after 1st branch	
	$f \leq 40m$	
<b>H</b>	Difference in height(Outdoor Unit ↔ Indoor Unit)	
	$H \leq 50m$ (40m : Outdoor Unit is lower)**	
<b>h</b>	Difference in height (Indoor Unit ↔ Indoor Unit)	
	$h \leq 15m$	

**⚠ WARNING**

**Pipe length after header branching (a~f)**  
 It is recommended that difference in length of the pipes connected to the Indoor Units is minimized. Performance difference between Indoor Units may occur.

- \* : Assume equivalent pipe length of Y branch to be 0.5m, that of header to be 1m, calculation purpose
- \*\* : Indoor Unit should be installed at lower position than the header

## ■ Combination of Y branch/header method

### Example : 5 Indoor Units connected

- Ⓐ : Outdoor Unit
- Ⓑ : 1st branch (Y branch)
- Ⓒ : Y branch
- Ⓓ : Indoor Unit
- Ⓔ : Header
- Ⓕ : Sealed piping

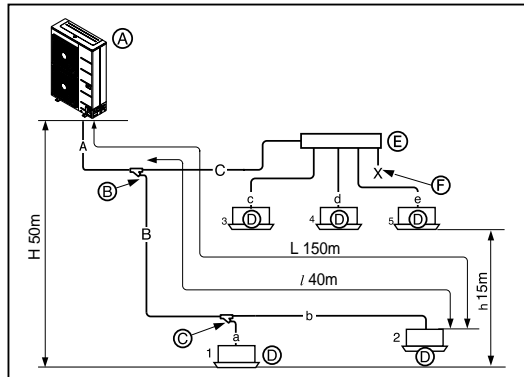

**Branch pipe can not be used after header**

### ○ Refrigerant pipe diameter from branch to branch (B,C)

Downward Indoor Unit total capacity [kW(Btu/h)]	Liquid pipe [mm(inch)]	Gas pipe [mm(inch)]
≤5.6(19,100)	Ø6.35(1/4)	Ø12.7(1/2)
<16(54,600)	Ø9.52(3/8)	Ø15.88(5/8)
<22.4(76,400)	Ø9.52(3/8)	Ø19.05(3/4)

### ○ Total pipe length = A+B+C+a+b+c+d+e ≤ 300m

<b>L</b>	Longest pipe length	* Equivalent pipe length
	A+B+b ≤ 150m	A+B+b ≤ 175m
<b>l</b>	Longest pipe length after 1st branch	
	B+b ≤ 40m	
<b>H</b>	Difference in height(Outdoor Unit ↔ Indoor Unit)	
	H ≤ 50m (40m : Outdoor Unit is lower than Indoor Units)**	
<b>h</b>	Difference in height (Indoor Unit ↔ Indoor Unit)	
	h ≤ 15m	

- \* : Assume equivalent pipe length of Y branch to be 0.5m, that of header to be 1m, calculation purpose
- \*\* : Indoor Unit should be installed at lower position than the header



### WARNING

It is recommended that difference of piping length for pipes connected to the Indoor Unit is minimized. Performance difference between Indoor Units may occur.

# The Amount of Refrigerant

## 1. Normal condition

The calculation of the additional charge should take into account the length of pipe.

$$\begin{aligned}
 & \text{(A) } \boxed{\text{Product Charge(kg)}} \\
 & \text{(B) } \boxed{\text{Additional charge (kg)}} \\
 & = \boxed{\text{Total liquid pipe (m)}} \\
 & \times \boxed{\text{Additional refrigerant charge amount per liquid pipe 1m (Table 1)}} \\
 & + \boxed{\text{Correction Factor (kg) (Table 2)}} \\
 & \boxed{\text{Total amount(kg)}} = \text{(A) + (B)}
 \end{aligned}$$

Example : 5 HP

L1	Ø9.52:10m	L2	Ø9.52:10m	L3	Ø9.52:5m		
a	Ø9.52:3m	b	Ø6.35:3m	c	Ø6.35:4m	d	Ø6.35:5m

**Additional charge amount R (kg)**  
 = (Lx x 0.022kg/m) + (Ly x 0.061kg/m) + Correction factor  
 = (12 x 0.022kg/m) + (28 x 0.061kg/m) + 0  
 = 1.972

Lx : Real total length of liquid pipe Ø6.35(m)  
 Ly : Real total length of liquid pipe Ø9.52(m)

Table 1

Pipe diameter at liquid side (mm)	Ø6.35	Ø9.52	Ø12.7	Ø15.88	Ø19.05	Ø22.2
Additional refrigerant amount (kg/m)	0.022	0.061	0.118	0.173	0.266	0.354

Table 2

HP	4	5	6
PRODUCT CHARGE	3.7	3.7	3.7
CF	-0.5	0	0

## 2. Special condition

In case of the No. of CST TQ/RAC SE/ARTCOOL SF models are over than 50% of the connected indoor units when the total No. of connected indoor units are over than 50% of the max. connectable indoor units.

$$\boxed{\text{Total amount(kg)}} = \text{(A) + (B) + (C)}$$

■ Additional refrigerant charging amount (kg) : (C)

$$= (A \times \alpha + B \times \beta) - (AVG \times \beta)$$

- A = Total No. of TQ,SE and SF Indoor units,  $\alpha = 0.5$
- B = Total No. of except TQ,SE and SF Indoor units,  $\beta = 0.3$
- AVG = 50% of Max. No. of connectable Indoor units.

**Example)**

### 1) Installation Information

- Outdoor unit : 6HP
- Total indoor units : 6 units (TQ 3 units, SE 2 units, BH 1 unit)

### 2) Information from PDB

- Max. No. of connectable indoor units : 10 units
- Calculated additional refrigerant amount = 2 kg : (B)

### 3) Indoor refrigerant charging amount

$$= (5 \text{ units} \times 0.5 + 1 \text{ unit} \times 0.3) - (5 \text{ units} \times 0.3) = 1.3 \text{ kg} : \text{(C)}$$

- ▶ Revised the total additional charging amount = (B) + (C) = 2 kg + 1.3 kg = 3.3 kg

**⚠ CAUTION**

If a negative result is obtained from the calculation, no refrigerant needs to be added.

**⚠ WARNING****Regulation for refrigerant leakage**

: the amount of refrigerant leakage should satisfy the following equation for human safety.

$$\frac{\text{Total amount of refrigerant in the system}}{\text{Volume of the room at which Indoor Unit of the least capacity is installed}} \leq 0.44 \text{ ( kg / m}^3 \text{ )}$$

**If the above equation can not be satisfied, then follow the following steps.**

- Selection of air conditioning system: select one of the next
  1. Installation of effective opening part
  2. Reconfirmation of Outdoor Unit capacity and piping length
  3. Reduction of the amount of refrigerant
  4. Installation of 2 or more security device (alarm for gas leakage)
- Change Indoor Unit type
  - : installation position should be over 2m from the floor (Wall mounted type → Cassette type)
- Adoption of ventilation system
  - : choose ordinary ventilation system or building ventilation system
- Limitation in piping work
  - : Prepare for earthquake and thermal stress

**⚠ WARNING**

Refer to model information since the CF Value of correction factor differs depending on model.

## Distribution Method

### 1. Line Distribution

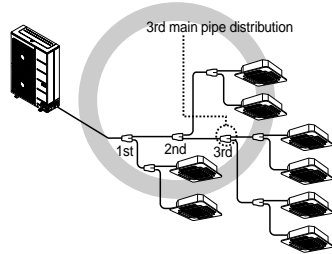
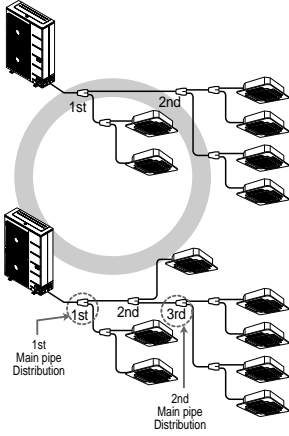

### 2. Vertical Distribution

Ensure that the branch pipes are attached vertically.

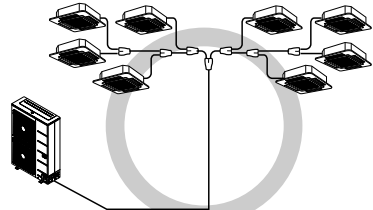
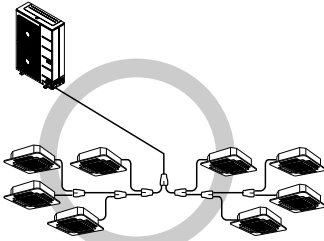

### 3. The others

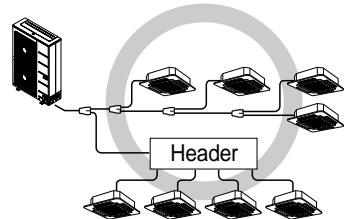
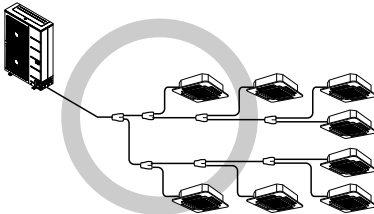

## Branch Pipe Fitting

### ■ Y branch

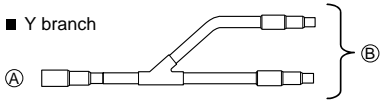

- Ⓐ To Outdoor Unit
- Ⓑ To Branch Piping or Indoor Unit

- Ensure that the branch pipes are attached horizontally or vertically (see the diagram below.)

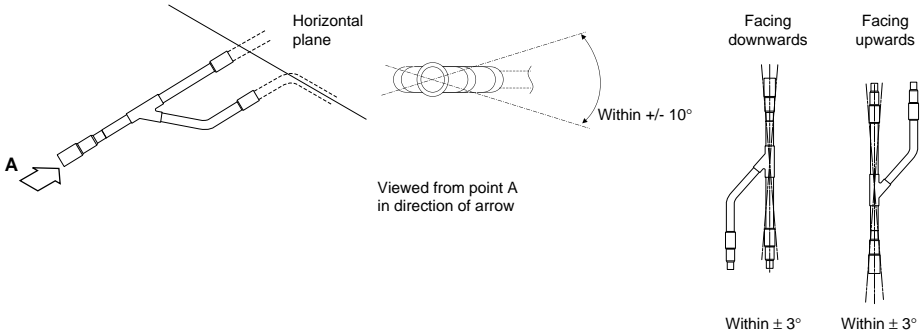

### ■ Header

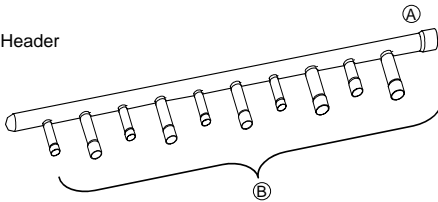

- Ⓐ To outdoor unit
- Ⓑ To indoor unit

- The indoor unit having larger capacity must be installed closer to Ⓐ than smaller one.
- If the diameter of the refrigerant piping selected by the procedures described is different from the size of the joint, the connecting section should be cut with a pipe cutter.

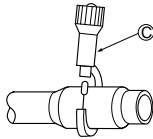

### Ⓒ Pipe cutter

- When the number of pipes to be connected is smaller than the number of header branches, install a cap to the unconnected branches.

## Refrigerant Piping

- When the number of indoor units to be connected to the branch pipes is less than the number of branch pipes available for connection then cap pipes should be fitted to the surplus branches.

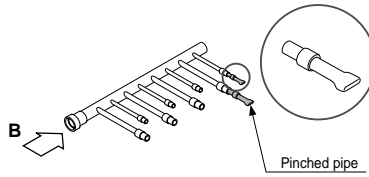

- Fit branch pipe lie in a horizontal plane.

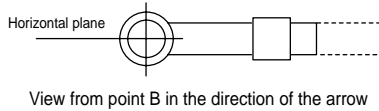

- Header should be insulated with the insulator in each kit.

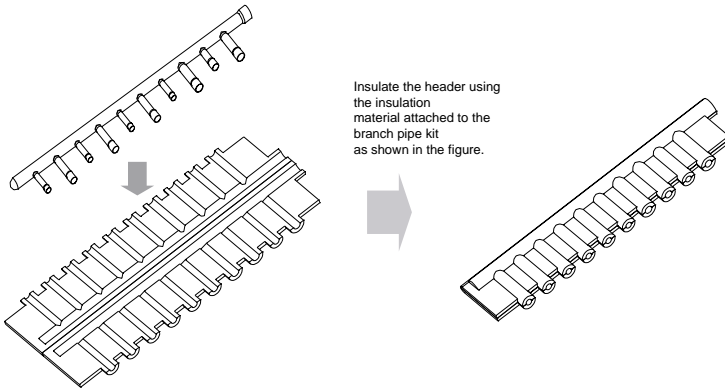

- Joints between branch and pipe should be sealed with the tape included in each kit.

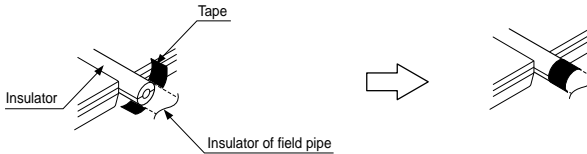

- Any cap pipe should be insulated using the insulator provided with each kit and then taped as described above.

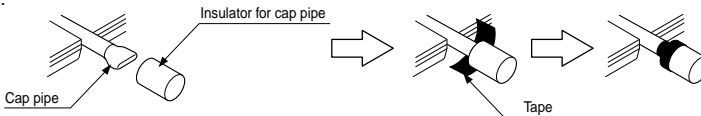

**Selection of Y Branch and Header**

**1. Y Branch**

[unit:mm]

Models	Gas pipe	Liquid pipe
ARBLN01621		
ARBLN03321		
ARBLN07121		
ARBLN14521		

\* For example. Indicated Ø9.52 is the outer diameter(O.D.) of field jointed piping

ENGLISH

2. Header

[unit:mm]

Models	Gas pipe	Liquid pipe
4 branch ARBL054		
7 branch ARBL057		
4 branch ARBL104		
7 branch ARBL107		
10 branch ARBL1010		
10 branch ARBL2010		

## Thermal Insulation of Refrigerant Piping

Be sure to give insulation work to refrigerant piping by covering liquid pipe and gas pipe separately with enough thickness heat-resistant polyethylene, so that no gap is observed in the joint between indoor unit and insulating material, and insulating materials themselves. When insulation work is insufficient, there is a possibility of condensation drip, etc. Pay special attention to insulation work to ceiling plenum.

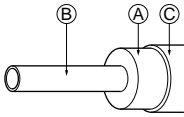

- (A) Heat insulation material
- (B) Pipe
- (C) Outer covering  
(Wind the connection part and cutting part of heat insulation material with a finishing tape.)

Heat insulation material	Adhesive + Heat - resistant polyethylene foam + Adhesive tape	
Outer covering	Indoor	Vinyl tape
	Floor exposed	Water-proof hemp cloth + Bronze asphalt
	Outdoor	Water-proof hemp cloth + Zinc plate + Oily paint

**Note:**

**When using polyethylene cover as covering material, asphalt roofing shall not be required.**

Bad example	<ul style="list-style-type: none"> <li>Do not insulate gas or low pressure pipe and liquid or high pressure pipe together.</li> </ul> <ul style="list-style-type: none"> <li>(A) Liquid pipe</li> <li>(B) Gas pipe</li> <li>(C) Power lines</li> <li>(D) Finishing tape</li> <li>(E) Insulating material</li> <li>(F) Communication lines</li> </ul>	<ul style="list-style-type: none"> <li>Be sure to fully insulate connecting portion.</li> </ul> <p>(A) These parts are not insulated.</p>
Good example	<ul style="list-style-type: none"> <li>(A) Liquid pipe</li> <li>(B) Gas pipe</li> <li>(C) Power lines</li> <li>(D) Insulating material</li> <li>(E) Communication lines</li> </ul> <p>Power lines    Communication lines</p> <p>Separation</p>	

### Penetrations

**Inner wall (concealed)**

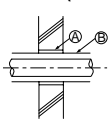

**Outer wall**

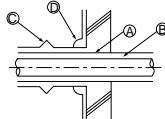

**Outer wall (exposed)**

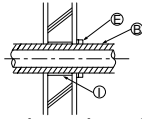

**Floor (fireproofing)**

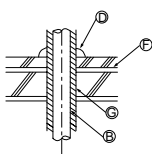

**Roof pipe shaft**

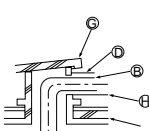

**Penetrating portion on fire limit and boundary wall**

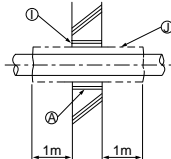

- (A) Sleeve
- (B) Heat insulating material
- (C) Lagging
- (D) Caulking material
- (E) Band
- (F) Waterproofing layer
- (G) Sleeve with edge
- (H) Lagging material
- (I) Mortar or other incombustible caulking
- (J) Incombustible heat insulation material

When filling a gap with mortar, cover the penetration part with steel plate so that the insulation material will not be caved in. For this part, use incombustible materials for both insulation and covering. (Vinyl covering should not be used.)

## Leak Test and Vacuum Drying

### 1. Leak test

Leak test should be made by pressurizing nitrogen gas to 3.8 MPa(38.7kgf/cm<sup>2</sup>). If the pressure does not drop for 24 hours, the system passes the test. If the pressure drops, check where the nitrogen leaks. For the test method, refer to the following figure. (Make a test with the service valves closed. Be also sure to pressurize liquid pipe, gas pipe and high/low pressure common pipe)

The test result can be judged good if the pressure has not be reduced after leaving for about one day after completion of nitrogen gas pressurization.

During this test, set DIP switch as Vacuum Mode.

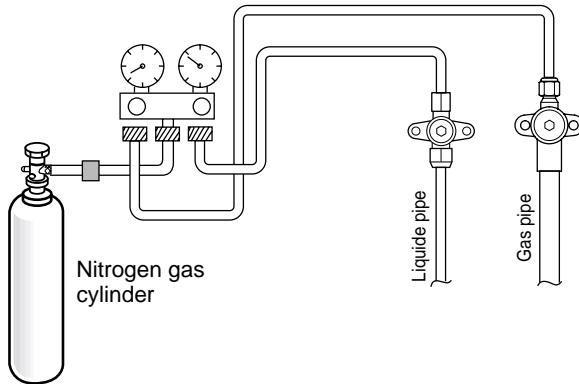

**Note:**

If the ambient temperature differs between the time when pressure is applied and when the pressure drop is checked, apply the following correction factor

There is a pressure change of approximately 0.1 kg/cm<sup>2</sup> (0.01 MPa) for each 1°C of temperature difference.

Correction= (Temp. at the time of pressurization – Temp. at the time of check) X 0.1

For example: Temperature at the time of pressurization (3.8 MPa) is 27 °C

24 hour later: 3.73 MPa, 20°C

In this case the pressure drop of 0.07 is because of temperature drop

And hence there is no leakage in pipe occurred.

**! CAUTION**

To prevent the nitrogen from entering the refrigeration system in the liquid state, the top of the cylinder must be at higher position than the bottom when you pressurize the system.

Usually the cylinder is used in a vertical standing position.

## 2. Vacuum

Vacuum drying should be made from the service port provided on the outdoor unit's service valve to the vacuum pump commonly used for liquid pipe, gas pipe. Vacuum of the pipe and the indoor units should be made from the port of the outdoor unit's service valve with the service valve closed.

\* Never perform air purging using refrigerant.

• Vacuum drying: Use a vacuum pump that can evacuate to -100.7kPa (5 Torr, -755mmHg).

1) Evacuate the system from the liquid and gas pipes with a vacuum pump for over 2 hrs and bring the system to -100.7kPa.

After maintaining system under that condition for over 1 hr, confirm the vacuum gauge rises. The system may contain moisture or leak.

2) Following should be executed if there is a possibility of moisture remaining inside the pipe.

(Rainwater may enter the pipe during work in the rainy season or over a long period of time)

After evacuating the system for 2 hrs, give pressure to the system to 0.05MPa(vacuum break) with

nitrogen gas and then evacuate it again with the vacuum pump for 1hr to -100.7kPa(vacuum drying). If the system cannot be evacuated to -100.7kPa within 2 hrs, repeat the steps of vacuum break and its drying.

Finally, check if the vacuum gauge does not rise or not, after maintaining the system in vacuum for 1 hr.

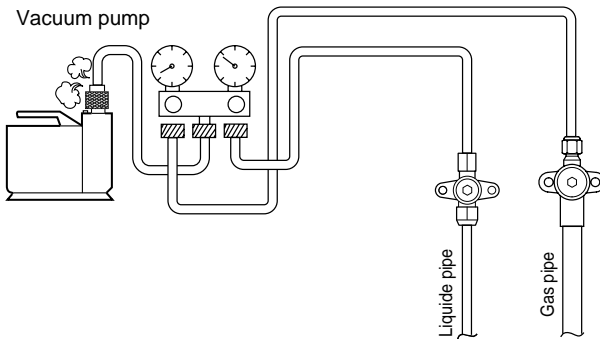

### WARNING

- If the primary charging is not performed after vacuum, wet air may go into the outdoor unit. If air is mixed with the refrigerant, the refrigerant cycle may malfunction and the unit may be damaged.
- Charging of refrigerant while the compressor is working is prohibited. Otherwise, liquid may go into the compressor. It may cause faults of the compressor.
- Use a gravimeter accurate to 0.1kg.
- If other refrigerants are mixed in the original refrigerant, a refrigerant cycle may cause malfunction or damage.
- Add accurate refrigerant quantity via calculation.  
Too much or too little refrigerant may cause problems
- Repeated on and off of the indoor units without charging refrigerant may cause faults of EEV.
- Since R410A is a mixed refrigerant, the required additional refrigerant must be charged in its liquid state. If the refrigerant is charged in its gaseous state, its composition changes and the system will not work properly.

### 3. Refrigerant charging

Follow following procedure to charge the refrigerant.

1. Open all service valves
2. Run the unit with cooling mode
3. Charging the refrigerant to gas service valve during operation.

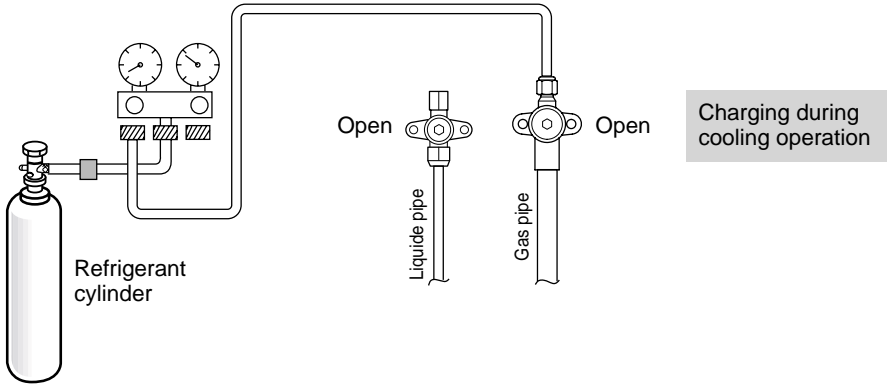

#### CAUTION

Never charge the refrigerant with service valves closed and unit stopped.

If charging is carried out with service valves closed and unit stopped, the compressor will be damaged when unit starts to run, and the unit will display ch26 error.

If trying to keep running under this condition, compressor will be broken.

# Electrical Wiring

## Electrical Wiring

### 1. Caution

- 1) Follow ordinance of your governmental organization for technical standard related to electrical equipment, wiring regulations and guidance of each electric power company.



#### WARNING

**Be sure to have authorized electrical engineers do the electric work using special circuits in accordance with regulations and this installation manual. If power supply circuit has a lack of capacity or electric work deficiency, it may cause an electric shock or fire.**

- 2) Install the Outdoor Unit communication line away from the power source wiring so that it is not affected by electric noise from the power source. (Do not run it through the same conduit.)
- 3) Be sure to provide designated grounding work to Outdoor Unit.



#### CAUTION

**Be sure to connect the Outdoor Unit to earth. Do not connect earth line to any gas pipe, water pipe, lightning rod or telephone earth line. If earth is incomplete, it may cause an electric shock.**

- 4) Give some allowance to wiring for electrical part box of Indoor and Outdoor Units, because the box is sometimes removed at the time of service work.
- 5) Never connect the main power source to terminal block of communication line. If connected, electrical parts will be burnt out.
- 6) Use 2-core shield cable for communication line. (O mark in the figure below) If communication lines of different systems are wired with the same multiplecore cable, the resultant poor transmitting and receiving will cause erroneous operations. (⊗ mark in the figure below)
- 7) Only the communication line specified should be connected to the terminal block for Outdoor Unit transmission.

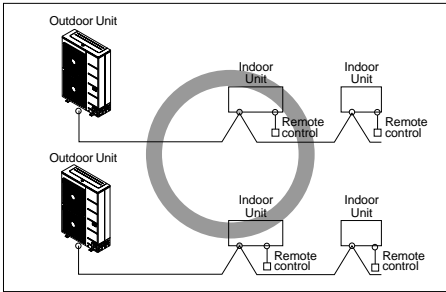

2-Core Shield Cable

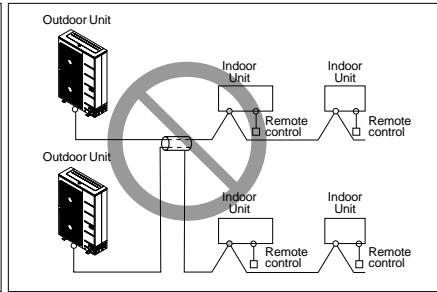

Multi-Core Cable

**⚠ CAUTION**

- This product has a reversed phase protection detector that only works when the power is turned on. If there is a power outage or the power goes on and off while the product is operating, attach a reversed phase protection circuit locally. Running the product in reversed phase may break the compressor and other parts.
- Use 2-core shield cables for communication lines. Never use them together with power cables.
- The conductive shielding layer of the cable should be grounded to the metal part of both units.
- Never use multi-core cable.
- As this unit is equipped with an inverter, installing a phase leading capacitor not only will deteriorate the power factor improvement effect, but also may cause capacitor abnormal heating. Therefore, never install a phase leading capacitor.
- Make sure the power unbalance ratio is not greater than 2%. If it is greater, the unit's lifespan will be reduced.
- Introducing a missing N-phase or a mistaken N-phase will break the equipment.

## 2. Communication and Power Lines

### 1) Communication cable

- Types : shielding wire CVVS or CPEVS
- Cross section : over 1.25mm<sup>2</sup>
- Insulation material : PVC
- Maximum allowable temperature: 60°C
- Maximum allowable line length: 300m

### 2) Remote control cable

- Types : 3-core cable

### 3) Simple central control cable

- Types : 4-core cable (Shielding wire)
- Cross section : over 0.75mm<sup>2</sup>
- Insulation material : PVC

### 4) Separation of communication and power lines

- If communication and power lines are run alongside each other then there is a strong likelihood of operational faults developing due to interference in the signal wiring caused by electrostatic and electromagnetic coupling.

The tables below indicates our recommendation as to appropriate spacing of communication and power lines where these are to be run side by side

Current capacity of power line		Spacing
100V or more	10A	300mm
	50A	500mm
	100A	1000mm
	Exceed 100A	1500mm

#### Note:

1. The figures are based on assumed length of parallel cabling up to 100m. For length in excess of 100m the figures will have to be recalculated in direct proportion to the additional length of line involved.
2. If the power supply waveform continues to exhibit some distortion the recommended spacing in the table should be increased.
  - If the lines are laid inside conduits then the following point must also be taken into account when grouping various lines together for introduction into the conduits
  - Power lines(including power supply to air conditioner) and signal lines must not be laid inside the same
  - In the same way, when grouping the lines power and signal lines should not be bunched together.



#### CAUTION

- **If apparatus is not properly earthed then there is always a risk of electric shocks, the earthing of the apparatus must be carried out by a qualified person.**
- **Use a power wire pipe for the power wiring.**

### Wiring of Main Power Supply and Equipment Capacity

Outdoor unit (1Ø, 220~240V, 50Hz / 1Ø, 220V, 60Hz), Indoor unit (1Ø, 220V, 50Hz/60Hz)

1. Separate power supply lines for the indoor units from outdoor unit.
2. Bear in mind ambient conditions (ambient temperature, direct sunlight, rain water, etc.) when proceeding with the wiring and connections.
3. The wire size is the minimum value for metal conduit wiring. The power cord size should be 1 rank thicker taking into account the line voltage drops. Make sure the power-supply voltage does not drop more than 10%.
4. Specific wiring requirements should adhere to the wiring regulations of the region.
5. Power supply cords of parts of appliances for outdoor use should not be lighter than polychloroprene sheathed flexible cord.
6. Don't install an individual switch or electrical outlet to disconnect each of indoor unit separately from the power supply.



#### WARNING

- Follow ordinance of your governmental organization for technical standard related to electrical equipment, wiring regulations and guidance of each electric power company.
- Make sure to use specified wires for connections so that no external force is imparted to terminal connections. If connections are not fixed firmly, it may cause heating or fire.
- Make sure to use the appropriate type of overcurrent protection switch. Note that generated overcurrent may include some amount of direct current.



#### CAUTION

- Some installation site may require attachment of an earth leakage breaker. If no earth leakage breaker is installed, it may cause an electric shock.
- Do not use anything other than breaker and fuse with correct capacity. Using fuse and wire or copper wire with too large capacity may cause a malfunction of unit or fire.

## ◆ Precautions when laying power wiring

Use round pressure terminals for connections to the power terminal block.

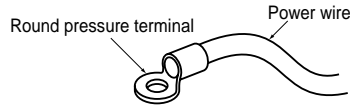

When none are available, follow the instructions below.

- Do not connect wiring of different thicknesses to the power terminal block. (Slack in the power wiring may cause abnormal heat.)
- When connecting wiring which is the same thickness, do as shown in the figure below.

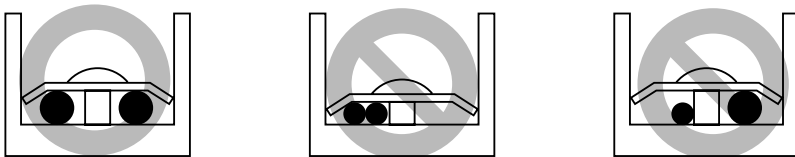

- For wiring, use the designated power wire and connect firmly, then secure to prevent outside pressure being exerted on the terminal block.
- Use an appropriate screwdriver for tightening the terminal screws. A screwdriver with a small head will strip the head and make proper tightening impossible.
- Over-tightening the terminal screws may break them.

## ◆ How to connect wiring

1. Connect power supply wire to terminal block of control case using clamps on the supporter and control case as shown figure right.
2. Connect communication wire to main PCB terminal block using clamps on the supporter and main PCB case as shown figure right.

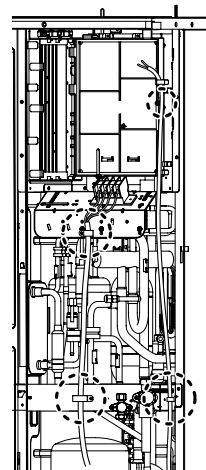

Example Connection of Communication Cable

1. 50Hz

■ 1 Outdoor Unit - 1Ø, 220~240V

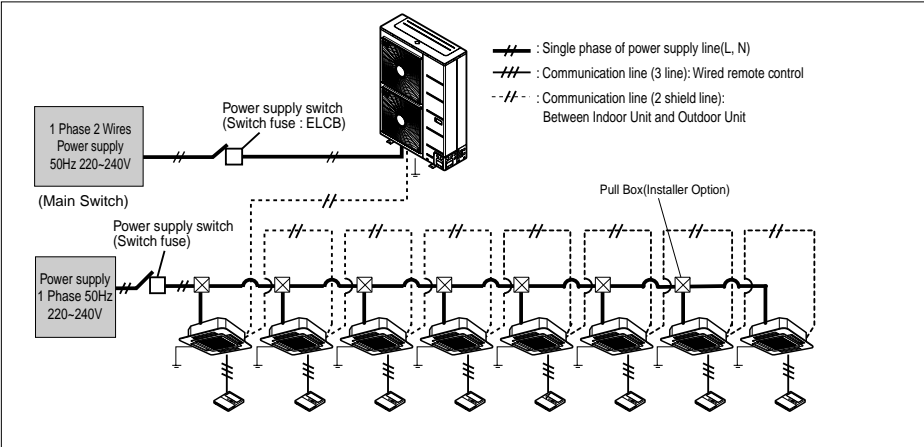

**! WARNING**

- Indoor Unit ground Lines are required for preventing electrical shock accident during current leakage, communication disorder by noise effect and motor current leakage (without connection to pipe).
- Don't install an individual switch or electrical outlet to disconnect each of indoor unit separately from the power supply.
- Install the main switch that can interrupt all the power sources in an integrated manner because this system consists of the equipment utilizing the multiple power sources.
- If there exists the possibility of reversed phase, lose phase, momentary blackout or the power goes on and off while the product is operating, attach a reversed phase protection circuit locally.  
Running the product in reversed phase may break the compressor and other parts.

Between Indoor and Outdoor unit

SODU	IDU	INTERNET	DRY1	DRY2	GND	12V
B	A	B	A	B	A	

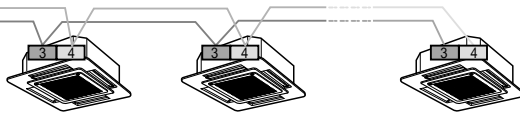

The GND terminal is a 'L' terminal for the central controller, not Ground Line

## 2. 60Hz

### ■ 1 Outdoor Unit - 1Ø, 220V

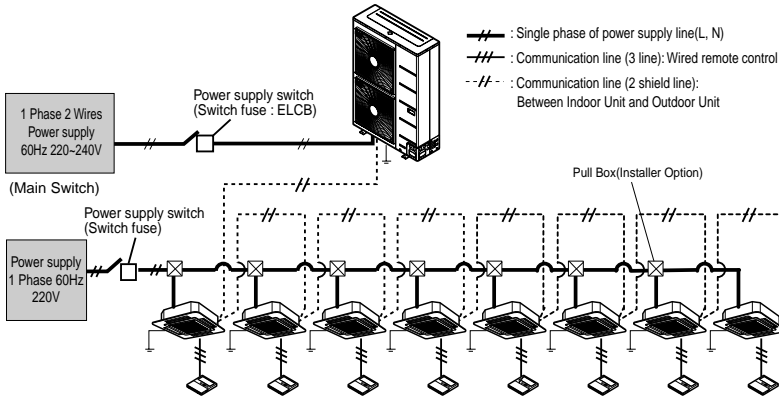

### **⚠ WARNING**

- Indoor Unit ground Lines are required for preventing electrical shock accident during current leakage, communication disorder by noise effect and motor current leakage (without connection to pipe).
- Don't install an individual switch or electrical outlet to disconnect each of indoor unit separately from the power supply.
- Install the main switch that can interrupt all the power sources in an integrated manner because this system consists of the equipment utilizing the multiple power sources.
- If there exists the possibility of reversed phase, lose phase, momentary blackout or the power goes on and off while the product is operating, attach a reversed phase protection circuit locally. Running the product in reversed phase may break the compressor and other parts.

Between Indoor and Outdoor unit

SODU	IDU	INTERNET	DRY1	DRY2	GND	12V
B	A	B	A			

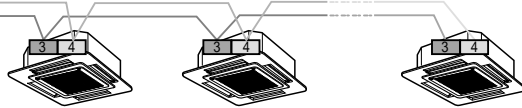

The GND terminal is a '-' terminal for the central controller, not Ground Line

### ■ Example Connection of Communication Cable

#### [BUS type]

- Connection of communication cable must be installed like below figure between indoor unit to outdoor unit.

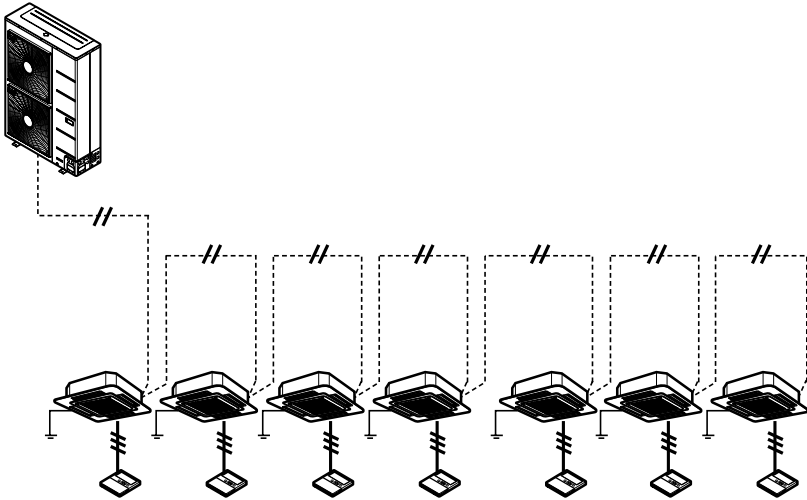

#### [STAR type]

- Abnormal operation can be caused by communication defect, when connection of communication cable is installed like below figure(STAR type).

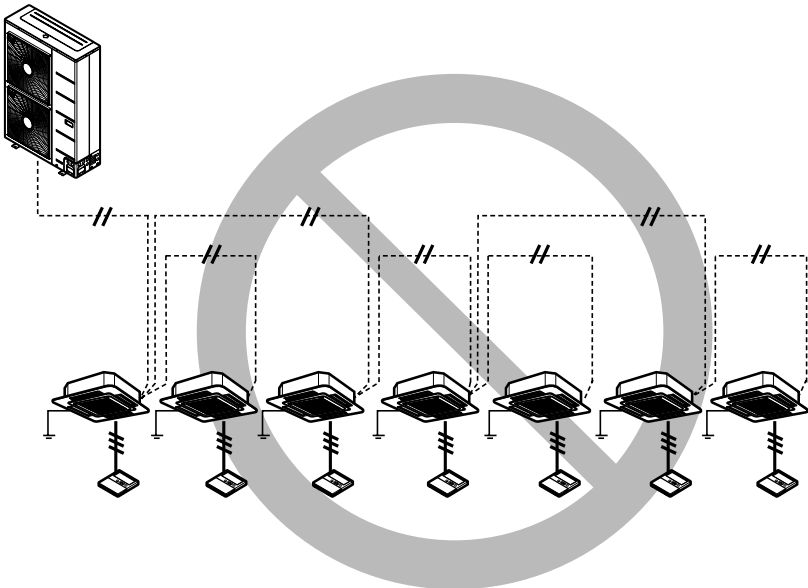

## DIP Switch Setting

### ■ Location of setting Switch

#### Main PCB

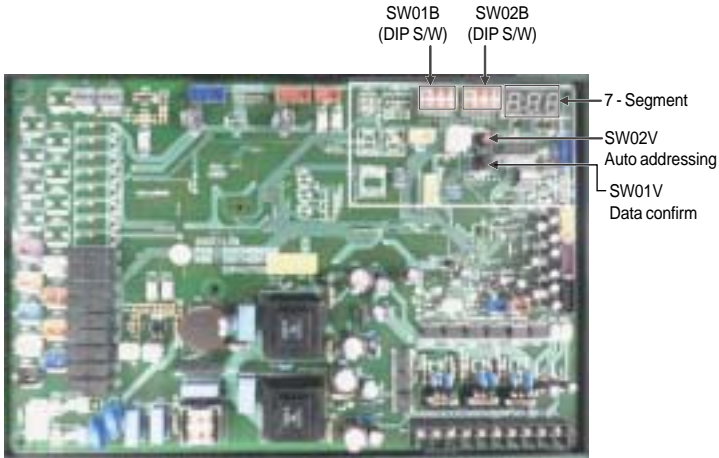

### ■ Checking according to dip switch setting

1. You can check the setting values of the outdoor unit from the 7 segment LED.  
The dip switch setting should be changed when the power is OFF.
2. It checks whether the input is properly performed without the bad contact of the dip switch or not

### ■ Checking the setting of the unit

The number is sequentially appeared at the 7 segment in 5 seconds after applying the power. This number represents the setting condition. & model code → total capacity → 2 → 25 → model type

- ① 1 ~255 : model code
- ② 4~6HP : HP numbers
- ③ No display : cooling only                      2 : heat pump
- ④ 25 : normal
- ⑤ 120 : Model type(Mini, 1Ø 220V)      121 : Model type(Mini, 3Ø 380V)

Example) 5HP, R410A

121 → 5 → 2 → 25 → 120

①   ②   ③   ④   ⑤



### CAUTION

Product may not properly operate if the relevant DIP switch is not properly setup.







### Model Code

Model Code	Unit (HP)	Ref.
120	4	R410A
121	5	
122	6	

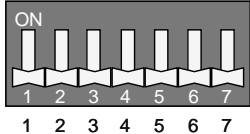

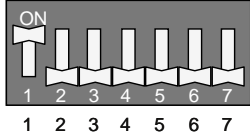
■ Setting the DIP switch

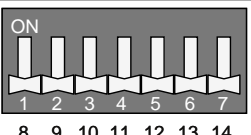
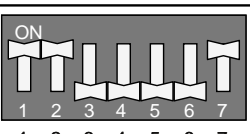
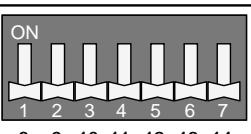
- Set the dip switch with the power turned off. If you change the setting when the power is on, the changed setting is not applied immediately. The changed setting is applied at the moment that the power is on.
- Instant indoor unit checking, data display mode, and forced oil collecting operation are used when the units are running. If you don't have to use those functions after using them, restore the dip switch setting.

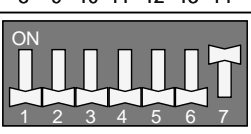
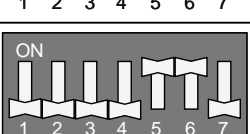
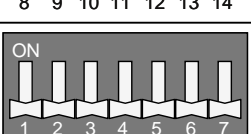
1. Settings of outdoor unit

Function	SW01B Setting	SW02B Setting	Remarks
Standard			Power reset is necessary Factory Setting
Short Pipe Length			Power reset is necessary -Cooling Target Pressure : Standard+39 -Heating Target Pressure : Standard-131
Long Pipe Length			Power reset is necessary -Cooling Target Pressure : Standard-39 -Heating Target Pressure : Standard+131
Refrigerant Auto Charging			Dip SW setting + Black button (SW01V)
Refrigerant Checking			Dip SW setting + Black button (SW01V)
Cool/Heat Selector			Power reset is necessary Optional device

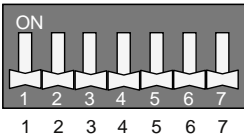
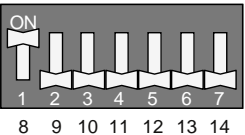
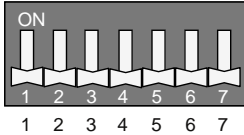
\* In long piping mode, power consumption will be increased.

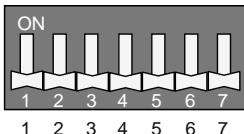
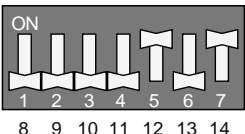
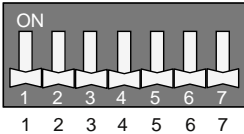
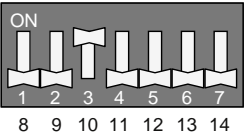
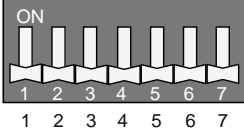
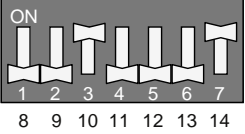
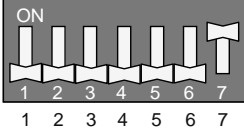
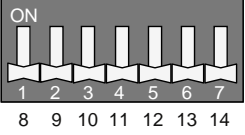
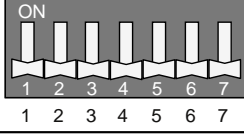
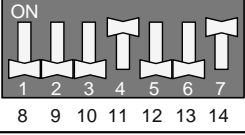
Function	SW01B Setting	SW02B Setting	Remarks
Snow			Used when snow piles up on the ODU Fan. Fan operates periodically.
Forced Defrosting			Accelerates defrost operation
Night Silent Operation			Power reset is necessary Fan RPM down on night time
Pump Down			Power reset is necessary All the refrigerant flows back into the ODU
Pump Out			Power reset is necessary Refrigerant from the broken ODU flows into the remaining units Refer Service manual
Forced Oil Return			Dip switch + Black button(SW01V)
Vacuum Mode			During Vacuuming, Valves & EEV should be opened Refer Service manual

**Note:** Oil collecting operation is default function which operates after every six hours.

- To enable forced operation of this function change the dip switch setting. And after using, make sure to restore the dip switch setting.

## Automatic Addressing

• **The address of indoor units would be set by auto addressing**

- 1) Wait for 3 minutes after applying power supply (outdoor unit, indoor unit).
- 2) Press the switch of the outdoor unit (SW02V) for 5 seconds.
- 3) A "88" is indicated on 7-segment LED of the outdoor unit PCB.
- 4) For completing addressing, 2-7 minutes are required depending on numbers of indoor unit connection set.
- 5) Numbers of indoor unit connection set whose addressing is completed are indicated for 30seconds on 7-segment LED of the outdoor unit PCB.
- 6) After completing addressing, address of each indoor unit is indicated on the wired remote control display window. (CH01, CH02, CH03, ..... CH06: Indicated as numbers of indoor unit connection set.)

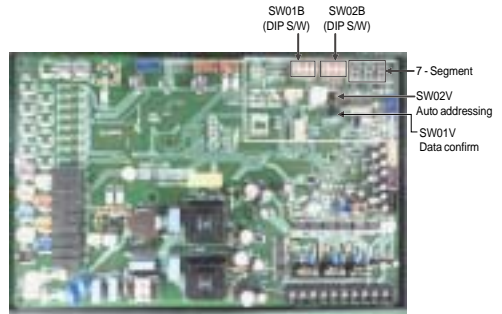

### CAUTION

**In replacement of the indoor unit PCB, always perform auto address setting again.**

- If power supply is not applied to the indoor unit, operation error occurs.
- Auto addressing is only possible on the main PCB
- Auto addressing has to be performed after 3 minutes to improve communication.

## ◆ The Procedure of Automatic Addressing

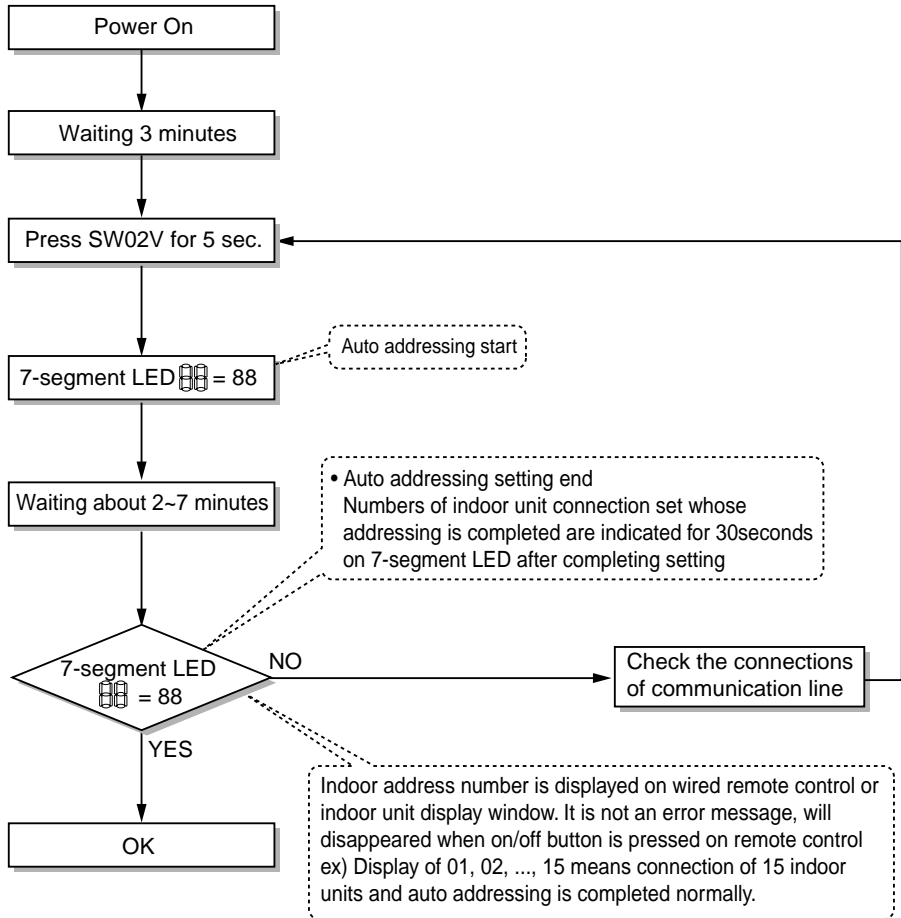

## Group Number Setting

### ■ Group Number setting for Indoor Units

- ① Confirm the power of whole system(Indoor Unit, Outdoor Unit) is OFF, otherwise turn off.
- ② The communication lines connected to INTERNET terminal should be connected to central control of Outdoor unit with care for their polarity( A → A, B → B )
- ③ Turn the whole system on.
- ④ Set the group and Indoor Unit number with a wired remote control.
- ⑤ To control several sets of Indoor Units into a group, set the group ID from 0 to F for this purpose.

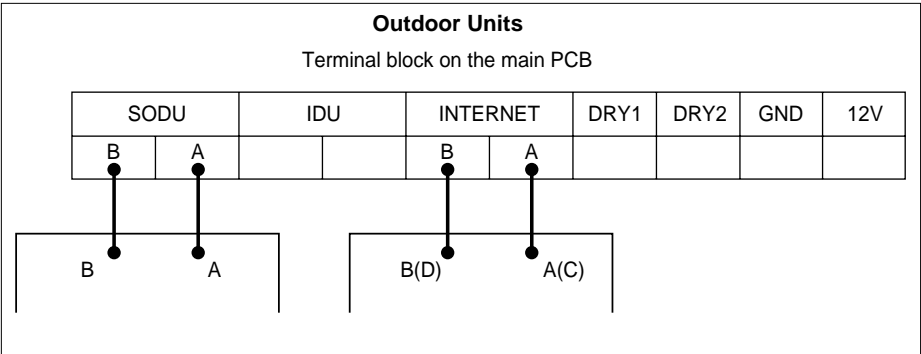

Group recognizing the simple central controller	
No.0 group (00~0F)	
No.1 group (10~1F)	
No.2 group (20~2F)	
No.3 group (30~3F)	
No.4 group (40~4F)	
No.5 group (50~5F)	
No.6 group (60~6F)	
No.7 group (70~7F)	
No.8 group (80~8F)	
No.9 group (90~9F)	
No. A group (A0~AF)	
No. B group (B0~BF)	
No. C group (C0~CF)	
No. D group (D0~DF)	
No. E group (E0~EF)	
No. F group (F0~FF)	

**Cool/Heat Selector Installation and Connection(Heat pump only)**

**■ Using Cool/Heat Selector Installation and Connection**

- Connect wires as below figure at the hole of backside of Outdoor Unit Dry Contact.
- Insert the wire in the connection hole pushing the "Push" button.
- Maximum communication line length for dry contact : 200m.

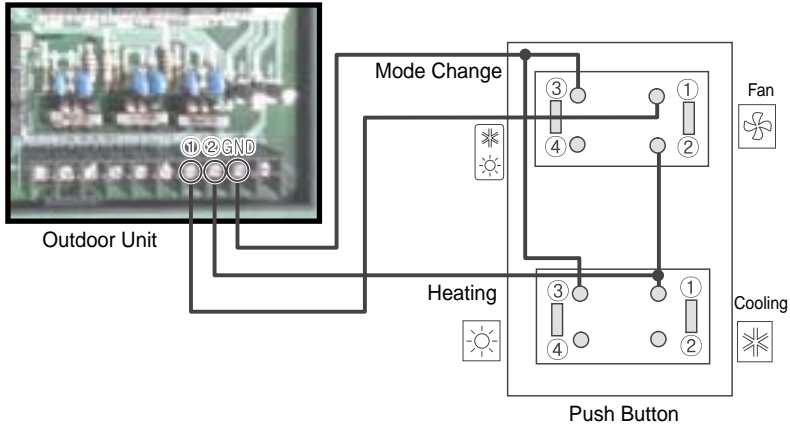

**■ Without Cool/Heat Selector Installation and Connection**

In case, try to set mode without Cool/Heat Selector and try to use other switch except from LG Outdoor Cool/Heat Selector in field.

Connect signal terminal block as below figure and description.

**- How to set mode without Cool/Heat Selector**

- Cooling Mode Setting

- ① → GND Connection
- ② → Off (Open)

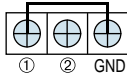

- Heating Mode Setting

- ① → GND Connection
- ② → GND Connection

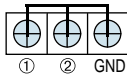

- Fan Mode Setting

- ① → Off (Open)
- ② → GND Connection

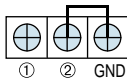

# Test Run

## Checks before Test Run

1	Check to see whether there is any refrigerant leakage, and slack of power or communication cable.
2	<p>Confirm that 500 V megger shows 2 MΩ or more between power supply terminal block and ground. Do not operate in the case of 2 MΩ or less.</p> <p>NOTE: Never carry out megaohm check over terminal control board. Otherwise the control board would be broken.</p> <p>Immediately after mounting the unit or after leaving it turned off for an extended length of time, the resistance of the insulation between the power supply terminal board and the ground may decrease to approx. 2 MΩ as a result of refrigerant accumulating in the internal compressor. If the insulation resistance is less than 2 MΩ, turning on the main power supply and energizing the crankcase heater for more than 6 hours will cause the refrigerant to evaporate, increasing the insulation resistance.</p>
3	<p>Check if high/low pressure common pipe, liquid pipe and gas pipe valves are fully opened.</p> <p>NOTE: Be sure to tighten caps.</p>
4	<p>Check if there are any problems in automatic addressing or not:</p> <p>Check and confirm that there are no error messages in the display of indoor units or remote controls and LED in outdoor units.</p>



### CAUTION

#### When cutting main power of the Multi V

- Always apply main power of the outdoor unit during use of product (cooling season/heating season).
- Always apply power 6 hours in advance to heat the crank case heater where performing test run after installation of product. It may result in burning out of the compressor if not preheating the crank case with the electrical heater for more than 6 hours.(In case of the outdoor temperature below 10°C)

## How to cope with Test Run Abnormality

### The phenomena from master component failure

Component	Phenomenon	Cause	Check method and Trouble shooting
Compressor	Not operating	Motor insulation broken	Check resistance between terminals and chassis
		Strainer clogged	Change strainer
		Oil leakage	Check oil amount after opening oil port
	Stop during running	Motor insulation failure	Check resistance between terminals and chassis
	Abnormal noise during running	U-V-W misconnection	Check compressor U-V-W connection
Outdoor fan	High pressure error at cooling	Motor failure, bad ventilation around outdoor heat exchanger	Check the outdoor fan operation after being turned the outdoor units off for some time. Remove obstacles around the outdoor units
Outdoor EEV	Heating failure, frequent defrosting	Bad connector contact	Check connector
	No operating sound at applying power	Coil failure	Check resistance between terminals
	Heating failure, frozen outdoor heat exchanger part	EEV clogged	Service necessary
	Low pressure error or discharge temperature error	EEV clogged	Service necessary

When system fault occurs, the error code is displayed at indoor unit display or remote control display, the trouble shooting guide is in the service manual

## Caution for Assembling Outdoor Panels after Test Run

When assemble the outdoor panels after test run, make sure that screws of top panel are assembled as shown figure. If screws are not assembled, it allows rain come into control box causing defect of unit.

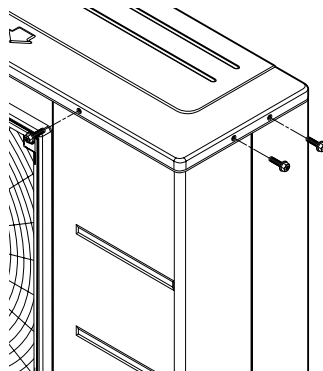

# Sensor Checking Function

Note 1)

Sensor checking function judges whether the current temperature of indoor and outdoor unit sensors is right or not. It checks 3 indoor temperature sensors, 9 outdoor temperature sensors, 2 outdoor pressure sensors. It is used for judging sensor abnormality. *Note 2)*

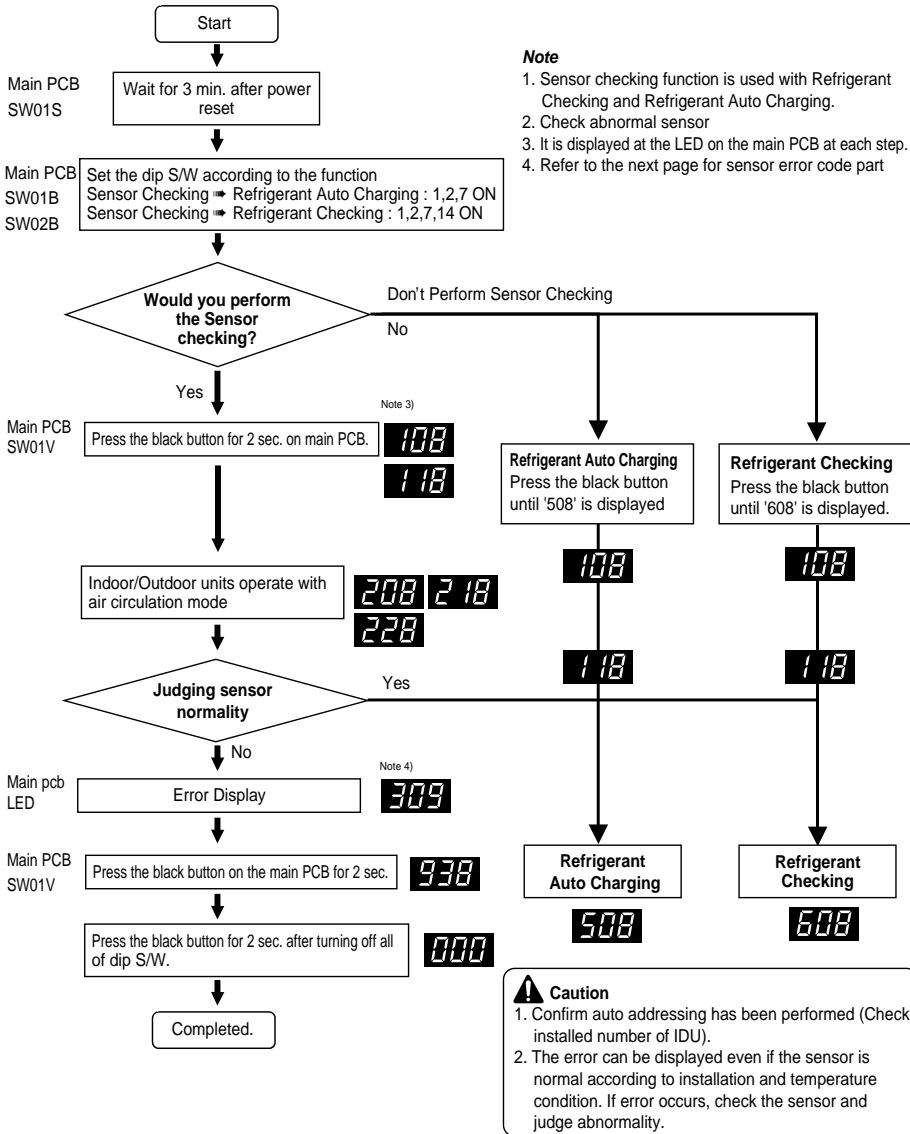

## Sensor Check Error Code Display

In case error occurs during sensor checking process, error display is as shown below.  
Following contents are displayed one after the other on the main PCB of outdoor unit.

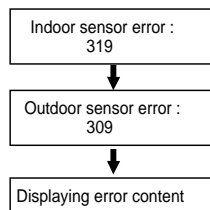

### Displaying error content

#### ■ Indoor unit error display

- 1<sup>st</sup> and 2<sup>nd</sup> number represents indoor unit number.  
Indoor unit number follows auto addressing number.
2. Last number represents sensor.

1	Pipe inlet temperature sensor
2	Pipe outlet temperature sensor
3	Air temperature sensor

※ Indoor unit number follows Auto addressing number.

#### ■ Displaying outdoor unit error

1. 1<sup>st</sup> and 2<sup>nd</sup> number represents error content(code).
2. Last number represents outdoor unit number.

1	Outdoor Air Temperature
2	Heat Exchanger 1
3	Inverter Compressor Discharge Temperature
4	Suction Temperature
5	Liquid Pipe Temperature
6	SC pipe in
7	SC pipe out
8	High Pressure Sensor
9	Low Pressure Sensor

ex) Indoor unit No. 2 pipe inlet temperature sensor error



ex) Outdoor unit liquid pipe temperature sensor error



ex) Indoor unit No.2 pipe inlet temperature sensor error and outdoor unitsuction temperature sensor error

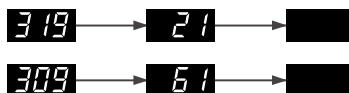

### ⚠ Caution

1. Up to 5 number of errors is displayed continuously and repeatedly. In case 5 number of errors occurs, again perform sensor checking after solving errors.
2. IDU in which error occurred operates fan mode.

## Refrigerant Auto Charging Function

This function charges appropriate amount of refrigerant automatically through cycle operation. It can be used when refrigerant amount isn't certain because of SVC and leakage.

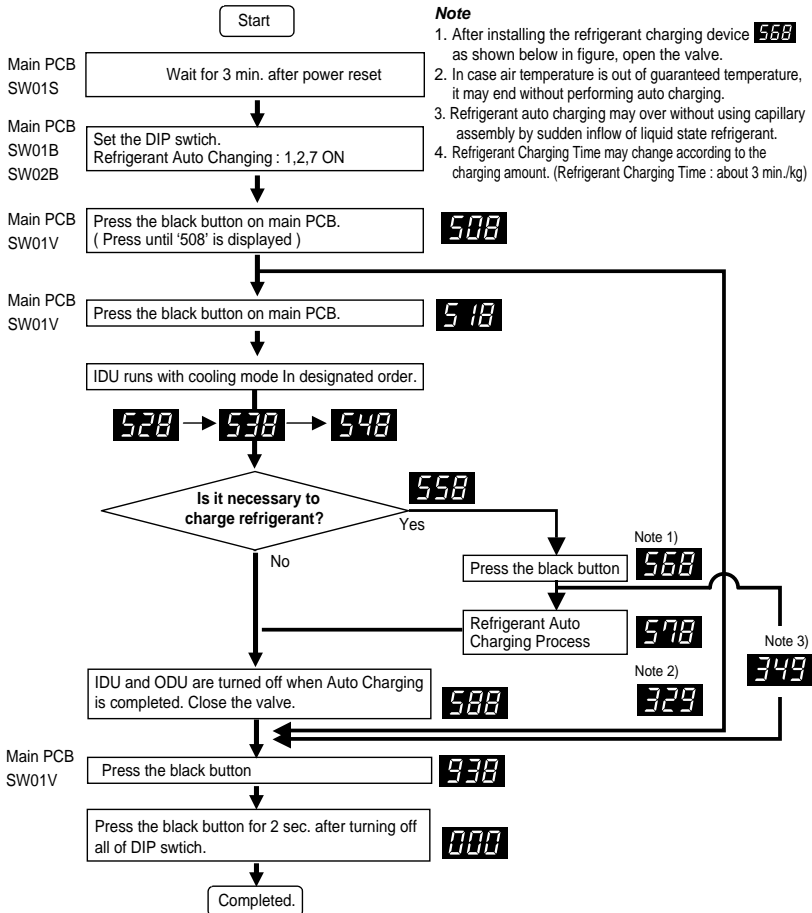

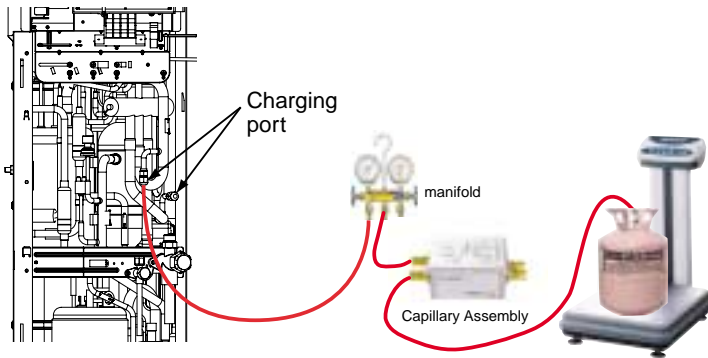

### Procedure

1. Arrange manifold, capillary assembly, refrigerant vessel and scale
2. Connect manifold to the gas pipe service valve of ODU as shown in the figure.
3. Connect manifold and Capillary tube.  
Use designated capillary assembly only.  
If designated capillary assembly isn't used, the system may get damaged.
4. Connect capillary and refrigerant vessel.
5. Purge hose and manifold.
6. After **568** is displayed, open the valve and charge the refrigerant

### ■ Error contents about auto refrigerant charging function

1. **329** : Temperature Range Error (In case that IDU or ODU is out of range)
2. **339** : Low Pressure Descent Error (In case the system runs at low pressure limit for over 10 minutes)
3. **349** : Judging rapid refrigerant inflow ( In case the liquid refrigerant flows in because of not using designated Capillary Assembly)
4. **359** : Instability Error( In case the high/low pressure target doesn't get satisfied for some time after the starting operation)

### ⚠ CAUTION

1. Guaranteed temperature range (Error will occur if temperature is out of range)  
IDU : 20~32°C  
ODU : 0~43°C
2. For refrigerant charging, use designated device only. (Capillary Assem Set)
3. Set the IDU wired remote controller temperature sensing mode as IDU
4. Be careful that IDU should not be thermo off.

## Refrigerant Checking Function

This function charges appropriate amount of refrigerant automatically through cycle operation.  
 This function judges refrigerant leakage and overcharging.

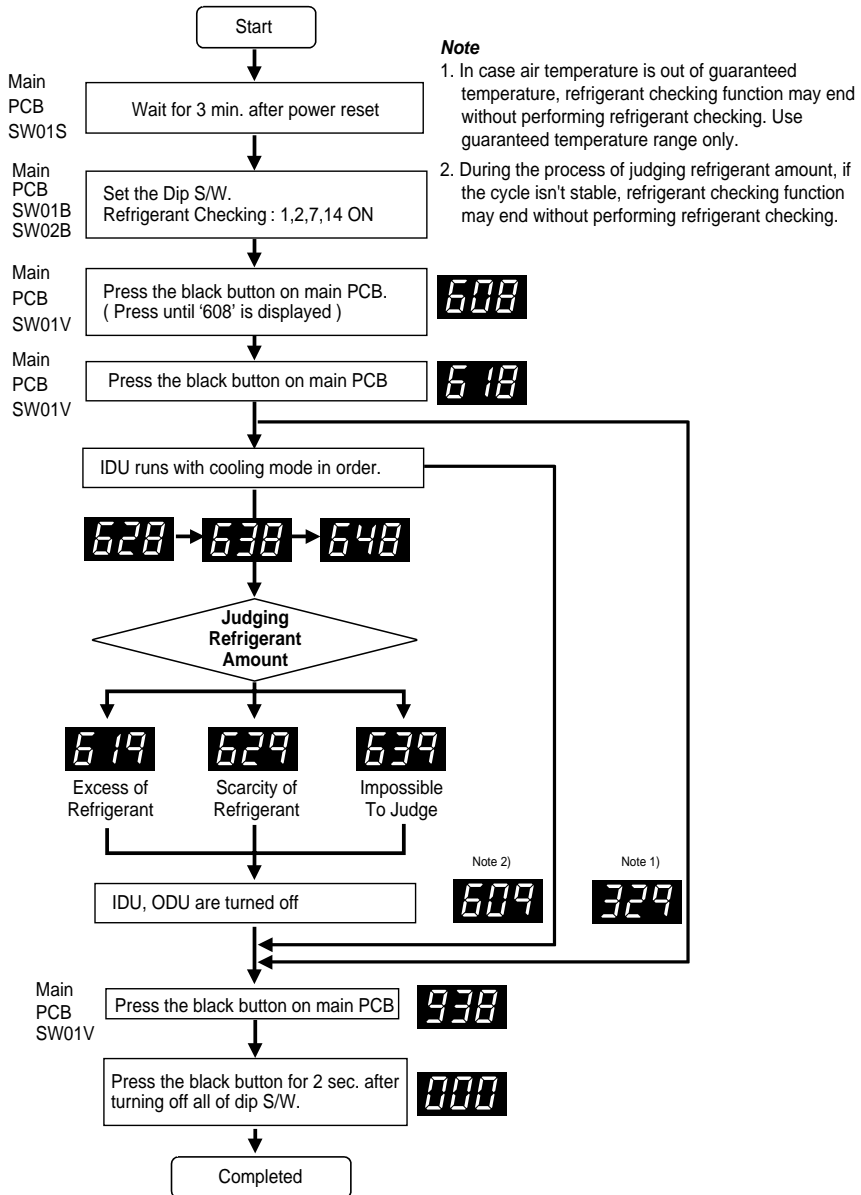

 **CAUTION**

1. **Guaranteed Temperature range**(Error occurs out of guaranteed temperature range)  
IDU : 20~32°C  
ODU : 10~38°C
2. Set IDU wired remote controller temperature sensor setting as 'IDU'.
3. Make certain that IDU doesn't run with thermo off mode during operation.

**[ Error contents about auto refrigerant charging function ]**

1. **329** : Temperature Range Error (In case that IDU or ODU is out of range)
2. **609** : System Unstable Error (In case, After 45 min operating the system, it does not be stable)

**How to cope with Result of Refrigerant Checking**

1. If the temperature is not in guaranteed Temperature range, the system will not execute Refrigerant checking and the system will be OFF.
2. **Excess of Refrigerant(619)**  
After remove the 20% of calculated total refrigerant, recharge the refrigerant by using Refrigerant Auto Charging Function.
3. **Scarcity of Refrigerant(629)**  
Charge the refrigerant by using Refrigerant Auto Charging Function.
4. **Impossible to Judge(639)**  
If the system is not in order, check the other problem except refrigerant.

## Night Silent Operation

In cooling mode, this function makes the ODU fan operate at low RPM to reduce the fan noise of ODU at night which has low cooling load.

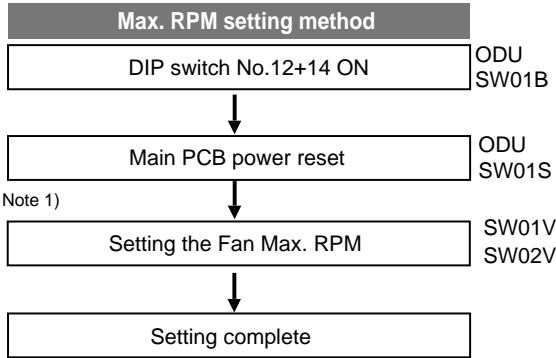

### Caution

1. Request installer to set the function during installation.
2. In case the function is not used, set the DIP switch OFF and reset the power.
3. If ODU RPM changes, cooling capacity may go down.

### [Note]

#### 1. Select appropriate RPM referencing noise table.

Step	Setting		Fan Max RPM	Judgment (hr)	Operation (hr)
	Black button	Red button			
1	1 time	1 time	420	8	9
2	2 times	1 time	370	8	9
3	3 times	1 time	320	8	9

## Self-Diagnosis Function

### Error Indicator

- This function indicates types of failure in self-diagnosis and occurrence of failure for air condition.
- Error mark is displayed on display window of indoor units and wired remote controller, and 7-segment LED of outdoor unit control board as shown in the table.
- If more than two troubles occur simultaneously, lower number of error code is first displayed.
- After error occurrence, if error is released, error LED is also released simultaneously.

### Error Display

1st,2nd LED of 7-segment indicates error number, 3rd LED indicates unit number.

	Display			Title	Cause of Error
Indoor unit related error	0	1	-	Air temperature sensor of indoor unit	Air temperature sensor of indoor unit is open or short
	0	2	-	Inlet pipe temperature sensor of indoor unit	Inlet pipe temperature sensor of indoor unit is open or short
	0	3	-	Communication error : wired remote controller ↔ indoor unit	Failing to receive wired remote controller signal in indoor unit PCB
	0	4	-	Drain pump	Malfunction of drain pump
	0	5	-	Communication error : outdoor unit ↔ indoor unit	Failing to receive outdoor unit signal in indoor unit PCB
	0	6	-	Outlet pipe temperature sensor of indoor unit	Outlet pipe temperature sensor of indoor unit is open or short
	0	7	-	Different operation mode	Operation mode between indoor unit and outdoor unit is different
	0	9	-	Indoor EEPROM Error	In case when the serial number marked on EEPROM of Indoor unit is 0 or FFFFFF
	1	0	-	Poor fan motor operation	Disconnecting the fan motor connector/Failure of indoor fan motor lock
	1	1	-	Communication error: indoor unit → main PCB of outdoor.	PCB damage
Outdoor unit related error	2	1	1	Outdoor Unit Inverter Compressor IPM Fault	Outdoor Unit Inverter Compressor Drive IPM Fault
	2	2	1	Inverter Board Input Over Current(RMS) of Outdoor Unit	Outdoor Unit Inverter Board Input Current excess (RMS)
	2	3	1	Outdoor Unit Inverter Compressor DC link Low Voltage	DC charging is not performed at outdoor unit after starting relay turn on.
	2	4	1	Outdoor Unit High Pressure Switch	System is turned off by outdoor unit high pressure switch.
	2	5	1	Outdoor Unit Input Voltage High/Low Voltage	Outdoor Unit input voltage is out of range.
	2	6	1	Outdoor Unit Inverter Compressor Start Failure	The First Start Failure by Outdoor Unit Inverter Compressor Abnormality
	2	7	1	PSC/PFC Fault error	When over current flows instantly at PSC/PFC
	2	8	1	Outdoor Unit Inverter DC link High Voltage	System is turned off by outdoor unit DC Voltage Over Charging
	2	9	1	Outdoor Unit Inverter Compressor Over Current	Outdoor Unit Inverter Compressor Fault OR Drive Fault

Test Run

				Display	Title	Cause of Error
Outdoor unit related error	3	2	1	Outdoor Unit Inverter Compressor High Discharge Temperature	System is turned off by outdoor unit Inverter Compressor High Discharge Temperature	
	3	4	1	High Pressure of Outdoor Unit	System is turned off by excessive increase of high pressure of outdoor unit	
	3	5	1	Low Pressure of Outdoor Unit	System is turned off by excessive decrease of low pressure of outdoor unit	
	3	6	1	Low pressure ratio	Pressure ratio is under limit	
	3	9	1	PFC communication error : Inv. Micom ↔ Converter Micom	Failing to communication between inverter Micom and converter Micom	
	4	0	1	Outdoor Unit Inverter Compressor CT Sensor Fault	Outdoor Unit Inverter Compressor CT Sensor open or short	
	4	1	1	Outdoor Unit Inverter Compressor Discharge Temperature Sensor Fault	Outdoor Unit Inverter Compressor Discharge Temperature Sensor open or short	
	4	2	1	Outdoor Unit Low Pressure Sensor Fault	Outdoor Unit Low Pressure Sensor open or short	
	4	3	1	Outdoor Unit High Pressure Sensor Fault	Outdoor Unit High Pressure Sensor open or short	
	4	4	1	Outdoor Unit Air Temperature Sensor Fault	Outdoor Unit Air Temperature Sensor open or short	
	4	5	1	Outdoor unit Heat Exchanger Temperature Sensor Fault	Outdoor Unit Heat Exchanger Temperature Sensor open or short	
	4	6	1	Outdoor Unit Suction Temperature Sensor Fault	Outdoor Unit Suction Temperature Sensor open or short	
	5	0	1	Omitting connection of R power of Outdoor unit → CH 50 ※ Note - Omitting connection of S power of Outdoor unit → CH 23 - Omitting connection of T power of Outdoor units → Main PCB power OFF	Omitting connection of Outdoor unit	
	5	1	1	Excessive capacity of indoor units	Excessive connection of indoor units compared to capacity of outdoor unit	
	5	2	1	Communication error : inverter PCB → Main PCB	Failing to receive inverter signal at main PCB of Outdoor Unit	
	5	3	1	Communication error : indoor unit → main PCB of outdoor unit	Failing to receive indoor unit signal at main PCB of outdoor Unit.	
	5	4	1	Reverse connection of R, S, T power of Outdoor unit	Reverse connection or omitting connection of R, S, T power of Outdoor unit	
	6	0	1	Inverter PCB EEPROM error	Check EEPROM checksum error when resetting power	
	6	2	1	Heat sink temperature high error	When Heat sink temperature is above setting value	
	6	5	1	Heat sink temperature sensor error	When the temperature sensor value is too high error	
	6	7	1	Fan lock	Fan operation fail at starting or during operation	
	7	3	1	Instant Over Current(Peak) of Outdoor Unit PFC	Instant Over Current(Peak) of Outdoor Unit PFC	
	8	6	1	Outdoor Unit Main PCB EEPROM Error	Communication Fail Between Outdoor Unit Fan MICOM and EEPROM or omitting EEPROM	
	1	1	3	1	Outdoor Unit Liquid pipe Temperature Sensor Error	Liquid pipe temperature sensor of outdoor unit is open or short
	1	1	4	1	Outdoor Unit Subcooling Inlet Temperature Sensor Error	Outdoor Unit Subcooling Inlet Temperature Sensor open or short
	1	1	5	1	Outdoor Unit Subcooling Outlet Temperature Sensor Error	Outdoor Unit Subcooling Outlet Temperature Sensor open or short
1	5	1	1	Failure of operation mode conversion at Outdoor Unit	Pressure unbalance between outdoor units	

# Caution for Refrigerant Leak

The installer and system specialist shall secure safety against leakage according to local regulations or standards. The following standards may be applicable if local regulations are not available.

## Introduction

Though the R410A refrigerant is harmless and incombustible itself, the room to equip the air conditioner should be large enough to such an extent that the refrigerant gas will not exceed the limiting concentration even if the refrigerant gas leaks in the room.

### Limiting concentration

Limiting concentration is the limit of Freon gas concentration where immediate measures can be taken without hurting human body when refrigerant leaks in the air. The limiting concentration shall be described in the unit of  $\text{kg/m}^3$  (Freon gas weight per unit air volume) for facilitating calculation.

**Limiting concentration:  $0.44\text{kg/m}^3$ (R410A)**

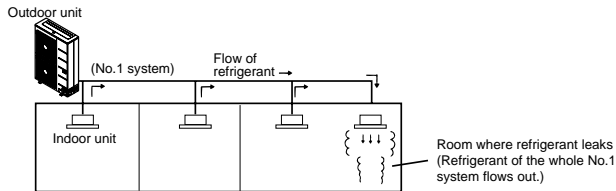

## Checking procedure of limiting concentration

Check limiting concentration along following steps and take appropriate measure depending on the situation.

### Calculate amount of all the replenished refrigerant (kg) per each refrigerant system.

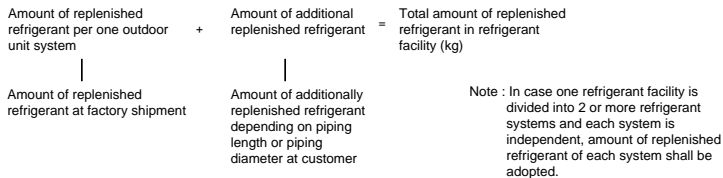

### Calculate minimum room capacity

Calculate room capacity by regarding a portion as one room or the smaller room.

(1) Without partition

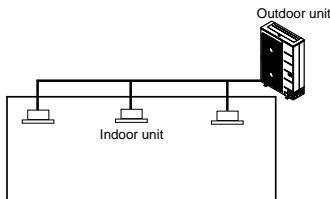

(2) With partition and with opening which serve as passage of air to adjoining room

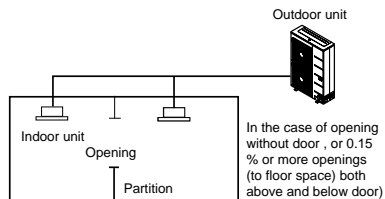

*Caution For Refrigerant Leak*

(3) With partition and without opening which serve as passage of air to adjoining room

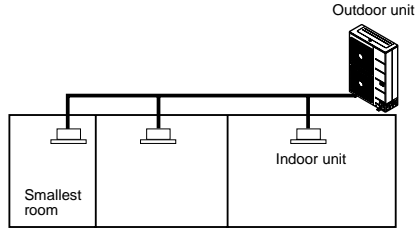

**■ Calculate refrigerant concentration**

$$\frac{\text{Total amount of replenished refrigerant in refrigerant facility (kg)}}{\text{Capacity of smallest room where indoor unit is installed (m}^3\text{)}} \leq \text{Refrigerant concentration (kg/m}^3\text{)} \quad \text{(R410A)}$$

In case the result of calculation exceeds the limiting concentration, perform the same calculations by shifting to the second smallest, and the third smallest rooms until at last the result is below the limiting concentration.

**■ In case the concentration exceeds the limit**

When the concentration exceeds the limit, change original plan or take one of the countermeasures shown below:

**• Countermeasure 1**

Provide opening for ventilation.

Provide 0.15% or more opening to floor space both above and below door, or provide opening without door.

**• Countermeasure 2**

Provide gas leak alarm linked with mechanical ventilator.

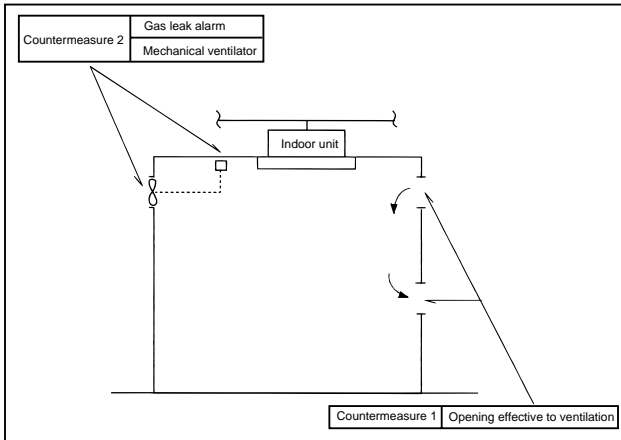

Pay special attention to the place, such as a basement, etc. where refrigerant can be present, since refrigerant is heavier than air.

# Installation Guide at the Seaside

## ⚠ CAUTION

1. Air conditioners should not be installed in areas where corrosive gases, such as acid or alkaline gas, are produced.
2. Do not install the product where it could be exposed to sea wind (salty wind) directly. It can result corrosion on the product. Corrosion, particularly on the condenser and evaporator fins, could cause product malfunction or inefficient performance.
3. If outdoor unit is installed close to the seaside, it should avoid direct exposure to the sea wind. Otherwise it needs additional anticorrosion treatment on the heat exchanger.

## Selecting the location(Outdoor Unit)

- 1) If the outdoor unit is to be installed close to the seaside, direct exposure to the sea wind should be avoided. Install the outdoor unit on the opposite side of the sea wind direction.

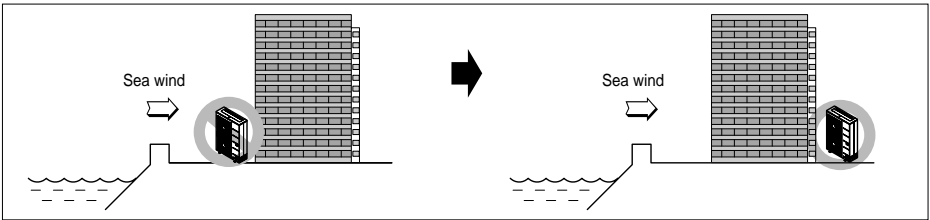

- 2) In case, to install the outdoor unit on the seaside, set up a windbreak not to be exposed to the sea wind.

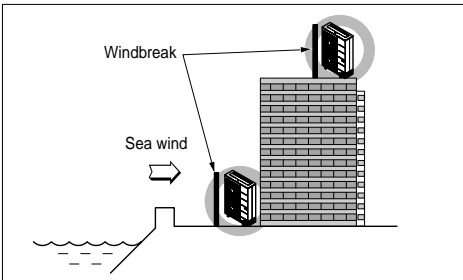

- It should be strong enough like concrete to prevent the sea wind from the sea.
- The height and width should be more than 150% of the outdoor unit.
- It should be keep more than 70 cm of space between outdoor unit and the windbreak for easy air flow.

- 3) Select a well-drained place.

1. If you can't meet above guide line in the seaside installation, please contact LG Electronics for the additional anticorrosion treatment.
2. Periodic ( more than once/year ) cleaning of the dust or salt particles stuck on the heat exchanger by using water

---

**The below Installation guide is limited applicable only for model  
ARUN60GS2**

**Installation Guide for EN 61000-3-12:2005**

This equipment complies with IEC 61000-3-12 provided that the short-circuit power  $S_{sc}$  is greater than or equal to **1032** kVA at the interface point between the user's supply and the public system. It is the responsibility of the installer or user of the equipment to ensure, by consultation with the distribution network operator if necessary, that the equipment is connected only to a supply with a short-circuit power  $S_{sc}$  greater than or equal to **1032** kVA."

**The below Installation guide is limited applicable only for model  
ARUN50GS2**

**Installation Guide for EN 61000-3-12:2005**

This equipment complies with IEC 61000-3-12 provided that the short-circuit power  $S_{sc}$  is greater than or equal to **964** kVA at the interface point between the user's supply and the public system. It is the responsibility of the installer or user of the equipment to ensure, by consultation with the distribution network operator if necessary, that the equipment is connected only to a supply with a short-circuit power  $S_{sc}$  greater than or equal to **964** kVA."

**The below Installation guide is limited applicable only for model  
ARUN40GS2**

**Installation Guide for EN 61000-3-12:2005**

This equipment complies with IEC 61000-3-12 provided that the short-circuit power  $S_{sc}$  is greater than or equal to **847** kVA at the interface point between the user's supply and the public system. It is the responsibility of the installer or user of the equipment to ensure, by consultation with the distribution network operator if necessary, that the equipment is connected only to a supply with a short-circuit power  $S_{sc}$  greater than or equal to **847** kVA."

