



**LG**

Life's Good

# INSTALLATION MANUAL

# AIR CONDITIONER

- Please read this installation manual completely before installing the product.
- Installation work must be performed in accordance with the national wiring standards by authorized personnel only.
- Please retain this installation manual for future reference after reading it thoroughly.

**TYPE : Ceiling Cassette**



P/NO : MFL42291413

[www.lg.com](http://www.lg.com)

# TABLE OF CONTENTS

<b>Installation Requirements</b>	<b>Required Parts</b>	<b>Required Tools</b>
<b>Safety Precautions</b> .....3	<input type="checkbox"/> Connecting cable	<input type="checkbox"/> Horizontal meter
<b>Introduction</b> .....6	<input type="checkbox"/> Pipes: Gas side	<input type="checkbox"/> Screw driver
Symbols used in this Manual .....6	Liquid side	<input type="checkbox"/> Electric drill
Features .....6	<input type="checkbox"/> Hanging Bolt (W 3/8 or M10 length 650mm)	<input type="checkbox"/> Hole core drill (ø70mm)
<b>Installation</b> .....7	<input type="checkbox"/> Insulated drain hose	<input type="checkbox"/> Flaring Tools set
Installation Tools.....7	<input type="checkbox"/> Additional Drain hose (Inner Dia.....32mm)	<input type="checkbox"/> Torque Wrenches
Installation of Indoor, Outdoor Unit .....8		<input type="checkbox"/> Hexagonal Wrench (4mm, 5mm)
Air purging .....23		<input type="checkbox"/> Gas-leak detector
Test running.....25		<input type="checkbox"/> Owner's Manual
Installer Setting -PQRCUSA0.....27		<input type="checkbox"/> Installation Manual
Installation guide at the seaside.....37		<input type="checkbox"/> Thermometer

# Safety Precautions



To prevent injury to the user or other people and property damage, the following instructions must be followed.

- Incorrect operation due to ignoring instruction will cause harm or damage. The seriousness is classified by the following indications.

**⚠ WARNING** This symbol indicates the possibility of death or serious injury.

**⚠ CAUTION** This symbol indicates the possibility of injury or damage.

- Meanings of symbols used in this manual are as shown below.

	<b>Be sure not to do.</b>
	<b>Be sure to follow the instruction.</b>

## ⚠ WARNING

### ■ Installation

**Do not use a defective or underrated circuit breaker. Use this appliance on a dedicated circuit.**

- There is risk of fire or electric shock.

**For electrical work, contact the dealer, seller, a qualified electrician, or an Authorized Service Center.**

- Do not disassemble or repair the product. There is risk of fire or electric shock.

**Always ground the product.**

- There is risk of fire or electric shock.

**Install the panel and the cover of control box securely.**

- There is risk of fire or electric shock.

**Always install a dedicated circuit and breaker.**

- Improper wiring or installation may cause fire or electric shock

**Use the correctly rated breaker or fuse.**

- There is risk of fire or electric shock.

**Do not modify or extend the power cable.**

- There is risk of fire or electric shock.

**Do not install, remove, or re-install the unit by yourself (customer).**

- There is risk of fire, electric shock, explosion, or injury.

**Be cautious when unpacking and installing the product.**

- Sharp edges could cause injury. Be especially careful of the case edges and the fins on the condenser and evaporator.

**Use a vacuum pump or insert (nitrogen) gas when doing leakage test or air purge. Do not compress air or Oxygen and Do not use Flammable gases. Otherwise, it may cause fire or explosion.**

- There is the risk of death, injury, fire or explosion.

**For installation, always contact the dealer or an Authorized Service Center.**

- There is risk of fire, electric shock, explosion, or injury.

**Do not install the product on a defective installation stand.**

- It may cause injury, accident, or damage to the product.

**Be sure the installation area does not deteriorate with age.**

- If the base collapses, the air conditioner could fall with it, causing property damage, product failure, and personal injury.

**Do not let the air conditioner run for a long time when the humidity is very high and a door or a window is left open.**

- Moisture may condense and wet or damage furniture.

## ■ Operation

---

**Do not touch(operate) the product with wet hands.**

- There is risk of fire or electrical shock.

**Do not place a heater or other appliances near the power cable.**

- There is risk of fire and electric shock.

**Do not let electric parts of the product get wet.**

- It may cause There is risk of fire, failure of the product, or electric shock.

**Do not store or use flammable gas or combustibles near the product.**

- There is risk of fire or failure of product.

**If strange sounds, or small or smoke comes from product. Turn the breaker off or disconnect the power supply cable.**

- There is risk of electric shock or fire.

**When the product is soaked (flooded or submerged), contact an Authorized Service Center.**

- There is risk of fire or electric shock.

**Be cautious that water could not enter the product.**

- There is risk of fire, electric shock, or product damage.

**Turn the main power off when cleaning or maintaining the product.**

- There is risk of electric shock.

**When the product is not be used for a long time, disconnect the power supply plug or turn off the breaker.**

- There is risk of product damage or failure, or unintended operation.

**Take care to ensure that nobody could step on or fall onto the outdoor unit.**

- This could result in personal injury and product damage.

 **CAUTION**
**■ Installation**

**Always check for gas (refrigerant) leakage after installation or repair of product.**

- Low refrigerant levels may cause failure of product.

**Do not install the product where the noise or hot air from the outdoor unit could be offensive to the neighborhoods or damage property.**

- It may cause a problem for your neighbors.

**Install the drain hose to ensure that water is drained away properly.**

- A bad connection may cause water leakage.

**Use two or more people to lift and transport the product.**

- Avoid personal injury.

**Keep level even when installing the product.**

- To avoid vibration.

**Do not install the product where it will be exposed to sea wind (salt spray) directly.**

- It may cause corrosion on the product. Corrosion, particularly on the condenser and evaporator fins, could cause product malfunction or inefficient operation.

**■ Operation**

**Do not expose the skin directly to cool air for long periods of time. (Don't sit in the draft.)**

- This could harm to your health.

**Do not use the product for special purposes, such as preserving foods, works of art, etc. It is a consumer air conditioner, not a precision refrigeration system.**

- There is risk of damage or loss of property.

**Do not block the inlet or outlet of air flow.**

- It may cause product failure.

**Use a soft cloth to clean. Do not use harsh detergents, solvents, etc.**

- There is risk of fire, electric shock, or damage to the plastic parts of the product.

**Do not touch the metal parts of the product when removing the air filter. They are very sharp!**

- There is risk of personal injury.

**Do not step on or put anything on the product. (outdoor units)**

- There is risk of personal injury and failure of product.

**Always insert the filter securely. Clean the filter every two weeks or more often if necessary.**

- A dirty filter reduces the efficiency of the air conditioner and could cause product malfunction or damage.

**Do not insert hands or other objects through the air inlet or outlet while the product is operated.**

- There are sharp and moving parts that could cause personal injury.

**Do not drink the water drained from the product.**

- It is not sanitary and could cause serious health issues.

**Use a firm stool or ladder when cleaning or maintaining the product.**

- Be careful and avoid personal injury.

**Replace the all batteries in the remote control with new ones of the same type. Do not mix old and new batteries or different types of batteries.**

- Could adversely effect operation.

**Do not recharge or disassemble the batteries. Do not dispose of batteries in a fire.**

- They may burn or explode.

**If the liquid from the batteries gets onto your skin or clothes, wash it well with clean water. Do not use the remote if the batteries have leaked.**

- The chemicals in batteries could cause burns or other health hazards.

# Introduction

## Symbols used in this Manual



This symbol alerts you to the risk of electric shock.



This symbol alerts you to hazards that may cause harm to the air conditioner.

**NOTICE**





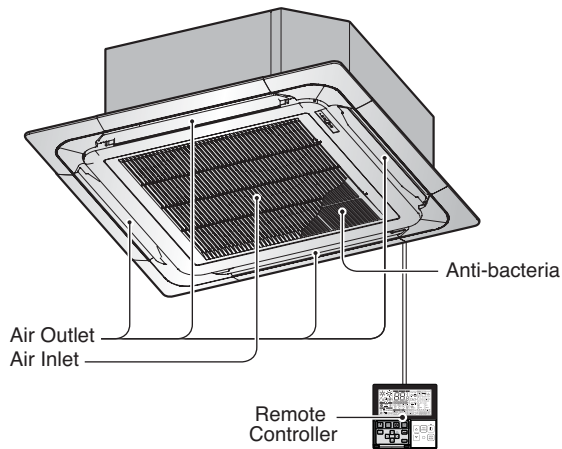



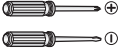

This symbol indicates special notes.

## Features

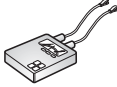

# Installation

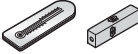
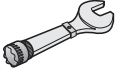
## Installation Tools

Figure	Name	Figure	Name
	Screw driver		Ohmmeter
	Electric drill		Hexagonal wrench
	Measuring tape, Knife		Ammeter
	Hole core drill		Gas-leak detector
	Spanner		Thermometer, Horizontal meter
	Torque wrench		Flaring tool set

# Installation of Indoor, Outdoor Unit

## Selection of the best location

### 1) Indoor unit

- There should not be any heat source or steam near the unit.
- There should not be any obstacles to prevent the air circulation.
- A place where air circulation in the room will be good.
- A place where drainage can be easily obtained.
- A place where noise prevention is taken into consideration.
- Do not install the unit near the door way.
- Ensure the spaces indicated by arrows from the wall, ceiling, or other obstacles.
- The indoor unit must keep the maintenance space.

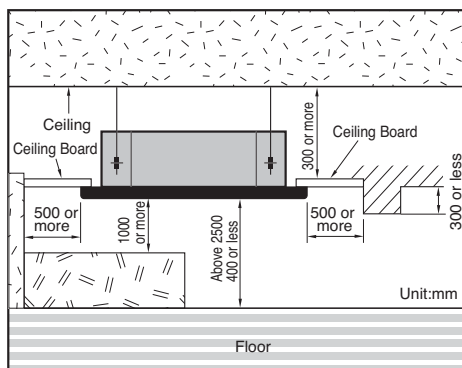

### 2) Outdoor unit

- If an awning is built over the unit to prevent direct sunlight or rain exposure, be careful that heat radiation from the condenser is not restricted.
- There should not be any animals or plants which could be affected by hot air discharged.
- Ensure the spaces indicated by arrows from the wall, ceiling, fence or other obstacles.

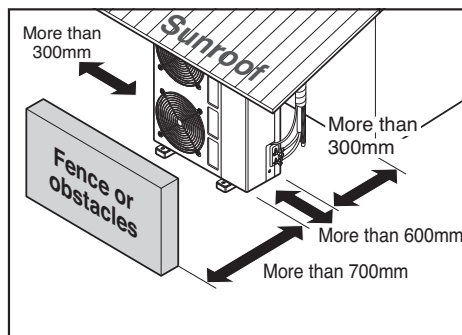

✱ Please use an annexed sheet or the corrugated cardboard on the bottom of packing as installation sheet.

✱ When using the bottom sheet, please use it after separating the installation sheet from packing of the product floor by using a knife etc as a picture below.



Annexed sheet

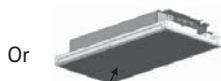

Or  
Packing corrugated cardboard on the bottom

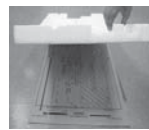

### 3) Piping length and the elevation

Model	Pipe Size mm(inch)		Length A(m)		Elevation B(m)		*Additional refrigerant (g/m)
	Gas	Liquid	Standard	Max.	Standard	Max.	
LT-H182QLE0	12.70(1/2")	6.35(1/4")	7.5	30	5	20	30
LT-H242QLE0	15.88(5/8")	6.35(1/4")	7.5	30	5	20	35
LT-H302PLE0	15.88(5/8")	6.35(1/4")	7.5	50	5	30	25
LT-H362NLE0	15.88(5/8")	6.35(1/4")	7.5	50	5	30	45
LT-H482MLE0	19.05(3/4")	9.52(3/8")	7.5	50	5	30	45
LT-H602MLE0	19.05(3/4")	9.52(3/8")	7.5	50	5	30	50
LT-C182QLE0	12.70(1/2")	6.35(1/4")	7.5	30	5	20	30
LT-C242QLE0	15.88(5/8")	6.35(1/4")	7.5	30	5	20	35
LT-C302PLE0	15.88(5/8")	6.35(1/4")	7.5	50	5	30	30
LT-C362NLE0	15.88(5/8")	6.35(1/4")	7.5	50	5	30	30
LT-C482MLE0	19.05(3/4")	9.52(3/8")	7.5	50	5	30	55
LT-C602MLE0	19.05(3/4")	9.52(3/8")	7.5	50	5	30	55

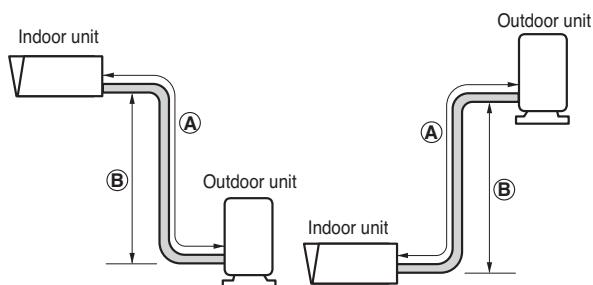

#### CAUTION:

- Rated performance for refrigerant line length of:7.5m
- Capacity is based on standard length and maximum allowance length is on the basis of reliability.
- Improper refrigerant charge may result in abnormal cycle.
- Oil trap should be installed every 10 meters.

## Ceiling opening dimensions and hanging bolt location

- The dimensions of the paper model for installing are the same as those of the ceiling opening dimensions.
- Please use included paper or cardboard on the bottom of packaging as installation paper
- Select and mark the position for fixing bolts and piping hole.
- Decide the position for fixing bolts slightly tilted to the drain direction after considering the direction of drain hose.
- Drill the hole for anchor bolt on the ceiling.
- The hole size for four anchor bolts is  $\varnothing$  14.5mm & 40mm depth.
- When using cardboard on the bottom of packaging, use after separating installation paper from bottom of the product packaging using back of a knife as shown in the picture (TM/TN/TP)

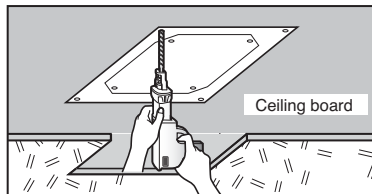
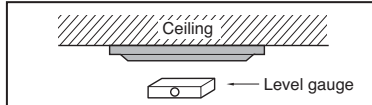
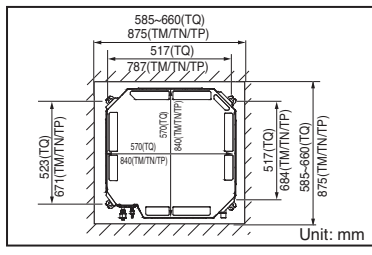

### CAUTION:

- This air-conditioner uses a drain pump.
- Horizontally install the unit using a level gauge.
- During the installation, care should be taken not to damage electric wires.

### NOTICE

- Thoroughly study the following installation locations:
  1. In such places as restaurants and kitchens, considerable amount of oil steam and flour adhere to the turbo fan, the fin of the heat exchanger and the drain pump, resulting in heat exchange reduction, spraying, dispersing of water drops, drain pump malfunction, etc.  
In these cases, take the following actions:
    - Make sure that the ventilation fan for smoke-collecting hood on a cooking table has sufficient capacity so that it draws oily steam which should not flow into the suction of the air conditioner.
    - Make enough distance from a cooking room to install the air conditioner in such a place where it may not suck in oily steam.

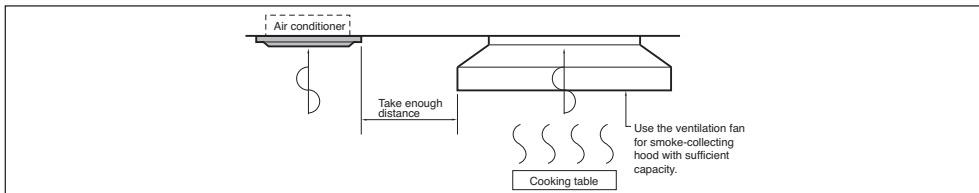

2. Avoid installing air conditioner in such circumstances where cutting oil mist or iron powder is in suspension in factories, etc.
3. Avoid places where inflammable gas is generated, flows in, is stored or vented.
4. Avoid places where sulfurous acid gas or corrosive gas is generated.
5. Avoid places near high frequency generators.

## The Indoor Unit Installation

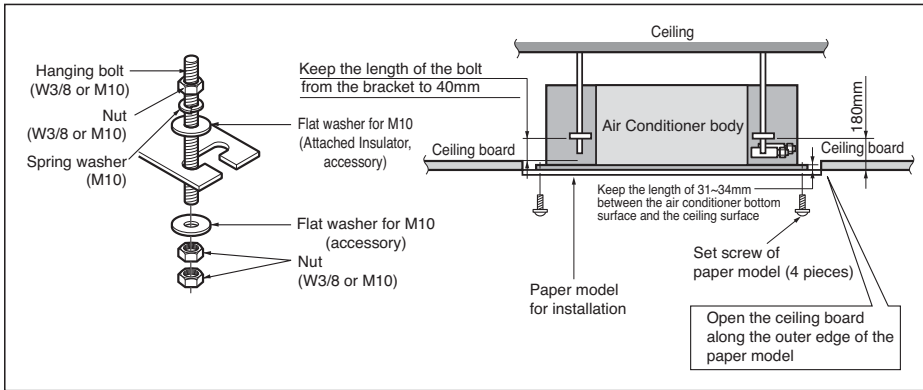

• The following parts is option.

- ① Hanging Bolt - W 3/8 or M10
- ② Nut - W 3/8 or M10
- ③ Spring Washer - M10
- ④ Plate Washer - M10

• Drill the piping hole on the wall slightly tilted to the outdoor side using a  $\varnothing 70$  hole-core drill.

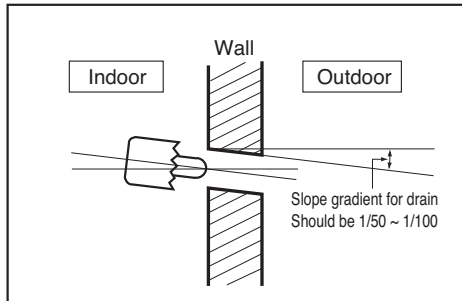

**CAUTION:** Tighten the nut and bolt to prevent unit falling.

## Remote Controller Installation

• Although the room temperature sensor is in the indoor unit, the remote controller should be installed in such places away from direct sunlight and high humidity.

### Installation of the remote controller

- Select places that are not splashed with water.
- Select control position after receiving customer approval.
- The room temperature sensor is built in the indoor unit.
- This remote controller equipped with liquid crystal display. If this position is higher or lower, display is difficult to see. (The standard height is 1.2 ~ 1.5m high)

### Routing of the remote controller cord

- Keep the remote controller cord away from the refrigerant piping and the drain piping.
- To protect the remote controller cord from electrical noise, place the cord at least 5cm away from other power cables (audio equipment, television set, etc.)
- If the remote controller cord is secured to the wall, provide a trap at the top of the cord to prevent water droplets from running.

## WIRED REMOTE CONTROL INSTALLATION

### 1. Please fix tightly using provided screw after placing remote controller setup board on the place where you like to setup.

- Please set it up not to bend because poor setup could take place if setup board bends.  
Please set up remote controller board fit to the reclamation box if there is a reclamation box.
- Install the product so as not to make a gap with the wall side and to prevent shaking after the installation.

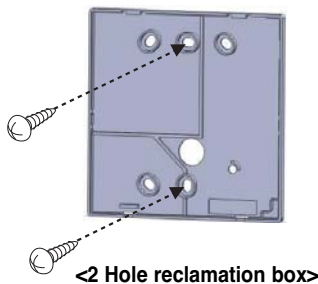
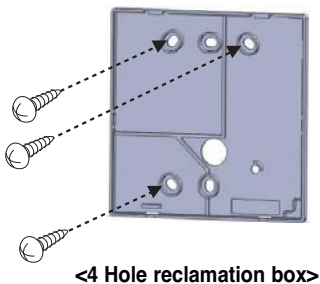

### 2. Can set up Wired remote controller cable into three directions.

- Setup direction: the surface of wall reclamation, upper, right
- If setting up remote controller cable into upper and right side, please set up after removing remote controller cable guide groove.

\* Remove guide groove with long nose.

① Reclamation to the surface of the wall

② Upper part guide groove

③ Right part guide groove

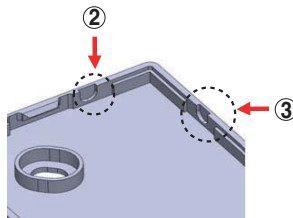
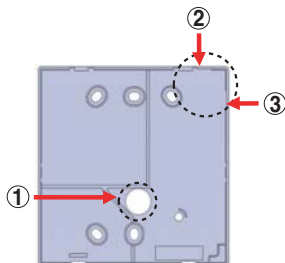

<Wire guide grooves>

### 3. Please fix remote controller upper part into the setup board attached to the surface of the wall, as the picture below, and then, connect with setup board by pressing lower part.

- Please connect not to make a gap at the remote controller and setup board's upper and lower, right and left part.

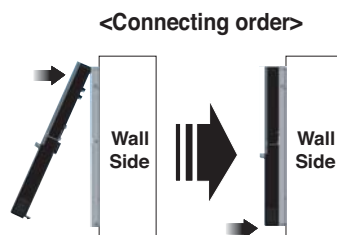

When separating remote controller from setup board, as the picture below, after inserting into the lower separating hole using screw driver and then, spinning clockwise, remote controller is separated.

- There are two separating holes. Please individually separate one at a time.
- Please be careful not to damage the inside components when separating.

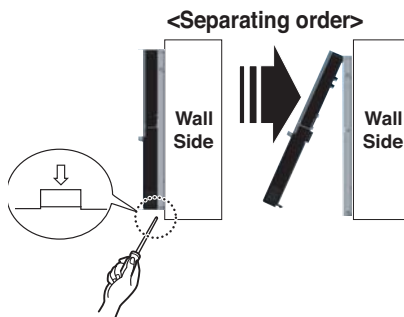

### 4. Please connect indoor unit and remote controller using connection cable.

12V	Red
Signal	Yellow
GND	Black

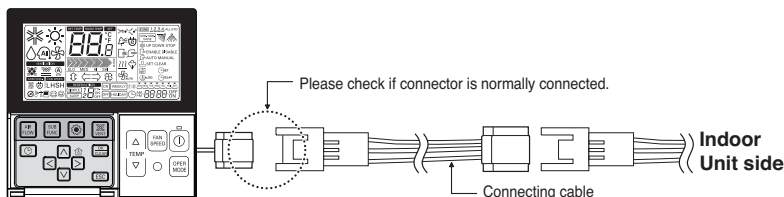

### 5. Please use extension cable if the distance between wired remote controller and indoor unit is more than 10m.

## ⚠ CAUTION

When installing the wired remote controller, do not bury it in the wall.

(It can cause damage in the temperature sensor.)

Do not install the cable to be 50m or above.

(It can cause communication error.)

- When installing the extension cable, check the connecting direction of the connector of the remote controller side and the product side for correct installation.
- If you install the extension cable in the opposite direction, the connector will not be connected.
- Specification of extension cable: 2547 1007 22# 2 core 3 shield 5 or above.

**Apply totally enclosed noncombustible conduit in case of local building code Requiring plenum cable usage**

## Wiring Connection

- Open the control box cover and connect the Remote controller cord and Indoor power wires.

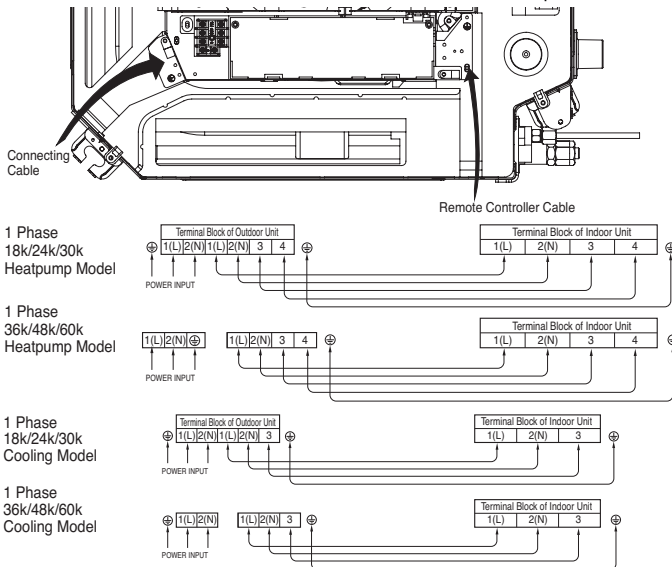

### CAUTION

The power cord connected to the outdoor unit should be complied with the following specifications (Rubber insulation, type H07RN-F approved by HAR or SAA).

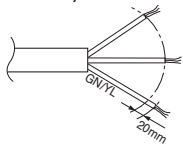

Capacity	1 Phase
18k/24k	2.1mm <sup>2</sup>
30k	3.5mm <sup>2</sup>
36k	5.5mm <sup>2</sup>
48k/60k	6.5mm <sup>2</sup>

The connecting cable connected to the indoor and outdoor unit should be complied with the following specifications (Rubber insulation, type H05RN-F approved by HAR or SAA).

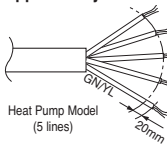

#### NORMAL CROSS-SECTIONAL

Capacity	1 Phase
18k/24k/30k/36k	0.75mm <sup>2</sup>
48k/60k	1.0mm <sup>2</sup>

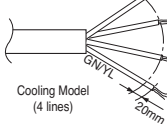

#### NORMAL CROSS-SECTIONAL

Capacity	1 Phase
18k/24k/30k/36k	0.75mm <sup>2</sup>
48k/60k	1.0mm <sup>2</sup>

If the supply cord is damaged, it must be replaced by a special cord or assembly available from the manufacturer or its service agent.

### ◆ Precautions when laying power wiring

Use round pressure terminals for connections to the power terminal block.

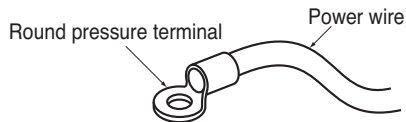

When none are available, follow the instructions below.

- Do not connect wiring of different thicknesses to the power terminal block. (Slack in the power wiring may cause abnormal heat.)
- When connecting wiring which is the same thickness, do as shown in the figure below.

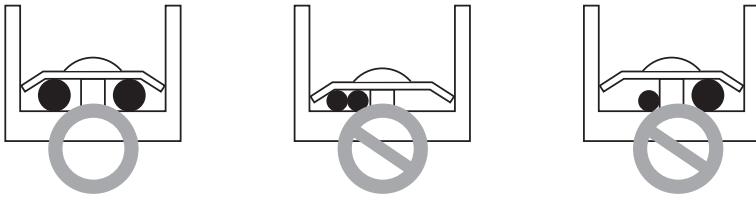

- For wiring, use the designated power wire and connect firmly, then secure to prevent outside pressure being exerted on the terminal block.
- Use an appropriate screwdriver for tightening the terminal screws. A screwdriver with a small head will strip the head and make proper tightening impossible.
- Over-tightening the terminal screws may break them.

## ELECTRICAL WIRING

1. All wiring must comply with LOCAL REGULATIONS.
2. Select a power source that is capable of supplying the current required by the air conditioner.
3. Feed the power source to the unit via a distribution switch board designed for this purpose.
4. The terminal screws inside the control box may be loose due to vibration during transport. Check the screws for loose connection.  
(Running the air conditioner with loose connection can overload and damage electrical components.)
5. Always ground the air conditioner with a grounding wire and connector to meet the LOCAL REGULATION.

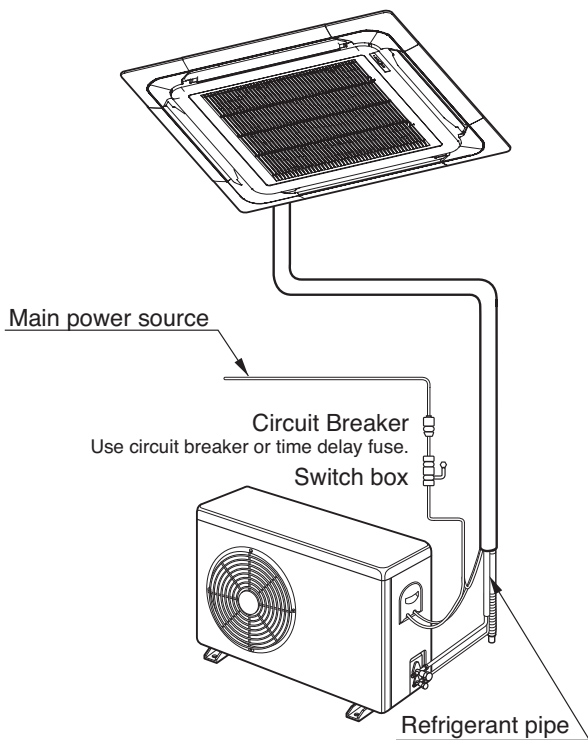

## CONNECTING THE CABLE TO OUTDOOR UNIT

1. Remove the Cover control from the unit by loosening a screw. Connect the wires to the terminals on the control board individually as following.
2. Secure the cable onto the control board with the holder (clammer).
3. Refix the cover control to the original position with the screw.
4. Use a recognized circuit breaker between the power source and the unit.  
a disconnecting device to adequately disconnect all supply lines must be fitted.

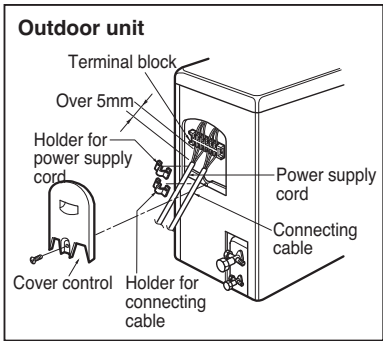

Circuit Bracker (A)	Grade					
	18k	24k	30k	36k	48k	60k
	20	20	30	30	50	50

## Connecting Pipes to the Indoor Unit

### • Preparation of Piping

Main cause of gas leakage is defect in flaring work. Carry out correct flaring work in the following procedure.

#### 1) Cut the pipes and the cable.

- Use the accessory piping kit or the pipes purchased locally.
- Measure the distance between the indoor and the outdoor unit.
- Cut the pipes a little longer than measured distance.
- Cut the cable 1.5m longer than the pipe length.

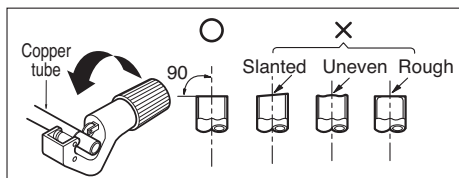

#### 2) Burrs removal

- Completely remove all burrs from the cut cross section of pipe/tube.
- Put the end of the copper tube/pipe to downward direction as you remove burrs in order to avoid to let burrs drop in the tubing.

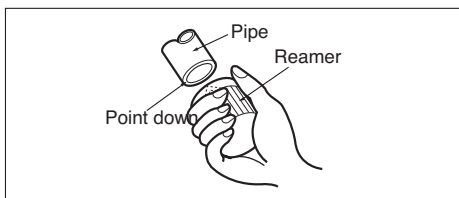

#### 3) Putting nut on

- Remove flare nuts attached to indoor and outdoor units, than put them on pipe/tube having completed burr removal. (Not possible to put them on after flaring work)

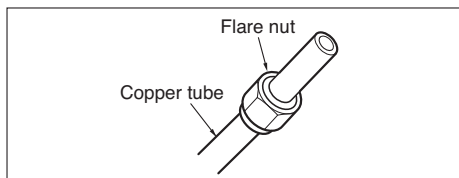

#### 4) Flaring work

- Carry out flaring work using flaring tool as shown below.

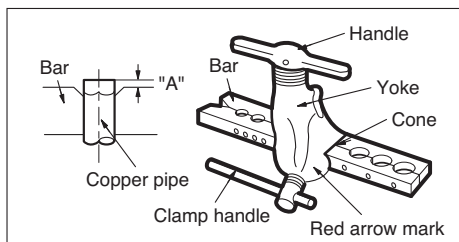

Outside diameter		A
mm	inch	mm
Ø6.35	1/4	1.1~1.3
Ø9.52	3/8	1.5~1.7
Ø12.7	1/2	1.6~1.8
Ø15.88	5/8	1.6~1.8
Ø19.05	3/4	1.9~2.1

Firmly hold copper tube in a bar(or die) as indicated dimension in the table above.

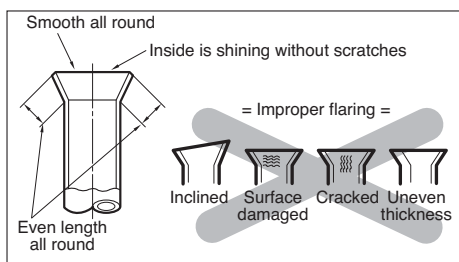

#### 5) Check

- Compare the flared work with figure below.
- If flare is noted to be defective, cut off the flared section and do flaring work again.

- If the piping and the drain hose are in common direction bundle the piping and the drain hose together by wrapping them with vinyl tape.

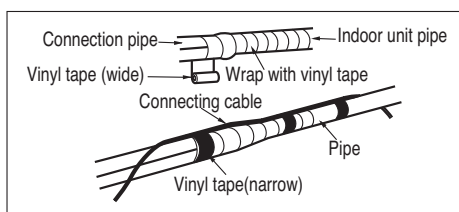

### Piping Connection

1. Form the piping according to its routing. Avoid bending and bending back the same piping point more than three times. (This will result in hardening the pipe.)
2. After deforming the piping, align centers of the union fitting of the indoor unit and the piping, and tighten them firmly with wrenches.
3. Connect pipe to the service valve or ball valve which is located below the outdoor unit.
4. After completing the piping connection, be sure to check if there is gas leakage in indoor and outdoor connection.

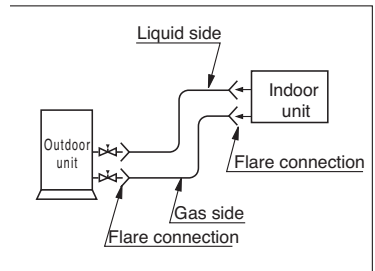

### Vacuum drying

After completing the piping connection, execute vacuum drying for the connecting piping and the indoor unit.

The vacuum drying must be carried out using the service ports of both the liquid and gas side valves.

Grade	Liquid side piping	Gas side piping
18k	Ø6.35mm	Ø12.70mm
24k	Ø6.35mm	Ø15.88mm
30k	Ø6.35mm	Ø15.88mm
36k	Ø6.35mm	Ø15.88mm
48k	Ø9.52mm	Ø19.05mm
60k	Ø9.52mm	Ø19.05mm

**CAUTION:** Use two wrenches and tighten with regular torque.

Flare nut fastening torque	
Ø6.35mm	16±2 N·m
Ø9.52mm	38±4 N·m
Ø12.7mm	55±6 N·m
Ø15.88mm	75±7 N·m
Ø19.05mm	110±10 N·m

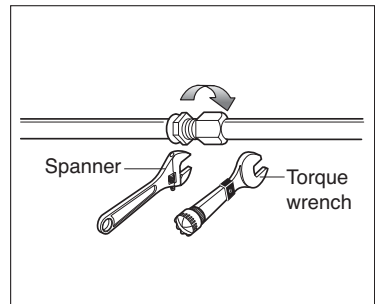

## Installation of Decorative Panel

**The decorative panel has its installation direction.  
Before installing the decorative panel, always remove the paper template.**

1. Remove the packing and take out air inlet grille from front panel.

Front grille

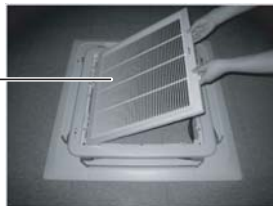

2. Remove the Corner covers of the panel.

Coner cover



3. Fit the panel on the unit by inserting hooks as shown in picture.

Hook clip

Hook

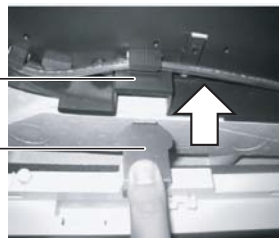

4. Insert two screws on diagonal corners of panel. Do not tighten the bolts completely. (The fixing screws are included in the indoor unit box.)  
Check the alignment of panel with the ceiling. Height can be adjusted using hanging bolts as shown in picture. Insert the other two screws and tighten all screws completely.



5. Fit the corner covers.

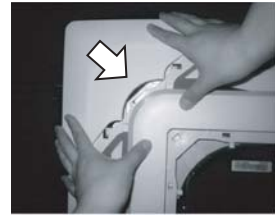

6. Open two screws of control panel cover.

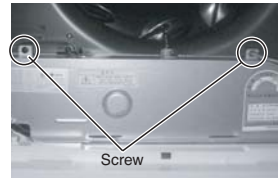

7. Connect one display connector and two vane control connectors of front panel to indoor unit PCB.

The position marking on PCB is as:  
Display connector : CN-DISPLAY  
Vane control connector: CN-VANE 1,2

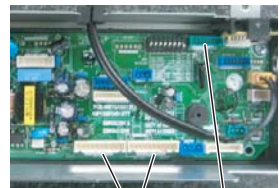

8. Close the cover for control box.

CN-VANE 1,2 CN-DISPLAY



9. Fit the link on the panel as shown in picture. (The link is included in the front panel unit box.) (TM/TN/TP)

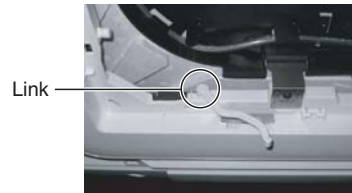

10. Attach the other side of link on the filter guide of inlet grille. Install the air inlet grille and filter on the panel. (TM/TN/TP)



11. Install the air inlet grille and Filter on the panel.



**CAUTION: Install certainly the decorative panel.**  
**Cool air leakage causes sweating. ⇨ Water drops fall.**

Good example

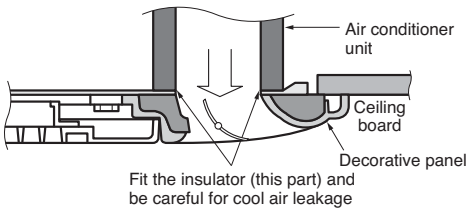

Bad example

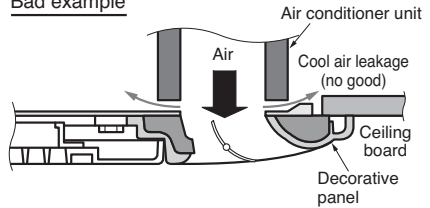

## Indoor Unit Drain Piping

- Drain piping must have down-slope (1/50 to 1/100): be sure not to provide up-and-down slope to prevent reversal flow.
- During drain piping connection, be careful not to exert extra force on the drain port on the indoor unit.
- The outside diameter of the drain connection on the indoor unit is 32mm.

Piping material: Polyvinyl chloride pipe VP-25 and pipe fittings

- Be sure to execute heat insulation on the drain piping.

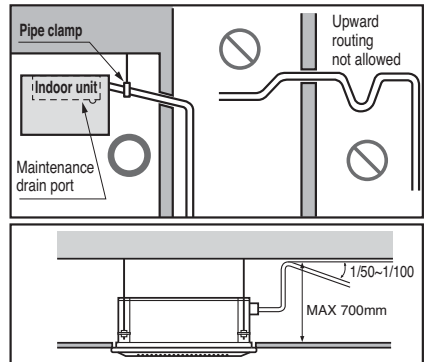

Heat insulation material: Polyethylene foam with thickness more than 8 mm.

## Drain test

The air conditioner uses a drain pump to drain water.  
 Use the following procedure to test the drain pump operation:

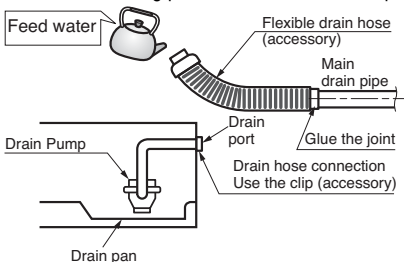

- Connect the main drain pipe to the exterior and leave it provisionally until the test comes to an end.
- Feed water to the flexible drain hose and check the piping for leakage.
- Be sure to check the drain pump for normal operating and noise when electrical wiring is complete.
- When the test is complete, connect the flexible drain hose to the drain port on the indoor unit.

**CAUTION: The supplied flexible drain hose should not be curved, neither screwed. The curved or screwed hose may cause a leakage of water.**

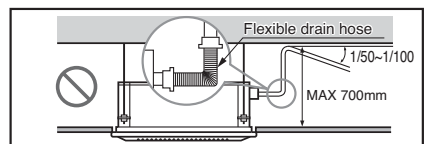

## HEAT INSULATION

1. Use the heat insulation material for the refrigerant piping which has an excellent heat-resistance (over 120°C).

2. Precautions in high humidity circumstance:

This air conditioner has been tested according to the "KS Standard Conditions with Mist" and confirmed that there is not any default. However, if it is operated for a long time in high humid atmosphere (dew point temperature: more than 23°C), water drops are liable to fall. In this case, add heat insulation material according to the following procedure:

- Heat insulation material to be prepared... Adiabatic EPDM or NBR with thickness 10 to 20mm.
- Stick EPDM or NBR on all air conditioners that are located in ceiling atmosphere.
- In addition to the normal heat insulation (thickness: more than 8mm) for refrigerant piping (gas piping: thick piping) and drain piping, add further 10mm to 30mm thickness material.

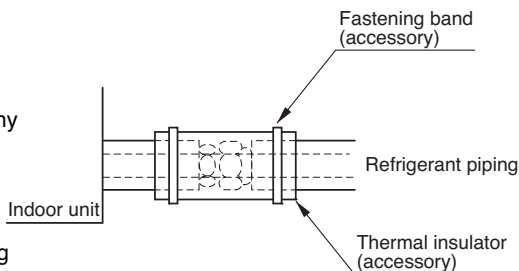

## FORM THE PIPINGS

1. Wrap the connecting portion of indoor unit with the Insulation material and secure it with two Plastic Bands. (for the right pipings)

- If you want to connect an additional drain hose, the end of the drain-outlet should keep distance from the ground. (Do not dip it into water, and fix it on the wall to avoid swinging in the wind.)

In case of the Outdoor unit being installed below position of the Indoor unit.

2. Tape the Pipings, drain hose and Connecting Cable from bottom to top.

3. Form the pipings gathered by taping along the exterior wall and fix it onto the wall by saddle or equivalent.

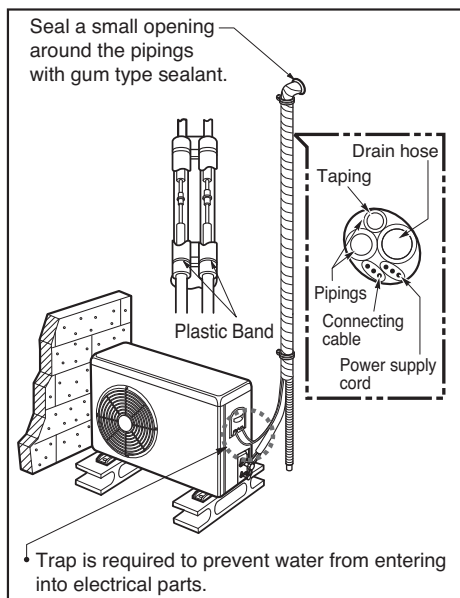

In case of the Outdoor Unit being installed above position of the Indoor Unit.

4. Tape the Pipings and Connecting cable from bottom to top.
5. Form the pipings gathered by taping along the exterior wall, and make the trap prevent water from entering into the room.
6. Fix the pipings onto the wall by saddle or equivalent.

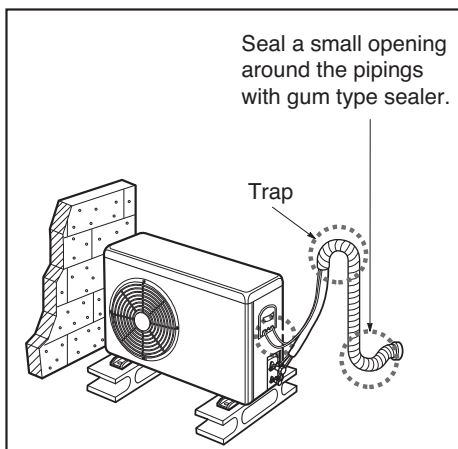

## Air Purging

### Air purging

The air and moisture remaining in the refrigerant system have undesirable effects as indicated below.

1. Pressure in the system rises.
2. Operating current rises.
3. Cooling(or heating) efficiency drops.
4. Moisture in the refrigerant circuit may freeze and block capillary tubing.
5. Water may lead to corrosion of parts in the refrigeration system.

Therefore, after evacuating the system, take a leak test for the piping and tubing between the indoor and outdoor unit.

### Air purging with vacuum pump

1. Check that both liquid and gas pipe between indoor and outdoor have been properly connected.
2. Remove the service valve cap from both the gas and liquid side on the outdoor unit.
3. Confirm that both the liquid and gas side valve are set to the closed position.
4. Connect the manifold valve(with pressure gauge) to the gas pipe side.



### CAUTION:

**Be sure to use a manifold valve for air purging. If it is not available, use a stop valve for this purpose. The "Hi" knob of the manifold valve must always be kept close.**

5. And connect the Nitrogen cylinder to the service port with charge hoses to the manifold gauge.
6. Pressurize the system to no more than 150 P.S.I.G with dry nitrogen gas. Close the nitrogen cylinder valve when it shows reading of 150 P.S.I.G.

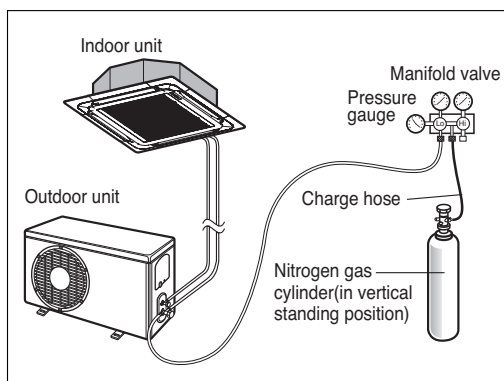



**CAUTION:**

To avoid nitrogen entering the refrigerant system in a liquid state, the top of the cylinder must be higher than its bottom when you pressurize the system. Usually, the cylinder is used in a vertical standing position.

7. Check for leakage with Liquid soap solution. Do the leakage test at all joints of tubing (indoor and outdoor) and on the service valve (both gas and liquid side).

**Soap water method**

1. Remove the caps from the 2-way and 3-way valves.
2. Remove the service-port cap from the 3-way valve.
3. To open the 2-way valve turn the valve stem counterclockwise approximately 90°, wait for about 2~3 sec, and close it.
4. Apply a soap water or a liquid neutral detergent on the indoor unit connection or outdoor unit connections by a soft brush to check for leakage of the connecting points of the piping.
5. If bubbles come out, the pipes have leakage

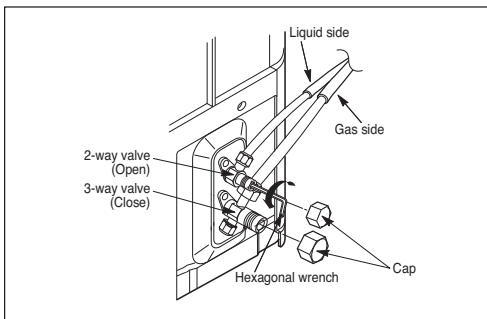

**Evacuation**

1. If the system is found free from all leakages, relieve the nitrogen pressure by loosening the charge hose connector at nitrogen cylinder. Disconnect the hose from cylinder when pressure reaches to normal state.
  2. Evacuation : Connect the charge hose to the vacuum pump and Connect the "Lo" side hose to the outdoor unit Which is the gas side valve. Check that the "Lo" Knob of manifold valve to open. Then, run the vacuum pump. The operation time for evacuation varies with tubing length and capacity of the pump.
- The degree of vacuum should be under 0.8 Torr.
  - When the desired vacuum is reached, close the "Lo" knob of the manifold valve and stop the vacuum pump.

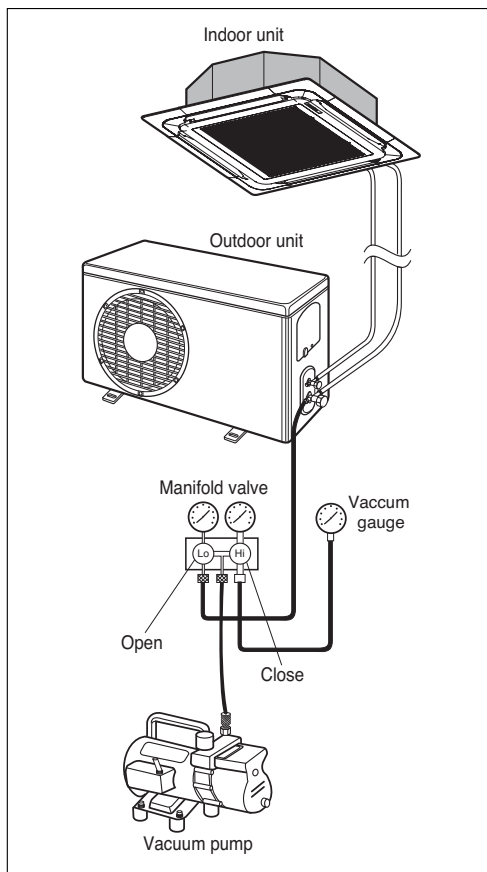

3. Once the desired vacuum is created. Disconnect the vacuum pump and open the liquid side valve stem by turning it to counter-clockwise direction with service valve wrench.
4. Open completely the gas side valve by turning to counter-clockwise with service valve wrench.
5. Remove slowly the charge hose connected to the gas side service port (to release the pressure).
6. Replace back the flare nut and its bonnet on the gas side service port. Fasten the flare nut with adjustable wrench to prevent any leakage from the system.
7. Fasten back the valve cap on both gas and liquid side service valves.

## Test running

### 1) PRECAUTIONS IN TEST RUN

- The initial power supply must provide at least 90% of the rated voltage. Otherwise, the air conditioner should not be operated.



#### CAUTION:

- ① For test run, carry out the cooling operation firstly even during heating season. If heating operation is carried out firstly, it leads to the trouble of compressor. Then attention must be paid.
- ② Carry out the test run more than 5 minutes without fail.  
(Test run will be cancelled 18 minutes later automatically)

- The test run is started by pressing the room temperature checking button and down timer button for 3 seconds at the same time.
- To cancel the test run, press any button.

### CHECK THE FOLLOWING ITEMS WHEN INSTALLATION IS COMPLETED

- After completing work, be sure to measure and record trial run properties, and store measured data, etc.
- Measuring items are room temperature, outside temperature, suction temperature, blow out temperature, wind velocity, wind volume, voltage, current, presence of abnormal vibration and noise, operating pressure, piping temperature, compressive pressure.
- As to the structure and appearance, check following items.
 

<ul style="list-style-type: none"> <li><input type="checkbox"/> Is the circulation of air adequate?</li> <li><input type="checkbox"/> Is the draining smooth?</li> <li><input type="checkbox"/> Is the heat insulation complete (refrigerant and drain piping)?</li> <li><input type="checkbox"/> Is there any leakage of refrigerant?</li> </ul>	<ul style="list-style-type: none"> <li><input type="checkbox"/> Is the remote controller switch operated?</li> <li><input type="checkbox"/> Is there any faulty wiring?</li> <li><input type="checkbox"/> Are not terminal screws loosened?</li> </ul>
M4.....118N·cm{12kgf·cm}	M5.....196N·cm{20kgf·cm}
M6.....245N·cm{25kgf·cm}	M8.....588N·cm{60kgf·cm}

### 2) Connection of power supply

1. Connect the power supply cord to the independent power supply.
  - Circuit breaker is required.
2. Operate the unit for 15 minutes or more.

### 3) Evaluation of the performance

1. Measure the temperature of the intake and discharge air.
2. Ensure the difference between the intake temperature and the discharge one is more than 8°C (Cooling) or reversely (Heating).

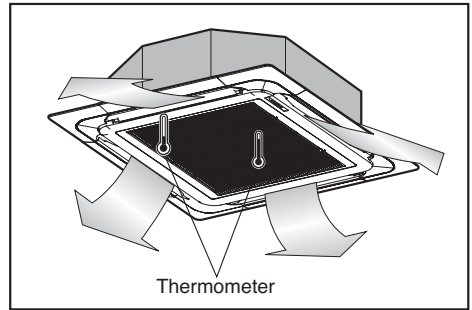

#### **CAUTION**

After the confirmation of the above conditions, prepare the wiring as follows:

- 1) Never fail to have an individual power specialized for the air conditioner. As for the method of wiring, be guided by the circuit diagram pasted on the inside of control box cover.
- 2) Provide a circuit breaker switch between power source and the unit.
- 3) The screw which fasten the wiring in the casing of electrical fittings are liable to come loose from vibrations to which the unit is subjected during the course of transportation. Check them and make sure that they are all tightly fastened. (If they are loose, it could give rise to burn-out of the wires.)
- 4) Specification of power source
- 5) Confirm that electrical capacity is sufficient.
- 6) Be sure that the starting voltage is maintained at more than 90 percent of the rated voltage marked on the name plate.
- 7) Confirm that the cable thickness is as specified in the power sources specification. (Particularly note the relation between cable length and thickness.)
- 8) Never fail to equip a leakage breaker where it is wet or moist.
- 9) The following troubles would be caused by voltage drop-down.
  - Vibration of a magnetic switch, damage on the contact point there of, fuse breaking, disturbance to the normal function of a overload protection device.
  - Proper starting power is not given to the compressor.

#### **HAND OVER**

Teach the customer the operation and maintenance procedures, using the operation manual (air filter cleaning, temperature control, etc.).

## Installer Setting -How to enter installer setting mode

### ⚠ CAUTION

Installer setting mode is to set the detail function of the remote controller.

If the installer setting mode is not set correctly, it can cause problems to the product, user injury or property damage. This must be set by a certificated installer, and any installation or change that is carried out by a non-certificated person should be responsible for the results. In this case, free service cannot be provided.

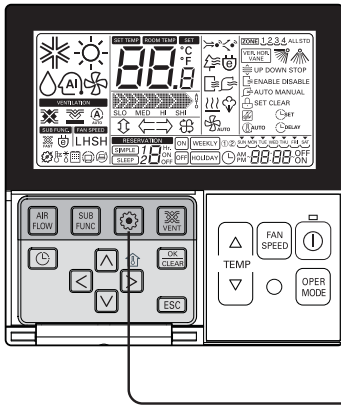

**1** If pressing  button long for 3 seconds, it enters into remote controller setter setup mode.

- If pressing once shortly, it enters into user setup mode. Please press more than 3 seconds for sure.

**2** When you enter the setting mode initially, Function code is displayed on the bottom of the LCD screen.

  
 Function Code      Value

- Some categories of the menu may not be displayed according to the function of the product, or the menu name may be different.

**<Installer Setting Code Table>**

**1) General air-conditioner product**

No.	Function	Code	Value
1	Test Run	01	01:Set
2	Address Setting	02	00~FF : Address
3	E.S.P. Value	03	<ESP Step><ESP Value>    <Example> 01:VeryLow 0 ~ 255 02:Low 03:Med 04:High 05:Very High
4	Thermistor	04	01:Remo 02:Indoor 03:2TH
5	Ceiling Height	05	01:Med 02:Low 03:High 04:Very High
6	Static Pressure	06	01:V-H 02:F-H 03:V-L 04:F-L
7	Master Setting	07	00:Slave 01:Master
8	Override Setting	08	00:Slave 01:Master
9	Dry Contact	09	00:Auto-Off 01:Auto-On
10	Release 3 Min. Delay	10	01:Set
11	Zone State	11	01:Variable 02:Fixed
12	Celsius Fahrenheit Switching	12	00:Celsius 01:Fahrenheit (Optimized only for U.S.A)
13	Zone Type	13	00:Zone Controller 01:Damper Controller
14	Zone Number	14	02~04(Zone number)
15	Plasma	20	00: Not Installed 01: Installed
16	Electric heater	21	
17	Humidifier	22	
18	Elevation Grill	23	
19	Ventilation Kit	24	





\* Some contents may not be displayed depending on the product function

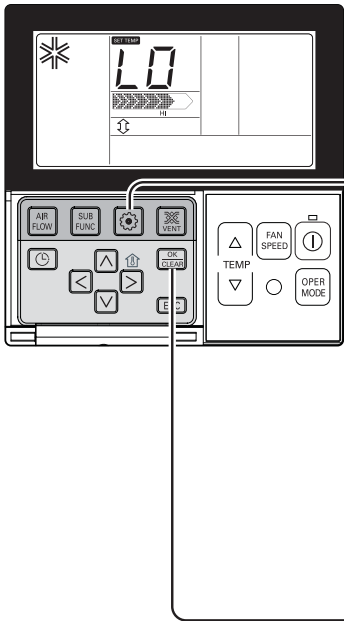

# Installer Setting - Test Run Mode

After installing the product, you must run a Test Run mode.  
 For details related to this operation, refer to the product manual.



- If pressing  button long for 3 seconds, it enters into remote controller setter setup mode.

  - If pressing once shortly, it enters into user setup mode. Please press more than 3 seconds for sure.
  - Please cancel the right and left of wind direction for RAC product.

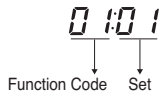

- Setup figure '01' blinks at the lower part of indication window.

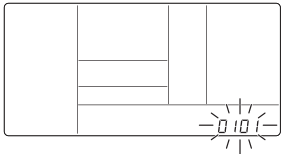

- Press  button to start.

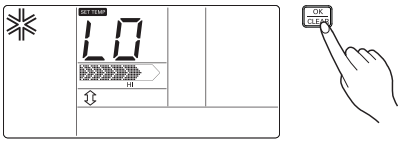



- During the test run, pressing the below button will exit the test run.



  - Select operation, temperature up/down, wind flow control, wind direction, start/stop button.

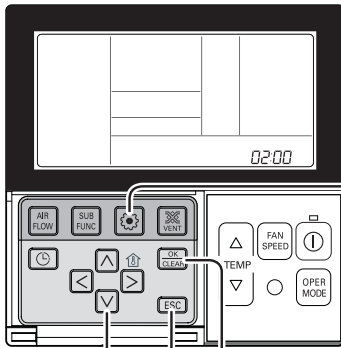

## Installer Setting - Setting Address of Central Control





It's the function to use for connecting central control.  
Please refer to central controller manual for the details

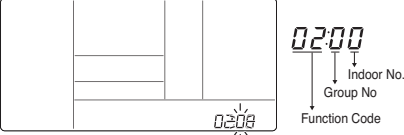









- 1** If pressing  button long for 3 seconds, it enters into remote controller setter setup mode.  
- If pressing once shortly, it enters into user setup mode. Please press more than 3 seconds for sure.





- 2** If entering into address setup mode by using  button, it indicates as picture below.

- 3** Set Group No. by pressing   button.(0~F)



- 4** Move to Indoor No. setting option by pressing   button.





- 5** Set Indoor No. by pressing   button.





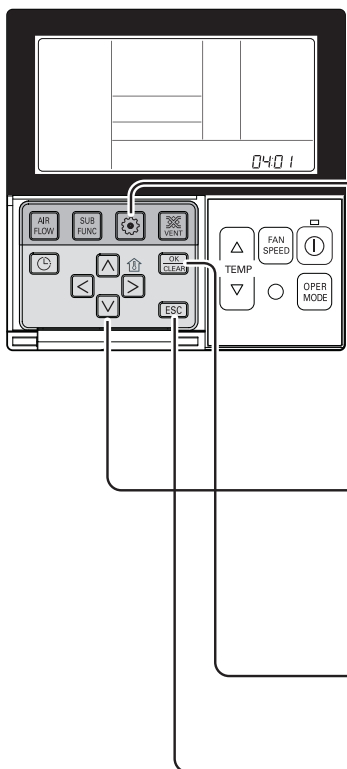





- 6** Press  button to save.

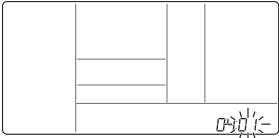

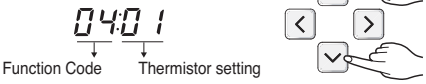
- 7** Pressing  button will exit settings mode.  
\* After setup, it automatically gets out of setup mode if there is no button input for 25 seconds.  
\* When exiting without pressing set button, the manipulated value is not reflected.

# Installer Setting - Thermistor

This is the function to select the temperature sensor to judge the room temperature.



- 1** If pressing  button long for 3 seconds, it enters into remote controller setter setup mode.  
 - If pressing once shortly, it enters into user setup mode. Please press more than 3 seconds for sure.
- 2** If moving to room temperature perception sensor selection menu by pressing , it indicates as picture below.
 
- 3** Set Thermistor value by pressing   button. (01: Remote Controller, 02: Indoor, 03: 2TH)
 
- 4** Press  button to save.
 
- 5** Pressing  button will exit settings mode.  
 \* After setup, it automatically gets out of setup mode if there is no button input for 25 seconds.  
 \* When exiting without pressing set button, the manipulated value is not reflected.

### <Thermistor Table>

Temperature sensor selection		Function
01	Remote controller	Operation in remote controller temperature sensor
02	Indoor unit	Operation in indoor unit temperature sensor
03	2TH	Cooling Operation of higher temperature by comparing indoor unit's and wired remote controller's temperature. (There are products that operate at a lower temperature.)
		Heating Operation of lower temperature by comparing indoor unit's and wired remote controller's temperature.

\* The function of 2TH has different operation characteristics according to the product.

# Installer Setting -Ceiling Height Selection

This function is to adjust FAN Airflow rate according to ceiling height (For ceiling type product)

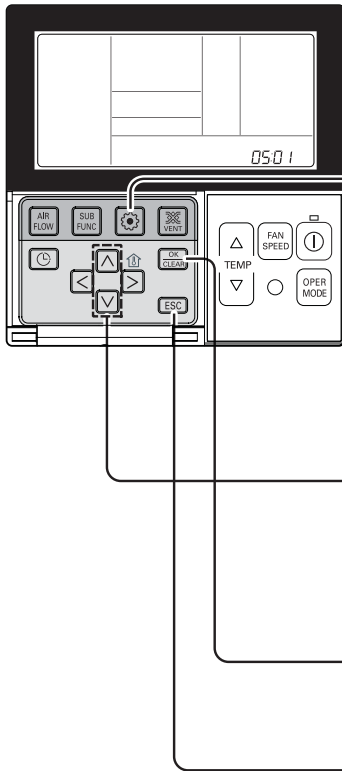

- 1** If pressing button long for 3 seconds, it enters into remote controller setter setup mode.  
- If pressing once shortly, it enters into user setup mode. Please press more than 3 seconds for sure.
- 2** If moving to ceiling height selection menu by pressing button, it indicates as picture below.

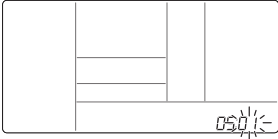
- 3** Select ceiling height value by pressing button. (01:Low, 02:Standard, 03:High, 04:Very high)

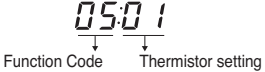
- 4** Press button to save.

- 5** Pressing button will exit settings mode.  
\* After setup, it automatically gets out of setup mode if there is no button input for 25 seconds.  
\* When exiting without pressing set button, the manipulated value is not reflected.

### <Ceiling Height Selection Table>

	Ceiling Height Level	Description
01	Low	Decrease the indoor airflow rate 1 step from standard level
02	Standard	Set the indoor airflow rate as standard level
03	High	Increase indoor airflow rate 1 step from standard level
04	Very high	Increase indoor airflow rate 2 steps from standard level



- Ceiling height setting is available only for some products.
- Ceiling height of 'Very high' function may not exist depending on the indoor unit.
- Refer to the product manual for more details.

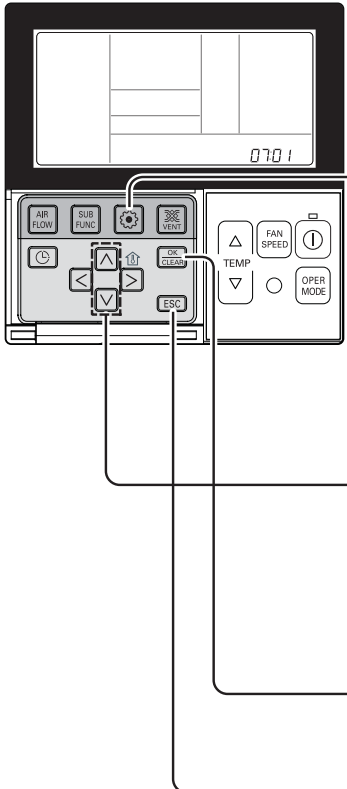

# Installer Setting-Remote Controller Master/Slave Setup

It is a function for settings in group control, or 2-remote controller control.





- 1** If pressing  button long for 3 seconds, it enters into remote controller setter setup mode.  
 - If pressing once shortly, it enters into user setup mode. Please press more than 3 seconds for sure.



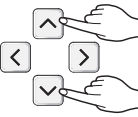

- 2** If pressing  button repeatedly, it moves to master/slave selection menu as picture below.

- 3** Select Master/ Slave by pressing   button.  
 (00: Slave, 01: Master)



Function Code      Master/Slave value

- 4** Press  button to save.



- 5** Pressing  button will exit settings mode.  
 \* After setup, it automatically gets out of setup mode if there is no button input for 25 seconds.  
 \* When exiting without pressing set button, the manipulated value is not reflected.

Remote controller	Function
Master	Indoor unit operates based on master remote controller at group control. (Master is set when delivering from the warehouse.)
Slave	Setup all remote controllers except one master remote controller to slave at group control

\* Refer to the 'group control' part for details



- When controlling in groups, basic operation settings, airflow strength weak/medium/strong, lock setting of the remote controller, time settings, and other functions may be restricted.

## Installer Setting - Option Function Setting

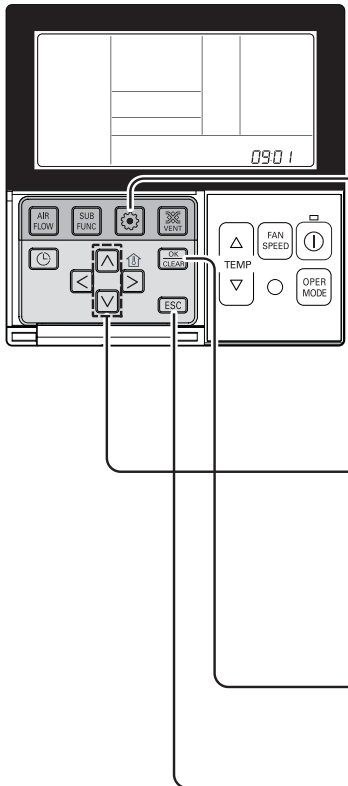
Dry contact function is the function that is possible to use only when dry contact equipment is separately purchased/setup.





- If pressing  button long for 3 seconds, it enters into remote controller setter setup mode.  
- If pressing once shortly, it enters into user setup mode. Please press more than 3 seconds for sure.

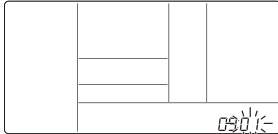

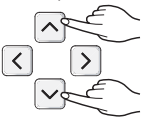

- If pressing  button repeatedly, it moves to remote controller dry contact mode setup menu as picture below.

- Select Dry contact setting by pressing button.  
(00 : Automatic, 01 : manual)



Function Code      Dry Contact setting value

- Press  button to save.



- Pressing  button will exit settings mode.  
\* After setup, it automatically gets out of setup mode if there is no button input for 25 seconds.  
\* When exiting without pressing set button, the manipulated value is not reflected.

### ► What is Dry Contact?

Like hotel card key and body perception sensor, it is the signal of the point of contact when using air-conditioner by interlocking.

- Please refer to dry contact manual for more details.

# Installer Setting - Option Function Setting

Setting feature for indoor unit when Air cleaning / Heater / Dehumidifier / Up/down grill / Ventilation KIT is newly installed, or installed unit is removed.

**1** If pressing button long for 3 seconds, it enters into remote controller setter setup mode.  
- If pressing once shortly, it enters into user setup mode. Please press more than 3 seconds for sure.

**2** If pressing button repeatedly, it moves to the selected option function code as picture below.

Function	Code
Plasma purification	20
Electric heater	21
Dehumidifier	22
Elevation grill	23
Ventilation kit	24

**3** Select existing condition of each mode by pressing button.  
(00: not installed, 01 : installed)

20:01

Function Code      Existing condition

**4** Press button to save.

**5** Pressing button will exit settings mode.  
\* After setup, it automatically gets out of setup mode if there is no button input for 25 seconds.  
\* When exiting without pressing set button, the manipulated value is not reflected.

### Wired remote controller operation

- 1) Setting data of sub-function as Air cleaning / Heater / Dehumidifier / Up/down grill / Ventilation is stored in remote controller EEPROM and recallable even if initializing.
- 2) The function can be not setup in remote controller but still available in indoor unit.

### ■ PI485 Installation Place

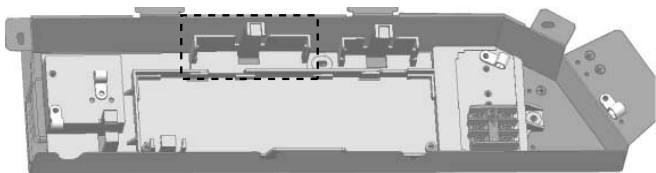

## Installation guide at the seaside



### CAUTION:

1. Air conditioners should not be installed in areas where corrosive gases, such as acid or alkaline gas, are produced.
2. Do not install the product where it could be exposed to sea wind (salty wind) directly. It can result corrosion on the product. Corrosion, particularly on the condenser and evaporator fins, could cause product malfunction or inefficient performance.
3. If outdoor unit is installed close to the seaside, it should avoid direct exposure to the sea wind. Otherwise it needs additional anticorrosion treatment on the heat exchanger.

### Selecting the location(Outdoor Unit)

- 1) If the outdoor unit is to be installed close to the seaside, direct exposure to the sea wind should be avoided. Install the outdoor unit on the opposite side of the sea wind direction.

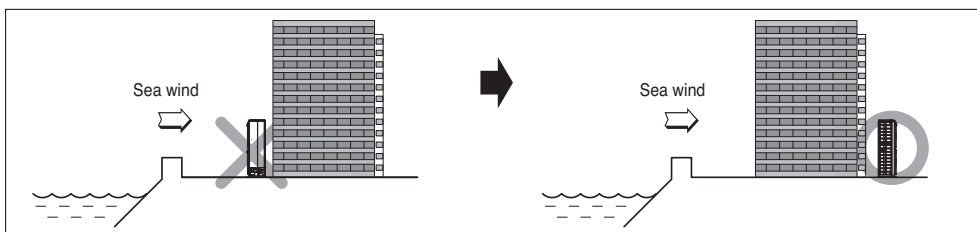

- 2) In case, to install the outdoor unit on the seaside, set up a windbreak not to be exposed to the sea wind.

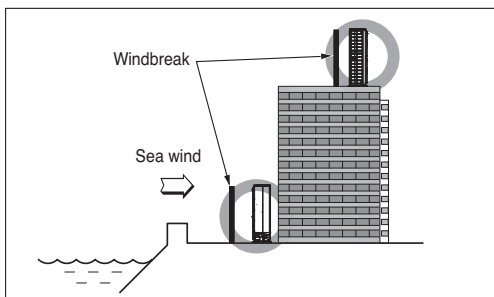

- It should be strong enough like concrete to prevent the sea wind from the sea.
- The height and width should be more than 150% of the outdoor unit.
- It should be keep more than 70 cm of space between outdoor unit and the windbreak for easy air flow.

- 3) Select a well-drained place.

- Periodic ( more than once/year ) cleaning of the dust or salt particles stuck on the heat exchanger by using water

