

INSTALLATION MANUAL

AIR CONDITIONER

- Please read this installation manual completely before installing the product.
- Installation work must be performed in accordance with the national wiring standards by authorized personnel only.
- Please retain this installation manual for future reference after reading it thoroughly.

TYPE : CEILING CASSETTE

**Model : LT-H282PLE0, LT-H332NLE0, LT-H452MLE0
LT-H512MLE0, LT-C282PLE0, LT-C332NLE0
LT-C452MLE0, LT-C512MLE0, LT-C48BMLE0
LT-C52BMLE0**



P/NO : MFL42291417

www.lg.com

TIPS FOR SAVING ENERGY

Here are some tips that will help you minimize the power consumption when you use the air conditioner. You can use your air conditioner more efficiently by referring to the instructions below:

- Do not cool excessively indoors. This may be harmful for your health and may consume more electricity.
- Block sunlight with blinds or curtains while you are operating the air conditioner.
- Keep doors or windows closed tightly while you are operating the air conditioner.
- Adjust the direction of the air flow vertically or horizontally to circulate indoor air.
- Speed up the fan to cool or warm indoor air quickly, in a short period of time.
- Open windows regularly for ventilation as the indoor air quality may deteriorate if the air conditioner is used for many hours.
- Clean the air filter once every 2 weeks. Dust and impurities collected in the air filter may block the air flow or weaken the cooling / dehumidifying functions.

For your records

Staple your receipt to this page in case you need it to prove the date of purchase or for warranty purposes. Write the model number and the serial number here:

Model number : _____

Serial number : _____

You can find them on a label on the side of each unit.

Dealer's name : _____

Date of purchase : _____

IMPORTANT SAFETY INSTRUCTIONS

READ ALL INSTRUCTIONS BEFORE USING THE APPLIANCE.

Always comply with the following precautions to avoid dangerous situations and ensure peak performance of your product

WARNING

It can result in serious injury or death when the directions are ignored

CAUTION

It can result in minor injury or product damage when the directions are ignored

WARNING

- Installation or repairs made by unqualified persons can result in hazards to you and others.
- Installation **MUST** conform with local building codes or, in the absence of local codes, with the Nation Electrical Code NFPA 70/ANSI C1-1003 or current edition and Canadian Electrical Code Part1 CSA C.22.1.
- The information contained in the manual is intended for use by a qualified service technician familiar with safety procedures and equipped with the proper tools and test instruments.
- Failure to carefully read and follow all instructions in this manual can result in equipment mal-function, property damage, personal injury and/or death.

Installation

- Do not use a defective or underrated circuit breaker. Use this appliance on a dedicated circuit.
 - There is risk of fire or electric shock.
- For electrical work, contact the dealer, seller, a qualified electrician, or an Authorized Service Center.
 - Do not disassemble or repair the product. There is risk of fire or electric shock.
- Always ground the product.
 - There is risk of fire or electric shock.
- Install the panel and the cover of control box securely.
 - There is risk of fire or electric shock.
- Always install a dedicated circuit and breaker.
 - Improper wiring or installation may cause fire or electric shock.
- Use the correctly rated breaker or fuse.
 - There is risk of fire or electric shock.
- Do not modify or extend the power cable.
 - There is risk of fire or electric shock.
- Do not let the air conditioner run for a long time when the humidity is very high and a door or a window is left open.
 - Moisture may condense and wet or damage furniture.
- Be cautious when unpacking and installing the product.
 - Sharp edges could cause injury. Be especially careful of the case edges and the fins on the condenser and evaporator.
- For installation, always contact the dealer or an Authorized Service Center.
 - There is risk of fire, electric shock, explosion, or injury.

4 SAFETY PRECAUTIONS

- Do not install the product on a defective installation stand.
 - It may cause injury, accident, or damage to the product.
- Be sure the installation area does not deteriorate with age.
 - If the base collapses, the air conditioner could fall with it, causing property damage, product failure, and personal injury.
- Use a vacuum pump or Inert (nitrogen) gas when doing leakage test or air purge. Do not compress air or Oxygen and Do not use Flammable gases. Otherwise, it may cause fire or explosion.
 - There is the risk of death, injury, fire or explosion.

Operation

- Do not store or use flammable gas or combustibles near the product.
 - There is risk of fire or failure of product.



CAUTION

Installation

- Always check for gas (refrigerant) leakage after installation or repair of product.
 - Low refrigerant levels may cause failure of product.
- Install the drain hose to ensure that water is drained away properly.
 - A bad connection may cause water leakage.
- Keep level even when installing the product.
 - To avoid vibration or water leakage.
- Do not install the product where the noise or hot air from the outdoor unit could damage the neighborhoods.
 - It may cause a problem for your neighbors.
- Use two or more people to lift and transport the product.
 - Avoid personal injury.
- Do not install the product where it will be exposed to sea wind (salt spray) directly.
 - It may cause corrosion on the product. Corrosion, particularly on the condenser and evaporator fins, could cause product malfunction or inefficient operation.

TABLE OF CONTENTS

6 INTRODUCTION

6 Features

7 INSTALLATION

7 Installation Tools
8 Installation of Indoor, Outdoor Unit
13 Remote Control Preparation
14 Wiring Connection
17 Connecting Pipes to the Indoor Unit
19 Installation of Decorative Panel
21 Indoor Unit Drain Piping
24 Air Purging
26 Test running
28 Installation guide at the seaside





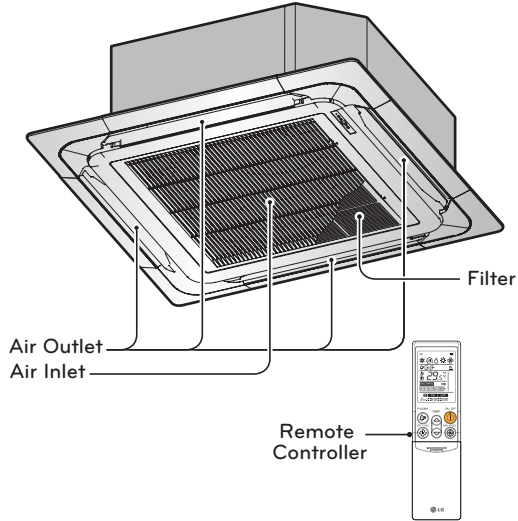



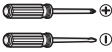

INTRODUCTION

Features

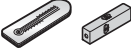
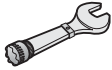

INSTALLATION

Installation Tools

Figure	Name	Figure	Name
	Screw driver		Ohmmeter
	Electric drill		Hexagonal wrench
	Measuring tape, Knife		Ammeter
	Hole core drill		Gas-leak detector
	Spanner		Thermometer, Horizontal meter
	Torque wrench		Flaring tool set
	Manifold gauges		Vacuum pump

Installation of Indoor, Outdoor Unit

Selection of the best location

Indoor unit

- There should not be any heat source or steam near the unit.
- There should not be any obstacles to prevent the air circulation.
- A place where air circulation in the room will be good.
- A place where drainage can be easily obtained.
- A place where noise prevention is taken into consideration.
- Do not install the unit near the door way.
- Ensure the spaces indicated by arrows from the wall, ceiling, or other obstacles.
- The indoor unit must keep the maintenance space.

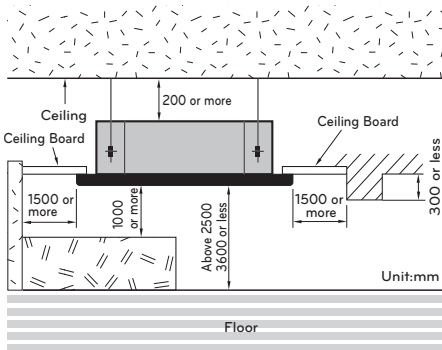

Outdoor unit

- If an awning is built over the unit to prevent direct sunlight or rain exposure, be careful that heat radiation from the condenser is not restricted.
- There should not be any animals or plants which could be affected by hot air discharged.
- Ensure the spaces indicated by arrows from the wall, ceiling, fence or other obstacles.

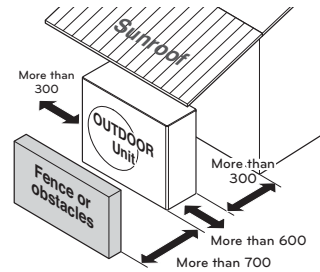

Unit : mm

- * Please use an annexed sheet or the corrugated cardboard on the bottom of packing as installation sheet.



Annexed sheet

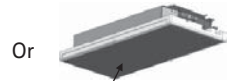

Or

Packing corrugated cardboard on the bottom

- When using the bottom sheet, please use it after separating the installation sheet from packing of the product floor by using a knife etc as a picture below.

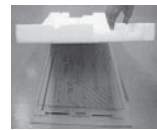

Piping length and the elevation

Model	Pipe Size mm(inch)		Length A(m)		Elevation B(m)		*Additional refrigerant (g/m)
	Gas	Liquid	Standard	Max.	Standard	Max.	
LT-H282PLE0	15.88(5/8")	6.35(1/4")	7.5	50	5	30	25
LT-H332NLE0	15.88(5/8")	6.35(1/4")	7.5	50	5	30	45
LT-H452MLE0	19.05(3/4")	9.52(3/8")	7.5	50	5	30	45
LT-H512MLE0	19.05(3/4")	9.52(3/8")	7.5	50	5	30	50
LT-C282PLE0	15.88(5/8")	6.35(1/4")	7.5	50	5	30	30
LT-C332NLE0	15.88(5/8")	6.35(1/4")	7.5	50	5	30	30
LT-C452MLE0	19.05(3/4")	9.52(3/8")	7.5	50	5	30	55
LT-C512MLE0	19.05(3/4")	9.52(3/8")	7.5	50	5	30	55
LT-C48BMLE0	19.05(3/4")	9.52(3/8")	7.5	50	5	30	50
LT-C52BMLE0	19.05(3/4")	9.52(3/8")	7.5	50	5	30	50

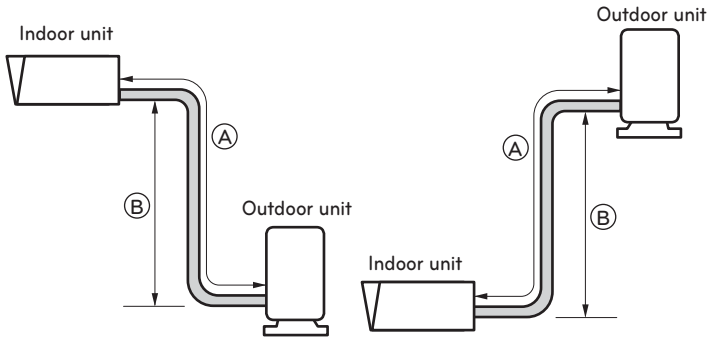

CAUTION

- Rated performance for refrigerant line length of:7.5m
- Capacity is based on standard length and maximum allowance length is on the basis of reliability.
- Improper refrigerant charge may result in abnormal cycle.

Ceiling opening dimensions and hanging bolt location

- The dimensions of the paper model for installing are the same as those of the ceiling opening dimensions.
- Select and mark the position for fixing bolts and piping hole.
- Decide the position for fixing bolts slightly tilted to the drain direction after considering the direction of drain hose.
- Drill the hole for anchor bolt on the ceiling.
- The hole size for four anchor bolts is $\varnothing 14.5\text{mm}$ & 40mm depth.

CAUTION

- This air-conditioner uses a drain pump.
- Horizontally install the unit using a level gauge.
- During the installation, care should be taken not to damage electric wires.

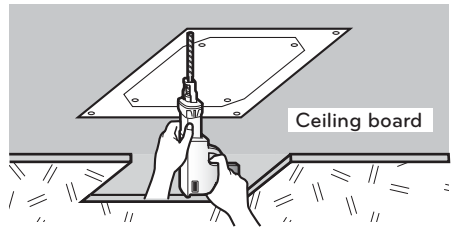
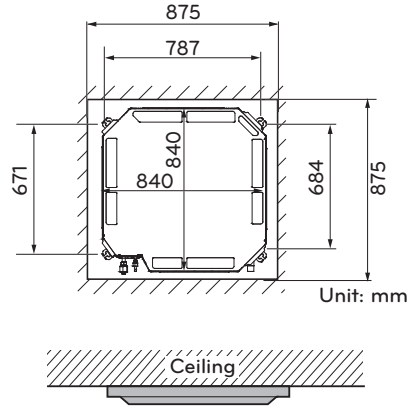

! NOTE

Thoroughly study the following installation locations:

- 1 In such places as restaurants and kitchens, considerable amount of oil steam and flour adhere to the turbo fan, the fin of the heat exchanger and the drain pump, resulting in heat exchange reduction, spraying, dispersing of water drops, drain pump malfunction, etc. In these cases, take the following actions:
 - Make sure that the ventilation fan for smoke-collecting hood on a cooking table has sufficient capacity so that it draws oily steam which should not flow into the suction of the air conditioner.
 - Make enough distance from a cooking room to install the air conditioner in such a place where it may not suck in oily steam.

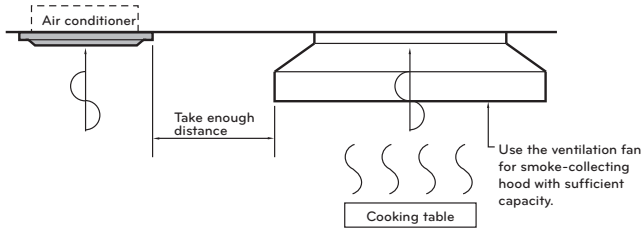

- 2 Avoid installing air conditioner in such circumstances where cutting oil mist or iron powder is in suspension in factories, etc.
- 3 Avoid places where inflammable gas is generated, flows in, is stored or vented.
- 4 Avoid places where sulfurous acid gas or corrosive gas is generated.
- 5 Avoid places near high frequency generators.

The Indoor Unit Installation

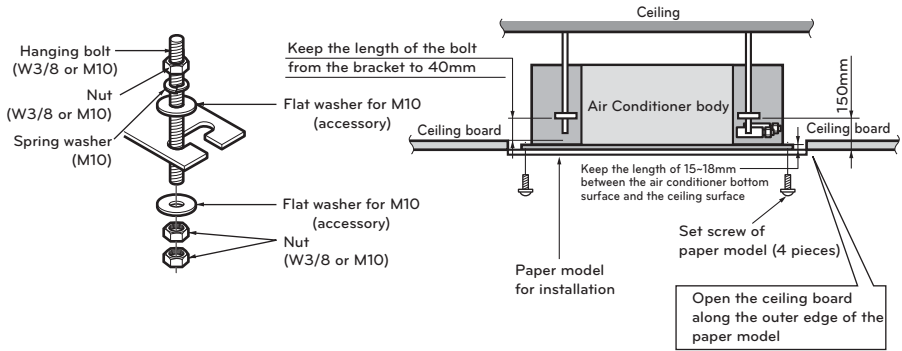

The following parts is option.

- ① Hanging Bolt - W 3/8 or M10
- ② Nut - W 3/8 or M10
- ③ Spring Washer - M10
- ④ Plate Washer - M10

Drill the piping hole on the wall slightly tilted to the outdoor side using a $\varnothing 65$ hole-core drill.

CAUTION

Tighten the nut and bolt to prevent unit falling.

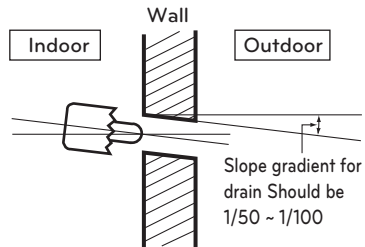

Remote Controller Installation

Although the room temperature sensor is in the indoor unit, the remote controller should be installed in such places away from direct sunlight and high humidity.

Installation of the remote controller

- Select places that are not splashed with water.
- Select control position after receiving customer approval.
- The room temperature sensor is built in the indoor unit.
- This remote controller equipped with liquid crystal display. If this position is higher or lower, display is difficult to see. (The standard height is 1.2 ~ 1.5m high)

Routing of the remote controller cord

- Keep the remote controller cord away from the refrigerant piping and the drain piping.
- To protect the remote controller cord from electrical noise, place the cord at least 5cm away from other power cables (audio equipment, television set, etc.)
- If the remote controller cord is secured to the wall, provide a trap at the top of the cord to prevent water droplets from running.

Remote Control Preparation

HOW TO MOUNT ONTO A WALL

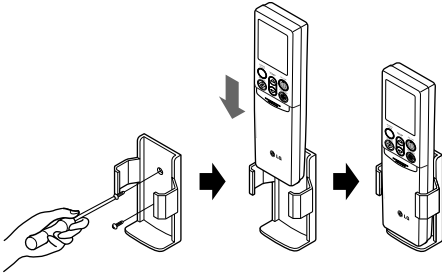

HOW TO INSERT BATTERIES

- 1 Remove the battery cover from the remote controller.
 - Slide the cover according to the arrow direction.
- 2 Insert the two batteries.
 - Be sure that the (+) and (-) directions are correct.
 - Be sure that both batteries are new.
- 3 Re-attach the cover.
 - Slide it back into position.

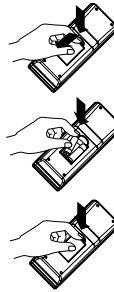

- Do not use rechargeable batteries, such batteries differ from standard dry cells in shape, dimensions, and performance.
- Remove the batteries from the remote controller if the air conditioner is not going to be used for some long time.

Wiring Connection

- Open the control box cover and connect the Remote controller cord and Indoor power wires.

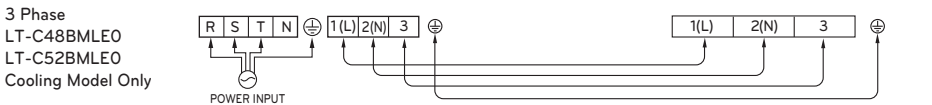
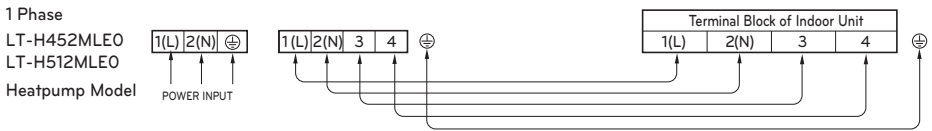
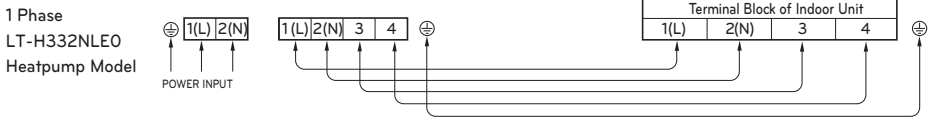
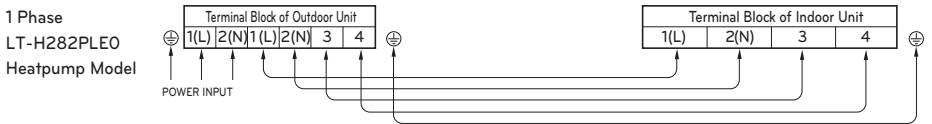
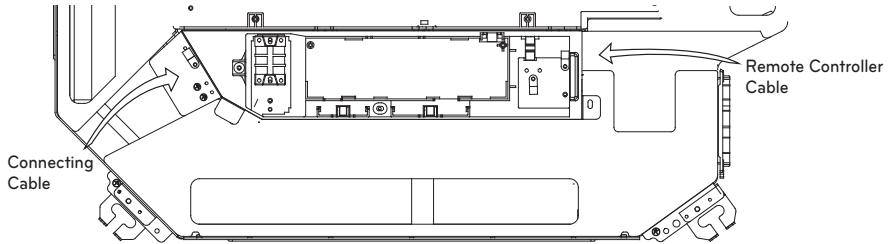

CAUTION

The power cord connected to the outdoor unit should be complied with the following specifications (Rubber insulation, type H05RN-F approved by HAR or SAA).

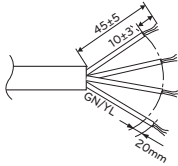

Model	Normal Cross-Sectional
LT-H282PLE0	3.5mm ² (3 wires)
LT-H332NLE0	5.5mm ² (3 wires)
LT-H452MLE0 LT-H512MLE0	6.5mm ² (3 wires)
LT-C282PLE0 LT-C332NLE0	3.5mm ² (3 wires)
LT-C452MLE0 LT-C512MLE0	6.5mm ² (3 wires)
LT-C48BMLE0 LT-C52BMLE0	3.5mm ² (4 wires)

The connecting cable connected to the indoor and outdoor unit should be complied with the following specifications (Rubber insulation, type H05RN-F approved by HAR or SAA).

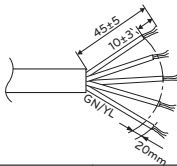

Model	Normal Cross-Sectional
LT-H282PLE0 LT-H332NLE0	0.75mm ² (5 wires)
LT-H452MLE0 LT-H512MLE0	1.0mm ² (5 wires)
LT-C282PLE0 LT-C332NLE0	0.75mm ² (4 wires)
LT-C452MLE0 LT-C512MLE0 LT-C48BMLE0 LT-C52BMLE0	1.0mm ² (4 wires)

If the supply cord is damaged, it must be replaced by a special cord or assembly available from the manufacturer or its service agent.

WARNING

Make sure that the screws of the terminal are free from looseness.

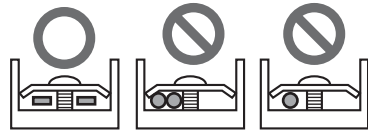
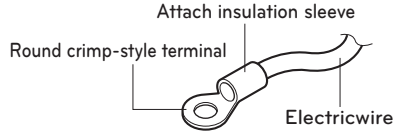

Connect wires of the same gauge to both sides

ELECTRICAL WIRING

- 1 All wiring must comply with LOCAL REGULATIONS.
- 2 Select a power source that is capable of supplying the current required by the air conditioner.
- 3 Feed the power source to the unit via a distribution switch board designed for this purpose.
- 4 The terminal screws inside the control box may be loose due to vibration during transport. Check the screws for loose connection. (Running the air conditioner with loose connection can overload and damage electrical components.)
- 5 Always ground the air conditioner with a grounding wire and connector to meet the LOCAL REGULATION.

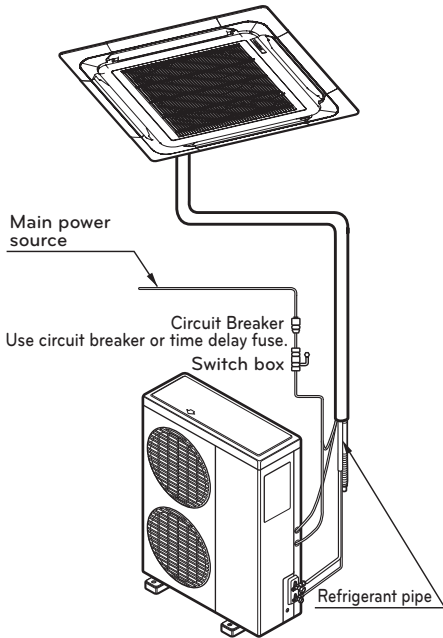

CONNECTING THE CABLE TO OUTDOOR UNIT

- 1 Remove the Cover control from the unit by loosening a screw. Connect the wires to the terminals on the control board individually as following.
- 2 Secure the cable onto the control board with the holder (clamper).
- 3 Refix the cover control to the original position with the screw.
- 4 Use a recognized circuit breaker between the power source and the unit. a disconnecting device to adequately disconnect all supply lines must be fitted.

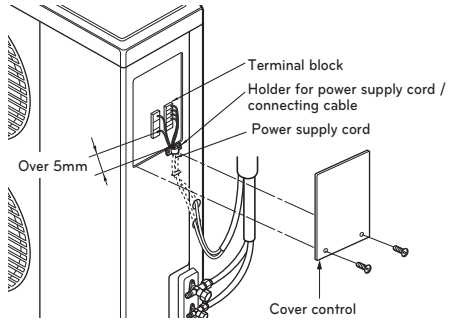

Model	Circuit Breaker (A)
LT-H282PLE0 LT-H332NLE0	30
LT-H452MLE0 LT-H512MLE0	50
LT-C282PLE0 LT-C332NLE0	30
LT-C452MLE0 LT-C512MLE0	50
LT-C48BMLE0 LT-C52BMLE0	50

Connecting Pipes to the Indoor Unit - Preparation of Piping

Main cause of gas leakage is defect in flaring work. Carry out correct flaring work in the following procedure.

Cut the pipes and the cable.

- Use the accessory piping kit or the pipes purchased locally.
- Measure the distance between the indoor and the outdoor unit.
- Cut the pipes a little longer than measured distance.
- Cut the cable 1.5m longer than the pipe length.

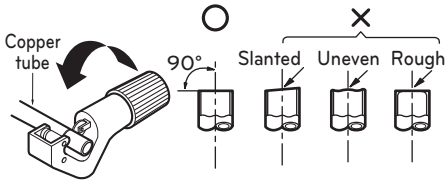

Burrs removal

- Completely remove all burrs from the cut cross section of pipe/tube.
- Put the end of the copper tube/pipe to downward direction as you remove burrs in order to avoid to let burrs drop in the tubing.

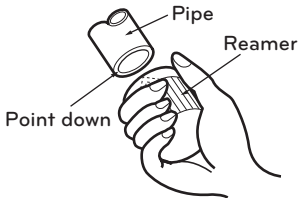

Putting nut on

- Remove flare nuts attached to indoor and outdoor units, then put them on pipe/tube having completed burr removal. (Not possible to put them on after flaring work)

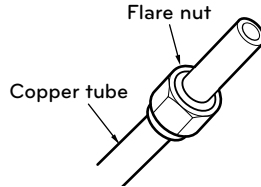

Flaring work

- Carry out flaring work using flaring tool as shown below.

Outside diameter		A
mm	inch	mm
Ø6.35	1/4	1.1~1.3
Ø9.52	3/8	1.5~1.7
Ø12.7	1/2	1.6~1.8
Ø15.88	5/8	1.6~1.8
Ø19.05	3/4	1.9~2.1

Firmly hold copper tube in a bar(or die) as indicated dimension in the table above.

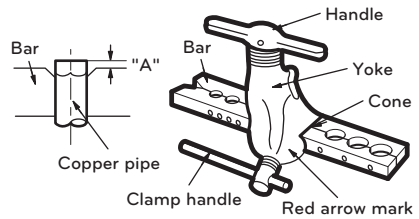

Check

- *Compare the flared work with figure below.
- *If flare is noted to be defective, cut off the flared section and do flaring work again.
- If the piping and the drain hose are in common direction bundle the piping and the drain hose together by wrapping them with vinyl tape.

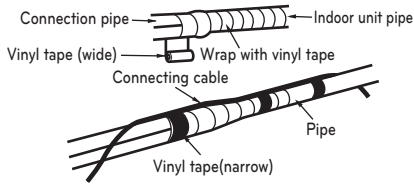
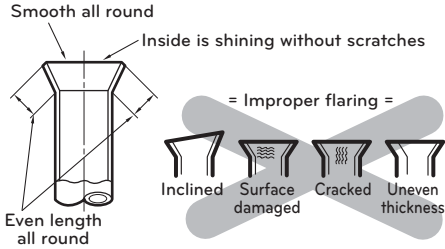

Piping Connection

- Form the piping according to its routing. Avoid bending and bending back the same piping point more than three times. (This will result in hardening the pipe.)
- After deforming the piping, align centers of the union fitting of the indoor unit and the piping, and tighten them firmly with wrenches.
- Connect pipe to the service valve or ball valve which is located below the outdoor unit.
- After completing the piping connection, be sure to check if there is gas leakage in indoor and outdoor connection.

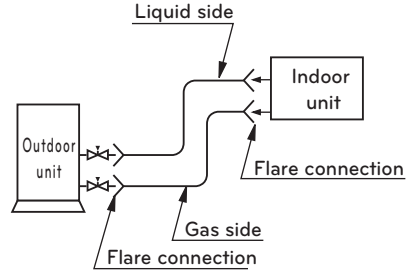

CAUTION

Use two wrenches and tighten with regular torque.

Flare nut fastening torque	
Ø6.35mm	1.8~2.5 kgf.m
Ø9.52mm	3.4~4.2 kgf.m
Ø12.7mm	5.5~6.6 kgf.m
Ø15.88mm	6.3~8.2 kgf.m
Ø19.05mm	9.9~12.1 kgf.m

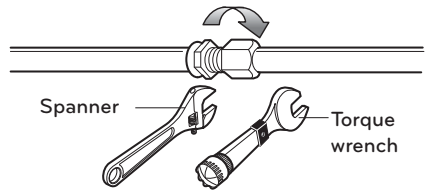

Vacuum drying

After completing the piping connection, execute vacuum drying for the connecting piping and the indoor unit.

The vacuum drying must be carried out using the service ports of both the liquid and gas side valves.

Installation of Decorative Panel

The decorative panel has its installation direction.
 Before installing the decorative panel, always remove the paper template.

- 1 Remove the packing and take out air inlet grille from front panel.

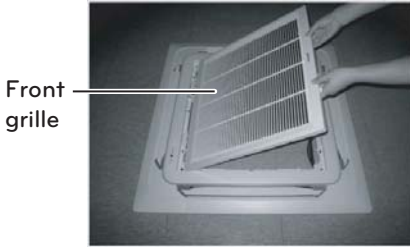

- 2 Remove the Corner covers of the panel.

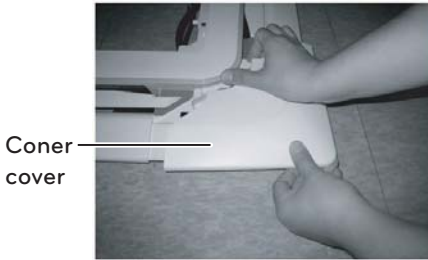

- 3 Fit the panel on the unit by inserting hooks as shown in picture.

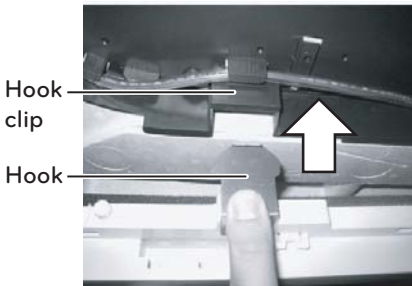

- 4 Insert two screws on diagonal corners of panel. Do not tighten the bolts completely. (The fixing screws are included in the indoor unit box.)
 Check the alignment of panel with the ceiling. Height can be adjusted using hanging bolts as shown in picture. Insert the other two screws and tighten all screws completely.

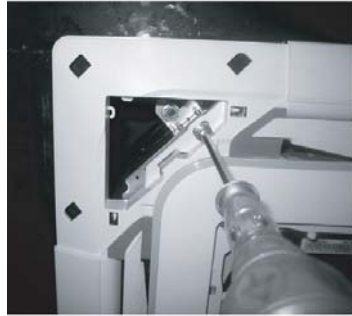

- 5 Fit the corner covers.

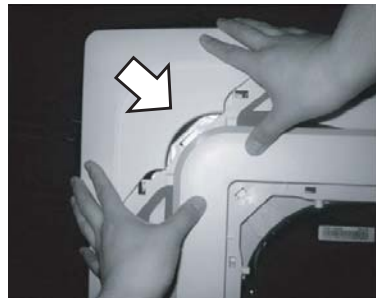

20 INSTALLATION

- 6 Open two screws of control panel cover.

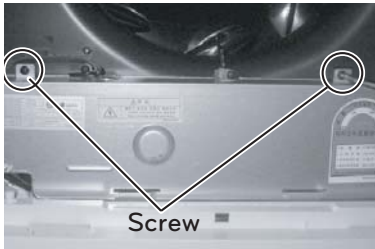

- 7 Connect one display connector and two vane control connectors of front panel to indoor unit PCB.

The position marking on PCB is as:

Display connector : CN-DISPLAY

Vane control connector: CN-VANE 1,2

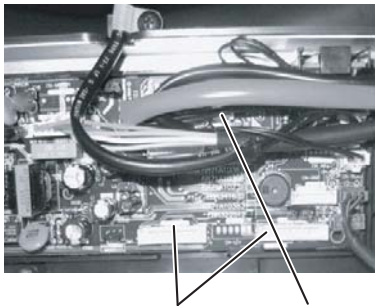

CN VANE 1,2 CN DISPLAY

- 8 Close the cover for control box.



- 9 Fit the link on the panel as shown in picture. (The link is included in the front panel unit box.)

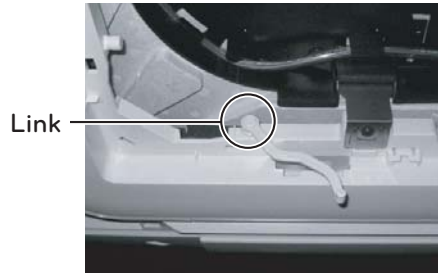

- 10 Attach the other side of link on the filter guide of inlet grille. Install the air inlet grille and filter on the panel.

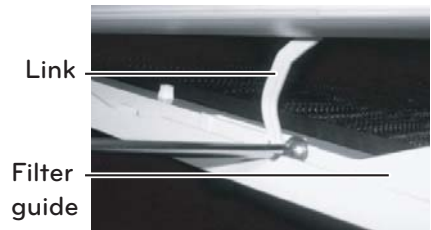

CAUTION

Install certainly the decorative panel.
Cool air leakage causes sweating. ↪
Water drops fall.

Good example

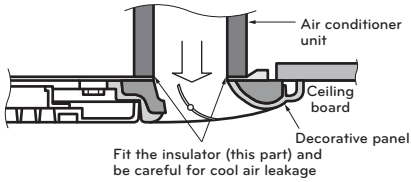

Bad example

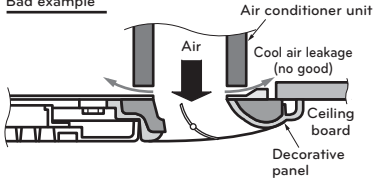

Indoor Unit Drain Piping

- Drain piping must have down-slope (1/50 to 1/100): be sure not to provide up-and-down slope to prevent reversal flow.
- During drain piping connection, be careful not to exert extra force on the drain port on the indoor unit.
- The outside diameter of the drain connection on the indoor unit is 32mm.

Piping material: Polyvinyl chloride pipe VP-25 and pipe fittings

- Be sure to execute heat insulation on the drain piping.

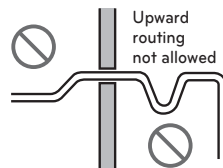
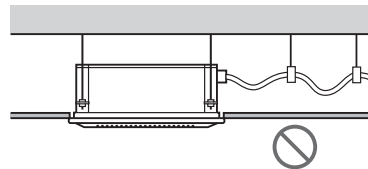
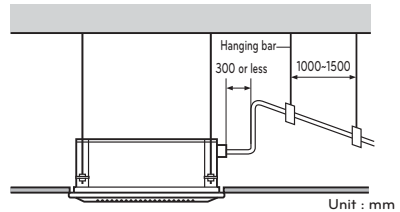
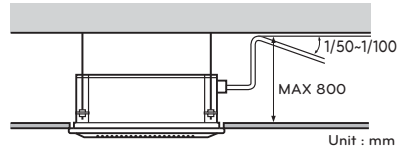

Heat insulation material: Polyethylene foam with thickness more than 8 mm.

Drain test

The air conditioner uses a drain pump to drain water.

Use the following procedure to test the drain pump operation:

- Connect the main drain pipe to the exterior and leave it provisionally until the test comes to an end.
- Feed water to the flexible drain hose and check the piping for leakage.
- Be sure to check the drain pump for normal operating and noise when electrical wiring is complete.
- When the test is complete, connect the flexible drain hose to the drain port on the indoor unit.

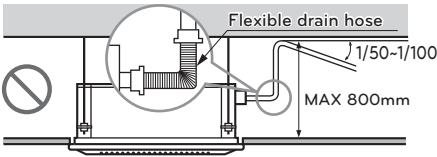
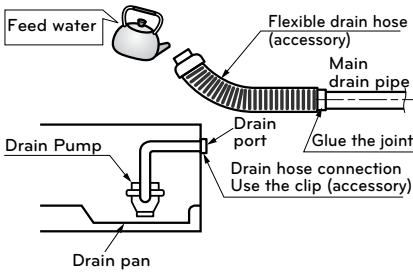

CAUTION

The supplied flexible drain hose should not be curved, neither screwed. The curved or screwed hose may cause a leakage of water.

HEAT INSULATION

- Use the heat insulation material for the refrigerant piping which has an excellent heat-resistance (over 120°C).
- Precautions in high humidity circumstance: This air conditioner has been tested according to the "KS Standard Conditions with Mist" and confirmed that there is not any default. However, if it is operated for a long time in high humid atmosphere (dew point temperature: more than 23°C), water drops are liable to fall. In this case, add heat insulation material according to the following procedure:

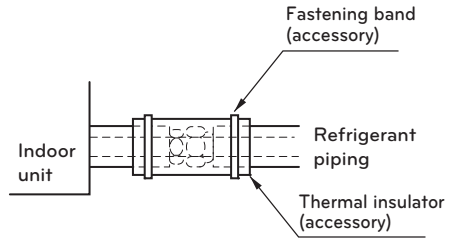

- Heat insulation material to be prepared... Adiabatic EPDM or NBR with thickness 10 to 20mm.
- Stick EPDM or NBR on all air conditioners that are located in ceiling atmosphere.
- In addition to the normal heat insulation (thickness: more than 8mm) for refrigerant piping (gas piping: thick piping) and drain piping, add further 10mm to 30mm thickness material.

Form the pipings

- 1 Wrap the connecting portion of indoor unit with the Insulation material and secure it with two Plastic Bands. (for the right pipings)
 - If you want to connect an additional drain hose, the end of the drain-outlet should keep distance from the ground. (Do not dip it into water, and fix it on the wall to avoid swinging in the wind.)

In case of the Outdoor unit being installed below position of the Indoor unit.

- 2 Tape the Pipings, drain hose and Connecting Cable from bottom to top.
- 3 Form the pipings gathered by taping along the exterior wall and fix it onto the wall by saddle or equivalent.

Seal a small opening around the pipings with gum type sealant.

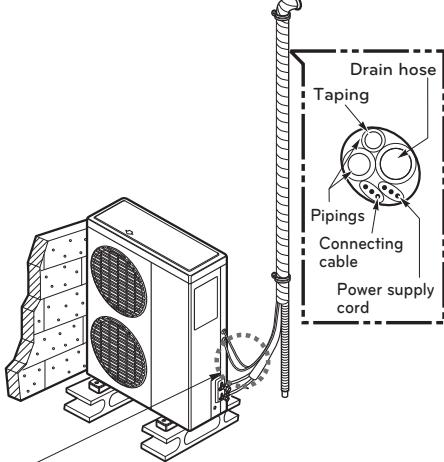

- Trap is required to prevent water from entering into electrical parts.

In case of the Outdoor Unit being installed above position of the Indoor Unit.

- 4 Tape the Pipings and Connecting cable from bottom to top.
- 5 Form the pipings gathered by taping along the exterior wall, and make the trap prevent water from entering into the room.
- 6 Fix the pipings onto the wall by saddle or equivalent

Seal a small opening around the pipings with gum type sealant.

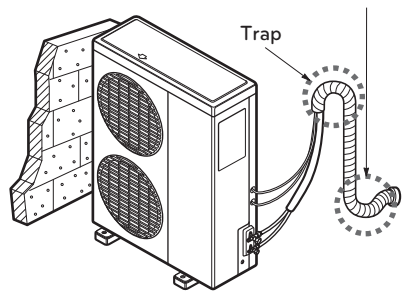

Air Purging

Air purging

The air and moisture remaining in the refrigerant system have undesirable effects as indicated below.

- Pressure in the system rises.
- Operating current rises.
- Cooling(or heating) efficiency drops.
- Moisture in the refrigerant circuit may freeze and block capillary tubing.
- Water may lead to corrosion of parts in the refrigeration system.

Therefore, after evacuating the system, take a leak test for the piping and tubing between the indoor and outdoor unit.

Air purging with vacuum pump

- Check that both liquid and gas pipe between indoor and outdoor have been properly connected.
- Remove the service valve cap from both the gas and liquid side on the outdoor unit.
- Confirm that both the liquid and gas side valve are set to the closed position.
- Connect the manifold valve(with pressure gauge) to the gas pipe side.

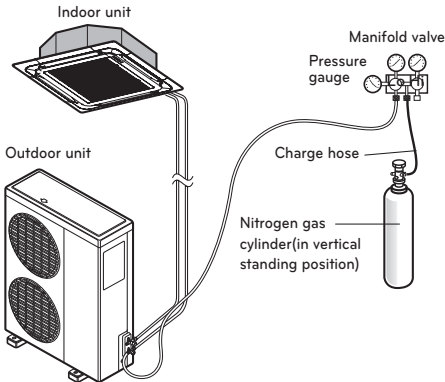

CAUTION

Be sure to use a manifold valve for air purging. If it is not available, use a stop valve for this purpose. The "Hi" knob of the manifold valve must always be kept close.

- And connect the Nitrogen cylinder to the service port with charge hoses to the manifold gauge.
- Pressurize the system to no more than 150 P.S.I.G with dry nitrogen gas. Close the nitrogen cylinder valve when it shows reading of 150 P.S.I.G.

CAUTION

To avoid nitrogen entering the refrigerant system in a liquid state, the top of the cylinder must be higher than its bottom when you pressurize the system. Usually, the cylinder is used in a vertical standing position.

- Check for leakage with Liquid soap solution. Do the leakage test at all joints of tubing (indoor and outdoor) and on the service valve (both gas and liquid side).

Soap water method

- Remove the caps from the 3-way(#1) and 3-way(#2) valves.
- Remove the service-port cap from the 3-way(#2) valve.
- To open the 3-way(#1) valve turn the valve stem counterclockwise approximately 90°, wait for about 2~3 sec, and close it.
- Apply a soap water or a liquid neutral detergent on the indoor unit connection or outdoor unit connections by a soft brush to check for leakage of the connecting points of the piping.
- If bubbles come out, the pipes have leakage

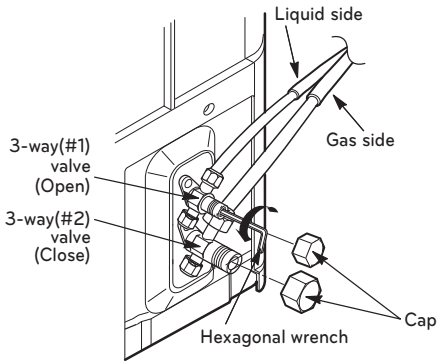
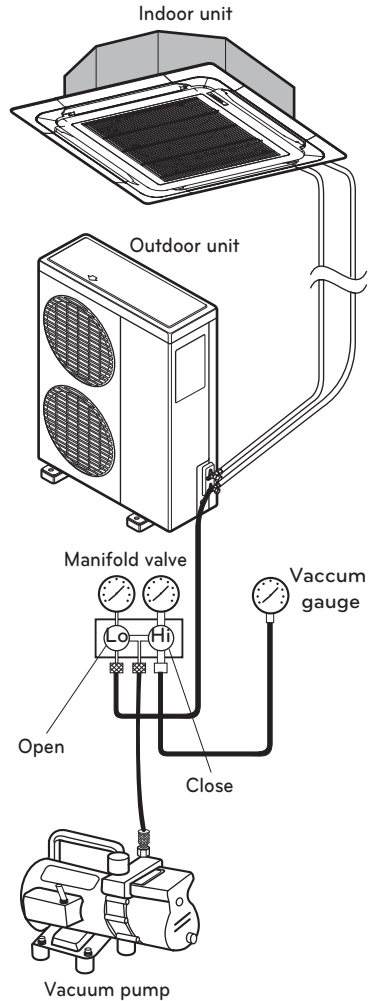

Evacuation

- If the system is found free from all leakages, relieve the nitrogen pressure by loosening the charge hose connector at nitrogen cylinder. Disconnect the hose from cylinder when pressure reaches to normal state.
 - Evacuation: Connect the charge hose end to the vacuum pump and evacuate the connecting of the and indoor unit. Check that the "Lo" knob of manifold is open. Run the vacuum pump. Confirm the "Lo" knob of the manifold valve is open. Then, run the vacuum pump. The operation time for evacuation varies with tubing length and capacity of the pump. The degree of vacuum should be under 0.8 Torr.
- When the desired vacuum is reached, close the "Lo" knob of the manifold valve and stop the vacuum pump.

- Once the desired vacuum is created. Disconnect the vacuum pump and open the liquid side valve stem by turning it to counter-clockwise direction with service valve wrench.
- Open completely the gas side valve by turning to counter-clockwise with service valve wrench.
- Remove slowly the charge hose connected to the gas side service port (to release the pressure).
- Replace back the flare nut and its bonnet on the gas side service port. Fasten the flare nut with adjustable wrench to prevent any leakage from the system.
- Fasten back the valve cap on both gas and liquid side service valves.

Test running

PRECAUTIONS IN TEST RUN

- The initial power supply must provide at least 90% of the rated voltage. Otherwise, the air conditioner should not be operated.



CAUTION

- For test run, carry out the cooling operation firstly even during heating season. If heating operation is carried out firstly, it leads to the trouble of compressor. Then attention must be paid.
- Carry out the test run more than 5 minutes without fail. (Test run will be cancelled 18 minutes later automatically)

- The test run is started by pressing the room temperature checking button and down timer button for 3 seconds at the same time.
- To cancel the test run, press any button.

CHECK THE FOLLOWING ITEMS WHEN INSTALLATION IS COMPLETED

- After completing work, be sure to measure and record trial run properties, and store measured data, etc.
- Measuring items are room temperature, outside temperature, suction temperature, blow out temperature, wind velocity, wind volume, voltage, current, presence of abnormal vibration and noise, operating pressure, piping temperature, compressive pressure.
- As to the structure and appearance, check following items.
 - * Is the circulation of air adequate?
 - * Is the draining smooth?
 - * Is the heat insulation complete (refrigerant and drain piping)?
 - * Is there any leakage of refrigerant?
 - * Is the remote controller switch operated?
 - * Is there any faulty wiring?
 - * Are not terminal screws loosened?

M4.....118N.cm{12kgf.cm}
 M5.....196N.cm{20kgf.cm}
 M6.....245N.cm{25kgf.cm}
 M8.....588N.cm{60kgf.cm}

Connection of power supply

- Connect the power supply cord to the independent power supply. Circuit breaker is required.
- Operate the unit for 15 minutes or more.

Evaluation of the performance

- Measure the temperature of the intake and discharge air.
- Ensure the difference between the intake temperature and the discharge one is more than 8°C (Cooling) or reversely (Heating).

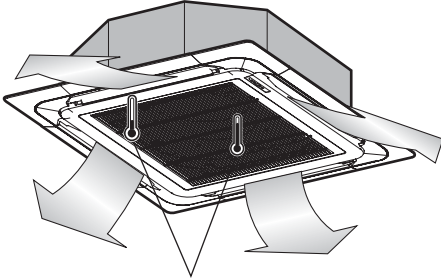

Thermometer

CAUTION

After the confirmation of the above conditions, prepare the wiring as follows:

- Never fail to have an individual power specialized for the air conditioner. As for the method of wiring, be guided by the circuit diagram pasted on the inside of control box cover.
- Provide a circuit breaker switch between power source and the unit.
- The screw which fasten the wiring in the casing of electrical fittings are liable to come loose from vibrations to which the unit is subjected during the course of transportation. Check them and make sure that they are all tightly fastened. (If they are loose, it could give rise to burn-out of the wires.)
- Specification of power source
- Confirm that electrical capacity is sufficient.
- Be sure that the starting voltage is maintained at more than 90 percent of the rated voltage marked on the name plate.

CAUTION

- Confirm that the cable thickness is as specified in the power sources specification. (Particularly note the relation between cable length and thickness.)
- Never fail to equip a leakage breaker where it is wet or moist.
- The following troubles would be caused by voltage drop-down.
Vibration of a magnetic switch, damage on the contact point there of, fuse breaking, disturbance to the normal function of a overload protection device.
Proper starting power is not given to the compressor.

NOTE**Setting the Ceiling Height Selection**

For more details refer to Owners Manual, whenever you want to set the Ceiling Height Selection.

HAND OVER

Teach the customer the operation and maintenance procedures, using the operation manual (air filter cleaning, temperature control, etc.).

Installation guide at the seaside

! CAUTION

- Air conditioners should not be installed in areas where corrosive gases, such as acid or alkaline gas, are produced.
- Do not install the product where it could be exposed to sea wind (salty wind) directly. It can result corrosion on the product. Corrosion, particularly on the condenser and evaporator fins, could cause product malfunction or inefficient performance.
- If outdoor unit is installed close to the seaside, it should avoid direct exposure to the sea wind. Otherwise it needs additional anticorrosion treatment on the heat exchanger.

Selecting the location(Outdoor Unit)

If the outdoor unit is to be installed close to the seaside, direct exposure to the sea wind should be avoided. Install the outdoor unit on the opposite side of the sea wind direction.

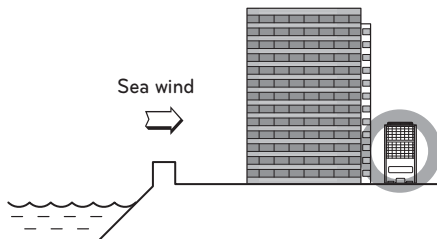
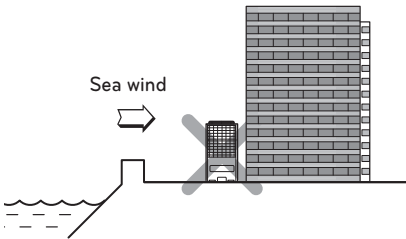

In case, to install the outdoor unit on the seaside, set up a windbreak not to be exposed to the sea wind.

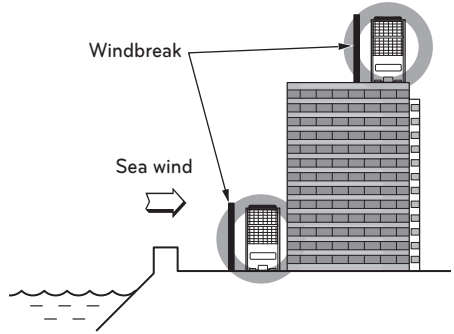

- It should be strong enough like concrete to prevent the sea wind from the sea.
- The height and width should be more than 150% of the outdoor unit.
- It should keep more than 70 cm of space between outdoor unit and the windbreak for easy air flow.

Select a well-drained place.

- If you can't meet above guide line in the seaside installation, please contact LG Electronics for the additional anticorrosion.
- Periodic (more than once/year) cleaning of the dust or salt particles stuck on the heat exchanger by using water

