

# INSTALLATION MANUAL

# AIR CONDITIONER

- Please read this installation manual completely before installing the product.
- Installation work must be performed in accordance with the national wiring standards by authorized personnel only.
- Please retain this installation manual for future reference after reading it thoroughly.

TYPE : Ceiling Cassette – 4Way



P/NO : MFL42803103

[www.lg.com](http://www.lg.com)

# TABLE OF CONTENTS

## Installation Requirements

## Required Parts

## Required Tools

Installation Parts .....3

Safety Precautions .....4





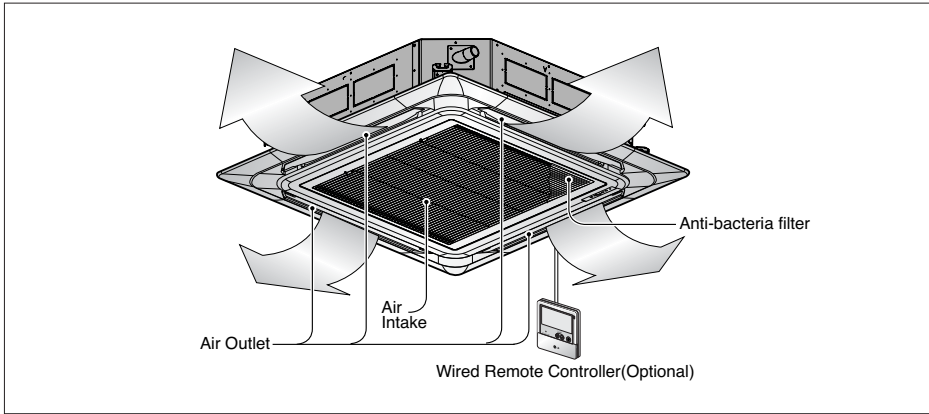

### Installation

Selection of the best location...7	<input type="checkbox"/> Installation guide map	<input type="checkbox"/> Level gauge
	<input type="checkbox"/> Four type "A" screws & plastic anchors	<input type="checkbox"/> Screw driver
	<input type="checkbox"/> Connecting cable	<input type="checkbox"/> Electric drill
Ceiling dimension and hanging bolt location .....8	<input type="checkbox"/> Pipes: Gas side	<input type="checkbox"/> Hole core drill
	Liquid side	<input type="checkbox"/> Horizontal meter
	(Refer to Product Data)	<input type="checkbox"/> Flaring tool set
Wiring Connection .....9	<input type="checkbox"/> Insulation materials	<input type="checkbox"/> Specified torque wrenches (different depending on model No.)
	<input type="checkbox"/> Additional drain pipe	<input type="checkbox"/> Spanner .....Half union
Installation of Decoration Panel.....11		
Drain Piping .....12		
Installation of Wired Remote Controller.....14		<input type="checkbox"/> Hexagonal wrench
		<input type="checkbox"/> Gas-leak detector
Name and function of wired remote controller(Accessory) .....16		<input type="checkbox"/> Vacuum pump
		<input type="checkbox"/> Gauge manifold
Dip Switch Setting .....17		
		<input type="checkbox"/> Owner's manual
Group Control Setting.....18		<input type="checkbox"/> Thermometer

# Installation Parts



## Standard Accessories

Name	Drain hose	Clamp metal	Washer for hanging bracket	Clamp (Tie Wrap)	Insulation for fitting	(Other)
Quantity	1 EA	2 EA	8 EA	4 EA	1 SET	
Shape					 for gas pipe  for liquid pipe	<ul style="list-style-type: none"> <li>• Paper pattern for installation</li> <li>• Owner's manual</li> <li>• Installation manual</li> </ul>

# Safety Precautions



To prevent injury to the user or other people and property damage, the following instructions must be followed.

- Be sure to read before installing the air conditioner.
- Be sure to observe the cautions specified here as they include important items related to safety.
- Incorrect operation due to ignoring instruction will cause harm or damage. The seriousness is classified by the following indications.

**⚠ WARNING** This symbol indicates the possibility of death or serious injury.

**⚠ CAUTION** This symbol indicates the possibility of injury or damage to properties only.

- Meanings of symbols used in this manual are as shown below.

	<b>Be sure not to do.</b>
	<b>Be sure to follow the instruction.</b>

## ⚠ WARNING

### ■ Installation

**Do not use a defective or underrated circuit breaker. Use this appliance on a dedicated circuit.**

- There is risk of fire or electric shock.



**For electrical work, contact the dealer, seller, a qualified electrician, or an Authorized Service Center.**

- Do not disassemble or repair the product. There is risk of fire or electric shock.



**Always ground the product.**

- There is risk of fire or electric shock.

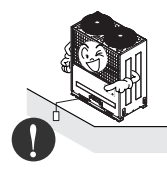

**Install the panel and the cover of control box securely.**

- There is risk of fire or electric shock.



**Always install a dedicated circuit and breaker.**

- Improper wiring or installation may cause fire or electric shock.



**Use the correctly rated breaker or fuse.**

- There is risk of fire or electric shock.



**Do not modify or extend the power cable.**

- There is risk of fire or electric shock.

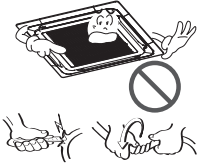

**Do not let the air conditioner run for a long time when the humidity is very high and a door or a window is left open.**

- Moisture may condense and wet or damage furniture.



**Be cautious when unpacking and installing the product.**

- Sharp edges could cause injury. Be especially careful of the case edges and the fins on the condenser and evaporator.



**For installation, always contact the dealer or an Authorized Service Center.**

- There is risk of fire, electric shock, explosion, or injury.



**Do not install the product on a defective installation stand.**

- It may cause injury, accident, or damage to the product.



**Be sure the installation area does not deteriorate with age.**

- If the base collapses, the air conditioner could fall with it, causing property damage, product failure, and personal injury.

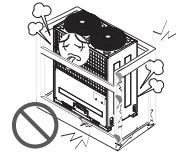

**Use a vacuum pump or Inert (nitrogen) gas when doing leakage test or air purge. Do not compress air or Oxygen and Do not use Flammable gases. Otherwise, it may cause fire or explosion.**

- There is the risk of death, injury, fire or explosion.

## ■ Operation

**Do not store or use flammable gas or combustibles near the product.**

- There is risk of fire or failure of product.



**CAUTION**

**Installation**

**Always check for gas (refrigerant) leakage after installation or repair of product.**

- Low refrigerant levels may cause failure of product.

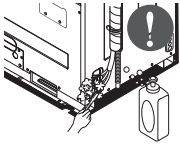

**Install the drain hose to ensure that water is drained away properly.**

- A bad connection may cause water leakage.

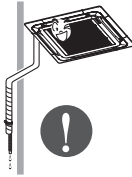

**Keep level even when installing the product.**

- To avoid vibration or water leakage.

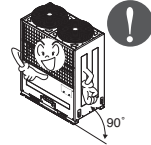

**Do not install the product where the noise or hot air from the outdoor unit could damage the neighborhoods.**

- It may cause a problem for your neighbors.



**Use two or more people to lift and transport the product.**

- Avoid personal injury.



**Do not install the product where it will be exposed to sea wind (salt spray) directly.**

- It may cause corrosion on the product. Corrosion, particularly on the condenser and evaporator fins, could cause product malfunction or inefficient operation.

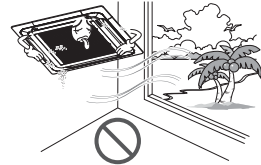

**If you eat the liquid from the batteries, brush your teeth and see doctor. Do not use the remote if the batteries have leaked.**

- The chemicals in batteries could cause burns or other health hazards.



# Installation

Read completely, then follow step by step.

## Selection of the best location

- If the temperature might rise above 30°C or the humidity might rise above RH 80%, attach the Dew-Protective kit or use another insulation to the indoor body.
  - \* Dew Protective kit is sold separately.
    - Use glass wool material or polyethylene foam and make sure at least 10mm thick.
- There should not be any heat source or steam near the unit.
- There should not be any obstacles to the air circulation.
- A place where air circulation in the room will be good.
- A place where drainage can be easily obtained.
- A place where noise prevention is taken into consideration.
- Do not install the unit near the door way.
- Ensure the spaces indicated by arrows from the wall, ceiling, or other obstacles.
- The indoor unit must have the maintenance space.

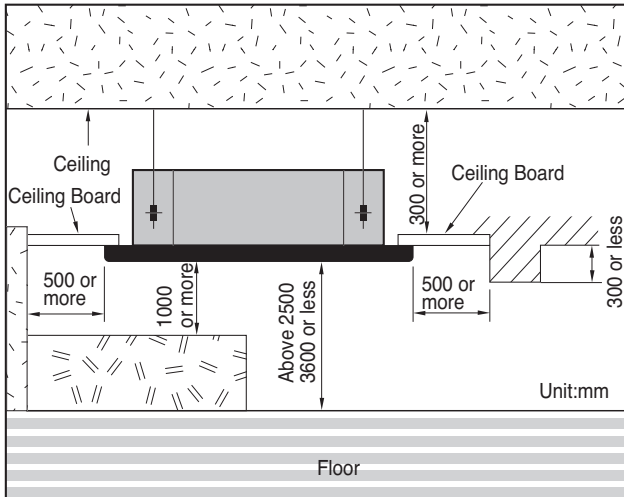

**CAUTION** : In case that the unit is installed near the sea, the installation parts may be corroded by salt. The installation parts (and the unit) should be taken appropriate anti-corrosion measures.

\* Please use an annexed sheet or the corrugated cardboard on the bottom of packing as installation sheet.

\* When using the bottom sheet, please use it after separating the installation sheet from packing of the product floor by using a knife etc as a picture below.



Annexed sheet

Or

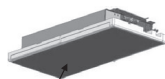

Packing corrugated cardboard on the bottom

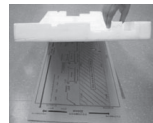

## Ceiling dimension and hanging bolt location

- The dimensions of the paper model for installation are the same as those of the ceiling opening dimensions.

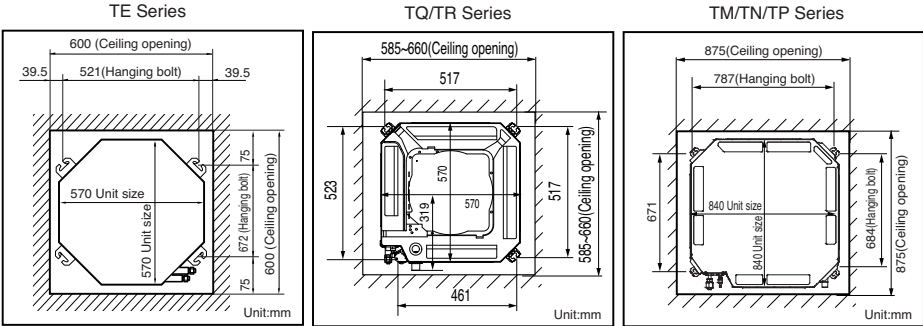
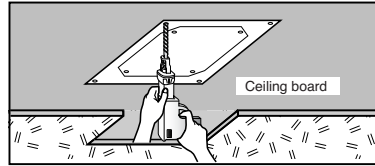
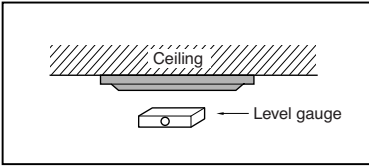

### CAUTION :

- This air-conditioner uses a drain pump.
- Install the unit horizontally using a level gauge.
- During the installation, care should be taken not to damage electric wires.
- Select and mark the position for fixing bolts and piping hole.
- Decide the position for fixing bolts slightly tilted to the drain direction after considering the direction of drain hose.
- Drill the hole for anchor bolt on the wall.

### NOTICE

- Avoid the following installation location.
  - Such places as restaurants and kitchen where considerable amount of oil steam and flour is generated. These may cause heat exchange efficiency reduction, or water drops, drain pump mal-function. In these cases, take the following actions;
    - Make sure that ventilation fan is enough to cover all noxious gases from this place.
    - Ensure enough distance from the cooking room to install the air conditioner in such a place where it may not suck oily steam.
  - Avoid installing air conditioner in such places where cooking oil or iron powder is generated.
  - Avoid places where inflammable gas is generated.
  - Avoid place where noxious gas is generated.
  - Avoid places near high frequency generators.

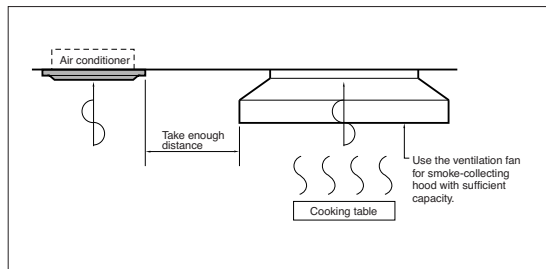



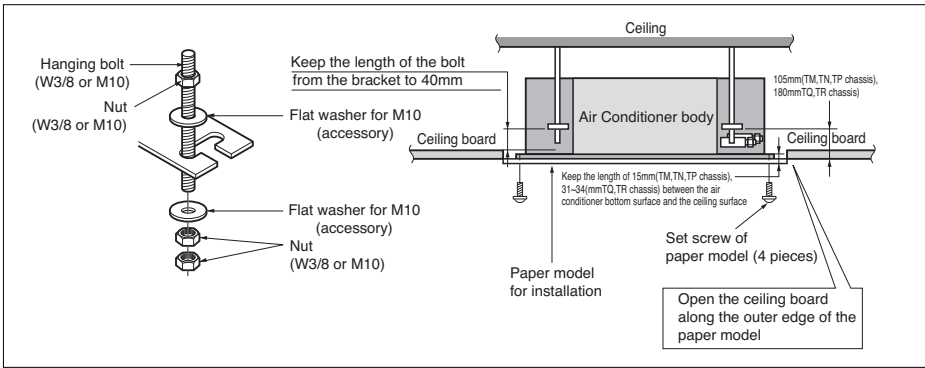

• The following parts are local purchasing.

- ① Hanging Bolt - W 3/8 or M10
- ② Nut - W 3/8 or M10
- ③ Spring Washer - M10
- ④ Plate Washer - M10

**CAUTION :** Tighten the nut and bolt to prevent the unit from falling.

## Wiring Connection

- Connect the wires to the terminals on the control board individually according to the outdoor unit connection.
- Ensure that the color of the wires of outdoor unit and the terminal No. are the same as those of indoor unit respectively.

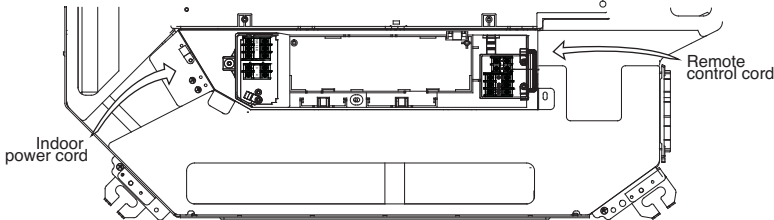

### • TR/TQ/TE Chassis

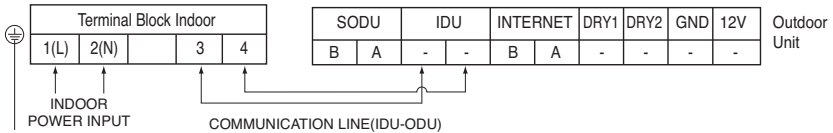

### • TM/TN/TP Chassis

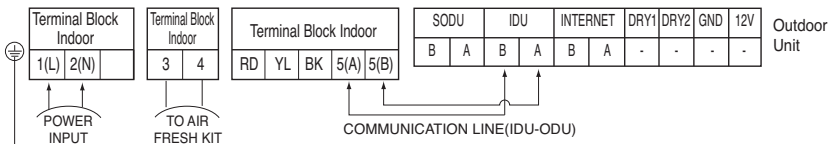

**WARNING :** Make sure that the screws of the terminal are free from loose.

**CAUTION :** The Power cord connected to the unit should be selected according to the following specifications.



**CAUTION:**

After the confirmation of the above conditions, prepare the wiring as follows:

- 1) **Never fail to have an individual power specialized for the air conditioner. As for the method of wiring, be guided by the circuit diagram posted on the inside of control box cover.**
- 2) **Provide a circuit breaker switch between power source and the unit.**
- 3) **The screws which fasten the wiring in the casing of electrical fittings are liable to come loose from vibrations to which the unit is subjected during the course of transportation. Check them and make sure that they are all tightly fastened. (If they are loose, it could give rise to burn-out of the wires.)**
- 4) **Specification of power source**
- 5) **Confirm that electrical capacity is sufficient.**
- 6) **Be sure that the starting voltage is maintained at more than 90 percent of the rated voltage marked on the name plate.**
- 7) **Confirm that the cable thickness is as specified in the power sources specification. (Particularly note the relation between cable length and thickness.)**
- 8) **Never fail to equip a leakage breaker where it is wet or moist.**
- 9) **The following troubles would be caused by voltage drop-down.**
  - Vibration of a magnetic switch, damage on the contact point, fuse breaking, disturbance by the normal function of an overload protection device.
  - Proper starting power is not given to the compressor.

**HAND OVER**

Teach the customer the operation and maintenance procedures, using the operation manual. (air filter cleaning, temperature control, etc.)

**WIRED REMOTE CONTROLLER INSTALLATION**

- Since the room temperature sensor is in the remote controller, the remote controller box should be installed in a place away from direct sunlight, high humidity and direct supply of cold air to maintain proper space temperature. Install the remote controller about 5ft(1.5m) above the floor in an area with good air circulation at an average temperature.

**Do not install the remote controller where it can be affected by:**

- Drafts, or dead spots behind doors and in corners.
- Hot or cold air from ducts.
- Radiant heat from sun or appliances.
- Concealed pipes and chimneys.
- Uncontrolled areas such as an outside wall behind the remote controller.
- This remote controller is equipped with a seven segment LED display. For proper display of the remote controller LED's, the remote controller should be installed properly as shown in Fig.1. (The standard height is 1.2~1.5 m from floor level.)

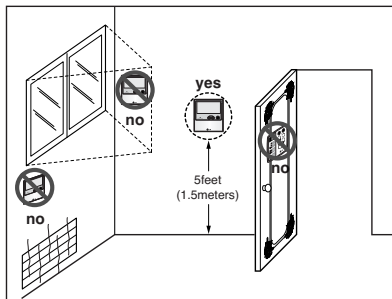



Fig.1 Typical locations for remote controller

## Installation of Decoration Panel

The decoration panel has its installation direction.

Before installing the decoration panel, always remove the paper template.

1. Temporarily fix two decoration panel fixing screws (hexagon M5 screw) on the unit body. (Tighten by amount 10mm in length.)  
The fixing screws (hexagon M5 screw) are included the indoor unit box.
2. Remove the air inlet grille from the decoration panel. (Remove the hook for the air inlet grille cord.)
3. Hook the decoration panel key hole (  ) on the screws fixed in step above, and slide the panel so that the screws reach the key hole edge.
4. Retighten completely two temporarily fixed screws and other two screws. (Total 4 screws)
5. Connect the louver motor connector and display connector.
6. After tightening these screws, install the air inlet grille (including the air filter).

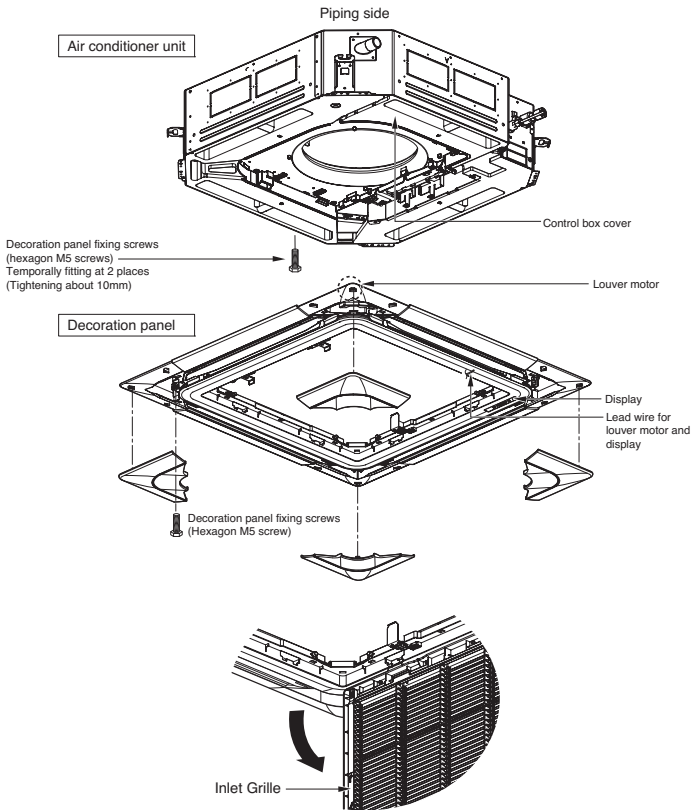

**CAUTION : Install certainly the decoration panel. Cool air leakage causes sweating.**  
 ⇨ Water drops fall.

Good example

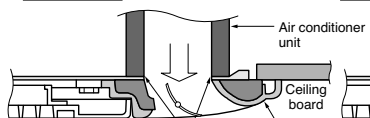

Fit the insulator (this part) and be careful for cool air leakage

Bad example

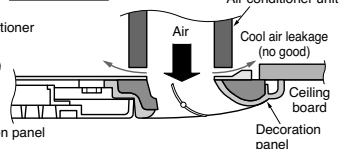

## Drain Piping

- Drain piping must have down-slope (1/50 to 1/100): be sure not to provide up-and-down slope to prevent reversal flow.
- During drain piping connection, be careful not to exert extra force on the drain port on the indoor unit.
- The outside diameter of the drain connection on the indoor unit is 32mm.

Piping material: Polyvinyl chloride pipe VP-25 and pipe fittings

- Be sure to install heat insulation on the drain piping.

Heat insulation material: Polyethylene foam with thickness more than 8 mm.

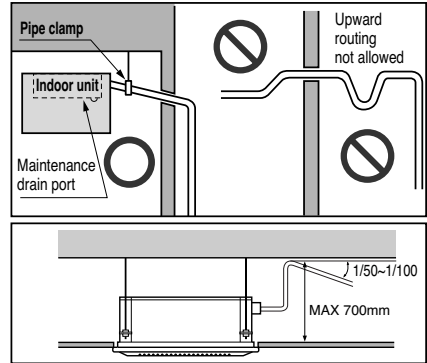

### Drain test

The air conditioner uses a drain pump to drain water. Use the following procedure to test the drain pump operation:

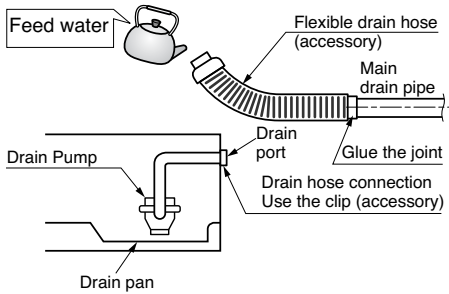

- Connect the main drain pipe to the exterior and leave it provisionally until the test comes to an end.
- Feed water to the flexible drain hose and check the piping for leakage.
- Be sure to check the drain pump for normal operating and noise when electrical wiring is complete.
- When the test is complete, connect the flexible drain hose to the drain port on the indoor unit.



**CAUTION :** The supplied flexible drain hose should not be curved, neither screwed. The curved or screwed hose may cause a leakage of water.

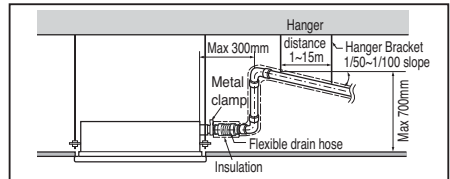

**Attention**

1. Possible drain-head height is up to 700mm. So, it must be installed below 700mm.
2. Keep the drain hose downward up to 1/50~1/100 inclination. Prevent any upward flow or reverse flow in any part.
3. 5mm or thicker formed thermal insulator is provided for the drain pipe.
4. Upward routing is not allowed.
5. Be sure to check the drain pump for normal operation and abnormal noise when electrical wiring is complete.

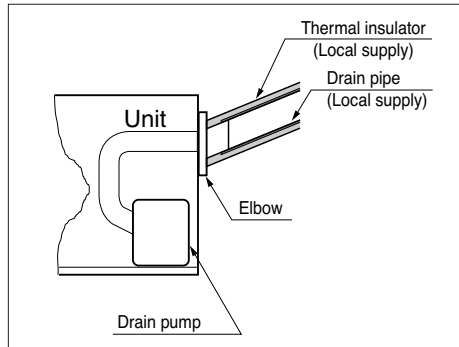
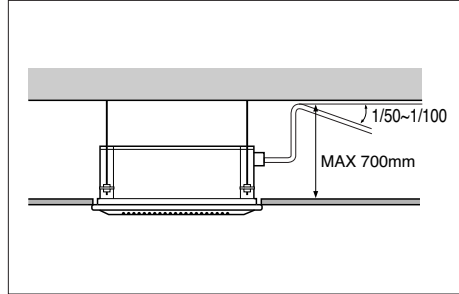

## Installation of Wired Remote Controller

### 1. Please fix tightly using provided screw after placing remote controller setup board on the place where you like to setup.

- Please set it up not to bend because poor setup could take place if setup board bends.
- Please set up remote controller board fit to the reclamation box if there is a reclamation box.

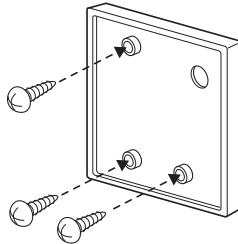

### 2. Can set up Wired remote controller cable into three directions.

- Setup direction: the surface of wall reclamation, upper, right
- If setting up remote controller cable into upper and right side, please set up after removing remote controller cable guide groove.

※ Remove guide groove with long nose.

- ① Reclamation to the surface of the wall
- ② Upper part guide groove
- ③ Right part guide groove

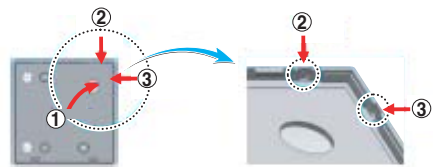

<Wire guide grooves>

### 3. Please fix remote controller upper part into the setup board attached to the surface of the wall, as the picture below, and then, connect with setup board by pressing lower part.

- Please connect not to make a gap at the remote controller and setup board's upper and lower, right and left part.

<Connecting order>

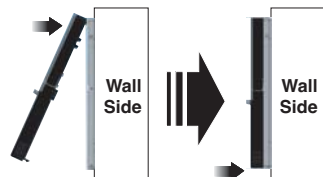

When separating remote controller from setup board, as the picture below, after inserting into the lower separating hole using screw driver and then, spinning clockwise, remote controller is separated.

- There are two separating holes. Please individually separate one at a time.
- Please be careful not to damage the inside components when separating.

<Separating order>

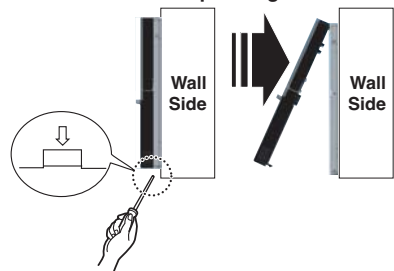

4. Please connect indoor unit and remote controller using connection cable.

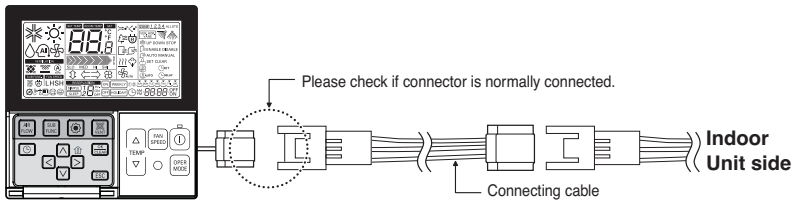

5. Please use extension cable if the distance between wired remote controller and indoor unit is more than 10m.

**CAUTION**

When installing the wired remote controller, do not bury it in the wall.

(It can cause damage in the temperature sensor.)

Do not install the cable to be 50m or above.

(It can cause communication error.)

- When installing the extension cable, check the connecting direction of the connector of the remote controller side and the product side for correct installation.
- If you install the extension cable in the opposite direction, the connector will not be connected.
- Specification of extension cable: 2547 1007 22# 2 core 3 shield 5 or above.

## Name and function of wired remote controller(Accessory)

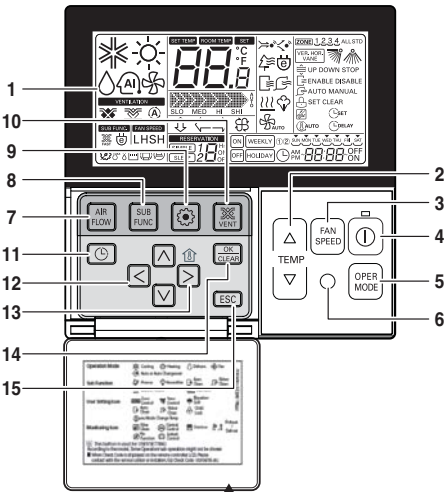

Please attach the inform label inside of the door.  
Please choose proper language depend on your country.

1. **Operation indication screen**
2. **Set temperature button**
  - It will set not room temperature but outlet air temperature.
3. **Fan speed button**
  - Fan Speed have 3 Steps.
  - Middle and Low step is same
4. **ON/OFF button**
5. **Operation mode selection button**
6. **Wireless remote controller receiver**
  - Some products don't receive the wireless signals.
7. **Air flow button**
8. **Subfunction button**
9. **Function setting button**
10. **Ventilation button**
11. **Reservation**
12. **Up,down,left,right button**
  - To check the indoor temperature, press button.
13. **Room temperature button**
  - Displays only the room temperature of the remote controller perception.
  - There is no control of room temperature.
  - In case of fresh air intake unit, displays only the temperature around remote controller.
14. **Setting/Cancel button**
15. **Exit button**

- ※ Some functions may not be operated and displayed depending on the product type.
- ※ It will display strange value to the room temperature if wired remote controller is not connected.

Model : PQRCSL0 (Black Color)  
PQRCSLQW (White Color)



## Dip Switch Setting

	Function	Description	Setting Off	Setting On	Default
SW1	Communication	N/A (Default)	-	-	Off
SW2	Cycle	N/A (Default)	-	-	Off
SW3	Group Control	Selection of Master or Slave	Master	Slave	Off
SW4	Dry Contact Mode	Selection of Dry Contact Mode	Wired/Wireless remote controller Selection of Manual or Auto operation Mode	Auto	Off
SW5	Installation	Fan continuous operation	Continuous operation Removal	-	Off
SW6	Heater linkage	N/A	-	-	Off
SW7	Ventilator linkage	Selection of Ventilator linkage	Linkage Removal	Working	Off
	Vane selection (Console)	Selection of up/down side Vane	Up side + Down side Vane	Up side Vane Only	
	Region selection	Selection tropical region	General model	Tropical model	
SW8	Etc.	Spare	-	-	Off

### CAUTION

For Multi V Models, Dip switch 1, 2, 6, 8 must be set OFF.

## Group Control Setting

### 1. Group Control 1

#### ■ Wired remote controller 1 + Standard Indoor Units

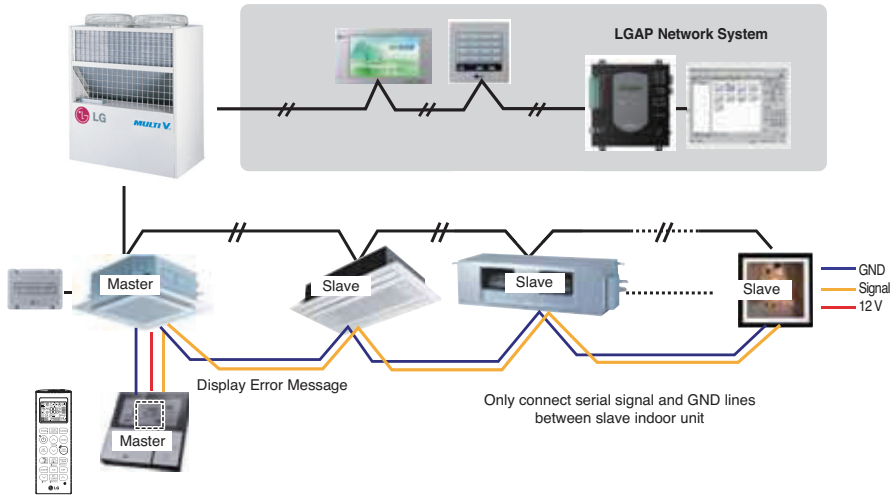

#### ■ Dip Switch in PCB (Cassette and Duct Type indoor units)

##### ① Master Setting - No. 3 Off

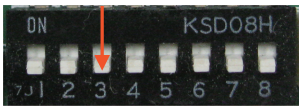

##### ② Slave Setting - No. 3 On

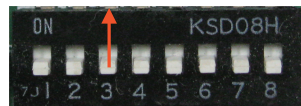

#### 1. It is possible to 16 indoor units(Max) by one wired remote controller.

Set only one indoor unit to Master, set the others to Slave.

#### 2. It is possible to connect with every type of indoor units.

#### 3. It is possible to use wireless remote controller at the same time.

#### 4. It is possible to connect with Dry Contact and Central controller at the same time.

- The Master indoor unit is possible to recognize Dry Contact and Central Controller only.
- In case of Central controller and Group controller at the same time, it is possible to connect standard 2series indoor units or later since Feb. 2009.
- In case of Central controller setting, the Central controller can control indoor units after setting only the address of master indoor unit.
- Slave indoor unit will be operated like master indoor unit.
- Slave indoor unit can not be individually controlled by Central controller.
- Some remote controller can't perform with Dry Contact and Central controller at the same time. So contact us further information about it.

**5. In case of any error occurs at indoor unit, display on the wired remote controller.**

Exception of the error indoor unit, an individual indoor unit control possibility.

**6. In case of Group Control, it is possible to use following functions.**

- Selection of operation options (operation/stop/mode/set temperature)
- Control of flow rate (High/Middle/Low)
- It is not possible at some functions.

\* Master/Slave setting of indoor units be set possible using a PCB Dip Switch.

\* It is possible to connect indoor units since Feb. 2009.

In the other cases, please contact LGE.

\* It can be the cause of malfunctions when there is no setting of master and slave.

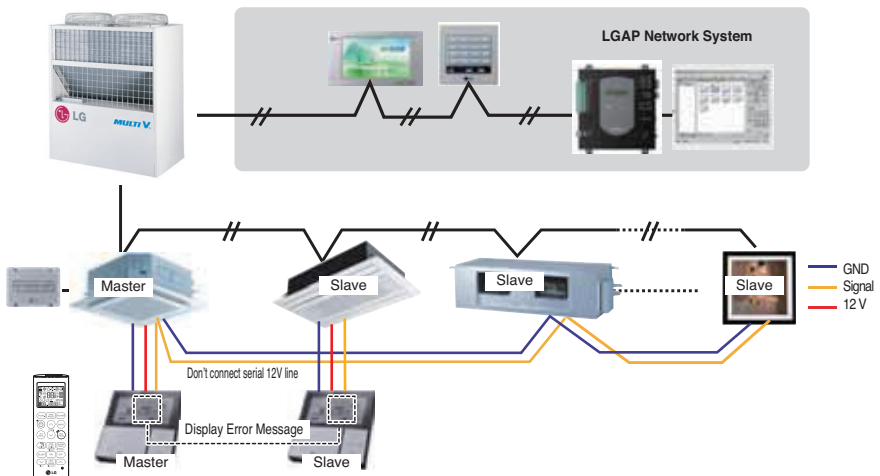
**2. Group Control 2****■ Wired remote controllers + Standard Indoor Units**

\* **It is possible to control N indoor units by wired remote controller M units. ( $M+N \leq 17$  Units)**

Set only one indoor unit to Master, set the others to Slave.

Set only one wired remote controller to Master, set the others to Slave.

Other than those, it is same with the Group Control 1.

### 3. Group Control 3

#### ■ Mixture connection with indoor units and Fresh Air Intake Unit

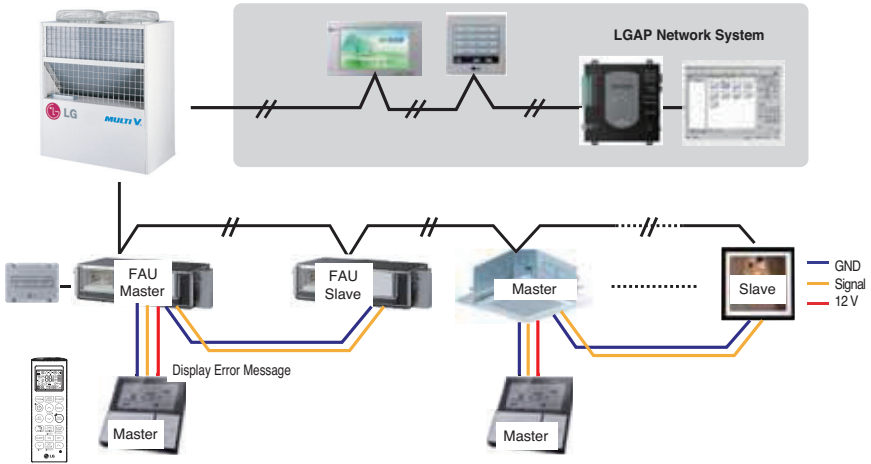

※ In case of connecting with standard indoor unit and Fresh Intake Unit, separate Fresh Air Intake Unit with standard units.  
(Because setting temperature are different.)

※ Other than those, it is same with Group Control 1.

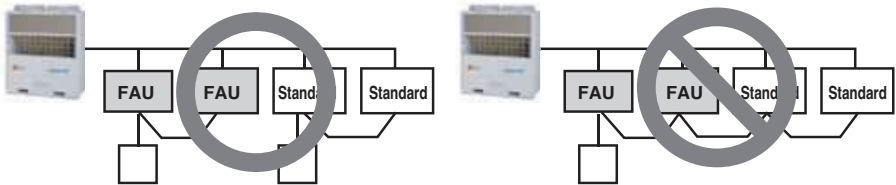

\* FAU : Fresh Air Intake Unit  
Standard: Standard Indoor Unit

## 4. 2 Remote Control

### ■ Wired remote controller 2 + Indoor unit 1

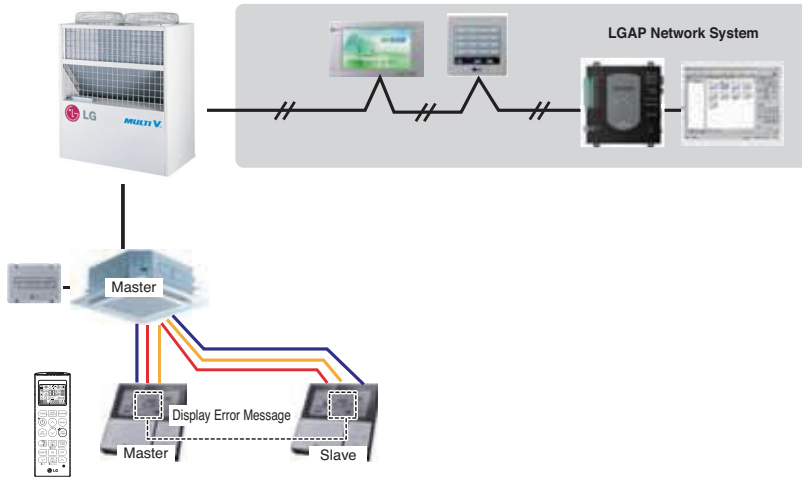

1. It is possible to connect two wired remote controllers with one indoor unit.
2. Every types of indoor unit is possible to connect two remote controller.
3. It is possible to use wireless remote controller at the same time.
4. It is possible to connect with Dry Contact and Central controller at the same time.
5. In case of any error occurs at indoor unit, display on the wired remote controller.
6. There isn't limits of indoor unit function.

\* Maximum 2wired remote controllers can be connected with 1 indoor unit.

## 5. Accessories for group control setting

It is possible to set group control by using below accessories.

