



ENGLISH

FRANCAIS

ESPAÑOL

INSTALLATION MANUAL

AIR CONDITIONER

- Please read this installation manual completely before installing the product.
- Installation work must be performed in accordance with the national wiring standards by authorized personnel only.
- Please retain this installation manual for future reference after reading it thoroughly.your set and retain it for future reference.

MODELS : WATER MINI SERIES



P/NO : MFL63748905

www.lg.com

TABLE OF CONTENTS

Safety Precautions	3
Installation Process	7
Outside units Information	8
Alternative Refrigerant R410A	9
Select the Best Location	9
Installation space	10
Water control	11
Lifting method	13
Installation	14
Refrigerant piping installation	18
Device protection unit	21
Refrigerant piping system	23
Y branch pipe and header branch pipe type	37
Leakage test and vacuum	39
Electrical Wiring	41
Test Run	55
Cooling tower applied method	62
Caution For Refrigerant Leak	63
Water Solenoid Valve Control	65
Variable Water Flow Control KIT(Accessory)	66

Safety Precautions

To prevent injury to the user or other people and property damage, the following instructions must be followed.

- Incorrect operation due to ignoring instruction will cause harm or damage. The seriousness is classified by the following indications.

⚠ WARNING This symbol indicates the possibility of death or serious injury.

⚠ CAUTION This symbol indicates the possibility of injury or damage to properties only.

- Meanings of symbols used in this manual are as shown below.



Be sure not to do.



Be sure to follow the instruction.

⚠ WARNING

■ Installation

Have all electric work done by a licensed electrician according to "Electric Facility Engineering Standard" and "Interior Wire Regulations" and the instructions given in this manual and always use a special circuit.

- If the power source capacity is inadequate or electric work is performed improperly, electric shock or fire may result.

Always ground the product.

- There is risk of fire or electric shock.

For re-installation of the installed product, always contact a dealer or an Authorized Service Center.

- There is risk of fire, electric shock, explosion, or injury.

Do not store or use flammable gas or combustibles near the air conditioner.

- There is risk of fire or failure of product.

Do not install the unit outside.

- Otherwise it may cause fire, electric shock and trouble

When installing and moving the air conditioner to another site, do not charge it with a different refrigerant from the refrigerant specified on the unit.

- If a different refrigerant or air is mixed with the original refrigerant, the refrigerant cycle may malfunction and the unit may be damaged.

Ask the dealer or an authorized technician to install the air conditioner.

- Improper installation by the user may result in water leakage, electric shock, or fire.

Always install a dedicated circuit and breaker.

- Improper wiring or installation may cause fire or electric shock.

Do not install, remove, or re-install the unit by yourself (customer).

- There is risk of fire, electric shock, explosion, or injury.

Use the correctly rated breaker or fuse.

- There is risk of fire or electric shock.

Do not install the product on a defective installation stand.

- It may cause injury, accident, or damage to the product.

Do not reconstruct to change the settings of the protection devices.

- If the pressure switch, thermal switch, or other protection device is shorted and operated forcibly, or parts other than those specified by LGE are used, fire or explosion may result.

Safety Precautions

Ventilate before operating air conditioner when gas leaked out.

- It may cause explosion, fire, and burn.

If the air conditioner is installed in a small room, measures must be taken to prevent the refrigerant concentration from exceeding the safety limit when the refrigerant leaks.

- Consult the dealer regarding the appropriate measures to prevent the safety limit from being exceeded. Should the refrigerant leak and cause the safety limit to be exceeded, hazards due to lack of oxygen in the room could result.

Securely install the cover of control box and the panel.

- If the cover and panel are not installed securely, dust or water may enter the outside unit and fire or electric shock may result.

Use a vacuum pump or Inert (nitrogen) gas when doing leakage test or air purge. Do not compress air or Oxygen and Do not use Flammable gases. Otherwise, it may cause fire or explosion.

- There is the risk of death, injury, fire or explosion.

■ Operation

Do not damage or use an unspecified power cord.

- There is risk of fire, electric shock, explosion, or injury.

Be cautious that water could not enter the product.

- There is risk of fire, electric shock, or product damage.

When the product is soaked (flooded or submerged), contact an Authorized Service Center.

- There is risk of fire or electric shock.

Take care to ensure that nobody could step on or fall onto the outside unit.

- This could result in personal injury and product damage.

Use a dedicated outlet for this appliance.

- There is risk of fire or electrical shock.

Do not touch the power switch with wet hands.

- There is risk of fire, electric shock, explosion, or injury.

Be cautious not to touch the sharp edges when installing.

- It may cause injury.

Do not open the inlet grille of the product during operation. (Do not touch the electrostatic filter, if the unit is so equipped.)

- There is risk of physical injury, electric shock, or product failure.

CAUTION

■ Installation

Always check for gas (refrigerant) leakage after installation or repair of product.

- Low refrigerant levels may cause failure of product.

Keep level even when installing the product.

- To avoid vibration or water leakage.

Use power cables of sufficient current carrying capacity and rating.

- Cables that are too small may leak, generate heat, and cause a fire.

Keep the unit away from children. The heat exchanger is very sharp.

- It can cause the injury, such as cutting the finger. Also the damaged fin may result in degradation of capacity.

Do not install the product where the noise or hot air from the outside unit could damage the neighborhoods.

- It may cause a problem for your neighbors.

Do not install the unit where combustible gas may leak.

- If the gas leaks and accumulates around the unit, an explosion may result.

Do not use the product for special purposes, such as preserving foods, works of art, etc. It is a consumer air conditioner, not a precision refrigeration system.

- There is risk of damage or loss of property.

When installing the unit in a hospital, communication station, or similar place, provide sufficient protection against noise.

- The inverter equipment, private power generator, high-frequency medical equipment, or radio communication equipment may cause the air conditioner to operate erroneously, or fail to operate. On the other hand, the air conditioner may affect such equipment by creating noise that disturbs medical treatment or image broadcasting.

Do not install the product where it is exposed to sea wind (salt spray) directly.

- It may cause corrosion on the product. Corrosion, particularly on the condenser and evaporator fins, could cause product malfunction or inefficient operation.

■ Operation**Do not use the air conditioner in special environments.**

- Oil, steam, sulfuric smoke, etc. can significantly reduce the performance of the air conditioner or damage its parts.

Make the connections securely so that the outside force of the cable may not be applied to the terminals.

- Inadequate connection and fastening may generate heat and cause a fire.

Do not block the inlet or outlet.

- It may cause failure of appliance or accident.

Be sure the installation area does not deteriorate with age.

- If the base collapses, the air conditioner could fall with it, causing property damage, product failure, or personal injury.

Be very careful about product transportation.

- Only one person should not carry the product if it weighs more than 20kg.
- Some products use PP bands for packaging. Do not use any PP bands for a means of transportation. It is dangerous.
- Do not touch the heat exchanger fins. Doing so may cut your fingers.
- When transporting the outside unit, suspending it at the specified positions on the unit base. Also support the outside unit at four points so that it cannot slip sideways.

Safely dispose of the packing materials.

- Packing materials, such as nails and other metal or wooden parts, may cause stabs or other injuries.
- Tear apart and throw away plastic packaging bags so that children may not play with them. If children play with a plastic bag which was not torn apart, they face the risk of suffocation.

Do not touch any of the refrigerant piping during and after operation.

- It can cause a burn or frostbite.

Do not directly turn off the main power switch after stopping operation.

- Wait at least 5minutes before turning off the main power switch. Otherwise it may result in water leakage or other problems.

Turn on the power at least 6hours before starting operation.

- Starting operation immediately after turning on the main power switch can result in severe damage to internal parts. Keep the power switch turned on during the operational season.

Do not operate the air conditioner with the panels or guards removed.

- Rotating, hot, or high-voltage parts can cause injuries.

Auto-addressing should be done in condition of connecting the power of all indoor and outdoor units. Auto-addressing should also be done in case of changing the indoor unit PCB.**Use a firm stool or ladder when cleaning or maintaining the air conditioner.**

- Be careful and avoid personal injury.



WARNING

- Refer to local code for all wiring size.
- Installation or repairs made by unqualified persons can result in hazards to you and others. Installation of all field wiring and components **MUST** conform with local building codes or, in the absence of local codes, with the National Electrical Code 70 and the National Building Construction and Safety Code or Canadian Electrical code and National Building Code of Canada.
- The information contained in the manual is intended for use by a qualified service technician familiar with safety procedures and equipped with the proper tools and test instruments.
- Failure to carefully read and follow all instructions in this manual can result in equipment malfunction, property damage, personal injury and/or death.



WARNING

When wiring:

Electrical shock can cause severe personal injury or death. Only a qualified, experienced electrician should attempt to wire this system.

- Do not supply power to the unit until all wiring and tubing are completed or reconnected and checked.
- Highly dangerous electrical voltages are used in this system. Carefully refer to the wiring diagram and these instructions when wiring. Improper connections and inadequate grounding can cause accidental injury or death.
- Ground the unit following local electrical codes.
- Connect all wiring tightly. Loose wiring may cause overheating at connection points and a possible fire hazard.
- The choice of materials and installations must comply with the applicable local/national or international standards.

When transporting:

Be careful when picking up and moving the indoor and outside units. Get a partner to help, and bend your knees when lifting to reduce strain on your back. Sharp edges or thin aluminum fins on the air conditioner can cut your finger.

When installing...

... in a wall: Make sure the wall is strong enough to hold the unit's weight.

It may be necessary to construct a strong wood or metal frame to provide added support.

... in a room: Properly insulate any tubing run inside a room to prevent "sweating" that can cause dripping and water damage to wall and floors.

... in moist or uneven locations: Use a raised concrete pad or concrete blocks provide a solid, level foundation for the outside unit. This prevents water damage and abnormal vibration.

... in an area with high winds: Securely anchor the outside unit down with bolts and a metal frame. Provide a suitable air baffle.

... in a snowy area(for Heat Pump Model): Install the outside unit on a raised platform that is higher than drifting snow. Provide snow vents.

When connecting refrigerant tubing

- Keep all tubing runs as short as possible.
- Use the flare method for connecting tubing.
- Check carefully for leaks before starting the test run.

When servicing

- Turn the power OFF at the main power box(mains) before opening the unit to check or repair electrical parts and wiring.
- Keep your fingers and clothing away from any moving parts.
- Clean up the site after you finish, remember to check that no metal scraps or bits of wiring have been left inside the unit being serviced.

Installation Process

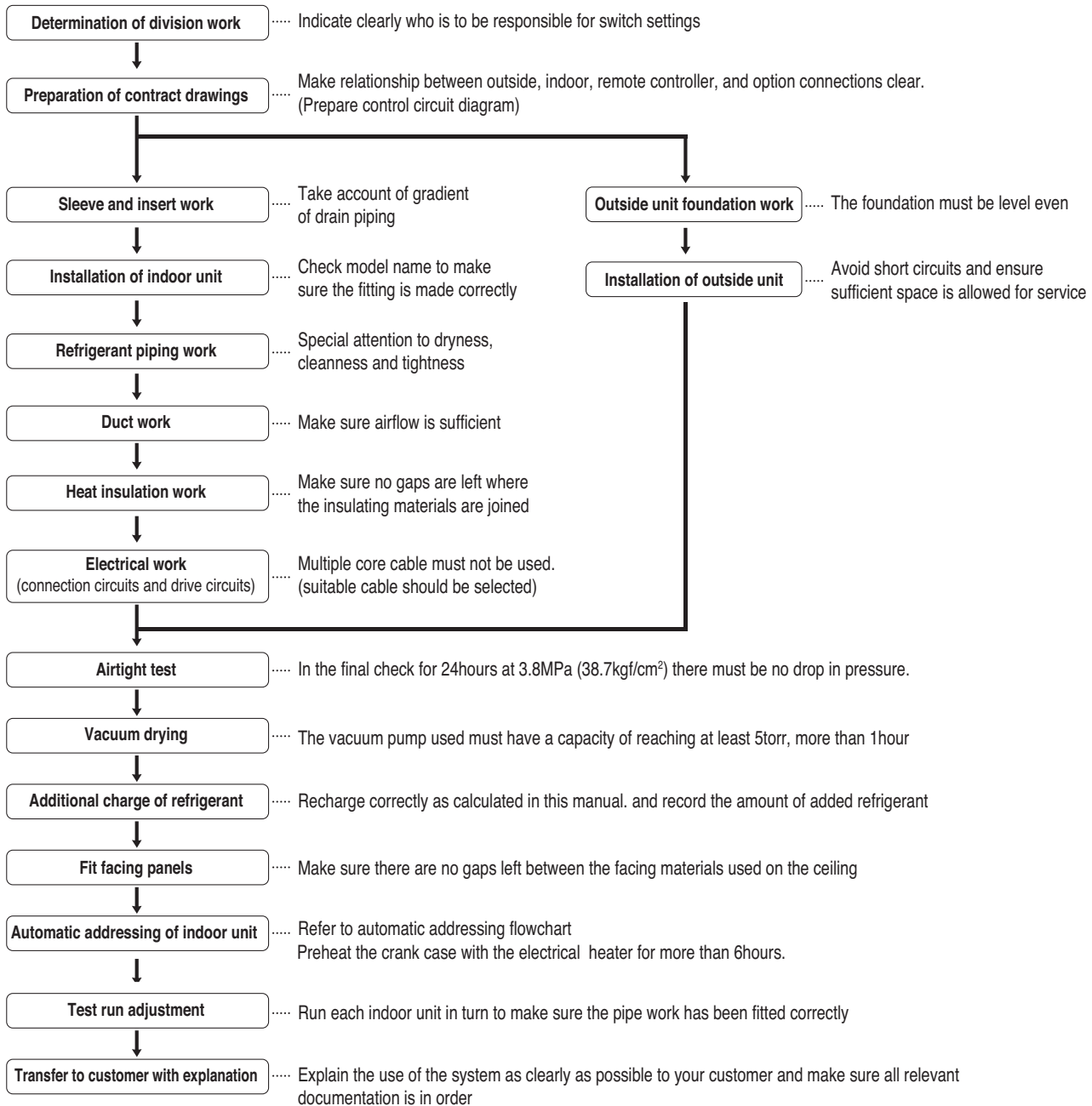

⚠ CAUTION

- The above list indicates the order in which the individual work operations are normally carried out but this order may be varied where local conditions warrants such change.
- The wall thickness of the piping should comply with the relevant local and national regulations for the designed pressure 3.8MPa.
- Since R410A is a mixed refrigerant, the required additional refrigerant must be charged in its liquid state. (If the refrigerant is charged in its gaseous state, its composition changes and the system will not work properly.)

Outside units Information

CAUTION

Ratio of the connectable Indoor Units to the Outside: Within 50 ~ 130%
 Ratio of running Indoor Units to the Outside: Within 10 ~ 100%
 A combination operation over 100% cause to reduce each indoor unit capacity.

Power Supply: Outside Unit (1Ø, 208/230V, 60Hz)

Model (HP)			4	5	6
Model			ARWN038GA2	ARWN048GA2	ARWN053GA2
Refrigerant	Product charge	kg (lbs)	1.0 (2.2)	1.0 (2.2)	1.0 (2.2)
	CF (Correction Factor)	kg (lbs)	-	-	-
Number of maximum connectable indoor units			6	8	9
Net Weight	kg (lbs)		76 (168)	76 (168)	76 (168)
Dimensions (WxHxD)	mm		520 X 1,080 X 330	520 X 1,080 X 330	520 X 1,080 X 330
	inch		20 ¹ / ₂ x 42 ¹ / ₂ x 13	20 ¹ / ₂ x 42 ¹ / ₂ x 13	20 ¹ / ₂ x 42 ¹ / ₂ x 13
Connecting Pipes	Liquid	Ø, mm (inch)	9.52 (3/8)	9.52 (3/8)	9.52 (3/8)
	Gas	Ø, mm (inch)	19.05 (3/4)	19.05 (3/4)	19.05 (3/4)

Alternative Refrigerant R410A

- The refrigerant R410A has the property of higher operating pressure in comparison with R22. Therefore, all materials have the characteristics of higher resisting pressure than R22 ones and this characteristic should be also considered during the installation. R410A is an azeotrope of R32 and R125 mixed at 50:50, so the ozone depletion potential (ODP) of R410A is 0.

CAUTION

- The wall thickness of the piping should comply with the relevant local and national regulations for the designed pressure 3.8MPa
- Since R410A is a mixed refrigerant, the required additional refrigerant must be charged in its liquid state. If the refrigerant is charged in its gaseous state, its composition changes and the system will not work properly.
- Do not place the refrigerant container under the direct rays of the sun to prevent it from exploding.
- For high-pressure refrigerant, any unapproved pipe must not be used.
- Do not heat pipes more than necessary to prevent them from softening.
- Be careful not to install wrongly to minimize economic loss because it is expensive in comparison with R22.

Select the Best Location

Select space for installing outside unit, which will meet the following conditions:

- No direct thermal radiation from other heat sources
- No possibility of annoying neighbors by noise from unit
- No exposition to strong wind
- With strength which bears weight of unit
- Note that drain flows out of unit when heating
- With space for air passage and service work shown next page.
- Because of the possibility of fire, do not install unit to the space where generation, inflow, stagnation, and leakage of combustible gas is expected.
- Avoid unit installation in a place where acidic solution and spray (sulfur) are often used.
- Do not use unit under any special environment where oil, steam and sulfuric gas exist.
- It is recommended to fence round the outside unit in order to prevent any person or animal from accessing the outside unit.
- This product is prohibited for outside installation.
- Select installation location considering following conditions to avoid bad condition when additionally performing defrost operation.
 1. Install the outside unit at a place well ventilated and having a lot of sunshine in case of installing the product at a place with a high humidity in winter (near beach, coast, lake, etc).
(Ex) Rooftop where sunshine always shines.
 2. Performance of heating will be reduced and preheat time of the indoor unit may be lengthened in case of installing the outside unit in winter at following location:
 - (1) Shade position with a narrow space
 - (2) Location with high moisture level in neighboring floor.
 - (3) Location with high humidity around.
 - (4) Location where water gathers since the floor is not even.

Installation space

Required the minimum space as shown below for installation and check. If the space is not fit on this drawing, consult with LG.

: Service area

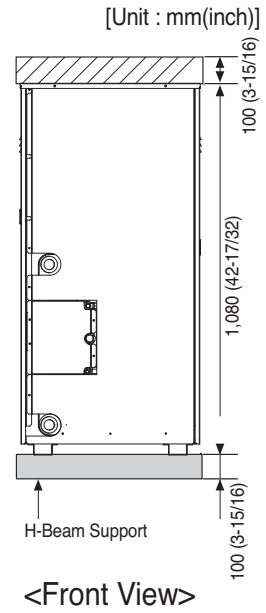
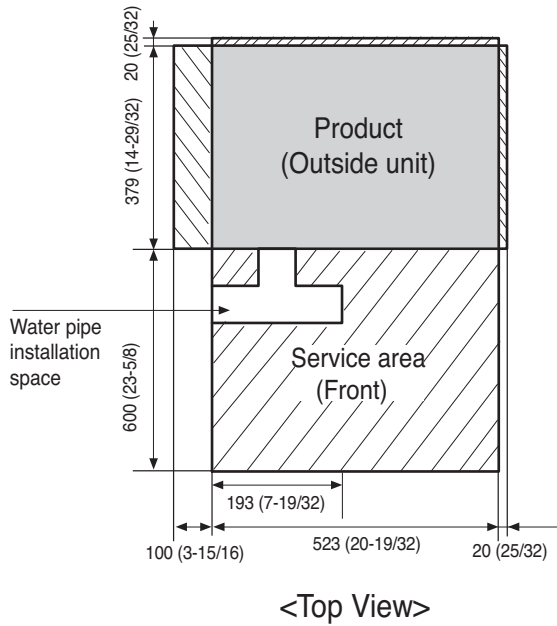

Water control

Water control

- Keep the water temperature between 10~45°C (50~113°F). Other it may cause the breakdown.
 - Standard water supply temperature is 30°C (86°F) for Cooling and 20°C (68°F) for heating.
- Properly control the water velocity. Otherwise it may cause the noise, pipe vibration or pipe contraction, expansion according to the temperature. Use the same water pipe size connected with the product or more.
- Refer to the water source pipe diameter and water velocity table below. As the water velocity is fast, air bubble will increase.

Diameter [mm(inch)]	Velocity range (m/s)
< 50 (1-31/32)	0.6 ~ 1.2
50 (1-31/32) ~ 100 (5-7/8)	1.2 ~ 2.1
100100 (5-7/8) <	2.1 ~ 2.7

- Be careful of the water purity control. Otherwise it may cause the breakdown due to water pipe corrosion. (Refer to 'Standard Table for Water Purity Control')
- In case the water temperature is above 40°C (104°F), it is good to prevent the corrosion by adding the anticorrosive agent.
- Install the pipe, valve and gauge sensor in the space where it is easy to maintain. Install the water valve in the low position for drain, if required.
- Be careful not to let air in. If so, the water velocity will be unstable in the circulation, pump efficiency will also decrease and may cause the piping vibration. Therefore, install the air purge where it may generate the air.
- Choose the following anti freezing methods. Otherwise, it will be dangerous for the pipe to break in the winter.
 - Circulate the water with the pump before dropping the temperature.
 - Keep the normal temperature by boiler.
 - When the cooling tower is not operated for a long time, drain the water in the cooling tower.
 - Use an anti-freeze. (For using an anti freeze, change the DIP switch on main PCB in outside unit.)
 - Refer to the additive amount about freezing temperature as in the table given below.

Anti freeze type	Minimum temperature for anti freezing [°C (°F)]					
	0	-5 (23)	-10 (14)	-15 (5)	-20 (-4)	-25
Ethylene glycol (%)	0	12	20	30	-	-
Propylene glycol (%)	0	17	25	33	-	-
Methanol (%)	0	6	12	16	24	30

- In addition to anti freeze, it may cause the change of the pressure in the water system and the low performance of the product.
- Make sure to use the closed cooling type tower.
When applying the open type cooling tower, use a 2nd heat exchanger to make the water supply system a closed type system.

Standard table for water purity control

The water may contain many foreign substances and hence may influence the performance and lifetime of the product due to the corrosion of the condenser and water pipe. (Use water source that complies with the below standard table for water purity control.)

If you use water supply other than the tap water to supply the water for the cooling tower, you must do a water quality inspection.

- If you use the closed cooling tower, the water quality must be controlled in accordance with the following standard table.

If you do not control the water quality in accordance with the following standard water quality table, it can cause performance deterioration to the air conditioner and severe problem to the product

Items	Closed type		Effect	
	Circulating water	Supplemented water	Corrosion	Scale
Basic Item				
pH(25C)	7.0~8.0	7.0~8.0	○	○
Conductivity[25C](mS/m)	Below 30	Below 30	○	○
Chlorine ion(mg Cl ⁻ /l)	Below 50	Below 50	○	-
Sulfuric acid ion(mg SO ₄ ²⁻ /l)	Below 50	Below 50	○	○
Acid demand[pH 4.8] (mg SiO ₂ /l)	Below 50	Below 50	-	○
Total hardness(mg SiO ₂ /l)	Below 70	Below 70	-	○
Ca hardness(mg CaCO ₃ /l)	Below 50	Below 50	-	○
Ion silica(mg SiO ₂ /l)	Below 30	Below 30	-	○
Reference Item				
Fe(mg Fe/l)	Below 1.0	Below 0.3	○	○
Copper(mg Cu/l)	Below 1.0	Below 0.1	○	-
Sulfuric acid ion(mg S ²⁻ /l)	Must not be detected	Must not be detected	○	-
Ammonium ion(mg NH ₄ ⁺ /l)	Below 0.3	Below 0.1	○	-
Residual chlorine(mg Cl/l)	Below 0.25	Below 0.3	○	-
Free carbon dioxide(mg CO ₂ /l)	Below 0.4	Below 4.0	○	-
Stability index	-	-	○	○

[Reference]

- (1) The "O" mark for corrosion and scale means that there is possibility of occurrence.
- (2) When the water temperature is 40°C or above or when uncoated iron is exposed to the water, it can result in corrosion. Therefore adding anti-corrosion agent or removing the air can be very effective.
- (3) In case of using the closed type cooling tower, the cooling water and supplementing water must satisfy the water quality criteria of closed type system in the table.
- (4) Supplementing water and supplied water must be supplied with tap water, industrial water and underground water excluding filtered water, neutral water, soft water etc.
- (5) 15 items in the table are general causes of corrosion and scale.

Lifting method

- When carrying the unit suspended, pass the ropes under the unit and use the two suspension points each at the front and rear.
- Always lift the unit with ropes attached at four points so that impact is not applied to the unit.
- Attach the ropes to the unit at an angle of 40° or less

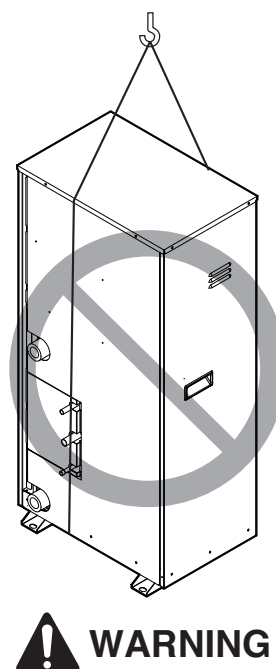
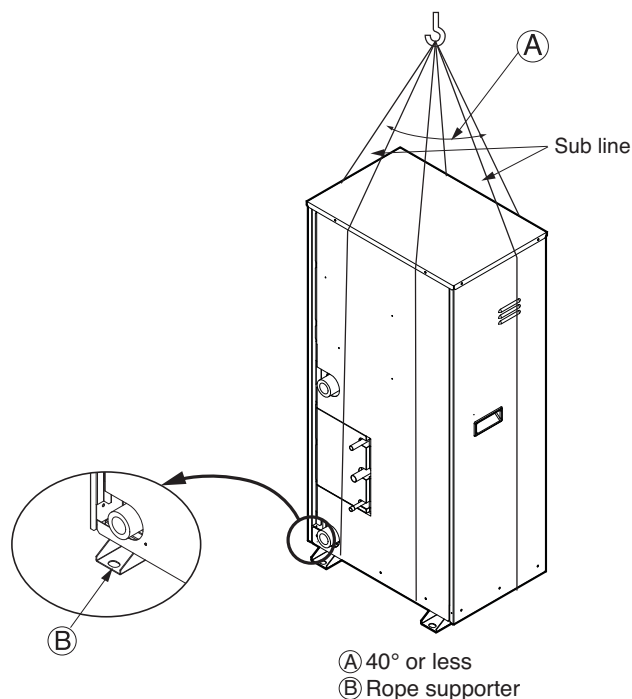

! CAUTION

- Do not have only one person carry product if it is more than 20kg (44.1lbs).
- PP bands are used to pack some products. Do not use them as a means for transportation because they are dangerous.
- Tear the plastic packaging bag and scrap it so that children cannot play with it. Otherwise plastic packaging bag may suffocate children.
- When carrying in outside unit, be sure to support it at four points. Carrying in and lifting with 3-point support may make outside unit unstable, resulting in a fall of it.
- When carrying with the forklift, be careful not to drop the product.

Installation

Location of anchor bolt

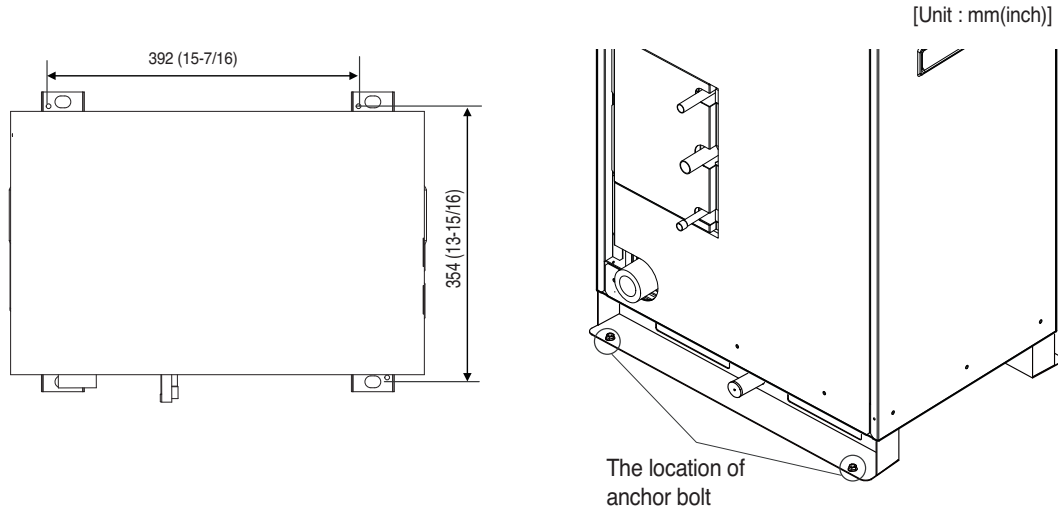

⚠ WARNING

- Be sure to install unit in a place strong enough to withstand its weight. Any lack of strength may cause unit to fall down, resulting in a personal injury.
- Have installation work in order to protect against a strong wind and earthquake. Any installation deficiency may cause unit to fall down, resulting in a personal injury.
- Especially take care for support strength of the floor surface, water drain processing (processing of water flown out from the outside unit during operation) and paths of the pipe and wiring when making a base support.

Foundation for Installation

- Check the strength and level of the installation ground so that the unit will not cause any operating vibration or noise after installation.
- Fix the unit securely by means of the foundation bolts. (Prepare 4sets of M12 foundation bolts, nuts and washers each which are available on the market.)
- It is best to screw in the foundation bolts until their length are 20mm (25/32inch) from the foundation surface.

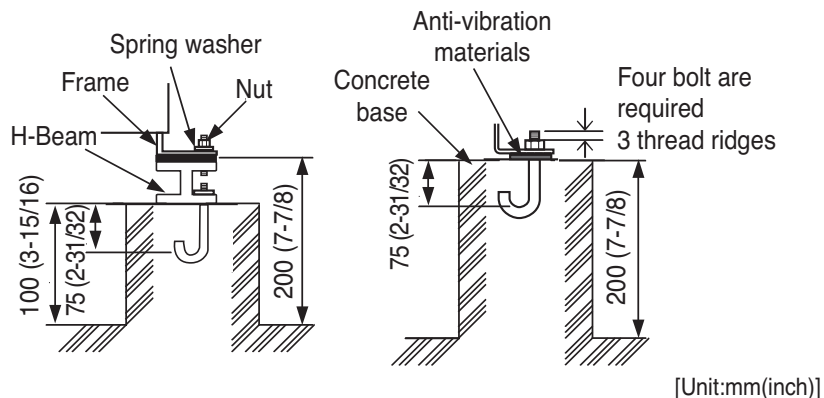

Foundation bolt executing method

Preparation of Piping

Main cause of gas leakage is defect in flaring work. Carry out correct flaring work in the following procedure.

1) Cut the pipes and the cable.

- Use the accessory piping kit or the pipes purchased locally.
- Measure the distance between the indoor and the outside unit.
- Cut the pipes a little longer than measured distance.
- Cut the cable 1.5m longer than the pipe length.

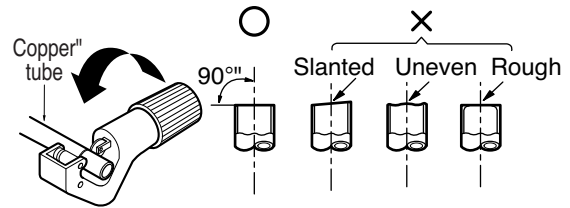

2) Burrs removal

- Completely remove all burrs from the cut cross section of pipe/tube.
- Put the end of the copper tube/pipe to downward direction as you remove burrs in order to avoid to let burrs drop in the tubing.

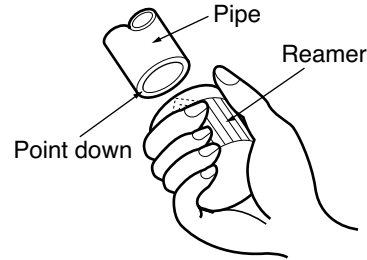

3) Flaring work

- Carry out flaring work using flaring tool as shown below. [Unit: mm(inch)]

Indoor unit [kW(Btu/h)]	Pipe		" A "	
	Gas	Liquid	Gas	Liquid
≤ 5.6 (19,100)	12.7 (1/2)	6.35 (1/4)	1.6~1.8 (0.63~0.71)	1.1~1.3 (0.43~0.51)
<16.0 (54,600)	15.88 (5/8)	9.52 (3/8)	1.6~1.8 (0.63~0.71)	1.5~1.7 (0.59~0.67)
≤ 22.4 (76,400)	19.05 (3/4)	9.52 (3/8)	1.9~2.1 (0.75~0.83)	1.5~1.7 (0.59~0.67)

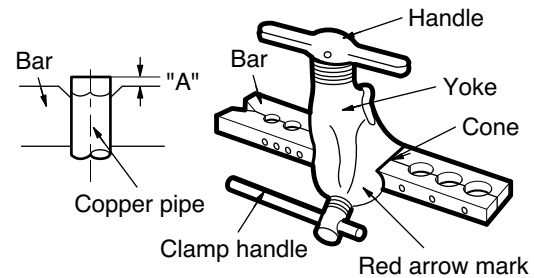

Firmly hold copper tube in a bar(or die) as indicated dimension in the table above.

4) Check

- Compare the flared work with figure below.
- If flare is noted to be defective, cut off the flared section and do flaring work again.

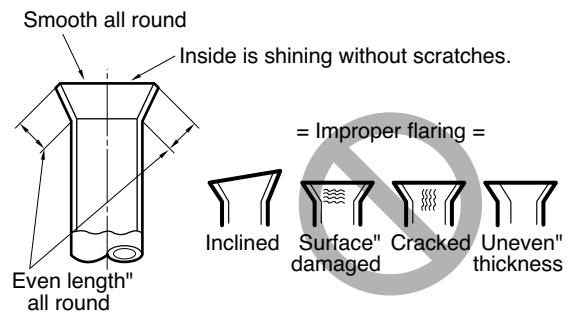

Installation

FLARE SHAPE and FLARE NUT TIGHTENING TORQUE

Precautions when connecting pipes

- See the following table for flare part machining dimensions.
- When connecting the flare nuts, apply refrigerant oil to the inside and outside of the flares and turn them three or four times at first. (Use ester oil or ether oil.)
- See the following table for tightening torque. (Applying too much torque may cause the flares to crack.)
- After all the piping has been connected, use nitrogen to perform a gas leak check.

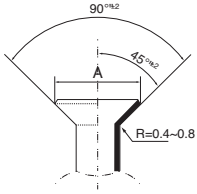
pipe size	tightening torque(Ncm)	A(mm)	flare shape
Ø9.5	3270-3990	12.8-13.2	
Ø12.7	4950-6030	16.2-16.6	
Ø15.9	6180-7540	19.3-19.7	

CAUTION

- Always use a charge hose for service port connection.
- After tightening the cap, check that no refrigerant leaks are present.
- When loosening a flare nut, always use two wrenches in combination. When connecting the piping, always use a spanner and torque wrench in combination to tighten the flare nut.
- When connecting a flare nut, coat the flare (inner and outer faces) with oil for R410A (PVE) and hand tighten the nut 3 to 4 turns as the initial tightening.

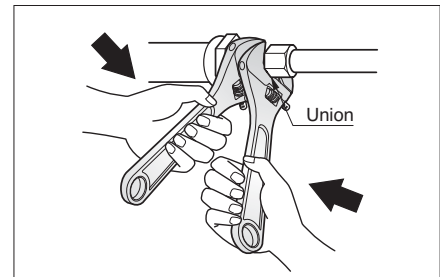

Opening shutoff valve

1. Remove the cap and turn the valve counter clockwise with the hexagon wrench.
2. Turn it until the shaft stops.
Do not apply excessive force to the shutoff valve. Doing so may break the valve body, as the valve is not a backseat type. Always use the special tool.
3. Make sure to tighten the cap securely.

Closing shutoff valve

1. Remove the cap and turn the valve clockwise with the hexagon wrench.
2. Securely tighten the valve until the shaft contacts the main body seal.
3. Make sure to tighten the cap securely.
* For the tightening torque, refer to the table on the below.

Tightening torque

Shutoff valve size	Tightening torque N-m (Turn clockwise to close)					
	Shaft (valve body)		Cap (Valve lid)	Service port	Flare nut	Gas line piping attached to unit
Ø6.4	5.4-6.6	Hexagonal wrench 4mm	13.5-16.5	11.5-13.9	14-17	-
Ø9.5					33-39	
Ø12.7	8.1-9.9	18-22	50-60			
Ø15.9	13.5-16.5	Hexagonal wrench 6mm	23-27		62-75	
Ø22.2	27-33	Hexagonal wrench 10mm	36-44	-	22-28	
Ø25.4				-		

HEAT INSULATION

1. Use the heat insulation material for the refrigerant piping which has an excellent heat-resistance (over 120°C).

2. Precautions in high humidity circumstance:

This air conditioner has been tested according to the "ISO Conditions with Mist" and confirmed that there is not any default. However, if it is operated for a long time in high humid atmosphere (dew point temperature: more than 23°C), water drops are liable to fall. In this case, add heat insulation material according to the following procedure:

- Heat insulation material to be prepared... EPDM (Ethylene Propylene Diene Methylene)-over 120°C the heat-resistance temperature.
- Add the insulation over 10mm thickness at high humidity environment.

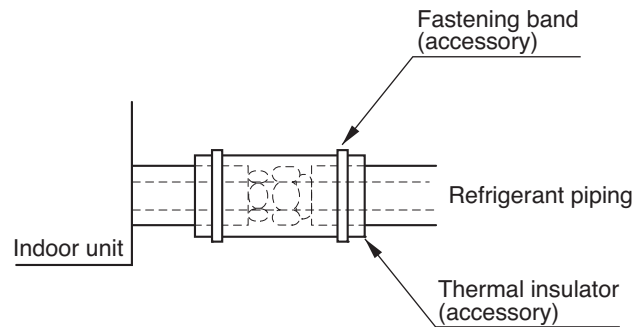

Refrigerant piping installation



WARNING

Always use extreme care to prevent the refrigerant gas (R410A) from leakage while using fire or flame. If the refrigerant gas comes in contact with the flame from any source, such as a gas stove, it breaks down and generates a poisonous gas which can cause gas poisoning. Never perform brazing in an unventilated room. Always conduct an inspection for gas leakage after installation of the refrigerant piping has been completed.

Cautions in pipe connection/valve operation

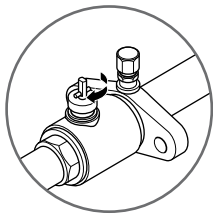

Open status when both the pipe and the valve are in a straight line.

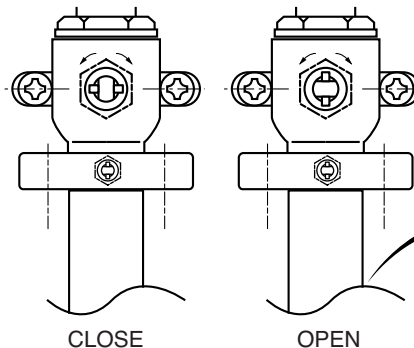

Cut both the pipe and the valve with a cutter to suit the length "
(Don't cut the length of less than 70mm)

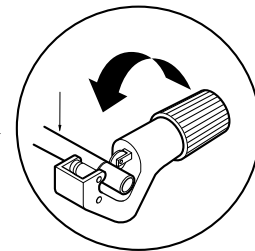

WARNING

After completing work, securely tighten both service ports and caps so that gas does not leak.

- ① Pipe joint (auxiliary parts): Securely perform brazing with a nitrogen blow into the service valve port. (Releasing pressure : 0.02MPa or less)
- ② Flare nut: Loose or tighten flare nut by using the wrench with both ends. Coat the flare connection part with oil for the compressor.
- ③ Cap: Remove caps and operate valve, etc. After operation, always reattach caps (tightening torque of valve cap: 25Nm (250kg-cm) or more). (Don't remove the internal part of the port)
- ④ Service port: Make the refrigerant pipe vacuum and charge it using the service port. Always reattach caps after completing work (tightening torque of service cap: 14Nm (140kg-cm) or more).
- ⑤ Liquid pipe
- ⑥ Gas pipe
- ⑦ Elbow joint (field supply)

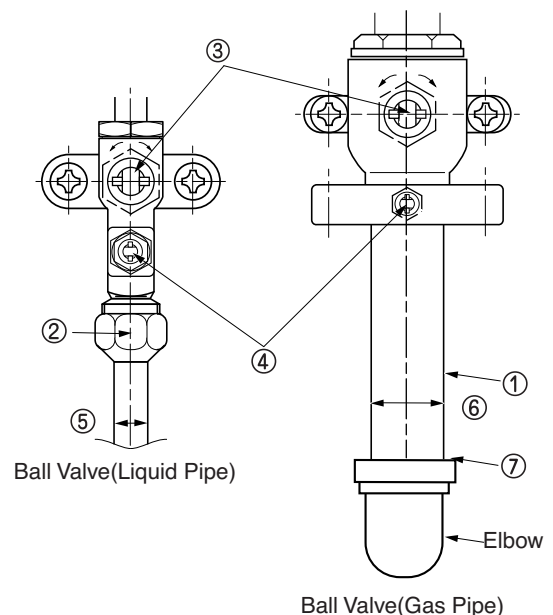

Installation of water pipe

1) Water pipe system diagram

- The water pressure resistance of the water pipe system of this product is 1.98MPa
- When the water pipe passes indoors, make sure to execute heat insulation on the pipe so that water drops do not form on the outer side of the water pipe.
- The size of the drain pipe must be equal to or larger than the diameter of the connecting product.
 - Always install a trap so that the drained water does not back flush.
- Always install a strainer (50Mesh or above) at the entrance of the water pipe. (When sand, trash, rusted pieces get mixed into the water supply, it can cause problems to the product due to blocking)
 - If On/Off valve is applied, by interlocking with outside unit, it can save the energy consumption of pump by blocking the water supply to the outside unit not operating. Select appropriate valve and install on site if necessary.
- Install a pressure gauge and temperature gauge at the inlet and outlet of the water pipe.
- Flexible joints must be installed not to cause any leakage from the vibration of pipes.
- Install a service port to clean the heat exchanger at the each end of the water inlet and outlet.
- For the components of the water pipe system, always use components above the designed water pressure.

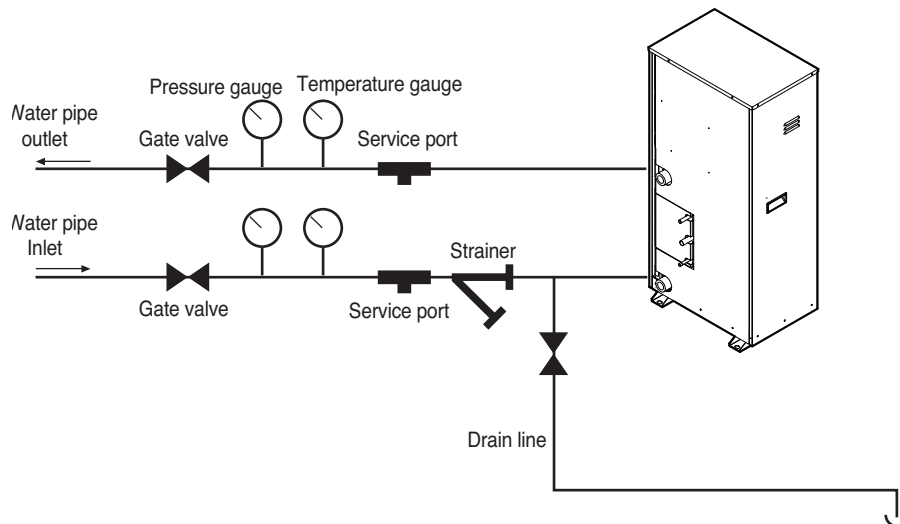

⚠ CAUTION

**Do not directly connect the drain outlet to the water pipe outlet.
(It can cause problems to the product.)**

2) Water pipe connection

- The water pipe should be the same size of the connection on the product or more.
- If necessary install the insulation material in the water pipe inlet/outlet to prevent water drop, freeze and to save energy. (Use the above 20mm thickness PE insulation material.)
- Tightly connect the socket to the water pipe refer to below table for recommended specification. (Too much torque may cause the damage of the facility.)

Refrigerant piping installation

Pipe thickness		Shear stress		Tensile stress		Bending moment		Torque	
mm	inch	(kN)	(kgf)	(kN)	(kgf)	(N·m)	(kgf·m)	(N·m)	(kgf·m)
12.7	1/2	3.5	350	2.5	250	20	2	35	3.5
19.05	3/4	12	1,200	2.5	250	20	2	115	11.5
25.4	1	11.2	1,120	4	400	45	4.5	155	15.5
31.8	1 1/4	14.5	1,450	6.5	650	87.5	8.75	265	26.5
38.1	1 1/2	16.5	1,700	9.5	950	155	16	350	35.5
50.8	2	21.5	2,200	13.5	1,400	255	26	600	61

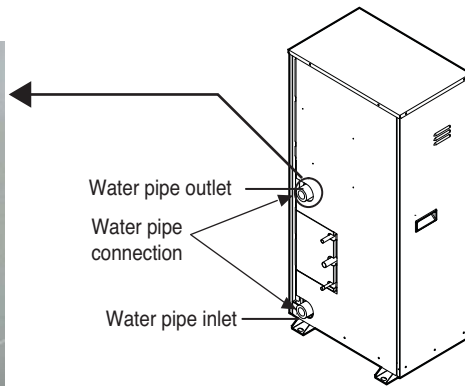

Device protection unit

Strainer on water pipe

To protect the water cooling type product, you must install a strainer with 50mesh or more on the heat water supply pipe. If not installed, it can result in damage of heat exchanger by the following situation.

1. Heat water supply within the plate type heat exchanger is composed of multiple small paths.
2. If you do not use a strainer with 50mesh or more, alien particles can partially block the water paths.
3. When running the heater, the plate type heat exchanger plays the role of the evaporator, and at this time, the temperature of the coolant side drops to drop the temperature of the heat water supply, which can result in icing point in the water paths.
4. And as the heating process progresses, the water paths can be partially frozen to lead to damage in plate type heat exchanger.
5. As a result of the damage of the heat exchanger from the freezing, the coolant side and the heat water source side will be mixed to make the product unusable.

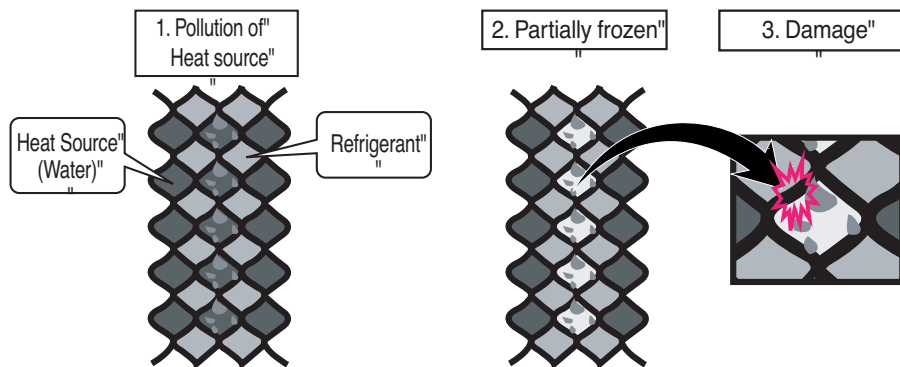

Flow switch work

- It is recommended to install the flow switch to the water collection pipe system connecting to the outside unit.
(Flow switch acts as the 1st protection device when the heat water is not supplied. If a certain level of water does not flow after installing the flow switch, an error sign of CH24 error will be displayed on the product and the product will stop operating.)
- When setting the flow switch, it is recommended to use the product with default set value to satisfy the minimum flow rate of this product. (The minimum flow rate range of this product is 50%. Reference flow rate : 4HP-11GPM, 5HP-13GPM, 6HP-16GPM)
- Select the flow switch with the permitted pressure specification considering the pressure specification of the heat water supply system. (Control signal from outside unit is AC 220V.)

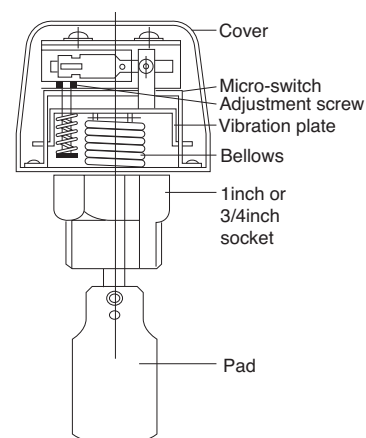

Installation of flow switch

- The flow switch must be installed at the horizontal pipe of the heat water supply outlet of the product and check the direction of the heat water flow before the installation. (Picture 1)
- When connecting the flow switch to the product, remove the jump wire to connect to the communication terminal (4(A) and 4(B)) of the outside unit control box. (Picture 2, 3) (Open the cover of the flow switch and check the wiring diagram before connecting the wires. The wiring method can differ by the manufacturer of the flow switch.)
- If necessary, adjust the flow rate detection screw after consulting with an expert and adjust to the minimum flow rate range. (Picture 4) (Minimum flow rate range of this product is 50%. Adjust the flow switch to touch the contact point when the flow rate reaches 50% of the flow rate.)
 - Reference flow rate : 4HP-11GPM, 5HP-13GPM, 6HP-16GPM

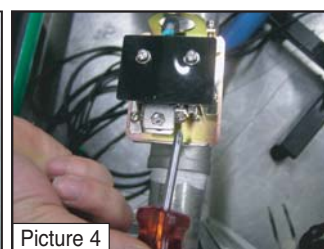
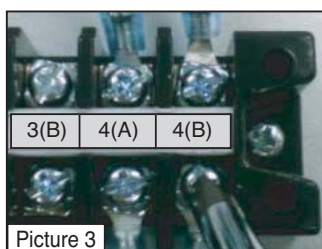
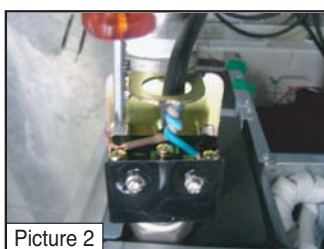

⚠ CAUTION

- If the set value does not satisfy the minimum flow rate or if the set value is changed by the user arbitrarily, it can result in product performance deterioration or serious product problem.
- If the product is operated with the heat water supply not flowing smoothly, it can damage the heat exchanger or cause serious product problems.
- In case of CH24 or CH180 error, there is a possibility that the plate type heat exchanger is partially frozen inside. In this case resolve the issue of partial freezing and then operate the product again. (Cause of partial freezing : Insufficient heat water flow rate, water not supplied, insufficient coolant, alien particle penetrated inside plate type heat exchanger)
- When the product operates while the flow switch touches the contact point at the flow rate range out of the permitted range, it can cause product performance deterioration or serious product problem.
- Must use the normal closed type flow switch - Circuit of outside unit is normal closed type

Refrigerant piping system

Y branch method

Example : 5 Indoor Units connected

- Ⓐ : Outside Unit
- Ⓑ : 1st branch (Y branch)
- Ⓒ : Indoor Units

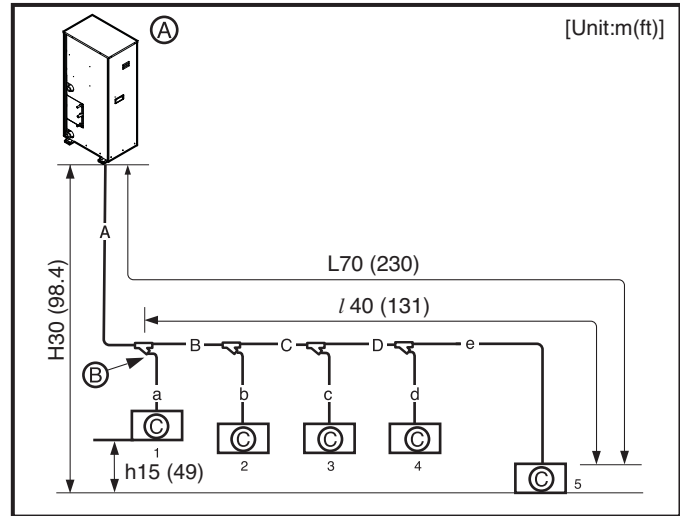

⇒ Total pipe length = A+B+C+D+a+b+c+d+e ≤ 145m (475.7ft)

L	Longest pipe length	Equivalent pipe length
	$A+B+C+D+e \leq 70\text{m (230ft)}$	* $A+B+C+D+e \leq 90\text{m (295.2ft)}$
l	Longest pipe length after 1st branch	
	$B+C+D+e \leq 40\text{m (131ft)}$	
H	Difference in height(Outside Unit ↔ Indoor Unit)	
	$H \leq 30\text{m (98.4ft)}$	
h	Difference in height (Indoor Unit ↔ Indoor Unit)	
	$h \leq 15\text{m (49ft)}$	

• * : Assume equivalent pipe length of Y branch to be 0.5m (1.6ft), that of header to be 1m (3.3ft), calculation purpose

⚠ CAUTION

Indoor Unit should be installed at lower position than the header

Header branch method

■ Header Method

Example : 6 Indoor Units connected

- Ⓐ : Outside Unit
- Ⓑ : 1st branch
- Ⓒ : Indoor Units
- Ⓓ : Sealed piping

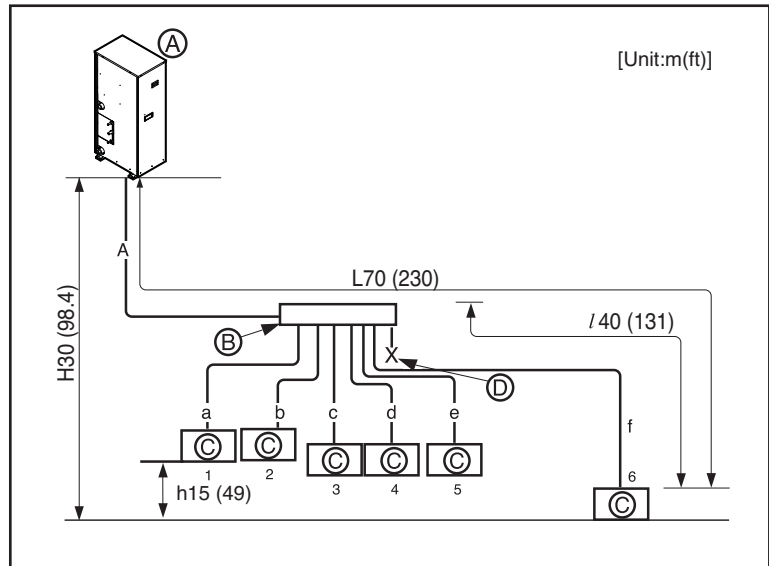

⤵ Total pipe length = $A+a+b+c+d+e+f \leq 145\text{m (475.7ft)}$

L	Longest pipe length	* Equivalent pipe length
	$A+f \leq 70\text{m (230ft)}$	$A+f \leq 90\text{m (295.2ft)}$
l	Longest pipe length after 1st branch	
	$f \leq 40\text{m (131ft)}$	
H	Difference in height(Outside Unit ↔ Indoor Unit)	
	$H \leq 30\text{m (98.4ft)}$	
h	Difference in height (Indoor Unit ↔ Indoor Unit)	
	$h \leq 15\text{m (49ft)}$	

- * : Assume equivalent pipe length of Y branch to be 0.5m (1.6ft), that of header to be 1m (3.3ft), calculation purpose



WARNING

Pipe length after header branching (a~f)

It is recommended that difference in length of the pipes connected to the Indoor Units is minimized. Performance difference between Indoor Units may occur.

Y/Header branch method

Combination of Y branch/header method

Example : 5 Indoor Units connected

- Ⓐ : Outside Unit
- Ⓑ : 1st branch (Y branch)
- Ⓒ : Y branch
- Ⓓ : Indoor Unit
- Ⓔ : Header
- Ⓕ : Sealed piping

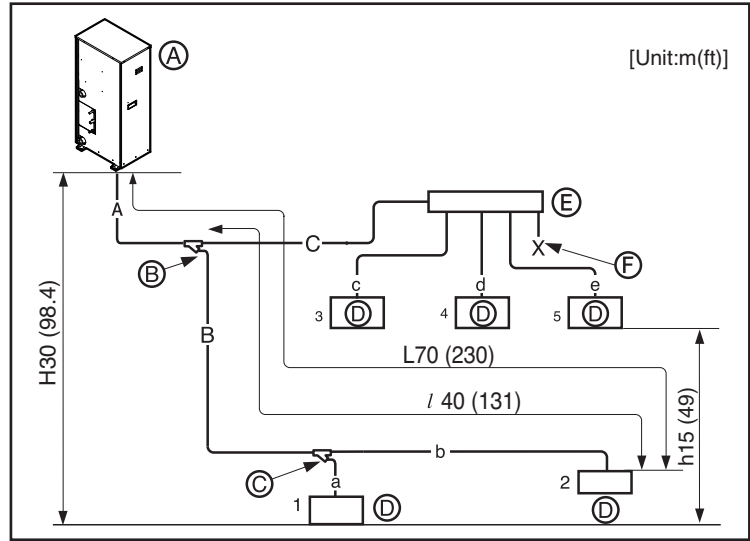

Branch pipe can not be used after header

Refrigerant pipe diameter from branch to branch (B,C)

Downward Indoor Unit total capacity [kW(Btu/h)]	Liquid pipe [mm(inch)]	Gas pipe [mm(inch)]
≤ 5.6 (19,100)	Ø6.35 (1/4)	Ø12.7 (1/2)
< 16 (54,600)	Ø9.52 (3/8)	Ø15.88 (5/8)
≤ 22.4 (76,400)	Ø9.52 (3/8)	Ø19.05 (3/4)

Total pipe length = A+B+C+a+b+c+d+e ≤ 145m (475.7ft)

L	Longest pipe length	* Equivalent pipe length
	A+B+b ≤ 70m (230ft)	A+B+b ≤ 90m (295.2ft)
l	Longest pipe length after 1st branch	
	B+b ≤ 40m (131ft)	
H	Difference in height(Outside Unit ↔ Indoor Unit)	
	H ≤ 30m (98.4ft)	
h	Difference in height (Indoor Unit ↔ Indoor Unit)	
	h ≤ 15m (49ft)	

* : Assume equivalent pipe length of Y branch to be 0.5m (1.6ft), that of header to be 1m (3.3ft), calculation purpose.

CAUTION

It is recommended that indoor unit is installed at lower position than the header.

WARNING

It is recommended that difference of piping length for pipes connected to the Indoor Unit is minimized. Performance difference between Indoor Units may occur.

Calculation of amount of refrigerant

The calculation of the additional charge should take into account the length of pipe.

Ⓐ	Product Charge (kg(lbs))	
Ⓑ	Additional charge (kg(lbs))	
=	Total liquid pipe (m(ft)): Ø22.2mm (7/8inch)	x 0.237lbs/ft
+	Total liquid pipe (m(ft)): Ø19.05mm (3/4inch)	x 0.178lbs/ft
+	Total liquid pipe (m(ft)): Ø15.88mm (5/8inch)	x 0.116lbs/ft
+	Total liquid pipe (m(ft)): Ø12.7mm (1/2inch)	x 0.079lbs/ft
+	Total liquid pipe (m(ft)): Ø9.52mm (3/8inch)	x 0.041lbs/ft
+	Total liquid pipe (m(ft)): Ø6.35mm (1/4inch)	x 0.015lbs/ft
+	CF(kg(lbs)) (Correction Factor)	
Total amount(kg(lbs))		= Ⓐ + Ⓑ

CAUTION If a negative result is obtained from the calculation, no refrigerant needs to be added.

Ex) 10HP

- Ⓐ Outside unit
- Ⓑ Header branch
- Ⓒ Indoor unit

- A : Ø9.52 (3/8), 50m (164ft)
- B : Ø9.52 (3/8), 10m (33ft)
- C : Ø9.52 (3/8), 10m (33ft)
- D : Ø9.52 (3/8), 10m (33ft)
- E : Ø 6.35 (1/4), 10m (33ft)

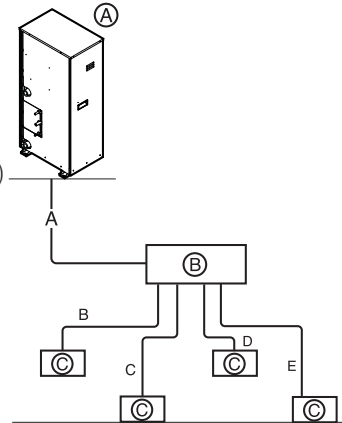

$$\begin{aligned}
 \text{Additional Charge} &= A \times 0.041 + B \times 0.041 + C \times 0.041 \\
 &\quad + D \times 0.041 + E \times 0.015 + HR + CF \\
 &= 164 \times 0.041 + 33 \times 0.041 + 33 \times 0.041 \\
 &\quad + 33 \times 0.041 + 33 \times 0.015 + 0(CF) \\
 &= 11.3\text{lbs (5.1kg)}
 \end{aligned}$$

Correction factor of Indoor unit

(Unit : lbs)

Type \ Capacity (Btu/h)	5k	7k	9k	12k	15k	18k	24k	28k	30k	36k	42k	48k	54k
Ceiling Consealed Duct(Low Static)		0.37	0.37	0.37	0.37	0.82	0.82						
Ceiling Consealed Duct(High Static)		0.57	0.57	0.57	0.57 0.97#	0.57 0.97#	0.57 0.97#	0.97		0.97	0.97	1.37	1.37
Wall Mounted(ARTCOOL Mirror)		0.53	0.53	0.53	0.53	0.62	0.62						
1way Ceiling Cassette		0.44	0.44	0.44									
2way Ceiling Cassette						0.35	0.35						
4way Ceiling Cassette	0.40	0.40	0.55 1.17##	0.55 1.17##	0.71 1.17##	0.71 1.48##	1.06 1.48##	1.06		1.41	1.41	1.41	
Floor Standing		0.37	0.37	0.37	0.37	0.82	0.82						
Ceiling & Floor			0.22	0.22									
Ceiling Suspended						0.77	0.77						
Vertical AHU				1.04		1.04	1.04		1.04	1.57	2.00	2.00	2.00

Note:

Fill in the f-gas Label attached on outside about the quantity of the fluorinated greenhouse gases

① Manufacturing site (See Model Name label)

② Installation site (If possible being placed adjacent to the service points for the addition or removal of refrigerant)

③ The total Charge (①+②)

: Use only ARNU153BGA2, ARNU183BGA2, ARNU243BGA2

##: Use only ARNU093TPAA, ARNU123TPAA, ARNU153TPAA, ARNU183TNA, ARNU243TNA

⚠ CAUTION

If a negative result is obtained from the calculation, no refrigerant needs to be added.

WARNING**Regulation for refrigerant leakage**

: the amount of refrigerant leakage should satisfy the following equation for human safety.

$$\frac{\text{Total amount of refrigerant in the system}}{\text{Volume of the room at which Indoor Unit of the least capacity is installed}} \leq 0.44\text{kg/m}^3 (0.028\text{lbs/ft}^3)$$

If the above equation can not be satisfied, then follow the following steps.

- Selection of air conditioning system: select one of the next
 1. Installation of effective opening part
 2. Reconfirmation of Outside Unit capacity and piping length
 3. Reduction of the amount of refrigerant
 4. Installation of 2 or more security device (alarm for gas leakage)
- Change Indoor Unit type

: installation position should be over 2m (6.6ft) from the floor (Wall mounted type → Cassette type)
- Adoption of ventilation system

: choose ordinary ventilation system or building ventilation system
- Limitation in piping work

: Prepare for earthquake and thermal stress

⚠ WARNING

Refer to model information since the CF Value of correction factor differs depending on model.

Distribution Method

1. Line Distribution

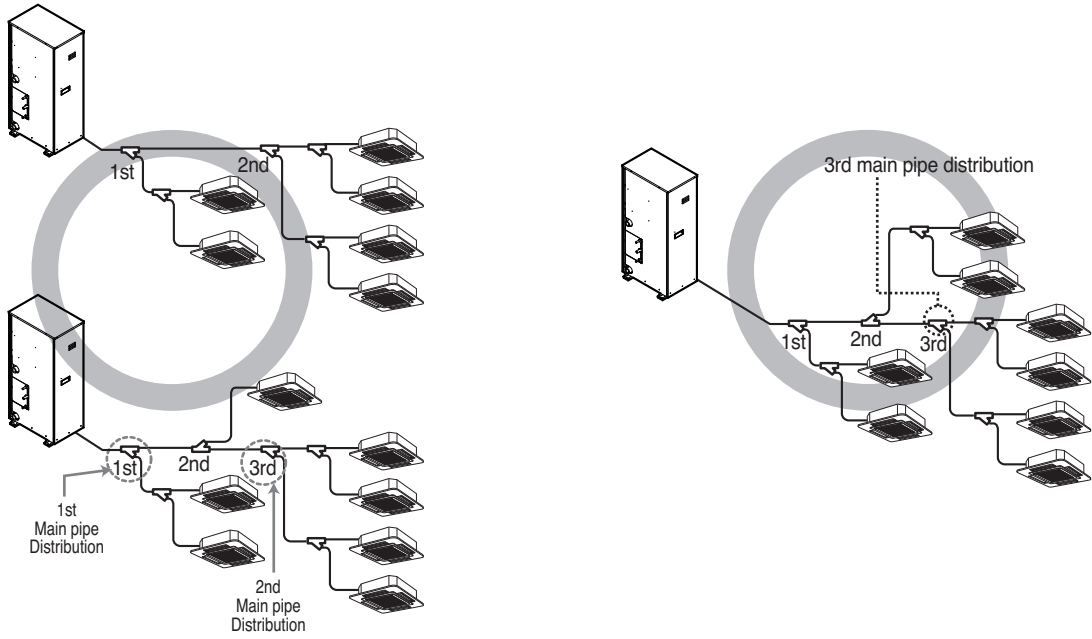

2. Vertical Distribution

Ensure that the branch pipes are attached vertically.

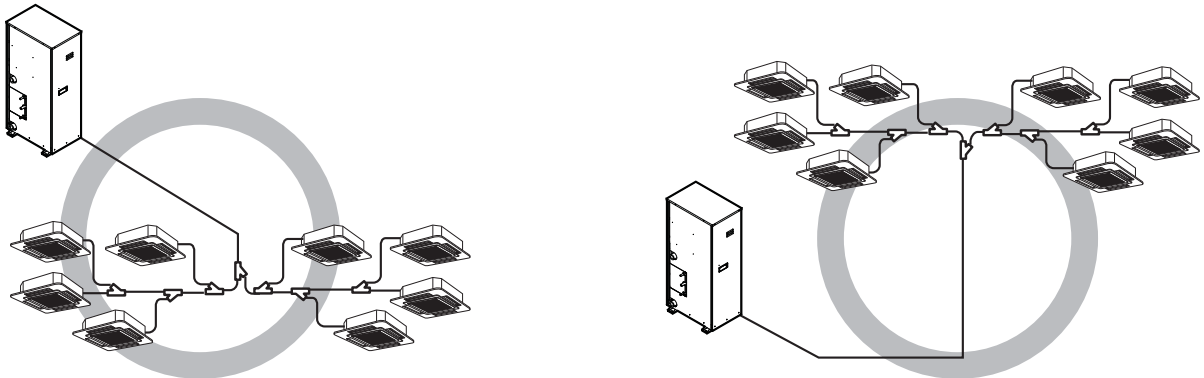

3. The others

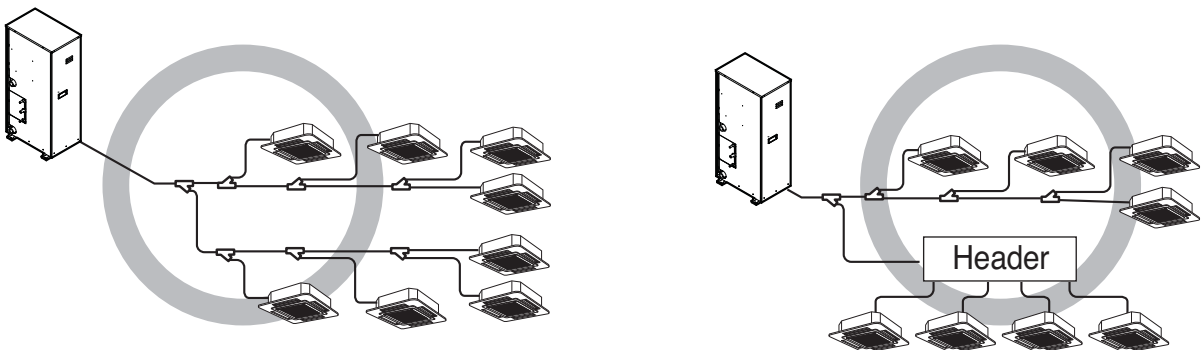

Caution

- Use the following materials for refrigerant piping.
 - Material: Seamless phosphorous deoxidized copper pipe
 - Wall thickness : Comply with the relevant local and national regulations for the designed pressure 3.8MPa. We recommend the following table as the minimum wall thickness.

Outer diameter [mm(inch)]	6.35 (1/4)	9.52 (3/8)	12.7 (1/2)	15.88 (5/8)	19.05 (3/4)	22.2 (7/8)	25.4 (1)	28.58 (1-1/8)	31.8 (1-1/4)	34.9 (1-3/8)	38.1 (1-1/2)	41.3 (1-15/16)
Minimum thickness [mm(inch)]	0.8 (0.03)	0.8 (0.03)	0.8 (0.03)	0.99 (3.25)	0.99 (0.04)	0.99 (0.04)	0.99 (0.04)	0.99 (0.04)	1.1 (0.04)	1.21 (0.05)	1.35 (0.05)	1.43 (0.06)

- Commercially available piping often contains dust and other materials. Always blow it clean with a dry inert gas.
- Use carefully to prevent dust, water or other contaminants from entering the piping during installation.
- Reduce the number of bending portions as much as possible, and make bending radius as big as possible.
- Always use the branch piping set shown below, which are sold separately.

Y branch		Header		
		4 branch	7 branch	10 branch
ARBLN01621	ARBLN03321	ARBL054	ARBL057	ARBL1010
ARBLN07121	ARBLN14521	ARBL104	ARBL107	ARBL2010

- If the diameters of the branch piping of the designated refrigerant piping differs, use a pipe cutter to cut the connecting section and then use an adapter for connecting different diameters to connect the piping.
- Always observe the restrictions on the refrigerant piping (such as rated length, difference in height, and piping diameter).
Failure to do so can result in equipment failure or a decline in heating/cooling performance.
- A second branch cannot be made after a header. (These are shown by ⊘.)

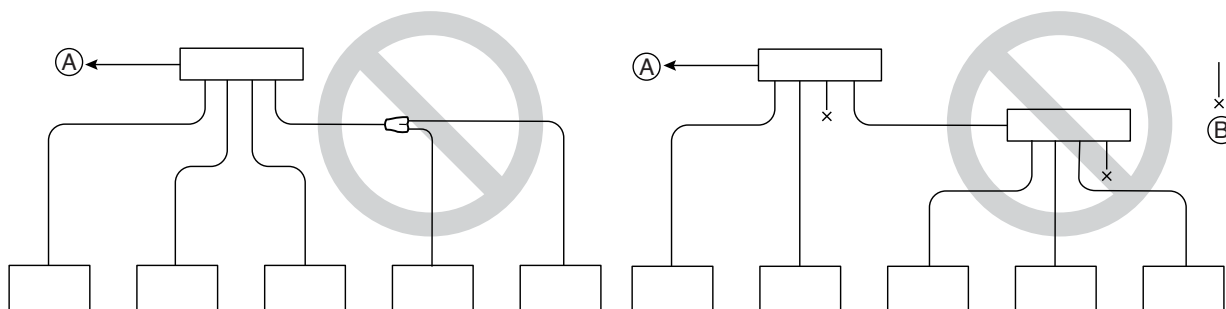

(A) To Outside Unit

(B) Sealed Piping

- The Multi V will stop due to an abnormality like excessive or insufficient refrigerant. At such a time, always properly charge the unit. When servicing, always check the notes concerning both the piping length and the amount of additional refrigerant.
- Never perform a pump down. This will not only damage the compressor but also deteriorate the performance.**
- Never use refrigerant to perform an air purge. Always evacuate using a vacuum pump.**

Refrigerant piping system

- When connecting the refrigerant piping, make sure the service valves of the Outside Unit is completely closed (the factory setting) and do not operate it until the refrigerant piping for the Outside and Indoor Units has been connected, a refrigerant leakage test has been performed and the evacuation process has been completed.
- Always use a non-oxidizing brazing material for brazing the parts and do not use flux. If not, oxidized film can cause clogging or damage to the compressor unit and flux can harm the copper piping or refrigerant oil.
- Take care so that there is no thermal damage on the service valves of the outside unit. (Especially packing part of service port.) Wrap the service valve with a wet towel when brazing it.

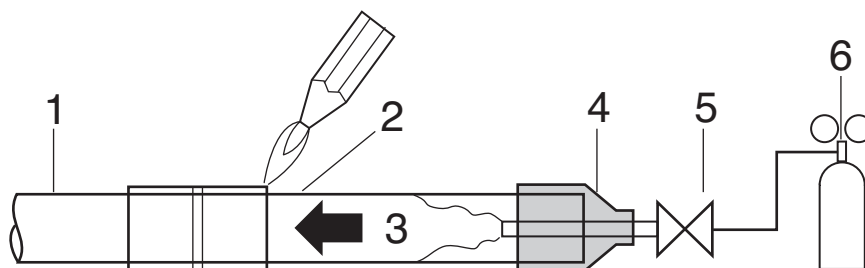

1	Refrigerant piping	4	Taping
2	Pipe to be brazed	5	Valve
3	Nitrogen	6	Pressure-reducing valve

WARNING

When installing and moving the air conditioner to another site, be sure to make recharge refrigerant after perfect evacuation.

- If a different refrigerant or air is mixed with the original refrigerant, the refrigerant cycle may malfunction and the unit may be damaged.
- After selecting diameter of the refrigerant pipe to suit total capacity of the indoor unit connected after branching, use an appropriate branch pipe set according to the pipe diameter of the indoor unit and the installation pipe drawing.



WARNING

Do not use anti-oxidants when brazing the pipe joints. Residue can clog pipes and break equipment.

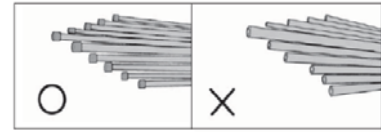
- Pipe must be able to obtain the specified thickness and should be used with low impurities.
 - Also when handling storage, pipe must be careful to prevent a fracture, deformity and wound.
- Should not be mixed with contaminations such as dust, moisture.

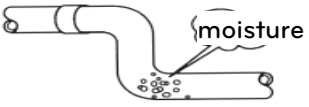

Refrigerant piping on three principles

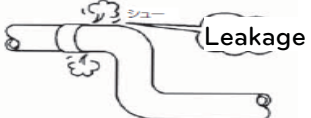
	Drying	Cleanliness	Airtight
	Should be no moisture inside	No dust inside.	There is no refrigerant leakage
Items			
Cause failure	<ul style="list-style-type: none"> • Significant hydrolysis of refrigerant oil • Degradation of refrigerant oil • Poor insulation of the compressor • Do not cold and warm • Clogging of EEV, Capillary 	<ul style="list-style-type: none"> • Degradation of refrigerant oil • Poor insulation of the compressor • Do not cold and warm • Clogging of EEV, Capillary 	<ul style="list-style-type: none"> • Gas shortages • Degradation of refrigerant oil • Poor insulation of the compressor • Do not cold and warm
Countermeasure	<ul style="list-style-type: none"> • No moisture in the pipe • Until the connection is completed, the plumbing pipe entrance should be strictly controlled. • Stop plumbing at rainy day. • Pipe entrance should be taken side or bottom. • When removal burr after cutting pipe, pipe entrance should be taken down. • Pipe entrance should be fitted cap when pass through the walls. 	<ul style="list-style-type: none"> • No dust in the pipe. • Until the connection is completed, the plumbing pipe entrance should be strictly controlled. • Pipe entrance should be taken side or bottom. • When removal burr after cutting pipe, pipe entrance should be taken down. • Pipe entrance should be fitted cap when pass through the walls. 	<ul style="list-style-type: none"> • Airtightness test should be. • Brazing operations to comply with standards. • Flare to comply with standards. • Flange connections to comply with standards.

Nitrogen substitution method

Welding, as when heating without nitrogen substitution a large amount of the oxide film is formed on the internal piping.

The oxide film is caused by clogging EEV, Capillary, oil hole of accumulator and suction hole of oil pump in compressor.

It prevents normal operation of the compressor.

In order to avoid this problem, Welding should be done after replacing air by nitrogen gas.

When welding plumbing pipe, the work is required.

How to work

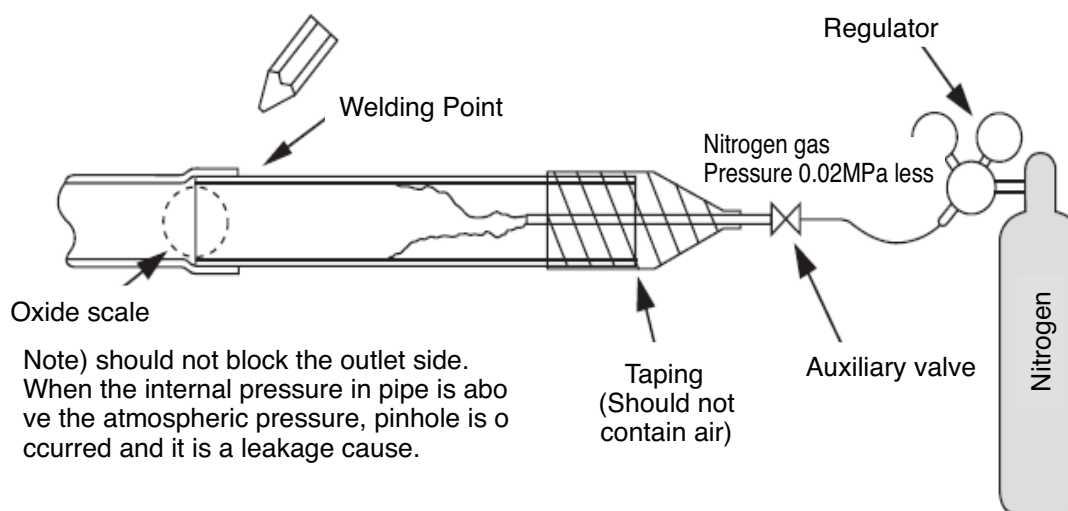

CAUTION

1. Always use the nitrogen.(not use oxygen, carbon dioxide, and a Chevron gas):
Please use the following nitrogen pressure 0.02MPa
Oxygen ----- Promotes oxidative degradation of refrigerant oil. Because it is flammable, it is strictly prohibited to use
Carbon dioxide --- Degrade the drying characteristics of gas
Chevron Gas ---- Toxic gas occurs when exposed to direct flame.
2. Always use a pressure reducing valve.
3. Please do not use commercially available antioxidant.
The residual material seems to be the oxide scale is observed.
In fact, due to the organic acids generated by oxidation of the alcohol contained in the anti-oxidants, ants nest corrosion occurs. (causes of organic acid alcohol + copper + water + temperature).

7.5 Selection of refrigerant piping

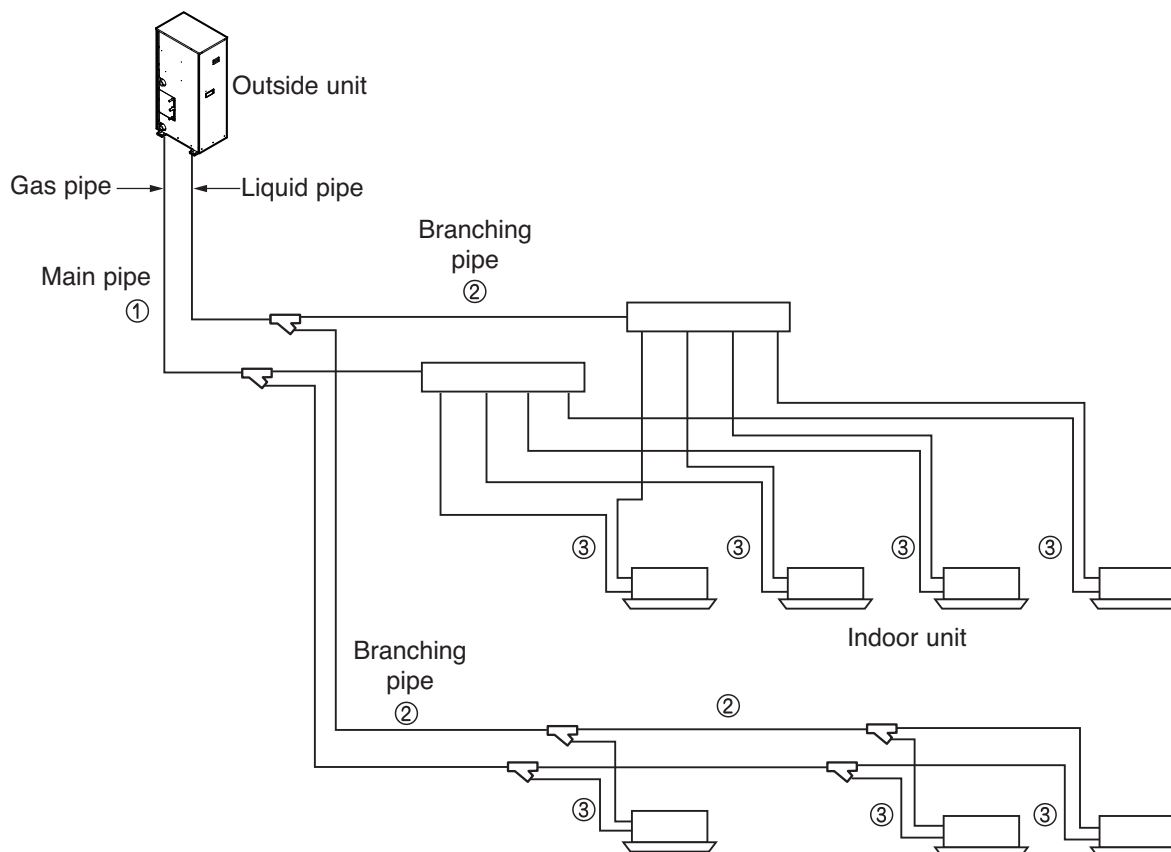

No.	Piping parts	Name	Selection of pipe size												
①	Outside unit ↓ 1st branching section	Main pipe	Size of main pipe <table border="1"> <thead> <tr> <th>Outside unit capacity</th> <th>Liquid pipe [mm (inch)]</th> <th>Gas pipe [mm (inch)]</th> </tr> </thead> <tbody> <tr> <td>4HP</td> <td>Ø9.52 (3/8)</td> <td>Ø19.05 (3/4)</td> </tr> <tr> <td>5HP</td> <td>Ø9.52 (3/8)</td> <td>Ø19.05 (3/4)</td> </tr> <tr> <td>6HP</td> <td>Ø9.52 (3/8)</td> <td>Ø19.05 (3/4)</td> </tr> </tbody> </table>	Outside unit capacity	Liquid pipe [mm (inch)]	Gas pipe [mm (inch)]	4HP	Ø9.52 (3/8)	Ø19.05 (3/4)	5HP	Ø9.52 (3/8)	Ø19.05 (3/4)	6HP	Ø9.52 (3/8)	Ø19.05 (3/4)
Outside unit capacity	Liquid pipe [mm (inch)]	Gas pipe [mm (inch)]													
4HP	Ø9.52 (3/8)	Ø19.05 (3/4)													
5HP	Ø9.52 (3/8)	Ø19.05 (3/4)													
6HP	Ø9.52 (3/8)	Ø19.05 (3/4)													
②	Branching section ↓ Branching section	Branching pipe	Pipe size of between branching sections <table border="1"> <thead> <tr> <th>Indoor unit capacity[kW (Btu/h)]</th> <th>Liquid pipe [mm (inch)]</th> <th>Gas pipe [mm (inch)]</th> </tr> </thead> <tbody> <tr> <td>≤ 5.6 (19,100)</td> <td>Ø6.35 (1/4)</td> <td>Ø12.7 (1/2)</td> </tr> <tr> <td>< 16.0 (54,600)</td> <td>Ø9.52 (3/8)</td> <td>Ø15.88 (5/8)</td> </tr> <tr> <td>< 22.4 (76,400)</td> <td>Ø9.52 (3/8)</td> <td>Ø19.05 (3/4)</td> </tr> </tbody> </table>	Indoor unit capacity[kW (Btu/h)]	Liquid pipe [mm (inch)]	Gas pipe [mm (inch)]	≤ 5.6 (19,100)	Ø6.35 (1/4)	Ø12.7 (1/2)	< 16.0 (54,600)	Ø9.52 (3/8)	Ø15.88 (5/8)	< 22.4 (76,400)	Ø9.52 (3/8)	Ø19.05 (3/4)
Indoor unit capacity[kW (Btu/h)]	Liquid pipe [mm (inch)]	Gas pipe [mm (inch)]													
≤ 5.6 (19,100)	Ø6.35 (1/4)	Ø12.7 (1/2)													
< 16.0 (54,600)	Ø9.52 (3/8)	Ø15.88 (5/8)													
< 22.4 (76,400)	Ø9.52 (3/8)	Ø19.05 (3/4)													
③	Branching section ↓ Indoor unit	Indoor unit connecting pipe	Connecting pipe size of indoor unit <table border="1"> <thead> <tr> <th>Indoor unit capacity[kW (Btu/h)]</th> <th>Liquid pipe [mm (inch)]</th> <th>Gas pipe [mm (inch)]</th> </tr> </thead> <tbody> <tr> <td>≤ 5.6 (19,100)</td> <td>Ø6.35 (1/4)</td> <td>Ø12.7 (1/2)</td> </tr> <tr> <td>< 16.0 (54,600)</td> <td>Ø9.52 (3/8)</td> <td>Ø15.88 (5/8)</td> </tr> </tbody> </table>	Indoor unit capacity[kW (Btu/h)]	Liquid pipe [mm (inch)]	Gas pipe [mm (inch)]	≤ 5.6 (19,100)	Ø6.35 (1/4)	Ø12.7 (1/2)	< 16.0 (54,600)	Ø9.52 (3/8)	Ø15.88 (5/8)			
Indoor unit capacity[kW (Btu/h)]	Liquid pipe [mm (inch)]	Gas pipe [mm (inch)]													
≤ 5.6 (19,100)	Ø6.35 (1/4)	Ø12.7 (1/2)													
< 16.0 (54,600)	Ø9.52 (3/8)	Ø15.88 (5/8)													

Branch pipe Fitting

■ Y branch

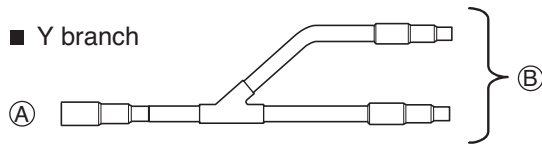

(A) To Outside Unit
(B) To Branch Piping or Indoor Unit

- Ensure that the branch pipes are attached horizontally or vertically (see the diagram below.)

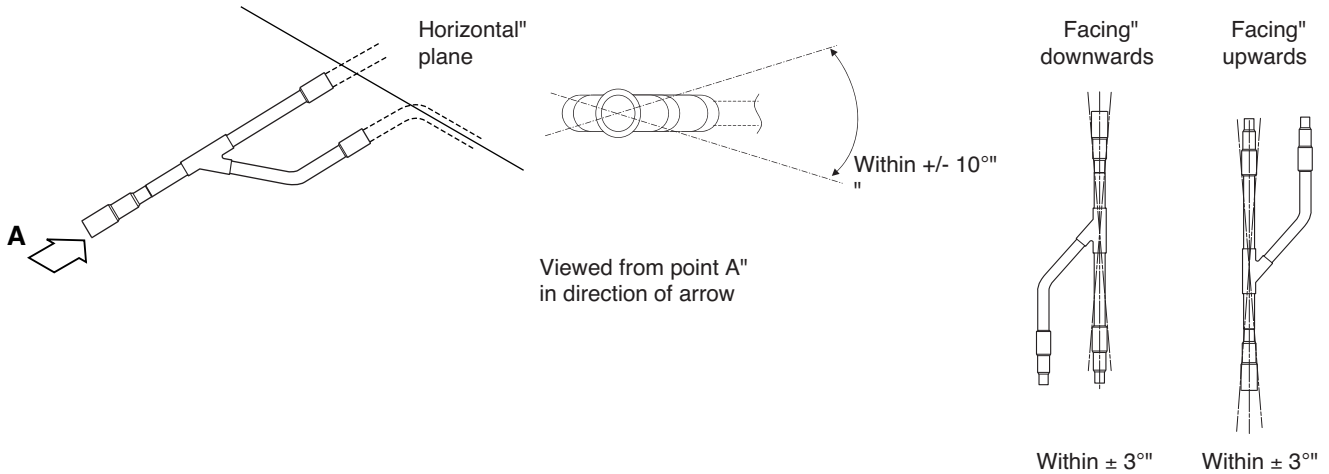

- There is no limitation on the joint mounting configuration.
- If the diameter of the refrigerant piping selected by the procedures described is different from the size of the joint, the connecting section should be cut with a pipe cutter.
- Branch pipe should be insulated with the insulator in each kit.

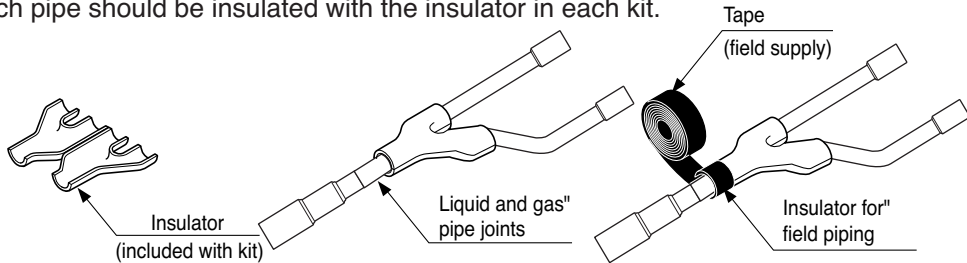

■ Header

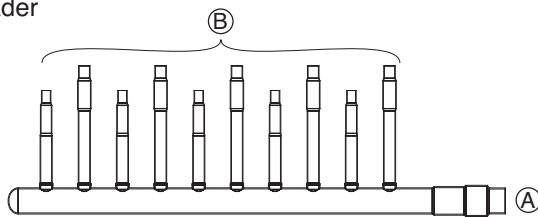

(A) To outside unit
(B) To indoor unit

- The indoor unit having larger capacity must be installed closer to (A) than smaller one.
- If the diameter of the refrigerant piping selected by the procedures described is different from the size of the joint, the connecting section should be cut with a pipe cutter.

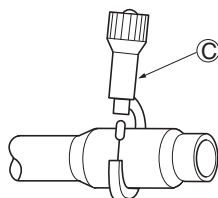

(C) Pipe cutter

- When the number of pipes to be connected is smaller than the number of header branches, install a cap to the unconnected branches.

- When the number of indoor units to be connected to the branch pipes is less than the number of branch pipes available for connection then cap pipes should be fitted to the surplus branches.

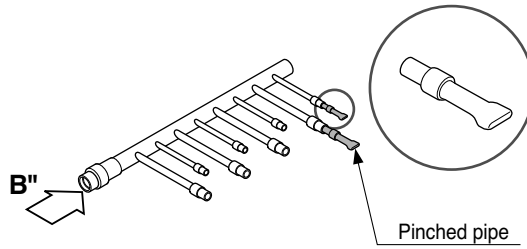

- Fit branch pipe lie in a horizontal plane.

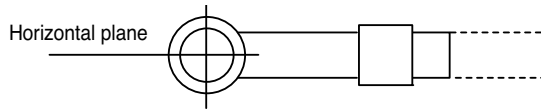

View from point B in the direction of the arrow

- Header should be insulated with the insulator in each kit.

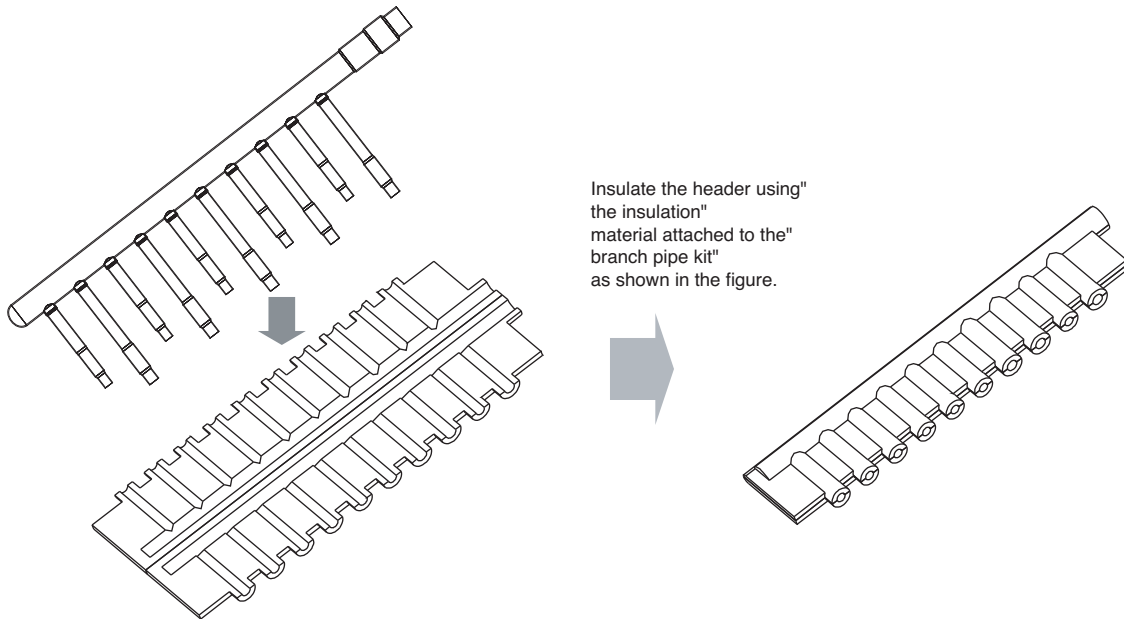

- Joints between branch and pipe should be sealed with the tape included in each kit.

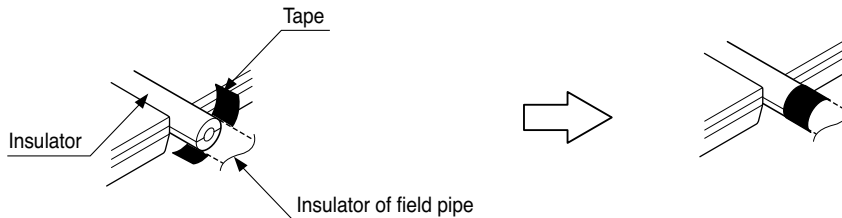

- Any cap pipe should be insulated using the insulator provided with each kit and then taped as described above.

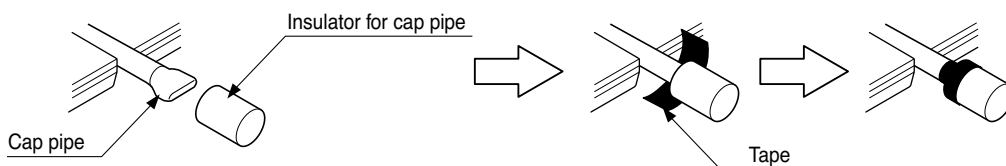

Thermal insulation of refrigerant piping

Be sure to give insulation work to refrigerant piping by covering liquid pipe and gas pipe separately with enough thickness heat-resistant polyethylene, so that no gap is observed in the joint between indoor unit and insulating material, and insulating materials themselves. When insulation work is insufficient, there is a possibility of condensation drip, etc. Pay special attention to insulation work to ceiling plenum.

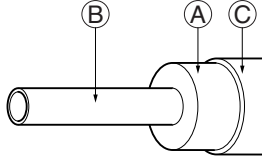

- (A) Heat insulation material"
- (B) Pipe "
- (C) Outer covering"
(Wind the connection part and cutting part of heat insulation material with a finishing tape.)

Heat insulation material	Adhesive + Heat - resistant polyethylene foam + Adhesive tape	
Outer covering	Indoor	Vinyl tape
	Floor exposed	Water-proof hemp cloth + Bronze asphalt
	Outside"	Water-proof hemp cloth + " inc plate + Oily paint

Note:
When using polyethylene cover as covering material, asphalt roofing shall not be required.

Bad example	<p>*"Do not insulate gas or low pressure pipe and liquid or high pressure pipe together.</p> <ul style="list-style-type: none"> (A) Liquid pipe (B) Gas pipe (C) Power lines (D) Finishing tape (E) Insulating material (F) Transmission lines 	<p>*"Be sure to fully insulate connecting portion.</p> <p>(A) These parts are not insulated.</p>
Good example	<ul style="list-style-type: none"> (A) Liquid pipe (B) Gas pipe (C) Power lines (D) Insulating material (E) Transmission lines 	

Penetrations

Inner wall (concealed)

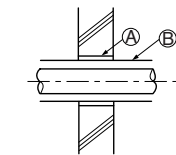

Floor (fireproofing)

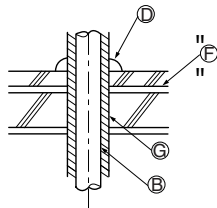

Outer wall

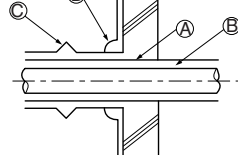

Roof pipe shaft

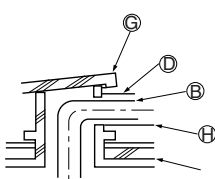

Outer wall (exposed)

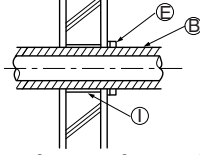

Penetrating portion on fire " limit and boundary wall

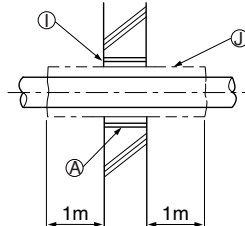

- (A) Sleeve"
- (B) Heat insulating material"
- (C) Lagging"
- (D) Caulking material"
- (E) Band"
- (F) Waterproofing layer"
- (G) Sleeve with edge"
- (H) Lagging material"
- (I) Mortar or other incombustible caulking"
- (J) Incombustible heat insulation material"

When filling a gap with mortar, cover the penetration part with steel plate so that the insulation material will not be caved in. For this part, use incombustible materials for both insulation and covering. (Vinyl covering should not be used.)

Y branch pipe and header branch pipe type

Y branch pipe

ENGLISH

[unit:mm (inch)]

Models	Gas pipe	Liquid pipe
ARBLN01621		
ARBLN03321		
ARBLN07121		
ARBLN14521		

Header

[unit:mm (inch)]

Models	Gas pipe	Liquid pipe
4 branch ARBL054		
7 branch ARBL057		
4 branch ARBL104		
7 branch ARBL107		
10 branch ARBL1010		
10 branch ARBL2010		

Leakage test and vacuum

Leak test

Leak test should be made by pressurizing nitrogen gas to 3.8MPa (38.7kgf/cm²). If the pressure does not drop for 24 hours, the system passes the test. If the pressure drops, check where the nitrogen leaks. For the test method, refer to the following figure. (Make a test with the service valves closed. Be also sure to pressurize liquid pipe, gas pipe and high/low pressure common pipe). The test result can be judged good if the pressure has not be reduced after leaving for about one day after completion of nitrogen gas pressurization.

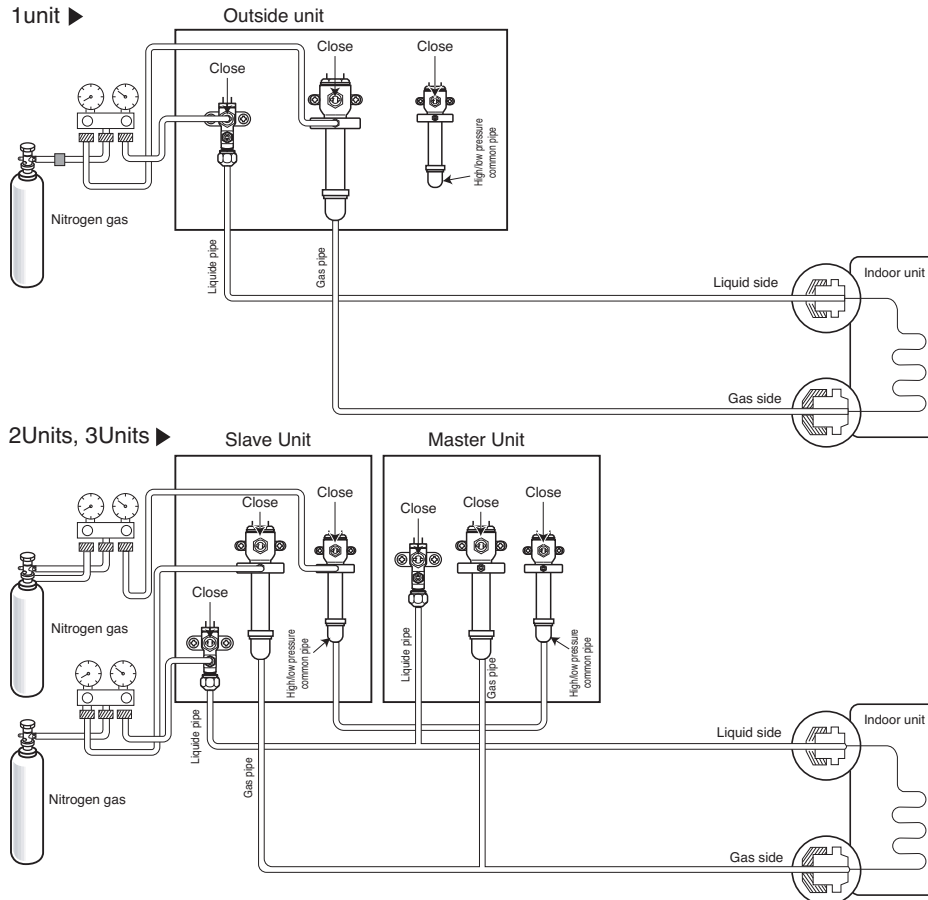

Note:

If the ambient temperature differs between the time when pressure is applied and when the pressure drop is checked, apply the following correction factor

There is a pressure change of approximately 0.1kg/cm² (0.01MPa) for each 1°C of temperature difference.

Correction= (Temp. at the time of pressurization – Temp. at the time of check) X 0.1

For example: Temperature at the time of pressurization (3.8MPa) is 27°C

24hour later: 3.73MPa, 20°C

In this case the pressure drop of 0.07 is because of temperature drop

And hence there is no leakage in pipe occurred.

CAUTION

To prevent the nitrogen from entering the refrigeration system in the liquid state, the top of the cylinder must be at higher position than the bottom when you pressurize the system. Usually the cylinder is used in a vertical standing position.

Vacuum

Vacuum drying should be made from the service port provided on the outside unit's service valve to the vacuum pump commonly used for liquid pipe, gas pipe and high/low pressure common pipe. (Make Vacuum from liquid pipe, gas pipe and high/low pressure common pipe with the service valve closed.)

* Never perform air purging using refrigerant.

• Vacuum drying: Use a vacuum pump that can evacuate to -100.7kPa (5Torr, -755mmHg).

1. Evacuate the system from the liquid and gas pipes with a vacuum pump for over 2hrs and bring the system to -100.7kPa .

After maintaining system under that condition for over 1hr, confirm the vacuum gauge rises. The system may contain moisture or leak.

2. Following should be executed if there is a possibility of moisture remaining inside the pipe.

(Rainwater may enter the pipe during work in the rainy season or over a long period of time)

After evacuating the system for 2hrs, give pressure to the system to 0.05MPa (vacuum break) with nitrogen gas and then evacuate it again with the vacuum pump for 1hr to -100.7kPa (vacuum drying). If the system cannot be evacuated to -100.7kPa within 2hrs, repeat the steps of vacuum break and its drying.

Finally, check if the vacuum gauge does not rise or not, after maintaining the system in vacuum for 1 hr.

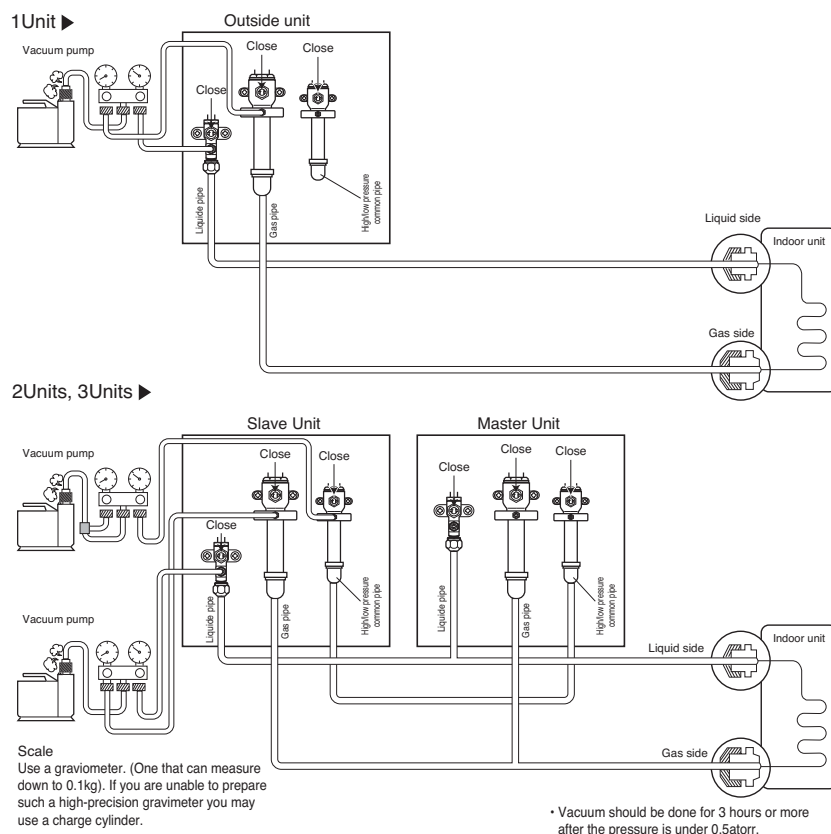

Note : Always add an appropriate amount of refrigerant. (For the refrigerant additional charge)

Too much or too little refrigerant will cause trouble.

To use the Vacuum Mode

(If the Vacuum mode is set, all valves of Indoor units and Outside units will be opened.)

⚠ WARNING

When installing and moving the air conditioner to another site, recharge after perfect evacuation.

- If a different refrigerant or air is mixed with the original refrigerant, the refrigerant cycle may malfunction and the unit may be damaged.

Electrical Wiring

1. Follow ordinance of your governmental organization for technical standard related to electrical equipment, wiring regulations and guidance of each electric power company.

⚠ WARNING

Be sure to have authorized electrical engineers do the electric work using special circuits in accordance with regulations and this installation manual. If power supply circuit has a lack of capacity or electric work deficiency, it may cause an electric shock or fire.

2. Install the Outside Unit transmission line away from the power source wiring so that it is not affected by electric noise from the power source. (Do not run it through the same conduit.)
3. Be sure to provide designated grounding work to Outside Unit.

⚠ CAUTION

Be sure to correct the outside unit to earth. Do not connect earth line to any gas pipe, water pipe, lightning rod or telephone earth line. If earth is incomplete, it may cause an electric shock.

4. Give some allowance to wiring for electrical part box of Indoor and Outside Units, because the box is sometimes removed at the time of service work.
5. Never connect the main power source to terminal block of transmission line. If connected, electrical parts will be burnt out.
6. Use 2-core shield cable for transmission line. (O mark in the figure below) If transmission lines of different systems are wired with the same multiplecore cable, the resultant poor transmitting and receiving will cause erroneous operations. (⊘ mark in the figure below)
7. Only the transmission line specified should be connected to the terminal block for Outside Unit transmission.

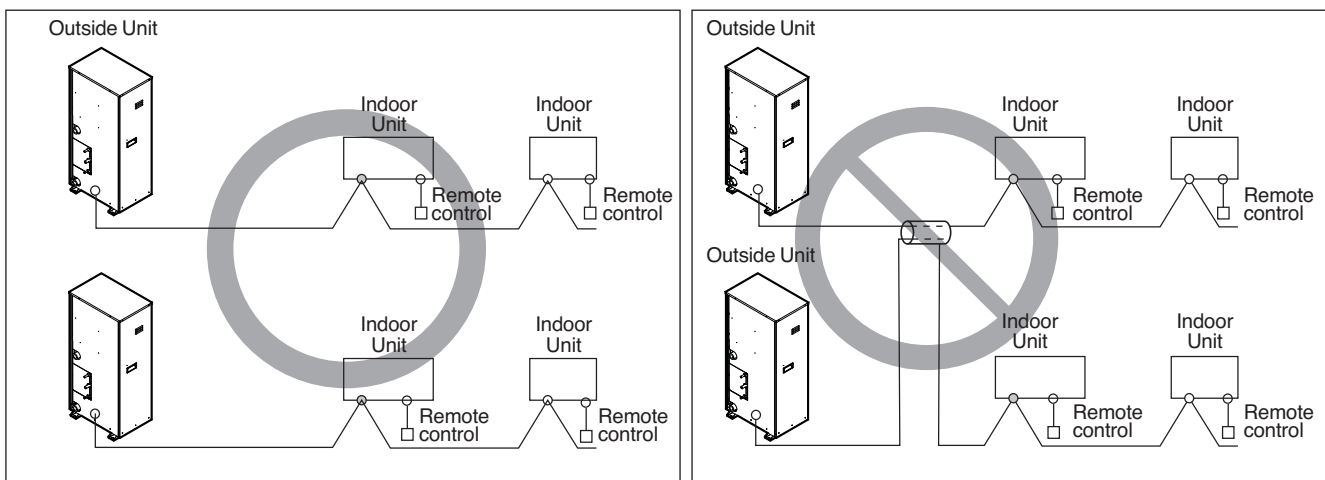

⚠ CAUTION

- This product have reversed phase protection detector that only works when the power is turned on. If there exists black out or the power goes on and off which the product is operating, attach a reversed phase protection circuit locally. running the product in reversed phase may break the compressor and other parts.
- Use the 2-core shield cables for communication lines. Never use them together with power cables.
- The conductive shielding layer of cable should be grounded to the metal part of both units.
- Never use multi-core cable
- As this unit is equipped with an inverter, to install a phase leading capacitor not only will deteriorate power factor improvement effect, but also may cause capacitor abnormal heating. Therefore, never install a phase leading capacitor.
- Make sure that the power unbalance ratio is not greater than 2%. If it is greater, the unit's lifespan will be reduced.
- Introducing with a missing N-phase or with a mistaken N-phase will break the equipment.

◆ Precautions when laying power wiring

Use round pressure terminals for connections to the power terminal block.

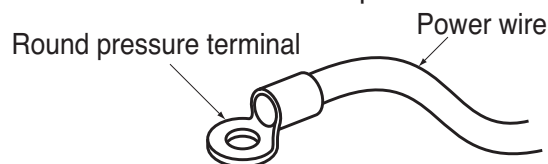

When none are available, follow the instructions below.

- Do not connect wiring of different thicknesses to the power terminal block. (Slack in the power wiring may cause abnormal heat.)
- When connecting wiring which is the same thickness, do as shown in the figure below.

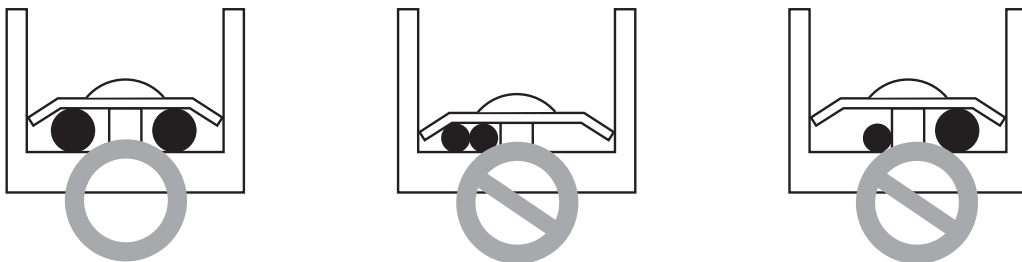

- For wiring, use the designated power wire and connect firmly, then secure to prevent outside pressure being exerted on the terminal block.
- Use an appropriate screwdriver for tightening the terminal screws. A screwdriver with a small head will strip the head and make proper tightening impossible.
- Over-tightening the terminal screws may break them.

Control Box and Wiring Location

- Unscrew all the screw, pull out the panel.
- Connect the transmission wire between outside unit and indoor unit, the connection between outside unit and central controller system pass through the sub PCB for central control.
- When connecting indoor unit with the shield cable, ground at the grounding screw.
When connecting central controller with the shield cable, ground at the grounding screw.
- Refer to next page about the distance between main power cable and communication cable.

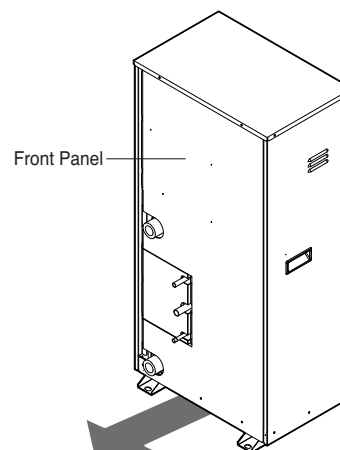

Transmission and Power Lines

1) Transmission cable

- Types : shielding wire
- Diameter : over 1.25mm²
- Maximum allowable temperature: 60°C (140°F)
- Maximum allowable line length: under 300m (984ft)

2) Remote control cable

- Types : 3-core cable

3) Simple central control cable

- Types : 4-core cable (Shielding wire)
- Use wires of size : 1.0~1.5mm²
- Insulation material : PVC

4) Separation of transmission and power lines

- If transmission and power lines are run alongside each other then there is a strong likelihood of operational faults developing due to interference in the signal wiring caused by electrostatic and electromagnetic coupling.

The tables below indicates our recommendation as to appropriate spacing of transmission and power lines where these are to be run side by side

Current capacity of power line		Spacing
100V or more	10A	300mm (11-13/16inch)
	50A	500mm (19-11/16inch)
	100A	1,000mm (39-3/8inch)
	Exceed 100A	1,500mm (59-1/16inch)

Note:

1. The figures are based on assumed length of parallel cabling up to 100m. For length in excess of 100m the figures will have to be recalculated in direct proportion to the additional length of line involved.
 2. If the power supply waveform continues to exhibit some distortion the recommended spacing in the table should be increased.
- If the lines are laid inside conduits then the following point must also be taken into account when grouping various lines together for introduction into the conduits
 - Power lines(including power supply to air conditioner) and signal lines must not be laid inside the same
 - In the same way, when grouping the lines power and signal lines should not be bunched together.

CAUTION

If apparatus is not properly earthed then there is always a risk of electric shocks, the earthing of the apparatus must be carried out by a qualified person.

◆ Wiring of Main Power Supply and Equipment Capacity

1. Use a separate power supply for the Outside Unit and Indoor Unit.
2. Bear in mind ambient conditions (ambient temperature, direct sunlight, rain water, etc.) when proceeding with the wiring and connections.
3. The wire size is the minimum value for metal conduit wiring. The power cord size should be 1 rank thicker taking into account the line voltage drops. Make sure the power-supply voltage does not drop more than 10%.
4. Specific wiring requirements should adhere to the wiring regulations of the region.
5. Power supply cords of parts of appliances for outside use should not be lighter than polychloroprene sheathed flexible cord.
6. Do not install an individual switch or electrical outlet to disconnect each of indoor unit separately from the power supply.

WARNING

- Follow ordinance of your governmental organization for technical standard related to electrical equipment, wiring regulations and guidance of each electric power company.
- Make sure to use specified wires for connections so that no external force is imparted to terminal connections. If connections are not fixed firmly, it may cause heating or fire.
- Make sure to use the appropriate type of overcurrent protection switch. Note that generated overcurrent may include some amount of direct current.

CAUTION

- Some installation site may require attachment of an earth leakage breaker. If no earth leakage breaker is installed, it may cause an electric shock.
- Do not use anything other than breaker and fuse with correct capacity. Using fuse and wire or copper wire with too large capacity may cause a malfunction of unit or fire.

◆ Example Connection of Transmission Cable

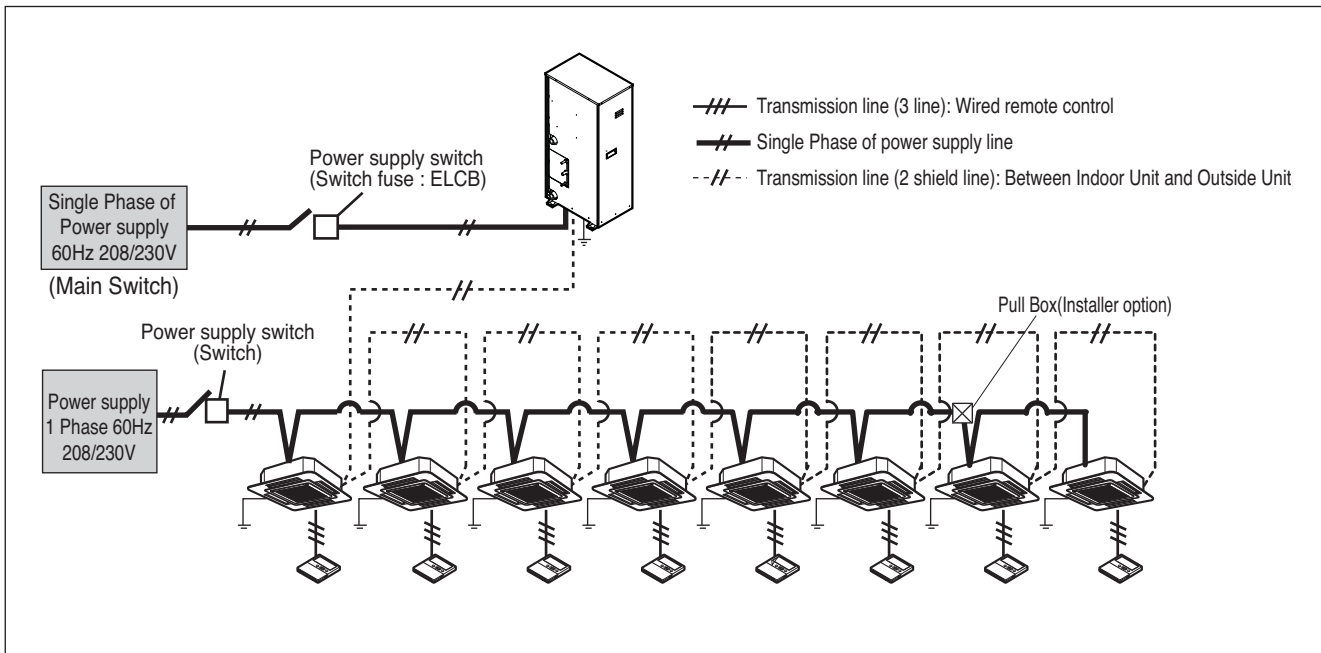

⚠ WARNING

- Indoor Unit ground Lines are required for preventing electrical shock accident during current leakage, Transmission disorder by noise effect and motor current leakage (without connection to pipe).
- Don't install an individual switch or electrical outlet to disconnect each of indoor unit separately from the power supply.
- Install the main switch that can interrupt all the power sources in an integrated manner because this system consists of the equipment utilizing the multiple power sources.
- If there exists the possibility of reversed phase, lose phase, momentary blackout or the power goes on and off while the product is operating, attach a reversed phase protection circuit locally.
Running the product in reversed phase may break the compressor and other parts.

Between Indoor and Outside unit

SODU	IDU	INTERNET	DRY1	DRY2	GND	12V
B	A					

Outside unit

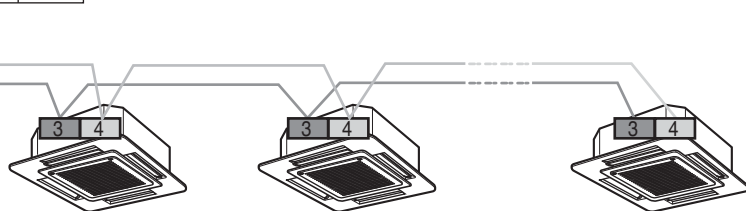

The GND terminal is a 'L' terminal for the central controller, not Ground Line

◆ Example Connection of Communication Cable

[BUS type]

- Connection of communication cable must be installed like below figure between indoor unit to outside unit.

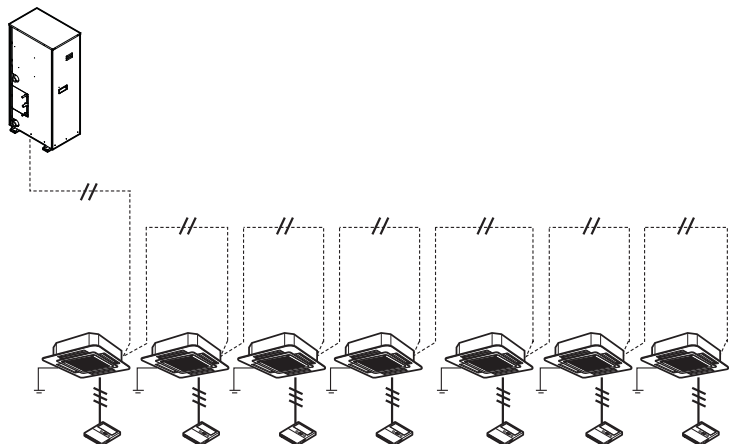

[STAR type]

- Abnormal operation can be caused by communication defect, when connection of communication cable is installed like below figure (STAR type).

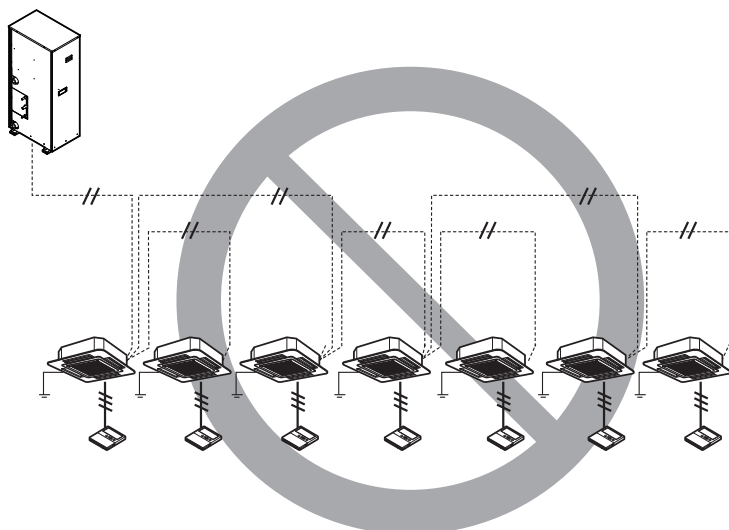

External wiring

External wires should be connected as follows.

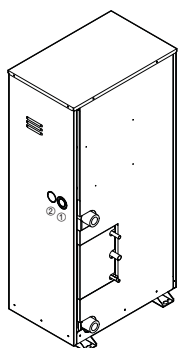

- ① Main power cable
- ② Communication cable

Connection method of the connecting cable (Example)

1. Make a hole appropriate for the passage of connection cable through on cap by tool.
2. After knocking out the holes, we recommend you paint the edges and areas around the edges using the repair paint to prevent rusting
3. Pass the connecting cable through the hole.
4. Properly connect the cable on the terminal block.
5. Fix the connection cable with the cord clamp providing on the unit not to have strain at the terminal.
6. Finally, Fix the cap to the conduit panel.

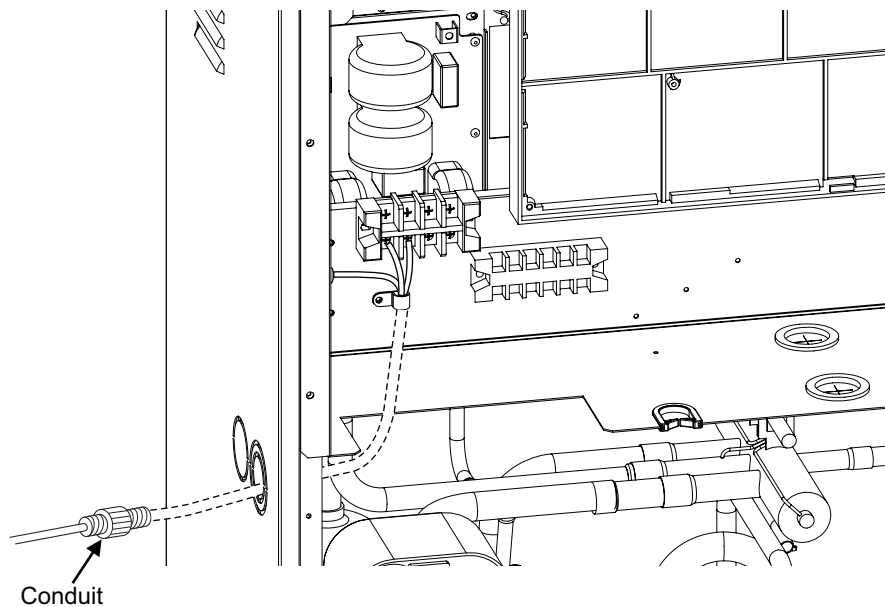

Model name	ARWN038GA2	ARWN048GA2	ARWN053GA2
AWG	10	10	10
Conduit [mm (inch)]	12.7 (1/2)	12.7 (1/2)	12.7 (1/2)
Knockout Diameter [mm (inch)]	22.2 (7/8)	22.2 (7/8)	22.2 (7/8)



WARNING

- Loose wiring may cause the terminal to overheat or result in unit malfunction.
- A fire hazard may also exist.
- Therefore, be sure all wiring is tightly connected.

Dip switch setting

1. Location of setting switch

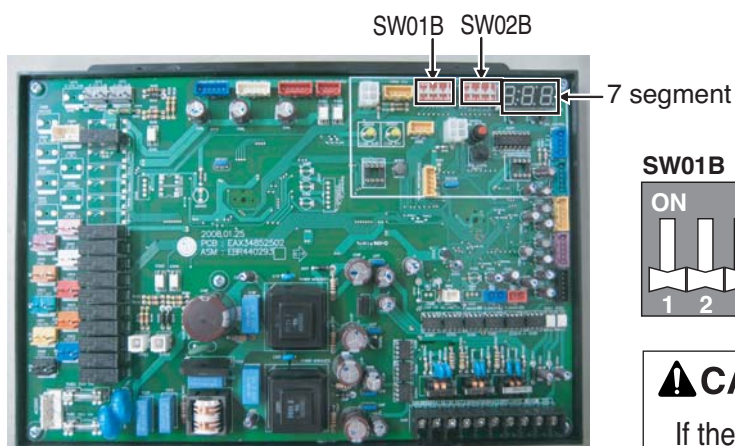

SW01B

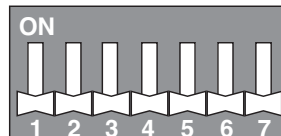

SW02B

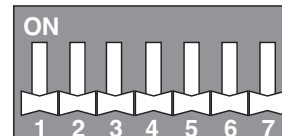

⚠ CAUTION

If the applicable dip switch is not set correctly, the product may not operate properly.

2. Dip switch setting

- 1) Set the dip switch and turn on the power of the outside unit to check whether the set value is correctly entered in the 7 segment.
- 2) This function is shown for only 2seconds after the power is connected.

■ Check outside unit setting

- The number on the 7 segment is displayed in order after the power is connected.
- This number represents the setting condition.

Order	Number	Item
1	-	Model code
2	-	Total capacity(HP)
3	2	Heat pump model
4	25	Normal mode display (If the dip switch is set incorrectly, it is not displayed.)
5	136	Model Type (Water Mini)

■ Model Code

Model Code	Unit(HP)	Powersupply	Ref.
120	4	1Ø, 208/230V	R410A
121	5		
122	6		

Electrical Wiring

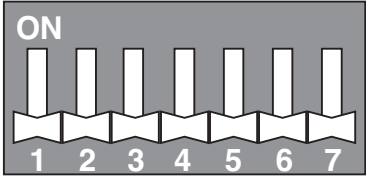
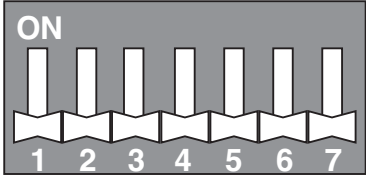
SW01B Setting	SW02B Setting	Remark
		<p>Normal mode at shipping factory</p>

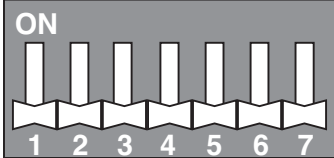
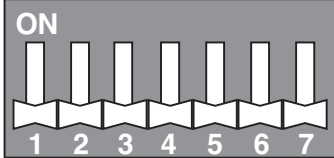
Function	SW01B Setting	SW02B Setting	Remark
<p>Standard</p>			<p>Standard mode at shipping factory</p>

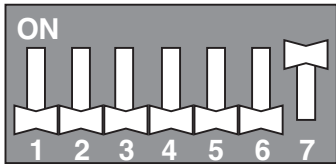
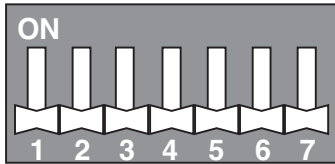
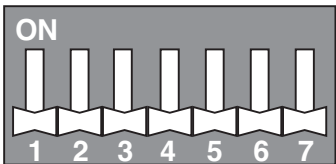
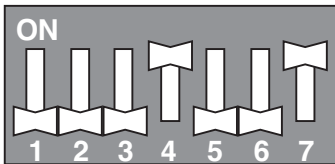
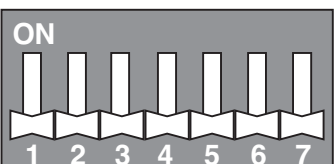
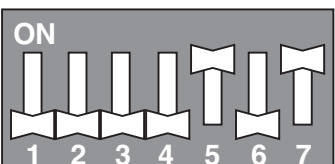
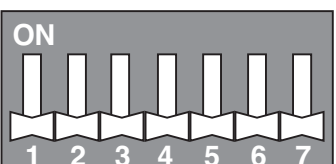
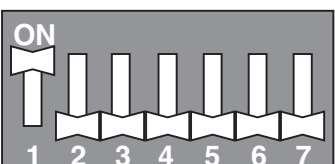
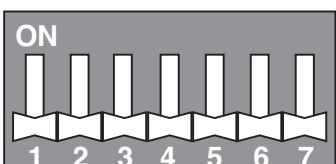
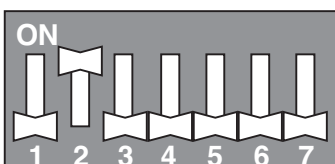
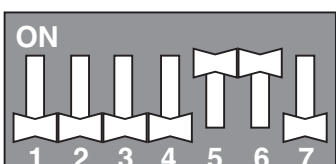
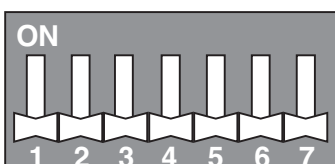
Function	SW01B Setting	SW02B Setting	Remark
Forced Oil Return			
Vacuum Mode			
Water Pipe Solenoid Valve 208/230V Functions			For water pipe Solenoid Valve 208/230V power
Ground source mode			Use this mode when temperature of circulation inlet water is under 10°C (50°F) (You should use an anti freeze)
Variable water Flow Control Mode			You should install the variable water flow valve control kit before using this mode.
Dry contact Mode			

CAUTION

- After operating the dip switch to set the additional function, you must reset the power of the main PCB to reflect the changed function. (After recovering the dip switch to cancel the additional function, you must reset the power of the main PCB to reflect the change.)
- If the dip switch is not set accurately, it can have excessive load on the product operation. Set the dip switch properly.

Indoor unit auto addressing

• The address of indoor units would be set by auto addressing

- 1) Wait for 3minutes after applying power supply.
- 2) Press the switch of the outside unit (SW02V) for 5seconds.
- 3) A "88" is indicated on 7-segment LED of the outside unit PCB.
- 4) For completing addressing, 2~7minutes are required depending on numbers of indoor unit connection set.
- 5) Numbers of indoor unit connection set whose addressing is completed are indicated for 30seconds on 7-segment LED of the outside unit PCB.
- 6) After completing addressing, address of each indoor unit is indicated on the wired remote control display window.
(CH01, CH02, CH03, CH06: Indicated as numbers of indoor unit connection set.)

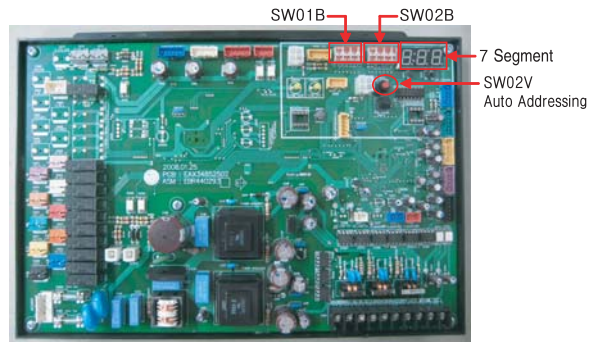

CAUTION

- In replacement of the indoor unit PCB, always perform auto address setting again. If power supply is not applied to the indoor unit, operation error occurs.
- Auto addressing is only possible on the main PCB
- Auto addressing has to be performed after 3minutes to improve communication.

◆ The Procedure of Automatic Addressing

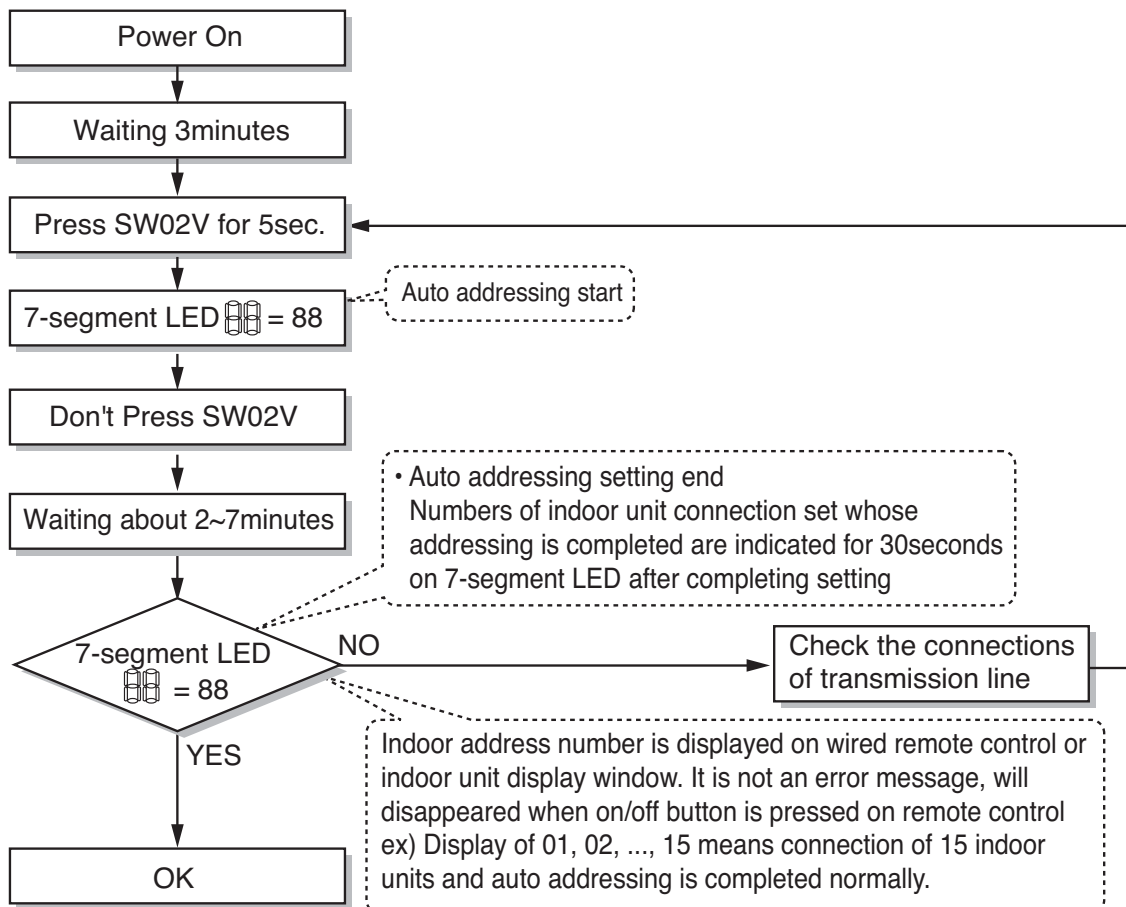

Group Number setting

Group Number setting for Indoor Units

- ① Confirm the power of whole system(Indoor Unit, Outside Unit) is OFF, otherwise turn off.
- ② The transmission lines connected to INTERNET terminal should be connected to central control of Outside unit with care for their polarity(A → A, B → B)
- ③ Turn the whole system on.
- ④ Set the group and Indoor Unit number with a wired remote control.
- ⑤ To control several sets of Indoor Units into a group, set the group ID from 0 to F for this purpose.

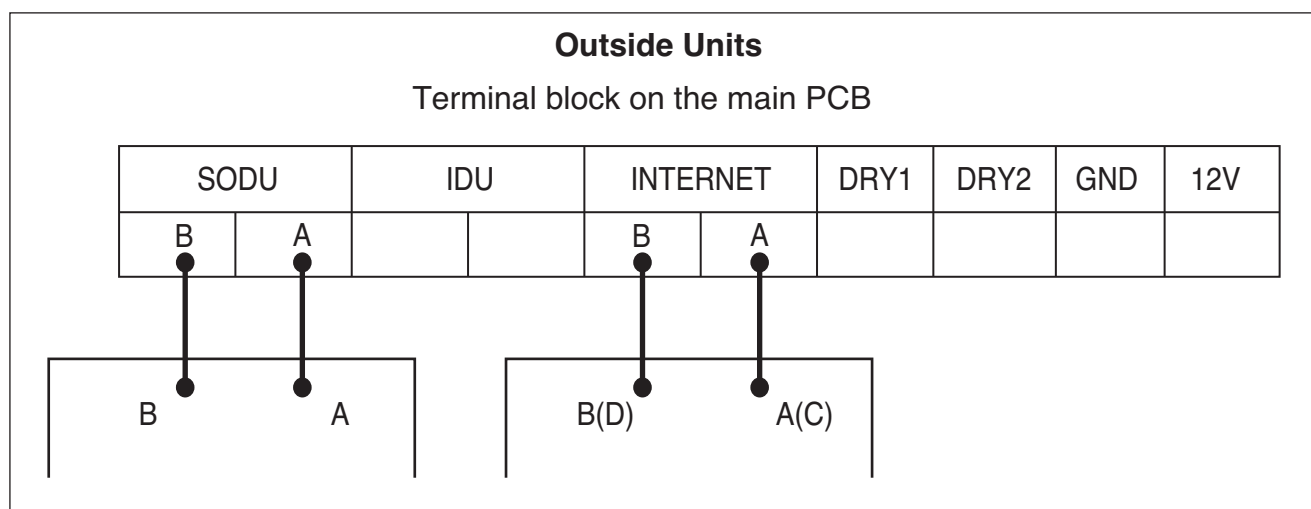

Group recognizing the simple central controller
No.0 group (00~0F)
No.1 group (10~1F)
No.2 group (20~2F)
No.3 group (30~3F)
No.4 group (40~4F)
No.5 group (50~5F)
No.6 group (60~6F)
No.7 group (70~7F)
No.8 group (80~8F)
No.9 group (90~9F)
No. A group (A0~AF)
No. B group (B0~BF)
No. C group (C0~CF)
No. D group (D0~DF)
No. E group (E0~EF)
No. F group (F0~FF)

Cool and Heat Selector Installation and Connection

- Connect wires as below figure at the hole of backside of Outside Unit Dry Contact.
- Insert the wire in the connection hole pushing the "Push" button.
- Setting Main PCB Dip SW of Master Outside Unit.

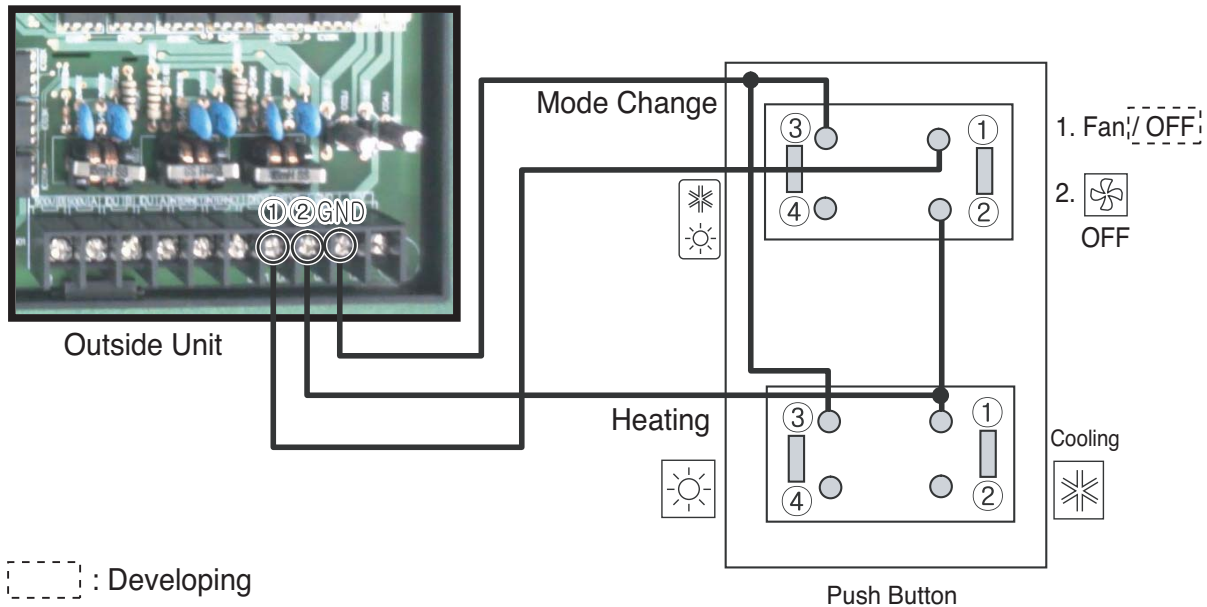

Without Cool/Heat Selector Installation and Connection

In case, try to set mode without Cool/Heat Selector and try to use other switch except from LG Outside Cool/Heat Selector in field.

Connect signal terminal block as below figure and description.

- How to set mode without Cool/Heat Selector

• Cooling Mode Setting

- ① → GND Connection
- ② → Off (Open)

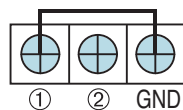

• Heating Mode Setting

- ① → GND Connection
- ② → GND Connection

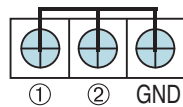

• Fan/ All OFF Mode Setting

- ① → Off (Open)
- ② → GND Connection

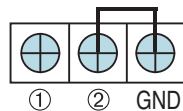

Test Run

Water supply system test run

- Before executing the test run for the product, you must first test the heat source water system. The test run for the product must be executed after checking the flow rate and temperature of the heat source water supplied.

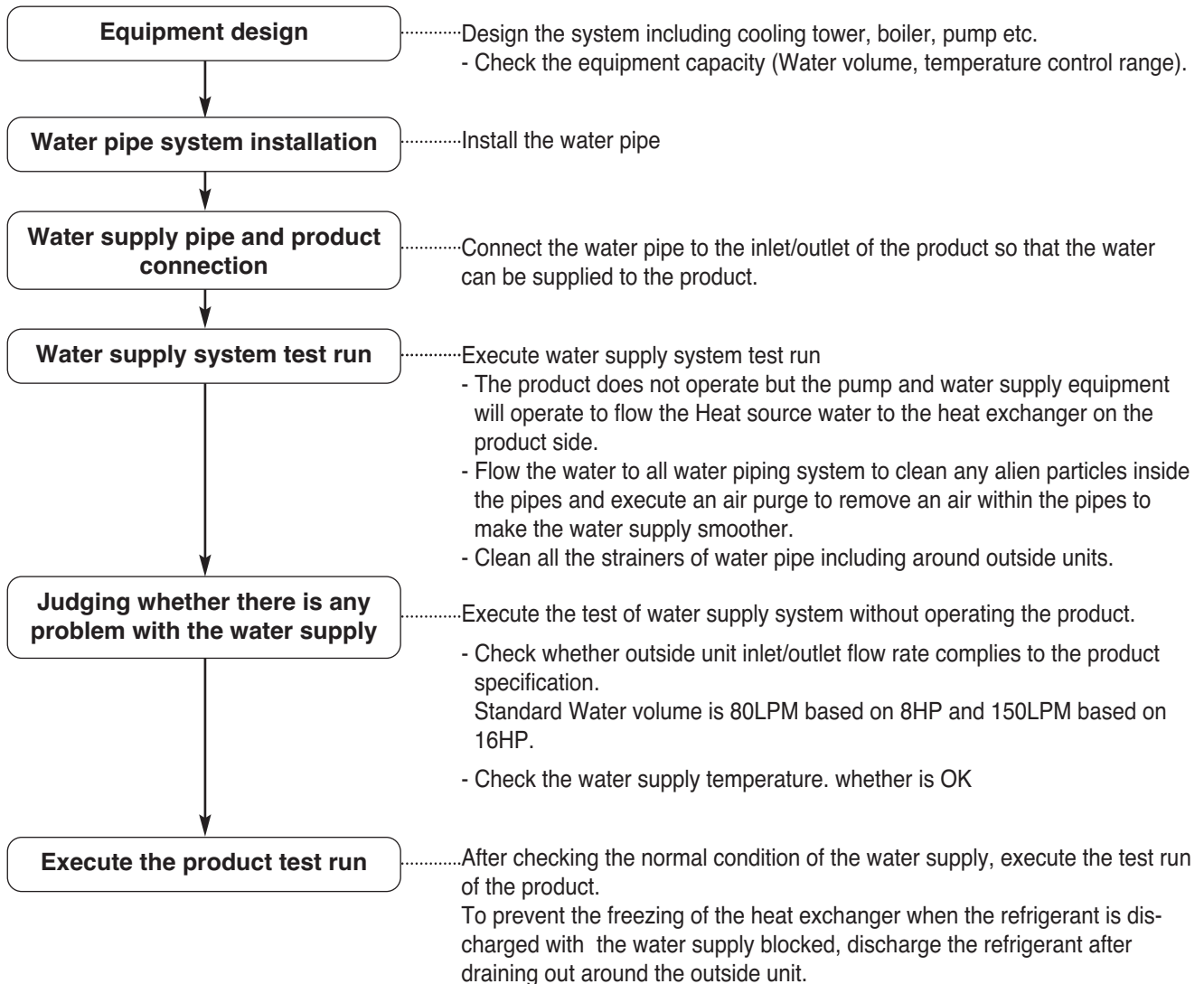

Precaution before test run

1	Check whether the air is completely removed and the water supply is flowing smoothly.
2	Check whether there is any refrigerant leakage of any disconnected or loose communication or power wire, or use the electric wiring diagram to check the wiring connection condition. Check whether the power and communication wire are connected.
3	Check whether the power cable L1, L2 are correctly connected. Check the insulation resistance with the DB mega tester device (DC 500V) between the power terminal block and grounding, and check whether it is 2.0MΩ or above when measured. If the resistance is 2.0MΩ or less, do not operate the product. Precaution) - Never check the insulation resistance for the terminal control board. (The control board can be damaged.) - If you leave the system turned off right after the installation or for a long period of time, the refrigerant gets accumulated within the compressor and the insulation resistance reduces to less than 2MΩ. When the insulation resistance is 2MΩ or less, turn on the power and let the electricity be supplied to the crank case heater of the compressor and let the refrigerant including the oil inside the compressor to evaporate. Then the insulation resistance value will increase to more than 2.0MΩ.
4	Check whether the liquid and gas pipes are open.
5	Precaution when blocking the water cooling type Multi V main power - While using the product (Air conditioning season/Heating season), always connect the main power of the outside unit. - During the test run operation after installing the product or during the operation after blocking the outside unit main power (Power outage etc.), you must always connect the power 6hours prior to heating the crank case heater. If the crank case is not preheated for more than 6hours with the electric heater, it can cause a burn on the compressor.

WARNING

- Always check whether the water supply is flowing smoothly before the test run. (If sufficient amount of water is not flowing, it can burn the product.)
- During the initial test run after installing the product, leaving the product for more than 3days or after replacing the compressor, power must be connected 6hours prior to the operation to heat the compressor heater. (If the product is not heated sufficiently, it can burn the product.)

How to Cope with Abnormal Test Run

Item	Phenomenon	Cause	Checkpoint and resolution
Whether heat water is supplied	CH24	When connecting the flow switch, heat-sourced water doesn't flow or the amount of its flow lacks due to the checked error related to heat-sourced water.	Check whether the heat source water supply pump is operating.
			Check whether the heat source water supply pipe is clogged. (Clean strainer, valve locked, valve issue, air trapped etc.)
			Check whether the flow switch is normal condition. (Flow switch problem, arbitrary control, disconnection etc.)
	CH32	Heat water not supplied or flow rate is insufficient (During air conditioning)	Check whether heat source water supply pump is operating. Check whether the heat source water supply pipe is clogged. (Clean strainer, valve locked, valve issue, air trapped etc.)

Item	Phenomenon	Cause	Checkpoint and resolution
Whether heat water is supplied	CH34	Heat water not supplied or flow rate is insufficient	Check whether heat source water supply pump is operating.
			Check whether the heat source water supply pipe is clogged. (Clean strainer, valve locked, valve issue, air trapped etc.)
	CH180	Heat water not supplied or flow rate is insufficient (During heating)	Check whether heat source water supply pump is operating.
			Check whether the heat source water supply pipe is clogged. (Clean strainer, valve locked, valve issue, air trapped etc.)

※ When CH24 or CH180 error occurs during the test operation of the heater, the inside of the panel heat exchanger may be partially frozen and therefore, be sure to get rid of its cause and then, re-operate the device.
(The root cause of partial freezing: The lack of flow of heat-sourced water, suspension of water, lack of cooling medium, infiltration of foreign substance inside of panel heat exchanger)

Maintenance of plate type heat exchanger

As the scales are created in the panel heat exchanger, its efficiency may decrease or damage may occur due to winter-sowing due to the decrease in its flow.

Due to this reason, regular maintenance is necessary so that the scales shouldn't be created.

- Before the season of use, check below points. (Once a year)
 - inspection on water quality to check if this is within the standard condition.
 - Clean the strainer.
 - Check if the flow is appropriate.
 - Check if the operation environment is appropriate. (Pressure, flow, output temperature)
- Below procedure should be abided by in order to clean the panel heat exchanger. (Once every 5 years)
 - Check if the service port is equipped with the water pipe in order to clean the chemical solution.
5% diluted formic acid, citric acid, oxalic acid, acetate acid, phosphoric acid and etc. are appropriate for the chemical solution for wiping out the scales. (Hydrochloric acid, sulphuric acid, nitric acid and etc. shouldn't be used due to its corrosion.)
 - Be sure to check if the gate valve of inflow/outflow pipe and the valve for outflow pipe are properly closed when cleaning.
 - Connect the water pipe for cleaning with the chemical solvent through the service plug of the pipe and fill up the panel heat exchanger with 50°C~60°C (122°F~140°F) of cleaning solvent and circulate it with the pump for 2~5 hours. The circulation time may depend on the temperature of the cleaning solvent or the creation of the scales. Therefore, observe change in the color of the chemical solvent to set the circulation time for removing the scales.
 - After the circulation of the solvent, extract the solvent inside of the panel heat exchanger and fill up 1~2% of NaOH or NaHCO₃ and then, circulate it for 15~20 minutes to neutralize the heat exchanger.
 - Once the neutralization is completed, clean the inside of the panel heat exchanger with clean water.
Measure the water Ph to check if the chemical solvent is properly removed or not.
 - When using a different kind of chemical solvent in the market, be sure to check if there is any corrosive action to stainless or copper in advance or not.
 - For details on the cleaning chemical solvent, be sure to consult the specialists of the related corporation.
- After cleaning, operate the device to see if it works properly once again.

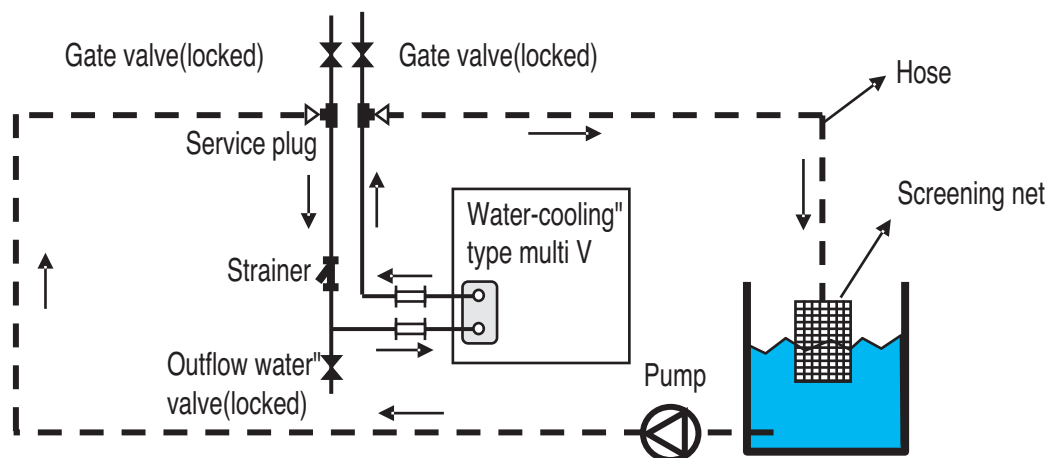

[Cleaning the panel heat exchanger]

Daily check/management

1. Water quality control

The plate type heat exchanger is not structured to be disassembled, cleaned or replaced with parts.

To prevent corrosion or scaling on the plate type heat exchanger, special care must be taken to control the water quality. Water quality must satisfy the minimum criteria of the reference water quality items.

When anti-corrosion agent or corrosion inhibitor is added, the substance must not have any corrosive effect on stainless steel and copper.

Even if the circulating water is not contaminated by the external air, it is recommended to empty the water flowing in the pipe and to resupply the water.

2. Flow rate control

If the flow rate is insufficient, it can cause freezing on the plate type heat exchanger.

Check whether the strainer is clogged or whether the pipe is filled with air and then check the temperature and pressure difference of the inlet and outlet pipe to check whether the flow rate is insufficient.

If the temperature and pressure difference is above the appropriate level, it means that the flow rate is reduced. In this case, the operation must immediately be stopped and re-operated when the root cause is resolved. (*If air is trapped in the pipe, the air must be purged. Air inside the water pipe interferes with the circulation of the heat water supply and can cause insufficient flow rate or freezing.)

3. Brine density management

When using the brine (Anti-freeze) in the heat water supply, designated type and density must be used. Calcium chloride brine can cause corrosion on the plate type heat exchanger and must not be used.

If the anti-freeze liquid is left as is, it absorbs the moisture from the air to cause a drop in the density, leading to freezing of plate type heat exchanger. Therefore minimize the contact surface with the atmosphere and periodically measure the density of the brine to supplement the brine as needed to maintain the density.

Maintenance/Repair checklist

Checkpoint \ Period (Year)	1	2	3	4	5	6	7	8	9	10	11	12	13	14	15
Product operating condition	●	●	●	●	●	●	●	●	●	●	●	●	●	●	●
Heat exchanger cleaning (Wash)					●					●					●
Strainer cleaning	●	●	●	●	●	●	●	●	●	●	●	●	●	●	●
Water quality check	●	●	●	●	●	●	●	●	●	●	●	●	●	●	●
Refrigerant leakage check	●														●
Indoor unit filter cleaning	●	●	●	●	●	●	●	●	●	●	●	●	●	●	●

(● : Check mark)

⚠ CAUTION

- The above checklist is set based on the minimum period and more frequent checking can be required depending on the operating condition/water quality condition.
- When cleaning the heat exchanger, make sure to take parts out or lock the valve so that chemical detergent does not penetrate into the pressure gauge etc.
- When cleaning the heat exchanger, check the connecting part of the water pipes prior to cleaning so that the chemical detergent does not leak.
- After sufficiently mixing the chemical detergent with water, start cleaning.
- Cleaning the heat exchanger is easier at the initial stage and becomes difficult after the scaling has accumulated.
- In areas where the water quality is poor, cleaning is required periodically.
Because chemical detergent has strong acidity, it must be washed off thoroughly with water.
- To check whether it is cleaned well inside, remove the hose and check the inside.
- Purge the air to remove any air inside the water pipe.
- After checking, always check whether the heat water supply is flowing normally before operating the product.

Self-Diagnosis Function

Error Indicator

- This function indicates types of failure in self-diagnosis and occurrence of failure for air condition.
- Error mark is displayed on display window of indoor units and wired remote controller, and 7-segment LED of outside unit control board as shown in the table.
- If more than two troubles occur simultaneously, lower number of error code is first displayed.
- After error occurrence, if error is released, error LED is also released simultaneously.

Display			Error item	Root cause of error	
Indoor unit	0	1	-	Indoor unit air temperature sensor error	Indoor unit air temperature sensor disconnection or short circuit
	0	2	-	Inlet pipe temperature sensor of indoor unit	Indoor unit pipe inlet temperature sensor disconnection or short circuit
	0	3	-	Communication error between wired remote controller and indoor unit	Occurs when indoor unit communication signal is not received from the wired remote controller
	0	4	-	Indoor unit drain error	Drain pump and float switch error
	0	5	-	Communication error between outside unit and indoor unit	When the indoor unit does not receive the outside communication signal continuously for 5minutes or more
	0	6	-	Indoor unit pipe outlet temperature sensor error	Indoor unit pipe outlet temperature sensor disconnection or short circuit
	0	9	-	Indoor unit EEPROM error	Communication error between MICOM and EEPROM or when there is no indoor unit EEPROM data
	1	0	-	Indoor unit BLDC motor feedback signal error	When motor connector is removed or defective
	1	7	-	Inlet Air temperature sensor of FAU	Air temperature sensor of indoor unit is open or short
Outside unit	2	1	1	Outside unit inverter compressor IPM fault	Outside unit inverter compressor drive IPM error
	2	2	1	Inverter Board Input Over Current(RMS) of Outside Unit	Outside Unit Inverter Board Input Current excess (RMS)
	2	3	1	Outside unit inverter compressor DC link under-voltage	DC voltage is not charged after master outside unit operating relay is turned on
	2	4	1	Outside unit high pressure switch	Compressor maintenance by master outside unit high pressure switch Flow rate insufficiency or flow switch trouble of master outside unit
	2	6	1	Outside unit inverter compressor operation failure error	Outside unit input voltage is 487V and above or less than 270V

Test Run

Display			Error item	Root cause of error	
Outside unit	2	8	1	Outside unit inverter DC link over-voltage error	Compressor turned off due to master outside unit inverter DC voltage over-charge
	2	9	1	Outside unit inverter compressor over-current	Outside unit inverter compressor error or operating component (IPM) error operation
	3	1	1	Outside unit inverter CT under-current error	Compressor turned off due to master outside unit inverter CT under-Current
	3	2	1	Outside unit inverter compressor discharge temperature over-rise	Compressor turned off due to master outside unit inverter compressor discharge temperature over-rise Flow rate insufficiency or flow switch trouble of master outside unit
	3	4	1	Outside unit high pressure over-rise	Compressor turned off due to master outside unit high pressure over-rise Flow rate insufficiency or flow switch trouble of master outside unit
	3	5	1	Outside unit low pressure over-drop	Compressor turned off due to master outside unit low pressure over-drop
	3	6	1	Low pressure ratio	Pressure ratio is under limit
	3	9	1	Communication error between Outside unit PFC and inverter board	Outside unit inverter compressor current detection (CT) sensor disconnection or short circuit
	4	0	1	Outside unit inverter compressor CT sensor error	Outside unit inverter compressor current detection (CT) sensor disconnection or short circuit
	4	1	1	Outside unit inverter compressor discharge temperature sensor error	Outside unit inverter compressor discharge temperature sensor disconnection or short circuit
	4	2	1	Outside unit under-voltage sensor error	Outside unit under-voltage sensor disconnection or short circuit
	4	3	1	Outside unit over-voltage sensor error	Outside unit over-voltage sensor disconnection or short circuit
	4	4	1	Outside unit air temperature sensor error	Outside unit air temperature sensor disconnection or short circuit
	4	5	1	Outside Unit Heat Exchanger Temperature Sensor(A) Fault	Outside Unit Heat Exchanger Temperature Sensor(A) Open or Short
	4	6	1	Outside unit suction temperature sensor error	Outside unit suction temperature sensor disconnection or short circuit
	5	1	1	Over-capacity (Indoor unit capacity sum is excessive) connection	Excessive connection f indoor unit connection display value(Different from outside unit)
	5	2	1	Communication error with master outside unit inverter controller	When the inverter controller signal is not received from the master outside unit inverter controller

Display				Error item	Root cause of error	
Outside unit	5	3	1	Communication error with master outside unit controller and indoor unit	When the indoor unit control signal is not received from the master outside unit inverter controller	
	5	7	1	Communication error between outside unit inverter controller	Failing to receive inverter controller signal at Outdoor Unit controller	
	6	0	1	Outside unit inverter PCB EEPROM error	Outdoor unit inverter PCB EEPROM ACCESS error	
	6	2	1	Outside unit inverter IGBT over-rise error	Outside unit inverter IGBT when the temperature rises above 110°C	
	6	5	1	Outside unit inverter IGBT temperature sensor error	Outside unit inverter IGBT temperature sensor disconnection or short circuit	
	7	0	1	Outside unit static speed CT sensor error	Outside unit static speed CT sensor disconnection or short circuit	
	7	1	1	PFC CT Sensor Error of Outdoor Unit	Outdoor Unit PFC CT Sensor open or short	
	7	3	1	Outside unit inverter PCB input instant over-current (Peak)	Outside unit inverter PCB input instant over-current (Peak) exceeded	
	7	4	1	Outside unit inverter PCB phase imbalance	When the master outside unit inverter PCB input current is different	
	8	6	1	Outside unit master PCB EEPROM error	Communication error between master outside unit master MICOM and EEPROM or EEPROM missing	
	8	8	1	PFC PCB EEPROM error	Communication error between Outside unit PFC and EEPROM or EEPROM missing	
	1	1	3	1	Outside unit liquid pipe temperature sensor error	Outside unit liquid pipe temperature sensor disconnection or short circuit
	1	5	1	1	Outside unit 4 way valve switch failure	Outside unit 4 way valve switch error
	1	8	0	1	Plate type heat exchanger freeze prevention	Plate type heat exchanger freeze prevention error
	1	8	1	1	Water temperature sensor error	Water temperature sensor open/short
1	8	2	1	Communication error between MICOMs	Communication error between main MICOM and sub MICOM	

■ Refer to the troubleshooting guide of service technical manual for each error.

Cooling tower applied method

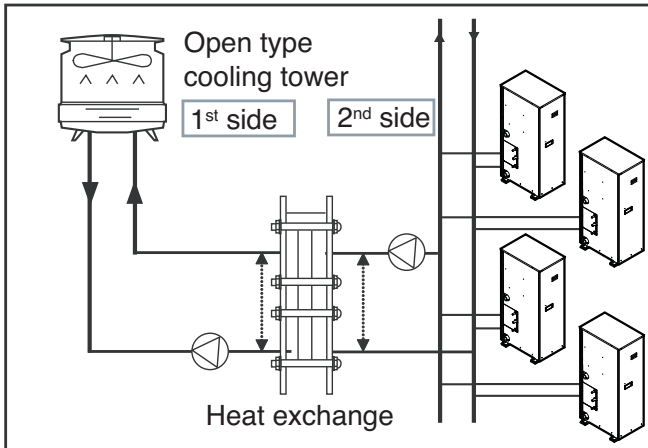

[Open type cooling tower + Second heat exchanger]

Heat exchanger is installed between the cooling tower and outside unit system piping, and the temperature difference between 1st side and 2nd side is maintained constantly

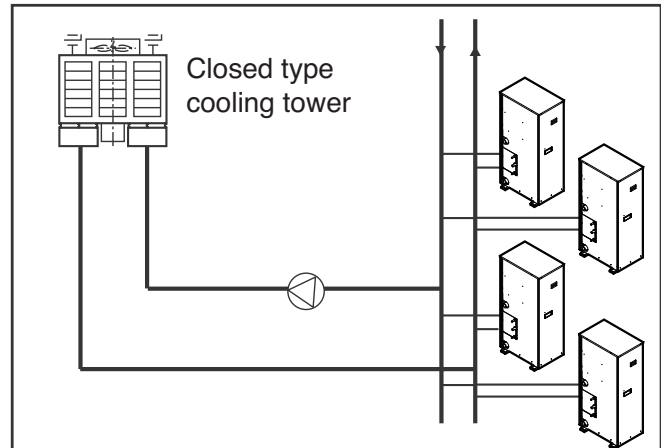

[Closed type cooling tower]

Heat source water of the cooling tower is supplied directly to the outside unit system.

CAUTION

When the open type cooling tower is used and the water supply is directly connected to the 2nd heat exchanger, product damage by alien particle cannot be repaired for free.

- Always use the 2nd heat exchanger.

Caution For Refrigerant Leak

The installer and system specialist shall secure safety against leakage according to local regulations or standards. The following standards may be applicable if local regulations are not available.

Introduction

Though the R410A refrigerant is harmless and incombustible itself, the room to equip the air conditioner should be large to such an extent that the refrigerant gas will not exceed the limiting concentration even if the refrigerant gas leaks in the room.

Limiting concentration

Limiting concentration is the limit of Freon gas concentration where immediate measures can be taken without hurting human body when refrigerant leaks in the air. The limiting concentration shall be described in the unit of kg/m³ (Freon gas weight per unit air volume) for facilitating calculation.

Limiting concentration: 0.44kg/m³ (R410A)

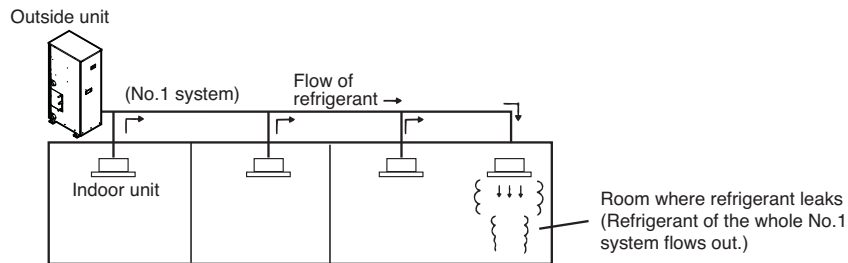

Checking procedure of limiting concentration

Check limiting concentration along following steps and take appropriate measure depending on the situation.

Calculate amount of all the replenished refrigerant (kg) per each refrigerant system.

Amount of replenished refrigerant per one outside unit system

Amount of replenished refrigerant at factory shipment

+

Amount of additional replenished refrigerant

Amount of additionally replenished refrigerant depending on piping length or piping diameter at customer

=

Total amount of replenished refrigerant in refrigerant facility (kg)

Note : In case one refrigerant facility is divided into 2 or more refrigerant systems and each system is independent, amount of replenished refrigerant of each system shall be adopted.

Calculate minimum room capacity

Calculate room capacity by regarding a portion as one room or the smaller room.

(1) Without partition

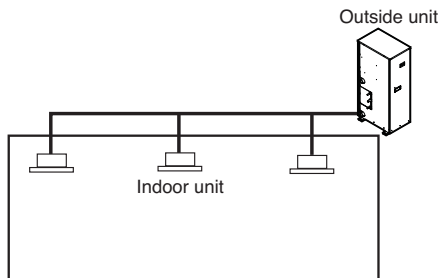

(2) With partition and with opening which serve as passage of air to adjoining room

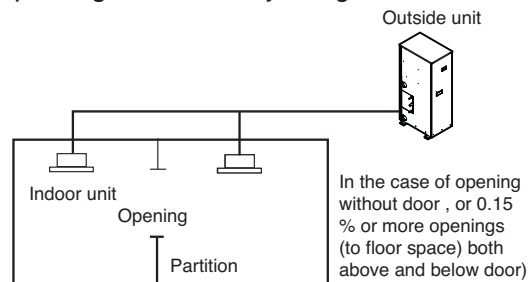

Caution For Refrigerant Leak

(3) With partition and without opening which serve as passage of air to adjoining room

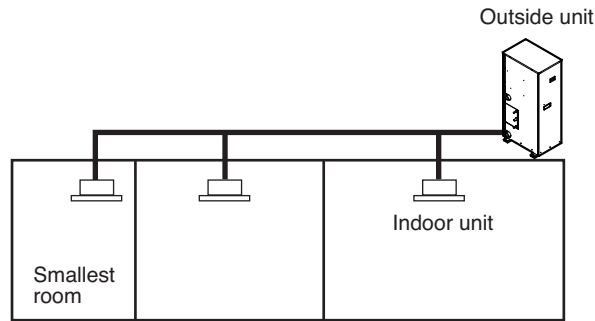

Calculate refrigerant concentration

$$\frac{\text{Total amount of replenished refrigerant in refrigerant facility (kg)}}{\text{Capacity of smallest room where indoor unit is installed (m}^3\text{)}} = \text{Refrigerant concentration (kg/m}^3\text{)} \quad \text{(R410A)}$$

In case the result of calculation exceeds the limiting concentration, perform the same calculations by shifting to the second smallest, and the third smallest rooms until at last the result is below the limiting concentration.

■ In case the concentration exceeds the limit

When the concentration exceeds the limit, change original plan or take one of the countermeasures shown below:

• Countermeasure 1

Provide opening for ventilation.

Provide 0.15% or more opening to floor space both above and below door, or provide opening without door.

• Countermeasure 2

Provide gas leak alarm linked with mechanical ventilator.

Reducing the outside refrigerant qty.

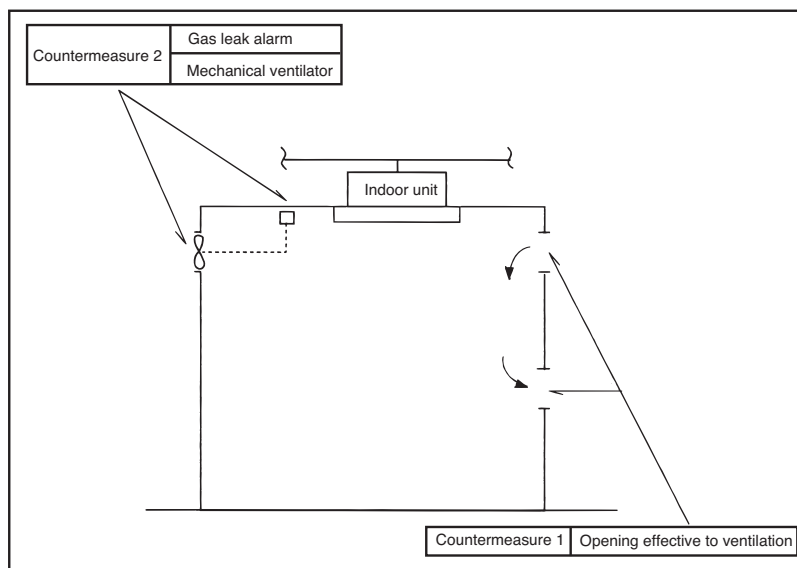

Pay a special attention to the place, such as a basement, etc. where refrigerant can stay, since refrigerant is heavier than air.

Water Solenoid Valve Control

Central Control (Use DDC Port)

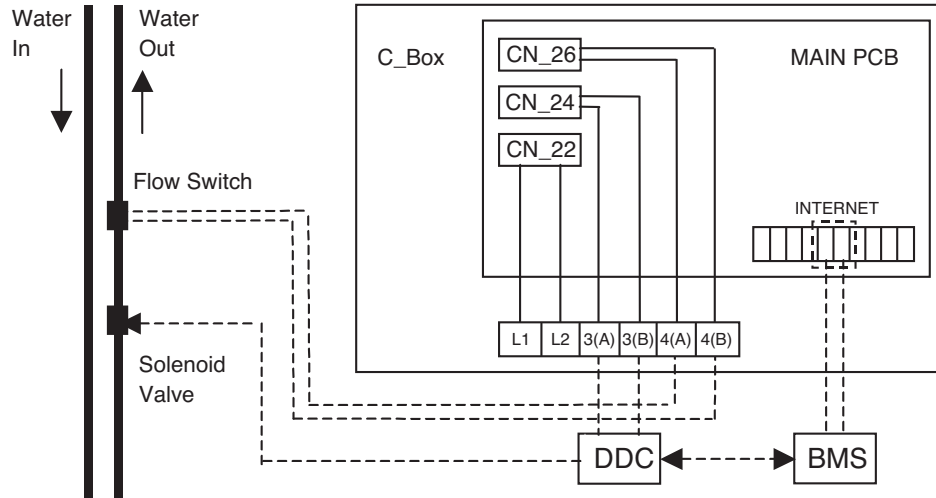

Individual Control (Use 208/230V Out Port)

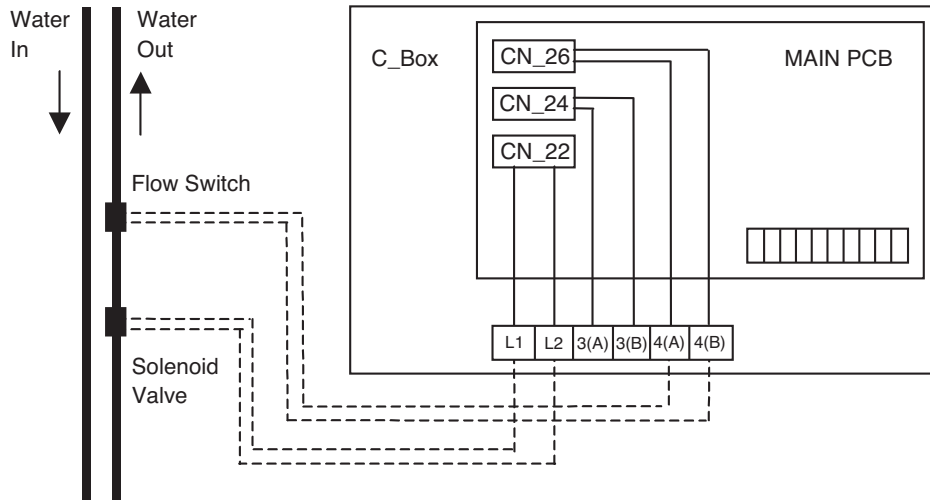

Set the dip switch refer to Fig.1 and turn on the power when you individual control for water solenoid valve control.

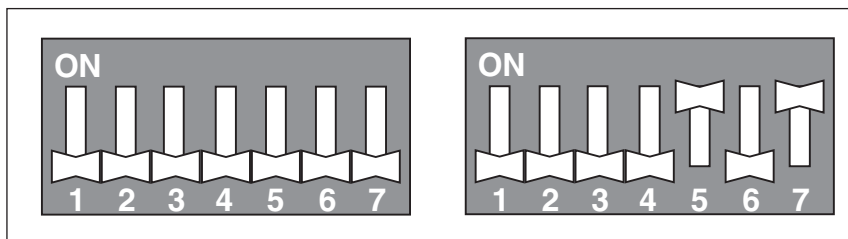
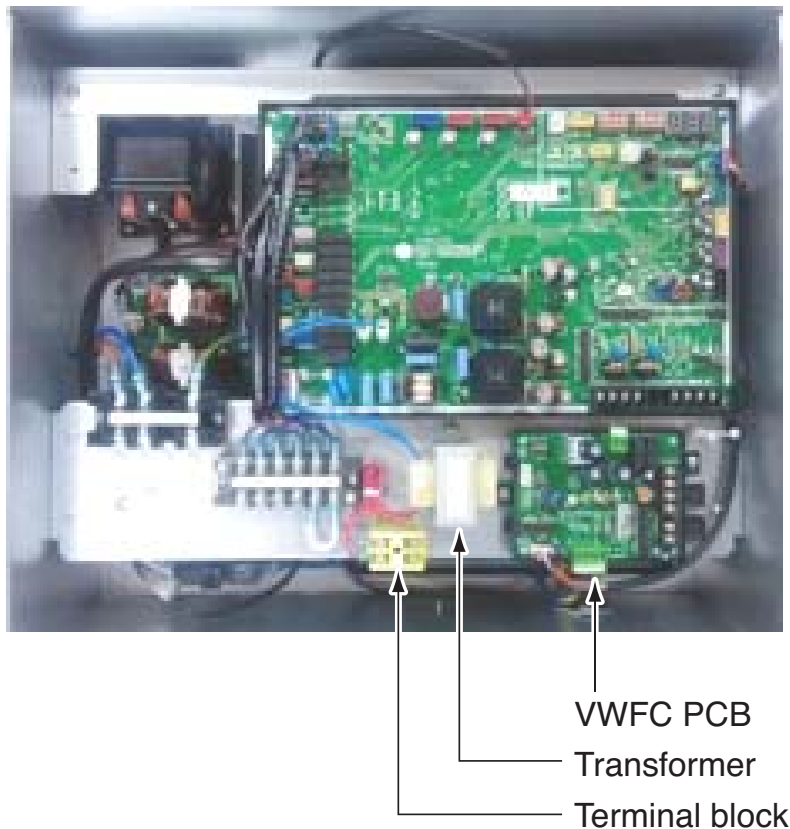

Figure 1

Variable Water Flow Control KIT(Accessory)

1. Shut off the main power line of outdoor unit.
2. Install the VWFC(Variable Water Flow Control) PCB in the C/BOX by using screws.
3. Install the transformer in the C/BOX by using screws.
4. Install the terminal block in the C/BOX by using screws.
5. Connect the Main PCB(CN41) to VWFC(CN_OUT) by using the cable assy.
6. Connect the blue wire of transformer to the Main PCB (JIG1(L), JIG2(N)).
7. Connect the red wire of transformer to the terminal block (2Pin Yellow terminal block).
8. Connect a power cable (DC 12V) to CN_PWR(12V, GND) of VWFC.
9. Connect a signal cable (DC 0~10V) of water flow control valve to CN_AO(AO_01(A+), GND(A-)) of VWFC.
10. Case of two water flow control valve, Connect a signal cable (DC 0~10V) of water flow control valve to CN_AO(AO_02(B+), GND(B-)) of VWFC.
11. Connect a power cable (AC 24V) of water flow control valve to the terminal block (2Pin Yellow terminal block, Max current 0.42A).
12. Connect the RS-485 communication cable to CN_COMM(BUS_A, BUS_B) of VWFC
13. Set up the main function Dip S/W of VWFC PCB.
14. Set up the Dip SW of outdoor main PCB.
15. Turn on the main power line of outdoor unit.
16. Check the signal of water flow control valve to CN_AO(AO_01, GND) of VWFC and the water flow rate.



⚠ CAUTION

1. Install the product on flat surface and screw at least 2 places. Otherwise the VWFC PCB may not be anchored properly.
2. Do not deform the case at random. It may cause malfunction of the Variable Water Flow Control PCB
3. This is a class A product. In a non-industrial environment, this product may cause radio interference, in which case the user may be required to take adequate measures.



LGEUS
LG Electronics, Air conditioning Division
1000 Sylvan Ave., Englewood Cliffs, NJ 07632

LGECI
LG ELECTRONICS CANADA INC.
20 NORELCO DRIVE.
NORTH YORK, ONTARIO M9L 2X6.

LG Customer Information Center

888-865-3026 USA, press #2 for PTAC, TTW
888-865-3026 USA, press #3 for DFS, Multi V
1-888-LG-Canada CANADA

Register your product Online!

www.lge.com