



**LG**

Life's Good

ENGLISH

ESPAÑOL

PORTUGUESE

# INSTALLATION MANUAL

# AIR CONDITIONER

- Please read this installation manual completely before installing the product.
- Installation work must be performed in accordance with the national wiring standards by authorized personnel only.
- Please retain this installation manual for future reference after reading it thoroughly.

**TYPE : 1WAY CEILING CASSETTE**



P/NO : MFL68021603

[www.lg.com](http://www.lg.com)

## TIPS FOR SAVING ENERGY

Here are some tips that will help you minimize the power consumption when you use the air conditioner. You can use your air conditioner more efficiently by referring to the instructions below:

- Do not cool excessively indoors. This may be harmful for your health and may consume more electricity.
- Block sunlight with blinds or curtains while you are operating the air conditioner.
- Keep doors or windows closed tightly while you are operating the air conditioner.
- Adjust the direction of the air flow vertically or horizontally to circulate indoor air.
- Speed up the fan to cool or warm indoor air quickly, in a short period of time.
- Open windows regularly for ventilation as the indoor air quality may deteriorate if the air conditioner is used for many hours.
- Clean the air filter once every 2 weeks. Dust and impurities collected in the air filter may block the air flow or weaken the cooling / dehumidifying functions.

### *For your records*

Staple your receipt to this page in case you need it to prove the date of purchase or for warranty purposes. Write the model number and the serial number here:

Model number : \_\_\_\_\_

Serial number : \_\_\_\_\_

You can find them on a label on the side of each unit.

Dealer's name : \_\_\_\_\_

Date of purchase : \_\_\_\_\_

# IMPORTANT SAFETY INSTRUCTIONS

## **READ ALL INSTRUCTIONS BEFORE USING THE APPLIANCE.**

Always comply with the following precautions to avoid dangerous situations and ensure peak performance of your product

### **WARNING**

It can result in serious injury or death when the directions are ignored

### **CAUTION**

It can result in minor injury or product damage when the directions are ignored

### **WARNING**

- Installation or repairs made by unqualified persons can result in hazards to you and others.
- Installation **MUST** conform with local building codes or, in the absence of local codes, with the Nation Electrical Code NFPA 70/ANSI C1-1003 or current edition and Canadian Electrical Code Part1 CSA C.22.1.
- The information contained in the manual is intended for use by a qualified service technician familiar with safety procedures and equipped with the proper tools and test instruments.
- Failure to carefully read and follow all instructions in this manual can result in equipment malfunction, property damage, personal injury and/or death.

### Installation

- Do not use a defective or underrated circuit breaker. Use this appliance on a dedicated circuit. There is risk of fire or electric shock.
- For electrical work, contact the dealer, seller, a qualified electrician, or an Authorized Service Center. Do not disassemble or repair the product. There is risk of fire or electric shock.
- Always ground the product. There is risk of fire or electric shock.
- Install the panel and the cover of control box securely. There is risk of fire or electric shock.
- Always install a dedicated circuit and breaker. Improper wiring or installation may cause fire or electric shock
- Use the correctly rated breaker or fuse. There is risk of fire or electric shock.
- Do not modify or extend the power cable. There is risk of fire or electric shock.
- Do not install, remove, or re-install the unit by yourself (customer). There is risk of fire, electric shock, explosion, or injury.
- Be cautious when unpacking and installing the product. Sharp edges could cause injury. Be especially careful of the case edges and the fins on the condenser and evaporator.
- For installation, always contact the dealer or an Authorized Service Center. There is risk of fire, electric shock, explosion, or injury.
- Do not install the product on a defective installation stand. It may cause injury, accident, or damage to the product.
- Be sure the installation area does not deteriorate with age. If the base collapses, the air conditioner could fall with it, causing property damage, product failure, and personal injury.
- Do not let the air conditioner run for a long time when the humidity is very high and a door or a window is left open. Moisture may condense and wet or damage furniture.

## 4 IMPORTANT SAFETY INSTRUCTIONS

---

- Do not install the product on a defective installation stand.
  - It may cause injury, accident, or damage to the product.
- Be sure the installation area does not deteriorate with age.
  - If the base collapses, the air conditioner could fall with it, causing property damage, product failure, and personal injury.
- Use a vacuum pump or Inert (nitrogen) gas when doing leakage test or air purge. Do not compress air or Oxygen and Do not use Flammable gases. Otherwise, it may cause fire or explosion.
  - There is the risk of death, injury, fire or explosion.

### Operation

- Take care to ensure that power cable could not be pulled out or damaged during operation. There is risk of fire or electric shock.
- Do not place anything on the power cable. There is risk of fire or electric shock.
- Do not plug or unplug the power supply plug during operation. There is risk of fire or electric shock.
- Do not touch(operate) the product with wet hands. There is risk of fire or electrical shock.
- Do not place a heater or other appliances near the power cable. There is risk of fire and electric shock.
- Do not allow water to run into electric parts. It may cause There is risk of fire, failure of the product, or electric shock.
- Do not store or use flammable gas or combustibles near the product. There is risk of fire or failure of product.
- Do not use the product in a tightly closed space for a long time. Oxygen deficiency could occur.
- When flammable gas leaks, turn off the gas and open a window for ventilation before turn the product on. Do not use the telephone or turn switches on or off. There is risk of explosion or fire
- If strange sounds, or small or smoke comes from product. Turn the breaker off or disconnect the power supply cable. There is risk of electric shock or fire.
- Stop operation and close the window in storm or hurricane. If possible, remove the product from the window before the hurricane arrives. There is risk of property damage, failure of product, or electric shock.
- Do not open the inlet grill of the product during operation.(Do not touch the electrostatic filter, if the unit is so equipped.) There is risk of physical injury, electric shock, or product failure.
- When the product is soaked (flooded or submerged), contact an Authorized Service Center. There is risk of fire or electric shock.
- Be cautious that water could not enter the product. There is risk of fire, electric shock, or product damage.
- Ventilate the product from time to time when operating it together with a stove, etc. There is risk of fire or electric shock.
- Turn the main power off when cleaning or maintaining the product. There is risk of electric shock.
- When the product is not be used for a long time, disconnect the power supply plug or turn off the breaker. There is risk of product damage or failure, or unintended operation.
- Take care to ensure that nobody could step on or fall onto the outdoor unit. This could result in personal injury and product damage.

## CAUTION

### Installation

- Always check for gas (refrigerant) leakage after installation or repair of product. Low refrigerant levels may cause failure of product.
- Install the drain hose to ensure that water is drained away properly. A bad connection may cause water leakage.
- Keep level even when installing the product. To avoid vibration or water leakage.
- Do not install the product where the noise or hot air from the outdoor unit could damage the neighborhoods. It may cause a problem for your neighbors.
- Use two or more people to lift and transport the product. Avoid personal injury.
- Do not install the product where it will be exposed to sea wind (salt spray) directly. It may cause corrosion on the product. Corrosion, particularly on the condenser and evaporator fins, could cause product malfunction or inefficient operation.

### Operation

- Do not expose the skin directly to cool air for long periods of time. (Don't sit in the draft.) This could harm to your health.
- Do not use the product for special purposes, such as preserving foods, works of art, etc. It is a consumer air conditioner, not a precision refrigeration system. There is risk of damage or loss of property.
- Do not block the inlet or outlet of air flow. It may cause product failure.
- Use a soft cloth to clean. Do not use harsh detergents, solvents, etc. There is risk of fire, electric shock, or damage to the plastic parts of the product.
- Do not touch the metal parts of the product when removing the air filter. They are very sharp! There is risk of personal injury.
- Do not step on or put anything on the product. (outdoor units) There is risk of personal injury and failure of product.
- Always insert the filter securely. Clean the filter every two weeks or more often if necessary. A dirty filter reduces the efficiency of the air conditioner and could cause product malfunction or damage.
- Do not insert hands or other objects through the air inlet or outlet while the product is operated. There are sharp and moving parts that could cause personal injury.
- Do not drink the water drained from the product. It is not sanitary and could cause serious health issues.
- Use a firm stool or ladder when cleaning or maintaining the product. Be careful and avoid personal injury.
- Replace the all batteries in the remote control with new ones of the same type. Do not mix old and new batteries or different types of batteries. There is risk of fire or explosion
- Do not recharge or disassemble the batteries. Do not dispose of batteries in a fire. They may burn or explode.
- If the liquid from the batteries gets onto your skin or clothes, wash it well with clean water. Do not use the remote if the batteries have leaked. The chemicals in batteries could cause burns or other health hazards.
- If you eat the liquid from the batteries, brush your teeth and see doctor. Do not use the remote if the batteries have leaked. The chemicals in batteries could cause burns or other health hazards.

## TABLE OF CONTENTS

### 2 TIPS FOR SAVING ENERGY

---

### 3 IMPORTANT SAFETY INSTRUCTIONS

---

### 7 INTRODUCTION

---

7 Features

### 8 INSTALLATION

---

8 Installation Tools

9 Installation of Indoor, Outdoor Unit

16 Remote Control Preparation

### 21 INSTALLATION OF DECORATIVE PANEL (ACCESSORY)

---

22 Indoor Unit Drain Piping

24 Air Purging

26 Test running

29 Installation guide at the seaside





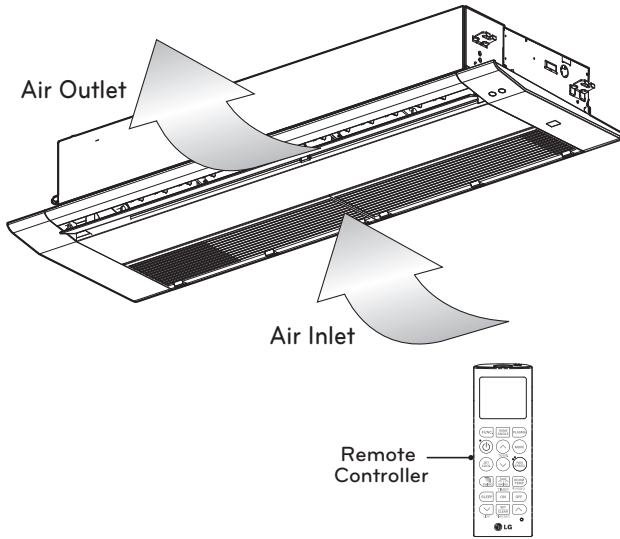





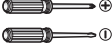

# INTRODUCTION

## Features

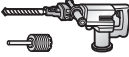

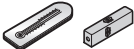
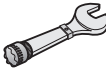
# INSTALLATION

## Installation Tools

Figure	Name	Figure	Name
	Screw driver		Ohmmeter
	Electric drill		Hexagonal wrench
	Measuring tape, Knife		Ammeter
	Hole core drill		Gas-leak detector
	Spanner		Thermometer, Horizontal meter
	Torque wrench		Flaring tool set
	Manifold gauges		Vacuum pump

# Installation of Indoor, Outdoor Unit

## Selection of the best location

### Indoor unit

- There should not be any heat source or steam near the unit.
- There should not be any obstacles to prevent the air circulation.
- A place where air circulation in the room will be good.
- A place where drainage can be easily obtained.
- A place where noise prevention is taken into consideration.
- Do not install the unit near the door way.
- Ensure the spaces indicated by arrows from the wall, ceiling, or other obstacles.
- The indoor unit must keep the maintenance space.

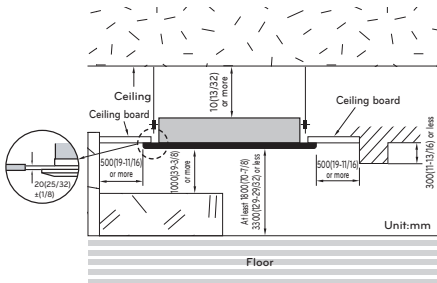

### Outdoor unit

- If an awning is built over the unit to prevent direct sunlight or rain exposure, be careful that heat radiation from the condenser is not restricted.
- There should not be any animals or plants which could be affected by hot air discharged.
- Ensure the spaces indicated by arrows from the wall, ceiling, fence or other obstacles.

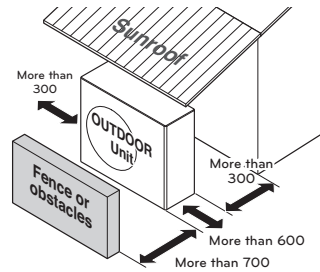

Unit : mm

\* Please use an annexed sheet or the corrugated cardboard on the bottom of packing as installation sheet.



Annexed sheet

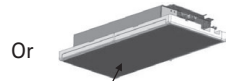

Or

Packing corrugated cardboard on the bottom

- When using the bottom sheet, please use it after separating the installation sheet from packing of the product floor by using a knife etc as a picture below.

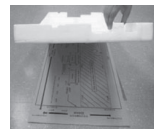

Piping length and the elevation

Model	Pipe Size mm(inch)		Length A(m)		Elevation B(m)		*Additional refrigerant (g/m)
	Gas	Liquid	Standard	Max.	Standard	Max.	
AT-Q12GULA0	9.52(3/8)	6.35(1/4)	5	20	5	15	15

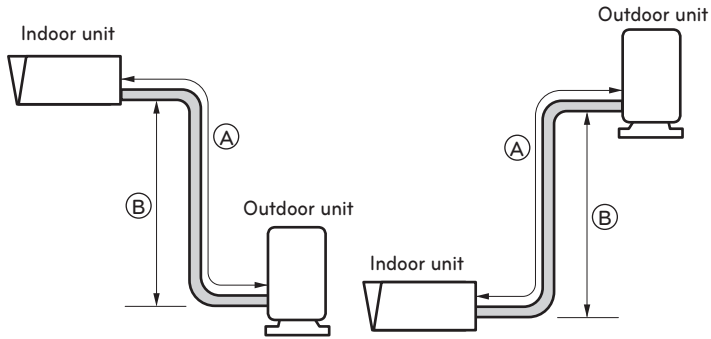

**CAUTION**

- Rated performance for refrigerant line length of : 5m
- Capacity is based on standard length and maximum allowance length is on the basis of reliability.
- Improper refrigerant charge may result in abnormal cycle.

### Ceiling opening dimensions and hanging bolt location

- The dimensions of the paper model for installing are the same as those of the ceiling opening dimensions.
- Select and mark the position for fixing bolts and piping hole.
- Decide the position for fixing bolts slightly tilted to the drain direction after considering the direction of drain hose.
- Drill the hole for anchor bolt on the ceiling.

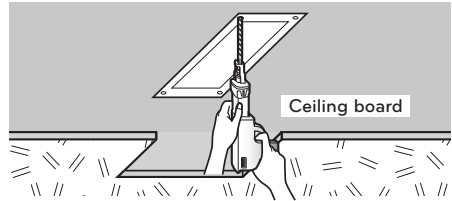
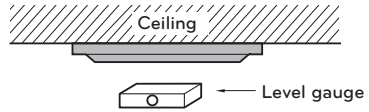

#### CAUTION

- This air-conditioner uses a drain pump.
- Horizontally install the unit using a level gauge.
- During the installation, care should be taken not to damage electric wires.

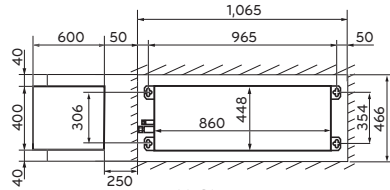

TU Chassis

(unit: mm)

**! NOTE**

Thoroughly study the following installation locations:

- 1 In such places as restaurants and kitchens, considerable amount of oil steam and flour adhere to the turbo fan, the fin of the heat exchanger and the drain pump, resulting in heat exchange reduction, spraying, dispersing of water drops, drain pump malfunction, etc. In these cases, take the following actions:
  - Make sure that the ventilation fan for smoke-collecting hood on a cooking table has sufficient capacity so that it draws oily steam which should not flow into the suction of the air conditioner.
  - Make enough distance from a cooking room to install the air conditioner in such a place where it may not suck in oily steam.

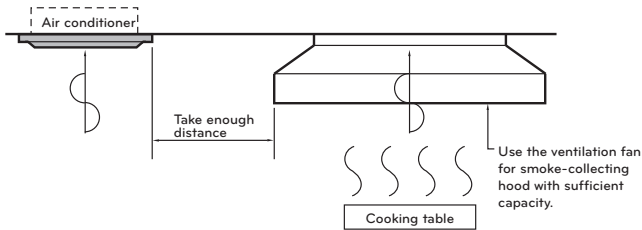

- 2 Avoid installing air conditioner in such circumstances where cutting oil mist or iron powder is in suspension in factories, etc.
- 3 Avoid places where inflammable gas is generated, flows in, is stored or vented.
- 4 Avoid places where sulfurous acid gas or corrosive gas is generated.
- 5 Avoid places near high frequency generators.

## The Indoor Unit Installation

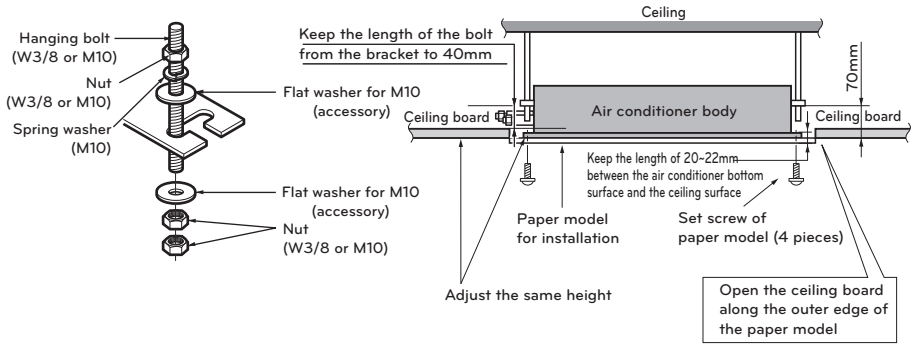

The following parts is option.

- ① Hanging Bolt - W 3/8 or M10
- ② Nut - W 3/8 or M10
- ③ Spring Washer - M10
- ④ Plate Washer - M10

Drill the piping hole on the wall slightly tilted to the outdoor side using a  $\varnothing 65$  hole-core drill.

### CAUTION

Tighten the nut and bolt to prevent unit falling.

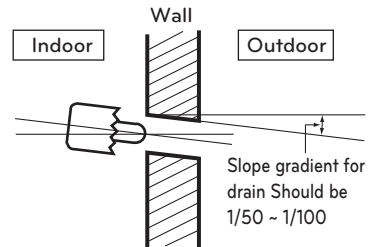

## The Outdoor Unit Installation

- Anchor the outdoor unit with a bolt and nut tightly and horizontally on a concrete or rigid mount.
- When installing on the wall, roof or rooftop, anchor the mounting base securely with a nail or wire assuming the influence of wind and earthquake.
- In the case when the vibration of the unit is conveyed to the house, secure the unit with an anti-vibration rubber.

### Bolt construction work

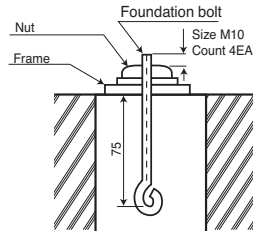
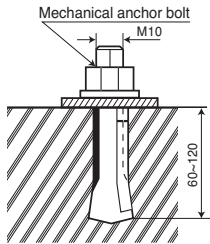

### Settlement draw of outdoor units

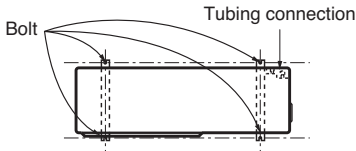

### ⚠ CAUTION

- The ingredients of foundation : Cement : Sand : Gravel for the concrete should 1 : 2 : 4 ratio
- The foundation surface should be finished with mortar.
- The edges of foundation should be rounded.
- A drain passage should be made around the foundation to thoroughly drain water away from the equipment installation area.
- If installing the outdoor units on the roof, the roof's strength have to be checked.
- Care should be taken for weather - proofing
- Blocking all gaps of outdoor unit, for passing piping and wiring, using sealing material (Field supply) (Animals and bugs might enter the machine.)

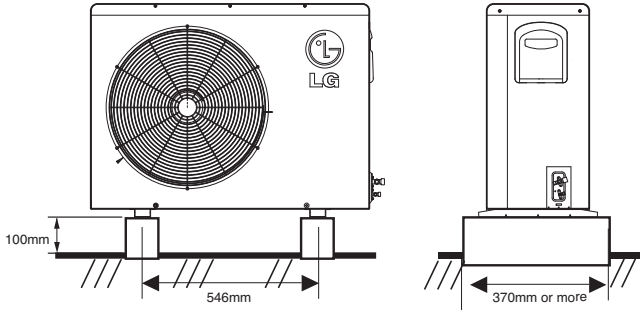

### Remote Controller Installation

Although the room temperature sensor is in the indoor unit, the remote controller should be installed in such places away from direct sunlight and high humidity.

#### Installation of the remote controller

- Select places that are not splashed with water.
- Select control position after receiving customer approval.
- The room temperature sensor is built in the indoor unit.
- This remote controller equipped with liquid crystal display. If this position is higher or lower, display is difficult to see. (The standard height is 1.2 ~ 1.5m high)

#### Routing of the remote controller cord

- Keep the remote controller cord away from the refrigerant piping and the drain piping.
- To protect the remote controller cord from electrical noise, place the cord at least 5cm away from other power cables (audio equipment, television set, etc.)
- If the remote controller cord is secured to the wall, provide a trap at the top of the cord to prevent water droplets from running.

## Remote Control Preparation

### HOW TO MOUNT ONTO A WALL

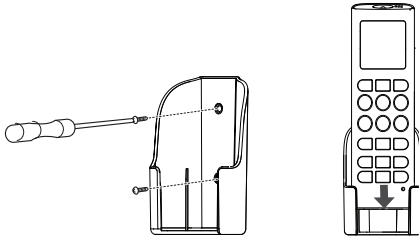

### HOW TO INSERT BATTERIES

- 1 Remove the battery cover from the remote controller.
  - Slide the cover according to the arrow direction.
- 2 Insert the two batteries.
  - Be sure that the (+) and (-) directions are correct.
  - Be sure that both batteries are new.
- 3 Re-attach the cover.
  - Slide it back into position.

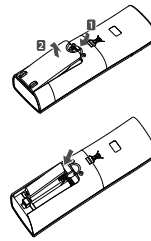

- Do not use rechargeable batteries, such as batteries differ from standard dry cells in shape, dimensions, and performance.

- Remove the batteries from the remote controller if the air conditioner is not going to be used for some long time.

## Wiring Connection

- Remove the control box cover for electrical connection between the indoor and outdoor unit.
- Use the cord clammer to fix the cord.



**CAUTION**

The power cord connected to the outdoor unit should be complied with the following specifications (Rubber insulation, type H05RN-F approved by HAR or SAA).

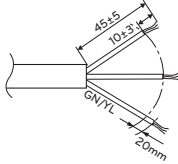

Model	Normal Cross-Sectional
AT-Q12GULA0	2.5mm <sup>2</sup> (3 wires)

The connecting cable connected to the indoor and outdoor unit should be complied with the following specifications (Rubber insulation, type H05RN-F approved by HAR or SAA).

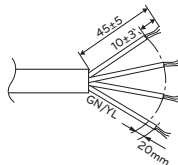

Model	Normal Cross-Sectional
AT-Q12GULA0	1.0mm <sup>2</sup> (4 wires)

If the supply cord is damaged, it must be replaced by a special cord or assembly available from the manufacturer or its service agent.

**CAUTION**

The Power cord connected to the unit should be selected according to the following specifications.

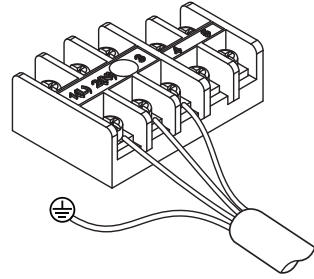

**Precautions when laying power wiring**

Use round pressure terminals for connections to the power terminal block.

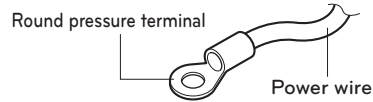

When none are available, follow the instructions below.

- Do not connect wiring of different thicknesses to the power terminal block. (Slack in the power wiring may cause abnormal heat.)
- When connecting wiring which is the same thickness, do as shown in the figure below.

Connect same thickness wiring to both sides.

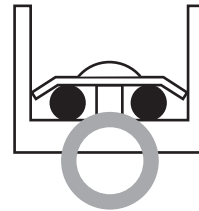

It is forbidden to connect two to one side.

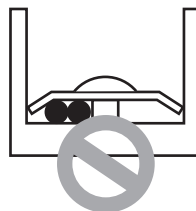

It is forbidden to connect wiring of different thicknesses.



- For wiring, use the designated power wire and connect firmly, then secure to prevent outside pressure being exerted on the terminal block.
- Use an appropriate screwdriver for tightening the terminal screws. A screwdriver with a small head will strip the head and make proper tightening impossible.
- Over-tightening the terminal screws may break them.

**ELECTRICAL WIRING**

- 1 All wiring must comply with LOCAL REGULATIONS.
- 2 Select a power source that is capable of supplying the current required by the air conditioner.
- 3 Feed the power source to the unit via a distribution switch board designed for this purpose.
- 4 The terminal screws inside the control box may be loose due to vibration during transport. Check the screws for loose connection. (Running the air conditioner with loose connection can overload and damage electrical components.)
- 5 Always ground the air conditioner with a grounding wire and connector to meet the LOCAL REGULATION.

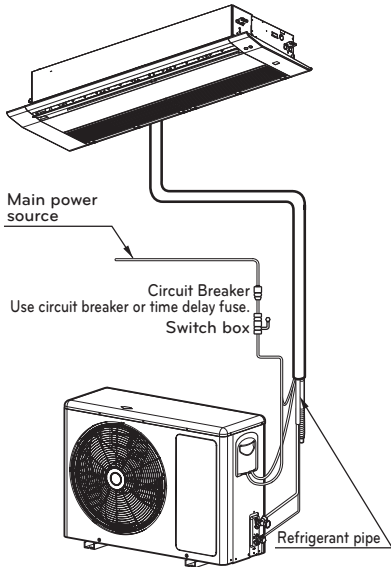

**CONNECTING THE CABLE TO OUTDOOR UNIT**

- 1 Remove the Cover control from the unit by loosening a screw.  
Connect the wires to the terminals on the control board individually as following.
- 2 Secure the cable onto the control board with the holder (clamper).
- 3 Refix the cover control to the original position with the screw.
- 4 Use a recognized circuit breaker between the power source and the unit.  
a disconnecting device to adequately disconnect all supply lines must be fitted.

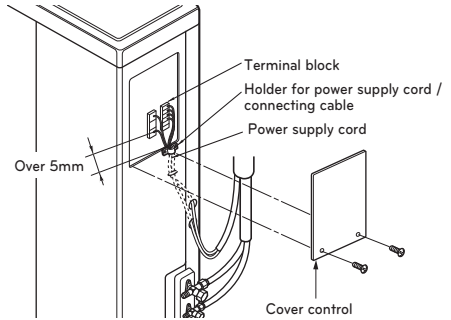

Model	Circuit Breaker (A)
AT-12GULA0	15

## Connecting Pipes to the Indoor Unit - Preparation of Piping

Main cause of gas leakage is defect in flaring work. Carry out correct flaring work in the following procedure.

### Cut the pipes and the cable.

- Use the accessory piping kit or the pipes purchased locally.
- Measure the distance between the indoor and the outdoor unit.
- Cut the pipes a little longer than measured distance.
- Cut the cable 1.5m longer than the pipe length.

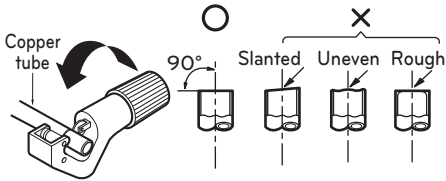

### Burrs removal

- Completely remove all burrs from the cut cross section of pipe/tube.
- Put the end of the copper tube/pipe to downward direction as you remove burrs in order to avoid to let burrs drop in the tubing.

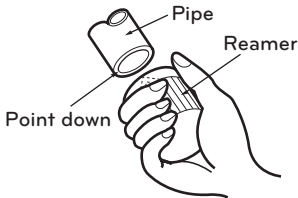

### Putting nut on

- Remove flare nuts attached to indoor and outdoor units, then put them on pipe/tube having completed burr removal. (Not possible to put them on after flaring work)

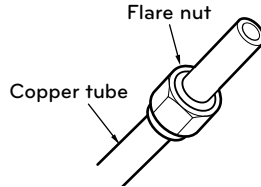

### Flaring work

- Carry out flaring work using flaring tool as shown below.

Outside diameter		A
mm	inch	mm
Ø6.35	1/4	1.1~1.3
Ø9.52	3/8	1.5~1.7
Ø12.7	1/2	1.6~1.8
Ø15.88	5/8	1.6~1.8
Ø19.05	3/4	1.9~2.1

Firmly hold copper tube in a bar(or die) as indicated dimension in the table above.

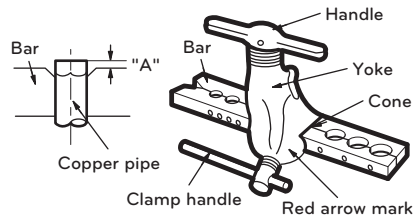

**Check**

- \*Compare the flared work with figure below.
- \*If flare is noted to be defective, cut off the flared section and do flaring work again.
- If the piping and the drain hose are in common direction bundle the piping and the drain hose together by wrapping them with vinyl tape.

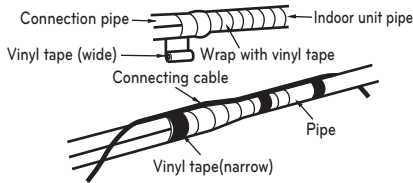
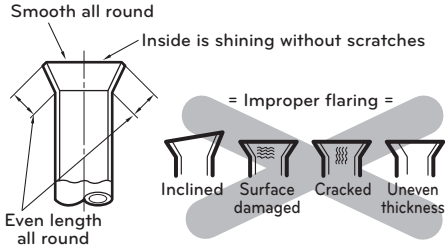

**Piping Connection**

- Form the piping according to its routing. Avoid bending and bending back the same piping point more than three times. (This will result in hardening the pipe.)
- After deforming the piping, align centers of the union fitting of the indoor unit and the piping, and tighten them firmly with wrenches.
- Connect pipe to the service valve or ball valve which is located below the outdoor unit.
- After completing the piping connection, be sure to check if there is gas leakage in indoor and outdoor connection.

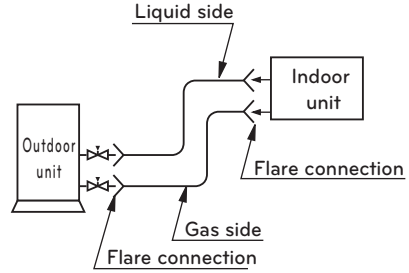

**CAUTION**

Use two wrenches and tighten with regular torque.

**Flare nut fastening torque**

Ø6.35mm	1.8~2.5 kgf.m
Ø9.52mm	3.4~4.2 kgf.m
Ø12.7mm	5.5~6.6 kgf.m
Ø15.88mm	6.3~8.2 kgf.m
Ø19.05mm	9.9~12.1 kgf.m

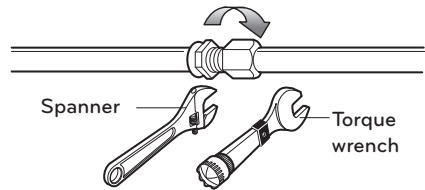

**Vacuum drying**

After completing the piping connection, execute vacuum drying for the connecting piping and the indoor unit.

The vacuum drying must be carried out using the service ports of both the liquid and gas side valves.

# INSTALLATION OF DECORATIVE PANEL(Accessory)

The decorative panel has its installation direction.  
Before installing the decorative panel, always remove the paper template.

- 1 Open the air outlet vane, and extract side covers.
- 2 Remove the air inlet grille from the decoration panel.
- 3 Hook decoration panel to indoor unit, using hooks attached at the backside of both side of decoration panel.
- 4 Arrange wires not to get caught between decoration panel and indoor unit.
- 5 Screw 7 fixing screws.  
(9, 12kBTu/h : 6 screws)
- 6 Connect the vane motor connector and display connector. (Plasma connector for plasma model)
- 7 Install the air inlet grille (including the air filter) and side covers.

## Good example

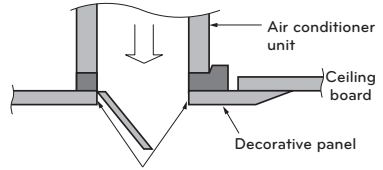

Fit the insulator (this part) and be careful for cool air leakage

## Bad example

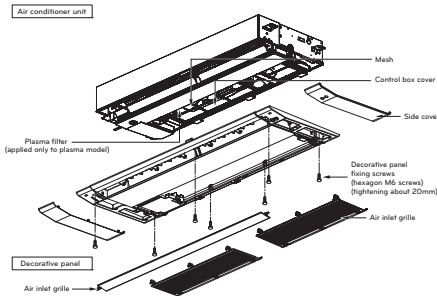
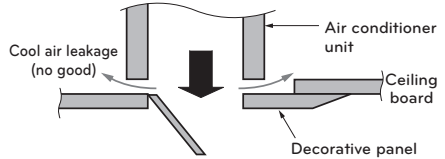

## CAUTION

Install certainly the decorative panel.  
Cool air leakage causes sweating. ☞  
Water drops fall.

### Indoor Unit Drain Piping

- Drain piping must have down-slope (1/50 to 1/100): be sure not to provide up-and-down slope to prevent reversal flow.
- During drain piping connection, be careful not to exert extra force on the drain port on the indoor unit.
- The outside diameter of the drain connection on the indoor unit is 32mm.

Piping material: Polyvinyl chloride pipe VP-25 and pipe fittings

- Be sure to execute heat insulation on the drain piping.

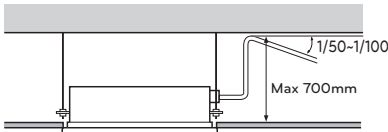
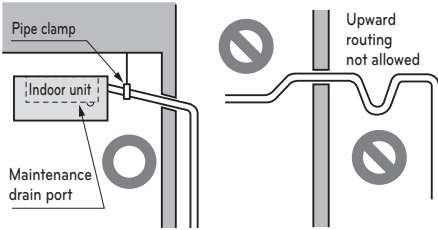

Heat insulation material: Polyethylene foam with thickness more than 8 mm.

### Drain test

The air conditioner uses a drain pump to drain water.

Use the following procedure to test the drain pump operation:

- Connect the main drain pipe to the exterior and leave it provisionally until the test comes to an end.
- Feed water to the flexible drain hose and check the piping for leakage.
- Be sure to check the drain pump for normal operating and noise when electrical wiring is complete.
- When the test is complete, connect the flexible drain hose to the drain port on the indoor unit.

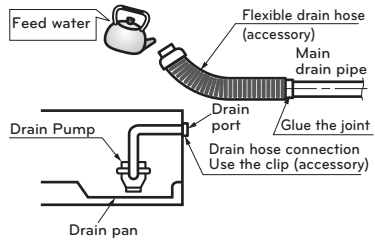

### CAUTION

The supplied flexible drain hose should not be curved, neither screwed. The curved or screwed hose may cause a leakage of water.

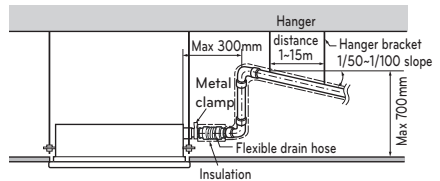

### HEAT INSULATION

- Use the heat insulation material for the refrigerant piping which has an excellent heat-resistance (over 120°C).

### HEAT INSULATION

- Use the heat insulation material for the refrigerant piping which has an excellent heat-resistance (over 120°C).
- Precautions in high humidity circumstance: This air conditioner has been tested according to the "KS Standard Conditions with Mist" and confirmed that there is not any default. However, if it is operated for a long time in high humid atmosphere (dew point temperature: more than 23°C), water drops are liable to fall. In this case, add heat insulation material according to the following procedure:

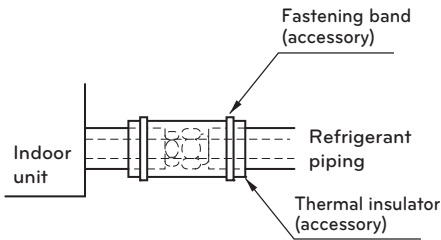

- Heat insulation material to be prepared... Adiabatic EPDM or NBR with thickness 10 to 20mm.
- Stick EPDM or NBR on all air conditioners that are located in ceiling atmosphere.
- In addition to the normal heat insulation (thickness: more than 8mm) for refrigerant piping (gas piping: thick piping) and drain piping, add further 10mm to 30mm thickness material.

### Form the pipings

- 1 Wrap the connecting portion of indoor unit with the Insulation material and secure it with two Plastic Bands. (for the right pipings)
  - If you want to connect an additional drain hose, the end of the drain-outlet should keep distance from the ground. (Do not dip it into water, and fix it on the wall to avoid swinging in the wind.)

In case of the Outdoor unit being installed below position of the Indoor unit.

- 2 Tape the Pipings, drain hose and Connecting Cable from bottom to top.
- 3 Form the pipings gathered by taping along the exterior wall and fix it onto the wall by saddle or equivalent.

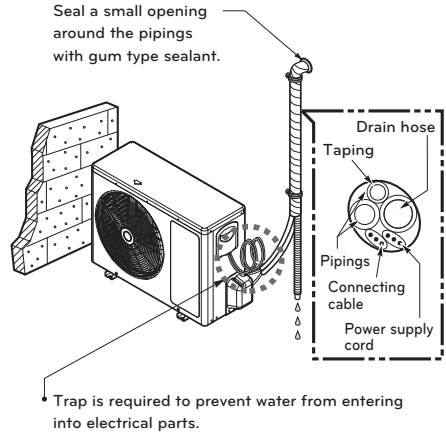

In case of the Outdoor Unit being installed above position of the Indoor Unit.

- 4 Tape the Pipings and Connecting cable from bottom to top.
- 5 Form the pipings gathered by taping along the exterior wall, and make the trap prevent water from entering into the room.
- 6 Fix the pipings onto the wall by saddle or equivalent

Seal a small opening around the pipings with gum type sealant.

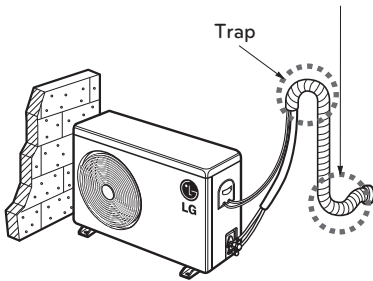

## Air Purging

### Air purging

The air and moisture remaining in the refrigerant system have undesirable effects as indicated below.

- Pressure in the system rises.
- Operating current rises.
- Cooling(or heating) efficiency drops.
- Moisture in the refrigerant circuit may freeze and block capillary tubing.
- Water may lead to corrosion of parts in the refrigeration system.

Therefore, after evacuating the system, take a leak test for the piping and tubing between the indoor and outdoor unit.

### Air purging with vacuum pump

- Check that both liquid and gas pipe between indoor and outdoor have been properly connected.
- Remove the service valve cap from both the gas and liquid side on the outdoor unit.
- Confirm that both the liquid and gas side valve are set to the closed position.
- Connect the manifold valve(with pressure gauge) to the gas pipe side.

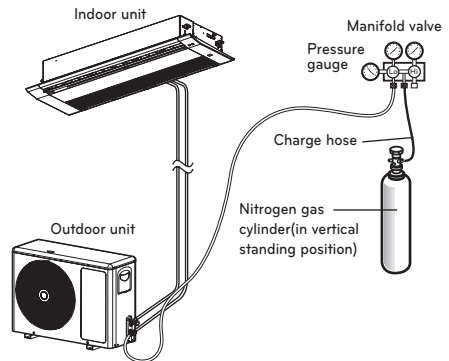

**CAUTION**

Be sure to use a manifold valve for air purging. If it is not available, use a stop valve for this purpose. The "Hi" knob of the manifold valve must always be kept close.

- And connect the Nitrogen cylinder to the service port with charge hoses to the manifold gauge.
- Pressurize the system to no more than 150 P.S.I.G with dry nitrogen gas. Close the nitrogen cylinder valve when it shows reading of 150 P.S.I.G.

**CAUTION**

To avoid nitrogen entering the refrigerant system in a liquid state, the top of the cylinder must be higher than its bottom when you pressurize the system. Usually, the cylinder is used in a vertical standing position.

- Check for leakage with Liquid soap solution. Do the leakage test at all joints of tubing (indoor and outdoor) and on the service valve (both gas and liquid side).

**Evacuation**

- If the system is found free from all leakages, relieve the nitrogen pressure by loosening the charge hose connector at nitrogen cylinder. Disconnect the hose from cylinder when pressure reaches to normal state.
- Evacuation: Connect the charge hose end to the vacuum pump and evacuate the connecting of the and indoor unit. Check that the "Lo" knob of manifold is open. Run the vacuum pump.  
Confirm the "Lo" knob of the manifold valve is open. Then, run the vacuum pump.  
The operation time for evacuation varies with tubing length and capacity of the pump.  
The degree of vacuum should be under 0.8 Torr.

When the desired vacuum is reached, close the "Lo" knob of the manifold valve and stop the vacuum pump.

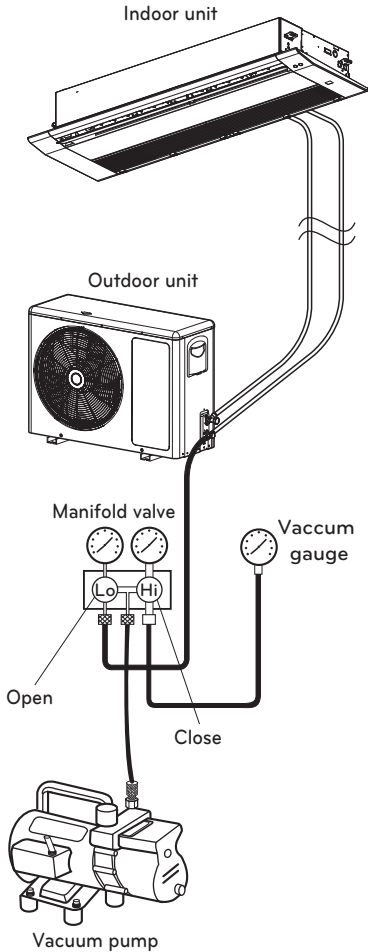

- Once the desired vacuum is created. Disconnect the vacuum pump and open the liquid side valve stem by turning it to counter-clockwise direction with service valve wrench.
- Open completely the gas side valve buy turning to counter-clockwise with service valve wrench.
- Remove slowly the charge hose connected to the gas side service port (to release the pressure).
- Replace back the flare nut and its bonnet on the gas side service port. Fasten the flare nut with adjustable wrench to prevent any leakage from the system.
- Fasten back the valve cap on both gas and liquid side service valves.

## Test running

### PRECAUTIONS IN TEST RUN

- The initial power supply must provide at least 90% of the rated voltage. Otherwise, the air conditioner should not be operated.

### ! CAUTION

- For test run, carry out the cooling operation firstly even during heating season. If heating operation is carried out firstly, it leads to the trouble of compressor. Then attention must be paid.
- Carry out the test run more than 5 minutes without fail. (Test run will be cancelled 18 minutes later automatically)

- The test run is started by pressing the room temperature checking button and down timer button for 3 seconds at the same time.
- To cancel the test run, press any button.

**CHECK THE FOLLOWING ITEMS WHEN INSTALLATION IS COMPLETED**

- After completing work, be sure to measure and record trial run properties, and store measured data, etc.
- Measuring items are room temperature, outside temperature, suction temperature, blow out temperature, wind velocity, wind volume, voltage, current, presence of abnormal vibration and noise, operating pressure, piping temperature, compressive pressure.
- As to the structure and appearance, check following items.
  - \* Is the circulation of air adequate?
  - \* Is the draining smooth?
  - \* Is the heat insulation complete (refrigerant and drain piping)?
  - \* Is there any leakage of refrigerant?
  - \* Is the remote controller switch operated?
  - \* Is there any faulty wiring?
  - \* Are not terminal screws loosened?

- M4.....12kgf.cm(118N.cm)
- M5.....20kgf.cm(196N.cm)
- M6.....25kgf.cm(245N.cm)
- M8.....60kgf.cm(588N.cm)

**Connection of power supply**

- Connect the power supply cord to the independent power supply.  
Circuit breaker is required.
- Operate the unit for 15 minutes or more.

**Evaluation of the performance**

- Measure the temperature of the intake and discharge air.
- Ensure the difference between the intake temperature and the discharge one is more than 8°C (Cooling) or reversely (Heating).

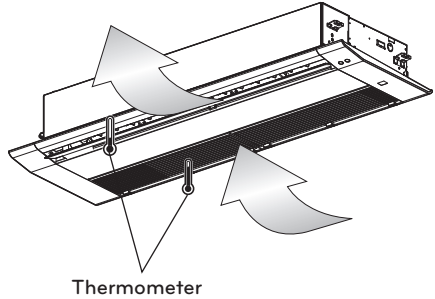

**! CAUTION**

After the confirmation of the above conditions, prepare the wiring as follows:

- Never fail to have an individual power specialized for the air conditioner. As for the method of wiring, be guided by the circuit diagram pasted on the inside of control box cover.
- Provide a circuit breaker switch between power source and the unit.
- The screw which fasten the wiring in the casing of electrical fittings are liable to come loose from vibrations to which the unit is subjected during the course of transportation. Check them and make sure that they are all tightly fastened. (If they are loose, it could give rise to burn-out of the wires.)
- Specification of power source
- Confirm that electrical capacity is sufficient.
- Be sure that the starting voltage is maintained at more than 90 percent of the rated voltage marked on the name plate.

**CAUTION**

- Confirm that the cable thickness is as specified in the power sources specification.  
(Particularly note the relation between cable length and thickness.)
- Never fail to equip a leakage breaker where it is wet or moist.
- The following troubles would be caused by voltage drop-down.  
Vibration of a magnetic switch, damage on the contact point there of, fuse breaking, disturbance to the normal function of a overload protection device.  
Proper starting power is not given to the compressor.

**NOTE****Setting the Ceiling Height Selection**

For more details refer to Owners Manual, whenever you want to set the Ceiling Height Selection.

**HAND OVER**

Teach the customer the operation and maintenance procedures, using the operation manual (air filter cleaning, temperature control, etc.).

## Installation guide at the seaside

### ! CAUTION

- Air conditioners should not be installed in areas where corrosive gases, such as acid or alkaline gas, are produced.
- Do not install the product where it could be exposed to sea wind (salty wind) directly. It can result corrosion on the product. Corrosion, particularly on the condenser and evaporator fins, could cause product malfunction or inefficient performance.
- If outdoor unit is installed close to the seaside, it should avoid direct exposure to the sea wind. Otherwise it needs additional anticorrosion treatment on the heat exchanger.

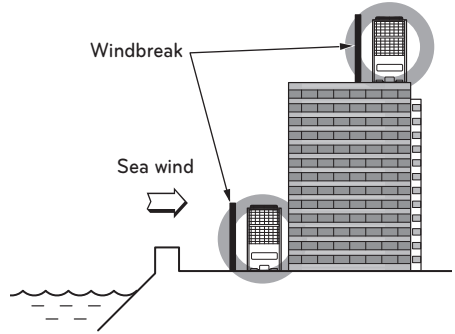

- It should be strong enough like concrete to prevent the sea wind from the sea.
- The height and width should be more than 150% of the outdoor unit.
- It should be keep more than 70 cm of space between outdoor unit and the windbreak for easy air flow.

## Selecting the location(Outdoor Unit)

If the outdoor unit is to be installed close to the seaside, direct exposure to the sea wind should be avoided. Install the outdoor unit on the opposite side of the sea wind direction.

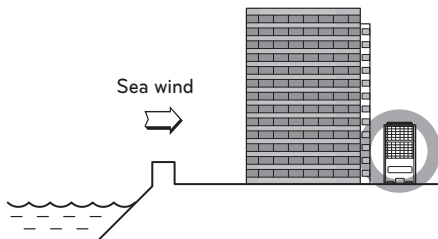
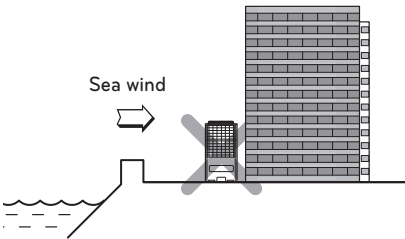

In case, to install the outdoor unit on the seaside, set up a windbreak not to be exposed to the sea wind.

Select a well-drained place.

- If you can't meet above guide line in the seaside installation, please contact LG Electronics for the additional anticorrosion.
- Periodic ( more than once/year ) cleaning of the dust or salt particles stuck on the heat exchanger by using water



