



# MICROWAVE OVEN

## OWNER'S MANUAL

MODEL : MS-74ML  
MS-74MLA

Please read this manual carefully before using this product.  
Retain this manual for future reference.

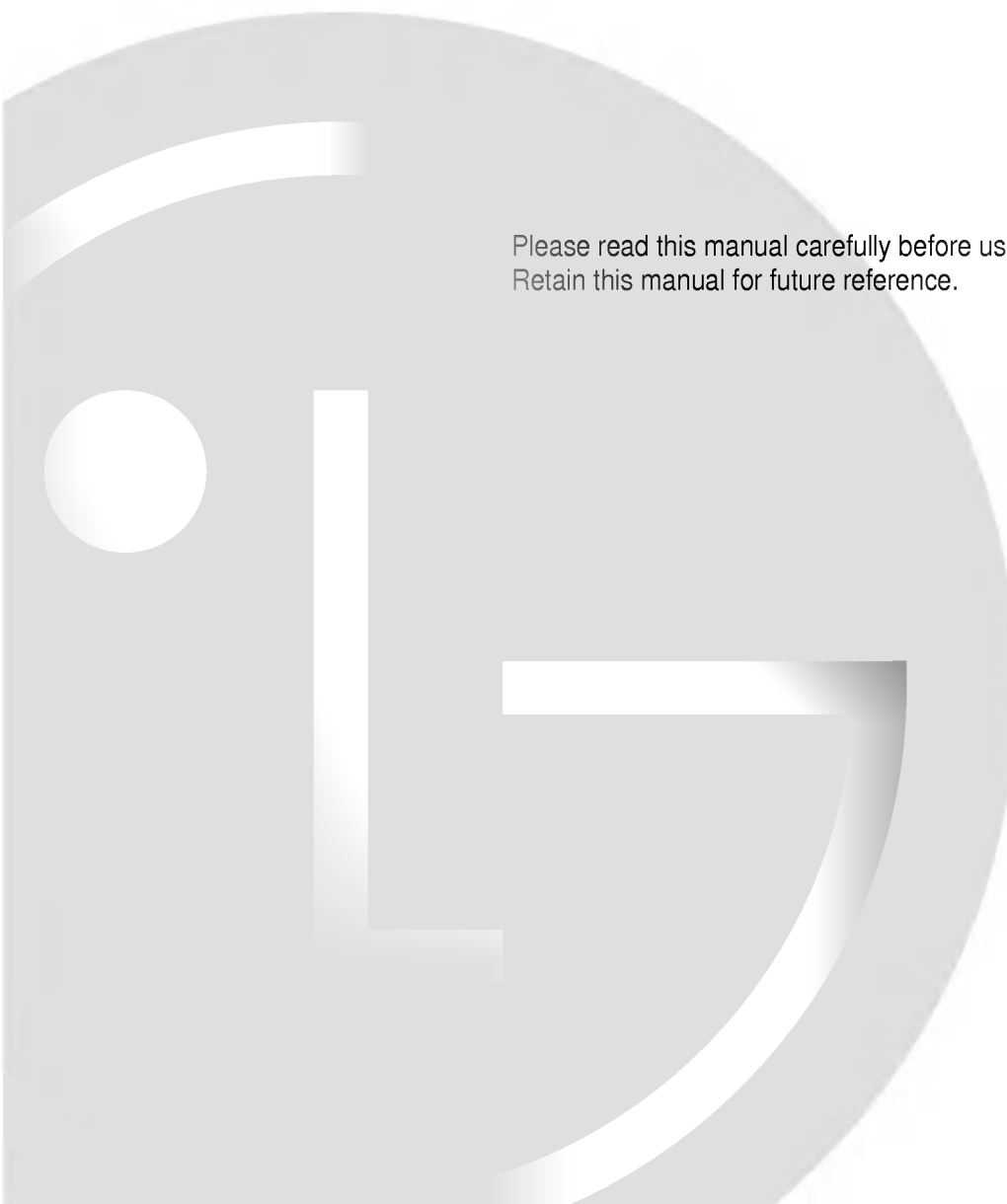

# PRECAUTIONS TO AVOID POSSIBLE EXPOSURE TO EXCESSIVE MICROWAVE ENERGY

Do not attempt to operate the oven with the door open since open door operation can result in harmful exposure to microwave energy. It is important not to tamper with the safety interlocks.

Do not place any object between the oven front face and the door or allow soil or cleaner residue to accumulate on sealing surfaces.

Do not operate the oven if it is damaged. It is particularly important that the oven door closes properly and that there is no damage to the (1) door, bent, (2) hinges and latches (broken or loosened), (3) door seals and sealing surfaces.

The oven should not be adjusted or repaired by anyone except properly qualified service personnel.

## WARNING

Please ensure cooking times are correctly set as over cooking may result in FIRE and subsequent damage to the oven.

## WARNING

When heating liquids, e.g. soups, sauces and beverages in your microwave oven, overheating the liquid beyond boiling point can occur without evidence of bubbling. This could result in a sudden boil over of the hot liquid. To prevent this possibility the following steps should be taken :

1. Avoid using straight sided containers with narrow necks.
2. Do not overheat.
3. Stir the liquid before placing the container in the oven and again halfway through the heating time.
4. After heating, allow to stand in the oven for a short time, stir or shake them again carefully and check the temperature of them before consumption to avoid burns (especially, contents of feeding bottles and baby food jars).

# IMPORTANT SAFETY INSTRUCTIONS

**WARNING** - To reduce the risk of burns, electric shock, fire, injury to persons or exposure to excessive microwave energy:

1. Read all instructions before using the appliance.

2. Read and follow the specific **“PRECAUTIONS TO AVOID POSSIBLE EXPOSURE TO EXCESSIVE MICROWAVE ENERGY”** found on page 2 of this manual.

3. This appliance must be grounded. Connect only to properly grounded outlet.

See **“GROUNDING INSTRUCTIONS”** found on page 5 of this manual.

4. Install or locate this appliance only in accordance with the provided installation instructions.

5. Some products such as whole eggs and sealed containers-for example, closed glass jars-may explode and should not be heated in this oven.

6. Use this appliance only for its intended use as described in the manual. Do not use corrosive chemicals or vapors in this appliance. This type of oven is specifically designed to heat, cook, or dry food. It is not designed for industrial or laboratory use.

7. As with any appliance, close supervision is necessary when used by children.

8. Do not operate this appliance if it has a damaged cord or plug, if it is not working properly, or if it has been damaged or dropped.

9. This appliance should be serviced only by qualified service personnel. Contact nearest authorized service facility for examination, repair or adjustment.

10. Do not cover or block any openings on the appliance.

11. Do not store this appliance outdoors. Do not use this product near water-for example, near a kitchen sink, in a wet basement, or near a swimming pool, and the like.

12. Do not immerse cord or plug in water.

13. Keep cord away from heated surfaces.

14. Do not let cord hang over edge of table or counter.

15. Either-(a) When cleaning surfaces of door and oven that comes together on closing the door, use only mild, nonabrasive soaps or detergents applied with a sponge or soft cloth; or when separate cleaning instructions apply, (b) See door surface cleaning instruction on (specific page or section to be included).

16. To reduce the risk of fire in the oven cavity:

a. Do not overcook food. Carefully attend appliance if paper, plastic, or other combustible materials are placed inside the oven to facilitate cooking.

b. Remove wire twist-ties from paper or plastic bags before placing bag in oven.

c. If materials inside the oven should ignite, **KEEP OVEN DOOR CLOSED**, turn oven off, and disconnect the power cord, or shut off power at the fuse or circuit breaker panel.

d. Do not use the cavity for storage purposes. Do not leave paper products, cooking utensils, or food in the cavity when not in use.

17. Do not heat any type of baby bottles or baby food. Uneven heating may occur and could cause personal injury.

18. Avoid heating small-necked containers such as syrup bottles.

19. Avoid using corrosive and vapors, such as sulfide and chloride.

20. Liquids heated in certain shaped containers (especially cylindrical-shaped containers) may become overheated. The liquid may splash out with a loud noise during or after heating or when adding ingredients (instant coffee, etc.) resulting in harm to the oven and possible injury. In all containers, for best results, stir the liquid several times before heating. Always stir liquid several times between reheatings.

## SAVE THESE INSTRUCTIONS

4	TECHNICAL SPECIFICATION
5	INSTALLATION
7	INTRODUCTION
10	FEATURES DIAGRAM / CONTROL PANEL
11	OPERATING INSTRUCTIONS
17	OTHER HELPFUL INSTRUCTIONS
18	SAFETY PRECAUTIONS
19	QUESTIONS AND ANSWERS

<b>Specifications</b>	<b>Model No.</b>	<b>MS-74ML</b>	<b>MS-74MLA</b>
Power Supply		120V AC / 60Hz	220V AC / 60Hz
Rated Power Consumption		1,050 W	1,050 W
Microwave Output		*700 W (IEC705 RATING STANDARD)	*700 W (IEC705 RATING STANDARD)
Frequency		2450MHz	2450MHz
Overall Dimensions (W X H X D)		483mm X 280mm X 326mm	483mm X 280mm X 326mm
Overall Cavity Dimensions (W X H X D)		300mm X 193mm X 316mm	300mm X 193mm X 316mm
Effective Capacity Oven Cavity		19 L	19 L

## A. INSTALLATION AND GROUNDING INSTRUCTIONS

Instale o forno seguindo três simples passos:

1. Retire o produto da embalagem e separe todos os acessórios e materiais utilizados em seu transporte.
2. Instale o forno em um local plano e firme, deixando espaços livres de 10 cm ao seu redor (laterais e partes superior e traseira), para assegurar uma boa ventilação. Não permita que objetos permaneçam nas laterais do forno para não comprometer a ventilação. Na parte superior do gabinete de alguns modelos há uma saída para exaustão, que se bloqueada poderá provocar danos ao forno.
3. Conecte o cabo de força do aparelho em uma tomada de voltagem compatível. Esta tomada deverá ser reservada exclusivamente para o forno e a rede elétrica deverá ser de pelo menos 15 amperes.

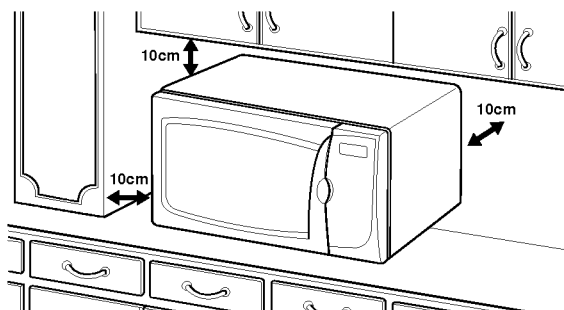

### NOTAS:

- **Caso o forno não funcione de maneira adequada, desligue o seu cabo de força da tomada e em seguida conecte-o novamente.**
- **O forno não foi projetado para uso comercial.**
- **Escolha o local ideal.**  
Procure um bom local que possa aumentar a partacidade e circulação na sua cozinha. Escolha uma região próxima a uma tomada de força e uma superfície sólida, firme e plana, e se possível que tenha também uma área de apoio. Atenção: escolha um local protegido do sol e que não seja úmido, nem próximo a fogões, estufas ou torneiras. Evite também a proximidade com aparelhos de TV e rádio porque poderão causar interferências.
- **Fio terra (aterramento)**  
A garantia da segurança deve-se ao aterramento do seu aparelho. Por isso, é imprescindível colocar um fio terra eficiente conectado à tomada em que será ligado o forno, ou a algum tubo metálico.

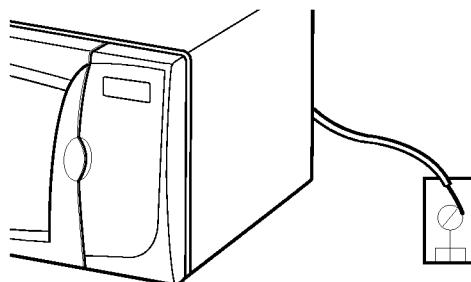

## B. CIRCUITS

For safety purposes this oven must be plugged into above 15 Amp for 120V, 60Hz and above 10 Amp for 220V, 60Hz circuit. No other electrical appliances or lighting circuits should be on this line. If in doubt, consult a licensed electrician.

## C. VOLTAGE WARNING

The voltage used at the wall receptacle must be the same as specified on the oven serial plate located on the back or on the side of the control panel of the oven. Use of a higher voltage is dangerous and may result in a fire or other type of accident causing oven damage.

Low voltage will cause slow cooking. In case your microwave oven does not perform normal operation in accordance with AC power source and voltage, remove the power cord and then insert it again.

## D. DO NOT BLOCK AIR VENTS

All air vents should be kept clear during cooking. If air vents are covered during oven operation the oven may overheat. In this case a sensitive thermal safety device automatically turns the oven off. The oven will be inoperable until it has cooled sufficiently.

## E. PLACEMENT OF THE OVEN

Your microwave oven can be placed easily in your kitchen, family room, or anywhere else in your home. Place the oven on a flat surface such as a kitchen countertop or a specially designed microwave oven cart. Do not place oven above a gas or electric range. Free air flow around the oven is important.

## F. RADIO INTERFERENCE

1. Operation of the microwave oven may cause interference to your radio, TV or similar equipment.
2. When there is interference, it may be reduced or eliminated by taking the following measures:
  - a. Clean door and sealing surfaces of the oven
  - b. Reorient the receiving antenna of radio or television.
  - c. Relocate the microwave oven with respect to the receiver.
  - d. Move the microwave oven away from the receiver.
  - e. Plug the microwave oven into a different outlet so that microwave oven and receiver are on different branch circuits.

## How the Microwave Oven Works

Microwaves are a form of energy similar to radio and television waves and ordinary daylight. Ordinarily, microwaves spread outwards as they travel through the atmosphere and disappear without effect.

Microwave ovens, however, have a magnetron which is designed to make use of the energy in microwaves. Electricity, supplied to the magnetron tube, is used to create microwave energy. These microwaves enter the cooking area through openings inside the oven. A turntable or tray is located at the bottom of the oven. Microwaves cannot pass through metal walls of the oven, but they can penetrate such materials as glass, porcelain and paper, the materials out of which microwave-safe cooking dishes are constructed. Microwaves do not heat the cookware, though cooking vessels will eventually get hot from the heat generated by the food.

**A very safe appliance.** Your microwave oven is one of the safest of all home appliances. When the door is opened, the oven automatically stops producing microwaves. Microwave energy is converted completely to heat when it enters food, leaving no "left over" energy to harm you when you cook your food.

## Getting The Best Results From Your Microwave Oven

**Keeping an eye on things.** The recipes in this book have been formulated with great care, but your success in preparing them depends, of course, on how much attention you pay to the food as it cooks. Always watch your food while it cooks. Your microwave oven is equipped with a light that turns on automatically when the oven is in operation so that you can see inside and check the progress of your recipe. Directions given in recipes to 'elevate', 'stir', and the like should be thought of as the minimum steps recommended. If the food seems to be cooking unevenly, simply make the necessary adjustments you think appropriate to correct the problem.

**Factors affecting cooking times.** To check the wattage of your oven, refer to the specifications at the beginning of this book. Many factors affect cooking times. The temperature of ingredients used in a recipe makes a big difference in cooking times.

For example, a cake made with ice-cold butter, milk, and eggs will take considerably longer to bake than one made with ingredients that are at room temperature. All of the recipes in this book give a range of cooking times. In general, you will find that the food remains under-cooked at the lower end of the time range, and you may sometimes want to cook your food beyond the maximum time given, according to personal preference. The governing philosophy of this book is that it is best for a recipe to be conservative in giving cooking times. While undercooked food is ruined for good. Some of the recipes, particularly those for bread, cakes, and custards, recommend that food be removed from the oven when they are slightly undercooked. This is not a mistake. When allowed to stand, usually covered, these foods will continue to cook outside of the oven as the heat trapped within the outer portions of the foods gradually travels inward. If the foods are left in the oven until they are cooked all the way through, the outer portions will become overcooked or even burnt. As you gain experience in using your microwave oven, you will become increasingly skillful in estimating both cooking and standing times for various foods.

## How Food Characteristics Affect Microwave Cooking

**Density of foods:** Light, porous food such as cakes and breads cook more quickly than heavy, dense foods such as roasts and casseroles. You must take care when microwaving porous foods that the outer edges do not become dry and brittle.

**Height of foods:** The upper portion of tall foods, particularly roasts, will cook more quickly than the lower portion. Therefore, it is wise to turn tall foods during cooking, sometimes several times.

**Moisture content of foods:** Since the heat generated from microwaves tends to evaporate moisture, relatively dry foods such as roasts and some vegetables should either be sprinkled with water prior to cooking or covered to moisture.

**Bone and fat content of foods:** Bones conduct heat and fat cooks more quickly than meat. Therefore, care must be taken when cooking bony or fatty cuts of meat that the meats do not cook unevenly and do not become overcooked.

**Quantity of foods:** The number of microwaves in your oven remains constant regardless of how much food is being cooked. Therefore, the more food you place in the oven, the longer the cooking time. Remember to decrease cooking times by at least one third when halving a recipe.

**Shape of foods:** Microwaves penetrate only about 1 inch (2.5cm) into foods the interior portion of thick foods are cooked as the heat generated on the outside travels inward. In other words, only the outer edge of any foods is actually cooked by microwave energy; the rest is cooked by convection. It follows then that the worst possible shape for a food that is to be microwaved is a thick square. The corners will burn long before the centre is even warm. Round thin foods and ring shaped foods cook successfully in the microwave.

## Special Techniques In Microwave Cooking

**Browning:** Meats and poultry that are cooked fifteen minutes or longer will brown lightly in their own fat. Foods that are cooked for a shorter period of time may be brushed with a browning sauce to achieve an appetizing colour. The most commonly used browning sauces are Worcestershire sauce, soya sauce and barbecue sauce. Since relatively small amounts of browning sauces are added to foods, the original flavour of recipes are not altered.

**Covering:** A cover traps heat and steam which causes food to cook more quickly. You may either use a lid or microwave clingfilm with a corner folded back to prevent splitting.

**Covering with greaseproof paper:** Greaseproofing effectively prevents spattering and helps food retain some heat. But because it makes a looser cover than a lid or clingfilm, it allows the food to dry out slightly.

**Wrapping in greaseproof or paper towel:** Sandwiches and many other foods containing prebaked bread should be wrapped prior to microwaving to prevent drying out.

**Arranging and spacing:** Individual foods such as baked potatoes, small cakes and hors d'oeuvres will heat more evenly if placed in the oven an equal distance apart, preferably in a circular pattern. Never stack foods on top of one another.

**Stirring:** Stirring is one of the most important of all microwaving techniques. In conventional cooking, foods are stirred for the purpose of blending. Microwaved foods, however, are stirred in order to spread and redistribute heat. Always stir from the outside towards the centre as the outside of the food heats first.

**Turning over:** Large, tall foods such as roasts and whole chickens should be turned so that the top and bottom will cook evenly. It is also a good idea to turn cut up chicken and chops.

**Placing thicker portions facing outwards:** Since microwaves are attracted to the outside portion of foods, it makes sense to place thicker portions of meat, poultry and fish to the outer edge of the baking dish. This way, thicker portions will receive the most microwave energy and the foods will cook evenly.

**Shielding:** Strips of aluminium foil, which block microwaves, are sometimes placed over the corners or edges of square and rectangular foods to prevent those portions from overcooking. Never use too much foil and make sure the foil is tightly secured to the dish or it may cause 'arcing' in the oven.

**Elevating:** Thick or dense foods are often elevated so that microwaves can be absorbed by the underside and centre of the foods.

**Piercing:** Foods enclosed in a shell, skin or membrane are likely to burst in the oven unless they are pierced prior to cooking. Such foods include both yolks and whites of eggs, clams and oysters and many whole vegetables and fruits.

**Testing if cooked:** Because foods cook so quickly in a microwave oven, it is necessary to test food frequently. Some foods are left in the microwave until completely cooked, but most foods, including meats and poultry, are removed from the oven while still slightly undercooked and allowed to finish cooking during standing time. The internal temperature of foods will rise between 5 °F(3 °C) and 15 °F (8 °C) during standing time.

**Standing time:** Foods are often allowed to stand for 3 to 10 minutes after being removed from the microwave oven. Usually the foods are covered during standing time to retain heat unless they are supposed to be dry in texture (some cakes and biscuits, for example). Standing allows foods to finish cooking and also helps flavour blend and develop.

## Microwave-Safe Utensils

**Never use metal or metal trimmed utensils in your microwave oven.** Microwaves cannot penetrate metal. They will bounce off any metal object in the oven and cause arcing, an alarming phenomenon that resembles lightning.

Most heat resistant non metallic cooking utensils are safe for use in your microwave oven. However, some may contain materials that render them unsuitable as microwave cookware. If you have any doubts about a particular utensil, there's a simple way to find out if it can be used in your microwave oven.

**Testing utensils for microwave use:** Place the utensil in question next to a glass bowl filled with water in the microwave oven.

Microwave at power HIGH for 1 minute. If the water heats up but the utensil remains cool to the touch, the utensil is microwave-safe. However, if the water does not change temperature but the utensil becomes warm, microwaves are being absorbed by the utensil and it is not safe for use in the microwave oven. You probably have many items on hand in your kitchen right now that can be used as cooking equipment in your microwave oven. Just read through the following checklist.

**1. Dinner plates:** Many kinds of dinner-ware are microwave-safe. If in doubt consult the manufacturer's literature or perform the microwave test.

**2. Glassware:** Glassware that is heat-resistant is microwave-safe. This would include all brands of oven tempered glass cookware. However, do not use delicate glassware, such as tumblers or wine glasses, as these might shatter as the food warms.

**3. Paper:** Paper plates and containers are convenient and safe to use in your microwave oven, provided that the cooking time is short and foods to be cooked are low in fat and moisture. Paper towels are also very useful for wrapping foods and for lining baking trays in which greasy foods such as bacon are cooked. In general, avoid coloured paper products as the colour may run.

**4. Plastic storage containers:** These can be used to hold foods that are to be quickly reheated. However, they should not be used to hold foods that will need considerable time in the oven as hot foods will eventually warp or melt plastic containers.

**5. Plastic cooking bags:** These are microwave-safe, provided they are specially made for cooking. However, be sure to make a slit in the bag so that steam can escape. Never use ordinary plastic bags for cooking in your microwave oven, as they will melt and rupture.

**6. Plastic microwave cookware:** A variety of shapes and sizes of microwave cookware is available. For the most part, you can probably microwave items you already have on hand rather than investing in new kitchen equipment.

**7. Pottery, stoneware and ceramic:** Containers made of these materials are usually fine for use in your microwave oven, but they should be tested to be sure.

**CAUTION: HIGH IRON CONTENT, HIGH LEAD CONTENT, SOME ITEMS NOT FOR COOKING.**

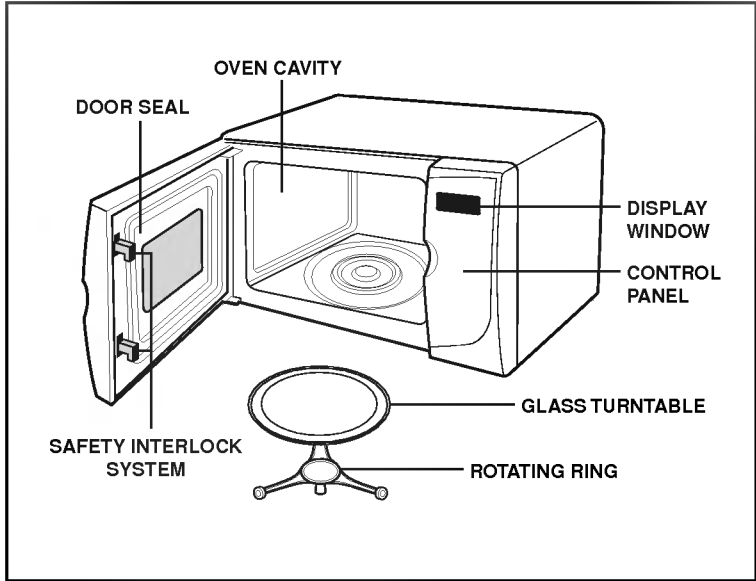

Your oven will be packed with the following materials:

- Glass Turntable ----- 1 each
- Owner's Manual ----- 1 each
- Rotating Ring ----- 1 each

This microwave oven is designed for household use only. It is not recommended for commercial purposes.

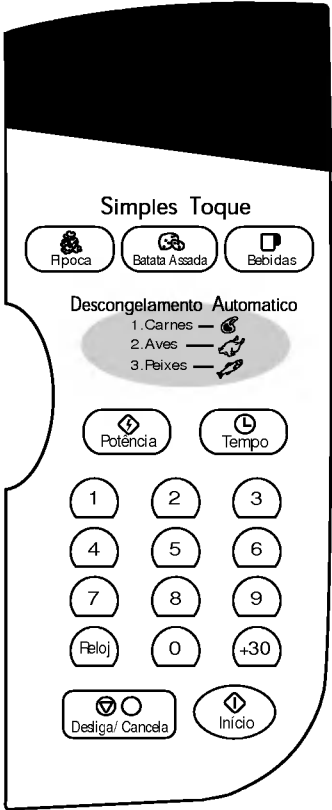

**NOTE:** A beep sounds when a pad on the control panel is touched, to indicate a setting has been entered.

## SETTING CLOCK

This is a 12 hour clock.

When your oven is plugged in for the first time or when power resumes after a power interruption, the numbers in the display reset to 0.

**Example: To set 11:11**

 Touch **Desliga/Cancela**.

 Touch **Reloj**.

 Enter the time by using the number key pads. **[1], [1], [1], and [1]**.

 Touch **Reloj**.  
The clock starts counting.

### NOTE:

To erase Err, touch Desliga/Cancela pad.

## + 30

+30 allows you to cook for 30 seconds at 100% power by simply touching the +30 pad. You can also extend cooking time in multiples of 30 seconds by repeatedly touching the +30 pad during cooking.

**Example: To set cooking for 2 minutes with +30 pad.**

 Touch **Desliga/Cancela**.

 Touch **+30** 4 times.  
The oven begins cooking and display shows time counting down.

### NOTE:

Maximum available time is 99 minute 59 seconds.

## TIMED COOKING

This function allows you to cook for a desired time. And in order to give you the best results, there are 10 power level settings in addition to HI-POWER because many food need slower cooking (at less than HI-POWER).

**Example: To cook food on 80% Power (Power8) for 5 minutes 30 seconds**

1. Touch **Desliga/Cancela**.
2. Touch **Tempo**.
3. Enter 5 minutes 30 seconds by touching **[5], [3], and [0]**.
4. Touch **Potência**.  
P-HI appears in the display. This is to tell you that the oven is set on HI unless a different power setting is chosen.
5. Touch **8**.  
To select power level 80%. Display shows **P-80**.
6. Touch **Início**.

When the cooking time is over, two short and one long tone sounds. The word **End** shows in the display window. Then the oven shuts itself off.

### NOTE:

If you do not select power level, the oven will operate at power HIGH. To set HI-POWER cooking, skip steps 4 & 5 above.

## 2 STAGE TIMED COOKING

For Two Stage cooking, repeat timed cooking steps 2 through 5 on the previous page before touching the Inicio pad for additional Time and Power program you want to add.

Auto Weight Defrost can be programmed before the first stage to defrost first and then cook.

## MICROWAVE POWER LEVELS

Your microwave oven is equipped with tenth power levels to give you maximum flexibility and control over cooking. The table below will give you some idea of which foods are prepared at each of the various power levels.

- The chart below shows the power level settings for your oven.

**MICROWAVE POWER LEVEL CHART**

Power Level	Use
(High)	<ul style="list-style-type: none"> <li>• Boiling water.</li> <li>• Browning ground beef.</li> <li>• Making candy.</li> <li>• Cooking poultry pieces, fish, &amp; vegetables.</li> <li>• Cooking tender cuts of meat.</li> </ul>
9	<ul style="list-style-type: none"> <li>• Reheating rice, pasta, &amp; vegetables.</li> </ul>
8	<ul style="list-style-type: none"> <li>• Reheating prepared foods quickly.</li> <li>• Reheating sandwiches.</li> </ul>
7	<ul style="list-style-type: none"> <li>• Cooking egg, milk and cheese dishes.</li> <li>• Cooking cakes, breads.</li> <li>• Melting chocolate.</li> </ul>
6	<ul style="list-style-type: none"> <li>• Cooking veal.</li> <li>• Cooking whole fish.</li> <li>• Cooking puddings and custard.</li> </ul>
5	<ul style="list-style-type: none"> <li>• Cooking ham, whole poultry, lamb.</li> <li>• Cooking rib roast, sirloin tip.</li> </ul>
4	<ul style="list-style-type: none"> <li>• Thawing meat, poultry and seafood.</li> </ul>
3	<ul style="list-style-type: none"> <li>• Cooking less tender cuts of meat.</li> <li>• Cooking pork chops, roast.</li> </ul>
2	<ul style="list-style-type: none"> <li>• Taking chill out of fruit.</li> <li>• Softening butter.</li> </ul>
1	<ul style="list-style-type: none"> <li>• Keeping casseroles and main dishes warm.</li> <li>• Softening butter and cream cheese.</li> </ul>
0	<ul style="list-style-type: none"> <li>• Standing time.</li> <li>• Independent timer.</li> </ul>

## CHILD LOCK

This is a unique safety feature that prevents unwanted oven operation such as used by children. Once the child lock is set, no cooking can take place.

**Example : To set the child lock**



Touch **Desliga/Cancela**.



Touch and hold **0** until **L** appears in the display and a single beep is heard. **L** remains in the display.

When CHILD LOCK was already set, if you touch other cooking pad, the window shows **L** in the display. Then you can cancel the child lock according to below procedure.

**Example : To cancel the child lock**



Touch and hold **0** until **L** disappears in the display. The time of day return to the display window..





Touch **Desliga/Cancela**.

## TIMER

You can use the Timer of your oven for purposes other than food cooking.

**Example: To count 3 minutes for an egg or telephone call**

 Touch **Desliga/Cancela**.

 Touch **Tempo**.

 Touch numbers to set time. Timer may be set for up to 99 minute 99 seconds.

 Touch **Potência**.

 Touch **[0]** (Power Level 0).

 Touch **Início**.

## ONE TOUCH COOKING

One Touch Cooking made easy! Your oven's menu has been preprogrammed to cook food automatically. Tell the oven what you want. Then let your microwave oven cook your selections.

**Example: To cook popcorn simply follow the step below**

 Touch **Desliga/Cancela**.

- Place popcorn in the oven and close the door.

 Touch **Pipoca**.  
The oven begins the cooking you selected without the need to touch **Início**. Be sure to close the door before selecting categories.

## ONE TOUCH COOKING CHART

Key	Touch keypad	Serving size	Directions	Cover
<b>POPCORN</b>	1 Time 2 Times 3 Times	3.5 oz. (100g) 3.0 oz. (85g) 1.75 oz. (50g)	f U Follow package instructions. f U Use popcorn package which is made especially for microwave cooking. f U Do not try to pop unpopped kernels. f U Heat only 1 package at a time. f U Do not leave the microwave oven unattended while popping popcorn.	None
<b>POTATO (PARAS AL HORNO)</b>	1 Time 2 Time 3 Times 4 Times	1 ea (225g) 2 ea (450g) 3 ea (675g) 4 ea (900g)	f U Place in center of the oven on paper towel. Pierce potato several times with fork. After cooking, let stand for 5 minutes.	None
<b>BEVERAGE (BEBIDAS)</b>	1 Time 2 Times	1 cup (225g) 2 cups (450g.)	f U Use mug or microwave-safe cup. f U Stir after reheating.	None

## AUTO WEIGHT DEFROST

Three defrost sequences are preset in the oven. The defrost feature provides you with the best defrosting method for frozen foods. The cooking guide will show you which defrost sequence is recommended for the food you are defrosting. With the Auto Weight Defrost feature, the oven automatically sets the defrosting time and power levels for you.

The oven automatically determines required defrosting times for each food item according to the weight you enter.

For added convenience, the Auto Weight Defrost Feature contains a built-in beep mechanism that lets you check, turn over, separate or rearrange as recommended in the Auto Defrosting AUTO WEIGHT DEFROST GUIDE.

Three different defrosting levels are provided.

- 1 CARNES**
- 2 AVES**
- 3 PEIXES**

- You can select the category by touching the key once (CARNES), twice (AVES), or three times (PEIXES).
- Available weight is 0.1~4.0 kg. However, when you want to defrost and cook consecutively, you should enter less than 4.0 kg. If you attempt to defrost and cook 4.0 kg consecutively, **Err** will show in the display window.

**Example : To defrost 1.2 kg of ground beef, select Meat menu, enter the weight, and press INICIO**



Touch **Desliga/Cancela**.

Descongelamento Automatico

- 1. Carnes —
- 2. Aves —
- 3. Peixes —

Touch **Descongelamento Automatico**. **dEF 1** appears in the display.



Enter the weight by touching **[1]** and **[2]**. **1.2** appears in the display.



Touch **Inicio**. Defrosting starts.

### NOTE:

When you touch the START pad, the display changes to defrost time count down. The oven will beep twice during the DEFROST cycle. At each beep, open the door and turn, separate or rearrange the food.

Remove any portions that have thawed.

Return frozen portions to the oven and touch START to resume the defrost cycle. **The oven will not STOP during the BEEP unless the door is opened.**

- For best results, remove fish, shellfish, meat, and poultry from its original closed paper or plastic package (wrapper). Otherwise, the wrap will hold steam and juice close to the foods, which can cause the outer surface of the foods to cook.
- Place foods in a shallow glass baking dish or on a microwave roasting rack to catch drippings.
- Food should still be somewhat icy in the center when removed from the oven.

### AUTO WEIGHT DEFROST SEQUENCE LIST

Sequence	Food
<b>1 MEAT (CARNES)</b>	<b>BEEF</b> Ground beef, Round steak, Cubes for stew, Tenderloin steak, Pot roast, Rib roast, Rump roast, Chuck roast, Hamburger patty.
	<b>LAMB</b> Chop(1 inch thick), Rolled roast
	<b>PORK</b> Chop(1/2 inch thick), Hot dogs, Spareribs, Country-style ribs. Rolled roast, Sausage.
<b>2 POULTRY (AVES)</b>	<b>VEAL</b> Cutlets(1 lbs,1/2 inch thick)
	<b>POULTRY</b> Whole(under 1.8kg), Cut up Breasts (boneless)
	<b>CORNISH HENS</b> Whole
<b>3 FISH (PEIXES)</b>	<b>TURKEY</b> Breast(under 2.7kg)
	<b>FISH</b> Fillets, Whole Steaks
	<b>SHELLFISH</b> Crab meat, Lobster tails, Shrimp, Scallops

**WARNING : Do not use aluminum foil during cooking cycle.**

## MEAT (CARNES)

1. No special techniques are required. The roast should be prepared and seasoned (if desired) as for any other conventional method. Meat should be thoroughly defrosted before cooking.
2. Place the meat on a microwave roasting rack or ovenproof plate and place on the turntable.
3. Cook according to the cooking chart (below), using the longer time for large meats and the shorter time for smaller meats. For thicker chops, use the longer time.
4. Turn the meat once halfway through the cooking time.
5. STAND for 5-10 minutes wrapped in foil after cooking. The standing time is very important as it completes the cooking process.
6. Ensure meat, especially pork, is thoroughly cooked before eating.

**MEAT COOKING CHART**

Cut	Microwave power	Cooking time per 500g
<b>BEEF</b>		
Standing/Rolled Rib		
-Rare	8	9~11 minutes
-Medium	8	10~12 minutes
-Well-done	8	12~14 minutes
Ground Beef (to brown for casserole)	HIGH	7~9 minutes
Hamburgers, Fresh or defrosted (4 oz. each)		
-2 patties	HIGH(100%)	3~5 minutes
-4 patties	HIGH(100%)	4~6 minutes
<b>PORK</b>		
Loin, Leg	8	13~16 minutes
Bacon		
-4 slices	HIGH	3~4 minutes
-6 slices	HIGH	4~6 minutes

**NOTE:**

The above times should be regarded only as a guide. Allow for difference in individual tastes and preferences. The times may vary due to the shape, cut, and composition of the meat.

## POULTRY (AVES)

1. No special techniques are required. The poultry should be prepared as for any other conventional method. Season if desired.
2. Poultry should be thoroughly defrosted, ensuring giblets and any metal clamps are removed.
3. Prick the skin and brush lightly with vegetable oil unless self-basting.
4. All poultry should be placed on a microwave roasting rack or a microwave-proof plate and placed on the turntable.
5. Cook according to the instructions in the cooking chart (below), turning the bird over halfway through the cooking time. Poultry, because of its shape, has a tendency to cook unevenly, especially in very bony parts. Turning the bird during roasting helps to cook these areas evenly.
6. STAND for 5-10 minutes wrapped in foil after cooking before carving. The standing time is very important, as it completes the cooking process.
7. Ensure poultry is thoroughly cooked before eating. Whole poultry is completely cooked when the juices run clear from the inside thigh when it is pierced with a sharp knife. Poultry portions should be pierced with a sharp knife through the thickest part to ensure that the juices are clear and the flesh is firm.

**POULTRY COOKING CHART**

Poultry	Microwave power	Cooking time per 500g
<b>CHICKEN</b>		
Whole	8	12~14 minutes
Breast(boned)	8	10~12 minutes
Portions	8	11~13 minutes
<b>TURKEY</b>		
Whole	8	13~15 minutes

**NOTE:**

- The above times should be regarded only as a guide. Allow for difference in individual tastes and preferences. The times may vary due to the shape, cut, and composition of the food.
- If whole birds are stuffed, the weight of the stuffed bird should be used when calculating the cooking time.

## FISH (PEIXES)

1. Arrange fish in a large shallow non-metallic dish or casserole.
2. Cover with pierced microwave plastic film or casserole lid.
3. Place the dish on the turntable.
4. Cook according to the instructions in the cooking chart (below). Flakes of butter can be added to the fish if desired.
5. Let STAND as directed in the cooking chart before serving.
6. After standing time, check to see that the fish is thoroughly cooked. The fish should be opaque and flake easily.

**FRESH FISH COOKING CHART**

<b>Fish</b>	<b>Microwave power</b>	<b>Cooking Time per 500g</b>	<b>Method</b>	<b>Standing Time</b>
Fish Fillets	HIGH	5~7 minutes	Add 15~30 ml (1~2 tbsp.)	2~3 minutes
Whole Mackerel, Cleaned and Prepared	HIGH	5~7 minutes	—	3~4 minutes
Whole Trout, Cleaned and Prepared	HIGH	6~8 minutes	—	3~4 minutes
Salmon Steaks	HIGH	6~7 minutes	Add 15~30 ml (1~2 tbsp.)	3~4 minutes

### For Best Results:

1. When determining the time for a particular food, begin by using minimum time and checking occasionally for doneness. It is easy to overcook food because microwaves cook very quickly.
2. Small quantities of food or foods with low water content may dry out and become hard if cooked too long.
3. Do not use the oven for drying kitchen towels or paper products. They may burn.
4. Break eggs before cooking them in the microwave.
5. For food items such as apples, potatoes, egg yolks, chicken livers, etc., be sure to pierce the skin or membrane to prevent bursting of the food while cooking in the oven.

### Defrosting Frozen Foods:

1. Foods that have been frozen can be placed directly in the oven for thawing. (Be certain to remove any metallic ties or wraps.)
2. Defrost according to the Defrost Guide found in this Manual.
3. For areas of the food thawing faster than others, shield if necessary.  
This helps slow down or stop the defrosting process.
4. Some foods should not be completely thawed before cooking. For example, fish cooks so quickly that it is sometimes better to begin cooking while still slightly frozen.
5. It may be necessary to increase or decrease the cooking time in some recipes, depending on the starting temperature of the foods.

### NOTE:

Air from the vent may become warm during cooking. This is normal.

### Browning:

There are a few foods which are not cooked long enough in the microwave oven to brown and may need additional colour.

Coatings such as SHAKE & BAKE<sup>®</sup>, paprika, and browning agents such kitchen bouquet<sup>®</sup> or Worcestershire sauce may be used on chops, meat patties or chicken parts.

Roasts, poultry or ham, cooked for 10-15 minutes or longer, will brown nicely without extra additives.

### Cooking Utensils:

1. Most glass, ceramic glass and heat resistant glassware utensils are excellent.
2. Most paper napkins, towels, plates, cups, cartons, and cardboard are convenient utensils. Some recycled paper products may contain impurities which could cause arcing or fires when used in the microwave oven.
3. Some plastic dishes, cups, containers, and wraps may be used in the microwave oven. Follow the manufacturer's instructions or information given in the cooking guide when using plastics in the microwave oven.
4. Metal utensils and utensils with metallic trim should not be used in the microwave oven.

### To Clean Your Oven:

1. Keep the inside of the oven clean.  
Food spatters or spilled liquids stick to oven walls and between seal and door surface. It is best to wipe up spillovers with a damp cloth right away. Crumbs and spillovers will absorb microwave energy and lengthen cooking times. Use a damp cloth to wipe out crumbs that fall between the door and the frame. It is important to keep this area clean to assure a tight seal. Remove greasy spatters with a sudsy cloth then rinse and dry. Do not use harsh detergent or abrasive cleaners. The glass tray can be washed by hand or in the dishwasher.
2. Keep the outside of the oven clean.  
Clean the outside of your oven with soap and water then with clean water and dry with a soft cloth or paper towel. To prevent damage to the operating parts inside the oven, the water should not be allowed to seep into the ventilation openings.  
To clean control panel, open the door to prevent oven from accidentally starting, and wipe with a damp cloth followed immediately by a dry cloth. Press Desliga/Cancela after cleaning.
3. If steam accumulates inside or around the outside of the oven door, wipe the panels with a soft cloth. This may occur when the microwave oven is operated under high humidity conditions and in no way indicates a malfunction of the unit.
4. The door and door seals should be kept clean.  
Use only warm, soapy water, rinse then dry thoroughly. **DO NOT USE ABRASIVE MATERIALS, SUCH AS CLEANING POWDERS OR STEEL AND PLASTIC PADS.**  
Metal parts will be easier to maintain if wiped frequently with a damp cloth.

1. Do not attempt to tamper with, or make any adjustments or repairs to the door, control panel, safety interlock switches or any other part of the oven. Repairs should only be undertaken by a qualified service technician.
2. Do not operate the oven when empty. It is best to leave a glass of water in the oven when not in use. The water will safely absorb all microwave energy, if the oven is accidentally started.
3. Do not dry clothes in the microwave oven, which may become carbonized or burned if heated too long.
4. Do not cook food wrapped in paper towels, unless your cook book contains instructions, for the food you are cooking.
5. Do not use newspaper in place of paper towels for cooking.
6. Do not use wooden containers. They may heat-up and char.  
Do not use metal containers or crockery containers which have metallic (e.g. gold or silver) inlays. Always remove metal twist ties.  
Metal objects in the oven may arc, which can cause serious damage.
7. Do not operate the oven with a kitchen towel, a napkin or any other obstruction between the door and the front edges of the oven, which may cause microwave energy leakage.
8. Do not use recycled paper products since they may contain impurities which may cause sparks and/or fires when used in cooking.
9. Do not rinse the turntable by placing it in water just after cooking. This may cause breakage or damage.
10. Small amounts of food require shorter cooking or heating time. If normal times are allowed they may overheat and burn.
11. Be certain to place the oven so the front of the door is 8cm or more behind the edge of the surface on which it is placed, to avoid accidental tipping of the appliance.
12. Before cooking, pierce the skin of potatoes, apples or any such fruit or vegetable.
13. Do not cook eggs in their shell. Pressure will build up inside the egg which will burst.
14. Do not attempt deep fat frying in your oven.
15. Remove the plastic wrapping from food before cooking or defrosting. Note though that in some cases food should be covered with plastic film, for heating or cooking, as detailed in microwave cook books.
16. The oven must never be used if the door sealing is not in good working order.
17. When liquids are cooked in microwave units, they may be overheated above their boiling point without visible bubbling. When the container is removed, the shock may cause the sudden formation of steam bubbles. A fountain of hot liquid can spring up out of the container explosively.
18. If smoke is observed keep the oven door closed and switch off or disconnect the oven from the power supply.
19. When food is heated or cooked in disposable containers of plastic, paper or other combustible materials look at the oven frequently to check if the food container is deteriorating.

**WARNING**—Please ensure cooking times are correctly set as over cooking may result in FIRE and subsequent DAMAGE to the OVEN.

Q. What's wrong when the oven light will not glow?

A. There may be several reasons why the oven light will not glow.

; E Light bulb has blown.

; E Door is not closed.

Q. Does microwave energy pass through the viewing screen in the door?

A. No. The holes, or ports, are made to allow light to pass; they do not let microwave energy through.

Q. Why does the beep tone sound when a pad on the Control Panel is touched?

A. The beep tone sounds to assure that the setting is being properly entered.

Q. Will the microwave oven be damaged if it operates while empty?

A. Yes. Never run it empty or without the glass tray.

Q. Why do eggs sometimes pop?

A. When baking, frying, or poaching eggs, the yolk may pop due to steam build up inside the yolk membrane. To prevent this, simply pierce the yolk before cooking. Never microwave eggs in the shell.

Q. Why is standing time recommended after microwave cooking is over?

A. After microwave cooking is finished, food keeps on cooking during standing time. This standing time finishes cooking evenly throughout the food. The amount of standing time depends on the density of the food.

Q. Is it possible to pop popcorn in a microwave oven?

A. Yes, if using one of the two methods described below:

(1) Popcorn-popping utensils designed specifically for microwave cooking.

(2) Prepackaged commercial microwave popcorn that contains specific times and power outputs needed for an acceptable final product.

FOLLOW EXACT DIRECTIONS GIVEN BY EACH MANUFACTURER FOR THEIR POPCORN PRODUCT. DO NOT LEAVE THE OVEN UNATTENDED WHILE THE CORN IS BEING POPPED. IF CORN FAILS TO POP AFTER THE SUGGESTED TIMES, DISCONTINUE COOKING. OVERCOOKING COULD RESULT IN AN OVEN FIRE.

**CAUTION:** NEVER USE A BROWN PAPER BAG FOR POPPING CORN. NEVER ATTEMPT TO POP LEFTOVER KERNELS.

Q. Why doesn't my oven always cook as fast as the cooking guide says?

A. Check your cooking guide again to make sure you've followed directions correctly, and to see what might cause variations in cooking time. Cooking guide times and heat settings are suggestions, chosen to help prevent over-cooking, the most common problem in getting used to a microwave oven. Variations in the size, shape, weight and dimensions of the food require longer cooking time. Use your own judgement along with the cooking guide suggestions to test for doneness, just as you would do with a conventional cooking.



**LG Electronics Inc.**