



Washing Machine

OWNER'S MANUAL

MODEL : WF-T1031TP
WF-T1235TP

Please read this manual carefully before operating your set.
Retain it for future reference.
Record model number and serial number of the set.
See the label attached on the back cover and quote this
information to your dealer when you require service.



P/No.: 3828FA3984K



CAUTION

"Turbo Drum" washer doesn't operate during the lid opened. When the lid is open during the wash, rinse and spin cycle, the operation stops for safety.

Fuzzy logic control

- A load sensor & a micro processor in the controller detect laundry load and set optimum washing conditions such as water level, wash time etc.
- The most advanced technology in electronic control system provides the best washing performance.



Turbo drum washing

- When "Punch + 3" washing wings turns, the washing tub turns in the opposite direction. This makes the both sides current of water which improve wash-performance by rubbing clothes strongly.



3 Step washing

- 3 step washing makes best washing performance with low tangling.



Rubbing



Rubbing and Shaking



Shaking and Disentangling



Innovated washing wings

- Three small washing wings generate strong and sharp washing currents to clean laundry uniformly.
- Adjusted vertical movement and rotating direction of the washing punch reduces laundry entanglement and improves washing power.

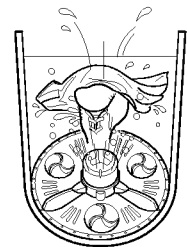

Device for removing naps

- Lint filter catches naps and thread generated during washing to make the laundry cleaner.





Special Attention for Safety	4
Name of Each Part	7
Installation	8
Function of Each Button	12
Normal Wash Program	14
Heavy Wash Program	16
Speedy Wash Program	18
Wool Wash Program	20
Delay Start Washing Program	22
Soak Wash Program	24
Selectable Washing Methods	26
Water Level and Amount of Detergent	28
How to Use the Bleach and the Softener	29
Basic of Selecting Each Button and Child Lock Selection	30
Maintaining the Washer	31
Troubleshooting Guide	33
Specifications	35



Following signs of special attention for safety are to prevent from unexpected danger of damages by using the washing machine properly and safely.

It is classified into "caution" and "attention". They have meanings of following.

 This signs are for possible situation of dangerous items and operation. Please read carefully and follow the direction to avoid any damages.

 **Caution** : There might be possible circumstances for serious injury of even death, when this signs are violated.

 **Attention** : There might be possible circumstances for light injury or damages of the product.

Please ground it or connect to circuit breaker before inserting power plug into outlet.
If it's not grounded, machine troubles of electric shock can be occurred in case of short circuit

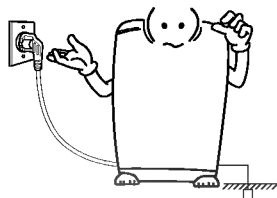

Please ask for repairing when spin doesn't stop within 15 seconds after opening the washing machine lid. It causes injury.



Please pay attention to children not to climb up or to get into the product.
Possible to get injured by falling or spin part.

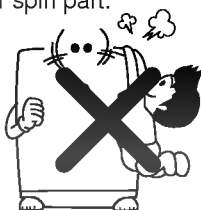

Do not put your foot or hands under washing machine. Spin part underneath of the product can cause injury.



Be careful not to fall into washing machine when you use prop.
Possible to get injured or fall down.



Do not operate near places where there are ignitability, gasoline benzene and flammable gas leakage and do not wash any flammable strained clothes. It can causes explosion of fire.



Caution

Do not operate it when the plug is loose.
Damaged plug can cause electric shock or fire.

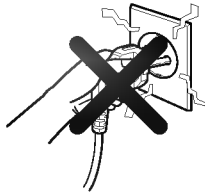

Please open the window to let fresh air in when a gas leak.
Spark can cause fire, explosion or burn.

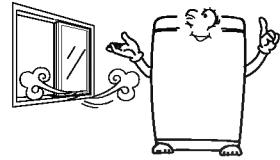

Do not put your hands in during use or before it stops completely.
You can get injured as hands is caught in the clothes.



Do not place washing machine in wet places or exposed places for rain & wind.
Electric shock, fire, machine trouble and transformation can be caused.

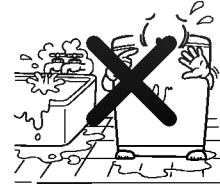

Do not place it near electric heaters, candles, or firearms.
Transformation of plastic & cord melting can caused fire or electric shock.



Do not sprinkle water to the body of washing machine.
Electric shock & fire can be caused.



Do not put any magnetic stuff on the top of the washing machine.
Fallacy of operation can cause injury.

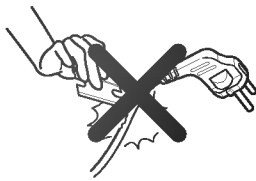

Do not disjoint or rebuild washing machine except technicians.
Fire, electric shock can be caused.

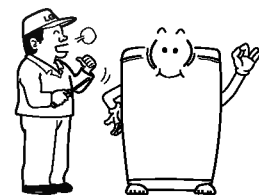

Do not use on outlet for many machineries.
Over usage of outlet can cause fire.



Do not damage the power cord by placing heavy things on it or covering it.
If the cord is damaged, it can cause fire or electric shock.

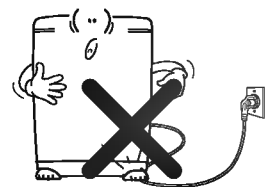

Attention

Because the product is quite heavy, so more than two people should carry it when untie or place it. Damage or injury can be caused by dropping or striking.

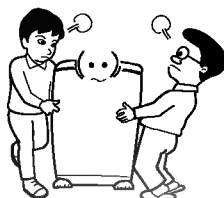

Do not press a pin or awl. It can cause electric shock.



Place it on flat and solid floor. Vibration or noise can be caused.



Check if there is dusts on the plug then insert it completely, if there is dusts on the plug or connection is unstable, a fire can be caused.

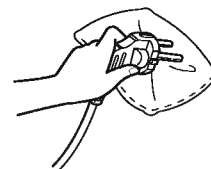

Do not place any heavy things on the top of it.



Turn the tap on or check connection. If screws are loose, water leaks and that can cause electric shock or injury.

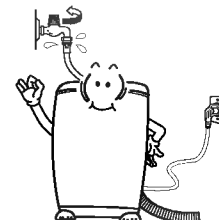

Handle the plug and switches with dried hands. It causes electric shock or ignition.

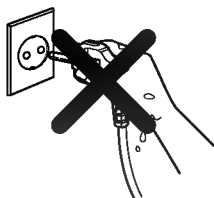

Do not use more than 70°C hot water. Plastic parts might be transformed or damaged that causes electric shock short circuit.



Do not wash the waterproof clothes or fabrics. Abnormal tremor can cause injury during spin.



Pull out the plug during cleaning or when you don't use for long time. Water and dusts can cause electric shock and short circuit by ignition or calorification.

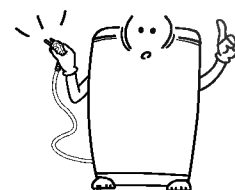

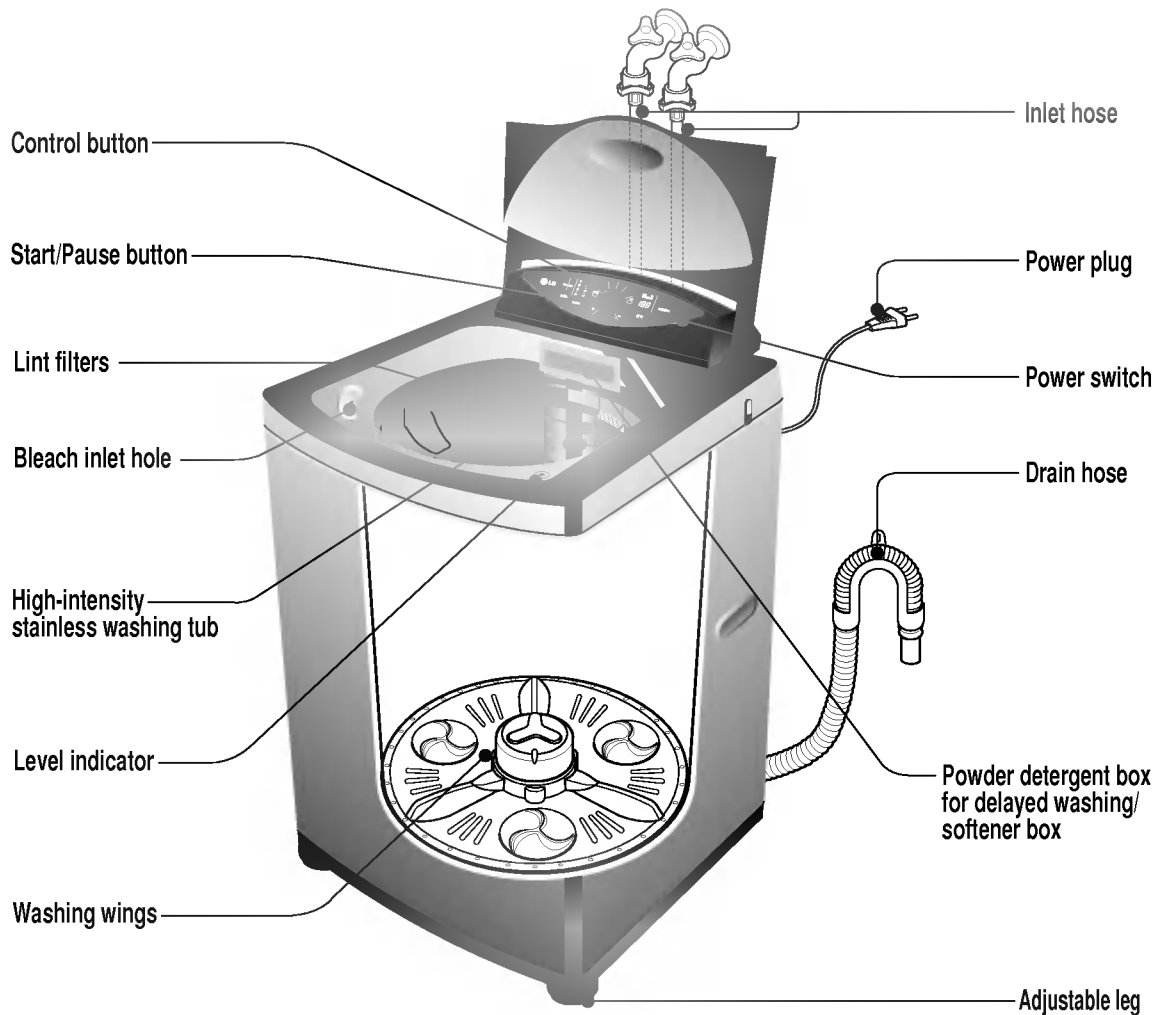

Accessories

Height adjustment plate

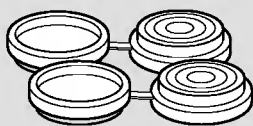

2 Pieces

Inlet hose

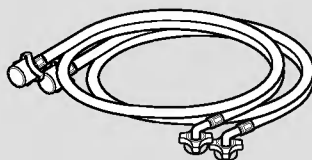

1 Each for cold and hot water

Drain hose

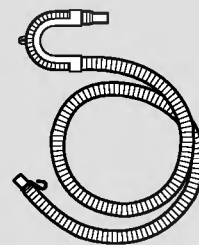

How to install the drain hose

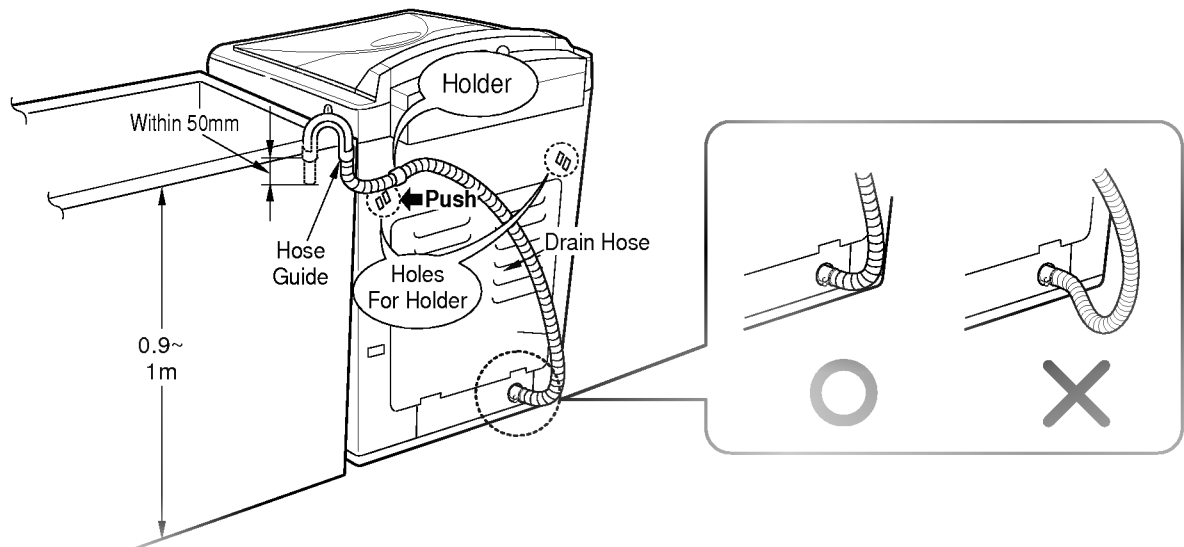

1 Fit the machine end of the drain hose to the outlet of the drain pump and tighten the clamp.

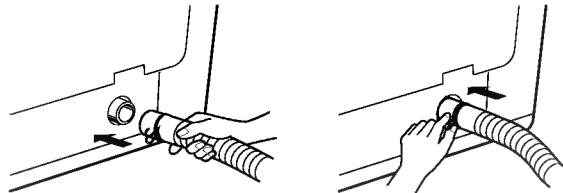

2 Fit the plastic holder into either holes for the holder at the rear of the machine. The holder is possible to fit at either direction according to location of the standpipe. Make sure that the holder keeps firmly the drain hose so that the drain hose should not fall down as shown in the fig.

3 Put the other end of the drain hose over the standpipe or wash tub.

NOTE :

- To prevent syphoning, the drain hose should not extend more than 50 mm from the end of the hose guide.
- The discharge height should be approximately 0.9~1m from the floor.

Flooding drainage

- Your machine requires a floor drainage slope (or hole) that will SAFELY DISPOSE of the FULL FLOW of any water that may leak out the machine malfunction.
It is therefore the OWNER'S RESPONSIBILITY to make sure this machine is installed in an area with a drain hole (or slope) that will prevent any possibility of water damage to floor coverings or property.



CAUTION

- Do not install the washer where it is directly exposed to sunlight, wind, rain etc.
- Plug the power cord of this washer into a properly installed standard power point that is switched & earthed.

Connecting inlet hose

The inlet hose is connected to **tabs with 3/4" thread**.

1 Ensure that rubber seals are fitted.

2 Connect the cold inlet hose having the blue end or blue markings.

- Attach the straight end of the cold hose to a cold water tap and then screw it tightly so that water will not leak.
- Attach the elbow end of the cold hose to the cold valve inlet with the blue strainer and then screw it tightly so that water will not leak.

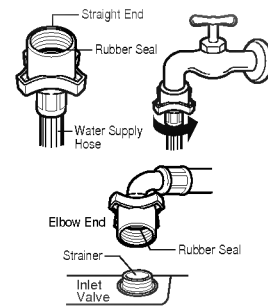

3 Connect the hot inlet hose having the red end or red markings.

- Attach the straight end of the hot hose to a hot water tap and then screw it tightly so that water will not leak.
- Attach the elbow end of the hot hose to the hot valve inlet with the red strainer and then screw it tightly so that water will not leak.

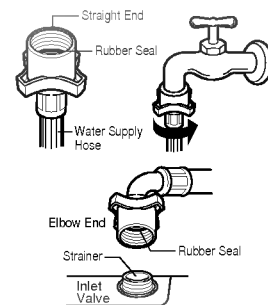

4 Make sure that the hose nuts are tight.

- It's the owner's responsibility to connect the inlet hoses so that water will not leak.



Connecting tap adapter(Optional)

For connecting the inlet hose to **taps without thread** the tap adapter is provided optionally on some models.

1 Unscrew the fixing screws of the adapter.

- Unscrew the 4 fixing screws of the tap adapter so that the tap can be placed in the middle. Push the connector vertically upwards so that the rubber seal within the adapter can completely adhere to the tap. (Take care that the rubber seal will not come off while pushing.)

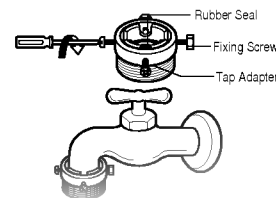

2 Fix the tap adapter to the tap.

- Place 2 fixing screws towards the wall and tighten it by hand or with a screwdriver to fit the size of the tap diameter. Then tighten the indicated 2 screws to fit the tap.

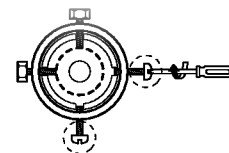

● After fixing the tap adapter connect the inlet hose according to the above instruction.



Improper installation of the washer may cause noise and malfunctioning.

1. The ventilating openings in the base area must not be obstructed by carpeting when the washing machine is installed on a carpeted floor.

2. Install the washing machine on a level and firm surface, any tilt should be less than 1°.

How to adjust level

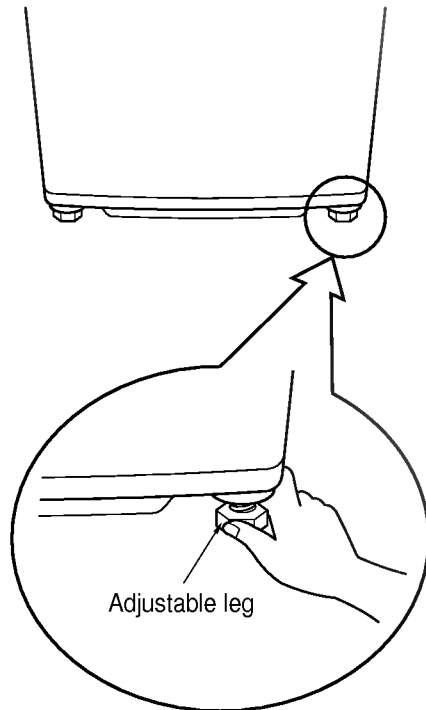

1 Installation area

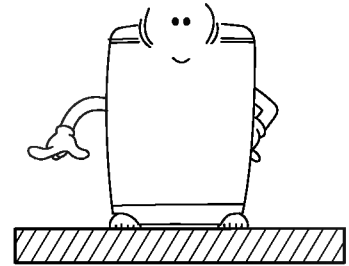

- Install the washer on flat and firm surface.

4 Horizontal setting

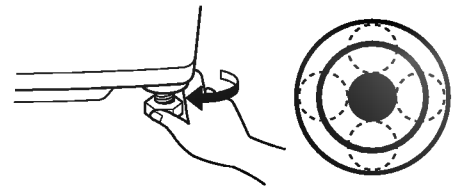

- Lift up the front of the washer and adjust the drop of the level indicator to the center by turning the adjustable legs clockwise or using the adjusting plate.

Horizontal setting

Location of drop	Cause	How to adjust
	When the front is lower.	● Adjust the front adjusting plate with the adjustable legs(2), or adjust the adjustable legs.
	When the rear is lower.	● Adjust the rear adjusting plate with the adjustable legs(2), or adjust the supporting plate.
	When the left is lower	● Adjust the left part of the front and rear adjusting plates or the supporting plate.
	When the right is lower.	● Adjust the right part of the front and rear adjusting plates or the supporting plate.

(Example) To move the drop of the level indicator by 15 mm: Use two adjusting plates and a 10 mm supporting plate, and turn the adjustable legs 2-3 times.

2 Checking level

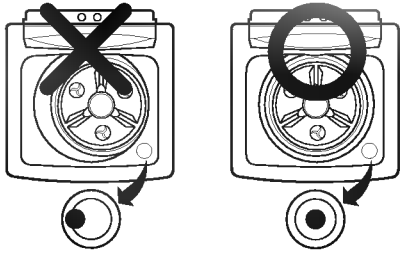

- Open the lid, and check if the washer is correctly leveled by looking down from the top.
- Adjust the drop of the level indicator to the red circle.

3 Checking slope

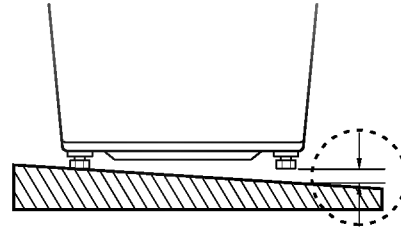

- Check if installation surface is tilted.
(Try to shake the washer and check if the washer is firmly installed.)

5 Confirming level

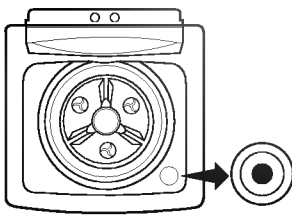

- Place the washer to original position and confirm the level as in the figure. (Try to shake the washer and confirm the level.)
- Check the location of the level in the front of washer.

Distance between drain hose and the wall

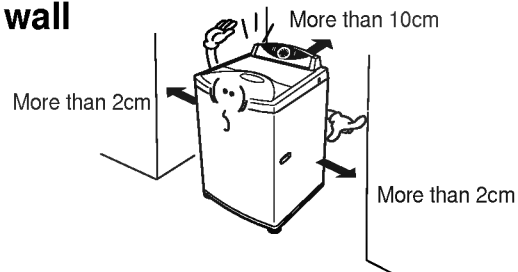

- Distance between drain hose and the wall should be more than 10cm, and the distance between the other part and the wall should be more than 2 cm.

How to use the adjusting plates

- Use the adjusting plates to level the washer when the adjustable legs cannot cover the gap.

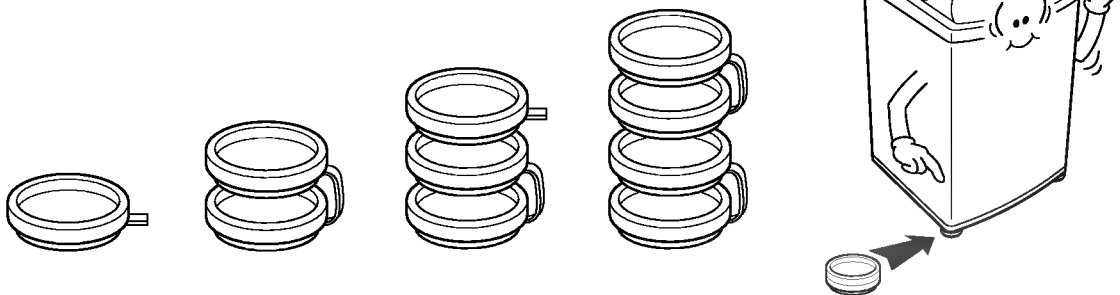

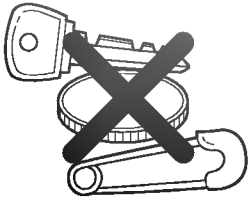

Changing various functions is possible only in PAUSE state.
 Selection button does not work when the washer is in operation
 (Except for water level, water temp.).

Preparation before wash

- Check if laundry is washable in water.
- Be sure to remove things such as keys, pins and coins from the laundry.

- Wash oily or dyed laundry separately.
- Brush off dust and soil from clothes.

- Wash fluffy laundry by turning it inside out.
- Wash delicate clothes, wrapping them in a nylon net.

- Upon loading laundry, it displays the correct amount of detergent to be added according to the amount of laundry (based on concentrated detergent).

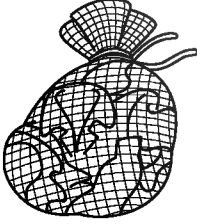
- Indicates the current washing status.
- Next step is lit, current step blinks and finished step is turned off.



- Used to select proper water temperature of washing water, [COLD → WARM(HOT+COLD) → HOT] mode repeats.
- Use it to select hot or cold water. (When hot water only is selected, hot water is supplied for washing and cold water are supplied for rinsing)

- Used to lock or unlock the control buttons to prevent all the setting from being changed by a child.
- For locking, push both buttons simultaneously and for unlocking, push them one more in washing process.

- Use it to select washing programs.
- By pressing the button, it cycles [NORMAL → HEAVY → SPEEDY → WOOL].

- Used to indicate the time left of all processes or reservation.
- In case of abnormal operation, the following indications are displayed.
 - Abnormal water supply : [] lamp blinks.
 - Abnormal drainage : [] lamp blinks.
 - Abnormal spin : [] lamp blinks.
 - Abnormal water level sensing : [] lamp blinks.
 - Abnormal lid open : [] lamp blinks.
 - Abnormal over flooding sensing : [] lamp blinks.

- Use it turn on and turn off. By pressing the button [turn on ' turn off] are repeated.
- Electric power automatically turns off 10 seconds after the washing cycle finishes with "boo-" sound.

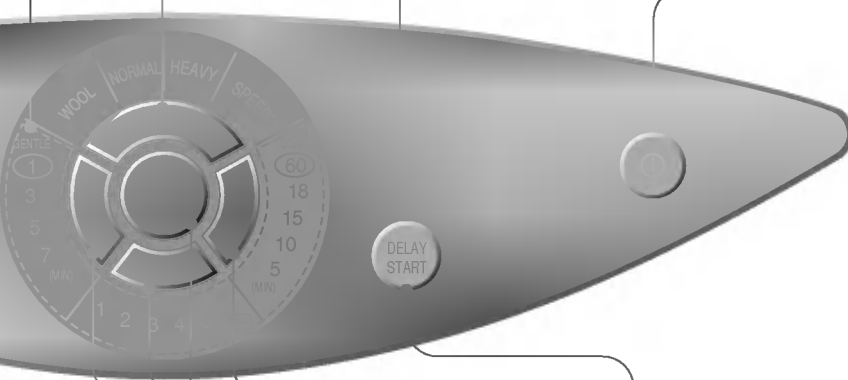

- By pressing the button, it cycles [LARGE → LARGE • EX-LARGE → EX-LARGE → SMALL → SMALL • MEDIUM → MEDIUM → MEDIUM • LARGE → LARGE].
- At NORMAL, HEAVY or SOAK program, water level is automatically based on the amount of laundry.
- Water level can be adjusted ever when the washer is in operation.

- Use this function for delayed washing.
- Use it to set the delay time.
- By pressing the button, it cycles [3 → 4 → 5 → ... → 11 → 12 → 14 → 16 → ... → 46 → 48 → 3] hours. (up to 48 hours can be delayed)
- To cancel delay time, turn the power switch off.

- Use it to start or pause temporarily.
- Pressing the button repeats start and temporary pause.
- After 10 minutes in a temporary pause state, the power will automatically turn off.

- **Wash :**
Use it to change washing time.
By pressing the button[18min → SOAK 5min → SOAK 10min → SOAK 15min → SOAK 18min → OFF → 5min → 10min → 15min]
SOAK is used to remove old or hardened dirt more effectively.
Soak time is about 60 minutes. (You cannot change in WOOL program.)
- **Rinse :**
Use it to change the frequency of rinse.
By pressing the button.
[rinse 1 → rinse 2 → rinse 3 → rinse 4 → rinse 5 → OFF → rinse 1] are repeated.
When you select rinse only, the operation starts with water supply.
- **Spin :**
Use it to change the spinning time.
By pressing the button [5 min → 7 min → OFF → 1 min → 3 min → 5 min].

Use this program for washing normal wash load.

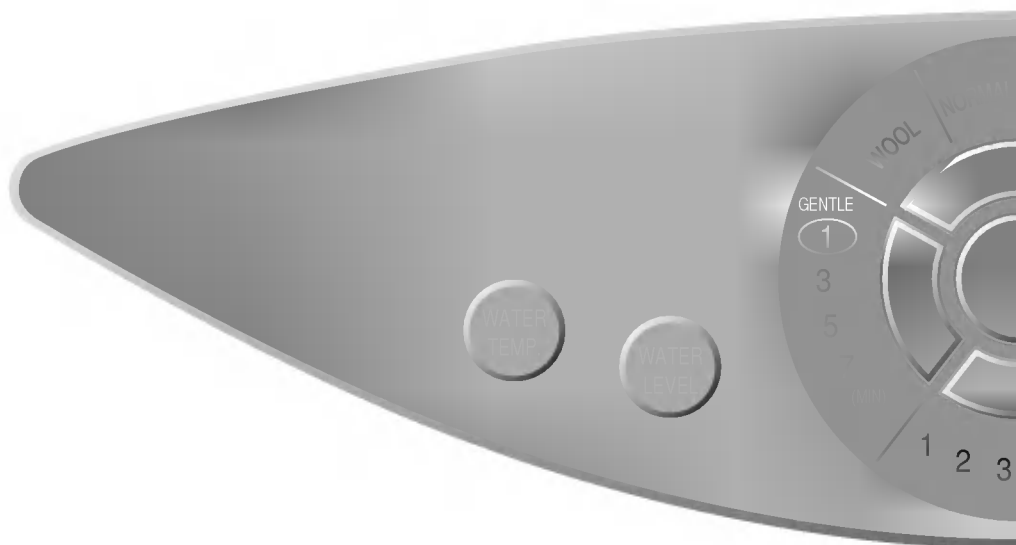

In NORMAL, HEAVY and SOAK programs.....

- The washer senses the amount and kinds of laundry and sets the most appropriate water current, wash time, number of rinses and spin time by itself.
- While sensing the most appropriate water level, each water level lamp blinks in turn.



- If either the inner-tub contains water or the laundry is wet before loading, water levels may become higher. Manually adjust proper water level before operating the washer in this case.
- Bulky and light laundry may cause a water level lower than usual. In this case, manually adjust the water level.
- For laundry that may easily be discolored, do not use [SOAK] washing.
- Water supply may be resumed about 2 minutes after starting the wash. It is an automatic water level adjustment function.
- When using neutral detergent or liquid detergent, deposit proper amount of detergent based on the [instruction for detergent].

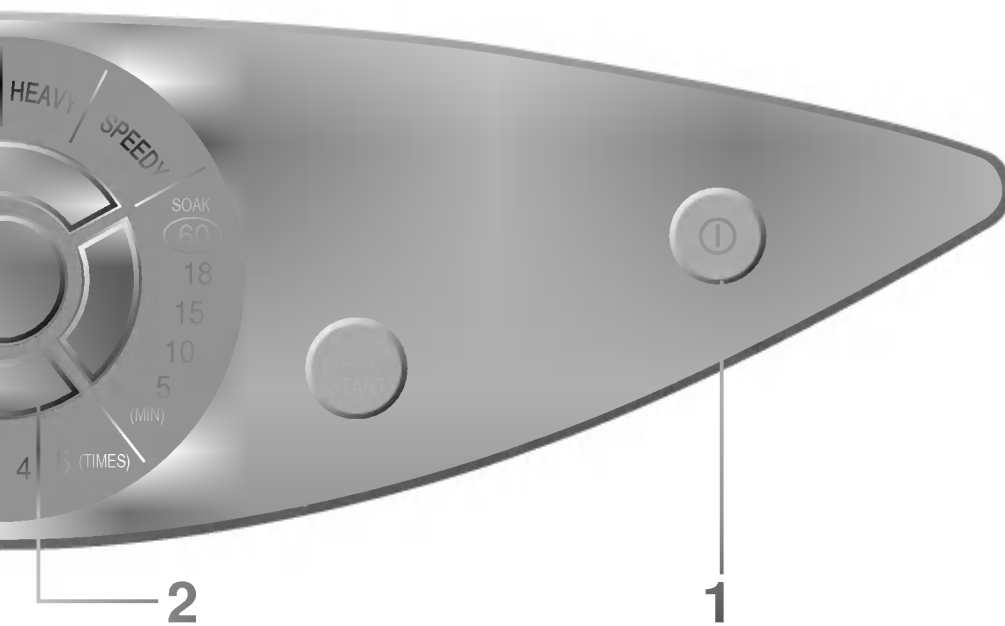

1 Press the [POWER SWITCH] button.

2 Deposit laundry and push [START/PAUSE] button.

3 Deposit detergent as indicated on the display or according to instruction of detergent manufacturer and close the lid.



- Electric power automatically turns off 10 seconds after the washing cycle finishes with "boo—" sound.
- If the lid is not closed, the machine cannot start washing and it displays "dE" with alarm sound.

Use this program for washing heavily soiled durable garments such as overalls, jeans etc.

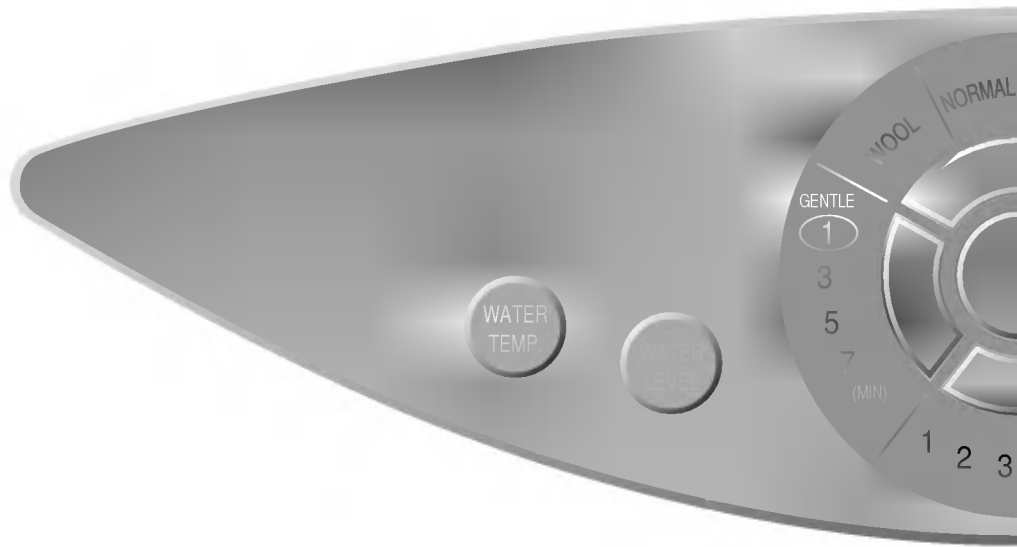

- All conditions such as water level, wash time and spin time are automatically selected by microcomputer.

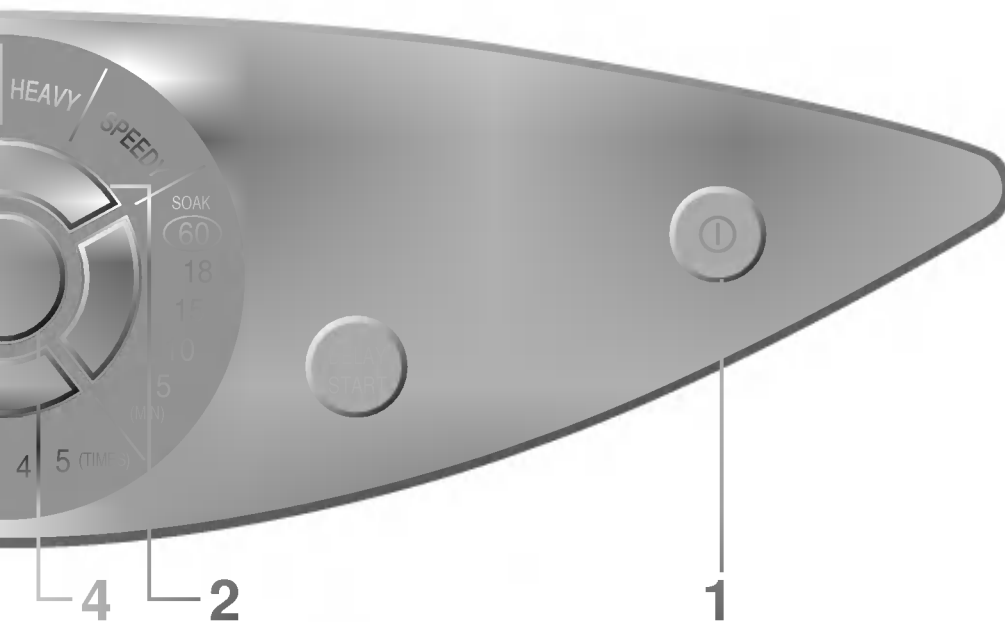

1 Press the [POWER SWITCH] button.

2 Select [HEAVY] program by pressing the program button.

3 Deposit laundry.

4 Press [STAR/PAUSE] button.

5 Deposit detergent as indicated on the display or according to instruction of detergent manufacturer and close the lid.



● If the lid is not closed, the machine cannot start washing and it displays "dE" with alarm sound.

Use this program for washing slightly soiled laundry.



- This program is economical because of its short washing time.
- Adjust water quantity according to the amount of laundry.(less then 3.0kg)
- Preset water level is medium.

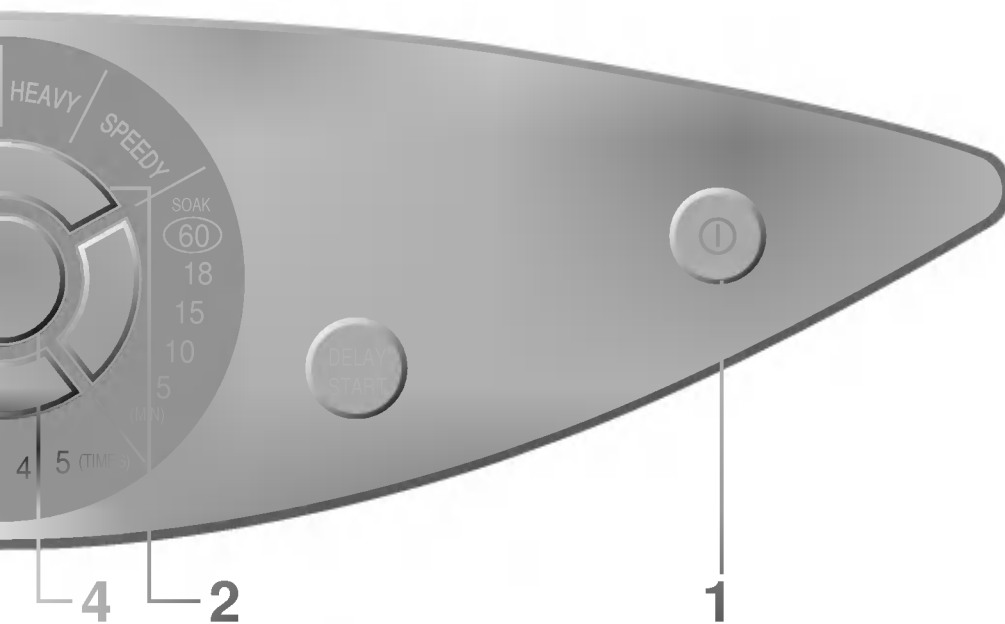

- 1** Press the [POWER SWITCH] button.
- 2** Select [SPEEDY] program by pressing the program button.
- 3** Deposit laundry.
- 4** Press [START/PAUSE] button.
- 5** Deposit detergent as indicated on the display or according to instruction of detergent manufacturer and close the lid.



- If the lid is not closed, the machine cannot start washing and it displays "dE" with alarm sound.

Use this program for washing wool, shumack, woolens.

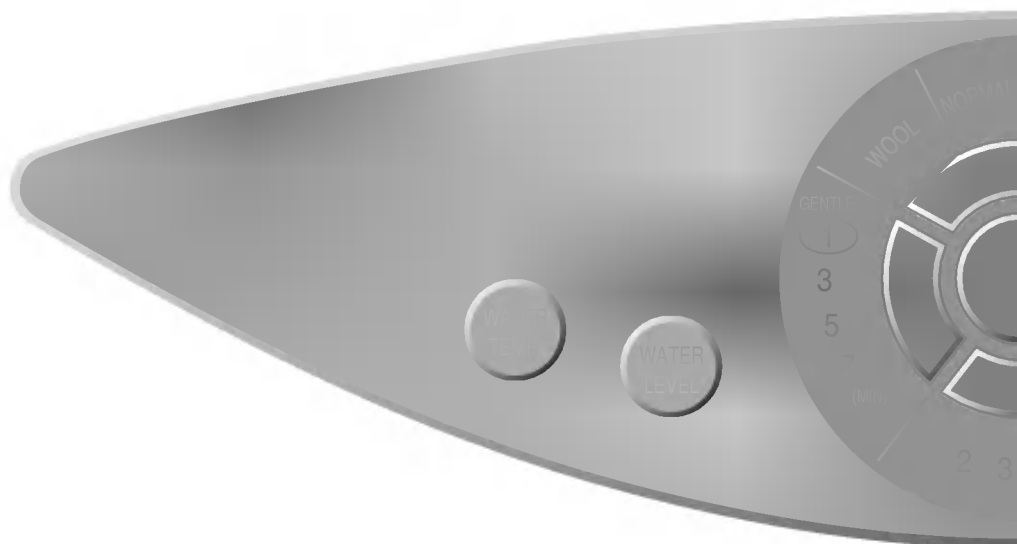

How to dry wool clothes

- Spread wool and Wool clothes on a shady, flat surface.
- In case of using a clothes hanger, wrap the upper portion of the hanger with a towel to maintain the shape of the neck or shoulder section.

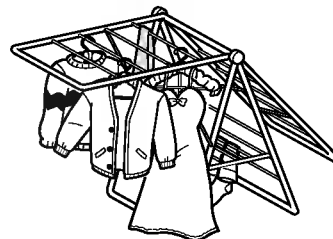

- Weak wrinkles after drying can be smoothed out by ironing.



CAUTION

- When setting the water level manually, do not select MEDIUM or SMALL water levels. Laundry may get damaged.
- Only cold water is set(Hot water may damage laundry).
- It is recommended the use of liquid detergents for woolens or home dry cleaning that are low sudsing and dissolve readily or in case of powdered detergent it should be dissolved in water before being put for best washing results.
- Wash less than 2.0kg of laundry at a time. For Wool, wash less than 1.0kg of laundry at a time.
- Do not wash altogether with white clothes, bright-colored clothes or dark-colored clothes which can be easily discolored.
- Since spin is 'weak' for Wool program, water may drop even after spinning.

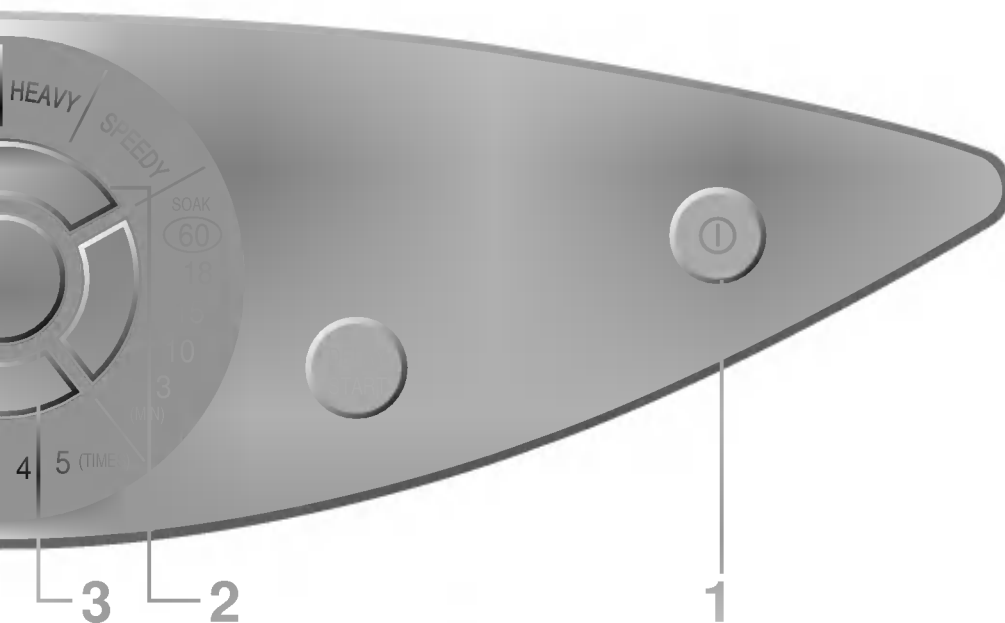

1 Press the [POWER SWITCH] button.

2 Select [WOOL] program.
• Water level is automatically set [MEDIUM].

3 Deposit laundry and press the [START/PAUSE] button.
• For laundry with fragile buttons, etc., turn them inside out.

4 Deposit detergent and close the lid.



• If the lid is not closed, the machine cannot start washing and it displays "dE" with alarm sound.

This can be used conveniently for the every washing type.(except for WOOL program.)
When you want to cancel delay start for delayed washing, switch the power off and start again.

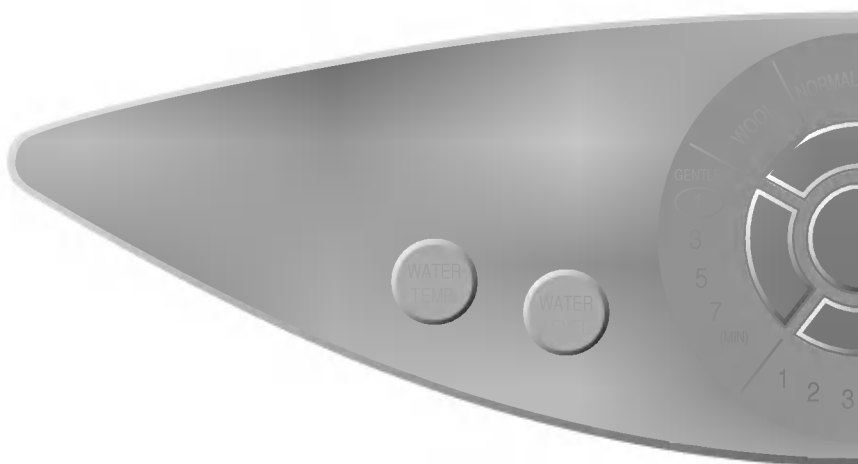

How to set the Delay Time

Example : It's 7 a.m. now. If you'd like your wash to finish at 9 p.m. set the time as in the figure below.

- When you push the button the delay time changes [3 → 4 → 5... → 12 → 14 → 16... → 48 → 3] repeatedly.

HOUR MIN
DELAY / TIME LEFT



14 hours : 7 a.m. ~ 9 p.m.

How to put the detergent into the detergent box

For powder detergent

- Put the detergent into the exclusive detergent box. Pull the box and put the detergent then close the box again.

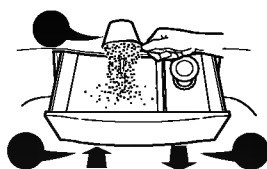

- Dry the moisture in and out of the box before inserting the detergent (the detergent can become hard).

For liquid detergent

- Put the detergent after diluting it with the water at the rate of 1:1.



CAUTION

- Make sure to deposit detergent in the powder detergent box. If you leave detergent with the laundry for a long time, the laundry may get partially discolored.
- When the lid is opened, delayed washing cannot proceed.
- In case of power failure, set again from the beginning.
- According to water supply conditions, washing may be unable to be completed by the preset time.
- Remove any water from the powder detergent box before depositing detergent. Moisture may harden the detergent.
- After setting delay time, you can change the program, wash time, number of rinses, spin time, water temperature and water level.

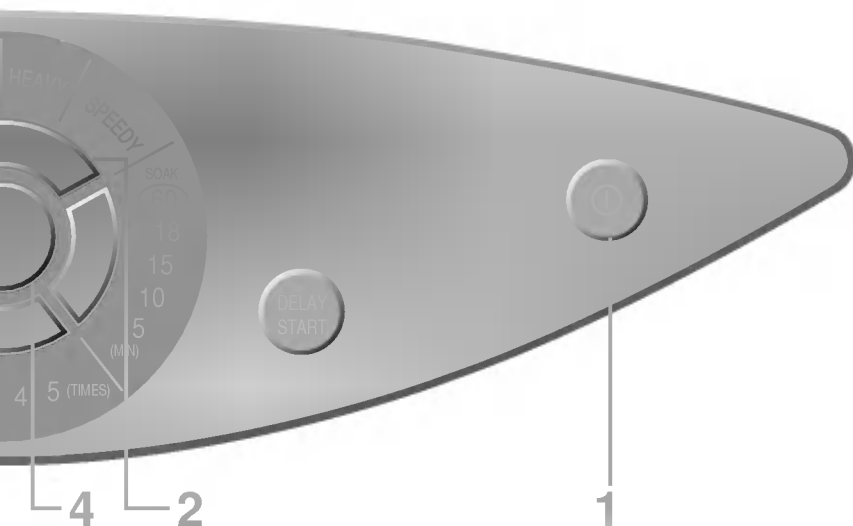

1 Press the [POWER SWITCH] button.

2 Select a program.
● Select program except for [WOOL] program.

3 Set the Time.
● Press the DELAY START button to set the time when the delayed washing is completed.

4 Deposit laundry and press the [START/PAUSE] button.

5 Deposit detergent in the powder detergent box and must close the lid.
● Pull the powder detergent box forward and deposit proper amount of detergent displayed or according to instruction of detergent manufacturer. Then, push back the box.



● If the lid is not closed, the machine cannot start washing and it displays "dE" with alarm sound.



How to wash when you go out

● When you cannot take the laundry out immediately after washing is completed, you'd better select wash and rinse only (in this case, do not select spin to prevent wrinkle).

Use this program for washing heavily soiled laundry after soaking.

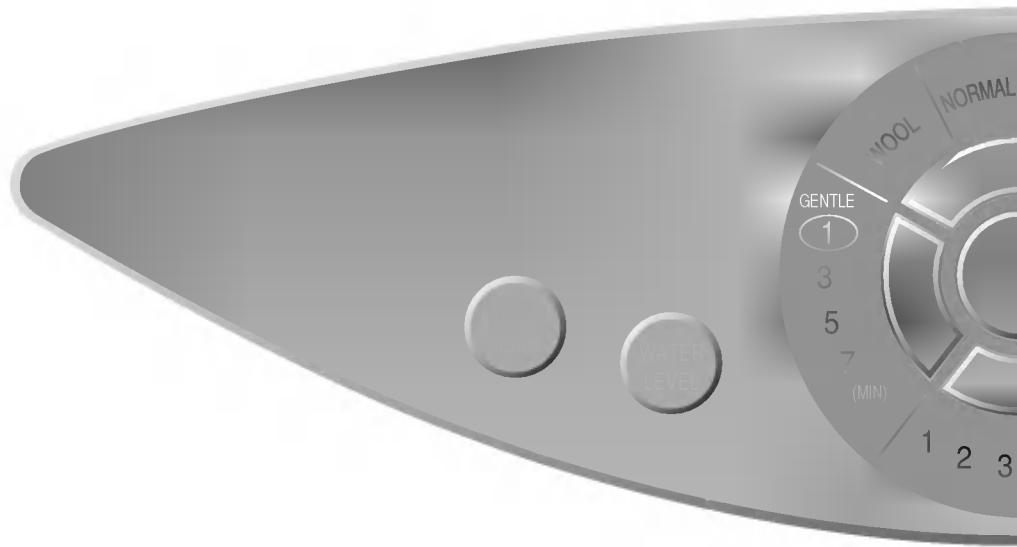

CAUTION

- If either the inner-tub contains water or the laundry is wet, water level may be different from the initial set level.(It is not malfunction. It is the proper water setting for laundry.)
- Bulky and light laundry may cause a water level lower than usual. In this case, manually adjust the water level.
- For laundry that may easily be discolored, do not use [SOAK] washing.

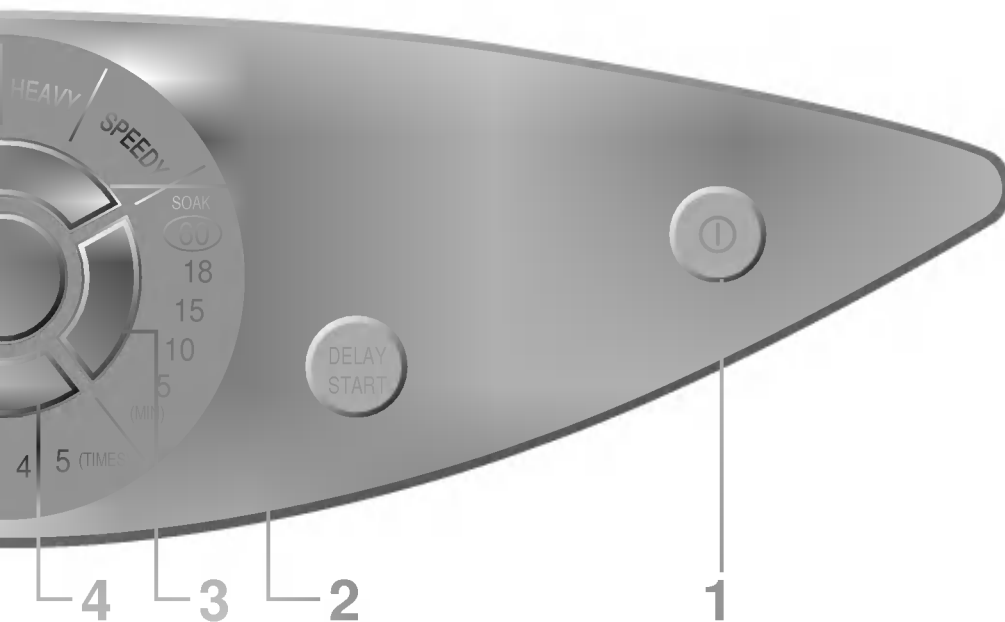

1 Press the [POWER SWITCH] button.

2 Select a program.
 • Wool washing is not available for soaking washing.

3 Press the [WASH] button until soak and wash blink.
 • Soak washing time order

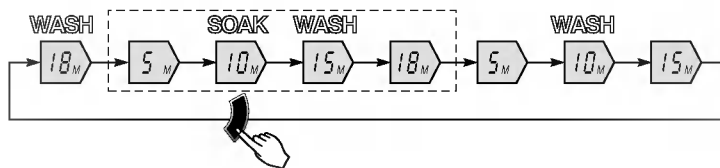

• Select rinse times and spin time.



4 Deposit laundry and press [START/PAUSE] button.

5 Deposit detergent as indicated on the display or according to instruction of detergent manufacturer and close the lid.

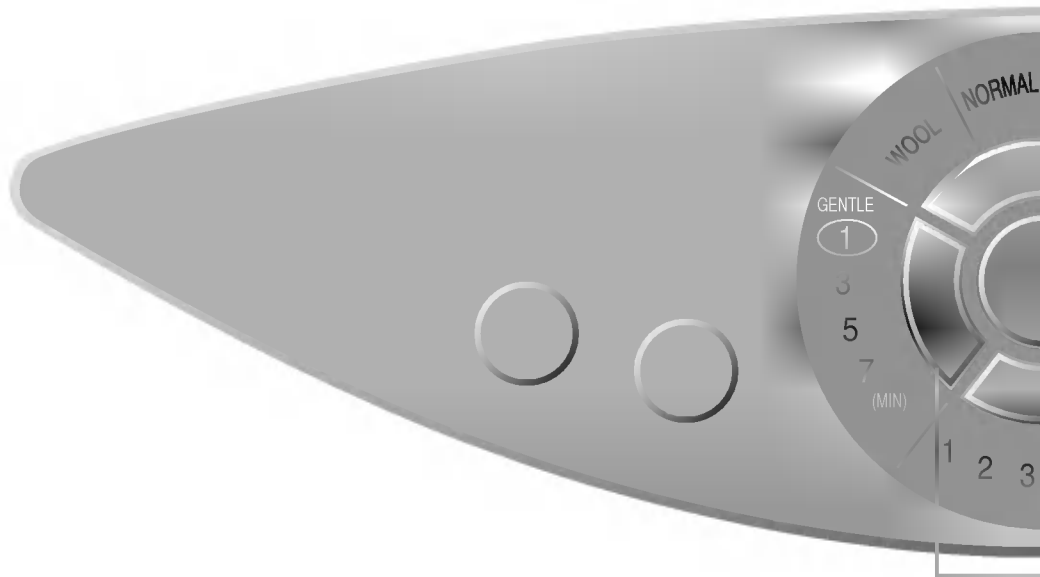

• If the lid is not closed, the machine cannot start washing and it displays "dE" with alarm sound.



1	<p>WASH Only</p> 	<p>RINSE & SPIN Only</p> 	<p>DRAIN Only</p> 
	<ul style="list-style-type: none"> • Push the wash button to select wash time. • In this case selected wash time is lit up. • Adjust water level for laundry. Preset water level is "Large" 	<ul style="list-style-type: none"> • Push the rinse & the spin button to select rinse times & spin time respectively. • In this case selected rinse time & spin time are lit up. • Adjust water level for laundry amount. Preset water level is "Large" 	<ul style="list-style-type: none"> • Push the spin button.

2 Put detergent & close the lid.

3 Push the start/pause button.

- When washing finishes buzzer sound for 10 secs and then electric power is automatically off.

2 Push the power switch to turn off after drain finishes.

- Buzzert sounds when drain fininshs in the state that the lid is open.

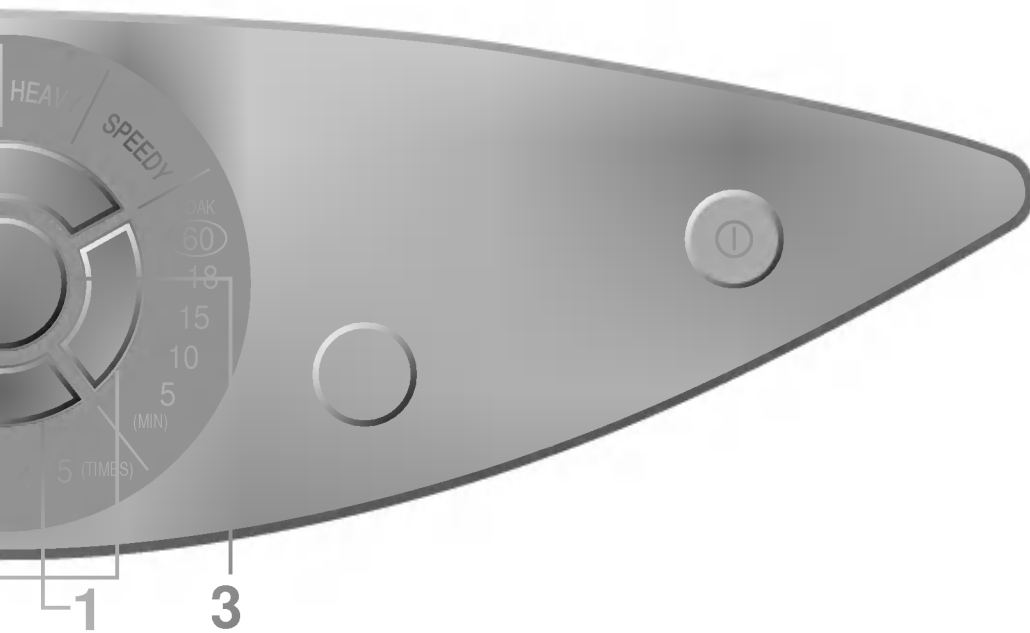

1	Wash & Rinse Only	Rinse Only	Spin Only	Wash & Spin Only
	<ul style="list-style-type: none"> • Press the WASH button to select the time. • Press the RINSE button to select the number of rinses. • Adjust the water level according to the amount of laundry. • If the water level is not selected, it is automatically set to [LARGE]. 	<ul style="list-style-type: none"> • Press the RINSE button to select the number of rinses. • Adjust the water level according to the amount of laundry. • If the water level is not selected, it is automatically set to [LARGE]. 	<ul style="list-style-type: none"> • Press the SPIN button to select the time. 	<ul style="list-style-type: none"> • Press the WASH and SPIN button to select wash and spin time. • Adjust water level for laundry. • Put laundry and detergent.

2 Close the lid

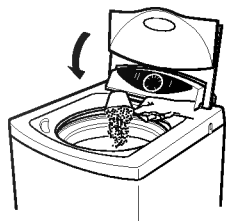















- If the lid is not completely closed, the washer generates the alarm sound.

3 Press the [START/ PAUSE] button



- Electric power turns off automatically 10 seconds after the alarm sounds, when washing completely finishes.

WATER LEVEL	AMOUNT OF WATER	AMOUNT OF LAUNDRY	AMOUNT OF DETERGENT	
			REGULAR	CONCENTRATED
EX 	91 l	More than 8.0kg	 About 91g	About 61g
• 	76 l	Less than 6.5kg	 About 76g	About 51g
L 	67 l	Less than 5.0kg	 About 67g	About 45g
• 	57 l	Less than 4.0kg	 About 57g	About 38g
M 	53 l	Less than 3.0kg	 About 53g	About 35g
• 	46 l	Less than 2.0kg	 About 46g	About 31g
S 	34 l	Less than 1.0kg	 About 34g	About 23g

- Concentrated detergent: 20g per 30 liters of water.
- Regular synthetic detergent: 30g per 30 liters of water.
- When sensing water levels automatically, the amount of water can differ according to the amount of laundry even at the same water level.
- For synthetic detergent, use one that generates less bubbles. This type of detergent is specially designed for washes.
- In case of using liquid detergent, dissolve it with water(detergent: water=1:1) and deposit it through the bleach deposit hole.
- For detail usage, refer to the detergent manufacturer's instruction.



CAUTION

- If you use laundry soap(neutral resin) for a long time, dirt separated from laundry may remain on the inner-tub wall and cling to laundry during washing.
- Using excessive amount of detergent may reduce the rinse effect and pollute the environment.

How to use the bleach agent

- In the case of using the bleach, it is necessary to use the oxygenated bleach.
- Put the powdered bleaching agent after separating the clothes only for bleaching.
- Put the liquid bleaching agent with into the washing cask.
- For detail usage, refer to the bleach agent manufacturer's instruction.

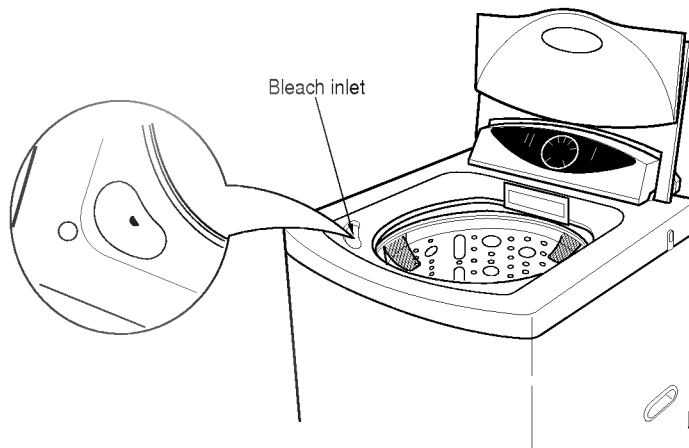

How to use the softener agent

- Pull and open the detergent box in the direction of arrow as indicated at picture.
- Put the enough agent under the standard line as indicated at the picture.
- Put the box slowly and smoothly not to make the agent flow over.
- For detail usage, refer to the softener agent manufacturer's instruction.

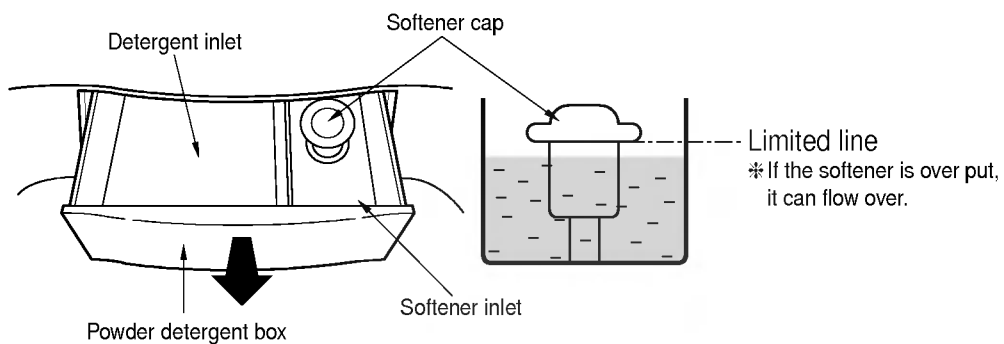

CAUTION

- The softener is to be inserted automatically at the last time of rinse.
- Insert the softener yourself at the last time of rinse since softener can be failed to be inserted automatically when the water pressure is weak (less than 0.5kgf/cm²).
- Do not leave the washing machine with the softener in it more than 2 days. (It could fail to insert softener by itself when left with softener because of the solidating of softener.)
- Do not put the bleach and softener directly to the clothes. (The clothes can be damaged of discolored.)

In addition to full-automatic washing, the user can select other functions as desired. When the washer is in operation, pause the washer before making changes.

Water supply selection

- By pressing the button, it cycles **COLD** → **WARM(COL & HOT)** → **HOT** → **COLD**.
- Even when only **HOT** or **WARM** is selected, water is supplied **COLD** only during the **RINSE** cycle.
- Only cold water is set in the **WOOL** washing.

Water LEVEL selection

- Water level is set automatically after sensing the amount of laundry is high or low, press the **WATER LEVEL** button to change the water level.

Wash selection

SOAK 8 ↑ ↓ 5	18 min.	Heavily stained clothes, thick clothes
	10 - 15 min.	Normal clothes, cotton, yam, synthetic fabric, normally-stained clothes, thin clothes
	5 min.	Soft clothes, delicate clothes, lightly-stained clothes

* Actual wash time may differ according to water level.

* For **WOOL** program, washing wings revolve very slowly(to prevent shrinkage and damage).

Rinse selection

Rinse 4, 5	Heavily stained clothes
Rinse 2, 3	Normal clothes, cotton, yam, synthetic fabric, normally-stained clothes, thin clothes
Rinse 1	Lightly-stained clothes

Spin selection

7min.	Thick clothes
5min.	Normal clothes, light clothes, thin clothes
3min.	Soft clothes
1min. at low revolution speed	Clothes to be ironed, delicate clothes

* For **WOOL** program, the tub turns very slowly and spins for a very short time (to prevent damage to clothes).

To guard against unwanted alteration of cycle settings during operation the child lock may be utilised.

HOW TO LOCK

- 1** Press the **POWER** button
- 2** Press the **START/PAUSE** key after all washing conditions are set according to the manual.
- 3** Press both the **WATER TEMP.** key and the **WATER LEVEL** key simultaneously while wash is proceeding, then all the keys are locked until completing the wash program or unlocking them.

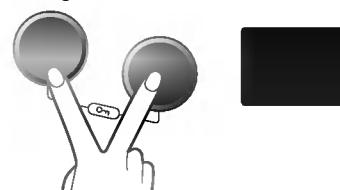

- "L" & the remaining time are alternatively shown on the display while they are locked.

HOW TO UNLOCK

If you want to unlock during wash press both the water temp key and the water level key simultaneously again

When the water supply is bad, check substances like stone or sand in the filter.
If the filter is clogged with dirt, water cannot flow into the washer. Clean the filter regularly.

Cleaning the filter in the inlet valve

Before cleaning the filter in the inlet valve, completely remove the water remaining in the water hose.

- 1**

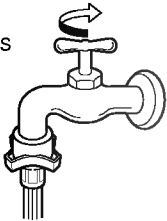
 - Turn off the faucet and press the power switch.
 - Select cold & hot water and press START/PAUSE button. Let the washer operate for 5 seconds.
- 2**

Switch off the washer and disconnect the power cord.

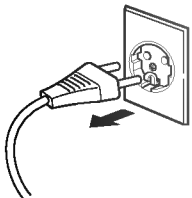
- 3**

Disconnect water hose, and remove filter from the inlet valve by hand or with tools. Remove dirt with a tooth brush, etc.

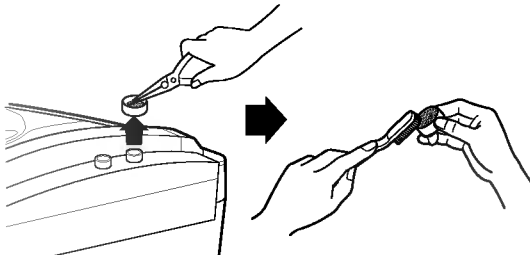
 - Then insert it back into the water inlet.

Cleaning the lint filter

- 1**

Press and then pull forward the lint filter from the washing tub to the arrow direction.

- 2**

Turn inside out and wash it to remove dirt.

- 3**

Insert it back into place ("Click").



• When the lint filter is worn out, etc., contact a LG Service Center for new one.

Cleaning the pump casing (when drainage is bad)

- 1**

Unfasten 2 screws of the back cover.

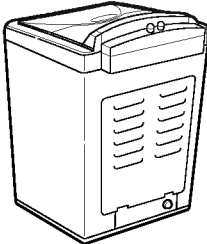

- 2**

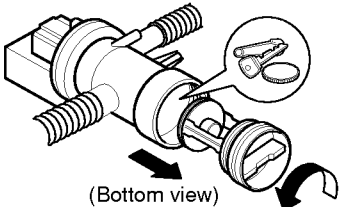
turn the cap to the arrow direction and unfasten it.

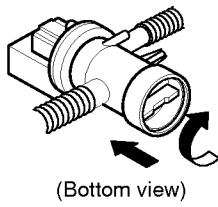

(Bottom view)
- 3**

Reassemble the cap to the arrow direction and fasten it.



(Bottom view)

• CAUTION : Check it over if water leaks after reassembling.(Rubber ring is in the cap)

To prevent freeze in winter

1 Close faucet and remove the water hose. Direct the hose toward the bottom and completely remove water from the hose.

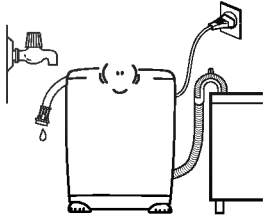

2 Press the SPIN button and let it spin for 1 min. to remove water from the tub and drain hose.

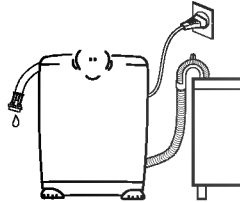

3 Unplug the power cord.

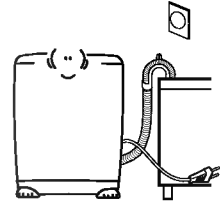

When frozen

1 Pour 50°C of hot water on the faucet and remove the water hose.

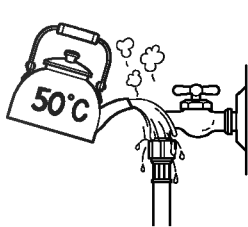

2 Pour 50°C of hot water inside the tub and leave it for 10 min.

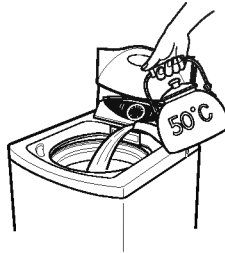

3 Submerge the separated hose in 50°C of hot water

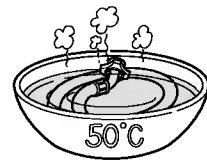

4 Connect the water hose to the washer and then start the washer. Pour 50°C of hot water into the water hose.

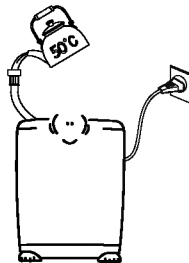

5 Connect the water hose to the faucet and check if water is draining.

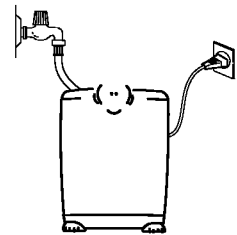

CAUTION

• **Stainless steel inner tub won't be rusted.**







However, external rust may cling to it in the following causes:



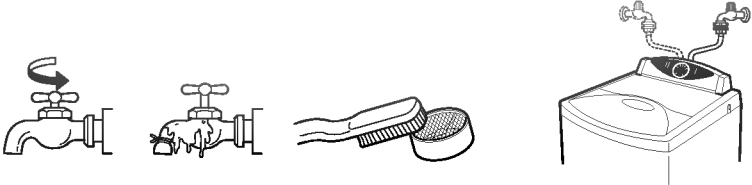

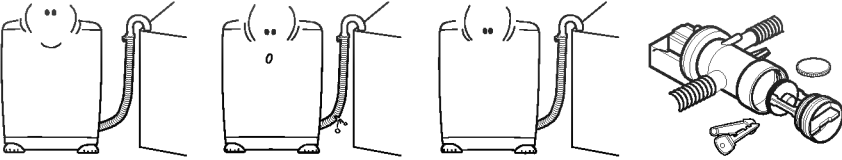

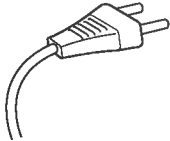

- Metal product (like hairpin, etc.) that can be rusted is left inside the tub for a long time.
- Water with a lot of iron substance is used for a long time.
- Water or chlorine type bleach is left inside the tub for a long time.

• **If rust is found, soak sponge or soft cloth with cleaner (neutral cleaner) and wipe the rust. (Never use metal sponge)**

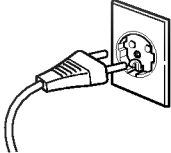
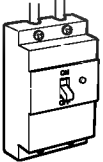

- If an abnormal symbol appears in the display window, check the following before asking for service.
- Request for the service center or agent in the case of failure or damage except for the following.

<p>Abnormal faucet</p> 	 <p>Is the faucet closed? Is the faucet frozen? Is water supply discontinued? Is the water pressure lowered or the filter clogged? Is hot water selected when only a cold water hose is connected to the cold valve?(In this case, select cold water.)</p>
<p>Abnormal drainage</p> 	 <p>Check if electric power has gone off. Check that the drain hose is not twisted or kinked? Is the drain hose hung properly? Check whether the drain pump is locked by foreign objects.</p>
<p>Abnormal spin</p> 	 <p>Is the laundry gathered to one side? Is the washer tilted?</p>
<p>Opened lid</p>  <p>(At this time, buzzer sounds without lamp indication)</p>	 <p>Is the lid closed? If the lid is open, alarm is generated and rinse and spin cannot be proceeded. Is the lid closed after setting delayed washing? If the lid is opened, delayed washing cannot be proceeded.</p>

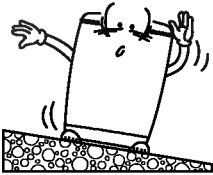
<p>Abnormal sensor</p> <p>PE</p>	<p>Ask for service center</p>		
<p>Abnormal power</p> <p>AE</p>			
<p>Abnormal overflow</p> <p>OF</p>			
<p>Abnormal Ball sensor</p> <p>bE</p>			
<p>No power</p> 	<p>AUTO OFF</p>  <p>Is the power switch pressed?</p>	 <p>Is the power plug firmly connected?</p>	 <p>Is power supply correct? Is the short-circuit breaker closed?</p>
<p>No operation</p> 	 <p>Is the lid closed and the START/PAUSE button is pressed?</p>	 <p>Is the tub filled with required amount of water?</p>	 <p>Is the faucet closed?</p>
<p>Excessive vibration and noise during spin</p> 	 <p>Is the washer installed on firm and level surface?</p>		
<p>Water supply and rinse after pausing it during spinning.</p>	<ul style="list-style-type: none"> ● It is normal, the washer is automatically correcting the laundry gathered to one side. ● No special action is needed. 		



- ❑ Water pressure : 30-800kPa (0.3kgf/cm² - 8kgf/cm²)
- ❑ Revolution speed of the wings : 110~130rpm
- ❑ Weight : 47kg
- ❑ Dimension : 632mm(W) × 688mm(D) × 1029mm(H)
- ❑ Standard amount of water : 91 ℓ
- ❑ Standard amount of water used : 260 ℓ

* The appearance and specifications may be varied without notice to raise the units quality.