



***Video CD Player/
Hi-Fi Stereo Karaoke
Video Cassette Player***

Owner's Manual



VC700M

WARNING

To prevent fire or shock hazard, do not expose the unit to rain or moisture.

To avoid electrical shock, do not open the cabinet. Refer servicing to qualified personnel only.

Laser component in this product is capable of emitting radiation exceeding the limit for Class 1.

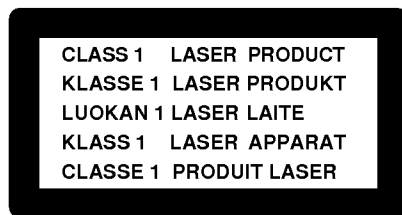

This appliance is classified as a CLASS 1 LASER product.

Caution

Television programs, films, video tapes, and other materials may be copyrighted.

Unauthorized recording of such material may be contrary to the provisions of the copyright laws.

Compatible colour systems

This player is designed to record and play back using the NTSC colour systems.

The apparatus shall not be exposed to dripping or splashing and that no objects filled with liquids, such as vases, shall be placed on the apparatus.

Welcome!

Thank you for purchasing the LG Video CD Player / Video Cassette Player. Before operating the unit, please read this manual thoroughly and retain it for future reference.

Table of contents

Getting Started

- 4 Step 1 : Setting up the remote control handset
- 5 Step 2 : Connecting

Getting Started

Basic Operations - VCD/VCP parts

- 6 Changing menu options

Basic Operations - VCP part

- 7 Playing a tape

Basic Operations - VCD part

- 10 The VCD part of this player can play the various discs
- 11 Using the menu
- 12 Playing a VIDEO CD/Audio CD/MP3 CD
- 14 Playback with MP3

Basic Operations - Karaoke function

- 16 Before you start karaoke
- 17 Karaoke sing-along
- 18 Grading your singing

Enjoying Recording a Tape

- 19 Recording TV programs
- 21 Editing with another VCR
- 23 Recording from a CD to a tape

Enjoying Playback of a VIDEO CD/Audio CD

- 24 Resuming playback from the point you stopped a VIDEO CD & AUDIO CD (Resume Play)
- 25 Playing repeatedly
- 26 Creating your own program (Program Play)
- 27 Playing in random order
- 28 Playing a VIDEO CD with PBC functions (PBC Playback)

Additional Information

- 30 Precautions
- 31 Troubleshooting
- 33 Specifications

Step 1

Setting up the remote control handset

Inserting the batteries

Insert two R03 (size AAA) batteries by matching the + and - on the batteries to the diagram inside the battery compartment.

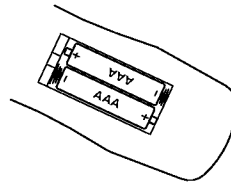

Using the remote control

This player is designed so that almost all of its features can be controlled from the remote control.

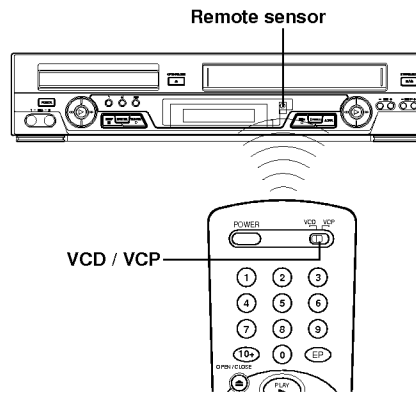

To operate	Set VCD/VCP to
VCD	VCD and control VCD part
VCP	VCP and control VCP part

Notes

- If you do not use the remote control handset for an extended period of time, remove the batteries to avoid possible damage from battery leakage.
- Do not use a new battery with an old one.
- Do not use different types of batteries.

Connecting

Basic connection

Connect AUDIO/VIDEO OUT of this unit and the AUDIO/VIDEO IN of your TV using the supplied audio/video cable.

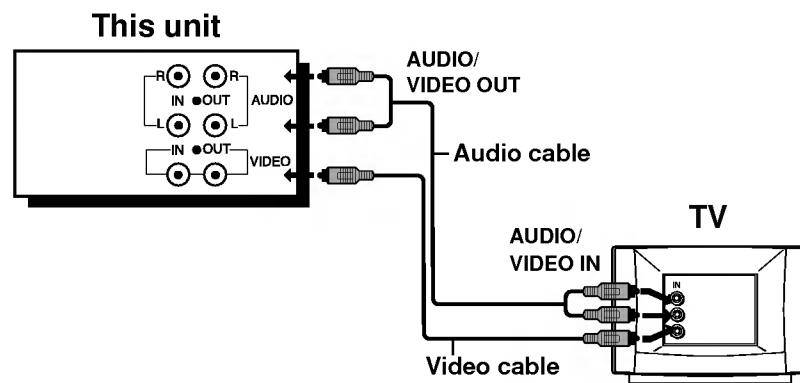

Other connection

When you enjoy a VCD and an audio CD, you can improve sound quality by connecting a stereo system as shown on the below.

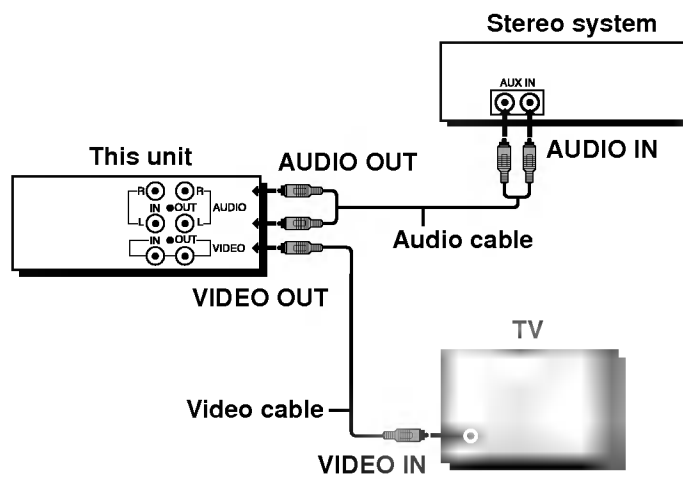

Changing menu options

Before you start...

- Turn on this player and the TV.
- Set the TV to the AV.
- Set VCD/VCP switch to the VCP.
- Set AV/CD SEL. to the VCP MODE.

1 Press MENU.

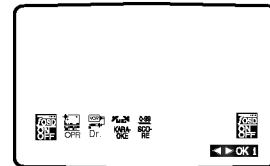

2 Press CURSOR ◀▶ to select the option to change, then press **OK** to change the setting and press CURSOR ◀▶ to select the sub menu.

3 Press **i** to remove the menu screen.

Menu choices

Menu option	Set this option to
fOSD ON/OFF (for VCD/VCP)	<ul style="list-style-type: none"> • ON to display the operating status of this player. • OFF to switch off OSD display.
OPR (for VCP)	<ul style="list-style-type: none"> • SOFT to make picture sharpness softer. • SHARP to make picture sharpness clearer. • OFF to switch off OPR. <p>Please note you may set OPR to on only when playing a tape.</p>
Dr. (for VCP)	<p>To check a problem with VCP part</p> <ul style="list-style-type: none"> • HEAD STATUS <ul style="list-style-type: none"> - OK - PLEASE CLEAN : Clean your video heads. • TAPE STATUS <ul style="list-style-type: none"> - RECORDABLE - NOT RECORDABLE : Insert a tape with its protection tab in place.
KARAOKE (for VCD/VCP)	<ul style="list-style-type: none"> • ON to switch on Karaoke & Karaoke Search. • OFF to switch off Karaoke & Karaoke Search.
SCORE (for VCD/VCP)	<ul style="list-style-type: none"> • ON to display the score your song when you Karaoke. • OFF to switch off score.

Playing a tape

When a tape is inserted and playback starts, the automatic tracking function works to get the best possible picture automatically.

“**AUTO TRACKING**” will appear on the TV screen while it is doing this. If the quality of the recording is poor, repeatedly press **TRK** (- or +) on the remote control to manually adjust the tracking until any distortions have been removed.

You can use auto tracking function also by pressing A.TRK on the front panel.

- Set VCD/VCP switch to the VCP.

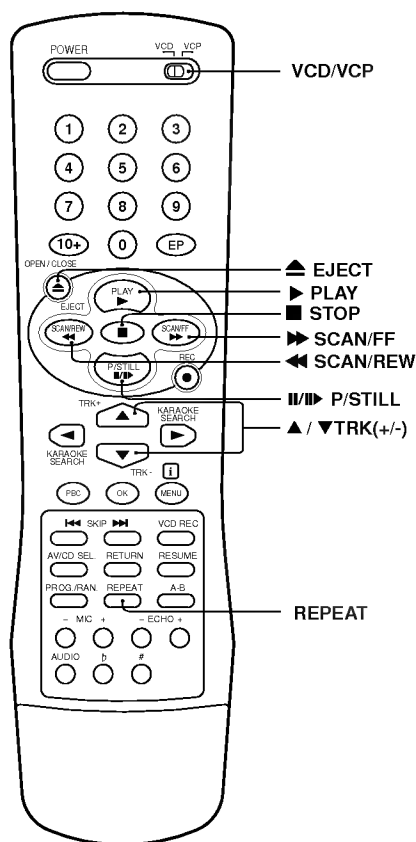

1 Turn on your TV and set it to AV.

2 Insert a tape.

This player turns on and starts playing automatically if you insert a tape with its safety tab removed.

3 Press ►PLAY.

When the tape reaches the end, it will rewind automatically.

continued

Playing a tape (continued)

Playing repeatedly

To play a tape repeatedly

Press **REPEAT**. "REPEAT (AUTO REPEAT)" appears in the display window and the TV screen. When the end of the tape is reached, this player automatically rewinds the tape to the beginning and repeats playback continuously.

To cancel Repeat Play

Press **REPEAT** repeatedly until "REPEAT (AUTO REPEAT)" disappears from the display window and the TV screen.

Additional tasks

To	Press
Stop play	■ STOP
Pause play	⏸ P/STILL
Frame advance	⏸ P/STILL during pause play. By repeatedly pressing ⏸ P/STILL the picture advances one frame at a time.
Slow motion	Hold ⏸ P/STILL down during pause play
Resume play after pause	▶ PLAY
Search forward	▶▶ SCAN/FF during playback
Search backward	◀◀ SCAN/REW during playback
Fast-forward the tape	▶▶ SCAN/FF during stop
Rewind the tape	◀◀ SCAN/REW during stop
Eject the tape	⏏ EJECT

To display the information for three seconds (Auto Display)

Displayed information disappears in three seconds automatically.

Press **MENU** and select fOSD ON/OFF, then set it to ON.

Using the on-screen display

You can check the operating status of the player and the information about the tape on the TV screen.

Press OK.

Each time you press OK, the on-screen display changes as follows;

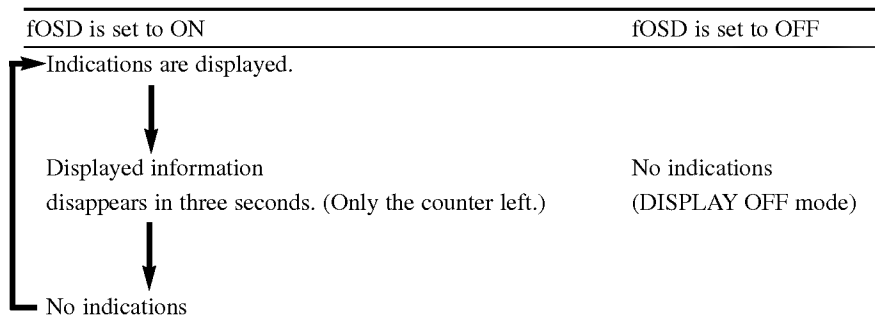



To change the channel for audio output.

You can select among MONO, STEREO (Hi-Fi), L (LEFT) and R (RIGHT) by pressing **AUDIO**.

Note

- On-screen display will not display when the microphone has been plugged in.

The VCD part of this player can play the various discs

	VIDEO CDs	AUDIO CDs	MP3 CDs
Disc logo			
Contents	Audio + Video (moving pictures)	Audio	Audio
Disc size	12 cm/8 cm	12 cm/8 cm (CD single)	
Play time	74 min./ 20 min.	74 min./ 20 min.	

To play a VIDEO CD/AUDIO CD/MP3 CD

See page 12.

To enjoy PBC Playback of a VIDEO CD with PBC functions

See page 28.

Note on VIDEO CDs

This player conforms to Ver. 1.1 and Ver. 2.0 of VIDEO CD standards. You can enjoy two kinds of playback according to the disc type.

Disc type	You can
VIDEO CDs without PBC functions (Ver. 1.1)	Enjoy video playback (moving pictures) as well as music.
VIDEO CDs with PBC functions (Ver. 2.0)	Play interactive software using menu screens displayed on the TV screen (PBC Playback), in addition to the video playback functions of Ver 1.1 discs. Moreover, you can play high-resolution still pictures.

Notes

- DVD, SVCD, and CD-RW discs cannot be played on this player.
- “” may appear on the TV screen during operation.
This icon means the function explained in this owner’s manual is not available on that specific items.

Using the menu

- Set VCD/VCP switch to the VCD.
- Set AV/CD SEL. to the VCD MODE.

1 Press **MENU**.

2 Press the number buttons to select the desired item.

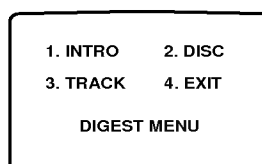

Menu option

1 INTRO (INTRO SCAN)

The first portion of each track will be played for about 10 seconds.

- To go manually to the next or preceding track, press **SKIP ►►** or **◄◄ SKIP**.
- To play a scanning track, press **► PLAY**.

2 DISC (DISC VIEW)

A picture is divided into the number of tracks on the disc and each track will be played sequentially.

- If there are more than 10 tracks on the disc, press **SKIP ►►** to make the next page. (To go back to preceding page, press **◄◄ SKIP**.)
- If you press **► PLAY** during performing the DISC VIEWING, the moving picture in the nine area will be played in full screen.
- You can select directly a desired area number with the number button.

3 TRACK (TRACK SCAN)

A track is divided into nine area and each division will be played sequentially.

- To go to the next or preceding track, press **SKIP ►►** or **◄◄ SKIP**.
- If you press **► PLAY** during performing the track scanning, the moving picture in the nine area will be played in full screen.
- You can select directly a desired area number with the number button.

4 EXIT

Remove the menu screen.

3 Press **MENU** to return to the DIGEST MENU during performing the selected item.

Notes

- Disc view and Track scan are not available to Audio CD.
- If you press **MENU** while playing a VIDEO CD with PBC ON, PBC is switched to OFF and the menu screen appears.

Playing a VIDEO CD/Audio CD/MP3 CD

- Set VCD/VCP switch to the VCD.

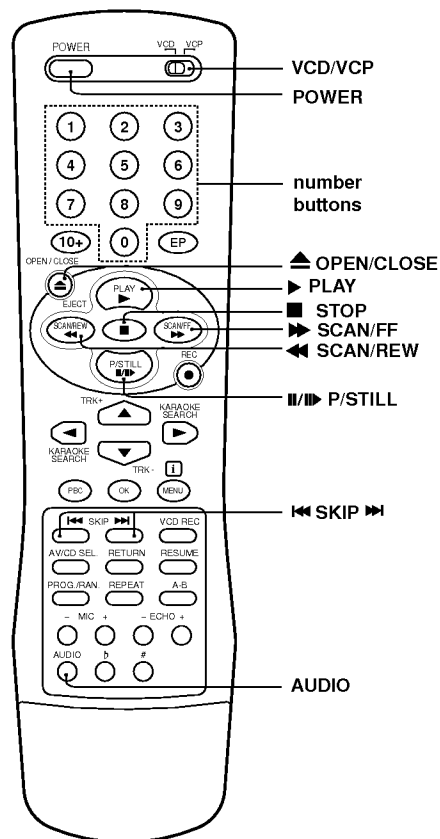

- Turn on your TV and set it to the AV.
When using an amplifier, turn on the amplifier and select this player position.
- Press **POWER** to turn on the player.
- Press **▲ OPEN/CLOSE**, and place the disc on the disc tray.

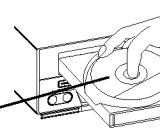

with the label side up
- Press **▶PLAY**.
The disc tray closes and the player plays all the tracks once (Continuous Play).

Playback with MP3

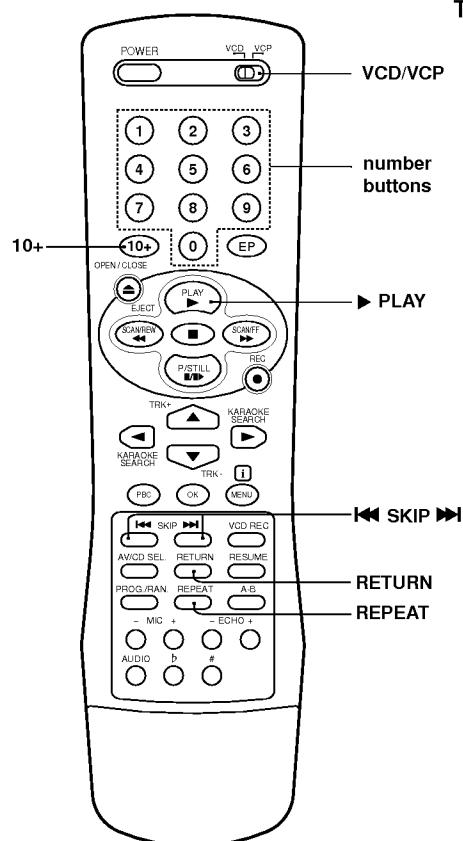

To play an MP3 file

- 1 Load an MP3 disc.
The MP3 menu is displayed.

MP3	MENU
	PAGE 01/02
→ MP3-1	MP3-2
MP3-3	MP3-4
MP3-5	MP3-6
MP3-7	MP3-8
MP3-9	MP3-10
MP3-11	MP3-12

- 2 Press **SKIP** or **SKIP** to select the directory where MP3 files that you want to play are located and then press **PLAY**.

If there are more than 13 directories on the disc, press **SCAN/FF** or **SCAN/REW** to make the next page.

MP3	DIR	MP3-1
		PAGE 01/02
→ TRACK 1	TRACK 2	
TRACK 3	TRACK 4	
TRACK 5	TRACK 6	
TRACK 7	TRACK 8	
TRACK 9	TRACK 10	
TRACK 11	TRACK 12	

- 3 Press **SKIP** or **SKIP** to select the desired MP3 file of the selected directory on your disc.
- 4 Press **PLAY** to start playback of a file.

To play an MP3 file repeatedly

- If you press **REPEAT** once during play, the current MP3 file will play repeatedly.
- If you press **REPEAT** twice during play, all directories will play repeatedly.
- If you press **REPEAT** three times, the repeat play will be cancelled.

For your reference

- Press **SKIP** / **SKIP** to play the next file or previous file during playback.
- You may also directly select the desired track using the numbered buttons on the remote control.
- If there are more than 10 tracks on the selected directory, press **10+** first, then the corresponding number buttons.
- Press **RETURN** to move to the Root Directory during playback.

Note

- The directory and file name is only to display with English.

Playback with MP3

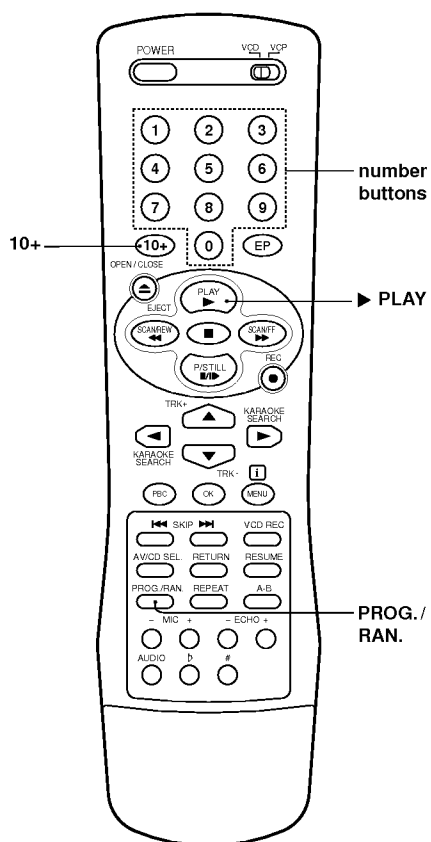

To program play an MP3 file

- 1** Follow steps 1 to 2 on previous page.
- 2** Press **PROG./RAN.**.
"PROGRAM" appears in the display window.
Press the number buttons of the tracks you want to program in order you want.
 - To program a track numbered over 10, use the **10+** button first, then the corresponding number buttons.
- 3** Press **▶PLAY** to start program play.

MP3	DIR	MP3-1
		PAGE 01/02
→ TRACK 1		TRACK 2
TRACK 3		TRACK 4
TRACK 5		TRACK 6
TRACK 7		TRACK 8
TRACK 9		TRACK 10
TRACK 11		TRACK 12

After playback all tracks programmed

Play is stopped.

To cancel program play

Press **PROG./RAN.** repeatedly until "PROGRAM" disappears from the display window.

(PROGRAM → RANDOM → CONTINUE)

To random play an MP3 file

- 1** Press **PROG./RAN.**.
"RANDOM" appears in the display window.
The player starts Random Play.
If you press **◀SKIP** or **SKIP▶** during random playback, this player goes to another track randomly and starts playback.
- 2** **To cancel Random Play.**
Press **PROG./RAN.**.
"RANDOM" disappears in the display window.

Before you start karaoke

You can sing along with a karaoke source (video tape, VCD, audio CD).
You can sing duets if you use an extra microphone.

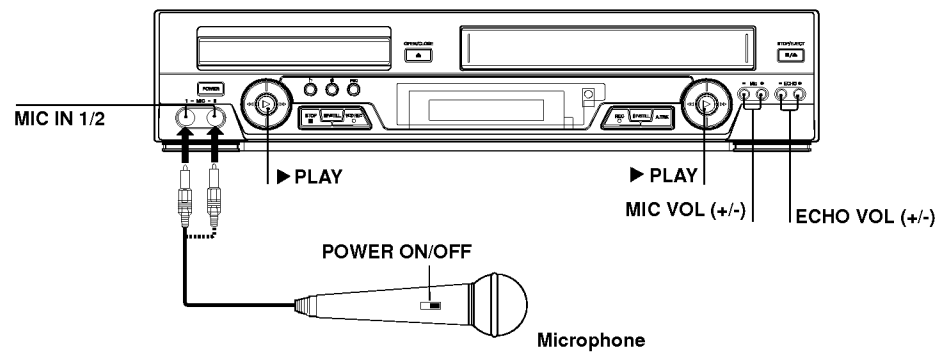

- 1** Turn on your TV and set it to the AV.
When using an amplifier, turn on the amplifier and select this player position.
- 2** Connect a microphone to the MIC 1 jack. To sing duets, connect another microphone to MIC 2 jack.

Karaoke sing-along

Singing along with karaoke video tapes

- Set VCD/VCP switch to VCP.

- 1** Insert a karaoke video tape.
The player turns on and starts playing automatically if you insert a tape with its safety tab removed.
- 2** Press ►PLAY.
If you want to play back a specific song, perform the Karaoke search.
 - Karaoke search will be operated only when a microphone has been plugged in.**Karaoke search**
Press **KARAOKE SEARCH** (◀ or ▶) on the remote control.
Press **KARAOKE SEARCH** (◀ or ▶) again to play a desired song.
- 3** Now you can enjoy playing karaoke.

Singing along with karaoke VIDEO CD

- Set VCD/VCP switch to VCD.

- 1** Press ▲OPEN/CLOSE, and place the disc on the disc tray.
- 2** Press ►PLAY.
The disc tray closes and starts. If you want to play back a specific song, see “Using the menu” on page 11.
- 3** Now you can enjoy playing karaoke.

To adjust the microphone volume

Press the **MIC VOL (-/+)** for the microphone connected to MIC 1/2.
Setting the **MIC VOL (-/+)** to the center position provides the best microphone volume.

To control the echo effect

Press the **ECHO (-/+)**. This controls both microphones' echo effect in the same way.
To get the best effect, adjust the microphone volume to a level slightly higher than the music volume.

continued

Grading your singing

As an extra challenge, this player can grade your singing.

When you have finished singing, your score appears on the TV screen.

Changing the pitch (Key Control)

While you are singing, you can change the pitch of the song to match your vocal range.

- Key control is controlled only while playing a CD source.

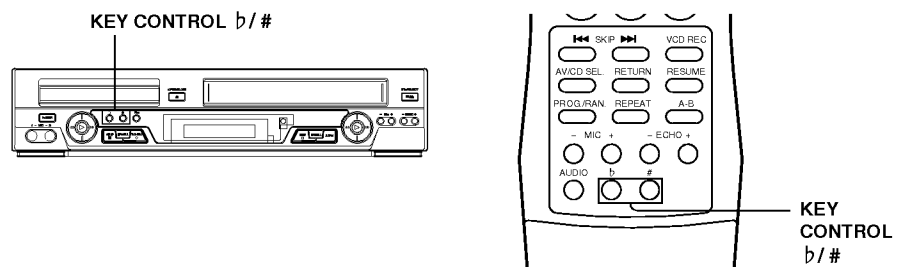

Press **KEY CONTROL** **b** or **#** repeatedly to set the pitch you want.

(# (sharp) : Raise the pitch, b (flat) : Lower the pitch)

To return to the original pitch press **KEY CONTROL** **b** or **#** until “**h**” appears in the display window.

Notes

- If the sound is reproduced through a stereo amplifier, turn down the volume of amplifier before operation.
- If feedback occurs, turn down the microphone or TV volume, or move the microphone away from the speakers.

Recording TV programs

When your TV is equipped with audio/video output jacks, you can record a program showing on the TV.

Before you start

- Set VCD/VCP switch to the VCP.
- Connect the AUDIO/VIDEO IN jacks of the player to the audio/video output jacks of your TV.

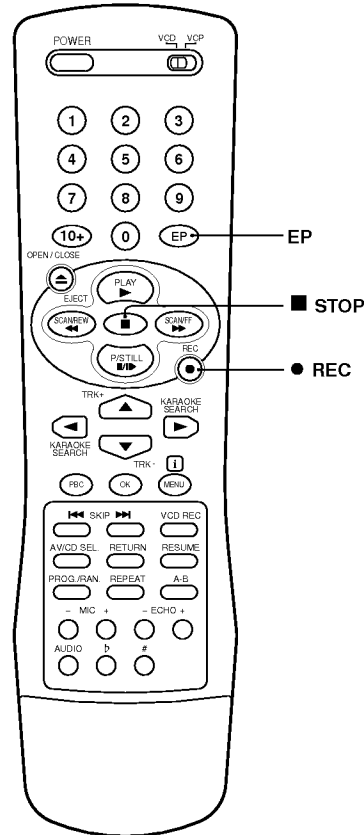

- 1** Turn on your TV and set it to the tuner mode.
- 2** Insert a tape with its safety tab in place into the VCP part of this player.
- 3** Press **EP** to select the tape speed, SP or EP.
EP provides recording time three times as long as SP, however, SP produces better picture and audio quality.
- 4** Press **● REC** to start recording.
During recording, do not change the TV channel or turn off the TV.
When the tape reaches the end, the unit automatically rewinds it to the beginning.

continued

To stop recording

Press ■ **STOP**.

To save a recording

To prevent accidental erasure, break off the safety tab as illustrated. To record on the tape again, cover the tab hole with adhesive tape.



Tip

- The display appears on the TV screen indicating information about the tape, but the information won't be recorded on the tape.

Notes

- The display appears only during playback at normal speed.
- If you've inserted a tape with its safety tab removed, the player ejects it when you press
 - **REC**.
- If your TV is a monaural type, connect the audio output jack of your TV to the AUDIO IN-L of the player.

Editing with another VCR

How to connect to record on the VCP part of this player

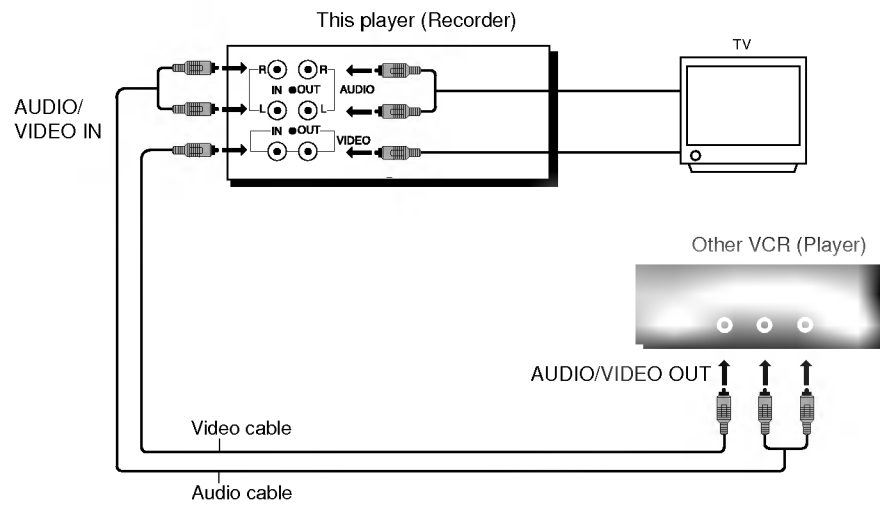

Notes

- Make sure you connect the plugs to jacks of the same colour.
- If the other VCR is a monaural type, connect the audio output jack of other VCR to the AUDIO IN-L of the player.

continued

Operation (when recording on the VCP part of this player)

Before you start editing

- Set VCD/VCP switch to the VCP.
- Turn on your TV and set it to the AV.
- Press EP to select the tape speed(SP or EP).

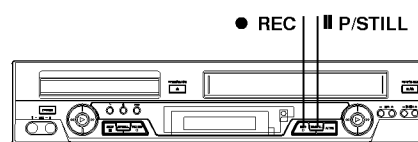

- 1** Insert a source tape with its safety tab removed into the other (playback) VCR.
- 2** Insert a tape with its safety tab in place into this (recording) VCP part of this player.
- 3** Press ● **REC** on this VCP part of this player.
To start editing, press the ► **PLAY** button on the VCR at the same time.

To stop editing

Press the ■ **STOP** buttons on the VCR and this VCP part.

Tip

- To cut out unwanted scenes while editing, press ■ **P/STILL** on this VCP part when an unwanted scene begins. When it ends, press ■ **P/STILL** again to resume recording.

Recording from a CD to a tape

- Set VCD/VCP switch to the VCD.

- 1** Press **POWER** to turn on the player.
- 2** Press **▲ OPEN/CLOSE**, place the disc on the disc tray, and press **▲ OPEN/CLOSE**.
- 3** Insert a tape with its safety tab in place into the VCP part of this player.
- 4** Press **VCD REC**.
VCD part starts playback and VCP part starts recording.
- 5** To stop a recording, press **■ STOP** of VCD part.

Tips

- To pause a recording, press **■ P/STILL** of VCD part.
- To return to the recording, press **■ P/STILL** of VCD part again.

Notes

- If the on-screen display is displayed on the TV screen by pressing **OK** during the VCD REC Mode, the on-screen display will be recorded in the recordable tape.
- Pausing a recording lasts for up to 5 minutes. After 5 minutes the player will stop the recording.

Resuming playback from the point you stopped a VIDEO CD & AUDIO CD (Resume Play)

- Set VCD/VCP switch to the VCD.

The VCD part of this player memorizes the point you stopped a VIDEO CD and AUDIO CD and you can resume playback from that point.

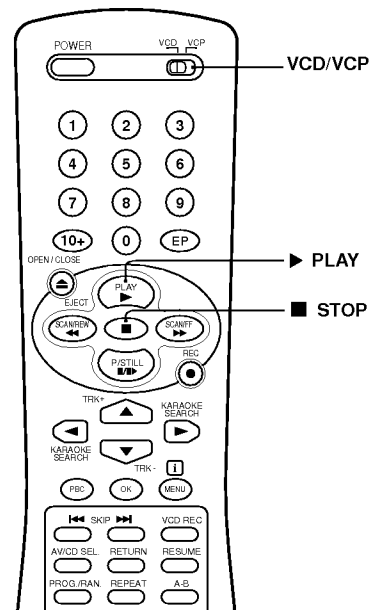

- 1** While playing a VIDEO CD & AUDIO CD, press ■ **STOP** to stop playback.
- 2** Press **RESUME**.
The player starts playback from the point you stopped the VIDEO CD & AUDIO CD in Step 1.

To play from the beginning of the VIDEO CD & AUDIO CD

Press ■ **STOP**, then press ► **PLAY**.

Notes

- Depending on where you stopped the VIDEO CD & AUDIO CD, the player may resume playback from a different point.
- The point at which you stopped playing is cleared when:
 - you remove the VIDEO CD & AUDIO CD from the player
 - you unplug the AC power cord of the player
- If you stop playback at the menu screen of CD while playing a CD with PBC ON, the resume play is not available.

Playing repeatedly

- Set VCD/VCP switch to the VCD.

You can play all the tracks, a single track or a specific portion repeatedly.

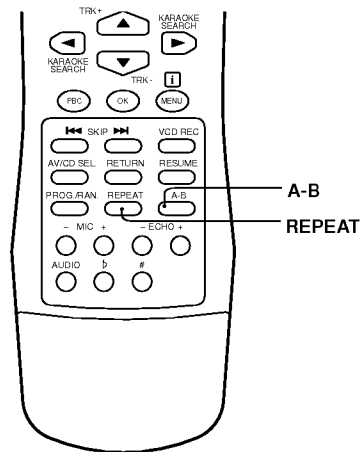

Repeating the current track

You can repeat only the current track in Continuous Play mode.

While the track you want is being played, press **REPEAT** repeatedly until “REPEAT ONE” appears in the display window.

To cancel repeating the current track

Press **REPEAT** repeatedly until “REPEAT ONE” disappears from the display window.

Repeating all the tracks on a disc

Press **REPEAT** while playing a disc.

“REPEAT ALL” appears in the display window.

To cancel Repeat Play

Press **REPEAT** repeatedly until “REPEAT ALL” disappears from the display window.

Repeating a specific portion

Press **A-B** while playing a disc to set the starting point.

“REPEAT A \leftrightarrow ” appears in the display window.

Press **A-B** again to set the ending point.

“REPEAT A \leftrightarrow B” appears in the display window.

To cancel repeating the A \leftrightarrow B

Press **A-B**.

Note

- You cannot do repeat play during random, program, and PBC playback.

Creating your own program (Program Play)

• Set VCD/VCP switch to the VCD.

You can arrange the order of the tracks on the discs and create your own program. The program can contain up to 30 tracks.

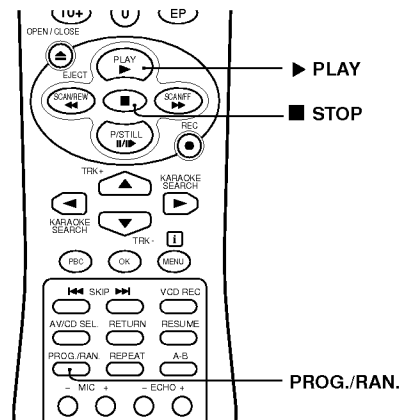

- 1** Press **PROG./RAN.**.
"PROGRAM" appears in the display window.
- 2** Press the number buttons of the tracks you want to program in the order you want.
To program a track numbered over 10, use the 10+ button first, then the corresponding number buttons.

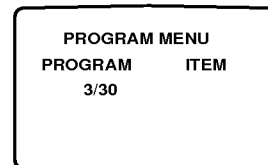

To cancel Program Play

Press ■ **STOP**.

"PROGRAM" disappears in the display window.

- 3** Press ▶ **PLAY** to start Program Play.

To return to the continuous playback, press **PROG./RAN.** twice.

"PROGRAM" disappears in the display window.

Tip

- The program remains even after the Program Play ends.
When you press ▶ **PLAY**, you can play the the same program again.

Notes

- If you play a VIDEO CD with PBC functions in Program Play mode, you cannot use PBC functions.
- If you turn PBC functions on while playing in program mode, the program mode is released.

Playing in random order

- Set VCD/VCP switch to the VCD.

You can have the player “random” tracks and play in a random order.

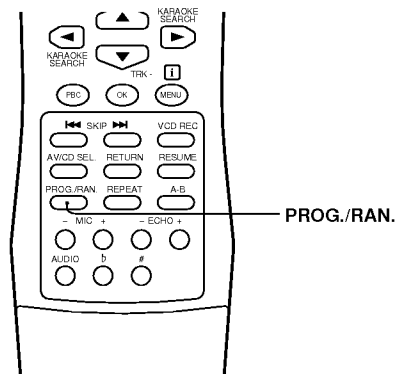

- 1** Press **PROG./RAN.**.
“RANDOM” appears in the display window.
- 2** The player starts Random Play.

To cancel Random Play

Press **PROG./RAN.**.
“RANDOM” disappears in the display window.

Notes

- If you play a VIDEO CD with PBC functions in Random Play mode, you cannot use the PBC functions.
- If you turn PBC functions on while playing in random mode, the random mode is released.

Playing a VIDEO CD with PBC functions (PBC Playback)

- Set VCD/VCP switch to the VCD.

When playing a VIDEO CD with PBC functions (Ver. 2.0), you can enjoy playing simple interactive software, software with search functions, etc.

PBC Playback allows you to play a VIDEO CD interactively, following the menu screen on the TV screen.

Refer to the instructions supplied with the disc, as the operating procedure may differ according to the VIDEO CD.

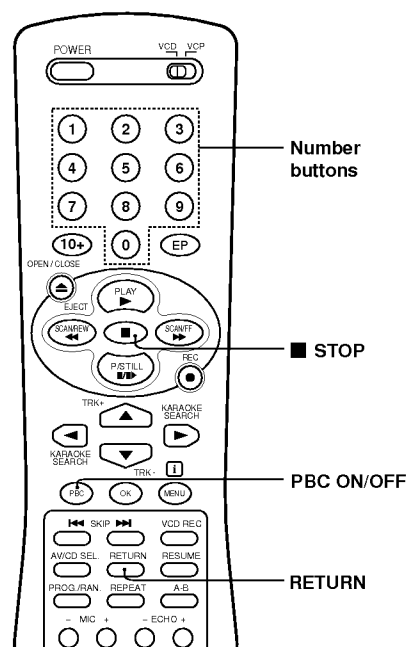
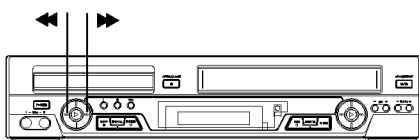

- 1 Start playing a VIDEO CD with PBC functions, following Steps 1 through 4 in “Playing a VIDEO CD/Audio CD/MP3 CD” on page 12.

The menu screen appears on the TV screen.

Playing a VIDEO CD with PBC functions (PBC Playback) (continued)

2 Select the item number you want.

Press the number button of the item you want.

When you want to select an item number over 10, press 10+ first, then the corresponding number buttons.

3 Follow the instructions on the menu screen for interactive operations.

To	Press
Stop play	■ STOP
Select the item	number buttons on the remote
Go back to the menu screen	RETURN

To cancel PBC Playback of a VIDEO CD with PBC functions and play the disc in Continuous Play mode

Press **PBC**.

“PBC” disappears in the display window and the player starts Continuous Play. You cannot play still pictures such as a menu screen.

Precautions

Precautions

Safety

- Caution - The use of optical instruments with this product will increase eye hazard.
- This player operates on 110 - 240 V AC, 50/60 Hz. Check that the unit's operating voltage is identical with your local power supply.
- If anything falls into the cabinet, unplug the unit and have it checked by qualified personnel before operating it any further.
- Unplug the unit from the mains if you do not intend to use it for an extended period of time. To disconnect the cord, pull it out by the plug, never by the cord.
- Should the AC power cord (mains lead) need to be changed, have it done at a qualified service shop only.

Installing

- Allow adequate air circulation to prevent internal heat buildup.
- Do not install the unit near heat sources such as radiators or air ducts, or in a place subject to direct sunlight, excessive dust, mechanical vibration or shock.
- Do not install the unit in an inclined position. It is designed to be operated in a horizontal position only.
- Keep the unit and cassettes away from equipment with strong magnets, such as microwave oven or large loudspeakers.
- Do not place heavy objects on the unit.
- If the unit is brought directly from a cold to a warm location, moisture may condense inside the unit and cause damage to the video head and tape. When you first install the unit, or when you move it from a cold to a warm location, wait for about one hour before operating the unit.
- Do not turn up the volume while listening to a portion with very low level inputs or no audio signals. If you do, the speakers may be damaged when a peak level portion is played.
- Clean the cabinet, panel and controls with a soft cloth slightly moistened with a mild detergent solution. Do not use any type of abrasive pad, scouring powder or solvent such as alcohol or benzine.

Notes on Discs

On handling discs

- To keep the disc clean, handle the disc by its edge. Do not touch the surface.
- Do not stick paper or tape on the disc. If there is glue (or a similar substance) on the disc, remove the glue completely before using the disc.

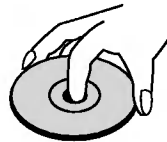

Not this way

- Do not expose the disc to direct sunlight or heat sources such as hot air ducts, or leave it in a car parked in direct sunlight as there can be considerable rise in temperature inside the car.
- After playing, store the disc in its case.

On cleaning

- Before playing, clean the disc with a cleaning cloth. Wipe the disc from the center to out.



- Do not use solvents such as benzine, thinner, commercially available cleaners or antistatic spray intended for vinyl LPs.

Troubleshooting

If you have any questions or problems not covered below, please consult your nearest service facility.

	Symptom	Remedy
Power	The POWER switch does not function.	<ul style="list-style-type: none"> • Connect the mains lead securely.
	The power is turned on but this player does not operate.	<ul style="list-style-type: none"> • Moisture condensation occurs. Turn the power on, leave this player to dry for over an hour. • There's no disc inside the VCD part ("NO DISC" appears). Insert a disc. • Insert the disc with the label side up on the disc tray of the VCD part correctly. • Clean the disc (VIDEO CD or Audio CD).
Playback	The playback picture does not appear on the TV screen.	<ul style="list-style-type: none"> • If you are using a monitor, set it to video input. • Check that the player is connected securely.
	The picture is not clear.	<ul style="list-style-type: none"> • Adjust the tracking with the TRK(+/-) buttons when using a video tape. • Make sure the colour system is set to the position corresponding to the colour system which the tape was recorded with. • The video heads of VCP part are dirty. Clean the video heads using video head cleaning cassette. If this cleaning cassette is not available in your area, have the heads cleaned at your nearest service facility. • The video heads of VCP part may have to be replaced. Consult your local service facility for more information.
	The picture rolls vertically during picture search.	<ul style="list-style-type: none"> • Adjust the vertical hold control on the TV or monitor.
	The picture has no sound	<ul style="list-style-type: none"> • The tape is defective. Use a new tape. • Check that the player is connected securely. • Make sure you operate the TV or the amplifier correctly. • Make sure you select the correct position on the amplifier.
	The tape starts playing as soon as it is inserted.	<ul style="list-style-type: none"> • The safety tab of the video tape has been removed. To record on this tape, cover the tab hole.
Recording	The tape is ejected when you press ● REC.	<ul style="list-style-type: none"> • Check that the safety tab of the video tape has not been removed.
	Nothing happens when you press ● REC.	<ul style="list-style-type: none"> • Make sure the tape is not at its end.

	Symptom	Remedy
Others	No tape can be inserted.	<ul style="list-style-type: none"> • Check that a tape isn't already in the tape compartment of the VCP part.
	The remote commander does not function.	<ul style="list-style-type: none"> • Make sure you are pointing the remote commander at the remote sensor on the player. • Remove the obstacles in the path of the remote and the player. • Replace all the batteries in the remote commander with new batteries if they are weak. • Make sure the VCD/VCP remote control switch is set correctly.
	The player needs to be cleaned	<ul style="list-style-type: none"> • Clean the cabinet, panel, and controls with a dry soft cloth, or a soft cloth slightly moistened with a mild detergent solution. Do not use any type of solvent, such as alcohol or benzine.

Specifications

VCD part

Laser
Semiconductor laser
Wavelength
760 - 800 nm
Signal format system
NTSC
Frequency response
20 Hz to 20 kHz \pm 2 dB
Signal-to noise ratio
More than 70 dB
Harmonic distortion
Less than 0.15%

VCP part

Video Head System
Double azimuth 4 heads,
helical scanning

Inputs and outputs

VIDEO IN, phono jack (1 each)
Input signal: 1 Vp-p, 75 ohms,
unbalanced
AUDIO IN, phono jack (2 each)
Input level: -6.0 dBm
Input impedance: more than 47 kilohms
VIDEO OUT, phono jack (1)
Output signal: 1 Vp-p, 75 ohms,
unbalanced
AUDIO OUT, phono jack (2)
Output level: -6.0 dBm
Output impedance: less than 1 kilohms

General

Power requirements
110 - 240 V AC, 50/60 Hz
Power consumption
20 W
Operating temperature
5°C to 35°C
Dimensions
Approx. 430 x 94.5 x 330 mm (w/h/d)
including projecting parts and controls
Mass
Approx. 4.0 kg

Supplied accessories

Remote control (1)
R03 (Size AAA) batteries (2)
Audio cable (2-phono to 2-phono) (1)
Video cable (1-phono to 1-phono) (1)

Design and specifications are subject to change
without notice.



P/N: 3834RM0046F