



# Color Television OWNER'S MANUAL

MODELS : RU-27FC30  
RU-32FC30

Please read this manual carefully before operating your set.  
Retain it for future reference.  
Record model number and serial number of the set.  
See the label attached on the back cover and quote this  
information to your dealer when you require service.

Internet Home Page [www.lg.ca](http://www.lg.ca)

RECORD YOUR MODEL NUMBER  
(For future reference)

The model and serial number of your new TV are located on the back of the TV cabinet. For your future convenience, we suggest that you record those numbers here:

MODEL NO. \_\_\_\_\_

SERIAL NO. \_\_\_\_\_



**WARNING**  
RISK OF ELECTRIC SHOCK  
DO NOT OPEN



**WARNING:**

TO REDUCE THE RISK OF ELECTRIC SHOCK DO NOT REMOVE COVER (OR BACK). NO USER SERVICEABLE PARTS INSIDE. REFER SERVICING TO QUALIFIED SERVICE PERSONNEL.



The lightning flash with arrowhead symbol, within an equilateral triangle, is intended to alert the user to the presence of uninsulated "dangerous voltage" within the product's enclosure that may be of sufficient magnitude to constitute a risk of electric shock to persons.



The exclamation point within an equilateral triangle is intended to alert the user to the presence of important operating and maintenance (servicing) instructions in the literature accompanying the appliance.

**WARNING:**

TO PREVENT FIRE OR SHOCK HAZARDS, DO NOT EXPOSE THIS PRODUCT TO RAIN OR MOISTURE.

**NOTE TO CABLE/TV INSTALLER:**

This reminder is provided to call the cable TV system installer's attention to Article 820-40 of the National Electric Code (U.S.A.). The code provides guidelines for proper grounding and, in particular, specifies that the cable ground shall be connected to the grounding system of the building, as close to the point of the cable entry as practical.

**REGULATORY INFORMATION:**

This equipment has been tested and found to comply with the limits for a Class B digital device, pursuant to Part 15 of the FCC Rules. These limits are designed to provide reasonable protection against harmful interference when the equipment is operated in a residential installation. This equipment generates, uses and can radiate radio frequency energy and, if not installed and used in accordance with the instruction manual, may cause harmful interference to radio communications. However, there is no guarantee that interference will not occur in a particular installation. If this equipment does cause harmful interference to radio or television reception, which can be determined by turning the equipment off and on, the user is encouraged to try to correct the interference by one or more of the following measures:

- Reorient or relocate the receiving antenna.
- Increase the separation between the equipment and receiver.
- Connect the equipment into an outlet on a circuit different from that to which the receiver is connected.
- Consult the dealer or an experienced radio/TV technician for help.

Any changes or modifications not expressly approved by the party responsible for compliance could void the user's authority to operate the equipment.

**CAUTION:** Do not attempt to modify this product in any way without written authorization from LG Electronics Corporation. Unauthorized modification could void the user's authority to operate this product.

# IMPORTANT SAFETY INSTRUCTIONS

## Important safeguards for you and your new product

Your product has been manufactured and tested with your safety in mind. However, improper use can result in potential electrical shock or fire hazards. To avoid defeating the safeguards that have been built into your new product, please read and observe the following safety points when installing and using your new product, and save them for future reference.

Observing the simple precautions discussed in this operating guide can help you get many years of enjoyment and safe operation that are built into your new product.

This product complies with all applicable U.S. Federal safety requirements, and those of the Canadian Standards Association.

### 1. Read Instructions

All the safety and operating instructions should be read before the product is operated.

### 2. Follow Instructions

All operating and use instructions should be followed.

### 3. Retain Instructions

The safety and operating instructions should be retained for future reference.

### 4. Heed Warnings

All warnings on the product and in the operating instructions should be adhered to.

### 5. Cleaning

Unplug this product from the wall outlet before cleaning. Do not use liquid cleaners or aerosol cleaners. Use a damp cloth for cleaning.

### 6. Water and Moisture

Do not use this product near water for example, near a bath tub, wash bowl, kitchen sink, or laundry tub, in a wet basement, or near a swimming pool.

### 7. Accessories

Do not place this product on an unstable cart, stand, tripod, bracket, or table. The product may fall, causing serious injury to a child or adult, and serious damage to the product. Use only with a cart, stand, tripod, bracket, or table recommended by the manufacturer, or sold with the product. Any mounting of the product should follow the manufacturer's instructions, and should use a mounting accessory recommended by the manufacturer.

### 8. Transporting Product

A product and cart combination should be moved with care. Quick stops, excessive force, and uneven surfaces may cause the product and cart combination to overturn.

### 9. Attachments

Do not use attachments not recommended by the product manufacturer as they may cause hazards.

### 10. Ventilation

Slots and openings in the cabinet are provided for ventilation and to ensure reliable operation of the product and to protect it from overheating, and these openings must not be blocked or covered. The openings should never be blocked by placing the product on a bed, sofa, rug, or other similar surface. This product should not be placed in a built-in installation such as a bookcase or rack unless proper ventilation is provided or the manufacturer's instructions have been adhered to.

### 11. Power Sources

This product should be operated only from the type of power source indicated on the marking label. If you are not sure of the type of power supply to your home, consult your product dealer or local power company. For products intended to operate from battery power, or other sources, refer to the operating instructions.

### 12. Line-Cord Polarization

This product is equipped with a polarized alternating-current line plug (a plug having one blade wider than the other). This plug will fit into the power outlet only one way. This is a safety feature. If you are unable to insert the plug fully into the outlet, try reversing the plug. If the plug should still fail to fit, contact your electrician to replace your obsolete outlet. Do not defeat the safety purpose of the polarized plug.

### 13. Power-Cord Protection

Power-supply cords should be routed so that they are not likely to be walked on or pinched by items placed upon or against them, paying particular attention to cords at plugs, convenience receptacles, and the point where they exit from the product.



PORTABLE CART WARNING

(Continued on next page)

# IMPORTANT SAFETY INSTRUCTIONS

(Continued from previous page)

## 14. Outdoor Antenna Grounding

If an outside antenna or cable system is connected to the product, be sure the antenna or cable system is grounded so as to provide some protection against voltage surges and built-up static charges. Article 810 of the National Electrical Code (U.S.A.), ANSI/ NFPA 70 provides information with regard to proper grounding of the mast and supporting structure, grounding of the lead-in wire to an antenna discharge unit, size of grounding conductors, location of antenna-discharge unit, connection to grounding electrodes, and requirements for the grounding electrode.

Example of Grounding According to National Electrical Code Instructions

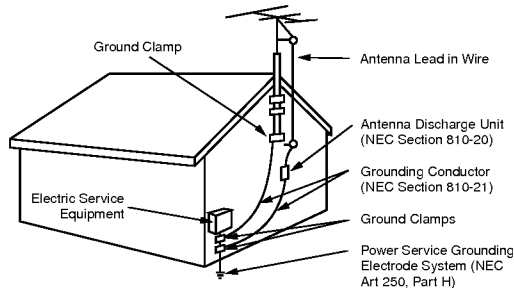

NEC- National Electrical Code

## 15. Lightning

For added protection for this product (receiver) during a lightning storm, or when it is left unattended and unused for long periods of time, unplug it from the wall outlet and disconnect the antenna or cable system. This will prevent damage to the product due to lightning and power-line surges.

## 16. Power Lines

An outside antenna system should not be located in the vicinity of overhead power lines or other electric light or power circuits, or where it can fall into such power lines or circuits. When installing an outside antenna system, extreme care should be taken to keep from touching such power lines or circuits as contact with them might be fatal.

## 17. Overloading

Do not overload wall outlets and extension cords as this can result in a risk of fire or electric shock.

## 18. Object and Liquid Entry

Never push objects of any kind into this product through openings as they may touch dangerous voltage points or short-out parts that could result in a fire or electric shock. Never spill liquid of any kind on the product.

## 19. Servicing

Do not attempt to service this product yourself as opening or removing covers may expose you to dangerous voltage or other hazards. Refer all servicing to qualified service personnel.

## 20. Damage Requiring Service

Unplug this product from the wall outlet and refer servicing to qualified service personnel under the following conditions:

- If the power-supply cord or plug is damaged.
- If liquid has been spilled, or objects have fallen into the product.
- If the product has been exposed to rain or water.
- If the product does not operate normally by following the operating instructions. Adjust only those controls that are covered by the operating instructions as an improper adjustment of other controls may result in damage and will often require extensive work by a qualified technician to restore the product to its normal operation.
- If the product has been dropped or the cabinet has been damaged.
- If the product exhibits a distinct change in performance.

## 21. Replacement Parts

When replacement parts are required, be sure the service technician has used replacement parts specified by the manufacturer or have the same characteristics as the original part. Unauthorized substitutions may result in fire, electric shock, or other hazards.

## 22. Safety Check

Upon completion of any service or repairs to this product, ask the service technician to perform safety checks to determine that the product is in proper operating condition.

## 23. Wall or Ceiling Mounting

The product should be mounted to a wall or ceiling only as recommended by the manufacturer.

## 24. Heat

The product should be situated away from heat sources such as radiators, heat registers, stoves, or other products (including amplifiers) that produce heat.

# CONTENTS

<b>Safety Warnings .....</b>	<b>2</b>	<b>Sound Control .....</b>	<b>17</b>
<b>Important Safety Instructions .....</b>	<b>3</b>	Enjoying Stereo/SAP Broadcasts.....	17
<b>Remote/Front Panel Controls .....</b>	<b>6</b>	Auto Sound Control.....	17
<b>Basic TV Setup and Operation .....</b>	<b>8</b>	Adjusting Equalizer	
Turning the TV On/Off.....	8	(OFF mode in ASC) .....	18
Selecting the Menu Language .....	8	Adjusting Balance .....	18
Channel Search. ....	9	AVL (Auto Volume Leveler) .....	18
Memorizing the Channels with		Adjusting the DBS	
AUTO PROGRAM .....	9	(Dynamic Bass Sound) .....	18
Memorizing the Channels with		Adjusting the Bass .....	19
MANUAL PROGRAM .....	10	Adjusting the Treble .....	19
Tuning Channels .....	10	<b>Closed Caption .....</b>	<b>20</b>
Adjusting Volume (Sound) .....	10	Using Closed Captions .....	20
<b>Available Features .....</b>	<b>11</b>	Operating the Caption and Text.....	21
Setting the Clock .....	11	<b>Parental Control.....</b>	<b>22</b>
Setting the OFF TIMER.....	11	Blocking Setup .....	23
Setting the ON TIMER .....	12	<b>Antenna Connections .....</b>	<b>24</b>
Setting the Sleep Timer .....	12	<b>Connection of external equipment .....</b>	<b>25</b>
Auto Off .....	12	<b>DVD player Connection and setup .....</b>	<b>27</b>
Operating Degauss .....	13	<b>Maintenance .....</b>	<b>28</b>
Key Lock .....	13	<b>Product Specifications .....</b>	<b>29</b>
Fine Tuning .....	13	<b>Troubleshooting Checklist .....</b>	<b>30</b>
Picture Tilt .....	14		
Favorite Channel Memory.....	14		
Wide/Zoom Picture .....	14		
<b>Picture Control .....</b>	<b>15</b>		
Auto Picture Control .....	15		
VM (Velocity Modulation) .....	15		
Color Temperature .....	15		
Adjusting the Picture .....	16		

After reading this manual, keep it handy for future reference.

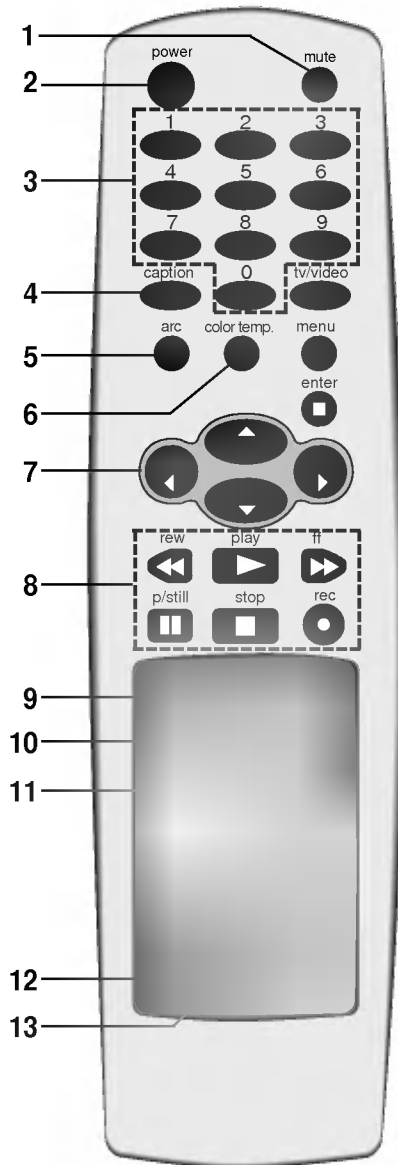

**1. MUTE BUTTON**

Press to mute sound. Press again to restore sound.

**2. POWER BUTTON (or ON/OFF)**

Refer to "Turning the TV On/Off".

**3. NUMBER BUTTONS**

Direct channel selection.

**4. CAPTION BUTTON**

Selects CAPTION mode.  
Refer to "Closed captions".

**5. ARC BUTTON**

Selects 4:3 or 16:9 picture formats..

**6. COLOR TEMPERATURE BUTTON**

Adjusts TV color temperature.

**7. CHANNEL UP/DOWN (▲/▼) BUTTONS**

- Selects the desired channel.
- Selects the desired menu option when menu is displayed on the screen.

**VOLUME UP/DOWN (◀/▶) BUTTONS**

- Increase or decrease volume level.
- Enters or adjusts the selected menu when menu is displayed on the screen.

**8. VCR BUTTONS**

Control some video cassette recorders.

**9. SLEEP BUTTON**

Sets desired sleep time.

**10. FLASHBACK BUTTON**

To return to the previous channel.

**11. MTS BUTTON**

Selects to the MTS sound : **MONO**, **STEREO** or **SAP**.

**12. AUTO PROGRAM BUTTON**

Memorizes channels with AUTO PROGRAM.

**13. MEMORY/ERASE BUTTON**

Memorizes or erases selected channel.

This is a simplified representation of front panel.

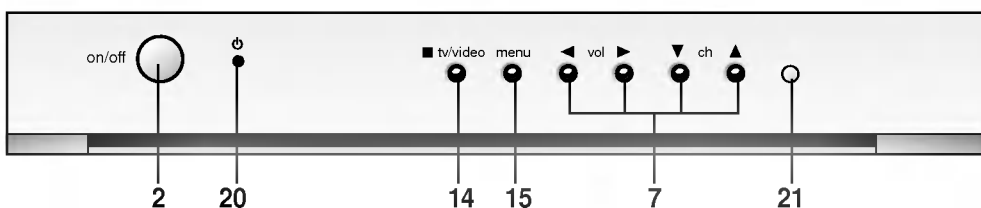

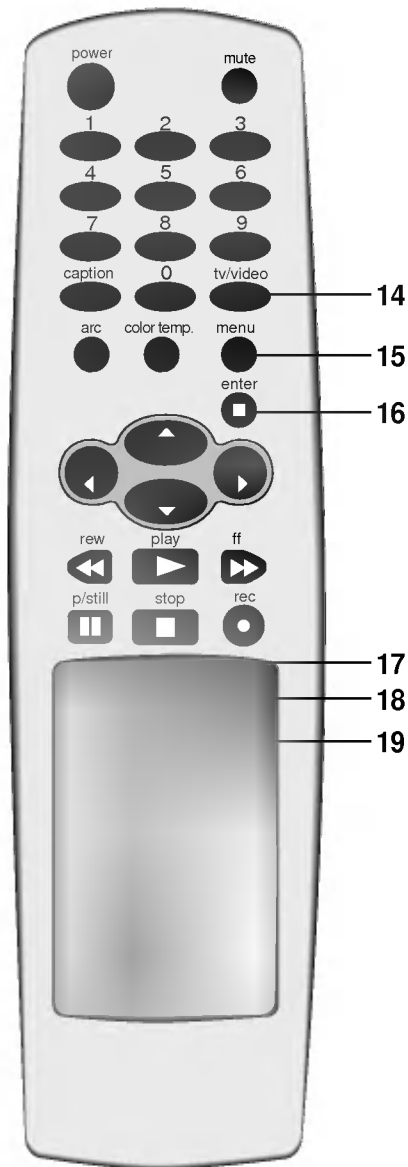

**14.TV/VIDEO BUTTON**

Selects TV, VIDEO or COMPONENT mode.

**15.MENU BUTTON**

Displays on-screen menus.  
Exit the current menu.  
Memorizes menu change.

**16.ENTER (■) BUTTON**

- Memorizes menu adjustments.
- Recalls current TV mode (by remote control only).

**17.APC (Auto Picture Control) BUTTON**

Selects factory preset picture settings.

**18.FCR (Favorite Channel Review) BUTTON**

Selects favorite channels.  
Refer to "**Favorite channel memory**".

**19.DASP BUTTON**

Selects the sound appropriate for the program's character ;  
**Dolby virtual, Flat, Movie, Music, Sports or User.**

**20.STANDBY INDICATOR**

Illuminates red when the TV is in standby mode. Refer to "**Turning the TV On/Off**".

**21.REMOTE CONTROL SENSOR**

**Installing Batteries in the Remote Control**

The remote control is powered by batteries, requiring 'AA' type batteries for operation. To ensure reliable operation, change the batteries about once a year.

**Caution :** Batteries installed incorrectly may leak and damage the remote control. Do not mix old and new batteries or different types of batteries (for example, standard and alkaline).

1. Remove the battery compartment cover by sliding it in the direction shown.
2. Insert new batteries matching the polarity markings (+ and -) inside the compartment.
3. Replace the battery compartment cover.

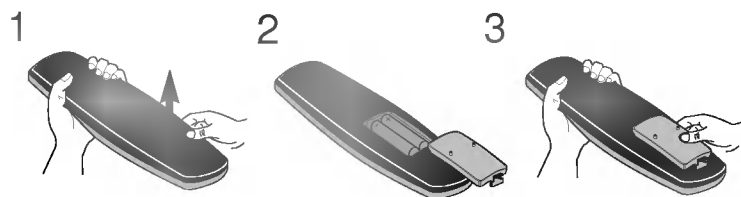

Before operating your TV, make sure the following have been completed.

- Your TV is connected to an antenna or a cable system.
- Your TV is plugged into a standard power outlet.

## Turning the TV On/Off

The set switches to standby mode and the standby indicator lights up in red.

To turn the TV on from standby mode, press the TV/VIDEO, CH ▲/▼ button on the set or POWER, TV/VIDEO, CH ▲/▼ or number button on the remote control.

A channel number will be displayed on the screen. The on-screen display will disappear after a few seconds.

Press the **power** button on the remote control, the TV reverts to standby mode.

## Selecting the Menu Language

1. Press the **menu** button and then use ▲ / ▼ button to select the menu shown to the right.
2. Press the ► and then use ▲/▼ button to select **Language**.
3. Use the ◀/▶ button to select the desired language.

From this point on, the on-screen display will be presented in the language of your choice.

4. Press the **menu** button to remove menu.



## Channel Search

This is the function to memorize all the active channels in your area before you can use the TV. There are two ways of memorizing channels. You can use either.

One is called **AUTO PROGRAM** and the other is called **MANUAL PROGRAM**.

In **AUTO PROGRAM** the TV will memorize the channels in ascending order. If there are additional channels you want to add or delete, you can manually add or delete those channels.

### Memorizing the Channels with AUTO PROGRAM

**AUTO PROGRAM** searches and memorizes all the active channels in your area then you can select the desired channel with the ▲ / ▼ buttons.

#### Using the a.prog Button

You can conveniently perform AUTO PROGRAM using the **a.prog** button on the remote control.

1. Press the **a.prog** button.
2. Use the ▲ / ▼ button to select **Normal** or **Turbo**.
3. Press the ► or **a.prog** button.

The AUTO PROGRAM starts now.

If you want to stop auto programming, press the **enter** (■) button. Only the channels searched up to that time are memorized.

**Turbo auto program** works faster than **Normal auto program**.

**Notes** : • If the programmed signal is of poor quality, memorize again in the **Normal auto program**.

- AUTO PROGRAM stores all available channels regardless of receiving signal (RF, Cable).
- If channels of general wireless TV and cable TV are duplicated, use the number buttons (0 ~ 9) to change as

Channels of general wireless TV ↔ Channels of Cable TV

#### Using the On screen Menu

1. Press the **menu** button and use ▲ / ▼ button to select the menu shown to the right.
2. Press the ► and then use ▲ / ▼ button to select **Auto program**.
3. Press the ► button to enter the **Auto program** mode.
4. Use the ▲ / ▼ button to select **Normal auto program** or **Turbo auto program**.
5. Press the ► button. The AUTO PROGRAM starts now.

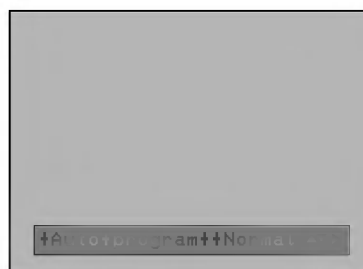

## Memorizing Channels with Manual Program

### Using Memory/Erase button

You can conveniently perform MANUAL PROGRAM using the **memory/erase** button on the remote control.

1. Use the ▲ / ▼ or NUMBER buttons to select the channel number you want to memorize or erase.
2. Press the **memory/erase** button.  
The on screen display appears as shown right.
3. Use the **memory/erase** button to select **Memory** or **Erase**.
4. Press the **enter** (■) button to remove menu.



### Using the Onscreen Menu

1. Press the **menu** button and then use ▲ / ▼ button to select the menu shown to the right.
2. Press the ► and then use ▲ / ▼ button to select **Manual program**.
3. Press the ► button to enter the **Manual program** mode.
4. Use the ◀/▶ to select **Memory** or **Erase**.
5. Use the ▼ button to select **Channel**.
6. Use the ◀/▶ or NUMBER buttons to select the channel number you want to memorize or erase.
7. Use the ▼ button to select **Name**. You can make a channel name.
8. Use the ◀/▶ button to select a word position and then ▲/▼ button to enter blank, number 0 to 9 and the alphabet A to Z.
9. Repeat steps 4 to 8 to memorize or erase other channels.
10. Press the **menu** button to remove menu.



## Channel Tuning

Use the ▲ / ▼ button to easily select the next higher or lower channel then the channel being viewed, or **NUMBER** buttons to directly select the desired channel.



## Adjusting Volume (Sound)

Use the ► button to increase the volume level or ◀ button to decrease the volume level.

To turn off the sound, press the **mute** button.

The word **Mute** is displayed (It's not displayed in the Caption mode).

Mute is convenient if you need to answer telephone calls.

To restore the muted sound, press the **mute** button again or **vol** ◀/▶ button.



## Setting the Clock

Before setting the on/off timer, set the current time on the clock.

1. Press the **menu** button and then use ▲ / ▼ button to select the menu shown to the right.
2. Press the ► and then use ▲ / ▼ button to select **Clock**.
3. Press the ► button and then use the ▲ / ▼ button to set the hours.
4. Press the ► button and then use the ▲ / ▼ button to set the minutes.
5. Press the **menu** button to remove menu.

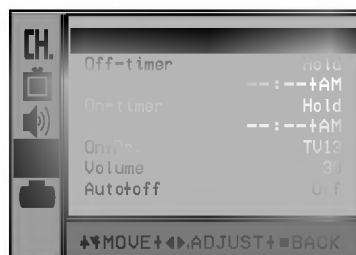
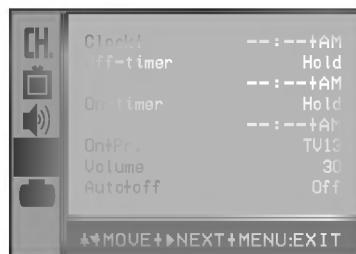

## Setting the Off Timer

This is the function to automatically switch the TV to standby mode at a preset time.

1. Press the **menu** button and then use ▲ / ▼ button to select the menu shown to the right.
2. Press the ► and then use ▲ / ▼ button to select **Off-timer**.
3. **Run/Hold** is used to activate or deactivate preset on/off times. Use the ◀ / ▶ button to select **Hold** or **Run**.
4. Press the ▼ button.
5. Press the ► button and then use the ▲ / ▼ button to set the hours.
6. Press the ► button and then use the ▲ / ▼ button to set the minutes.
7. Press the **menu** button to remove menu.

**Notes:** • If the same time is set for the on time and off time, only the off time operates.

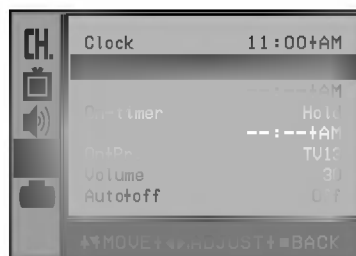
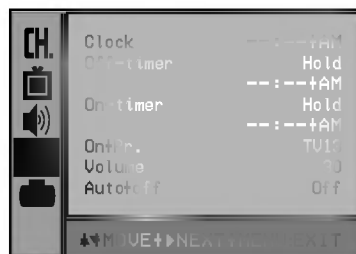

## Setting the On Timer

This is the function to automatically turn the TV on at a preset time and tune to the specified channel.

1. Press the **menu** button and then use **▲ / ▼** button to select the menu shown to the right.
2. Use the **▶** and then **▲/▼** button to select **On-timer**.
3. Repeat OFF TIMER steps 3 to 6 and then press the enter button.
4. Press the **▼** button to select **On Pr.** and then use the **◀/▶** button to select the desired channel.
5. Press the **▼** button to select **Volume** and then use the **◀/▶** button to adjust the volume level.
6. Press the **menu** button to remove menu.

**Notes:**

- If you don't press any button within 2 hours after turning on the TV set by ON TIMER function, the TV will be automatically switched back to standby mode.
- TV must be in standby mode for the On timer to work.

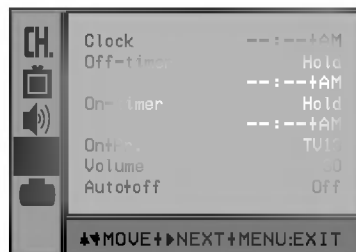

## Setting the Sleep Timer

You don't have to remember to switch the TV to standby mode before you go to sleep. The sleep timer automatically turns the TV off after the preset time elapses.

Use the **sleep** button to select the desired sleep time.

Each time you press this button, the sleep time is displayed one by one as shown below. The timer begins to count down from the number of minutes selected.

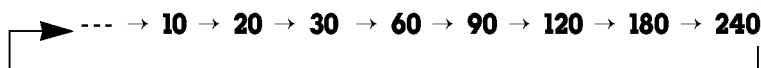

**Notes:**

- After a few seconds, the desired sleep time setting will disappear and operate automatically.
- To view the remaining sleep time, press the **sleep** button once and the remaining sleep time will be displayed.
- To cancel the sleep timer, select the **Sleep ---** setting with **sleep** button.
- "SLEEP 1" will be displayed one minute before the set is due to turn off.

## Auto Off

If there is no input signal, the TV is switched to standby mode automatically in 10 minutes.

1. Press the **menu** button and then use **▲ / ▼** button to select the menu shown to the right.
2. Press the **▶** and then use **▲/▼** button to select **Auto off**.
3. Use the **◀/▶** button to select **On** or **Off**.
4. Press the **menu** button to remove menu.

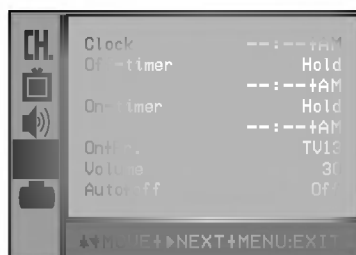

## Operating Degauss

In this TV set, the magnetic field of the earth may influence the color purity of picture by neighbor magnetic substance or installation direction of the TV set. Stripes may appear on the screen or the color may not be equal in the corners. Use Degauss to reset the color purity.

1. Press the **menu** button and then use ▲ / ▼ button to select the menu shown to the right.
2. Press the ► and then use ▲ / ▼ button to select **Degauss**.
3. Use the ◀ / ▶ button to select **On** or **Off**.
4. Press the **menu** button to remove menu.

**Notes:**

- Do not operate Degauss too often or the life of CPT may be shortened.
- If are unable to correct the screen condition by degaussing, try again after about 4 minutes.



## Key Lock

The TV can be set up so that the remote control is needed to operate it. This feature can be used to prevent unauthorized viewing.

1. Press the **menu** button and then use ▲ / ▼ button to select the menu shown to the right.
2. Press the ► and then use ▲ / ▼ button to select **Key lock**.
3. Use the ◀ / ▶ button to select **On** or **Off**.
4. Press the **menu** button to remove menu.

**Notes :**

- With the key lock on, the display **Key lock** appears on the screen if any button on the front panel is pressed while viewing the TV.
- This TV is programmed to remember which option it was last set to even if you switch the TV from standby mode.



## Fine Tuning Adjustment

This function is to adjust the picture to a stable condition when it is poor, for example, a horizontal stripe, twisted picture or no color in program.

1. Press the **menu** button and then use ▲ / ▼ button to select the menu shown to the right.
2. Press the ► and then use ▲ / ▼ button to select **Manual program**.
3. Press the ► button.
4. Use the ▲ / ▼ button to select **Fine**.
5. Use the ◀ / ▶ button to adjust the desired picture condition.
6. Press the **menu** button to remove menu.

**Notes :**

- To release the memorized fine tuning, reprogram the fine-tuned channel with AUTO PROGRAM or MANUAL PROGRAM.
- If a finely tuned channel is memorized, the color of the channel number changes to yellow.

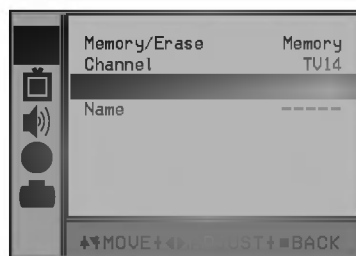
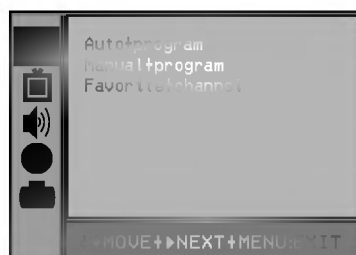

## Picture Tilt

The picture on the TV screen may tilt to left or right if the set is moved to another direction. Picture Tilt should be used to correct any tilt.

1. Press the **menu** button and then use ▲ / ▼ button to select the menu shown to the right.
2. Press the ► and then use ▲ / ▼ button to select **Tilt**.
4. Use the ◀ / ▶ button to adjust the **Tilt**.
5. Press the **menu** button to remove menu.



## Favorite Channel Memory

Favorite channel memory is a convenient feature that lets you quickly scan up to eight channels of your choice without having to wait for the TV to scan through all the in-between channels.

1. Press the **menu** button and then use ▲ / ▼ button to select the menu shown to the right.
2. Press the ► and then use ▲ / ▼ button to select **Favorite channel**.
3. Press the ► button to enter the **Favorite channel** mode.
4. Use the ▲ / ▼ button to memorize a favorite channel.
5. Use the ◀ / ▶ button to select the desired channel number.
6. Repeat steps 4 to 5.
7. Press the **menu** button to remove menu.



To select a favorite channel, press **fcn** repeatedly (Favorite Channel Review) button. Eight favorite channels programmed appear on the screen one by one.

## Wide / Zoom Picture

You can select the desired picture format (4:3 or 16:9).

1. Use the **arc** button to select your desired picture format.

- 4:3

It is the standard picture format size.

- 16:9

You can view either the cinema picture format 16:9 or standard picture format 4:3 in the 16:9 mode.

16:9 is viewed as is, 4:3 image is expanded to the left and right to fill the 16:9 screen.

## Auto Picture Control

You can select preprogrammed picture modes.

### Using the apc Button

1. Press the **apc** button.
2. Use the **apc** button to select **Clear**, **Optimum**, **Soft** or **User**.
3. Press the **enter** (■) button to remove menu.

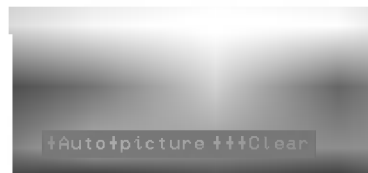

## VM (Velocity Modulation)

If you select **VM High**, the TV will automatically enhance the sharpness of the image's edges.

1. Press the **menu** button and then use ▲ / ▼ button to select the menu shown to the right.
2. Press the ► and then use ▲ / ▼ button to select **VM**.
3. Use the ◀ / ▶ button to select **Low**, **High** or **Off**.
4. Press the **menu** button to remove menu.



## Color Temperature

Specify the picture color status.

### Using the Color temp. Button

1. Press the **Color temp.** button.
2. Use the **Color temp.** button to select **Neutral**, **Warm**, or **Cool**.
3. Press the **enter** (■) button to remove menu.



### Using the menu Button

1. Press the **menu** button and then use ▲ / ▼ button to select the menu shown to the right.
2. Press the ► and then the use ▲ / ▼ button to select **Color Temp.**
3. Use the ◀ / ▶ button to select **Neutral**, **Warm**, or **Cool**.
4. Press the **menu** button to remove menu.



## Adjusting the Picture Appearance

This is the function to manually adjust the desired picture levels: **Contrast, Brightness, Color, Sharpness, Tint** of the image to your preference. If the picture settings you adjust are not satisfactory, you can also select a factory preset picture setup.

1. Press the **menu** button and then use ▲ / ▼ button to select the menu shown to the right.
2. Press the ► and then use ▲/▼ button to select the desired picture menu option.
3. Press the ► button.
4. Use the ◀/▶ button to adjust the level.  
The setting of highlighted menu option is displayed.
5. Press the **menu** button to remove menu.



## Stereo/SAP Broadcasts Setup

This TV set can receive MTS stereo programs and any SAP (Secondary Audio Program) that accompanies the stereo program, as the system to be transmitted one additional sound signal as well as the original one. MTS function doesn't operate in the video mode.

### Using the mts Button

1. Use the **mts** button to select your desired MTS mode.  
Each time you press this button, the **MONO**, **STEREO**, or **SAP** mode appear in turn.
2. Press the **enter** (■) button.

- Notes:**
- Stereo or SAP can be received only when the TV station transmits those signals even though you have selected **STEREO** or **SAP**.
  - Mono sound is automatically received if the broadcast is only in Mono; even though **STEREO** or **SAP** has been selected.
  - Select **MONO** if you want to listen to the mono sound in remote fringe areas during stereo/SAP broadcasting.

## Auto Sound Control

You can enjoy the best sound without any special adjustment because this TV set automatically adjusts the sound appropriate to viewing program character.

### Using the dasp Button

1. Press the **dasp** button.
2. Use the **dasp** button to select **Dolby virtual**, **Flat**, **Movie**, **Music**, **Sports** or **User**.
3. Press the **enter** (■) button to remove menu.

### Using the Menu Button

1. Press the **menu** button and then use ▲ / ▼ button to select the menu shown to the right.
2. Press the ► and then use the ▲ / ▼ button to select **DASP**.
3. Use the ◀ / ▶ button to select **Dolby virtual**, **Flat**, **Movie**, **Music**, **Sports** or **User**.
4. Press the **menu** button to remove menu.



## Adjusting the Equalizer (User Mode In ASC)

1. Press the **menu** button and then use ▲ / ▼ button to select the menu shown to the right.
2. Press the ► and then use ▲/▼ button to select **Equalizer**.
3. Use the ► button to select the **Equalizer** mode.
4. Use the ◀/▶ button to select the sound band and then use the ▲/▼ button to select the desired level.
5. Press the **menu** button to remove menu.



## Adjusting Balance

1. Press the **menu** button and then use ▲ / ▼ button to select the menu shown to the right.
2. Press the ► and then use ▲/▼ button to select **Balance**.
3. Use the ◀/▶ button to adjust the balance level.
4. Press the **menu** button to remove menu.



## AVL (Auto Volume Leveler)

AVL automatically keeps on an equal volume level even if you change channels.

### Using the Menu Button

1. Press the **menu** button and then use ▲ / ▼ button to select the menu shown to the right.
2. Press the ► and then use ▲/▼ button to select **AVL**.
3. Use the ◀/▶ button to select **On** or **Off**.
4. Press the **menu** button to remove menu.



## Adjusting the DBS (Dynamic Bass Sound)

1. Press the **menu** button and then use ▲ / ▼ button to select the menu shown to the right.
2. Press the ► and then use ▲/▼ button to select **DBS**.
3. Use the ◀/▶ button to select **On** or **Off**.
4. Press the **menu** button to remove menu.



## Adjusting Bass

This function is to increase or decrease bass.

1. Press the **menu** button and then use ▲ / ▼ button to select the menu shown to the right.
2. Press the ► and then use ▲ / ▼ button to select **DASP**.
3. Use the ◀ / ▶ button to select **Dolby virtual**.
4. Use the ▲ / ▼ button to select **Bass**.
5. Use the ◀ / ▶ button to adjust the bass level.
6. Press the **menu** button to remove menu.

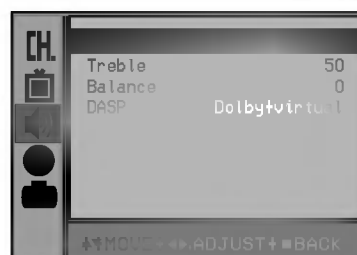

## Adjusting Treble

This function is to increase or decrease treble.

1. Press the **menu** button and then use ▲ / ▼ button to select the menu shown to the right.
2. Press the ► and then use ▲ / ▼ button to select **DASP**.
3. Use the ◀ / ▶ button to select **Dolby virtual**.
4. Use the ▲ / ▼ button to select **Treble**.
5. Use the ◀ / ▶ button to adjust the treble level.
6. Press the **menu** button to remove menu.



Closed captioning is a process which converts the audio portion of a television program into written words, which then appear on the television screen in a form similar to subtitles. Closed captions allow viewers to read the dialogue and narration of television programs.

## Using Closed Captions

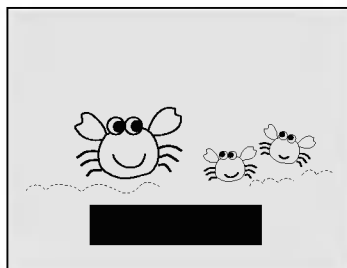

Captions are the subtitles of the dialogue and narration of television programs. For prerecorded programs, program dialogue can be arranged into captions in advance. It's possible to caption a live program by using a process called "real-time captioning", which creates captions instantly. Real-time captioning is normally done by professional reporters using a machine shorthand system and computer for translation into English.

Captioning is an effective system for the hearing-impaired, and it can also aid in teaching language skills.

- The picture at left shows a typical caption.

### Caption Tips

- Not all TV broadcasts include closed caption signals.
- Sometimes TV stations broadcast two different caption signals on the same channel. By selecting from CC 1 to CC 4, you can choose which signal you view. CC 1 is usually the signal with the captions, while another mode might show demonstration or programming information.
- Your TV might not receive caption signals normally in the following situations.

1 Poor reception conditions are encountered:



■ **IGNITION:**

Picture may flutter, drift, suffer from black spots or horizontal streaking. Usually caused by interference from automobile ignition systems, neon lamps, electrical drills and other electrical appliances.



■ **GHOSTS:**

Ghosts are caused when the TV signal splits and follows two paths. One is the direct path and the other is reflected off tall buildings, hills or other objects. Changing the direction or position of the antenna may improve reception.



■ **SNOW:**

If your receiver is located at the weak, fringe area of a TV signal, your picture may be marred by small dots. It may be necessary to install a special antenna to improve the picture.

2 An old, bad or illegally recorded tape is played.

3 Strong, random signals from a car or airplane interfere with the TV signal.

4 The signal from the antenna is weak.

5 The program wasn't captioned when it was produced, transmitted or taped.

## Using the Text Function

Text services give a wide variety of information on all kind of subjects (ex. captioned program lists, weather forecasts, stock exchange topics, news for hearing-impaired---) through the full TV screen. But not all stations offer text services, even though they might offer captioning.

**Note:** In the event you receive a poor signal, an empty black box may appear and disappear, even when the text mode is selected. This is a normal occurrence in such an event.

## Operating the Caption and Text

### Using the Caption Button

1. Press the **caption** button.
2. Use the **caption** button to select **Off**, **CC 1~4**, or **Text 1~4**.
3. Press the **enter** (■) button to remove menu.



### Using the Menu

1. Press the **menu** button repeatedly until the menu is displayed as shown to the right.
2. Press the **▶** and then **▲/▼** button to select **Caption**.
3. Use the **◀/▶** button to select **Off**, **CC 1~4**, or **Text 1~4**.
4. Press the **menu** button to remove menu.

**Note:** This TV is programmed to remember which mode it was last set to, even if you turn the TV off.

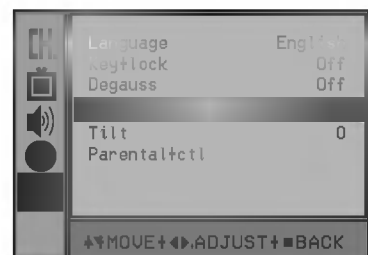

## Parental Control

The Parental Control Function (V-Chip) is used to block program viewing based on the ratings sent by the broadcast station. The default setting is to allow all programs to be viewed. Viewing can be blocked by the type of program and by the categories chosen to be blocked. It is also possible to block all program viewing for a time period. To use the Parental Control Function, the following must be set.

1. Ratings and categories to be blocked.
2. Number of hours to lock the television viewing control
3. Set a password
4. Enable the lock

### **V-Chip rating and categories**

Rating guidelines are provided by broadcast stations. Most television programs and television movies can be blocked by TV Rating and/or Individual Categories.

### **Canadian english language rating system:**

- Exempt
- C (Children)
- C8 and above (8 years and up)
- G (General audience)
- PG (Parental guidance suggested)
- 14 and above (Viewers 14 years and up)
- 18 and above (Adult)

### **Canadian french language rating system:**

- Exempt
- G (General audience)
- 8 and above (8 years and up)
- 13 and above (13 years and up)
- 16 and above (16 years and up)
- 18 and above (Adult)

## Blocking Setup

1. Press the **MENU** button and then use **▲ / ▼** button to select the menu shown to the right.
2. Press the **▶** and then use the **▲ / ▼** button to select **Parental ctrl.**
3. Press the **▶** button.  
If Parental is already set enter the password when requested.
4. Use the **▲ / ▼** buttons to select the types of blocking to be set. Use the **◀ / ▶** buttons to select the types of ratings to block.  
**English**, and/or **French** may be set.
5. Use the **▲ / ▼** buttons to select the **Set hours**.  
Use the **◀ / ▶** buttons to set the number of hours for the blocking. (Up to 99)  
Use the **▲ / ▼** buttons to select the Set password option. Enter a four digit password. Enter it again when requested.  
A new password may be chosen each time blocking is set up.
6. Use the **▲ / ▼** buttons to select the **Lock on/off** menu option. Use the **◀ / ▶** buttons to turn the lock On. Press the menu button to save the blocking setups and exit.



# Antenna Connections

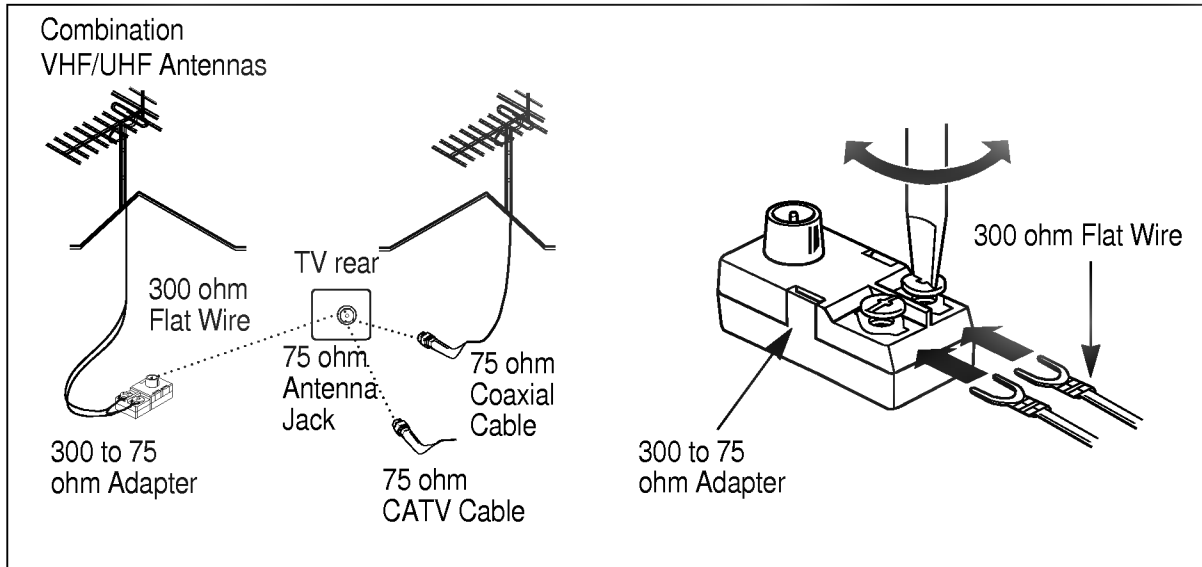

## Connecting an Outdoor Antenna

For the best reception, we recommend you use an outdoor antenna. Severely weathered antennas and antenna cables can reduce the signal quality. Before making any connections, inspect all antenna hardware. Any service center can explain the various outdoor antennas available to you.

### 300 Ohm Flat Wire

1. Connect the 300 ohm flat wire to the screws on the 300 ohm to 75 ohm adapter.
2. Push the end of 300 ohm to 75 ohm adapter onto the 75 ohm antenna jack.

### 75 Ohm Coaxial Cable

1. Connect the 75 ohm coaxial cable directly to the 75 ohm antenna jack.

## Connecting a CATV Cable

If you subscribe to a CATV system, make the antenna connection as described below.

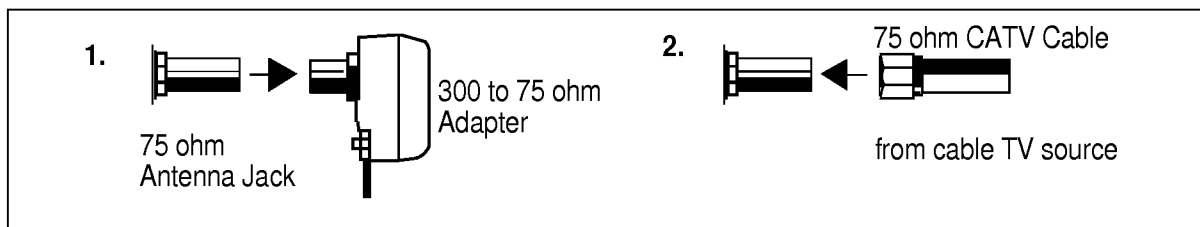

1. Remove the 300 to 75 ohm adapter or the cable from the TV, if attached.
2. Connect the CATV cable (75 ohm coaxial cable) to the 75 ohm antenna jack.

You can connect additional equipment, such as VCRs, camcorders etc. to your TV.  
 Connection panels shown here may be somewhat different from your TV.  
 Here is an example drawing of a typical jackpack layout.

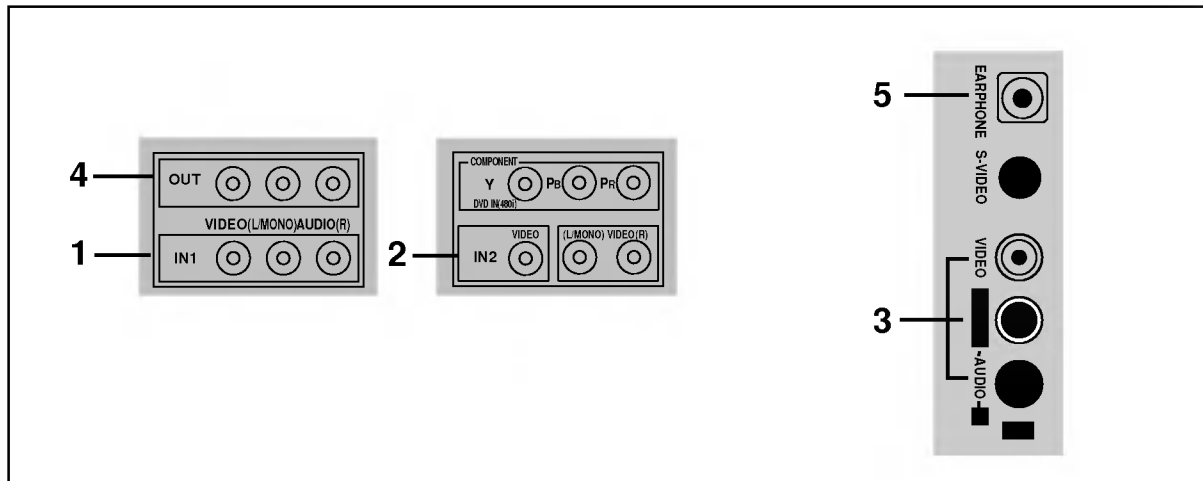

1. **IN 1 JACKS** : Connect external equipment outputs (VCR, LASER DISC, CAMCORDER) to these inputs. Use the **TV/VIDEO** button to select **VIDEO-1**.
2. **IN 2 JACKS** : Connect external equipment outputs (VCR, LASER DISC, CAMCORDER) to these inputs. Use the **TV/VIDEO** button to select **VIDEO-2**.
3. **IN 3 JACKS** : Connect external equipment outputs (VCR, LASER DISC, CAMCORDER) to these inputs. Use the **TV/VIDEO** button to select **VIDEO-3**.
4. **OUT JACKS**: Connect external equipment inputs (VCR, Audio amplifier) to these outputs for recording or monitoring the selected program.
5. **🎧 / EARPHONE JACK**

**Note:** This TV is programmed to remember which mode it was last set to, even if you turn the TV off.

### Connecting AUDIO/VIDEO IN Jacks

1. Connect the audio/video output jacks of the VCR to **IN 1** or **IN 2(A/V)** jacks on the back of TV.  
 If you connect the video jack only, you can't hear the sound from the TV.
2. Use the **TV/VIDEO** button to select **VIDEO-1** or **VIDEO-2**.  
**Note:** If you connect the audio/video output jacks of the VCR to the **IN 3(A/V)** jacks on the side of the TV, select **VIDEO-3**.
3. Press the **PLAY** button on the VCR.  
 The video playback appears on the TV screen.

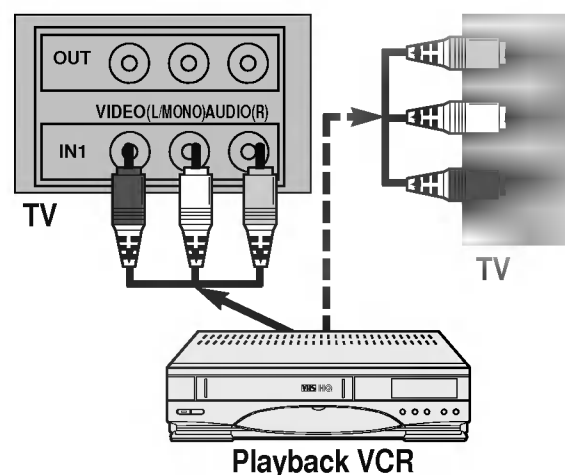

**Note:** In case of MONO VCR, connect the output jack of VCR to the **AUDIO L/MONO IN** jack of TV so that the sound can be heard from both speakers. If you connect it to the **AUDIO R IN** jack of TV the sound is heard only from right speaker.

**Note:** When the input jacks on the front panel and back panel are connected to external equipment at the same time, the input jacks on the front panel have priority over the input jacks on the back panel of the TV.

## S-VHS VCR Connection

1. Connect the S-VHS output jack of the VCR to the **S-VIDEO** jack on the side of the TV.
2. Connect the audio/video output jacks of the VCR to the **IN 3(A/V)** jacks on the side of the TV.
3. Use the **TV/VIDEO** button to select **VIDEO-3**.

**Note:** If you connect the S-VHS/audio output jacks on the VCR to the **S-VIDEO** jack and **IN 1** or **IN 2** audio jacks on the back of the TV, select **VIDEO-1** or **VIDEO-2**.

4. Press the **PLAY** button on the VCR.  
Video playback is visible on the TV screen.

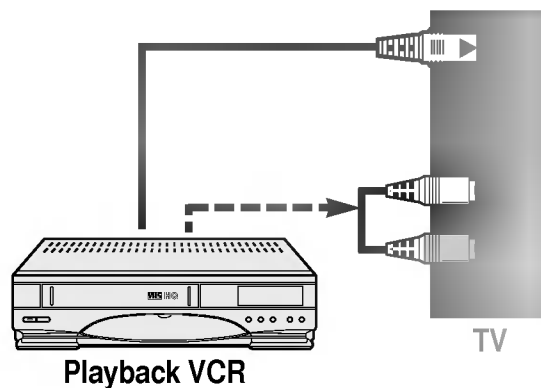

## VCR Recording Setup for TV Programs

1. Connect the audio/video input jacks of the recording VCR to the **OUT (A/V)** jacks on the TV connection panel.
2. Select the channel number on the TV.
3. Set the recording VCR to record.

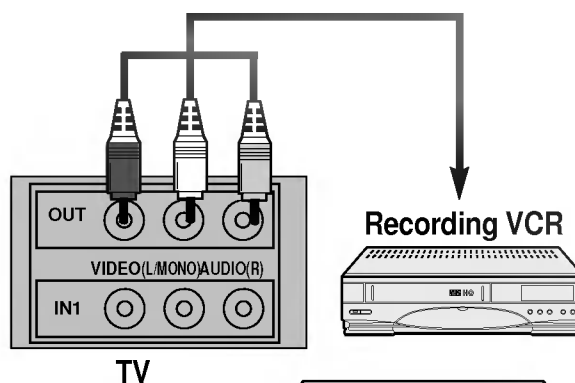

## VCR Recording Setup for a VCR

1. Connect the output jacks of the playback VCR to the **IN 1** or **IN 2 (A/V)** jacks on the back of the TV (or **IN 3** jacks on the side of TV).
2. Connect the input jacks of the recording VCR to the **OUT (A/V)** jacks on the back of the TV.
3. Use the **TV/VIDEO** button to select **VIDEO-1** or **VIDEO-2**.

If you connect it to the **IN 3 (A/V)** jacks on the side of TV, you should select **VIDEO-3**.

4. Press the **PLAY** button on the playback VCR and set the recording VCR to record.

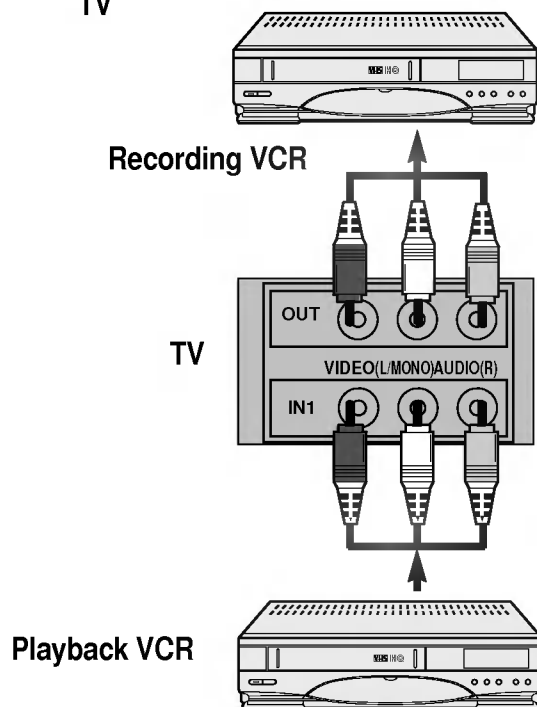

- Connect component video inputs to Y, Pb, Pr(480i) and audio **IN2** to audio(L/R) ports.
- **Note:** This TV is programmed to remember which mode it was last set to, even if you turn the TV off.

## 1. How to connect

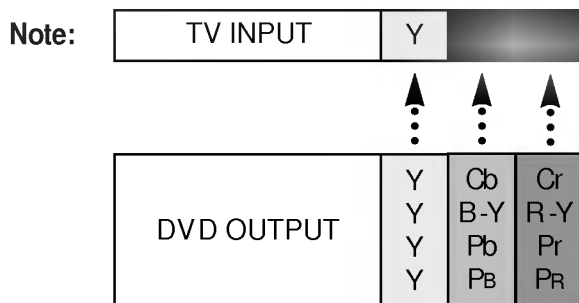
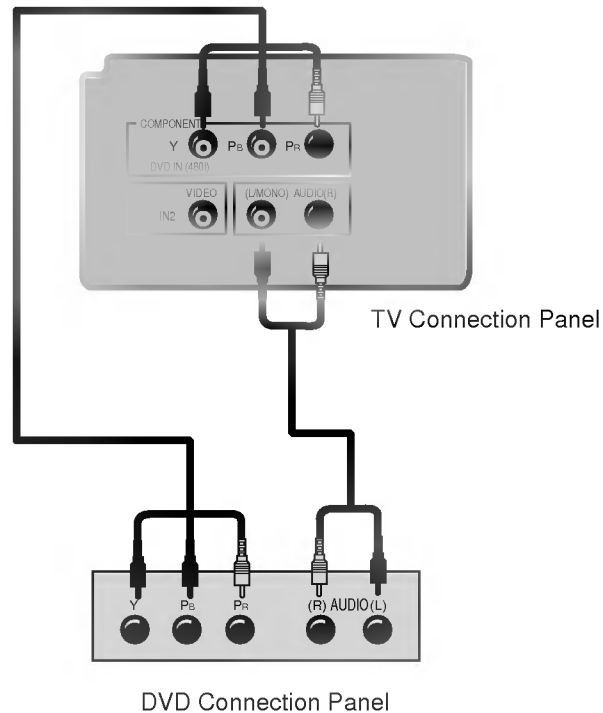

## 2. How to use

- Turn on the DVD.
- Turn the TV on and use the **TV/VIDEO** button on the remote control or **TV/VIDEO** button on the front panel to select **COMPONENT**.
- Press **PLAY** on the DVD, see DVD operation manual.

Early malfunctions can be prevented. Careful and regular cleaning can extend the amount of time you will have with your new TV. Be sure to turn the power off and pull out the plug before you begin any cleaning.

### Screen Cleaning

1. Here's a great way to keep the dust off your screen for a while. Wet a soft cloth in a mixture of lukewarm water and a little fabric softener or dish washing detergent. Wring the cloth until it's almost dry, and then use it to wipe the screen.
2. Make sure the excess water is off the screen, and then let it air-dry before you turn on your TV.

### Cabinet Cleaning

1. Use a soft cloth with a mild soap solution to wipe the cabinet.
2. Rinse the cloth and wipe the cabinet again.
3. Let the cabinet air-dry before turning the TV on.

### Extended Absence



If you leave your TV dormant for a long time (such as a vacation), it's a good idea to unplug the power to protect against possible damage from lightning or power surges. If you use an off-air antenna, you may also want to disconnect it from the back of your TV before leaving.

## Product Specifications

### Model

RU-27FC30	:	Horizontal size (inches)	: 32.7
		Height (inches)	: 23.6
		Thickness (inches)	: 20
		Weight (pounds)	: 116.8

RU-32FC30	:	Horizontal size (inches)	: 35.3
		Height (inches)	: 26.9
		Thickness (inches)	: 21.5
		Weight (pounds)	: 174.2

<b>Power requirements</b>	:	AC 120 V
---------------------------	---	----------

<b>Television system</b>	:	NTSC
--------------------------	---	------

<b>Television channels</b>	:	VHF : 2 ~ 13, UHF : 14 ~ 69
	:	Cable : 01 ~ 125

<b>Power consumption</b>	:	See the back of the set
--------------------------	---	-------------------------

<b>External antenna impedance</b>	:	75 $\Omega$
-----------------------------------	---	-------------

<b>Audio output</b>	:	7W + 7W
---------------------	---	---------

<b>Speaker outputs</b>	:	8 $\Omega$ X 2
------------------------	---	----------------

<b>External input ports</b>	:	Video input ports 3 sets Video output port 1set S-video input port 1set Component input port 1set Earphone jack (1)
-----------------------------	---	---

## SYMPTOMS

No power

No picture or sound

Poor picture but good sound

Poor reception

Lines in picture

Ghosts (multiple images)

Remote control does not work.

Cannot tune desired channel.

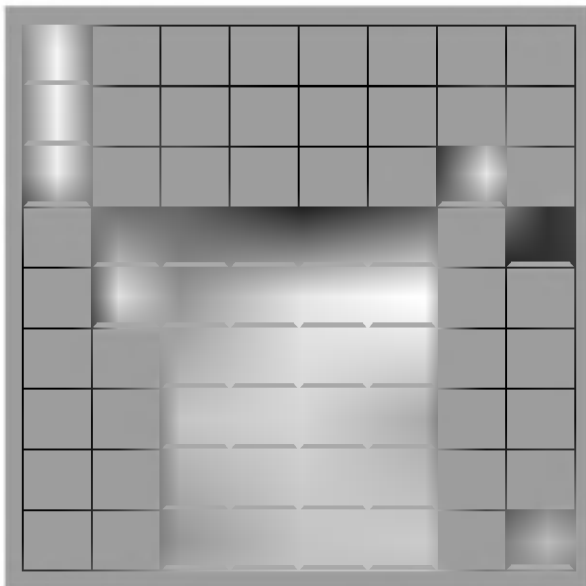

## CHECK THESE THINGS

- Is power cord plugged in?
- Is television turned on?
- Check batteries in remote control.
- Try another channel (station trouble).
- Check antenna connectings.
- Check for local interference.
- Adjust the antenna.
- Adjust the picture control.
- Program channel using AUTO PROGRAM.

## Notes

