



# Washing Machine OWNER'S MANUAL

MODEL : WP-550N/560N

Please read this manual carefully before operating your set.  
Retain it for future reference.

Record model number and serial number of the set.

See the label attached on the back cover and quote this  
information to your dealer when you require service.

This washing machine is designed and manufactured for  
household use only.

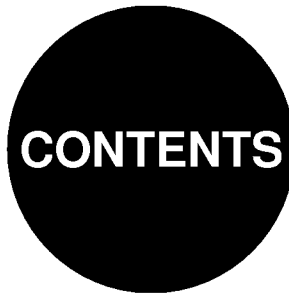





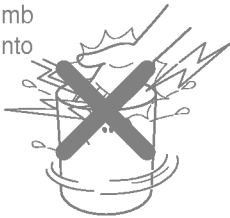

# CONTENTS

GUIDANCE FOR SAFETY AND DURABILITY .....	3
PARTS IDENTIFICATION.....	4~5
SPECIFICATIONS .....	5
INSTALLATION.....	6~8
PREPARATIONS BEFORE WASHING .....	9
HOW TO WASH.....	10
HOW TO RINSE.....	11~12
CARE AND MAINTENANCE.....	13~14
REFERENCE .....	15
TROUBLESHOOTING GUIDE.....	15

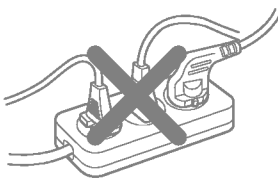
# GUIDANCE FOR SAFETY AND DURABILITY

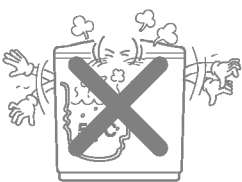
- Manufacturer is not responsible for accidents caused by the user as a result of not following the user's guide.

<p><b>In Operation</b></p> <ul style="list-style-type: none"> <li>● Do not insert hand inside the spin dryer basket while the machine is in operation. (Do not let children climb on to the machine or into the spin dryer basket. Injury may occur.)</li> </ul> 	<p><b>Installation Area</b></p> <ul style="list-style-type: none"> <li>● Avoid installing the machine exposed to snow, rain, or where humidity is high. It may cause electric shock.</li> </ul> 
<p><b>Switch Area</b></p> <ul style="list-style-type: none"> <li>● Avoid getting water on the switch area. It may cause electric shock or fire.</li> </ul> 	<p><b>Electric Outlet</b></p> <ul style="list-style-type: none"> <li>● Avoid connecting several electric devices to a single outlet. It may cause fire.</li> </ul> 
<p><b>Volatile Material</b></p> <ul style="list-style-type: none"> <li>● Do not use volatile materials such as benzene, gasoline, or pesticides. Do not leave strong alkaline substances such as bleach inside the wash tub. It may damage the plastic surfaces and rubber parts.</li> </ul> 	<p><b>Hot Water</b></p> <ul style="list-style-type: none"> <li>● Avoid using hot water higher than 50°C. It may deform the plastic parts or cause malfunction.</li> </ul> 
<p><b>Heat</b></p> <ul style="list-style-type: none"> <li>● Avoid having electric heaters, candles, cigarette lights, etc. near the machine. It may ignite or deform the plastic.</li> </ul> 	<p><b>Power Cord</b></p> <ul style="list-style-type: none"> <li>● If the power supply cord is damaged, it must only be replaced by a repair shop appointed by the manufacturer, because special purpose tools are required.</li> </ul>

# PARTS IDENTIFICATION

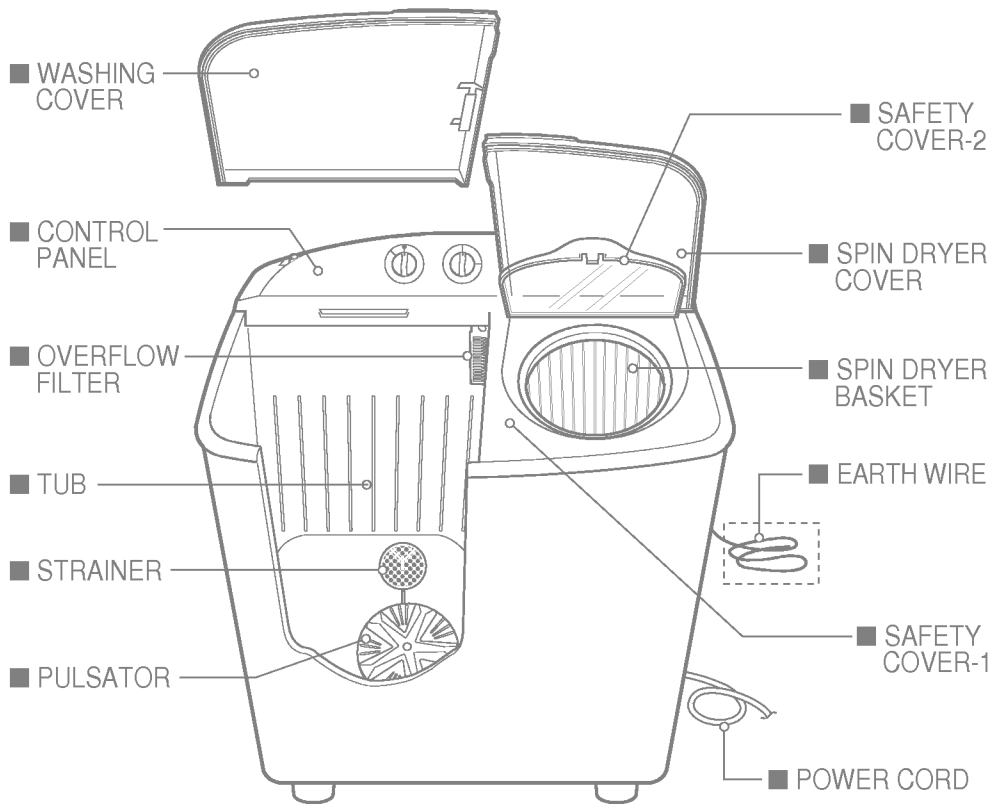

## Accessories



## Control panel

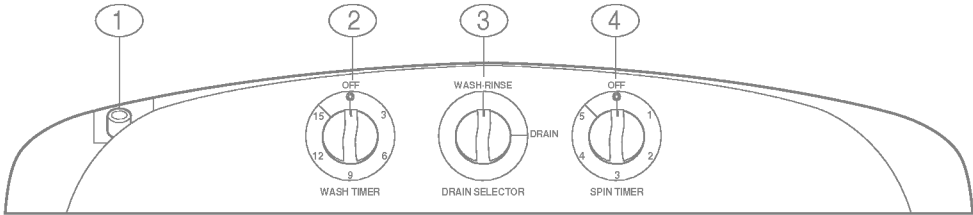

### 1. Water Inlet

Connect the hose from the water faucet to feed water to the tub.

### 2. Wash Timer

Used to select the desired time for washing or rinsing.

### 3. Drain Selector

Select "WASH · RINSE" for washing and rinsing, and "DRAIN" to drain the tub.

### 4. Spin Timer

Used to select the desired time for spinning.

## SPECIFICATIONS

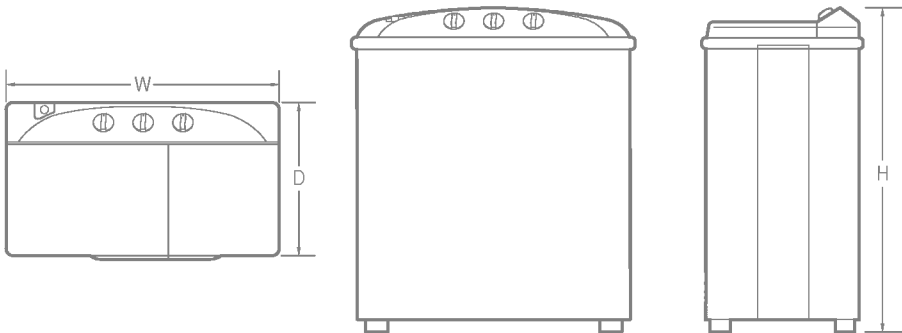

Power source	On SPECIFICATION LABEL
Water level	High : 34 ℓ
Water pressure	Less than 1,000kPa (10kgf/cm <sup>2</sup> )
Dimensions	686 × 412 × 835mm. (W × D × H)
Weight (Net)	17kg

# INSTALLATION

## Installation area

- Select flat and firm floor.
- Incorrect installation may cause severe noise and break down.

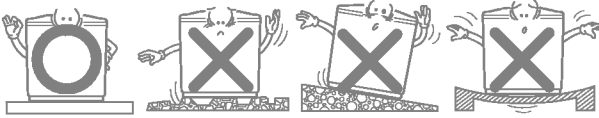

- Maintain more than 10cm between the side of drain hose and the wall.

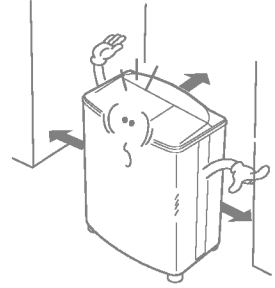

- The base openings must not be obstructed by carpeting when the washing machine is installed on a carpeted floor.

## How to connect the drain hose

**1** Insert the drain hose to the connecting area at the body.

hose while the hose clamp is directed to the top.)

**2** Push the hose clamp to the body to tighten it as shown in the figure.(Push the

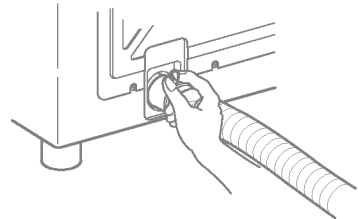
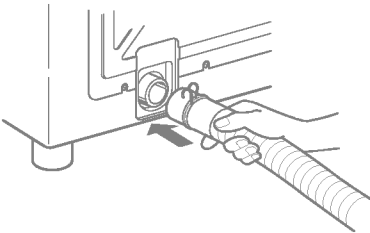

- The hose is placed over doorsill

- Avoid submerging the end of the hose in the water.

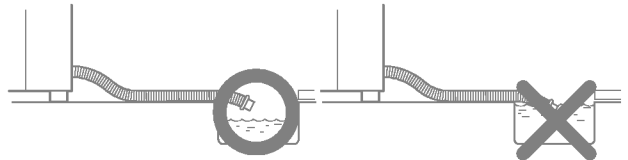
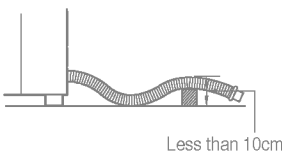

## Connecting the earth wire

- Install the earth wire to prevent short-circuit due to leaking current and electric shock.
- It is attached at the back of the washer. Connect it to the metal water pipe. If the water pipe is made of plastic, it does not have the earth effect.
- Never connect the earth wire to the gas pipe, lightning arrester, telephone connector, etc.

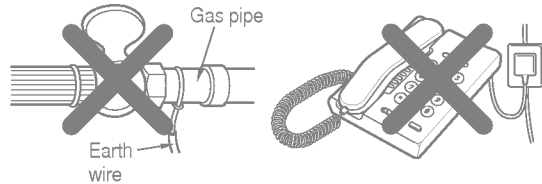

**\* WARNING-THIS APPLIANCE MUST BE EARTHED.**

## Other earthing method

- After connecting the earth wire to the earth copper plate, bury it at least 75cm deep under the wet ground.

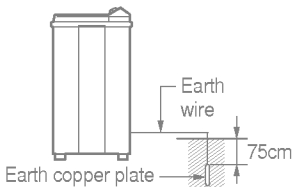

- Connect to the earthing-only outlet.

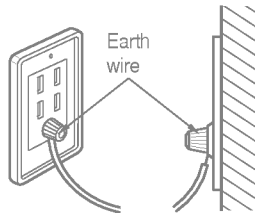

- When installing it in an area where earthing is not possible, purchase a short-circuit breaker (15mA at operation, 7.5mA at idle) and connect it to the outlet.

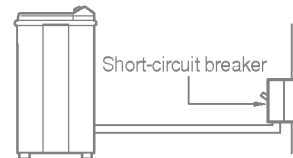

## Connecting the power plug

- Insert the power plug into the outlet.
- Before connecting the power plug, check if the voltage setting of the washer matches the outlet voltage.

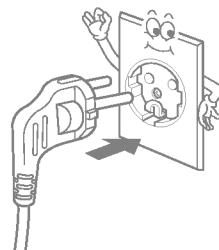

# INSTALLATION

## Voltage change (only for Dual voltage)

- This washer can be adjusted to operate on a power supply of either 110(127) or 220 volts.  
However, in order to avoid the danger of a fire and prevent damage to the washing machine, the voltage setting must match the voltage of your power supply.  
The present voltage is indicated on the label on the back of the washing machine.
- To change the voltage setting, follow the procedure below.
  1. Unplug the power cord from the electric outlet, being sure to take hold of the plug itself.
  2. Use a screwdriver to remove the back cover from the washing machine.
  3. Remove the bag covering the lead wire couplers.
  4. To change the voltage setting from 220V to 110(127)V, disconnect the coupler marked "220V" and connect the coupler marked "110(127)V", to change the voltage setting from 110(127)V to 220V, disconnect the coupler marked "110(127)V" and connect the coupler marked "220V".
  5. Cover the couplers with the bag and reattach the back cover.
  6. Be sure to indicate the new voltage setting on the "Present Voltage" label for future reference.

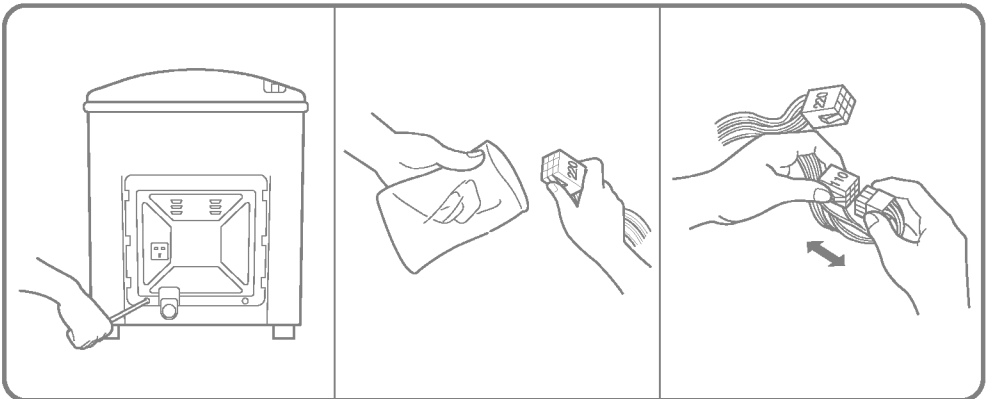

# PREPARATIONS BEFORE WASHING

## Laundry handling

Check pockets for articles.  
(Failure to do so may damage clothes or machine.)



Brush off dust and soil from clothes.



Check label on the clothes for washing instructions.



Wash colored and white clothes separately.



Since bulky and light laundry may float, wash only few at a time. (parka, jumper, etc.)

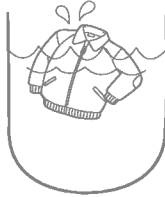

Since stringed or long clothes may cause entanglement tie them up or use separate washing net.

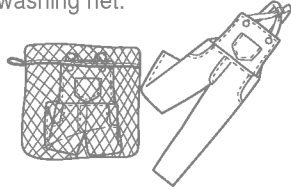

## Washer set-up

**1** Connect the water supply hose.

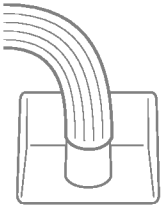

**2** Lower the drain hose.

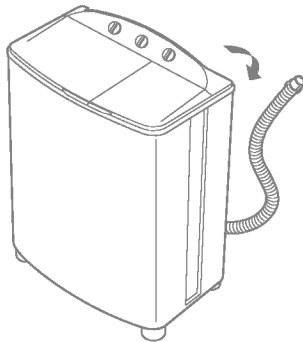

**3** Connect the power plug to the wall outlet.

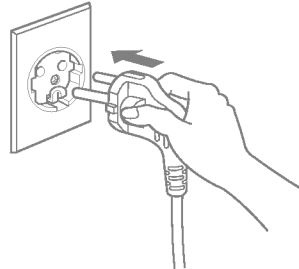

# HOW TO WASH

- 1** Set the drain selector to the "WASH · RINSE" position.



- 2** Open the water faucet and feed water to the water level indicated inside wash tub.

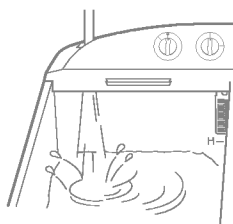

- 3** Put the laundry and detergent into the wash tub.

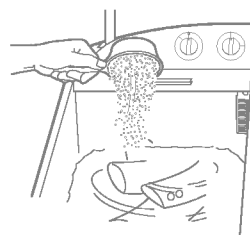

- 4** Set the wash time with the wash timer.

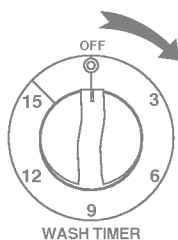

- 5** When washing is finished, select the drain selector to the "DRAIN" position and drain the wash tub.

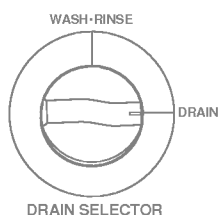

- 6** Rinse according to "HOW TO RINSE" on page 11~12.



- 7** Spinning in the spin dryer basket.

- Put the laundry into the spin dryer basket.
- Place the safety cover horizontally on the laundry.
- Set the desired spin time with the spin timer.



# HOW TO RINSE

## Interim spin rinse

- Interim spin rinse prior to regular rinsing will remove sudsy water from the laundry and improve rinsing efficiency.

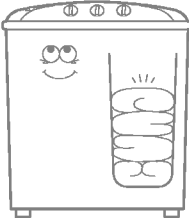
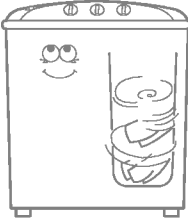
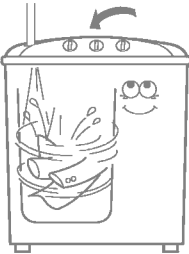
<p><b>1</b> After washing.</p> <ul style="list-style-type: none"><li>● Put the laundry into the spin dryer basket.</li><li>● Place the safety cover horizontally on the laundry.</li></ul> 	<p><b>2</b> Set the desired spin time with the spin timer.</p> 	<p><b>3</b> After spinning.</p> <ul style="list-style-type: none"><li>● Put the laundry into the wash tub and rinse.</li></ul> 
--	--	--

## Economical water supply rinse

- This course allows you to save water as this course is to rinse after feeding appropriate water to the tub.

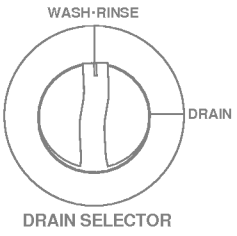
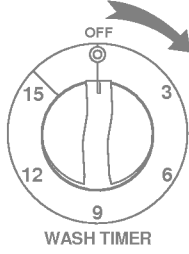
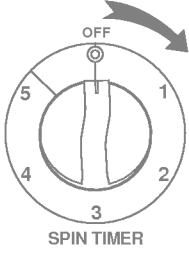
<p><b>1</b> Set the drain selector to "WASH · RINSE" position and feed appropriate water to the tub.</p>  <p>DRAIN SELECTOR</p>	<p><b>2</b> Set the rinse time with the wash timer</p>  <p>WASH TIMER</p>	<p><b>3</b> Put the laundry into the spin dryer basket and set the spin time with the spin timer.</p>  <p>SPIN TIMER</p>
--	--	---

## Continuous water supply rinse

■ This course is to rinse while feeding water continuously.

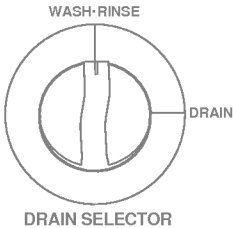
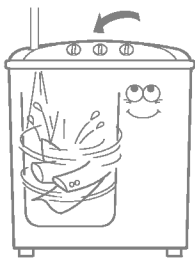
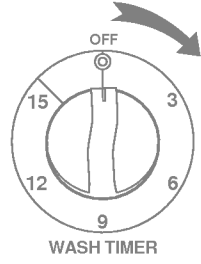
<p><b>1</b> Set the drain selector to "WASH · RINSE" position.</p> 	<p><b>2</b> Put the laundry into the wash tub and open the water faucet.</p> 	<p><b>3</b> Set the rinse time with the wash timer and feed water continuously.</p> 
--	--	--

## Precautions for spinning

- Put the laundry evenly into the spin dryer basket.
- Place the safety cover horizontally on the laundry.
- Close the spin dryer cover and perform spinning.

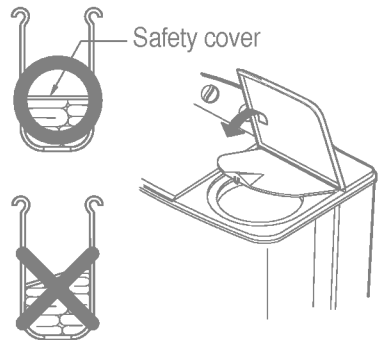

## Spin time guide

Kinds of laundry	Spin time
Thin fabrics (Synthetic fabrics, Mixed fabrics)	1~2 min.
Sweaters (Synthetic fabrics)	2~3 min.
Cotton underwear	3~5 min.
Sheets, Towel	5 min.

# CARE AND MAINTENANCE

- Be sure to disconnect the power cord from the electric outlet before starting care and maintenance.

## Washing machine

- If the washing machine itself becomes dirty.
- The washing machine can be cleaned with a mild liquid detergent. Never use abrasive cleanser or chemicals such as benzene or thinner to clean the washing machine, because these materials will damage both the painted surfaces and the plastic parts.

## Pulsator

- If a button or some other object gets caught in the pulsator.
1. Use a screwdriver to loosen the screw in the center of the pulsator, and lift the pulsator straight up in order to remove the button or other object.
  2. Reposition the pulsator and retighten the screw. Be sure to tighten the screw all the way down into the hole so that it does not protrude, or it will damage the clothing during washing.

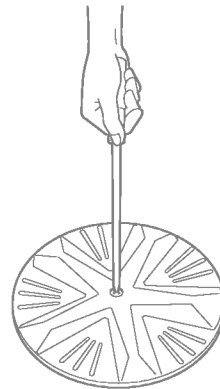

## Overflow filter

1. Pull the overflow filter forward from the wash tub in the direction of the arrow.
2. Remove dirt by using tooth brush, etc., and then insert overflow filter back into the wash tub.

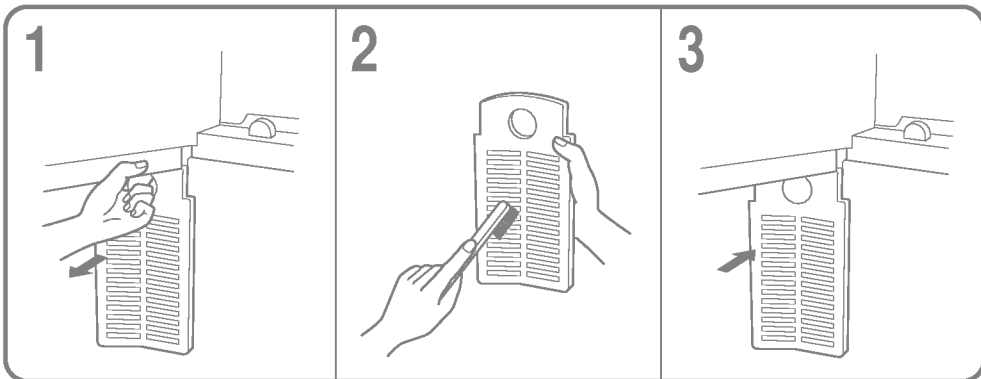

# CARE AND MAINTENANCE

## Strainer

1. Separate the strainer from the wash tub by using the tip of the screwdriver.
2. Remove dirt by using tooth brush, etc., and then insert strainer back into the wash tub.

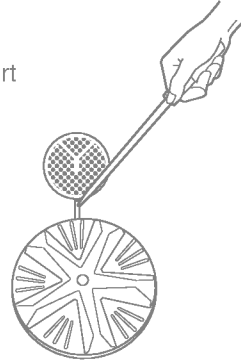

## Lint in dryer basket

- If clothing becomes trapped between the spin dryer basket and the outer spin tub.
1. Take hold of the front of the safety cover-1 and pull it upward.
  2. Remove the article of clothing.
  3. Close the safety cover-1, pressing down on it so that it fits securely into the outer spin tub.

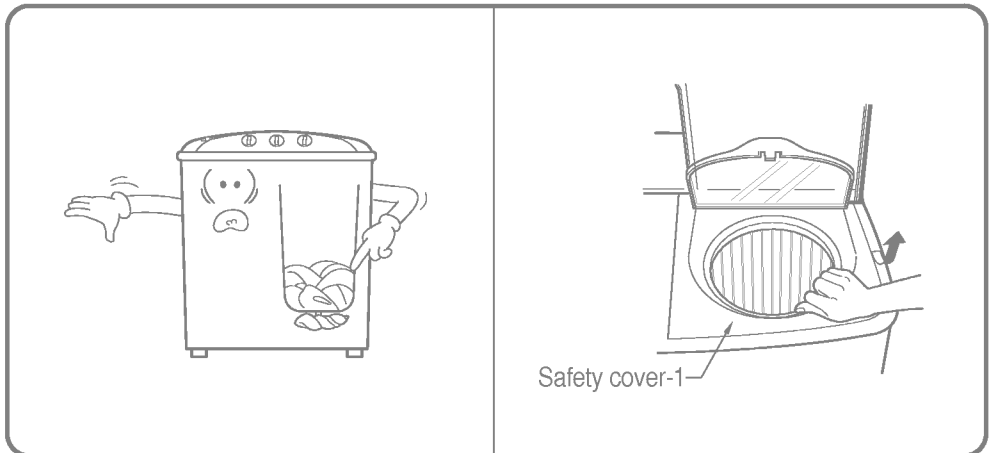

# REFERENCE

**TABLE 1. WEIGHT GUIDE FOR CLOTHES**

Type of clothing	Type of fabric	Weight per piece
Under shirt	Cotton	150g
Handkerchief	Cotton	50g
Bath towel	Cotton	300g
Shirt	Mixed fabric	200g
Socks (1 pair)	Mixed fabric	60g
Pajama (shirt and pants)	Cotton	500g
Winter undershirt	Cotton	600g
Work clothes	Mixed fabric	800g
Blouse	Mixed fabric	200g

**TABLE 2. GUIDE FOR WASHING**

Water level	Amount of water	Amount of detergent
H	34 ℓ	34g

## NOTES

- Amount of laundry is a weight of dry laundry.
- Detergent is a general synthetic detergent.

# TROUBLESHOOTING GUIDE

## Before Requesting Service

Troubles	Checking points
Motor does not operate.	<ul style="list-style-type: none"> <li>• Is the power cord firmly plugged in?</li> <li>• Is the timer turned to a suitable point except "OFF"?</li> </ul>
Spin dryer basket does not operate.	<ul style="list-style-type: none"> <li>• Is there any cloth dropped between the basket and tub?</li> <li>• Is the spin dryer cover closed?</li> <li>• Is the laundry gathered to one side of spin basket?</li> </ul>
No draining	<ul style="list-style-type: none"> <li>• Is the lint stuck to the plunger valve?</li> <li>• Is not the end of the drain hose guide located at a excessive height?</li> </ul>

