



# Washing Machine

## OWNER'S MANUAL

With Drain Pump

**MODELS : WP-1100QP/1130QP**

**WP-1100GP/1130GP**

**WP-1100NP/1130NP**

Please read this manual carefully before operating your set.  
Retain it for future reference.

Record model number and serial number of the set.  
See the label attached on the back cover and quote this  
information to your dealer when you require service.

This washing machine is designed and manufactured for  
household use only.



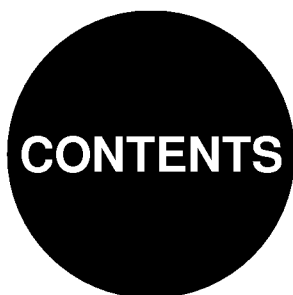

# CONTENTS

SAFETY MEASURE.....	3~4
PARTS IDENTIFICATION.....	4~5
INSTALLATION.....	6~7
PREPARATIONS BEFORE WASHING .....	8
HOW TO WASH.....	9
HOW TO RINSE.....	10~11
HOW TO SPIN .....	11
AFTER FINISHING .....	12
REFERENCE .....	12
CARE AND MAINTENANCE.....	13~14
TROUBLESHOOTING GUIDE.....	14
SPECIFICATIONS .....	15

# SAFETY MEASURE

- Manufacturer is not responsible for accidents caused by the user as a result of not following the user's guide.

## WARNING

### In Operation

- Do not insert the hand inside the spin dryer basket while the machine is in operation.  
(Do not let children climb on the machine or climb into the tub. Injury may occur.)



### Installation Area

- Avoid area exposed to snow, rain, or where humidity is high. It may cause electric shock.



### Switch Area

- Avoid watering on the switch area. It may cause electric shock or fire.



### Spin Motor

- After continuous using spinning program 3 times, please stop spinning more than 1 hour. Otherwise the spin motor could be damaged or fired.

### Volatile Material

- Do not use volatile material such as Benzene, Gasoline, bug killer. Do not leave strong alkaline substance such as bleach inside the tub. Damage on plastic surface and rubber parts may occur.



### Heat

- Avoid electric heater, candle light, cigarette light, bug smoker, etc. near the machine. It may ignite or deform plastic part.



### Power Cord

- If the power supply cord is damaged, it must only be replaced by the manufacturer or its service agent or a similarly qualified person in order to avoid a hazard.

### Electric outlet

- Avoid connecting several electric devices to single outlet. It may cause fire.

## ⚠ CAUTION

### Hot water

- Avoid using hot water over 50 °C. It may deform plastic parts or cause malfunction.



### Installation

- Install the washing machine on a horizontal support. Otherwise, it may cause vibration and noise.



### Power Cord

- Do not treat the power supply cord with your wet hand.

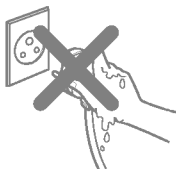

- Plug out the power supply cord, When cleaning or not using the washing machine for a long time.



# PARTS IDENTIFICATION

## Control Panel

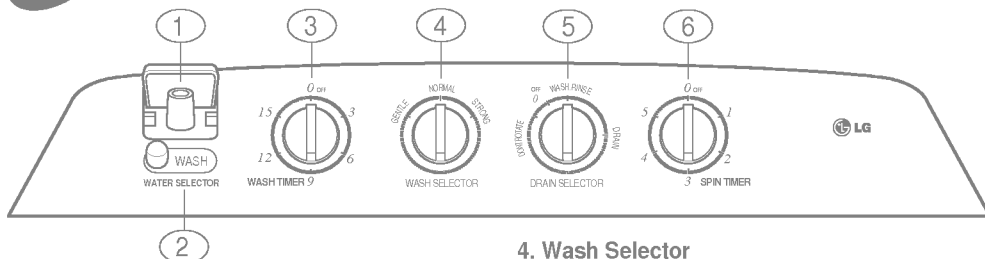

### 1. Water Supply Inlet

Connect here with the inlet hose from the water faucet to feed water to the tub.

### 2. Water Selector

Select "WASH" to supply water for washing and rinsing and "SPIN" for spin shower rinse.

### 3. Wash Timer

Select the desired time for washing or rinsing.

### 4. Wash Selector

Set the selector to "GENTLE", "NORMAL", "STRONG" according to kinds and quantity of the laundry.

### 5. Drain Selector

Select "WASH-RINSE" for washing and rinsing, and "DRAIN" to drain the water out of the tub, and "OFF" to turn off the drain pump.

### 6. Spin Timer

Select the desired time for spinning. The max. limit is 5 min. Don't rotate the knob more than prescribed limit.

# PARTS IDENTIFICATION

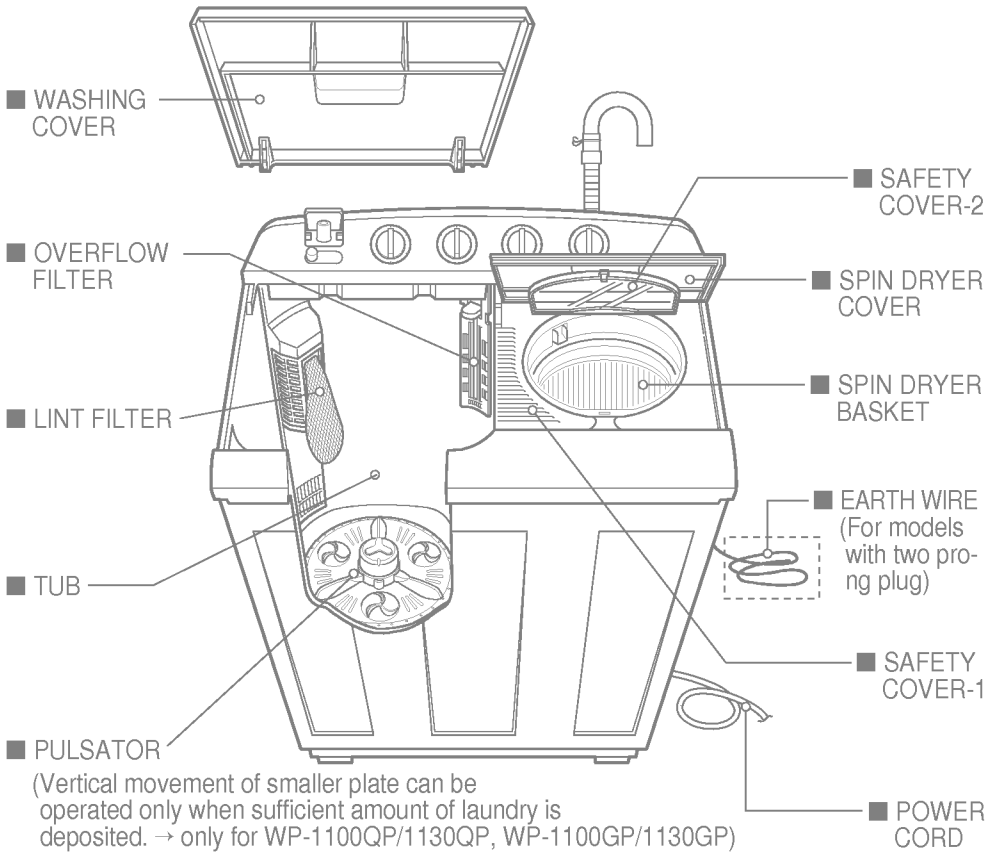

## Accessories

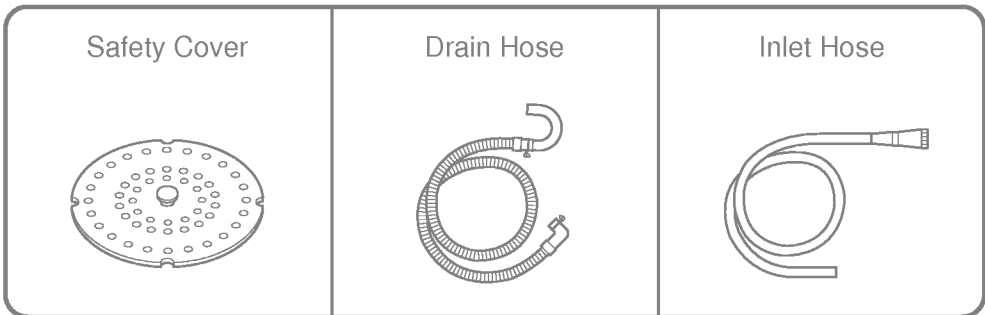

# INSTALLATION

## Installation area

- Select flat and firm floor.
- Incorrect installation may cause severe noise and break down.
- Maintain more than 10cm between the side of drain hose and the wall.

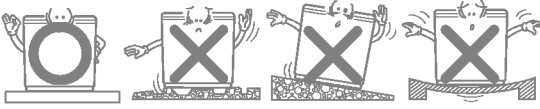

- The base openings must not be obstructed by carpeting when the washing machine is installed on a carpeted floor.

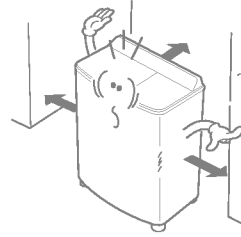

## Connect The Drain Hose

- Connect the drain hose to the outlet of the plunger valve located at the back side of the washing machine.
- Push the clamp toward the body of the washing machine as in the figure.

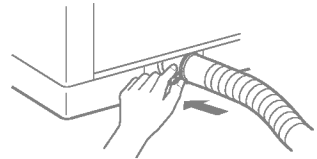
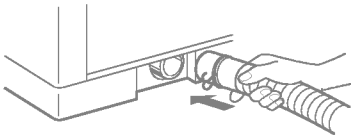

## Voltage Change (only for dual voltage)

This washer is assembled for 220V, but can be changed from 220V to 110V(or 127V). Check your electrical source and follow the diagram below to convert voltage.

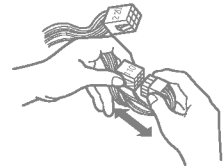
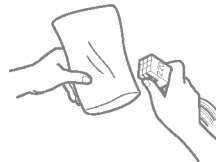
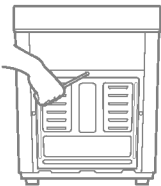

## Connecting the earth wire

- Install the earth wire to prevent short-circuit due to leaking current and electric shock.
- It is attached at the back of the washer. Connect it to the metal water pipe. If the water pipe is made of plastic, it does not have the earth effect.
- Never connect the earth wire to the gas pipe, lightning arrester, telephone connector, etc.

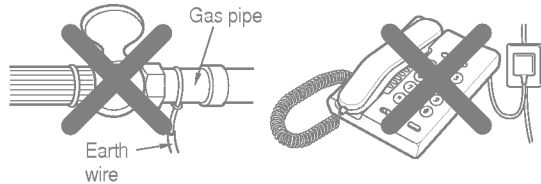

**\* WARNING-THE APPLIANCE WITH TWO PRONG PLUG MUST BE GROUNDED.**

## Other earthing method

- After connecting the earth wire to the earth copper plate, bury it at least 75cm deep under the wet ground.

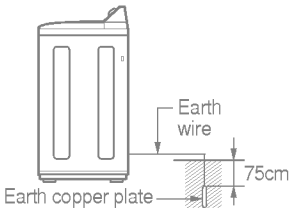

- Connect to the earthing-only outlet.

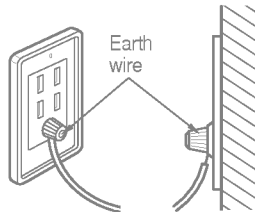

- When installing it in an area where earthing is not possible, purchase a short-circuit breaker (15mA at operation, 7.5mA at idle) and connect it to the outlet.

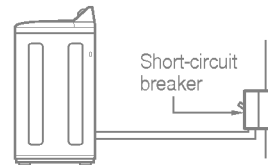

## Connecting the power plug

- Insert the power plug into the outlet.
- Before connecting the power plug, check if the voltage setting of the washer matches the outlet voltage.
- If AC outlet with ground terminal is used, grounding is not needed. If not, never forget earthing (earthing method above).
- The appliance must be positioned so that the plug is accessible.

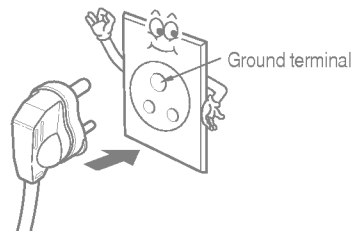

# PREPARATIONS BEFORE WASHING

## Preparation

- Connect the water supply hose to the water supply inlet.

- Set the supply selector lever to "WASH" for washing and rinsing, to "SPIN" for interim spin rinse.

- Note : The water selector lever should not be placed near the center (as shown in Fig (A) ) otherwise water flows to the wash and spin tub simultaneously.)



( Fig A )

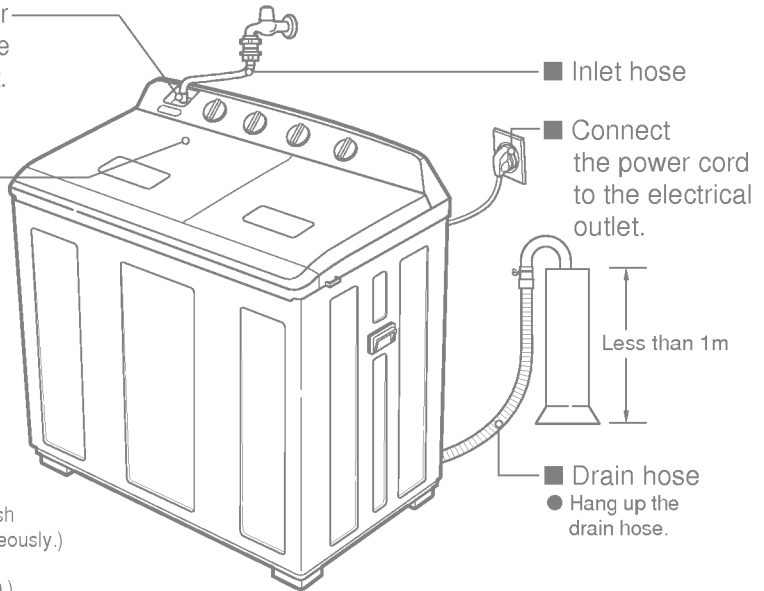

## Before washing

- 1** Check the washing instructions labels on the clothing to be washed.



- 2** Remove any objects from the pockets of the clothing. Object left in the pockets may damage the clothing or washing machine (especially cause clogging of the drain hose).

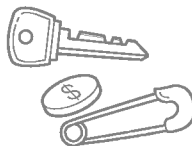

- 3** After separating an oiled or dyed laundry, wash.

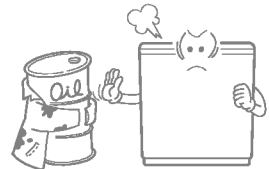

**1** Set the drain selector to "O(OFF)" position.

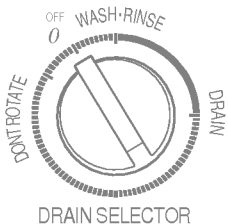

**2** Set the water selector to "WASH".



**3** Open the water tap and fill water in the wash tub about halfway to the desired water level.

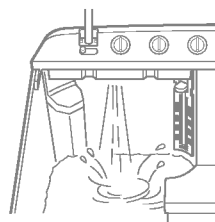

**4** Put the appropriate amount of detergent and the laundry into the wash tub. And add water to the desired water level.

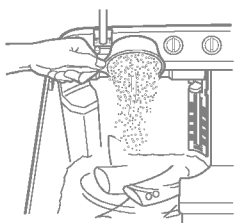

● Refer to TABLE 2 in REFERENCE on page 12.

**5** Select the wash selector to "GENTLE", "NORMAL", "STRONG" according to kinds and quantity of the laundry.

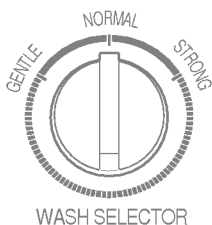

● Refer to TABLE 2 in REFERENCE on page 12

**6** Set the desired wash time.

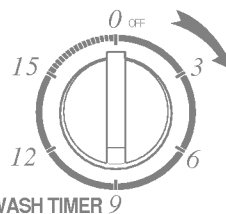

● Refer to TABLE 2 in REFERENCE on page 12 for information on how to select the appropriate washing time.

**7** When washing is finished, select the drain selector to "DRAIN" position and drain the water out.

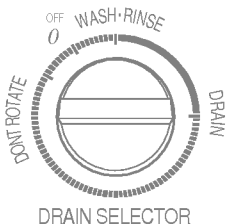

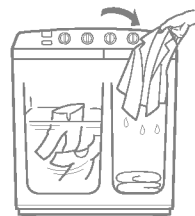

**8** Spinning in the spin dryer basket.  
● Put the laundry into the spin dryer basket.  
● Put the laundry down lightly.  
● Place the safety cover horizontally on the laundry.  
● Set the desired spin time with the spin timer.



# HOW TO RINSE

## Interim spin rinse

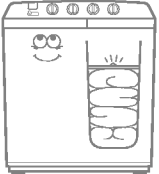
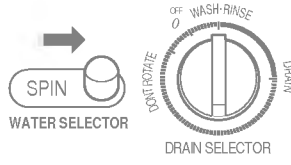
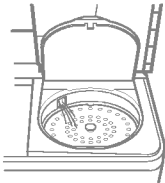
■ Interim spin rinse prior to regular rinsing will remove sudsy water from the laundry and improve rinsing efficiency.

<p><b>1</b> After washing.</p> <ul style="list-style-type: none"> <li>Put the laundry into the spin dryer basket.</li> <li>Place the safety cover horizontally on the laundry.</li> </ul> 	<p><b>2</b> Set the water selector to "SPIN"</p> <ul style="list-style-type: none"> <li>Set the drain selector to "WASH · RINSE" position.</li> </ul> 	<p><b>3</b> Allow the water to flow appropriately.</p> <p><b>4</b> Turn off the water supply, close the safety cover-2 and spin dryer cover</p> 
<p><b>5</b> Set the desired spin time with the spin timer.</p> 	<p><b>6</b> After spinning.</p> <ul style="list-style-type: none"> <li>Put the laundry into the wash tub and rinse.</li> </ul> 	

## Economical water supply rinse

■ This course allows you to save water as this course is to rinse after feeding appropriate water to the tub.

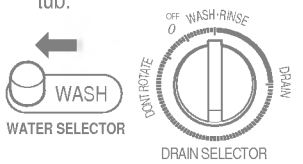
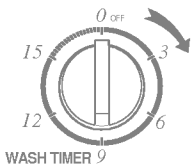
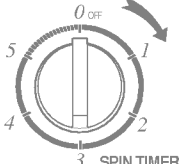
<p><b>1</b> Set the drain selector to "WASH · RINSE" position and feed appropriate water to the tub.</p> 	<p><b>2</b> Set the rinse time with the wash timer</p> 	<p><b>3</b> Put the laundry into the spin dryer basket and set the spin time with the spin timer.</p> 
<p><b>4</b> Put the laundry into the wash tub and repeat 1 to 3 course.</p>		

## Continuous water supply rinse

This course is to rinse while feeding water continuously.

**1** Set the drain selector to "WASH · RINSE" position.

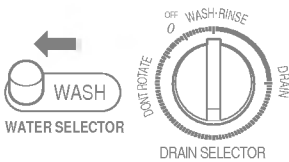

**2** Put the laundry into the wash tub and open the water faucet.

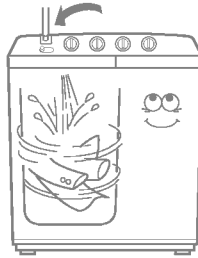

**3** Set the rinse time with the wash timer and feed water continuously.

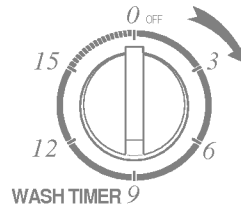

1. Put the laundry evenly into the spin dryer basket.
2. Put the laundry down lightly.
3. Place the safety cover horizontally on the top of the laundry.
4. Close the spin dryer cover.
5. Set the spin timer according to the following table.

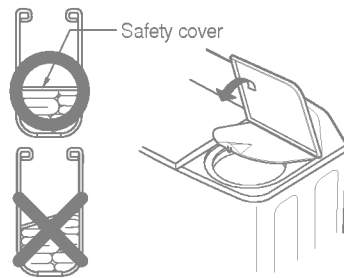

Type of clothing	Spin time
Thin fabrics (synthetic fabrics, mixed fabrics)	1 minute
Sweaters (synthetic fabrics)	1~3 minutes
Cotton underwear	3~5 minutes
Sheets, towels	5 minutes

- If the spin dryer basket is off-balance and vibrates excessively, stop the spinning, rearrange the clothes evenly, and then resume spinning.
- Should spinning fail to stop within 15 seconds after the spin dryer cover is opened, the brake is out of order. Immediately stop using the machine and request repair service.

# AFTER FINISHING

1. Remove the laundry from the spin dryer basket and close the spin dryer cover.
2. If there is water in the wash tub, set the drain selector to "DRAIN" in order to drain it out, and then put it back to "OFF".
3. Disconnect the power cord from the electrical outlet.
4. Clean the washing machine. (Refer to CARE AND MAINTENANCE on page 13~14.)
5. Ensure without fail the Drain Selector is turned to "OFF" position after using the machine.

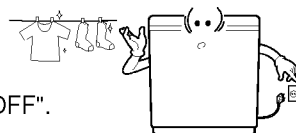

# REFERENCE

**TABLE 1. WEIGHT GUIDE FOR CLOTHES**

Type of clothing	Type of fabric	Weight per piece
Under shirt	Cotton	150 g (5.3 OZ)
Handkerchief	Cotton	50 g (1.8 OZ)
Bath towel	Cotton	300 g (10.6 OZ)
Shirt	Mixed fabric	200 g (7.1 OZ)
Socks (1 pair)	Mixed fabric	50 g (1.8 OZ)
Pajama (shirt and pants)	Cotton	500 g (17.6 OZ)
Winter undershirt	Cotton	600 g (21.2 OZ)
Workclothes	Mixed fabric	800 g (28.2 OZ)
Blouse	Mixed fabric	200 g (7.1 OZ)

**TABLE 2. GUIDE FOR WASHING**

Water Level	Wash Load	Type of fabric	Wash selector	Wash time	Detergent volume
"S"(43 ℓ)	0.5~4.5kg (1.1~9.9 lb)	Synthetics, silk, Woolen knits	GENTLE	2~5 minutes	40~45g (1.4~1.6 OZ)
		Cotton, linen	NORMAL	5~10 minutes	
		Very soiled cotton and linen	STRONG	10~15 minutes	
"L"(50 ℓ)	4.5~5.5kg (9.9~12.1 lb)	Synthetics, silk, Woolen knits	GENTLE	2~5 minutes	48~52g (1.7~1.8 OZ)
		Cotton, linen	NORMAL	5~10 minutes	
		Very soiled cotton and linen	STRONG	10~15 minutes	
"M"(58 ℓ)	5.5~6.5kg (12.1~14.3 lb)	Synthetics, silk, Woolen knits	GENTLE	2~5 minutes	56~60g (2.0~2.1 OZ)
		Cotton, linen	NORMAL	5~10 minutes	
		Very soiled cotton and linen	STRONG	10~15 minutes	
"H"(67 ℓ)	6.5kg~ (14.3 lb~)	Synthetics, silk, Woolen knits	GENTLE	2~5 minutes	65~70g (2.3~2.5 OZ)
		Cotton, linen	NORMAL	5~10 minutes	
		Very soiled cotton and linen	STRONG	10~15 minutes	

- Notes :**
- When the wash load and the water volume are not matched, damage to clothing and splashing of water may occur.
  - The volume of washable clothes varies depending on types, size and the thickness of material. Make the adjustment required by carefully watching the movement of clothes in the wash tub.

# CARE AND MAINTENANCE

- Be sure to disconnect the power cord from the electric outlet before starting care and maintenance.

## Washing machine

If the washing machine itself becomes dirty.

- The washing machine can be cleaned with a mild liquid detergent. Never use abrasive cleanser or chemicals such as benzene or thinner to clean the washing machine, because these materials will damage both the painted surfaces and the plastic parts.

## Pulsator

- If a button or some other object gets caught in the pulsator.
  1. Take out the pulsator cap with "-" type driver(only for WP-1100QP/1130QP, WP-1100GP/1130GP)
  2. Use a screwdriver to loosen the screw in the center of the pulsator, and lift the pulsator straight up in order to remove the button or other object.
  3. Replace the pulsator and tighten the screw.
  4. Replace the pulsator cap.

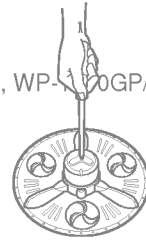

## Overflow Filter

1. Detach the overflow filter by pulling in the direction indicated by the arrow.
2. Use a brush or your hand to remove all of the lint which has adhered to the overflow filter, being careful not to exert excessive force on the hose attached to the overflow filter.
3. Re-attach the overflow filter by fitting the bottom of the overflow filter frame into the opening and then press in the direction indicated by the arrow.

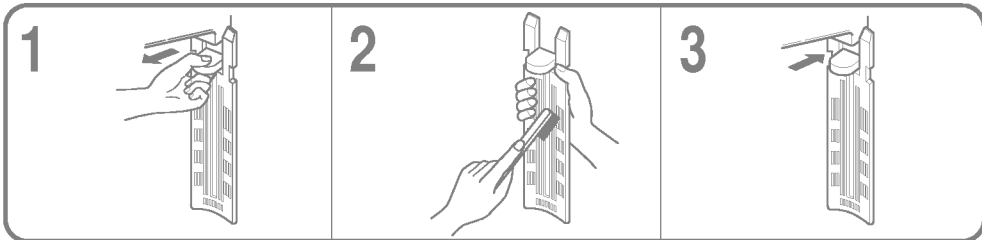

## Lint Filter

- Remove the lints or pieces of clothes fixed to lint filter by pulling it, and turn the net over and rinse in water. After cleaning, replace the lint filter.

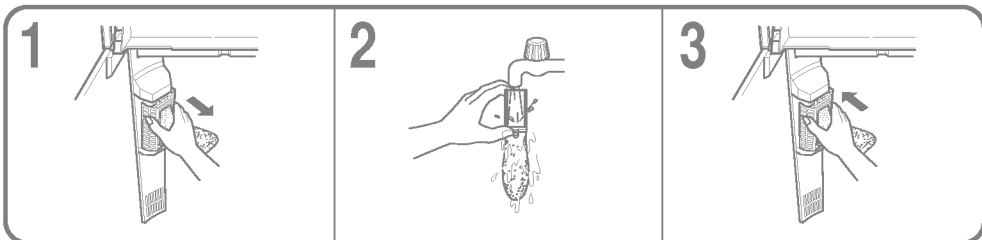

# CARE AND MAINTENANCE

## in dryer basket

- If clothing becomes trapped between the spin dryer basket and the spin tub.
  1. Take hold of the front of the safety cover-1.
  2. Pull the tub by the other hand.
  3. Pull the safety cover-1 upward.
  4. Remove the article of clothing.
  5. Close the safety cover-1, pressing down on it so that it fits securely into the spin tub.

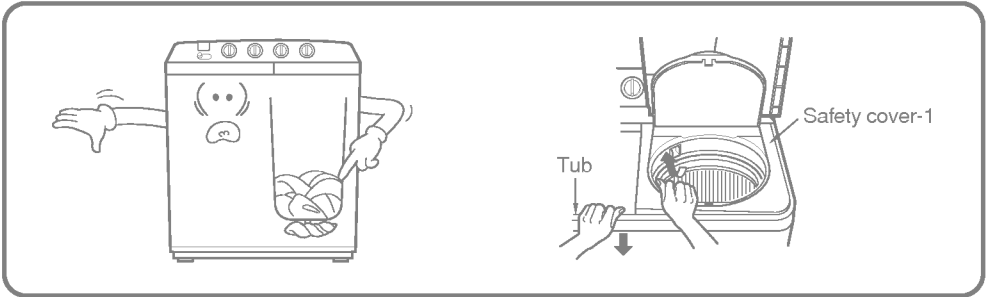

# TROUBLESHOOTING GUIDE

## Before Requesting Service

Troubles	Checking points
<b>Motor does not operate.</b>	<ul style="list-style-type: none"> <li>● Is the power cord firmly plugged in?</li> <li>● Is the timer turned to a suitable point except "OFF"?</li> </ul>
<b>Spin dryer does not operate.</b>	<ul style="list-style-type: none"> <li>● Is there any cloth dropped between the basket and tub?</li> <li>● Is the spin dryer cover closed?</li> <li>● Is the laundry gathered to one side of spin basket?</li> </ul>
<b>No draining.</b>	<ul style="list-style-type: none"> <li>● Is the lint stuck to the plunger valve?</li> <li>● Is not the end of the drain hose guide located at a excessive height?</li> <li>● Is the drain pump operated?</li> </ul>

# SPECIFICATIONS

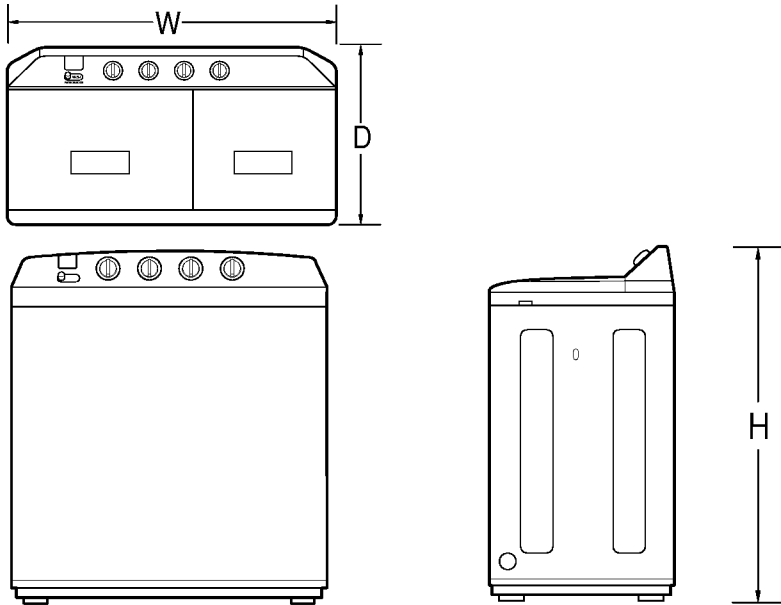

Power source	On SPECIFICATION LABEL
Water level	H: 67 l M: 58 l L: 50 l S: 43 l
Water Pressure	Less than 100kPa (1kgf/cm <sup>2</sup> )
Dimensions	850 × 530 × 1011mm. (W × D × H)
Weight (Net)	42kg

- How to read the manufactured month and year from the label stuck on the back of the product.

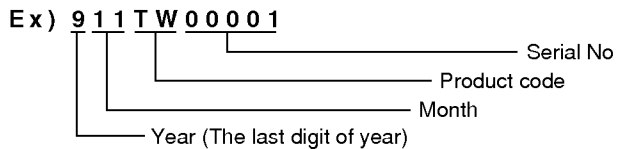

- Main service parts list :  
Refer to below listed parts name when you need service call.

Part name	Remark
-WASH MOTOR	105W
-SPIN MOTOR	105W
-S.D. BASKET	PLASTIC
-CYCLE TIMER ASM	
-CAPACITOR	
-GEAR CASE ASM	

