



**MALAY**  
**ENGLISH**

# Telefon WAP

**BUKU PANDUAN PENGGUNA**

**MODEL : W3000**

Sila baca buku panduan ini dengan teliti sebelum menggunakan telefon anda. Simpan ia untuk rujukan pada masa hadapan.





# Telefon WAP

## **BUKU PANDUAN PENGGUNA**

### **MODEL: W3000**

Sila baca buku panduan ini dengan teliti sebelum menggunakan telefon anda. Simpan ia untuk rujukan pada masa hadapan.



**W3000 mempunyai gaya yang memberikan pengguna lebih keselesaan dan kemudahan.**



## Untuk Keselamatan Anda

Semua pemancar radio membawa risiko gangguan dengan barangan elektronik yang berdekatan.



Telefon-telefon GSM mestilah sentiasa dimatikan di dalam kapal terbang.



Jangan aktifkan berdekatan dengan stesen minyak, depo bahan bakar, loji kimia atau operasi peletupan.



Matikan semasa di hospital: alat perubatan elektronik, misalnya perentak jantung dan alat bantuan pendengaran boleh terjejas.



Sedikit gangguan mungkin menjejaskan TV, radio, PC, dan lain-lain.



Jangan pegang telefon di dalam tangan semasa memandu.



Jangan buka telefon atau bateri.



Simpan telefon di tempat selamat dari kanak-kanak kerana barang kecil menyebabkan bahaya.



Jangan sentuh pengecas dengan tangan basah.



Gunakan hanya bateri dan pengecas yang ditentukan kerana bateri dan pengecas lain boleh merosakkan telefon.

### Sila ambil perhatian:



Bateri yang tidak boleh digunakan harus dibuang menurut undang-undang yang berkenaan.



Gunakan hanya aksesori ASLI bagi mengelakkan kerosakan pada telefon anda.



Sesetengah khidmat di dalam buku panduan ini tidak disokong oleh semua rangkaian.

### Maklumat Penting

Panduan pengguna ini mengandungi maklumat penting mengenai penggunaan dan operasi telefon ini. Sila baca semua maklumat dengan teliti untuk prestasi optimum dan untuk mengelakkan sebarang kerosakan atau penyalahgunaan telefon ini. Sebarang perubahan atau pengubahsuaian yang tidak diluluskan secara nyata di dalam panduan pengguna ini boleh mentaksahkan waranti anda untuk alat ini.

# Contents

## Gambaran keseluruhan

<b>Aksesori</b> .....	<b>9</b>
<b>Bahagian Telefon</b> .....	<b>10</b>
• Bahagian Depan Telefon .....	10
• Bahagian Belakang Telefon .....	11
<b>Penerangan Kekunci</b> .....	<b>12</b>
• Kekunci Abjad Angka.....	13

## Maklumat Paparan

<b>Maklumat Paparan</b> .....	<b>14</b>
• Ikon-Ikon Pada Skrin .....	14

## Bermula

<b>Pemasangan</b> .....	<b>16</b>
• Menyisipkan Kad SIM .....	16
• Memasang Bateri.....	16
• Mengecas Bateri .....	17
• Memutuskan sambungan pengecas .....	17
• Arahan untuk menukar penutup berwarna depan .....	18
<b>Urutan Untuk Menghidupkan</b> .....	<b>19</b>
• Untuk bermula menggunakan telefon .....	19
• Untuk mematikan telefon .....	19
<b>Kod Akses</b> .....	<b>20</b>
• Kod PIN (4 hingga 8 angka) .....	20
• Kod PIN2 (4 hingga 8 angka) .....	20
• Kod PUK (4 hingga 8 angka) .....	20
• Kod PUK2 (4 hingga 8 angka) .....	20
• Kod sekuriti (4 hingga 8 angka) .....	20

## Mengakses Menu

<b>Buku telefon</b> .....	<b>21</b>
• Cari [Nama 1] .....	22
• Tambah baru [Nama 2] .....	23
• Dail cepat [Nama 3] .....	24
• Senarai suara [Nama 4].....	25
• Kump. pemanggil [Nama 5] .....	25

• Salin semua [Nama 6] .....	26
• Padam semua [Nama 7] .....	26
• Aturan [Nama 8] .....	27
• Maklumat [Nama 9] .....	28
<b>Pohon Menu .....</b>	<b>29</b>
<b>Mesej [Menu 1] .....</b>	<b>31</b>
• Tulis mesej [Menu 1-1] .....	31
• Peti masuk [Menu 1-2] .....	34
• Peti Keluar [Menu 1-3] .....	35
• Servis maklumat [Menu 1-4] .....	36
• Mesej suara [Menu 1-5] .....	37
• Kad nama [Menu 1-6] .....	38
• Templat [Menu 1-7] .....	38
• Aturan [Menu 1-8] .....	39
• Periksa memori [Menu 1-9] .....	39
<b>Daftar panggilan [Menu 2] .....</b>	<b>40</b>
• Panggilan terlepas [Menu 2-1] .....	40
• Panggilan masuk [Menu 2-2] .....	40
• Panggilan keluar [Menu 2-3] .....	40
• Padam panggilan terkini [Menu 2-4] .....	40
• Panggilan di caj [Menu 2-5] .....	41
<b>Profil [Menu 3] .....</b>	<b>44</b>
• Getaran shj [Menu 3-1] .....	44
• Senyap [Menu 3-2] .....	44
• Am [Menu 3-3] .....	45
• Kuat [Menu 3-4] .....	45
• Set kepala [Menu 3-5] .....	45
• Kereta [Menu 3-6] .....	45
<b>Aturan [Menu 4] .....</b>	<b>47</b>
• Jam loceng [Menu 4-1] .....	47
• Tarikh & masa [Menu 4-2] .....	48
• Aturan telefon [Menu 4-3] .....	49
• Aturanpanggilan [Menu 4-4] .....	50
• Aturan sekuriti [Menu 4-5] .....	52
• Aturan jaringan [Menu 4-6] .....	56
• Kembalikan aturan kilang [Menu 4-7] .....	56

<b>Alih panggilan [Menu 5]</b> .....	<b>57</b>
• Semua panggilan [Menu 5-1].....	57
• Jika sibuk [Menu 5-2].....	57
• Jika tak jawab [Menu 5-3] .....	57
• Jika tak sampai [Menu 5-4].....	57
• Semua panggilan [Menu 5-5].....	57
• Semua panggilan faks [Menu 5-6] .....	58
• Batal semua pe [Menu 5-7].....	76
<b>Penyelenggara [Menu 6]</b> .....	<b>59</b>
• Tambah baru [Menu 6-1] .....	59
• Lihat hari [Menu 6-2].....	60
• Lihat semua [Menu 6-3] .....	60
• Padam terakhir [Menu 6-4] .....	60
• Padam semua [Menu 6-5] .....	60
<b>Mainan &amp; Utiliti [Menu 7]</b> .....	<b>61</b>
• Permainan [Menu 7-1] .....	61
• Ubah unit [Menu 7-2] .....	62
• Kalkulator [Menu 7-3].....	62
• Masa dunia [Menu 7-4].....	63
<b>Internet [Menu 8]</b> .....	<b>64</b>
• Rumah [Menu 8-1] .....	64
• Penanda [Menu 8-2] .....	64
• Profil [Menu 8-3] .....	64
• Pergi ke URL [Menu 8-4] .....	66
• Aturan Cache [Menu 8-5] .....	67
• Kawalan puas [Menu 8-6].....	67
• Reset profil [Menu 8-7] .....	67
<b>Menu dalam talian</b> .....	<b>68</b>
<b><u>Additional Functions</u></b>	
<b>Bagaimana Menggunakan panggilan Data dan Faks</b> .....	<b>69</b>
• Menghantar Panggilan Data atau Faks .....	69
• Menerima Panggilan Data atau Faks .....	69
<b>Menu Dalam Panggilan</b> .....	<b>71</b>
• 1 SEMASA PANGGILAN.....	71
• 2 Panggilan Semua Pihak atau Menerima .....	73
<b>Penjagaan dan Penyelenggaraan</b> .....	<b>75</b>
<b>Data Teknikal</b> .....	<b>77</b>

Periksa bagi memastikan anda mempunyai semua bahagian yang ditunjukkan di bawah.



## <Aksesori Pilihan>



## Bahagian Depan Telefon

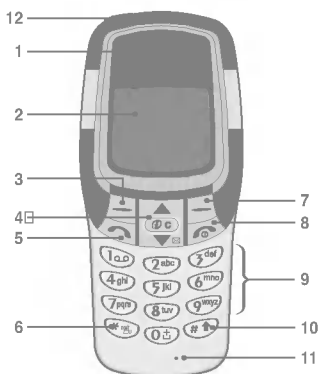

- |                       |                                |
|-----------------------|--------------------------------|
| 1 Cuping Telinga      | 7 Kekunci Kanan Lembut         |
| 2 Skrin Paparan       | 8 Kekunci TAMAT/KUASA          |
| 3 Kekunci Kiri Lembut | 9 Kekunci Angka                |
| 4 Kekunci Pandu Arah  | 10 Kekunci Dwipangkah          |
| 5 Kekunci Hantar      | 11 Mikrofon                    |
| 6 Kekunci Bintang     | 12 Mikrofon Telinga Penyambung |



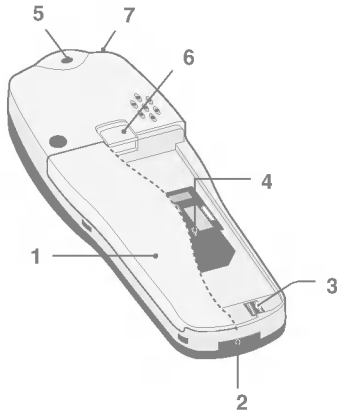

## Bahagian Belakang Telefon





- 1 Bateri
- 2 Penyambung Kabel/  
Pengecasan Bateri Penyambung/  
Kit Kereta Bebas Tangan Penyambung/
- 3 Terminal-Terminal Bateri
- 4 Soket Kad SIM
- 5 Lubang Tali Bimbit
- 6 Kunci Bateri
- 7 Mikrofon Telinga Penyambung

Berikut ditunjukkan komponen-komponen kekunci telefon.

## Penerangan Pad Kekunci

Kekunci	
	<p><b>Kekunci Kiri Lembut / Kekunci Kanan Lembut</b> Setiap daripada kekunci-kekunci ini melaksanakan fungsi yang ditunjukkan oleh teks pada paparan di atas kekunci tersebut.</p>
	<p><b>Kekunci Panas WAP</b> Digunakan untuk mentambung langsung kepada WAP dengan menekan kekunci ini. Digunakan untuk memadam aksara(-aksara).</p> <p><b>Kekunci-Kekunci Pandu Arah</b> Digunakan untuk menatal nama, nombor telefon, menu atau pilihan tetapan.</p>
	Digunakan untuk memasuki langsung menu <b>Messages</b> .
	Digunakan untuk menatal nama-nama, nombor-nombor telefon.
	<p><b>Kekunci Hantar</b> Anda boleh mendail nombor telefon dan menjawab panggilan. Jika anda menekan kekunci ini tanpa memasukkan nombor, telefon anda akan menunjukkan nombor yang paling terbaru didail.</p>
	<p><b>Kekunci Angka</b> Kekunci-kekunci ini selalunya digunakan untuk mendail dalam mod tunggu sedia dan memasukkan nombor atau aksara dalam mod mengedit. Apabila anda menekan kekunci-kekunci ini untuk masa yang lama.</p> <ul style="list-style-type: none"><li>• Digunakan untuk memanggil peti mel suara anda dengan .</li><li>• Digunakan untuk membuat panggilan antarabangsa dengan .</li><li>• Digunakan untuk memanggil Dail cepat dengan  hingga .</li></ul>
	Digunakan untuk memasukkan mod getar dengan menekan kekunci ini untuk masa yang lama.

Kekunci	
	Digunakan untuk memanggil melalui dail suara dengan menekan kekunci ini agak lama. Kekunci ini juga digunakan sebagai kekunci cangkuk mikrofon Telinga apabila menyambungkan mikrofon Telinga.
	<b>Kekunci TAMAT/KUASA</b> Digunakan untuk menamatkan atau menolak panggilan. Kekunci ini juga digunakan sebagai Kekunci Kuasa. Menekan dan menahan kekunci ini untuk beberapa saat.















## Kekunci Abjad Angka

Hubungan pemetaan pad kekunci abjad dan angka disenaraikan seperti jadual berikut.

Kekunci	
	., ' ? ! - & 1
	A B C 2 Ä À Á Â Ã Æ Ç a b c ä à á â ã ç
	D E F 3 È É Ê Ë d e f è é ê ë
	G H I 4 Î Ï Ì Í g h i î ï í
	J K L 5 j k l
	M N O 6 Ö Õ Ö Ó Ø Ñ m n o ö õ ò ó ø ñ
	P Q R S 7 p q r s
	T U V 8 Ü Û Ü Ú t u v ü û ú
	W X Y Z 9 w x y z
	0 [Kekunci Ruang]

Skrin memaparkan beberapa ikon dan berikut diterangkan setiap satu ikon yang anda mungkin lihat pada telefon.

## Ikon-Ikon Pada Skrin

Ikon/Penunjuk	
	Memberitahu anda kekuatan isyarat rangkaian.
	Panggilan disambungkan.
	Talian 1/ 2 sedang digunakan untuk panggilan keluar – Jika anda melanggan Khidmat Dua Talian.
	Penggera telah ditetapkan dan sedang aktif.
	Memberitahu anda status bateri.
	Anda telah menerima satu mesej teks.
	Anda telah menerima satu mesej suara bergantung kepada langganan anda.
	Anda telah menerima satu E-mel.
	Anda boleh melihat jadual anda.
	Semua isyarat yang dapat didengar dimatikan.
	Menu Umum dalam profil.
	Menu Kuat dalam profil.
	Menu Perlahan dalam profil.
	Menu Alat dengar dalam profil.
	Menu Bebas tangan dalam profil.
	Anda boleh mengalihkan panggilan.

**Ikon-Ikon Menu Atas**

Ikon	
	Mesej
	Daftar panggil
	Profil
	Aturan
	Alih Panggilan
	Penyelenggara
	Mainan & Utiliti
	Internet
	CanalAmena

## ① Menyisipkan Kad SIM

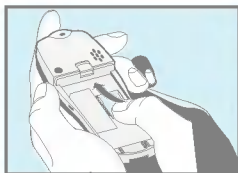

Cari soket kad SIM di belakang telefon. Ikut langkah-langkah di bawah untuk memasang kad SIM.

1. Tanggalkan bateri jika ia terpasang.
2. Gelongsorkan kad SIM ke dalam lubang alur, di bawah pemegang-pemegang perak, dengan penyambung-penyambung emas menghadap bawah dan sudut terpotong di sebelah kanan.

### ● PERHATIAN

- Sebelum memasang pastikan bahawa telefon dimatikan dan tanggalkan bateri.
- Sentuhan logam kad SIM mudah rosak disebabkan tercalar. Beri perhatian khusus pada kad SIM apabila anda memegang dan memasang. Ikut arahan yang dibekalkan dengan kad SIM.

## ② Memasang Bateri



1. Letakkan bateri di belakang telefon.



2. Tolak ia sehingga anda mendengar bunyi klik.

### 3 Mengecas Bateri

Untuk menyambungkan penyesuai kembara kepada telefon, anda mestilah memasang bateri.

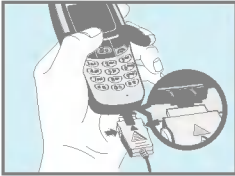

1. Masukkan satu hujung penyesuai kembara ke dalam bahagian bawah telefon.

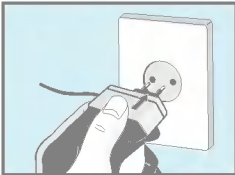

2. Sambungkan hujung penyesuai kembara yang satu lagi kepada soket dinding AC. Gunakan hanya pengecas yang disertakan di dalam bungkusan.



#### ● Amaran

- Jangan paksa penyambung kerana ini boleh merosakkan telefon dan/atau penyesuai kembara.

### 4 Memutuskan sambungan pengecas



Putuskan sambungan penyesuai kembara dari telefon dengan menekan butang-butang tepinya.

### ● Notis

- Bateri yang diberi bersama telefon anda perlu dicas sepenuhnya sebelum menggunakannya.
- Jangan tanggalkan bateri atau kad SIM semasa pengecasan.
- Mengecas Bateri dipaparkan pada skrin selepas menyambungkan penyusui kembara. Hanya jika bateri benar-benar kosong, Lampu Penunjuk Panggilan akan bernyala tanpa memaparkan Mengecas Bateri.
- Palang-palang bergerak ikon bateri akan berhenti selepas pengecasan penuh.

### ⑤ Arahan untuk menukar penutup berwarna depan

Sebelum menukar penutup, sentiasa matikan kuasa dan putus sambungan telefon dari pengecas atau sebarang peranti lain.



1. Untuk menanggalkan penutup, tekan kancing mengunci penutup misalnya dengan sekeping duit syiling, Mula membuka penutup dari bahagian atasnya.

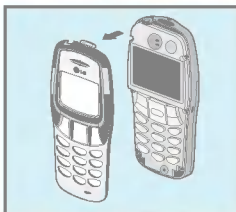

2. Untuk memasang semula penutup, pertama letakkan dan tutup kancing di bahagian bawah penutup ke dalam lubang yang sepadan pada telefon dan kemudian tutup dengan lembut seluruh

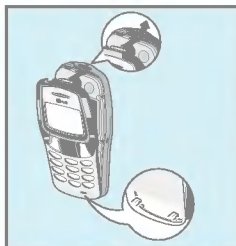

## ① Untuk bermula menggunakan telefon

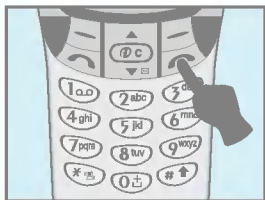

1. Tekan dan tahan kekunci  sehingga anda mendengar satu nada.
2. Bergantung kepada tetapan **Kod PIN** anda boleh memasukkan Kod PIN tidak.
3. Jika telefon menyambung kepada rangkaian, nama rangkaian akan dipaparkan sejeurus kemudian.

## ② Untuk mematikan telefon

Dalam mod tunggu sedia, tekan dan tahan kekunci  sehingga anda mendengar satu nada.

Anda boleh menggunakan kod-kod akses yang diterangkan di dalam bahagian ini untuk mengelakkan penggunaan telefon anda tanpa izin. Kod-kod akses (kecuali kod PUK dan PUK2) boleh ditukar dengan menggunakan [Menu 4-5-6].

### **Kod PIN (4 hingga 8 angka)**

Kod PIN (Nombor Pengenalan Peribadi) melindungi kad SIM anda daripada digunakan tanpa izin. Kod PIN biasanya dibekalkan dengan kad SIM. Apabila permintaan **Kod PIN** ditetapkan ke **Boleh**, telefon anda akan meminta kod PIN setiap kali ia dihidupkan. Sebaliknya, apabila **Kod PIN** ditetapkan ke **Tak Boleh**, telefon anda akan menyambung langsung kepada rangkaian tanpa meminta kod PIN.

### **Kod PIN2 (4 hingga 8 angka)**

Kod PIN2, dibekalkan dengan sesetengah kad SIM, diperlukan bagi mengakses beberapa fungsi seperti Pemberitahuan caj panggilan, Nombor Dail tetap. Fungsi-fungsi ini hanya terdapat jika disokong oleh kad SIM anda.

### **Kod PUK (4 hingga 8 angka)**

Kod PUK (Kunci Nyah-Halang Peribadi) diperlukan bagi menukar kod PIN yang terhalang. Kod PUK boleh dibekalkan dengan kad SIM. Jika tidak, hubungi pembekal khidmat setempat anda untuk kod tersebut. Jika anda kehilangan kod, hubungi juga pembekal khidmat anda.

### **Kod PUK2 (4 hingga 8 angka)**

Kod PUK2, dibekalkan dengan sesetengah kad SIM, diperlukan bagi menukar kod PIN2 yang terhalang. Jika anda kehilangan kod, hubungi juga pembekal khidmat anda.

### **Kod sekuriti (4 hingga 8 angka)**

Kod keselamatan melindungi telefon anda daripada digunakan tanpa izin. Ia biasanya dibekalkan dengan telefon. Kod ini diperlukan bagi menghapus semua entri telefon dan untuk mengaktifkan menu "Factory reset" (Tetap semula kilang). Nombor lalai Kod keselamatan ialah "0000". Anda juga boleh menukarnya di dalam menu Keselamatan.









Untuk memilih menu di dalam buku telefon, tekan  [Nama] dalam mod tunggu sedia dan kemudian tatal ke butiran yang diinginkan.

1	<b>Cari</b>	Membolehkan anda mencari nama, nombor tertentu.
2	<b>Tambah baru</b>	Membolehkan anda menambah nama dan nombor baru.
3	<b>Dail cepat</b>	Membolehkan anda memberi sehingga 8 (2-9) peruntukan dail satu sentuhan.
4	<b>Senarai suara</b>	Membolehkan anda menyenaraikan nombor-nombor telefon yang dikaitkan kepada suara.
5	<b>Kump.pemanggil</b>	Membolehkan anda memaparkan senarai kumpulan.
6	<b>Salin semua</b>	Membolehkan anda menyalin entri-entri dari memori Telefon kepada kad SIM atau dari kad SIM kepada memori Telefon.
7	<b>Padam semua</b>	Membolehkan anda memadam semua data di dalam sama ada buku telefon anda atau kad SIM ke memori telefon.
8	<b>Aturan</b>	Membolehkan anda menetapkan memori dan mencari butiran melalui Variable, nama dan nombor.
9	<b>Maklumat</b>	Membolehkan anda memeriksa status memori, SDN (Nombor Dail Khidmat), dan Nombor sendiri.

## Cari [Nama 1]









(Memanggil dari buku telefon)

1. Buka buku telefon dahulu dengan menekan  [Nama] dalam mod tunggu sedia.
2. **Cari** dengan Menekan  [Pilih] untuk memasuki.
3. Bergantung kepada tetapan **Cari**, menu di bawah mungkin tidak muncul.
  - **Nama**
  - **Nombor**
4. Anda boleh mencari sesuatu entri melalui nama dan nombor.
5. Pilih  [Cari].
6. Anda boleh memeriksa nama dan nombor dengan menekan  [Senarai].
7. Jika anda mahu mengedit, memadam, menyalin sesuatu entri, atau menambah suara kepada satu entri, pilih  [Pilihan]. Menu di bawah akan dipaparkan.
  - **Edit** : Anda boleh mengedit nama, nombor, E-mel, dan faks dengan menekan  [Okay].
  - **Padam** : Anda boleh memadam sesuatu entri.
  - **Salin** : Anda boleh menyalin sesuatu entri dari SIM ke telefon atau dari telefon ke SIM.
  - **Panggil** : Anda boleh memanggil menerusi entri yang dipilih.
  - **Suara** : Anda boleh menambah suara kepada entri atau menukar tag suara.
  - **Nombor utama** : Anda boleh memilih satu dari nombor telefon bimbit, rumah, pejabat yang selalu anda gunakan. Nombor utama akan dipaparkan dahulu, jika anda menetapkan ini.

## **Tambah baru [Nama 2]**

Anda boleh menambah kemasukan buku telefon dengan menggunakan fungsi ini. Muatan memori telefon ialah 200 kemasukan. Muatan memori kad SIM bergantung kepada pembekal khidmat selular.

Anda boleh menyimpan 20 perkataan bagi nama di dalam memori Telefon, dan anda boleh menyimpan perkataan-perkataan di dalam kad SIM. Bilangan perkataan ciri yang bergantung kepada SIM.

1. Buka buku telefon dahulu dengan menekan  [Nama] dalam mod tunggu sedia.
2. Gerakan untuk menyerlahkan **Tambah baru**, dan tekan  [Pilih] untuk memasuki.
3. Pilih memori yang ingin anda simpan: **SIM** atau **Fon**.
  - **SIM** : Anda boleh menambah nama dan nombor untuk kemasukan.
    - a. Tulis nama untuk ditambahkan.
    - b. Tekan  [Okay], kemudian anda boleh memasukkan nombor.
    - c. Tekan  [Okay].
    - d. Jika anda mahu menambah suara, tekan  [Ya].
  - **Fon** : Anda boleh menambah nama, nombor telefon bimbit, rumah, pejabat, no. Faks, dan alamat E-mel.
    - a. Tulis nama untuk ditambahkan.
    - b. Tekan  [Okay].
    - c. Masukkan nombor-nombor yang berikut sebagai bimbit, rumah, pejabat, dan faks dengan menekan  [Okay]. Anda juga boleh memasukkan alamat E-mel.
    - d. Jika anda mahu menambah Suara, tekan  [Ya].



Anda harus menyebut perkataan dalam masa 2 saat, dan telefon akan meminta anda menyebutnya lagi bagi memastikan ketepatan pengenalan suara. Selepas pengenalan suara selesai, Suara ditambahkan secara automatik.

## ● Perhatian





- Suara hanya boleh ditambahkan kepada nombor utama yang anda tetapkan. Sebagai contoh, jika anda menukar nobor utama suara akan ditambahkan secara automatik kepada nombor yang diubah.
- Anda boleh menambah tag suara kepada nombor telefon di dalam kad SIM. Tag suara boleh dipadam dengan menanggalkan atau menukar kad SIM. Dan tag suara yang ditambahkan kepada nombor telefon di dalam kad SIM boleh ditambahkan kepada nombor telefon lain apabila anda menukar kad SIM. Mengapa? Jawapannya ialah kad SIM tidak mengandungi maklumat mengenai tag suara.

## Dail cepat [Nama 3]

Anda boleh mengaitkan sebarang kekunci 2 hingga 9 dengan entri senarai Nama. Anda boleh memanggil langsung dengan menekan kekunci ini selama 2-3 saat.

1. Buka buku telefon dahulu dengan menekan  [Nama] dalam mod tunggu sedia.
2. Tatal ke **Dail cepat**, kemudian tekan  [Pilih] untuk memasuki menu ini.
3. Setiap Dail cepat akan dipaparkan.
4. Jika anda mahu manambah Dail cepat, pilih <Kosong>. Kemudian, anda boleh cari nama di dalam buku telefon.
5. Jika anda memilih nama yang diperuntukkan dengan dail cepat, anda boleh melihat submenu-submenu berikut.
  - **Tukar** : Anda bolen menukar peruntukan **Dail cepat**.
  - **Tak cepat**: Anda boleh memadam nombor dail cepat yang **dail** diperuntukkan.



## Senarai suara [Nama 4]

Anda boleh melihat semua nombor telefon yang mengandungi suara. Anda juga boleh memanggil langsung dengan menekan  [Hantar]. Selepas memilih nombor telefon dengan menggunakan  dan  dan tekan  [Pilihan], anda boleh melihat submenu-submenu berikut.

- **Main** : Anda boleh memainkan suara yang ditambahkan kepada nombor telefon.
- **Tukar** : Anda boleh menukar suara yang ditambahkan kepada nombor telefon.
- **Padam** : Anda boleh memadam suara yang ditambahkan kepada nombor telefon.
- **Panggil** : Anda boleh memanggil dengan memilih menu ini.

## Kump. pemanggil [Nama 5]

Anda boleh menyenaraikan sehingga 20 ahli bagi satu kumpulan. Terdapat 7 kumpulan yang boleh anda buat senarai.

1. Tekan  [Nama] untuk memasuki buku telefon dalam mod tunggu sedia.
2. Tatal ke butiran **Kump. pemanggil** kemudian tekan  [Pilih] untuk memasuki menu ini.
3. Setiap senarai Kumpulan akan dipaparkan : **Keluarga, Kawan-Kawan, Rakan Sekerja, VIP.**
4. Pilih nama Kumpulan yang ingin anda urus dengan menekan  [Pilih].
5. Submenu-submenu berikut akan dipaparkan.

- **Tambah ahli**

Anda boleh menambah nombor di dalam Kumpulan pemanggil.

- **Lihat ahli**

- Anda boleh melihat senarai nombor di dalam Kumpulan pemanggil.
- Anda boleh memilih anggota yang anda mahu dengan menekan  [Pilihan] kemudian anda boleh mengupayakan submenu seperti **Edit, Padam.**

- **Nada deringan kumpulan**

- Anda boleh menetapkan nada dering bergantung kepada Kumpulan.



- **Ikon kump.**
  - Anda boleh menetapkan ikon bergantung kepada Kumpulan.
- **Tukar nama**
  - Anda boleh menukar dan mengedit nama Kumpulan.

### ● Perhatian

- Menu "**Tukar nama**" ini akan dipaparkan hanya apabila anda memilih "**Kosong**".





## Salin semua [Nama 6]

Anda boleh menyalin/memindahkan entri dari memori Kad SIM ke memori Telefon atau dari memori Telefon ke memori Kad SIM.

1. Buka buku telefon dahulu dengan menekan  [Nama] dalam mod tunggu sedia.
2. Tatal untuk **Salin semua**, kemudian tekan  [Pilih] untuk memasuki menu ini.
3. Submenu-submenu di bawah akan dipaparkan.
  - **SIM kepada Fon**: Anda boleh menyalin entri dari Kad SIM ke memori Telefon.
  - **Fon kepada SIM**: Anda boleh menyalin entri dari memori Telefon ke Kad SIM.



## Padam semua [Nama 7]

Andana boleh memadam semua entri di dalam **SIM**, **Fon**, dan **Suara**. Fungsi ini memerlukan kod Keselamatan.

1. Tekan  [Nama] untuk memasuki buku telefon dalam mod tunggu sedia.
2. Tatal ke **Padam semua**, kemudian tekan  [Pilih].
3. Kemudian pilih memori untuk dipadam: **SIM**, **Telefon**, **Suara**.
4. Dan kemudian anda akan diminta memasukkan kod Keselamatan.
5. Tekan  [Okay] atau, tekan  [Kembali] untuk membatalkan.

## Aturan [Nama 8]

Anda boleh menetapkan memori yang lebih digemari yang termasuk **Variable**, **SIM** atau **Telefon** dan carian yang lebih digemari yang termasuk **Variable**, **Nama** dan **Nombor**.

1. Buka buku telefon dahulu dengan menekan  [Nama] dalam mod tunggu sedia.
2. Tatal ke **Aturan**, kemudian tekan  [Pilih] untuk memasuki.
3. Submenu-submenu di bawah akan dipaparkan.

### • Set Memori

1. Tatal untuk menyerlahkan **Set Memori**, kemudian tekan  [Pilih] untuk memasuki.
2. Ketiga-tiga submenu dipaparkan.
  - Jika anda memilih **berbagai**, apabila menambah entri, telefon akan bertanya di mana untuk menyimpannya.
  - Jika anda memilih **SIM**, apabila menambah entri, tanpa bertanya di mana untuk menyimpannya, telefon akan menyimpan entri ke SIM.
  - Jika anda memilih **Fon**, apabila menambah entri, tanpa bertanya di mana untuk menyimpannya, telefon akan menyimpan entri ke memori Telefon.





### • Cari dengan

1. Tatal untuk menyerlahkan **Cari, dengan** kemudian tekan  [Pilih] untuk memasuki.
2. Ketiga-tiga submenu dipaparkan.
  - Jika anda memilih **berbagai**, apabila mencari, telefon akan bertanya bagaimana untuk mencari.
  - Jika anda memilih **Nama**, apabila mencari, tanpa bertanya bagaimana untuk mencari, telefon akan mencari entri melalui nama.
  - Jika anda memilih **Nombor**, apabila mencari, tanpa bertanya bagaimana untuk mencari, telefon akan mencari entri melalui nombor.

## Maklumat [Nama 9]

### SDN (No. dail diservis)



Gunakan fungsi ini untuk mengakses senarai tertentu bagi khidmat-khidmat yang disediakan oleh operator rangkaian anda (jika disokong oleh kad SIM).

1. Buka buku telefon dahulu dengan menekan  [Nama] dalam mod tunggu sedia.
2. Gerak ke servis dail nombor, kemudian tekan  [Okay] untuk memasuki.
3. Nama-nama khidmat yang terdapat akan dipaparkan.
4. Gunakan  dan  untuk memilih khidmat. Tekan  [Hantar].

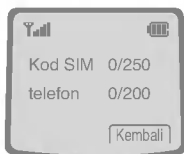
### Periksa memori



Ciri ini membolehkan anda melihat berapa banyak memori bebas dan sedang digunakan di dalam buku telefon anda.

1. Buka buku telefon dahulu dengan menekan  [Nama] dalam mod tunggu sedia. Pilih **Maklumat** dengan menekan  [Pilih].
2. Gerak ke **Periksa memori**, kemudian tekan  [Okay] untuk memasuki menu ini.

### Senarai no.sendiri (Bergantung kepada SIM)

Anda boleh memeriksa nombor anda sendiri di dalam kad SIM.



## 1 Mesej

- 1 Tulis mesej  
Hantar  
Simpan  
Gunakan templat  
Gunakan kad nama  
Tambah kamus  
Senarai kamus
- 2 Peti masuk  
Padam  
Edit  
Kehadapan  
Dapatkan nombor  
Jawab  
Balas panggilan
- 3 Peti Keluar  
Padam  
Edit  
Kehadapan  
Dapatkan nombor
- 4 Servis maklumat  
1 Baca  
2 Terima CB  
3 Awas  
4 Bahasa  
5 Topik
- 5 Mesej suara  
1 Dengar dari mesej suara  
2 Peti mail suara nombor
- 6 Kad nama
- 7 Templat

## 8 Aturan

- 1 Jenis mesej
- 2 Tempoh sah
- 3 Laporan Status
- 4 Bayar utk balas
- 5 Pusat SMS
- 9 Periksa memori



## 2 Daftar panggilan

- 1 Panggilan terlepas
- 2 Panggilan masuk
- 3 Panggilan keluar
- 4 Padam panggilan terkini
- 5 Panggilan di caj  
1 Tempoh panggilan  
2 Kos panggilan  
3 Aturan kos



## 3 Profil

- 1 Getaran shj
- 2 Senyap
- 3 Am
- 4 Kuat
- 5 Set Kepala
- 6 Kereta



## 4 Aturan

- 1 Jam loceng  
1 Boleh  
2 Tak boleh
- 2 Tarikh & masa  
1 Data  
2 Masa
- 3 Aturan telefon  
1 Pamer  
2 Bahasa
- 4 Aturan panggilan  
1 Pengawas minit  
2 Mana-mana ke kunci jawab  
3 Hantar nombor  
4 Panggilan menu  
5 Redail Auto  
6 Pilih rangkaian  
7 Panggilan Kemu
- 5 Aturan sekuriti  
1 kod PIN  
2 Kunci telefon  
3 Automatik Pad Kekunci  
4 Sekat panggilan  
5 Nombor panggilan  
6 Tukar kod
- 6 Aturan jaringan  
1 Auto  
2 Manual  
3 Yang disukai  
4 Kegunaan peng
- 7 Kembalikan aturan kilang



## 5 Alih panggilan

- 1 Semua panggilan
- 2 Jika sibuk
- 3 Jika tak jawab
- 4 Jika tak sampai
- 5 Semua panggilan
- 6 Semua panggilan faks
- 7 Batal semua pe



## 6 Penvelenggara

- 1 Tambah baru
  - 1 Jadual
  - 2 Memo
- 2 Lihat hari
- 3 Lihat semua
- 4 Padam terakhir
- 5 Padam semua



## 7 Mainan & Utiliti

- 1 Permainan
- 2 Ubah unit
- 3 Kalkulator
- 4 Masa dunia



## 8 Internet

- 1 Rumah
- 2 Penanda
- 3 Profil
- 4 Pergi ke URL
- 5 Aturan Cache
  - 1 Kosongkan cache
  - 2 Cache periksa
- 6 Kawalan puas
- 7 Reset profil



## 9 CanalAmena

This menu depends on SIM and the network services.

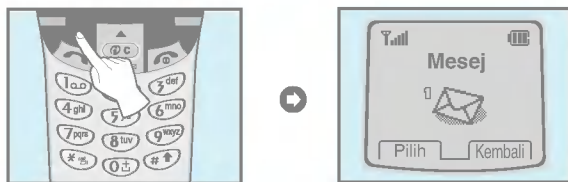

Menu ini termasuk fungsi-fungsi yang berkaitan dengan SMS (Short Message Service, Khidmat Mesej Ringkas), mel suara, serta mesej-mesej khidmat rangkaian.

### **Tulis mesej [Menu 1-1]**

Anda boleh menulis dan mengedit mesej teks sehingga 1024 aksara. Anda juga boleh memeriksa bilangan aksara.

1. Masuki menu **Tulis mesej** dengan menekan [Pilih].
2. Jika Anda mahu menulis mesej baru, pilih **Tulis mesej** di dalam menu.
3. Masukkan mesej dengan menggunakan teks eZi. Untuk perincian, lihat Teks eZi (Halaman 33).
4. Apabila anda selesai menulis mesej anda, tekan [Pilihan]. Menu pilihan berikut akan dipaparkan.



### **Hantar**

Menghantar mesej teks.

1. Jika anda mahu menghantar mesej teks, masukkan nombor yang anda mahu.
2. Telefon anda meminta anda memasukkan nombor untuk menghantar mesej tersebut
3. Selepas menghantarnya, telefon anda bertanya sama ada anda akan menyimpan mesej yang telah diedit.
4. Tekan jika anda mahu menyimpannya di dalam **Peti Keluar** dan tekan jika anda tidak mahu.

### Simpan

Menyimpan mesej di dalam Peti Keluar.

1. Telefon anda bertanya sama ada anda akan menyimpan mesej yang telah diedit.
2. Tekan  jika anda mahu menyimpannya di dalam Peti keluar dan tekan  jika anda tidak mahu.

### Gunakan templat



Templat ialah mesej yang telah dipraktakrif. Anda boleh menambah templat senarai kepada mesej apabila anda mengeditnya.

### Gunakan kad nama

Butiran-butiran kad nama ialah nama, nombor telefon bimbit, pejabat, faks, dan e-mel. Anda boleh menambah kad nama kepada mesej.



### Tambah kamus

Jika anda menambah perkataan yang selalu anda gunakan, anda boleh memasukkannya dengan menekan kekunci sekali untuk setiap aksara.

1. Masuki menu.
2. Tatal untuk menyerlahkan **Tambah kamus mudah**, dan kemudian tekan  [Pilih].
3. Masukkan perkataan, dan kemudian tekan  [Tambah].

### Senarai kamus

Anda boleh melihat senarai perkataan-perkataan yang telah anda simpan di dalam kamus.

1. Masuki menu.
2. Tatal untuk menyerlahkan List dictionary, dan kemudian tekan  [Pilih].
3. Anda boleh memeriksa senarai perkataan.
4. Jika anda mahu memadam perkataan, tekan  [Padam].
5. Jika anda mahu memadam semua perkataan di dalam senarai, pilih Padam semua di bawah senarai dengan menekan  [Pilih].

## eZi-Text

Teks eZi membolehkan anda menaip dengan mudah dan cepat. Jika anda hanya menekan kekunci yang ditandakan dengan aksara pada pad kekunci, anda boleh mendapatkan aksara yang anda mahu. Ia sangat berguna untuk membuat perkataan dan ayat.

Jika anda menekan kekunci  selama beberapa saat, anda boleh menukar jenis bahasa. Telefon juga menyokong empat **mod: Mod eZi, Mod Angka, Mod Hurut besar, dan Kecil** Jika anda mahu memukar mod, tekan kekunci .

### • Bagaimana menggunakan mod eZi

Untuk memasukkan aksara dalam mod eZi, anda hanya tekan setiap kekunci sekali untuk aksara yang anda mahu.

Sebagai contoh, untuk menulis **Girl** dalam mode eZi;

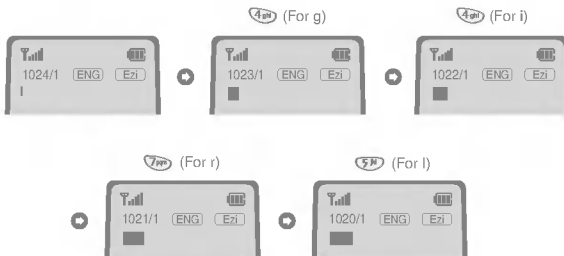

### • Bagaimana menggunakan dalam mod Angka



Untuk memasukkan nombor dalam mod Angka, anda tekan kekunci nombor yang dipaparkan pada pad kekunci.

### • Bagaimana menggunakan dalam mod Huruf besar



Untuk memasukkan huruf Besar, anda tekan aksara yang dipaparkan pada pad kekunci.

### • Bagaimana menggunakan dalam mod huruf Kecil





Untuk memasukkan huruf Kecil, anda tekan kekunci aksara yang dipaparkan pada pad kekunci.

### ● Perhatian

- Jika anda mahu memasukkan aksara simbol, tekan kekunci  dalam setiap mod.

## Peti masuk [Menu 1-2]

Apabila anda menerima mesej teks, telefon anda menunjukkan simbol dan menyimpannya di dalam senarai mesej masuk. Tatal ke mesej yang diinginkan dengan menggunakan  ,  . Sebagai tambahan, anda boleh melihat Padam semua untuk memadam semua mesej masuk di bawah senarai. Semasa membaca mesej, tekan  [Pilihan] untuk mengakses pilihan-pilihan yang terdapat.

## Padam

Mesej yang terpilih dipadam.

## Edit

Anda boleh mengedit mesej masuk dan menghantar atau menyimpan mesej yang telah diedit.

## Kehadapan

Anda boleh menghantar lanjut mesej terpilih kepada pihak yang satu lagi.

## Dapatkan nombor

Jika mesej yang terpilih mempunyai nombor telefon, anda boleh mengambil dan menyimpannya di dalam buku telefon. Anda juga boleh memanggil melalui nombor ini.





## Jawab

Anda boleh menjawab penghantar melalui mesej.

## Balas panggilan

Anda boleh memanggil balik penghantar yang menghantar mesej secara automatik.

## Peti Keluar [Menu 1-3]

Apabila anda memasuki menu ini, anda boleh melihat senarai panggilan keluar. Tatal ke mesej yang diinginkan dengan menggunakan  ,  dan tekan  untuk melihat mesej. Dan jika anda mahu keluar dari menu **Peti Keluar**, tekan . Dan jika anda mahu keluar dari menu outbox, tekan . Sebagai tambahan, anda boleh melihat **Padam semua** untuk memadam semua mesej keluar di bawah senarai.

Semasa membaca mesej, tekan  [Pilihan] untuk mengakses submenu-submenu berikut.

## Padam

Mesej yang terpilih dipadam.

## Edit

Anda boleh mengedit mesej keluar dan menghantar atau menyimpannya.

## Kehadapan

Anda boleh menghantar lanjut mesej yang terpilih kepada pihak yang satu lagi.

## Dapatkan nombor



Jika mesej yang terpilih mempunyai nombor telefon, anda boleh mengambil dan menyimpannya di dalam buku telefon. Anda juga boleh memanggil melalui nombor ini.

### Servis maklumat [Menu 1-4]

#### (Bergantung kepada rangkaian dan langganan)

Mesej-mesej Siaran Sel (Mesej CB) adalah mesej-mesej teks oleh rangkaian kepada pengguna telefon GSM. Ia memberi maklumat umum seperti laporan cuaca, berita lalu lintas, teksi, farmasi, dan harga saham. Setiap jenis maklumat mempunyai nombor; oleh itu, anda boleh menghubungi pembekal khidmat. Apabila anda menerima mesej CB, anda boleh membacanya mengikut urutan ini:

#### Baca [Menu 1-4-1]

1. Apabila anda menerima mesej CB, ia akan dipaparkan pada skrin. Anda boleh membaca mesej dengan menatal  ,  .
2. Selepas membaca mesej, tekan  untuk kembali ke mod tunggu sedia. Sebagai tambahan, anda boleh menyimpannya sehingga satu lagi mesej sampai.

#### Terima CB [Menu 1-4-2]

- **Ya**

Jika anda memilih menu ini, telefon anda akan menerima mesej Siaran Sel.

- **Tidak**

Jika anda memilih menu ini, telefon anda tidak akan menerima mesej Siaran Sel lagi.

#### Awas [Menu 1-4-3]

- **Ya**

Jika anda memilih menu ini, telefon anda akan berbunyi bip apabila mesej Siaran sel diterima.

- **Tidak**

Jika anda memilih menu ini, telefon anda tidak akan berbunyi bip walaupun apabila mesej Siaran sel diterima.

### **Bahasa [Menu 1-4-4]**

Anda boleh memilih bahasa yang anda mahu. Setelah itu telefon anda akan menerima mesej siaran sel dalam bahasa yang anda pilih.

Anda boleh memilih bahasa siaran sel dengan menekan  [Pilih]. Senarai bahasa yang anda pilih akan dipaparkan dengan kotak yang bertanda semak.

### **Topik (Bergantung kepada rangkaian dan langganan) [Menu 1-4-5]**

#### **• Tambah [Menu 1-4-5-1]**

Jika anda memilih menu ini, anda akan menambah kategori mesej CB dengan nama gelarnya.

#### **• Lihat senari [Menu 1-4-5-2]**

Jika anda memilih menu ini, anda boleh melihat kategori mesej CB yang telah anda tambahkan. Jika anda menekan  [Pilihan], anda boleh mengedit dan memadam kategori mesej CB yang telah anda tambahkan.

#### **• Senari aktif [Menu 1-4-5-3]**

Anda boleh memilih kategori mesej CB di dalam senarai aktif dengan menekan  [Pilih].

### **Mesej suara [Menu 1-5]**

Anda boleh mendengar mesej suara anda dan mendapatkan nombor pusat mel suara anda.

#### **Dengar dari mesej suara [Menu 1-5-1]**

Anda boleh memanggil pusat mel suara jika anda mahu mendengar mesej suara anda.

### **Peti mail suara nombor [Menu 1-5-2]**

Anda boleh mendapatkan mel suara jika ciri ini disokong oleh pembekal khidmat rangkaian. Apabila mel suara baru tiba, simbol akan dipaparkan pada skrin. Sila periksa dengan pembekal khidmat rangkaian anda untuk perincian mengenai khidmat mereka untuk menatarajah telefon seperlunya.

1. Tekan kekunci  untuk masa yang lama dalam mod tunggu sedia.
2. Anda boleh memeriksa submenu-submenu berikut.

- **Rumah air [Menu 1-5-2-1]**

Nombor yang didail pada rangkaian tanah air untuk mendengarkan mel suara.

- **Roam [Menu 1-5-2-2]**

Nombor yang didail apabila rangkaian-rangkaian lain digunakan untuk mendengarkan mel suara.

### **Kad nama [Menu 1-6]**

Ia adalah untuk mengedit kad nama. Butiran-butiran kad nama ialah nama, nombor telefon bimbit, pejabat, faks, dan e-mel.

- **Edit** : Anda boleh mengedit kad nama.
- **Padam** : Anda boleh memadam kad nama.

### **Templat [Menu 1-7]**

Ini adalah untuk mengedit mesej yang telah dipraktakrif. Anda boleh melihat 11 mesej yang telah dipraktakrif di dalam senarai. Anda boleh menyimpan 6 templat sebelum anda mengedit. Tetapi anda boleh menukarnya. Yang lain adalah <Kosong>.

- **Edit** : Anda boleh mengedit templat.
- **Padam** : Anda boleh memadam templat.

## **Aturan [Menu 1-8]**

### **Jenis mesej [Menu 1-8-1]**

#### **Teks, Suara, Faks, Nutl. paging X.400, E-mel, ERMES**

Biasanya, jenis mesej ditetapkan ke **Teks** Anda boleh menukar teks anda kepada format-format alternatif, yang sesuai untuk peranti yang akan menerima mesej. Hubungi pembekal khidmat anda untuk ketersediaan fungsi ini.

### **Tempoh sah [Menu 1-8-2]**

Khidmat rangkaian ini membolehkan anda menetapkan kepanjangan mesej yang akan disimpan di pusat mesej semasa percubaan dibuat untuk menghantarnya kepada anda.

### **Laporan Status [Menu 1-8-3]**

Jika anda menetapkan **Ya** di dalam menu ini, anda boleh memeriksa sama ada mesej anda berjaya dihantar atau tidak.

### **Bayar utk balas [Menu 1-8-4]**

Apabila mesej dihantar, ia membolehkan orang yang mendapat mesej daripada anda menjawab dan mengecaj kos jawapannya ke bil telefon anda.

### **Pusat SMS [Menu 1-8-5]**

Jika anda mahu menghantar mesej teks, anda boleh mendapatkan alamat pusat SMS melalui menu ini.

## **Periksa memori [Menu 1-9]**

Jika anda memilih menu ini, telefon memaparkan memori yang digunakan dan jumlah bilangan memori. Jumlah memori ialah jumlah memori SIM dan memori Telefon.

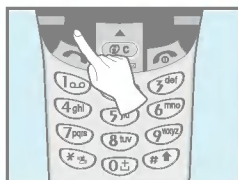

<Tekan sekali>



### Panggilan terlepas [Menu 2-1]

Menu ini menunjukkan nombor-nombor terbaru yang tidak dijawab. Anda boleh memanggil melalui nombor ini, juga menyimpan dan melihat tarikh dan masa panggilan di dalam menu ini.

### Panggilan masuk [Menu 2-2]







Anda boleh memeriksa nombor-nombor yang terbaru anda terima. Anda boleh memanggil melalui nombor ini, menyimpannya dan melihat tarikh dan masanya dalam menu ini.

### Panggilan keluar [Menu 2-3]

Anda boleh memeriksa nombor-nombor yang terbaru didail. Anda boleh memanggil melalui nombor ini, menyimpannya dan melihat tarikh dan masanya dalam menu ini.

### Padam panggilan terkini [Menu 2-4]

Anda boleh memadam semua rekod panggilan.





1. Tekan  [Menu] dalam mod tunggu sedia.
2. Tekan  untuk akses langsung atau gunakan  dan  untuk memasuki **Log panggilan**.
3. Tatal untuk menyerlahkan **Padam panggilan terkini** dan tekan  [Pilih] untuk memasuki.
4. Empat submenu berikut : Panggilan yang tidak dijawab, Panggilan yang diterima, Panggilan yang didail, Semua panggilan.
5. Mesej **Padam Semua** akan dipaparkan dan kemudian tekan  [Ya].

## **Panggilan di caj [Menu 2-5]**

Dalam submenu-submenu ini, anda boleh melihat tempoh dan kos panggilan.

### **Tempoh panggilan [Menu 2-5-1]**





Fungsi ini membolehkan anda melihat tempoh Panggilan Terakhir, Semua Panggilan, Panggilan Masuk dan Panggilan Keluar anda dalam kiraan jam, minit dan saat. Anda juga boleh melaras semula pengira masa panggilan.

1. Tekan  [Menu] dalam mod tunggu sedia.
2. Tekan  untuk akses langsung atau gunakan  dan  untuk memasuki **Daftar panggilan**.
3. Tatal untuk memnyerlahkan Tempoh panggilan dan tekan  [Pilih].

5 Submenu berikut : **Panggilan akhir, Semua panggilan, Panggilan masu, Panggilan kelua, Reset semua.**

### **Kos panggilan [Menu 2-5-2]**

Fungsi ini membolehkan anda memeriksa kos panggilan terakhir anda, semua panggilan, yang tinggal dan menetap semula kos. Untuk menetap semula kos, anda perlukan kod PIN2

1. Tekan  [Menu] dalam mod tunggu sedia.
2. Tekan  untuk akses langsung atau gunakan  dan  untuk memasuki **Daftar panggilan**.
3. Tatal untuk menterlahkan Kos panggilan dan tekan  [Pilih] unek memasuki.

Submenu berikut: **Panggilan akhir, Semua panggilan, Peringatan, Reset semua.**





#### **● Perhatian**

- Kos panggilan yang sebenar mungkin berbeza bergantung kepada ciri-ciri rangkaian, bil, dan cukai.

### Aturan kos [Menu 2-5-3] [Bergantung kepada SIM]





#### • Set tarif [Menu 2-5-3-1]

Anda boleh menetapkan jenis mata wang dan harga unit. Hubungi pembekal-pembekal khidmat anda untuk mendapatkan harga –harga unit mengecaj. Untuk memilih mata wang atau unit di dalam menu ini, anda perlukan kod PIN2.

1. Tekan  [Menu] dalam mod tunggu sedia.
2. Tekan  untuk akses langsung atau gunakan  dan  untuk memasuki **Daftar panggilan**.
3. Tatal untuk menyerlahkan Aturan dan tekan  [Pilih] untuk memasuki.
4. Pilih **Set tarif**.

#### • Set Kredit [Menu 2-5-3-2]

Khidmat rangkaian ini membolehkan anda menyekat kos-kos panggilan anda dengan unit-unit mengecaj yang terpilih. Jika anda memilih **Baca**, bilangan unit yang tinggal ditunjukkan. Jika anda memilih **Tukar**, anda boleh menukar had caj anda.





1. Tekan  [Menu] dalam mod tunggu sedia.
2. Tekan  untuk akses langsung atau gunakan  dan  untuk memasuki **Daftar panggilan**.
3. Tatal untuk menyerlahkan **Aturan** dan tekan  [Pilih] untuk memasuki.
4. Pilih **Set Kredit**.

#### ● **Perhatian**

- Apabila semua unit telah digunakan, tiada panggilan yang boleh dibuat kecuali panggilan kecemasan. Bergantung kepada kad SIM, anda memerlukan Kod PIN2 untuk menetapkan had kos panggilan.

- **Auto pamer [Menu 2-5-3-3]**





Khidmat rangkaian membolehkan anda melihat secara automatik kos panggilan terakhir anda. Jika anda memilih **Ya** dalam menu **Tidak pamer**, anda boleh melihat kos terakhir apabila panggilan dilepaskan.

1. Tekan  [Menu] dalam mod tunggu sedia.
2. Telam  untuk akses langsung atau gunakan  dan  untuk memasuki **Daftar panggilan**.
3. Tatal untuk menyerlahkan **Aturan** dan tekan  [Pilih] untuk memasuki.
4. Pilih **Auto pamer**.



<Tekan dua kali>

Di dalam menu ini, anda boleh melaras dan mengkhususkan nada-nada telefon untuk acara-acara, sekitaran dan kumpulan pemanggil yang berbeza. (misalnya, Apabila telefon anda disambungkan kepada kit Bebas tangan, ia akan ditetap secara automatik kepada menu profil Bebas tangan dan apabila telefon anda disambungkan kepada mikorfon Teinga, ia akan ditetap secara automatik kepada menu profil Alat dengar.)

1. Tekan  [Menu] dalam mod tunggu sedia.
2. Tekan  untuk akses langsung atau gunakan  dan  untuk memasuki Profil.

### ● Perhatian

- Sekiranya telefon anda disambungkan kepada Aksesori seperti mikrofon Telinga dan Bebas tangan, anda tidak boleh menupayakan menu Profil secara manual.
- Menu Profil mempunyai submenu "Upayakan" kecuali Alat dengar dan Bebas tangan supaya anda boleh menetap menu Profil pada bila-bila masa kecuali dalam kes di atas.

## Getaran shj [Menu 3-1]

- **Boleh** : Anda boleh melaras profil sebagai Getaran jika anda memerlukan mod getaran.

## Senyap [Menu 3-2]

- **Boleh** : Anda boleh melaras profil sebagai Privet.
- **Tukar** : Anda boleh menukar nilai-nilai submenu-submenu Profil.

### **Am [Menu 3-3]**

- **Boleh** : Anda boleh melaras profil sebagai Kuat jika anda di dalam sekitaran yang bising.
- **Tukar** : Anda boleh menukar nilai-nilai submenu-submenu Profil.

### **Kuat [Menu 3-4]**

- **Boleh** : Anda boleh melaras profil sebagai Perlahan jika anda di tempat yang sunyi.
- **Tukar** : Anda boleh menukar nilai-nilai submenu-submenu Profil.

### **Set kepala [Menu 3-5]**

- **Tukar** : Anda boleh melaras profil sebagai Headset apabila anda memakai alat dengar.
- **Tukar** : Anda boleh menukar nilai-nilai submenu-submenu Profil Audio.

### **Kereta [Menu 3-6]**

- **Tukar** : Anda boleh melaras profil sebagai Car apabila anda mengaktifkan Kit Bebas Tangan.
- **Tukar** : Anda boleh menukar nilai-nilai submenu-submenu Profil Audio.

### **Kumpulan profil submenu [Menu 3-x-x]**

Menu **Profil** mempunyai submenu-submenu seperti yang ditunjukkan di bawah.

#### **Jenis isyarat pangg.Masuk [Menu 3-x-1]**

Membolehkan isyarat bagi panggilan masuk untuk melaras sekitaran.

#### **Jenis deringan [Menu 3-x-2]**

Membolehkan anda menetapkan jenis deringan untuk melaras sekitaran.

#### **Kelantangan deringan [Menu 3-x-3]**

Membolehkan menetapkan kelantangan deringan untuk melaras sekitaran.

### Jenis isyarat [Menu 3-x-4]

Membolehkan isyarat dibunyikan apabila menerima mesej untuk melaras sekitaran. **Bip, Getaran, dan Tiadaisyarat.**

### Saiz utama [Menu 3-x-5]

membolehkan menetap kelantangan pad kekunci untuk melaras sekitaran.

### Jawab auto [Menu 3-x-6]

Membolehkan anda menetap telefon supaya menjawab secara automatik bagi sekitaran melaras.

Sila ambil perhatian bahawa hanya Bebas tangan dan Alat dengar mempunyai submenu ini supaya anda boleh mengaktifkan fungsi ini.

- **Tidak boleh**

Walaupun telefon anda sedang berdering, telefon anda tidak akan menjawab secara automatik.

- **Selepas 5 saat**

Selepas 5 saat telefon anda akan menjawab secara automatik.

- **Selepas 10 saat**

Selepas 10 saat telefon anda akan menjawab secara automatik.

### ● Perhatian

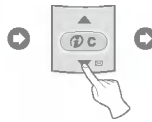

- Jika anda menyambungkan kit Bebas Tangan kepada telefon, anda tidak boleh mengaktifkan getaran yang berkaitan dengan menu isyarat Masuk atau isyarat Mesej. Oleh itu, di dalam menu Car, anda boleh melihat submenu-submenu berikut;
  - **Isyarat masuk** : Berdering, Senyap
  - **Isyarat mesej** : Bip, Tiada isyarat



<Tekan tiga kali>



Anda boleh menetapkan menu-menu berikut untuk kemudahan dan pilihan anda.



1. Tekan  [Menu] dalam mod tunggu sedia.
2. Tekan  untuk akses langsung untuk memasuki **Aturan**.

### Jam loceng [Menu 4-1]

Anda boleh menetapkan telefon supaya menggera pada masa yang ditentukan di dalam menu ini.



#### **Boleh [Menu 4-1-1]**

Anda boleh menetapkan masa (Jam dan Minit) untuk membunyikan penggera.

1. Masuki menu ini.
2. Pilih Enable dengan menekan  [Pilih], dan kemudian masukkan masa penggeraan yang anda mahu.
3. Tekan  [Okay].
4. Pilih tempoh ulangan: **Sekali, Harian, Mingguan, dan Bulanan**.
5. Jika anda menetapkan penggeraan Tutup kuasa, penggera membunyikan isyarat pada masa yang ditetapkan walaupun telefon telah anda matikan.

#### **Tak boleh [Menu 4-1-2]**

Anda boleh membatalkan penetapan masa penggeraan.



1. Masuki menu.
2. Pilih **Tak boleh** dengan menekan  [Pilih].
3. Mesej **Loceng dibatalkan?** dipaparkan.
4. Jika anda mahu membatalkan, tekan  [Ya]. Jika tidak, tekan  [Tidak].

### Tarikh & masa [Menu 4-2]

#### Data [Menu 4-2-1]

- **Set tarikh**

Di dalam menu ini, anda boleh menetapkan tarikh telefon anda.

1. Masuki menu.
2. Pilih **Set tarikh** dengan menekan  [Pilih].
3. Masukkan nombor yang ingin anda tetapkan tarikhnya.
4. Tekan  [Okay].

- **Format tarikh**

Anda boleh menetapkan **Format tarikh** di dalam menu ini.





#### Masa [Menu 4-2-2]

Telefon mempunyai jamnya sendiri. Di dalam menu ini anda boleh menetapkan masa dan pilih antara format masa 12 jam atau 24 jam.

1. Masuki menu.
2. Tatal untuk menyerlahkan **Masa** dengan menekan  [Pilih].



- **Set masa:**

Anda boleh menetapkan masa telefon anda di dalam menu ini.

1. Pilih **Set masa** dengan menekan  [Pilih].
2. Masukkan nombor yang ingin anda tetapkan masanya.
3. Pilih **AM/PM** yang anda mahu menetapkan format masa dengan menekan kekunci  , .
4. Tekan  [Okay].

- **Format masa:**

Anda boleh memilih **Format masa** antara 12 jam dan 24 jam.

1. Tatal untuk menyerlahkan Time dengan menekan  [Pilih].
2. Pilih 12 jam atau 24 jam yang anda mahu dengan menekan  [Pilih].

## **Aturan telefon [Menu 4-3]**

Anda boleh menetapkan tetapan telefon yang anda mahu. Tatal untuk menyeralhakan menu **Aturan** telefon, dan kemudain tekan  [Pilih].

### **Pamer [Menu 4-3-1]**

- **Profil grafik [Menu 4-3-1-1]**

Jika anda tidak mengaktifkan sebarang fungsi selama 20 saat, gambar akan dipaparkan dalam mod tunggu sedia.

- **Nota pembukaan [Menu 4-3-1-2]**

Menu ini membolehkan anda menetapkan mesej, yang dipaparkan sebentar apabila telefon dihidupkan.

1. Pilih **Aturan-Telefon-Nota-Pembukaan**.

2. Teks anda sendiri boleh dipaparkan. Jika anda memilih butiran ini, telefon anda meminta anda mengedit Message.

- **Lampu belakang [Menu 4-3-1-3]**

Anda boleh menetapkan tempoh pencahayaan yang anda mahu bila-bila saja dengan menekan kekunci : **Tak boleh, 5 saat, 10 saat, dan sentiasa**.

- **LCD kontras [Menu 4-3-1-4]**

Anda boleh menetapkan terangnya LCD yang anda mahu dengan menekan  , .

### **Bahasa [Menu 4-3-2]**

Anda boleh memilih bahasa yang akan dipaparkan pada telefon. Bahasa lalai ialah Jerman.

### Aturan panggilan [Menu 4-4]

Anda boleh menetapkan menu relevan dengan panggilan dengan menekan  [Pilih] di dalam menu Setting.

#### Pengawas minit [Menu 4-4-1]

Jika anda memilih **Ya**, anda boleh memeriksa tempoh panggilan dengan bunyi bip setiap minit semasa panggilan.

#### Mana-mana ke kunci jawab [Menu 4-4-2]

##### • Ya [Menu 4-4-2-1]

Jika anda memilih menu ini, anda boleh menerima panggilan masuk dengan menekan sebarang kekunci kecuali kekunci .

##### • Tidak [Menu 4-4-2-2]

Jika anda memilih menu ini, anda boleh menerima panggilan masuk dengan hanya membuka pelipat.

#### ● Perhatian

##### • Bagaimana menggunakan BEBAS Tangan Mudah Alih.:

Jika anda mahu menggunakan Bebas Tangan Mudah Alih (fon telinga), tekan butang untuk masa yang lama selepas menyisipkan ia pada penyambung semasa panggilan masuk.

#### Hantar nombor [Menu 4-4-3]

(bergantung kepada rangkaian dan langganan)

##### • Ya [Menu 4-4-3-1]

Jika anda memilih menu ini, anda boleh menghantar nombor telefon anda kepada pihak yang satu lagi. Iaitu, nombor telefon anda akan dipaparkan pada telefon penerima.

##### • Tidak [Menu 4-4-3-2]

Jika anda memilih menu ini, anda tidak boleh menghantar nombor telefon anda.

##### • Kesalahan [Menu 4-4-3-3]

Jika anda memilih menu ini, telefon ini akan ditetapkan ke nilai lalai.

## Panggilan menu [Menu 4-4-4] (bergantung kepada rangkaian)

Jika khidmat ini Diupaya, anda boleh menerima panggilan (masuk) yang menunggu.

- **Aktifan [Menu 4-4-4-1]**  
Mengaktifkan khidmat yang sepadan.
- **Boleh [Menu 4-4-4-2]**  
Menyahaktifkan khidmat yang sepadan.
- **Periksa status [Menu 4-4-4-3]**  
Memeriksa Status khidmat.

## Redail Auto [Menu 4-4-5]

- **Ya [Menu 4-4-5-1]**  
Apabila fungsi ini diaktifkan, telefon anda akan membuat sehingga 10 percubaan untuk membuat panggilan selepas menyambung.
- **Tidak [Menu 4-4-5-2]**  
Telefon anda tidak akan membuat sebarang percubaan untuk menyambungkan panggilan selepas ia tidak dapat menyambungkan.

## Pilih rangkaian [Menu 4-4-6] (bergantung kepada rangkaian)

Fasilitas ini hanya digunakan jika **Pilihan rangkaian** disokong oleh Pembekal Khidmat. Dua nombor telefon berasingan didaftarkan untuk telefon. Fungsi ini memberi anda pemilihan nombor telefon yang sedang digunakan. Jika fungsi ini disokong oleh pembekal khidmat anda, menu yang berikut akan dipaparkan.

1. **Baris 1** : Pilih Line 1 sebagai nombor telefon semasa.
2. **Baris 2** : Pilih Line 2 sebagai nombor telefon semasa.

### Panggilan kemu [Memu 4-4-7]

#### (bergantung kepada rangkaian)

Dalam hal Khidmat Pernomboran Tunggal, anda boleh menggunakan telefon dan PC yang tersambung untuk menghantar dan menerima faks, data dan suara. Jika anda memilih mod ini, anda boleh menerima data, faks, atau suara setiap mod. Setelah anda memasuki menu ini, pilihan-pilihan berikut dipaparkan.

- **Suara**

Anda boleh menerima panggilan suara.

- **Data**

Anda boleh menerima panggilan data.

- **Faks**

Anda boleh menerima panggilan faks.





#### ● **Perhatian**

- Khidmat pernomboran tunggal bermakna bahawa nombor khidmat faks atau data adalah sama dengan nombor khidmat suara. Dan, mod-mod ini bergantung kepada ciri rangkaian.

## Aturan sekuriti [Menu 4-5]

### Kod PIN [Menu 4-5-1]

Di dalam menu ini, anda boleh menetapkan telefon supaya meminta Kod PIN kad SIM anda apabila telefon dihidupkan. Jika fungsi ini diaktifkan, anda diminta memasukkan Kod PIN.

1. Tekan  [Menu] dalam mod tunggu sedia.
2. Tekan  untuk akses langsung atau gunakan  dan  untuk memasuki Settings.
3. Tatal untuk menyerlahkan menu **Aturan sekuriti**.
4. Pilih PIN Code dengan menekan  [Pilih].
5. Anda boleh melihat submenu-submenu berikut.
  - **Boleh** : Mengupayakan permintaan Kod PIN.
  - **Tak Boleh** Melumpuhkan permintaan Kod PIN.

### Kunci telefon [Menu 4-5-2]

Anda boleh menggunakan kod keselamatan untuk mengelakkan telefon anda daripada digunakan tanpa izin. Apabila anda menghidupkan telefon anda, telefon anda akan sentiasa meminta kod keselamatan jika anda menetap penguncian telefon ke "Upayakan". Jika anda menetap penguncian telefon ke "Automatik". Telefon anda akan meminta kod keselamatan hanya apabila anda menukar kad SIM anda.



- Boleh
- Tak boleh
- Auto

### Automatik pad kekunci [Menu 4-5-3]

Apabila anda mengupayakan penguncian telefon Automatik, pad kekunci akan dikunci secara automatik pada skrin melalu selepas 25 saat tanpa sebarang permintaan kekunci.

- Boleh
- Tidak Perlu

#### ● Nota

- Jika anda mahu mengunci pad kekunci anda secara manual, masukkan menu Atas dan tekan kekunci .
- Jika anda mahu membuka kunci pad kekunci telefon anda, tekan [buka kunci] kekunci dan kemudian tekan kekunci . Tetapi jika anda telah mengupayakan penguncian telefon Automatik sebelum itu, penguncian pad kekunci telefon anda akan dibuka dan kemudian selepas 25 saat pad kekunci akan dikunci semula secara automatik.

### Sekat panggilan [Menu 4-5-4]

Khidmat Sekatan panggilan mencegah telefon anda daripada membuat atau menerima kategori panggilan tertentu. Fungsi ini memerlukan kata laluan sekatan panggilan. Anda boleh melihat submenu-submenu berikut.

- **Semua keluar:**

Khidmat sekatan bagi semua panggilan keluar.

- **Panggilan keluar intl:**

Khidmat sekatan bagi semua panggilan keluar antarabangsa.

- **Panggilan keluar intl roam:**

Khidmat sekatan bagi semua panggilan keluar antarabangsa kecuali rangkaian tanah air.

- **Semua masuk:**

Khidmat sekatan bagi semua panggilan masuk.

- **Panggilan masu:**

Khidmat sekatan bagi semua panggilan masuk apabila merayau.

- **Batal semua pe:**





Anda boleh membatalkan semua khidmat sekatan.

- **Tukar katalalua:**

Anda boleh menukar kata laluan untuk Khidmat Sekatan Panggilan.

### Nombor panggilan [Menu 4-5-5] (Bergantung kepada SIM)

Anda boleh menyekat panggilan keluar anda kepada nombor telefon yang terpilih. Nombor-nombor tersebut dilindungi oleh PIN2 Code anda.

1. Tekan  [Menu] dalam mod tunggu sedia.
2. Tekan  untuk akses langsung atau gunakan  dan  untuk memasuki Settings.
3. Tatal untuk menyerlahkan menu **Security**.
4. Pilih kod PIN1 dengan menekan  [Select].
5. Jika kod PIN2 betul, anda boleh melihat submenu-submenu berikut.

- **Pasang :**

Anda boleh menyekat panggilan keluar anda kepada nombor telefon yang terpilih.

- **Tutup:**







anda boleh memanggil tanpa menyekat nombor telefon.

- **Senarai nombor :**

Anda boleh melihat senarai nombor yang disimpan sebagai Nombor dial tetap.

### Tukar kod [Menu 4-5-6]

Anda boleh menukar kod-kod akses: **Kod PIN**, **Kod PIN2**, dan **Kod sekuriti**.

1. Tekan  [Menu] dalam mod tunggu sedia.
2. Tekan  untuk akses langsung atau gunakan  dan  untuk memasuki **Aturan**.
3. Tatal untuk menyerlahkan menu **Aturan sekuriti**.
4. Pilih **Tukar kod** dengan menekan  [Pilih].
5. Jika anda mahu menukar Kod PIN/Kod PIN2/Kod sekuriti, masukkan kod asal anda, dan kemudian tekan  [Okay].
6. Masukkan Kod PIN/Kod PIN2/Kod sekuriti, dan tentulah ia.

### **Aturan jaringan [Menu 4-6]**

Anda boleh memilih rangkaian yang anda akan daftarkan sama ada secara automatik atau manual. Biasanya, pemilihan rangkaian yang digunakan oleh telefon dibuat secara automatik.

#### **Auto [Menu 4-6-1]**

Telefon secara automatik memilih rangkaian yang terdapat di kawasan anda.

#### **Manual [Menu 4-6-2]**

Telefon akan mencari senarai rangkaian-rangkaian yang terdapat dan menunjukkannya kepada anda. Kemudian anda boleh memilih rangkaian yang ingin anda gunakan jika rangkaian ini mempunyai persetujuan merayau dengan operator rangkaian tanah air anda.

#### **Yang disukai [Menu 4-6-3]**

Anda boleh menetapkan satu senarai rangkaian-rangkaian yang lebih digemari untuk telefon cuba berdaftar dahulu, sebelum ia cuba berdaftar kepada sebarang rangkaian lain. Senarai ini dicipta daripada senarai telefon yang menyenaraikan rangkaian yang diketahui yang telah di pratarkrif.

#### **Kegunaan peng [Menu 4-6-4]**

Anda boleh menambah entri atau memadam yang baru dari senarai rangkaian. Ini boleh juga termasuk rangkaian-rangkaian baru yang kod-kod rangkaian tidak diketahui oleh telefon. Untuk melakukan ini, pilih dan kemudian masukkan kod rangkaian, kod negara dan nama rangkaian.

### **Kembalikan aturan kilang [Menu 4-7]**

Anda boleh menetapkan telefon kepada tatarajah lalai dengan memilih pilihan menetapkan semula Settings/Factory, dan kemudian mengesahkan pilihan ini.

## Alih panggilan [Menu 5]

(bergantung kepada rangkaian dan langganan)



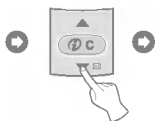
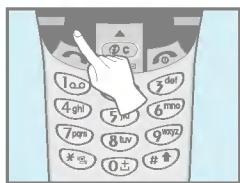

Mengakses Menu



<Tekan empat kali>



Khidmat Alihan panggilan membolehkan anda mengalihkan panggilan suara, panggilan faks, dan panggilan data yang masuk ke nombor lain. Untuk perincian, hubungi pembekal khidmat anda.

1. Tekan  [Menu] dalam mod tunggu sedia.
2. Tekan  untuk akses langsung atau gunakan  dan  untuk memasuki Alih panggilan.

### **Semua panggilan [Menu 5-1]**

Mengalihkan semua panggilan tanpa syarat.

### **Jika sibuk [Menu 5-2]**

Mengalihkan semua panggilan suara apabila telefon sedang digunakan.

### **Jika tak jawab [Menu 5-3]**

Mengalihkan semua panggilan suara apabila telefon dimatikan atau di luar kawasan khidmat.

### **Jika tak sampai [Menu 5-4]**

Mengalihkan panggilan yang tidak anda jawab.

### **Semua panggilan [Menu 5-5]**

Mengalihkan ke nombor dengan sambungan PC tanpa syarat.

## **Alih panggilan [Menu 5]**

Mengakses Menu

(bergantung kepada rangkaian dan langganan)

### **Semua panggilan faks [Menu 5-6]**

Mengalihkan ke nombor dengan sambungan faks tanpa syarat.

### **Submenu-submenu [Menu 5-x-x]**

Menu-menu **Alih panggilan** mempunyai submenu-submenu seperti yang ditunjukkan di bawah.

#### **Boleh [Menu 5-x-1]**

Mengaktifkan khidmat yang sepadan.

- **Peti mel suara [Memu 5-x-x-1]**

Menghantar lanjut kepada pusat mesej. Fungsi ini tidak disertakan di dalam menu-menu **Panggilan semua data** dan **Panggilan semua faks**.

- **Nombor lain [Memu 5-x-x-2]**

Memasukkan nombor untuk pengalihan.

- **Pilihan [Memu 5-x-x-3]**

Memaparkan senarai 5 nombor pengalihan.

#### **● Perhatian**

- Anda boleh memilih nombor yang anda mahu di dalam menu Nombor pilihan.

#### **Tak Boleh [Menu 5-x-2]**

Menyahaktifkan khidmat yang sepadan.

#### **Periksa status [Menu 5-x-3]**

Memeriksa Status khidmat yang sepadan.

### **Batal semua pe [Menu 5-7]**

Membatalkan semua khidmat alihan panggilan.

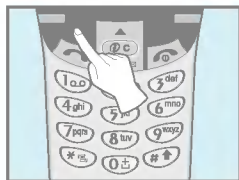

Apabila anda memasuki menu ini Kalendar akan terpapar. Di bahagian atas skrin terdapat bahagian-bahagian untuk tarikh dan ikon-ikon. Setiap kali anda menukar tarikh, kalendar akan dikemaskini menurut tarikh ini. Dan kursor empat segi akan digunakan untuk mencari hari tertentu. Jika anda melihat anak panah pada kalendar, ini bermakna terdapat jadual untuk hari itu. Fungsi ini membantu mengingatkan anda tentang jadual dan memo anda. Telefon akan membunyikan nada isyarat jika anda menetapkan penggera untuk nota tersebut.

Untuk menukar hari, bulan, dan tahun.

		Tahunan	 	Jika tekan kekunci sekali loceng jam akan diset. Jika tekan lebih lama ia akan diset migguan.
		Bulanan		

### Tambah baru [Menu 6-1]

Anda boleh menambar maksimum 30 perkataan. Anda boleh mengambil nota. Anda boleh memilih jenis-jenis nota berikut. Anda boleh membuat sehingga maksimum 20 nota.

#### **Jadual [Menu 6-1-1]**

Masukkan subjek, masa jadual, masa ulang, masa penggeraan dengan menekan [Pilih].



##### • **Ulang [Menu 6-1-1-1]**

- **Sekali** : tiada ulangan.
- **Harian** : ulang jadual harian untuk 5 hari.
- **Mingguan** : ulang jadual mingguan untuk 5 minggu.
- **Bulanan** : ulang jadual bulanan untuk 5 bulan.
- **Tahunan** : ulang jadual tahunan untuk 5 tahun.



### • Loceng [Menu 6-1-1-1]

- **Dalam masa tep** : menggera pada masa yang telah anda tetapkan.
- **10 min.seblm** : menggera 10 minit sebelum jadual yang telah anda tetapkan.
- **30 min.seblm** : menggera 30 minit sebelum jadual yang telah anda tetapkan.
- **1 jam seblm** : menggera 1 jam sebelum jadual yang telah anda tetapkan.
- **1 hari seblm** : menggera 1 hari sebelum jadual yang telah anda.



### Memo [Menu 6-1-2]

1. Pilih **Baru** dengan menekan  [Pilih].
2. Gerakan untuk menampilkan **Memo**.
3. Tekan  [Pilih].
4. Masukkan memo dan kemudian tekan  [Pilih].

### Lihat hari [Menu 6-2]

Memaparkan nota untuk hari yang terpilih. Gunakan  ,  untuk menyemak imbas senarai nota. Jika anda menetap penggera untuk nota, jam Penggera dipaparkan. Tekan  [Pilihan] untuk memadam, mengedit nota yang anda pilih.

### Lihat semua [Menu 6-3]

Memaparkan nota-nota yang telah ditetapkan untuk semua hari. Gunakan  ,  untuk menyemak imbas senarai nota. Menekan  [Pilihan] membolehkan akses kepada menu yang sama seperti Lihat hari.

### Padam terakhir [Menu 6-4]

Anda boleh memadam jadual terakhir yang anda telah diberitahu.

### Padam semua [Menu 6-5]

Anda boleh memadam semua nota(-nota).

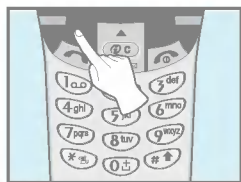

<Tekan enam kali>



### Permainan [Menu 7-1]

Telefon anda menyediakan permainan yang menarik.

#### ● Perhatian

Kekunci-kekunci Kawalan adalah berlainan untuk setiap permainan. Tetapi setiap permainan mempunyai skrin-skrin untuk menerangkan kekunci kawalan utama. Kekunci-kekunci lain yang sama disebutkan di bawah.

#### [Fungsi Kekunci Sama]

- [Soft 1 Key] : Mulakan Permainan,
- [CLR] : Henti Permainan Sebarang,
- [Soft 2 Key] : Kekunci lembut
- [END] : Tamat
- [Star Key] : Lampu latar
- [Soft 1 Key] : Simpan keputusan
- [▲], [▼], [0] ~ [9] : Kawalan paras  
[Kekunci Atas/Bawah, angka]

## Ubah unit [Menu 7-2]



Ini menukarkan sebarang ukuran ke dalam unit yang anda mahu. Terdapat 4 jenis yang boleh ditukarkan ke dalam unit-unit: **panjang, Kawasn, Berat, dan Saiz.**

1. Anda boleh memilih salah satu daripada empat jenis unit dengan menekan [Pilih].
2. Pilih unit yang ingin anda tukarkan dengan menekan dan .
3. Anda boleh menukar unit dengan menekan kekunci [tukar].
4. Anda boleh memasukkan nombor perdana dengan menekan kekunci .
5. Anda boleh memadam nombor yang anda mahu dengan menekan .
6. Tekan kekunci atau kekunci [Balik] jika anda mahu menamatkan proses menukar nilai.





## Kalkulator [Menu 7-3]

Ini mengandungi fungsi-fungsi standard seperti +, -, \*, ÷: **Tambah, Sama ja dengan, Bahagi, Tolak, Titik perpuluha dan Persamaan.**

1. Masukkan angka dengan menekan tombol angka.
2. Tekan [Pilihan] untuk memilih menu yang anda mahu seperti Tambah, Tolak, Darab, Bahagi, Negatif, Titik perpuluhan, Sama dengan.
3. Anda boleh melihat hasilnya dengan menekan kekunci [Pilihan] dan memilih sama **dengan**.
4. Jika anda mahu teruskan pengiraan, ulang proses tersebut.
5. Anda boleh memadam nombor atau tanda yang anda mahu dengan menekan .
6. Tekan kekunci jika anda mahu menamatkan proses pengiraan.

## **Masa dunia [Menu 7-4]**

Anda boleh melihat masa untuk setiap bandar di seluruh dunia.

apabila anda menekan  ,  sebentar, anda boleh melihat bandar yang termasuk dalam zon masa yang berlainan dan apabila anda menekan  ,  agak lama, anda boleh melihat semua bandar yang di dalam zon masa yang sama.

Jika anda mahu memilih negara yang anda mahu, tekan kekunci  [tetap].

### **● PC Sync**

PC Sync ialah satu program untuk pertukaran data menggunakan PC & Telefon melalui kabel data. Oleh itu, jika anda mahu menggunakan fungsi ini, anda perlu membeli kit aksesori. Untuk perincian lanjut bagi panduan penggunaan rujuk kepada fail PC Sync Help pada CD PC Sync.





Telefon ini menyokong khidmat-khidmat yang berdasarkan Protokol Aplikasi Wayarles (WAP). Anda boleh mengakses khidmat-khidmat yang disokong oleh rangkaian anda. Menu khidmat membolehkan anda mendapatkan maklumat seperti berita, laporan cuaca, dan masa-masa penerbangan.

### Rumah [Menu 8-1]

Anda boleh menyambung kepada laluan yang ditatarajah profil yang diaktifkan..

### Penanda [Menu 8-2]

Apabila anda memasuki menu ini, anda boleh melihat penanda-penanda buku. Kemudian tekan butang  untuk mengakses pilihan yang terdapat, atau tekan  untuk keluar.

- **Sambung** : Sambung kepada penanda buku yang terpilih.
- **Tambah baru**: Tambah penanda buku baru secara manual.
- **Edit** : Edit tajuk dan alamat penanda buku yang terpilih.
- **Padam** : Padam penanda buku yang terpilih dari senarai penanda buku.

### Profil [Menu 8-3]

Anda boleh membuat sehingga 5 profil dan aktifkan hanya satu daripadanya. Tatal ke profil yang diinginkan dan tekan  untuk mengakses pilihan-pilihan yang terdapat.

#### • **Aktifkan [Menu 8-3-1-1]**

Aktifkan profil yang terpilih.

- **Aturan [Menu 8-3-1-2]**

Submenu-submenu mestilah ditetapkan sebelum anda boleh menyemak imbas tapak-tapak WAP.

- **Laman Utama [Menu 8-3-1-2-1]**

Tetapan ini membolehkan anda memasukkan alamat (URL) tapak yang ingin anda gunakan sebagai laman. Anda tidak perlu menaip "http://" di depan setiap URL kerana Penyemak imbas WAP akan menambahkannya secara automatik.

- **Pamer imej [Menu 8-3-1-2-2]**

Anda boleh memilih sama ada imej-imej pada kad WAP dipaparkan atau tidak.

- **Jenis sambungan [Menu 8-3-1-2-3]**

Pilihan-pilihan untuk jenis sambungan ialah Sementara atau Berterusan dan bergantung kepada gerbang laluan yang anda gunakan.

- Berterusan [Menu 8-3-1-2-3-1]**

Satu mekanisme penghantaran yang disahkan tetapi menjana lebih banyak trafik rangkaian.

- Sementara [Menu 8-3-1-2-3-2]**

Satu khidmat yang tidak disahkan (Tanpa sambungan).

- **Aturan Selamat [Menu 8-3-1-2-4]**

Pilihan-pilihannya ialah **Aktif** dan Tak **Aktif** bergantung kepada get laluan yang anda gunakan.

- **Maklumat gate laluan [Menu 8-3-1-2-5]**

Kebanyakan get-get laluan WAP tidak memerlukan ID Pengguna dan Kata laluan. Jika get laluan anda memerlukan untuk menyambung kepadanya, rangkaian anda harus menyediakannya, dan anda mestilah menetapnya dengan betul sebelum menyemak imbas tapak WAP.

### - Aturan data [Menu 8-3-1-2-6]

Nilai-nilai tetapan ini disediakan oleh rangkaian anda.

**Alamat IP** : Masukkan alamat IP get laluan WAP yang anda gunakan untuk mengakses.

**No. dailan** : Masukkan nombor telefon untuk didail bagi mengakses get laluan WAP.

**Jenis panggilan** : Pilih jenis panggilan data: Analogue atau Digital(ISDN).

**Kelajuan panggilan** : Kelajuan sambungan data anda.

**ID Pengguna** : Pengenal pengguna bagi pelayan pendailan anda (dan BUKAN gerbang laluan).

**Katalaluan** : Kata laluan yang diperlukan oleh pelayan pendailan anda (dan BUKAN gerbang WAP) untuk mengenal pasti anda.

### - Penentu masa lengah [Menu 8-3-1-2-7]

Anda perlu memilih salah satu daripada 5 tempoh masa tamat. Selepas memilih salah satu daripadanya, khidmat ini tidak akan terdapat jika sebarang data tidak dimasukkan atau dipindahkan.

### • Nama semula [Menu 8-3-1-3]

Edit Nama Profil.

### • Pelayan E-mel [Menu 8-3-1-4]

Simpan URL pelayan E-mel yang sering anda gunakan.

### - Sambung [Menu 8-3-1-4-1]

Sambung kepada pelayan E-mel yang telah anda tatarajah.

### - Edit alamat [Menu 8-3-1-4-2]

Edit URL pelayan E-mel.

## Pergi ke URL [Menu 8-4]

Anda boleh menyambung langsung kepada tapak yang anda mahu. Anda perlu memasukkan URL tertentu yang anda mahu untuk menyambung langsung.

## **Aturan Cache [Menu 8-5]**

Anda boleh membuang kandungan memori cache atau menukar mod Cache.

### **Kosongkan cache [Menu 8-5-1]**

Kandungan memori Cache akan dibuang.

### **Cache periksa [Menu 8-5-2]**

Anda boleh menukar masa untuk memeriksa memori Cache.

- **Sentiasa [Menu 8-5-2-1]**

Cache sentiasa diperiksa apabila URL dimuat atau URL dipandu arah.

- **Mula sahaja [Menu 8-5-2-2]**

Cache hanya diperiksa apabila WAP dimulakan.

- **Tutup [Menu 8-5-2-3]**

Cache tidak pernah diperiksa.

## **Kawalan puas [Menu 8-6]**

Satu senarai sijil-sijil yang terdapat dipaparkan.

## **Reset profil [Menu 8-7]**

Anda boleh mentap semula semua tetapan semasa profil-profil kepada nilai lalai kilang.

Jika anda berada dalam talian, anda boleh melihat menu-menu berikut ini.

**Rumah**

Sama dengan <Menu 8-1>

**Muat semula**

Memuat turun semula halaman semasa.

**Penanda**

Sama dengan < Menu 8-2>

**Simpan sebagai penanda**

Mencipta penanda buku baru untuk halaman yang sedang anda lihat. Anda boleh memasukkan tajuk tapak.

**Pergi ke URL**

Bergerak ke tapak yang anda mahu. Di dalam menu ini, anda boleh mengedit alamat tapak yang ingin anda gerakkan.

**Pergi ke pelayan e-mel**

Bergerak ke pelayan E-mel yang telah anda tatarajah.

**Set sebagai pelayan e-mel**

Menetapkan alamat tapak semasa sebagai alamat pelayan E-mel.

Untuk dapat menggunakan khidmat data atau faks, anda perlukan perisian komunikasi seperti program data atau faks. Sebelum menggunakan fungsi-fungsi ini, anda perlu menyambungkan telefon anda kepada komputer atau memastikan telefon anda sedang tersambung kepada peranti yang serasi.

### **Menghantar Panggilan Data atau Faks**

1. Sambungkan komputer anda kepada telefon.
2. Selepas memulakan perisian komunikasi, buat panggilan dan hantar data atau faks.
3. Selepas penghantaran data atau faks, anda boleh menamatkan panggilan dengan hanya menamatkan perisian komunikasi, menekan  [Kekunci Tamat/Kuasa] atau dengan menutup pelipat.

### **Menerima Panggilan Data atau Faks**

Jika anda mempunyai nombor-nombor berasingan untuk panggilan suara, data atau faks, telefon anda mengenali jenis panggilan itu.

#### **Menerima Panggilan Data atau Faks – Nombor-nombor berasingan (Semua nombor)**

Untuk menggunakan khidmat data atau faks, paparan menunjukkan jenis panggilan yang sedang anda terima.

Untuk menerima panggilan data atau faks



1. Sambungkan komputer anda kepada telefon.
2. Selepas memulakan perisian komunikasi, terima panggilan dan dan terima data atau faks (jika ia tidak dijawab secara automatik).
3. Selepas penerimaan data atau faks, anda boleh menamatkan panggilan dengan hanya menamatkan perisian komunikasi, menekan  [Kekunci Tamat/Kuasa] atau dengan menutup pelipat.

### Menerima Panggilan Data atau Faks – Nombor tunggal

Jika anda mempunyai kad SIM yang tidak menyokong nombor-nombor suara, data dan faks yang berasingan, telefon tidak akan mengenali jenis panggilan masuk.

Untuk menggunakan khidmat data atau faks, pastikan anda mahu menerima mod panggilan data atau faks. Anda terlebih dahulu harus menekan telefon kepada salah satu pilihan-pilihan ini di dalam submenu mod panggil (Aturanpanggilan aturan panggilan berikut → Panggilan berikut).

Untuk menerima panggilan data atau faks



1. Tekan  [Menu] dalam mod tunggu sedia.
2. Pilih Aturan → Aturan panggilan → Panggilan berikut.
3. Pilih jenis panggilan yang anda mahu (Suara, Data atau Faks) dan tekan .
4. Sambungkan komputer anda kepada telefon.
5. Selepas memulakan perisian komunikasi, terima panggilan dan dan terima data atau faks (jika ia tidak dijawab secara automatik).
6. Selepas penerimaan data atau faks, anda boleh menamatkan panggilan dengan hanya menamatkan perisian komunikasi, menekan  [Kekunci Tamat/Kuasa] atau dengan menutup pelipat.

Setelah anda menetapkan telefon anda untuk panggilan masuk tertentu, ia kekal ditetap sehingga anda menukarnya.



Menu yang dipaparkan pada skrin telefon semasa panggilan adalah berlainan daripada menu utama lalai yang dicapai dari skrin melahu, dan pilihan-pilihannya diterangkan di sini.

### 1 SEMASA PANGGILAN



#### 1-1 Menahan Panggilan

Anda boleh menahan panggilan atau mendapatkan ia semula dengan hanya menekan kekunci  [Hantar]. Apabila panggilan dibuat atau dijawab, tekan kekunci  [Hantar] untuk menahan panggilan itu. Apabila sesuatu panggilan ditahan, tekan kekunci  [Hantar] untuk membuatnya aktif.

#### 1-2 Membuat Panggilan Kedua

Anda boleh mendapatkan nombor dailan dari buku telefon untuk membuat panggilan kedua. Tekan kekunci  [Nama] kemudian pilih **Cari**. Untuk menyimpan nombor dailan ke dalam buku telefon semasa panggilan, tekan  [Nama] kemudian pilih **Tambah baru**.

#### 1-3 Bertukar-tukar Antara Dua Panggilan



Untuk bertukar-tukar antara dua panggilan, pilih kekunci  [Menu], kemudian pilih Swap atau tekan saja kekunci  [Hantar].

Anda boleh membuat satu atau dua panggilan tertumpu dengan menekan kekunci anak panah atas/ bawah. Jika anda mahu menamatkan salah satu panggilan, buat panggilan yang ingin anda tamatkan tumpuan, kemudian tekan kekunci  [Kekunci Tamat/Kuasa] apabila panggilan yang anda ingin tamatkan ditumpukan.

#### 1-4 Menjawab Panggilan Masuk

Untuk menjawab panggilan masuk apabila telefon sedang berdering, tekan saja kekunci  [Hantar].



Telefon juga boleh memberi amaran kepada anda tentang panggilan masuk semasa anda sedang melayani panggilan lain. Satu nada berbunyi di cuping telinga, dan paparan akan menunjukkan bahawa terdapat panggilan kedua yang menunggu.

Ji Servis tunggu panggilan aktif, anda boleh menahan panggilan pertama dan menjawab panggilan kedua, dengan menekan  [Hantar] atau dengan memilih kekunci  [Menu], kemudian **Tahan & Jawab**.

Anda boleh menamatkan panggilan yang sedang berlangsung dan menjawab panggilan yang menunggu dengan memilih kekunci  [Menu], kemudian **Tamat & Jawab**.

### 1-5 Menolak Panggilan Masuk



Apabila tidak dalam panggilan anda boleh menolak panggilan masuk tanpa menjawab dengan hanya menekan kekunci  [Kekunci Tamat/Kuasa].

Apabila dalam panggilan anda boleh menolak panggilan masuk dengan menekan kekunci  [Menu] dan memilih Menerima/Tolak panggilan atau dsngan menekan kekunci  [Kekunci Tamat/Kuasa].

### 1-6 Mengawal kelantangan suara semasa panggilan

Anda boleh mengawal kelantangan suara semasa panggilan dengan menekan kekunci  [Menu] dan memilih **Kelantangan suara**.

### 1-7 Menutup Mikrofon

Anda boleh membisukan mikrofon semasa panggilan dengan menekan kekunci  [Menu] kemudian memilih senyap. Telefon boleh disuarakan dengan menekan  [Unmute] . Apabila telefon dibisukan, pemanggil tidak dapat mendengar suara anda, tetapi anda boleh mendengarkannya.

### 1-8 Mengaktifkan Nada DTMF Semasa Panggilan

Untuk mengaktifkan nada-nada **DTMF** semasa panggilan, misalnya, untuk membolehkan telefon anda menggunakan papan suis diautomasi, pilih kekunci  [Menu], kemudian **Pasang DTMF**. Nada-nada DTMF boleh dinyahaktifkan dengan cara yang sama.

### 1-9 Memanggil Menu Utama

Pilihan-pilihan menu Mesej dan SIM Tool kit boleh didapati dari menu dalam panggilan dengan menekan kekunci  [Menu], kemudian **Main** Menu. Menu SIM Tool kit dipaparkan hanya apabila SIM di dalam telefon menyokong khidmat SIM Tool kit.



## 2 Panggilan Semua Pihak atau Menerima

Khidmat semua pihak atau persidangan memberi anda keupayaan untu mengadakan perbualan serentak dengan lebih daripada seorang pemanggil, jika pembekal khidmat rangkaian anda menyokong ciri ini.

Panggilan semua pihak boleh diadakan apabila anda mempunyai satu panggilan aktif dan satu panggilan menunggu, dengan kedua-dua panggilan telah dijawab. Setelah panggilan semua pihak diwujudkan, panggilan boleh ditambahkan, diputuskan atau diasingkan (iaitu, dibuang dari panggilan semua pihak tetapi masih disambungkan kepada anda) oleh orang yang memulakan panggilan semua pihak. Pilihan-pilihan ini semuanya terdapat dari menu dalam panggilan dan disenaraikan di dalam Bahagian.

Bilangan maksimum pemanggil bagi panggilan semua pihak ialah lima. Sebaik saja ia bermula, andalah yang mengawal panggilan semua pihak tersebut, dan anda saja yang boleh menambah panggilan kepada panggilan semua pihak.

### 2-1 Membuat Panggilan Kedua

Anda boleh membuat panggilan kedua semasa anda sedang melayani panggilan lain. Untuk melakukan ini, masukkan nombor kedua dan tekan  [Hantar]. Apabila anda mendapat panggilan kedua, panggilan pertama ditahan secara automatik. Anda boleh bertukar-tukar antara panggilan dengan memilih kekunci  [Menu] kemudian **Tukar panggilan**.

### 2-2 Mewujudkan Panggilan Semua Pihak

Anda boleh menyambungkan panggilan yang ditahan kepada panggilan yang sedang aktif untuk membentuk panggilan semua pihak dengan memilih kekunci  [Menu] kemudian **Persidangan disertai**.

### 2-3 Menahan Panggilan Semua Pihak

Untuk membuat panggilan semua pihak, pilih kekunci  [Menu] kemudian **Persidangan/Tahan panggilan**.

### 2-4 Aktifkan Panggilan Semua Pihak yang Ditahan

Untuk membuat panggilan semua pihak, yang ditahan aktif, pilih kekunci  [Menu] kemudian **Persidangan/Tahan panggilan**.

### 2-5 Menambah Panggilan kepada Panggilan Semua Pihak

Untuk menyambungkan panggilan aktif kepada panggilan semua pihak yang ditahan, pilih kekunci  [Menu] kemudian **Persidangan/Tahan panggilan**.

### 2-6 Memaparkan Pemanggil dalam Panggilan Semua Pihak

Untuk menatal nombor-nombor pemanggil yang membentuk panggilan semua pihak pada skrin telefon, tekan kekunci  dan .



### 2-7 Menahan Panggilan daripada Anggota Panggilan Semua Pihak

Untuk menahan panggilan daripada seorang anggota panggilan pihak yang terpilih (yang minbornya sedang dipaparkan pada skrin), pilih kekunci  [Menu] kemudian **Tamat/Tidak termasuk**.

### 2-8 Panggilan Sulit Dalam Panggilan Semua Pihak

Untuk mengadakan panggilan sulit dengan seorang pemanggil panggilan semua pihak, paparkan nombor pemanggil yang ingin anda adakan perbualan sulit pada skrin, kemudian pilih kekunci  [Menu] dan **Persidangan/Sulit** untuk menahan semua pemanggil lain.

### 2-9 Menamatkan panggilan Semua Pihak

Pemanggil panggilan semua pihak yang sedang dipaparkan boleh diputuskan sambungannya dengan menekan kekunci  [End]. Untuk menamatkan panggilan semua pihak, tekan kekunci  [Menu] kemudian pilih **Tamat/Tamat** multiparty.

Memilih kekunci  [Menu] **Tamat/Tamat** all, akan menamatkan semua panggilan aktif dan yang ditahan.

### 2-10 Explicit Call Transfer (Pemindahan Panggilan Jelas) (ECT)

Jika anda mempunyai satu pemanggil yang ditahan dan satu lagi panggilan aktif, anda boleh menyambungkan satu pihak dengan pihak yang satu lagi dan kemudian meninggalkan panggilan tersebut.

Ini dilakukan dengan memilih pilihan Persidangan/Alih panggilan dari menu dalam panggilan.

**Apabila menggunakan unit ini, langkah-langkah berhati-hati keselamatan yang asas seperti di bawah harus sentiasa dipatuhi.**

- Jangan sentuh penyesuai dengan tangan yang basah.
- Jangan buka bahagian-bahagian unit ini. (Bawa ia kepada seorang juruteknik servis yang berkelayakan apabila kerja pembaikan diperlukan.)
- Jauhkan dari alat elektrik seperti TV, radio atau komputer peribadi.
- Unit ini harus dijauhkan dari sumber-sumber haba seperti penyinar atau alat memasak.
- Jangan jatuhkan.
- Lindungi unit ini daripada getaran atau kejutan mekanikal.
- Salutan telefon boleh rosak jika dibalut dengan pembalut vinil.
- Gunakan kain kering untuk membersihkan bahagian luar unit. (Jangan gunakan pelarut seperti benzena, pencair atau alkohol.)
- Jangan dedahkan unit ini kepada asap atau habuk yang berlebihan.
- Jangan simpan telefon bersebelahan kad kredit atau tiket pengangkutan; ia boleh menjejaskan maklumat pada jalur-jalur magnet.
- Jangan ketuk skrin dengan benda tajam; ini boleh merosakkan telefon.
- Jangan dedahkan telefon kepada cecair atau lembapan.
- Gunakan aksesori-aksesori seperti cuping telinga dengan berhati-hati. Jangan sentuh antenna jika tidak perlu.

### ■ Menjaga Bateri

- Anda tidak perlu menyahcas bateri sepenuhnya sebelum mengecas semula. Tidak seperti sistem-sistem bateri lain, tidak terdapat kesan memori yang dapat menjejaskan prestasi bateri.
- Gunakan hanya bateri-bateri dan pengecas-pengecas LG. Pengecas-pengecas LG direka bentuk untuk memaksimumkan hayat bateri.
- Jangan buka atau litar pintas pek bateri.
- Pastikan sentuhan-sentuhan logam pek bateri sentiasa bersih.
- Gantikan bateri apabila ia tidak lagi memberi prestasi yang boleh diterima. Pek bateri boleh dicas semula beratus-ratus kali sehingga ia perlu diganti.
- Cas semula bateri jika ia tidak digunakan buat masa yang lama untuk memaksimumkan penggunaannya.
- Jangan dedahkan pengecas bateri kepada cahaya matahari langsung atau gunakan ia dalam suasana kelembapan tinggi, seperti di dalam bilik air.
- Jangan tinggalkan bateri di tempat yang panas atau sejuk; ini boleh melemahkan prestasi bateri.

### Umum

---

Nama Produk : W3000

Sistem : GSM 900/DCS 1800

### Suhu Ambien

---

Maks : +55°C

Min : -10°C





# WAP Phone

## USER'S MANUAL

### MODEL: W3000

Please read this manual carefully  
before operating your set.  
Retain it for future reference.



**W3000 has a polished style which provides users' a better feel and convenience.**



## For Your Safety

All radio transmitters carry risks of interference with electronics in close proximity.



GSM Phones must be switched off at all times in an aircraft.



Do not activate near petrol stations, fuel depots, chemical plants or blasting operations.



Switch off the phone in any area where are forced by special regulations. For example, the phone does not allow to be used in hospital because pacemakers and hearing aids can be affected.



Minor interference may affect TVs, radios, PCs, etc.



Do not hold the phone in your hand while driving.



Do not dismantle phone or battery.



Keep the phone in a safe place out of children's reach since it contains the detachable small parts and create a choking hazard.



Do not touch the charger with wet hands.



For your safety, use **ONLY** specified **ORIGINAL** batteries and chargers.

### **Please note:**



Unusable batteries should be disposed of in accordance with relevant legislation.



Only use **ORIGINAL** accessories to avoid damage to your phone.



Emergency call may not be available under all cellular networks. Therefore, you should never depend solely on the phone for essential communications such as medical emergencies.

### **Important Information**

This user's guide contains important information on the use and operation of this phone. Please read all the information carefully for optimal performance and to prevent any damage to or misuse of the phone. Any changes or modifications not expressly approved in this user's guide could void your warranty for this equipment.

# Contents

## Overview

<b>Accessories</b> .....	<b>9</b>
<b>Part of the Phone</b> .....	<b>10</b>
• Front of the Phone .....	10
• Rear of the Phone .....	11
<b>Key Description</b> .....	<b>12</b>
• Alphanumeric Keys .....	13

## Display Information

<b>Display Information</b> .....	<b>14</b>
• On-Screen Icons .....	14

## Getting Started

<b>Installation</b> .....	<b>16</b>
• Inserting the SIM Card .....	16
• Installing the Battery .....	16
• Charging the Battery .....	17
• Disconnecting the charger .....	17
• Instructions for changing the front colour cover .....	18
<b>Powering On Sequence</b> .....	<b>19</b>
• To get started with the phone .....	19
• To turn off the phone .....	19
<b>Access Codes</b> .....	<b>20</b>
• PIN code (4 to 8 digits) .....	20
• PIN2 code (4 to 8 digits) .....	20
• PUK code (4 to 8 digits) .....	20
• PUK2 code (4 to 8 digits) .....	20
• Security code (4 to 8 digits) .....	20

## Accessing the Menu

<b>Phonebook</b> .....	<b>21</b>
• Search [Names 1] .....	21
• Add new [Names 2] .....	22
• Speed dial [Names 3] .....	23
• Voice list [Names 4] .....	23
• Caller groups [Names 5] .....	24

• Copy all [Names 6] .....	25
• Delete all [Names 7] .....	25
• Settings [Names 8] .....	25
• Information [Names 9] .....	26
<b>Menu Tree .....</b>	<b>27</b>
<b>Messages [Menu 1] .....</b>	<b>29</b>
• Write message [Menu 1-1] .....	29
• Inbox [Menu 1-2] .....	32
• Outbox [Menu 1-3] .....	33
• Info Service [Menu 1-4] .....	34
• Voice messages [Menu 1-5] .....	35
• Namecard [Menu 1-6] .....	36
• Templates [Menu 1-7] .....	36
• Settings [Menu 1-8] .....	37
• Check memory [Menu 1-9] .....	37
<b>Call Register [Menu 2] .....</b>	<b>38</b>
• Missed calls [Menu 2-1] .....	38
• Received calls [Menu 2-2] .....	38
• Dialed calls [Menu 2-3] .....	38
• Clear recent calls [Menu 2-4] .....	38
• Call charge [Menu 2-5] .....	39
<b>Profiles [Menu 3] .....</b>	<b>41</b>
• Vibrate only [Menu 3-1] .....	41
• Quiet [Menu 3-2] .....	41
• General [Menu 3-3] .....	41
• Loud [Menu 3-4] .....	42
• Headset [Menu 3-5] .....	42
• Car [Menu 3-6] .....	42
<b>Settings [Menu 4] .....</b>	<b>44</b>
• Alarm clock [Menu 4-1] .....	44
• Date & Time [Menu 4-2] .....	45
• Phone settings [Menu 4-3] .....	46
• Call settings [Menu 4-4] .....	47
• Security settings [Menu 4-5] .....	49
• Network settings [Menu 4-6] .....	52
• Restore factory settings [Menu 4-7] .....	52

<b>Call Divert [Menu 5]</b> .....	<b>53</b>
• All voice calls [Menu 5-1] .....	53
• If busy [Menu 5-2] .....	53
• If no reply [Menu 5-3] .....	53
• If unreachable [Menu 5-4] .....	53
• All data calls [Menu 5-5] .....	53
• All fax calls [Menu 5-6] .....	54
• Cancel all [Menu 5-7] .....	54
<b>Scheduler [Menu 6]</b> .....	<b>55</b>
• Add new [Menu 6-1] .....	55
• View day [Menu 6-2] .....	56
• View all [Menu 6-3] .....	56
• Delete passed [Menu 6-4] .....	56
• Delete all [Menu 6-5] .....	56
<b>Fun &amp; Tools [Menu 7]</b> .....	<b>57</b>
• Game [Menu 7-1] .....	57
• Unit convert [Menu 7-2] .....	58
• Calculator [Menu 7-3] .....	58
• World time [Menu 7-4] .....	59
<b>Internet [Menu 8]</b> .....	<b>60</b>
• Home [Menu 8-1] .....	60
• Bookmarks [Menu 8-2] .....	60
• Profiles [Menu 8-3] .....	60
• Go to URL [Menu 8-4] .....	62
• Cache settings [Menu 8-5] .....	63
• Security certifications [Menu 8-6] .....	63
• Reset profiles [Menu 8-7] .....	63
<b>Internet On- line menu</b> .....	<b>64</b>

## **Additional Functions**

<b>How to Use Data and Fax call</b> .....	<b>65</b>
• Sending Data or Fax Calls .....	65
• Receiving Data or Fax Calls .....	65
<b>In call Menu</b> .....	<b>67</b>
• 1 During a call .....	67
• 2 Multiparty or Conference Calls .....	69
<b>Care and Maintenance</b> .....	<b>71</b>
<b>Technical Data</b> .....	<b>73</b>

Check to make sure that you have all the parts shown below.



Handset



Standard Battery  
(BSL-15GA)



Changeable  
front cover



User's manual



Warranty Card(s)



Neckstrap

Travel Adapter

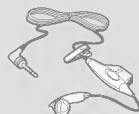

Portable Handsfree  
(EM-LG416B)

## <Optional Accessories>



Changeable  
front cover

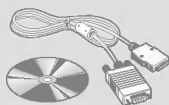

Data Kit/CD

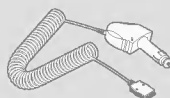

Cigar Lighter  
Adapter

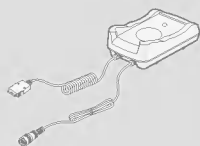

Handsfree Kit

## Front of the Phone

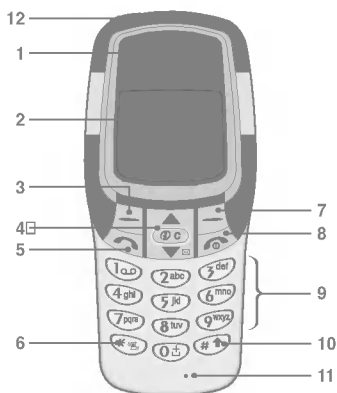

- |                   |                             |
|-------------------|-----------------------------|
| 1 Earpiece        | 8 END/PWR keys              |
| 2 Display Screen  | 9 Numeric Keys              |
| 3 Soft Left Key   | 10 Hash Key                 |
| 4 Navigation Keys | 11 Microphone               |
| 5 Send Key        | 12 Ear Microphone Connector |
| 6 Star Key        |                             |
| 7 Soft Right Key  |                             |



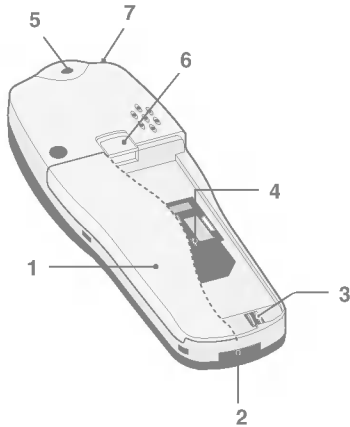









## Rear of the Phone



- 1 Battery
- 2 Cable Connector/  
Battery Charging Connector/  
Hands-Free Car kit Connector/
- 3 Battery Terminals
- 4 SIM Card Socket
- 5 Handstrap Hole
- 6 Battery Lock
- 7 Ear Microphone Connector

The following shows key components of the phone.

## Keypad Description

Key	
	<p><b>Soft Left Key / Soft Right Key</b> Each of these keys performs the function indicated by the text on the display immediately above it.</p>
	<p><b>WAP Hotkey</b> Used to connect to <b>WAP</b> directly by pressing this key. Used to delete character(s).</p> <p><b>Navigation Keys</b> Used to scroll through name, phone numbers, menus or setting options.</p>
	<p>Used to enter <b>Message</b> menu directly.</p>
	<p>Used to scroll through names, phone numbers.</p>
	<p><b>Send Key</b> You can dial a phone number and answer a call. If you press this key without entering a number, your phone shows the most recently dialed number.</p>
	<p><b>Numeric Keys</b> These keys are used mainly to dial in standby mode and enter numbers or characters in editing mode. When you press these keys for a long time.</p> <ul style="list-style-type: none"> <li>Used to call your voicemail box by .</li> <li>Used to call for international call by .</li> <li>Used to call Speed dials by from  to .</li> </ul>
	<p>Used to enter the vibration mode by pressing this key for a long time</p>
	<p>Used to call by voice dial with long pressing this key. This key is also used as Ear mic. hook key when connecting Ear mic.</p>
	<p><b>END/PWR Key</b> Used to end or reject a call. This key is also used as Power Key. Pressing and holding this key for a few seconds.</p>

















## Alphanumeric Keys

The alphabet and numerical keypad mapping relation are listed as the following table.









Key	
1  <b>1</b>	. , ' ? ! - & 1
2  <b>2</b>	A B C 2 Ä Å Ã Æ Ç a b c ä å á â ã ø ç
3  <b>3</b>	D E F 3 È É Ê Ë d e f è é ê ë
4  <b>4</b>	G H I 4 Î Ï Ì Í Ĵ ħ i î ï ï í
5  <b>5</b>	J K L 5 j k l
6  <b>6</b>	M N O 6 Ö Õ Ò Ó Ø Ñ m n o ö ò ó ø ñ
7  <b>7</b>	P Q R S 7 p q r s
8  <b>8</b>	T U V 8 Ü Û Ú Ó t u v ü ù ú ó
9  <b>9</b>	W X Y Z 9 w x y z
0  <b>0</b>	0 [Space Key]

The screen displays several icons the following describe each of them you may see on the phone.

## On-Screen Icons

Icon/Indicator	
	Tells you the strength of the network signal.
	Call is connected.
	Line 1/2 is in use for outgoing calls - If you subscribe to the Two Line Service.
	The alarm has been set and is on.
	Tells you the status of the battery.
	You have received a text message.
	You have received a voice message depending on your subscription.
	You have received an E-mail.
	You can view your schedule.
	All audible signals are turned off.
	General menu in profiles.
	Loud menu in profiles.
	Quiet menu in profiles.
	Headset menu in profiles.
	Handsfree menu in profiles.
	You can divert a call.

## Top Menu Icons

Icon	
	Messages
	Call register
	Profiles
	Settings
	Call divert
	Scheduler
	Fun & Tools
	Internet
	Sim service

### ① Inserting the SIM Card

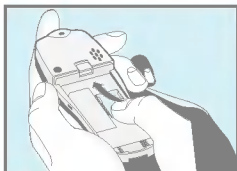

Locate the SIM card socket in the back of the phone.

Follow the steps below to install the SIM card.

1. Remove the battery if attached.
2. Slide the SIM card into the slot, under the silvery holders, with the golden connectors facing down and the cut corner to the right,

#### ● Notice

- Before installing always make sure that the phone is switched off and remove the battery.
- The metal contact of the SIM card can be easily damaged by scratches. Pay special attention to the SIM card when you handle and install. Follow the instructions supplied with the SIM card.

### ② Installing the Battery



1. Place the battery on the back of the phone.

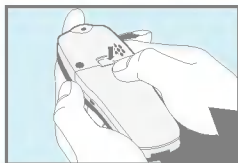

2. Push it until you hear a click.

### 3 Charging the Battery

To connect the travel adapter to the phone, you must have installed the battery.

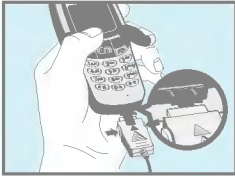

1. Insert one end of the travel adapter into the bottom of the phone.

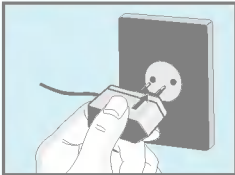

2. Connect the other end of the travel adapter to an AC wall outlet.  
Use only the included packing charger.



#### ● Warning

- Do not force the connector as this may damage the phone and/or the travel adapter.

### 4 Disconnecting the charger



Disconnect the travel adapter from the phone by pressing its side buttons.

## ● Notice

- The battery delivered with your phone has to be fully charged before using it.
- Do not remove your battery or the SIM card while charging.
- “Battery Charging” is displayed on the screen after connecting the travel adapter. Only if the battery is totally empty, Back light is on without displaying “Battery Charging”.
- The moving bars of battery icon will stop after charging completely.

## ⑤ Instructions for changing the front colour cover

Before changing the cover, always switch off the power and disconnect the phone from the charger or any other device.

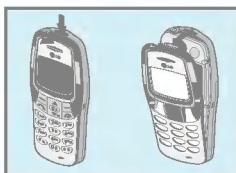

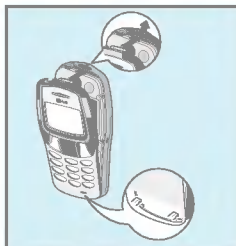
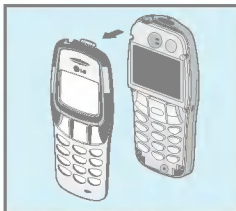

1. To remove the cover, press the locking catch of the cover for example with a coin, Start to open the cover from its upper part.

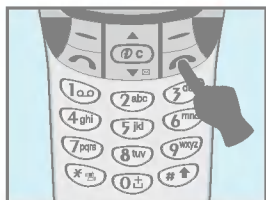

2. To replace the cover, first place and close the catch in the lower part of the cover into the corresponding hole in the phone and then gently close the whole cover.

### ① To get started with the phone



1. Press and hold  key until you hear a tone.
2. Depending on setting **PIN Code** [Menu 4-5-1], you can enter PIN code or not.
3. If your phone connects to a network, the network name will be displayed shortly.

### ② To turn off the phone

In stand by mode, press and hold  key until you hear a tone.

You can use the access codes described in this section to avoid unauthorized use of your phone. The access codes (except PUK and PUK2 codes) can be changed by using [Menu 4-5-6].

### **PIN code (4 to 8 digits)**

The PIN (Personal Identification Number) code protects your SIM card against unauthorized use. The PIN code is usually supplied with the SIM card. When **PIN code** is set **Enable**, your phone will request the PIN code every time it is switched on. On the contrary, when **PIN code** is set **Disable**, your phone connects to the network directly without the request PIN code.

### **PIN2 code (4 to 8 digits)**

The PIN2 code, supplied with some SIM cards, is required to access some functions such as Advice of call charge, Fixed Dial number. These functions are only available if supported by your SIM card.

### **PUK code (4 to 8 digits)**

The PUK(Personal Unblocking Key) code is required to change a blocked PIN code. The PUK code may be supplied with the SIM card. If not, contact your local service provider for the code. If you lose the code, also contact your service provider.

### **PUK2 code (4 to 8 digits)**

The PUK2 code, supplied with some SIM cards, is required to change a blocked PIN2 code. If you lose the code, also contact your service provider.

### **Security code (4 to 8 digits)**

The security code protests the unauthorized use of your phone. It is usually supplied with the phone. This code is required to delete all phone entries and to activate "Factory reset" menu. The default number of Security code is "0000". You can also change it in Security menu.









To select a menu in phonebook, press  [Names] in standby mode and then scroll to a desired item.

1	<b>Search</b>	Allows you to search for a specific name, number.
2	<b>Add new</b>	Allows you to add new names and numbers.
3	<b>Speed dial</b>	Allows you to assign up to 8(2-9) one-touch dial allocations.
4	<b>Voice list</b>	Allows you to list phone numbers which is attached voice.
5	<b>Caller groups</b>	Allows you to show group list.
6	<b>Copy all</b>	Allows you to copy entries from your Phone memory to SIM card or from SIM card to Phone memory.
7	<b>Delete all</b>	Allows you to erase all the data in either your phonebook or the SIM card to the phone memory.
8	<b>Settings</b>	Allows you to set the memory and to search item by Variable, name and number.
9	<b>Information</b>	Allows you to check the status of memory, SDN(Service Dial Number), and Own number.

## Search [Names 1]

(Calling from phonebook)

1. Open the phonebook first by pressing  [Names] in a standby mode.
2. **Search** by Pressing  [Select] to enter.
3. Depending on setting **Search by**, the below menu may not appear.
  - **Name**
  - **Number**
4. You can find an entry by name and number.
5. Select  [Search].
6. You can check the names and numbers by pressing  [List].









7. If you want to edit, delete, copy an entry, or to add the voice to one, select  [Options]. The below menu will be displayed.
- **Edit** : You can edit the name, number, E-mail, and fax by pressing .
  - **Delete** : You can delete an entry.
  - **Copy** : You can copy a entry from SIM to phone or from phone to SIM.
  - **Call** : You can call thru the chosen entry.
  - **Voice** : You can add the voice to the entry or change the voice tag.
  - **Main number**: You can select the one out of mobile, home, office that you often use. The main number will be displayed first, if you set this.

## Add new [Names 2]

You can add phonebook entry by using this function.

Phone memory capacity is 200 entries. SIM card memory capacity depends on the service provider.

You can also save 20 characters of name in the Phone memory, and you can save characters in the SIM card. the number of character is SIM dependent feature.

1. Open the phonebook first by pressing  [Names] in standby mode.
2. Scroll to highlight **Add new**, and press  [Select] to enter.
3. Select the memory you want to save: **SIM** or **Phone**.
  - **SIM** : You can add name and number for entry.
    - a. Write a name to add.
    - b. Press  [OK], then you can input a number.
    - c. Press  [OK].
    - d. If you want to add the voice, press  [Yes].
  - **Phone** : You can add name, mobile, home, office, fax no. and E-mail address.
    - a. Write a name to add.
    - b. Press  [OK].
    - c. Enter the numbers following as mobile, home, office, and fax by pressing  [OK]. Also you can input E-mail address.
    - d. If you want to add the voice, press  [Yes].



You should speak a word within 2 seconds, and the phone asks you to speak it again to ensure the accuracy of voice recognition. After voice recognition has finished, Voice is attached automatically.

### Note





- The voice can only be attached to main number which you set. For example, If you change main number voice will be automatically attached changed number.
- You can add voice tag to phone number in SIM card. The voice tag can be erased removing or changing SIM card. And voice tag attached to phone number in SIM card may be attached to another phone number when you changed SIM card. Why? The answer is that SIM card doesn't contain information about voice tag.

## Speed dial [Names 3]

You can associate any of the keys 2 to 9 with a Name list entry. You can call directly by pressing this key for 2-3 seconds.

1. Open the phonebook first by pressing  [Names] in a standby mode.
2. Scroll to **Speed dial**, then press  [Select] to enter this menu.
3. Every Speed dial will be displayed.
4. If you want to add Speed dial, select <Is Empty>. Then, you can search the name in phonebook.
5. If you select allocated name by speed dial, you can view following the submenus.
  - **Change** : You can change the allocation of speed dial number.
  - **Undo speed dial**: You can delete the allocated speed dial number.



## Voice list [Names 4]

You can see all phone numbers which contain voice. You can also call directly by pressing  [Send]. After selecting phone number by using and  and  press  [Options], you can see following the submenus.

- **Play** : You can play voice which is attached to phone number.
- **Change**: You can change voice which is attached to phone number.
- **Delete** : You can delete voice which is attached to phone number.
- **Call** : You can call by selecting this menu.

## Caller groups [Names 5]

You can list up to 20 members per one group. There are 7 groups you can make lists to.

1. Press  [Names] to enter into the phonebook in standby mode.
2. Scroll to **Caller groups** then press  [Select] to enter this menu.
3. Every Group list will be displayed.: **Family, Friend, Colleague, VIP,** etc.
4. Select Group name that you want to manage by pressing  [Select].
5. Then submenus below will be displayed.

- **Add member**

You can add the number in Caller groups.

- **View member**

- You can view the number list in Caller groups.
- You can select the member you want by pressing  [Options] then you can enable the submenu such as **Edit, Delete.**

- **Group ring tone**

- You can set the ring tone depending on Group.

- **Group icon**

- You can set icon depending on Group.

- **Change name**



- You can change and edit the Group name.

### ● Note

- This menu "**Change name**" will be displayed only when you select "**Empty**".





## Copy all [Names 6]

You can copy/move entries from SIM card memory to Phone memory or from Phone memory to SIM card memory.

1. Open the phonebook first by pressing  [Names] in standby mode.
2. Scroll to **Copy all**, then press  [Select] to enter this menu.
3. Then submenus below will be displayed.
  - **SIM to Phone**: You can copy the entry from SIM Card to Phone memory.
  - **Phone to SIM**: You can copy the entry from Phone memory to SIM Card.



## Delete all [Names 7]

You can delete all entries in **SIM**, **Phone**, and **Voice**. This function requires Security code.

1. Press  [Names] to enter into the phonebook in standby mode.
2. Scroll to **Delete all**, then press  [Select].
3. Then select a memory to erase: SIM, Phone, Voice.
4. And then you will be requested to enter Security code.
5. Press  [OK] or, press  [Back] to cancel.

## Settings [Names 8]

You can set preferred memory which includes **Variable**, **SIM** or **Phone** and preferred search which includes **Variable**, **Name and Number**.

1. Open the phonebook first by pressing  [Names] in a standby mode.
2. Scroll to **Settings**, then Press  [Select] to enter.
3. Then submenus below will be displayed.
  - **Set memory**
    1. Scroll to highlight **Set memory**, then press  [Select] to enter.
    2. The three submenus are displayed.
      - **Variable** : If you select Variable, the phone asks you where to store whenever you add entries in Phonebook.
      - **SIM** : If you select SIM, the phone stores entries to SIM directly without asking you where to store.
      - **Phone** : If you select Phone, the phone stores entries to Phone directly without asking you where to store.





## • Search by

1. Scroll to highlight Search by, then press  [Select] to enter.
2. The three submenus are displayed.
  - **Variable** : If you select Variable, the phone asks you how to search the entries.
  - **Name** : If you select Name, the phone searches entries by name.
  - **Number** : If you select Number, the phone searches entries by number.

## Information [Names 9]

### SDN (Service Dial Number)

Use this function to access a particular list of services provided by your network operator (if supported by the SIM card).

1. Open the phonebook first by pressing  [Names] in a standby mode.
2. Scroll to **SDN**, then Press  [select] to enter.
3. The names of the available services will be shown.
4. Use  and  to select a service. Press  [Send].

### Check memory

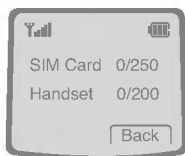

This feature allows you to see how many free and in-use are in your phonebook.

1. Open the phonebook first by pressing  [Names] in standby mode. Select **Information** by pressing  [Select].
2. Scroll to **Check memory**, then press  [select] to enter this menu.

### Own number (SIM dependent)

You can check your own number in SIM card.



## 1 Messages

- 1 Write message
  - Send
  - Save
  - Use template
  - Use namecard
  - Add dictionary
  - List dictionary
- 2 Inbox
  - Delete
  - Edit
  - Forward
  - Get number
  - Reply
  - Return call
- 3 Outbox
  - Delete
  - Edit
  - Forward
  - Get number
- 4 Info service
  - 1 Read
  - 2 Receive CB
  - 3 Alert
  - 4 Language
  - 5 Topics
- 5 Voice messages
  - 1 Listen to voice message
  - 2 Voice mailbox number
- 6 Namecard
- 7 Templates

## 8 Settings

- 1 Message type
  - 2 Validity period
  - 3 Status report
  - 4 Pay for reply?
  - 5 SMS centre
- ## 9 Check memory



## 2 Call Register

- 1 Missed calls
- 2 Received calls
- 3 Dialed calls
- 4 Clear recent calls
- 5 Call charge
  - 1 Call duration
  - 2 Show call costs
  - 3 Cost settings



## 3 Profiles

- 1 Vibrate only
- 2 Quiet
- 3 General
- 4 Loud
- 5 Headset
- 6 Car



## 4 Settings

- 1 Alarm clock
  - 1 Enable
  - 2 Disable
- 2 Date & Time
  - 1 Date
  - 2 Time
- 3 Phone settings
  - 1 Display
  - 2 Language
- 4 Call setting
  - 1 Minute minder
  - 2 Any key answer
  - 3 Send number
  - 4 Call waiting
  - 5 Auto redial
  - 6 Select line
  - 7 Next incoming
- 5 Security settings
  - 1 PIN code
  - 2 Phone lock
  - 3 Automatic key lock
  - 4 Call barring
  - 5 Fixed dial num.
  - 6 Change code
- 6 Network settings
  - 1 Automatic
  - 2 Manual
  - 3 Preferred
  - 4 User define
- 7 Restore factory settings



## 5 Call Divert

- 1 All voice calls
- 2 If busy
- 3 If no reply
- 4 If unreachable
- 5 All data calls
- 6 All fax calls
- 7 Cancel all



## 6 Scheduler

- 1 Add new
  - 1 Schedule
  - 2 Memo
- 2 View day
- 3 View all
- 4 Delete passed
- 5 Delete all



## 7 Fun & Tools

- 1 Game
- 2 Unit convert
- 3 Calculator
- 4 World time



## 8 Internet

- 1 Home
- 2 Bookmarks
- 3 Profiles
- 4 Go to URL
- 5 Cache settings
  - 1 Clear cache
  - 2 Cache check
- 6 Security certifications
- 7 Reset profiles



## 9 Sim Service

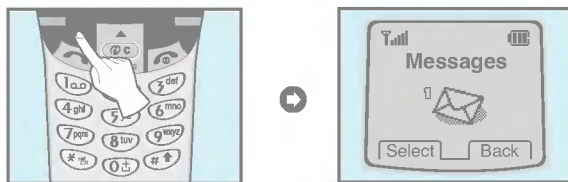

This menu depends on SIM and the network services.



This menu includes functions related to SMS (Short Message Service), voice mail, as well as the network's service messages.



### Write message [Menu 1-1]

You can write and edit text message up to 1024 characters. Also, you can check the number of characters.

1. Enter the **Messages** menu by pressing  [Select].
2. If you want to write a new message, select **Write message** in the menu.
3. Input the message by using eZi text. For details, see eZi text (Page 31).
4. When you finish writing your message, press  [Options]. Then following option menu will be displayed.



### Send

Sends the text message.

1. If you want to send the text message, enter the number you want.
2. Your phone asks you to enter the number that you want to send it to.
3. After sending it, your phone asks whether you will store the edited message.
4. Press  if you want to store it in Outbox and press  if you don't want to.

### Save

Stores the message in Outbox.

1. Your phone asks whether you will save the edited message.
2. Press  if you want to save it in Outbox and press  if you don't want to.

## Use template



The template is pre-defined message. You can add the template of the list to the message when you edit it.

## Use namecard

The items of the name card are a name, mobile, office, and memo. You can add a namecard to the message.



## Add dictionary

If you add a word you use often, you can input it by pressing a key once for each character.

1. Enter the menu.
2. Scroll to highlight **Add dictionary**, and then press  [Select].
3. Input a word, and then press  [Add].

## List dictionary

You can view the list you already saved words in a dictionary.

1. Enter the menu.
2. Scroll to highlight List dictionary, and then press  [Select].
3. You can check the word list.
4. If you want to delete a word, press  [Delete].
5. If you want to delete all words in a list, select **Delete all** at the bottom of the list by pressing  [Select].

## eZi-Text

The eZi text allows you to type easily and quickly. If you just press a key marked a character on the keypad, you can get a character you want. It is useful to make a word and a sentence. If you press  key for a long time, you can change the type of language.

Also, the phone supports four modes: **eZi Mode**, **Numeric mode**, **Capital mode**, and **Small mode**. If you want to change mode, press  key.

### • How to Use in eZi mode

To input a character in eZi text mode, you just press each key once for a character you want.

For example, to write **Girl** in eZi mode;

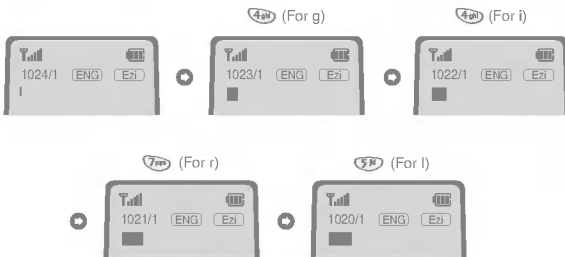

### • How to use in Numeric mode



To input a number in Numeric mode, you press a number key displayed on the keypad.

### • How to use in Capital mode



To input Capital letter, you press a character key displayed on the keypad.

### • How to use in Small mode





To input Small letter, you press a character key displayed on the keypad.

### ● Note

- If you want to input a symbolic character, press  key in each mode.

## Inbox [Menu 1-2]

When you receive a text message, your phone shows the symbol and stores it in the incoming message lists. Scroll to the desired message by using  ,  . In addition, you can see Delete all for deleting all incoming messages at the bottom of the list. While reading the message, press  [Options] to access the available options.

### Delete

The selected message is deleted.

### Edit

You can edit an incoming message and send or save the edited message.

### Forward

You can forward the selected message to the other party.

### Get number

If the selected message has the phone number, you can extract and save it in a phonebook. Also, you can call by this number.





## Reply

You can reply to the sender by message.

## Return call

You can call back to the sender who sent the message automatically.

## Outbox [Menu 1-3]

When you enter this menu, you can see the message(s). Scroll to the desired message by using  ,  and press  to see the message. And if you want to exit **Outbox** menu, press .

And if you want to exit outbox menu, press . In addition, you can see **Delete all** for deleting all outgoing messages at the bottom of the list.

After reading message, press  [Options] to access the following submenus.

## Delete

The selected message is deleted.

## Edit

You can edit an outgoing message and send or save it.

## Forward

You can forward the selected message to the other party.

## Get number



If the selected message has the phone number, you can extract and save it in a phonebook. Also, you can call by this number.

### Info Service [Menu 1-4]

#### **(Dependent to network and subscription)**

Cell Broadcast messages (CB Message) are text messages by the network to GSM phone users. They provide general information such as weather reports, traffic news, taxis, pharmacies, and stock prices. Each type of information has the number; therefore, you can contact service provider. When you receive CB message, you can read it following sequence:

#### **Read [Menu 1-4-1]**

1. When you receive CB message, it will be displayed on the screen. You can read the message by scrolling  ,  .
2. After reading the message, press  to return to the standby mode. In addition, you can save it until another message is reached.

#### **Receive CB [Menu 1-4-2]**

- **Yes**

If you select this menu, your phone will receive the Cell Broadcast message.

- **No**

If you select this menu, your phone will not receive the Cell Broadcast message any more.

#### **Alert [Menu 1-4-3]**

- **Yes**

If you select this menu, your phone will beep when Cell broadcast message is received.

- **No**

If you select this menu, your phone will not beep despite Cell broadcast message is received.

## Language [Menu 1-4-4]

You can select the language you want. Then your phone will receive the cell broadcast message in the language selected by you.

You can select Cell broadcast language pressing  [Select]. The language list which you selected already will be displayed with check box.

## Topics (Dependent to network and subscription) [Menu 1-4-5]

- **Add [Menu 1-4-5-1]**

If you select this menu, you will add the CB message category in Phone memory.

- **View list [Menu 1-4-5-2]**

If you select this menu, you can see CB message category. If you press  [Option], you can edit and delete it.

- **Active list [Menu 1-4-5-3]**

You can select the CB message category in active list by pressing  [Select].

## Voice messages [Menu 1-5]

You can listen to your voice message(s) and get the voicemail centre number.

### **Listen to voice message [Menu 1-5-1]**

You can call voicemail centre if you want to listen to voice message.

### **Voice mailbox number [Menu 1-5-2]**

You can get the voicemail if this feature is supported by the network service provider. When new voicemail is arrived, the symbol will be displayed on the screen. Please check with your network service provider for details of their service in order to configure the handset accordingly.

1. Press **Tab** key for a long time in standby mode.
2. You can check the following submenus.

- **Home [Menu 1-5-2-1]**

The number dialed on the home network to listen to voicemail.

- **Roam [Menu 1-5-2-2]**

The number dialed when other networks to listen to voicemail.

### **Namecard [Menu 1-6]**

It's for editing the namecard. The items of the namecard are a name, mobile, office, and memo.

- **Edit** : You can edit a namecard.
- **Delete** : You can delete a namecard.

### **Templates [Menu 1-7]**

It's for editing pre-defined messages. You can see 11 pre-defined messages in the list. You can save 6 templates before you edit. But you can change them. The others are <Empty>.

- **Edit** : You can edit a template.
- **Delete** : You can delete the template.

## **Settings [Menu 1-8]**

### **Message type [Menu 1-8-1]**

**Text, Voice, Fax, Natl. paging, X.400, E-mail, ERMES**

Usually, the type of message is set to **Text**. You can convert your text into alternative formats, which are suitable for the device that will be received the message. Contact your service provider for the availability of this function.

### **Validity period [Menu 1-8-2]**

This network service allows you to set how long your text messages will be stored at the message center while attempts are made to deliver them to you.

### **Status report [Menu 1-8-3]**

If you set **Yes** in this menu, you can check whether your message is sent successfully or not.

### **Pay for reply? [Menu 1-8-4]**

When a message is sent, it allows the person to whom you sent the message to reply and charges the cost of the reply to your telephone bill.

### **SMS centre [Menu 1-8-5]**

If you want to send the text message, you can get the address of SMS center thru this menu.

### **Check memory [Menu 1-9]**

If you select this menu, the phone shows an used memory and total amount of memory. The total memory is the sum of SIM and Phone memory.

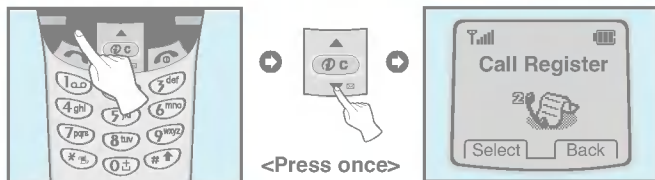

<Press once>

### Missed calls [Menu 2-1]

This menu shows recent missed call number(s). You can call by this number, save it or view date and time in this menu.

### Received calls [Menu 2-2]

You can check the recent received numbers. You can call by this number, save it or view date and time in this menu.

### Dialled calls [Menu 2-3]

You can check the recent dialled numbers. You can call by this number, save it or view date and time in this menu.

### Clear recent calls [Menu 2-4]

You can delete all call records.





1. Press [Menu] in standby mode.
2. Press for direct access or use and to enter **Call register**.
3. Scroll to highlight **Clear recent calls** and press [Select] to enter.
4. The following four submenus : Missed calls, Received calls, Dialled calls, All calls.
5. **Delete all** message will be displayed and then press [Select]. Then, press on more time [Yes] to confirm.

## Call charge [Menu 2-5]

Within these submenus, you can view the duration and the call cost.

### Call duration [Menu 2-5-1]





This function allows you to view the duration of your Last Call, All Calls, Incoming Calls and Outgoing Calls in hours, minutes and seconds. You can also reset the call timers.

1. Press  [Menu] in standby mode.
2. Press  for direct access or use  and  to enter **Call register**.
3. Scroll to highlight **Call duration** and press  [Select].

The following 5 submenus: **Last call, All calls, Received calls, Dialed calls** and **Reset all**.

### Show call costs [Menu 2-5-2]

This function allows you to check the cost of your last call, all calls, remaining and reset the costs. To reset the cost, you need the PIN2 code.

1. Press  [Menu] in standby mode.
2. Press  for direct access or use  and  to enter **Call register**.
3. Scroll to highlight **Show call costs** and Press  [Select] to enter.  
The following 4 submenus: **Last call, All calls, Remaining** and **Reset all**.





#### Note

- The actual call cost may be different depending on network features, billing, and tax.





### Cost settings [Menu 2-5-3] [SIM Dependent]

#### • Set tariff [Menu 2-5-3-1]

You can set the currency type and the unit price. Contact your services providers to obtain charging unit prices. To select the currency or unit in this menu, you need the PIN2 code.

1. Press  [Menu] in standby mode.
  2. Press  for direct access or Use  and  to enter **Call register**.
  3. Scroll to highlight **Cost settings** and Press  [Select] to enter.
  4. Select **Set tariff**.
- **Set credit [Menu 2-5-3-2]**

This network service allows you to limit the costs of your calls by selected charging units. If you select **Read**, the number of remaining unit is shown. If you select **Change**, you can change your charge limit.





1. Press  [Menu] in a standby mode.
2. Press  for direct access or use  and  to enter **Call register**.
3. Scroll to highlight **Cost settings** and press  [Select] to enter.
4. Select **Set credit**.

### Note

- When all units have been used, no calls can be made except emergency calls. Depending on SIM card, you need the PIN2 code to set a call cost limit.



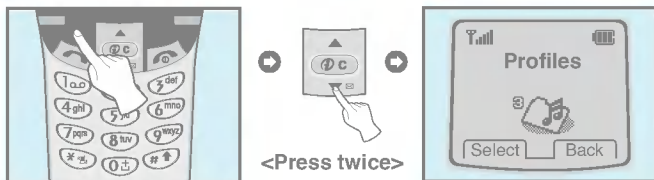

- **Auto display [Menu 2-5-3-3]**

This network service allows you to see automatically cost of your last call. If you select **Yes** in **Auto display** menu, you can see the last cost when the call is released.

1. Press  [Menu] in standby mode.
2. Press  for direct access or use  and  to enter **Call register**.
3. Scroll to highlight **Cost settings** and press  [Select] to enter.
4. Select **Auto display**.



In this menu, you can adjust and customize the phone tones for different events, environments and caller's group. (e.g. When your phone is connected to the Handsfree kit, it'll be automatically set to the Car profiles menu and when your phone is connected to the Earmic, it'll be automatically set to Headset profiles menu.)

1. Press  [Menu] in standby mode.
2. Press  for direct access or use  and  to enter **Profiles**.

### Note

- In case that your phone is connected to Accessories such as Earmic and Handsfree, you cannot enable Profiles menu manually.
- Profiles menu has "Enable" submenu except Headset and Car so that you can set Profiles menu at any time except above case.

### Vibrate only [Menu 3-1]

- **Enable** : You can adjust the Profiles as Vibration if you need vibration mode.

### Quiet [Menu 3-2]

- **Enable** : You can adjust the Profiles as Quiet if you are in Silent place.
- **Change** : You can change the values of Profiles submenus.

### General [Menu 3-3]

- **Enable** : You can adjust the Profiles as General
- **Change** : You can change the values of Profiles submenus.

### Loud [Menu 3-4]

- **Enable** : You can adjust the Profiles as Loud if you are in a noisy environment.
- **Change** : You can change the values of Profiles submenus.

### Headset [Menu 3-5]

- **Enable** : You can adjust the Profiles as Headset when you put on a headset.
- **Change** : You can change the values of Profiles submenus.

### Car [Menu 3-6]

- **Enable** : You can adjust the Profiles as Car when you activate Handsfree Kit.
- **Change** : You can change the values of Profiles submenus.

### A Group of Profiles submenus [Menu 3-x-x]

**Profiles** menu have the submenus as shown below.

#### **Incoming alert type [Menu 3-x-1]**

Allows to set alert type for the incoming call for adjusting environment.

#### **Ring tone [Menu 3-x-2]**

Allows to set the ringing tone for adjusting environment.

#### **Ring volume [Menu 3-x-3]**

Allows to set the ringing volume for adjusting environment.

#### **Message alert [Menu 3-x-4]**

Allows to alert when receiving a message for adjusting environment.:  
**Beep, Vibrator, and No alert.**

#### **Key volume [Menu 3-x-5]**

Allows to set the keypad volume for adjusting environment.

## Automatic answer [Menu 3-x-6]

Allows to set to answer automatically for adjusting environment.

Please note that only Car and Headset has this sub menu so that you can activate this function.

- **Disable**

Even though your phone is ringing, your phone will not answer automatically.

- **After 5 sec**

After 5 seconds your phone will answer automatically.

- **After 10 sec**

After 10 seconds your phone will answer automatically.

### ● Note

- If you set the Handsfree kit to the phone, you can't activate the vibration related with Incoming alert type or Message alert menu. Therefore, in Car menu, you can view the following submenus;
  - **Incoming alert** : Ring, Silent
  - **Message alert** : Beep, No alert

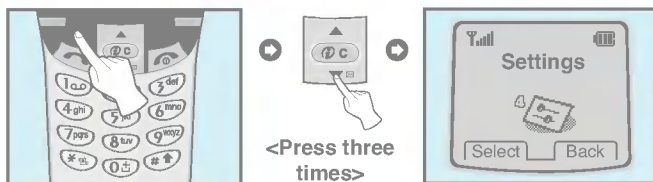

You can set the following menus for your convenience and preferences.

1. Press [Menu] in standby mode.
2. Press for direct access to enter Setting.

### Alarm clock [Menu 4-1]

You can set the phone to alarm at a specified within this menu.

#### **Enable [Menu 4-1-1]**

You can set the time (Hour and Minute) for raising the alarm.

1. Enter the menu.
2. Select Enable by pressing [Select], and then enter the alarm time you want.
3. Press [OK].
4. Select the repeat period: **Once, Daily, Weekly, and Monthly.**
5. If you set in Power off alarm, the alarm signal sounds at the time you set even if the phone is turned off.

#### **Disable [Menu 4-1-2]**

You can cancel setting the alarm time.



1. Enter the menu.
2. Select **Disable** by pressing [Select].
3. **Clear alarm** message will be displayed when the phone is set to alarm before.
4. If you want to cancel, press [Yes]. If not, press [No].

## Date & Time [Menu 4-2]

### Date [Menu 4-2-1]

- **Set date**

In this menu, you can set the date of your phone.

1. Enter the menu.
2. Select Set date by pressing  [Select].
3. Enter the number you want to set the date.
4. Press  [OK].

- **Date format**

You can set the Date format in this menu.





### Time [Menu 4-2-2]

The phone has its own clock. In this menu you can set the time and select between the 12-hour or 24-hour time formats.

1. Enter the menu.
2. Scroll to highlight Time by pressing  [Select].



- **Set time:**

You can set time of your phone in this menu.

1. Select Set time by pressing  [Select].
2. Enter the number you want to set the time.
3. Select the **am/pm** you want to set the time format by long pressing ,  key.
4. Press  [OK].

- **Time format:**

Your can select time format between 12-hour or 24-hour.

1. Scroll to highlight Time format by pressing  [Select].
2. Select 12 hour or 24 hour you want by pressing  [Select].

### Phone settings [Menu 4-3]

You can set the phone setting you want. Scroll to highlight **Phone settings** menu, and then press  [Select].

#### Display [Menu 4-3-1]

- **Screen saver [Menu 4-3-1-1]**

If you don't activate any function for 20 seconds, the picture will be displayed in a standby mode.

- **Welcome note [Menu 4-3-1-2]**

This menu allows you to set the message, which is shown briefly when the phone is switched on.

1. Select **Settings - Phone settings - Display - Welcome note**.
2. Your own text can be displayed. If you select this item, your phone asks you to edit the message.

- **Backlight [Menu 4-3-1-3]**

You can set the light-up duration you want whenever you press a key.

- **LCD contrast [Menu 4-3-1-4]**

You can set the brightness of LCD you want by pressing  , .

#### Language [Menu 4-3-2]

You can select the language that will be displayed on the phone.

## Call settings [Menu 4-4]

You can set the menu relevant to a call by pressing  [Select] in Setting menu.

### Minute minder [Menu 4-4-1]

If you select Yes, you can check the call duration by beep sound every minute during a call.

### Any key answer [Menu 4-4-2]

- **Yes [Menu 4-4-2-1]**

If you select this menu, you can receive an incoming call by pressing any key except  key and  key

- **No [Menu 4-4-2-2]**

If you select this menu, you can receive an incoming call by  [Answer] or .

#### ● Note

- **How to use Handsfree portable:**

If you want to use the handsfree portable (earphone), Please press the button for a long time after inserting it to the connector when incoming a call.

## Send number [Menu 4-4-3]

(network and subscription dependent)

- **Yes [Menu 4-4-3-1]**

If you select this, you can send your phone number to the other party. That is, your phone number will be displayed on receiver's phone.

- **No [Menu 4-4-3-2]**

If you select this, you can't send your phone number.

- **Default [Menu 4-4-3-3]**

If you select this menu, this phone will be set to the default value.

### Call waiting [Menu 4-4-4]

#### (network dependent)

If this service is available, you can accept a waiting (incoming) call.

- **Enable [Menu 4-4-4-1]**  
Activating the corresponding service.
- **Disable [Menu 4-4-4-2]**  
Deactivating the corresponding service.
- **Check status [Menu 4-4-4-3]**  
Checking the Status of the service.

### Auto redial [Menu 4-4-5]

- **Yes [Menu 4-4-5-1]**  
When this function is set on, your phone will make up to 10 attempts for a call after not connecting.
- **No [Menu 4-4-5-2]**  
Your phone will not make any attempts to connect the call after not connecting.

### Select line [Menu 4-4-6]

#### (network dependent)

This function is only used if **Alternate line service** supported by the Service Provider. Two independent phone numbers are registered for the phone. This function provides you with the selection the currently used phone number. If this function is supported by your service provider, the following menu will be displayed.

1. **Line 1** : Select Line 1 as the current phone number.
2. **Line 2** : Select Line 2 as the current phone number.

## Next incoming [Memu 4-4-7]

### (network dependent)

In case of Single Numbering Service, you can use the phone and a connected PC to send and receive fax, data, and voice. If you select the mode, you can receive data, fax, or voice each mode. Once you enter this menu, you following options are displayed.

- **Voice**

You can receive the voice call.

- **Data**

You can receive the data call.

- **Fax**

You can receive the fax call.





#### ● Note

- Single numbering service means that the number of fax or data service is identical with the number of voice service. And, these modes depend on network feature.

## Security settings [Menu 4-5]

### PIN code [Menu 4-5-1]

In this menu, you can set the phone to ask for the PIN code of your SIM card when the phone is switched on. If this function is activated, you'll be requested to enter the PIN code.

1. Press  [Menu] in standby mode.
2. Press  key for direct access or use  and  to enter **Settings**.
3. Scroll to highlight **Security settings** menu.
4. Select PIN code by pressing  [Select].
5. You can view the following submenus.
  - **Enable** : Enable PIN code request.
  - **Disable** : Disable PIN code request.

### Phone lock [Menu 4-5-2]

You can use security code to avoid unauthorized use of your phone. When you switch on your phone, Your phone will request security code always if you set phone lock to "Enable". if you set phone lock to "Automatic". Your phone will request security code only when you change your SIM card.



- **Enable**
- **Disable**
- **Automatic**

### Automatic key lock [Menu 4-5-3]

When you enable Automatic key lock, keypad will be lock automatically on a idle screen after 25 seconds without any key requesting.

- **Enable**
- **Disable**

#### Note

- If you want to lock your phone keypad manually, enter Top menu and press  key.
- If you want to unlock your phone keypad, press [unlock] key and then press  key. But if you enabled Automatic key lock before, your phone keypad will be unlock and then after 25 seconds the keypad will be lock up again automatically.

### Call barring [Menu 4-5-4]

The Call barring service prevents your phone from making or receiving certain category of calls. This function requires the call barring password. You can view the following submenus.

- **All outgoing:**  
The barring service of all outgoing calls.
- **Outgoing Intl:**  
The barring service of all outgoing international calls.

- **Outg. intl roam:**

The barring service of all international outgoing calls except home network.

- **All incoming:**

The barring service of all incoming calls

- **Inc when roam:**

The barring service of all incoming calls when roaming

- **Cancel all:**





You can cancel all barring service.

- **Change passwd:**

You can change the password for Call Barring Service.





### Fixed dial num. [Menu 4-5-5] (SIM dependent)



You can restrict your outgoing calls to selected phone number. The numbers are protected by your PIN2 code.

1. Press  [Menu] in standby mode.
2. Press  key for direct access or use  and  to enter **Settings**.
3. Scroll to highlight **Security settings** menu.
4. Select PIN code by pressing  [Select].
5. If the PIN 2 code is correct, you can view the following submenus.
  - **On** : You can restrict your outgoing calls to selected phone number.
  - **Off** : you can call without restricting phone number.
  - **Number list**: You can view the number list saved as Fixed dial number.

### Change code [Menu 4-5-6]

You can change the access codes: **PIN**, **PIN2**, and **Security code**.

1. Press  [Menu] in standby mode.
2. Press  key for direct access or use  and  to enter **Settings**.

3. Scroll to highlight **Security settings** menu.
4. Select **Change code** by pressing  [Select].
5. If you want to change the PIN/PIN2/Security code, input your original code, and then press  [OK].
6. Input new PIN/PIN2/Security code, and verify the them.

### **Network settings [Menu 4-6]**

You can select the network which you will be registered either automatically or manually. Usually, the selection of the network used by the handset is automatic.

#### **Automatic [Menu 4-6-1]**

The phone automatically selects network which is available in the your area.

#### **Manual [Menu 4-6-2]**

The phone will find the list of available networks and show you them. Then you can select the network which you want to use if this network has a roaming agreement with your home network operator.

#### **Preferred [Menu 4-6-3]**

You can set a list of preferred networks the handset should attempt to register with first, before attempting to register to any other networks. This list is created from the handset's predefined list of known networks.

#### **User define [Menu 4-6-4]**

You can add entries or delete new ones from the network list. This can even include new networks whose network codes are not known to the handset. To do this, select and then enter the network code, country code and network name.

### **Restore factory settings [Menu 4-7]**

You can set the handset to the default configuration by selecting the Settings/Restore factory settings option, and then confirming this selection.

## Call Divert [Menu 5]

(network and subscription dependent)

Accessing the Menu

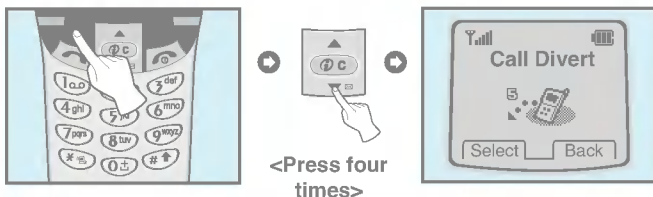

<Press four times>

The Call divert service allows to divert incoming voice calls, fax calls, and data calls to another number. For details, contact your service provider.

1. Press [Menu] in standby mode.
2. Press for direct access or use and to enter Call Divert.

### **All voice calls [Menu 5-1]**

Diverts voice calls unconditionally.

### **If busy [Menu 5-2]**

Diverts voice calls when the phone is in progress.

### **If no reply [Menu 5-3]**

Diverts voice calls which you do not answer.

### **If unreachable [Menu 5-4]**

Diverts voice calls when the phone is switched off or out of range.

### **All data calls [Menu 5-5]**

Diverts to a number with a PC connection unconditionally.

## Call Divert [Menu 5]

Accessing the Menu

(network and subscription dependent)

### All fax calls [Menu 5-6]

Diverts to a number with a fax connection unconditionally.

### The submenus [Menu 5-x-x]

**Call Divert** menus have the submenus as shown below.

#### **Enable [Menu 5-x-1]**

Activating the corresponding service.

- **Voicemail box [Menu 5-x-x-1]**

Forwards to message center. This function is not included in **All data calls** and **All fax calls** menus.

- **Other number [Menu 5-x-x-2]**

Inputs the number for diverting.

- **Favorite [Menu 5-x-x-3]**

Shows the list of 5 diverting numbers.

#### ● **Note**

- You can select the number you want in **Favorite** menu.

#### **Disable [Menu 5-x-2]**

Deactivating the corresponding service.

#### **Check status [Menu 5-x-3]**

Checking the Status of the corresponding service.

### Cancel all [Menu 5-7]

Cancels all call divert service.







## Scheduler [Menu 6]

Accessing the Menu



When you enter this menu a Calendar will show up. On top of the screen there are sections for date and icons. Whenever you change the date, the calendar will be updated according to the date. And square cursor will be used to locate the certain day. If you see under bar on the calendar, it means that there is a schedule that day. This function helps to remind you of your schedule and memo. The phone will sound an alarm tone if you set alarm for the note.

For changing the day, month, and year.

 	Yearly	 	If you press these keys shortly, you can set the alarm daily. In case of pressing for a long time, you can set it weekly.
 	Monthly		

### Add new [Menu 6-1]

You can edit maximum 30 characters. You can take a note. You can choose the following types of note. You can make up to maximum 20 notes.

#### Schedule [Menu 6-1-1]

Input the subject, the schedule time, the repeat time, alarm time by pressing  [Select].

##### • Repeat [Menu 6-1-1-1]

- **Once** : no repeat.
- **Daily** : repeat schedule daily for 5 days.
- **Weekly** : repeat schedule weekly for 5 weeks.
- **Monthly** : repeat schedule monthly for 5 months.
- **Yearly** : repeat schedule yearly for 5 years.



### • Alarm time [Menu 6-1-1-1-1]

- **On time** : alarm on time you set already.
- **10 min before** : alarm before 10 minutes from the schedule you set already.
- **30 min before** : alarm before 30 minutes from the schedule you set already.
- **1 hour before** : alarm before 1 hour from the schedule you set already.
- **1 day before** : alarm before 1 day from the schedule you set already.



### Memo [Menu 6-1-2]

1. Select **Add new** by pressing  [Select].
2. Scroll to highlight **Memo**.
3. Press  [Select].
4. Input the memo and then press  [Select].

### View day [Menu 6-2]

Shows the note for the chosen day. Use  ,  to browse through the note lists. If you set alarm for the note, Alarm watch is displayed. Press  [Options] to delete, edit the note you selected.

### View all [Menu 6-3]

Shows the notes that are set for all days. Use  ,  to browse through the note lists. Pressing  [Options] allows access to the same menu as in 'View day'.

### Delete passed [Menu 6-4]

You can delete for the last schedule already is notified you.

### Delete all [Menu 6-5]

You can delete for the all note(s).

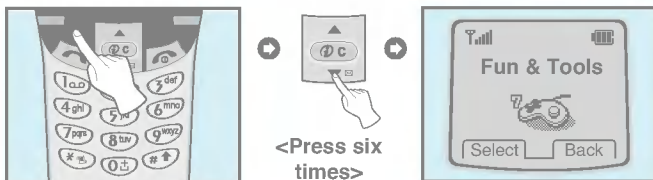

### Game [Menu 7-1]

Your phone offers you enjoyable games to play with.

#### Note

The Control keys are different for each game. But each game has screens to explain the main control key. Other common control keys are below.

#### [Common Key Function]

- [Soft 1 Key] : Start Game
- [CLR] : Pause
- [Soft 2 Key] : Back
- [END] : Exit
- [Star Key] : Backlight
- [Soft 1 Key] : Save score
- [Up/Down, numeric key]

### Unit convert [Menu 7-2]



This converts any measurement into a unit you want. There are 4 types that can be converted into units: **Length, Area, Weight, and Volume.**

1. You can select one of four unit types by pressing [Select] key.
2. Select the unit you want to convert by pressing and .
3. You can change unit by pressing [Change] key.
4. You can input the prime number after the decimal place by pressing key.
5. You can delete the number you want by pressing .
6. Press key or [Back] key if you want to end the process for converting the value.





### Calculator [Menu 7-3]

This contains the standard functions such as +, -, \*, ÷ : **Add, Subtract, Multiply, Divide**

1. Input the numbers by pressing numeric keys.
2. Press [Options] to select menu you want such as Add, Subtract, Multiply, Divide, Negative, Decimal point, Equals.
3. You can view the result by pressing [Options] key and select **equals.**
4. If you want to continue the calculation, repeat the process.
5. You can delete the number or sign you want by pressing .
6. Press key if you want to end the calculation process.

## **World time [Menu 7-4]**

You can view the time for each city around the world.

when you press  ,  shortly, you can view the city belonged to the different time zone and when you press  ,  long, you can view the all of city on the same time zone.

If you want to select the country you want, press  [set] key.

### **● PC Sync**

PC Sync is a program for data exchange PC & Phone by data cable. Therefore, if you want to use this function, you have to buy accessory kit. About more detail for using guide refers to PC Sync Help file on the PC Sync CD.





Your phone supports services based on Wireless Application Protocol(WAP). You can access services supported by your network. The services menu allows you to get the information such as news, weather reports, and flight times.

### Home [Menu 8-1]

You can connect to the configured homepage of the activated profile.

### Bookmarks [Menu 8-2]

When you enter this menu, you can see the bookmarks. Then press  button to access available option, or press  to exit it.

- **Connect** : Connect to selected bookmark.
- **Add new** : Add a new bookmark manually.
- **Edit** : Edit the title and the address of the selected bookmark.
- **Delete** : Delete the selected bookmark from the bookmark list.

### Profiles [Menu 8-3]

You can make up to 5 profiles and activate only one of them. Scroll to the desired profile and press  to access available options.

#### • **Activate [Menu 8-3-1-1]**

You can activate the selected profile.

#### • **Settings [Menu 8-3-1-2]**

You can edit and change WAP settings of the selected profile.

#### - **Homepage [Menu 8-3-1-2-1]**

This setting allows you to enter the address (URL) of the site you want to use as homepage. You do not need to type "http://" in front of each URL as the WAP Browser will automatically add it.

**- Display image [Menu 8-3-1-2-2]**

You can select whether images on WAP cards are displayed or not.

**- Conn. type [Menu 8-3-1-2-3]**

The options for connection type are Continuous or Temporary and depend on the gateway.

**Continuous [Menu 8-3-1-2-3-1]**

A confirmed delivery mechanism but generates more network traffic.

**Temporary [Menu 8-3-1-2-3-2]**

A non-confirmed (connectionless) service.

**- Secure setting [Menu 8-3-1-2-4]**

The options are **On** and **Off** depend on the gateway you are using.

**- Gateway info. [Menu 8-3-1-2-5]**

Most of WAP gateways do not require a User ID and Password. If your gateway need them to connect to it, then your network should provide them, and you must set them up correctly before trying to browse a WAP site.

**- Data setting [Menu 8-3-1-2-6]**

These values of setting are provided by your network.

**IP address** : Enter the IP address of the WAP gateway you are using to access.

**Dial number** : Enter the telephone number to dial to access your WAP gateway.

**Call type** : Select the type of data call.: Analogue or ISDN (Digital).

**Call speed** : The speed of your data connection.

**User ID** : The user identity for your dial-up server (and NOT the WAP gateway).

**Password** : The password required by your dial-up server (and NOT the WAP gateway) to identify you.

**- Linger time [Menu 8-3-1-2-7]**

You need to select one of 5 timeout periods. After selecting one of them, the service will be unavailable if any data wasn't input or transferred.

**• Rename [Menu 8-3-1-3]**

Edit the Profile Name.

**• E-mail server [Menu 8-3-1-4]**

Save the URL of the E-mail server that you frequently use.

**- Connect [Menu 8-3-1-4-1]**

Connect to the E-mail server that you configured.

**- Edit address [Menu 8-3-1-4-2]**

Edit the URL of the E-mail server.

### **Go to URL [Menu 8-4]**

You can directly connect to the site that you want. You need to enter the specific URL that you want to directly connect.

## **Cache settings [Menu 8-5]**

You can remove the contents of Cache memory and change the Cache check mode.

### **Clear cache [Menu 8-5-1]**

The contents of Cache memory will be removed.

### **Cache check [Menu 8-5-2]**

You can change the time for checking the Cache memory.

- **Always [Menu 8-5-2-1]**

The cache is always checked whenever URL is loaded or navigated.

- **Start only [Menu 8-5-2-2]**

The cache is only checked when the WAP is started.

- **Off [Menu 8-5-2-3]**

The cache is never checked.

## **Security certifications [Menu 8-6]**

A list of the available certificates is shown.

## **Reset profiles [Menu 8-7]**

You can reset all the current settings of profiles to the factory default.

If you are on line, you can see the following menus.

**Home**

This is the same as [Menu 8-1].

**Reload**

This reloads the current page.

**Bookmarks**

This is the same as [Menu 8-2].

**Save as bookmarks**

Save the current URL as a bookmark. You can also edit the bookmark title.

**Go to URL**

Same as [Menu 8-4]

**Go to e-mail server**

Connect to the E-mail server that you configured.

**Set as e-mail server**

Save the current URL as an E-mail server.

To be able to data or fax service, you need the communicate software such as a data or a fax program. Before using these functions, you need to connect your phone to a computer or make sure that your phone is in connection with a compatible device.

### **Sending Data or Fax Calls**

1. Connect your computer to the phone.
2. After starting the communicate software, make a call and transmit a data or fax.
3. After the data or fax transmission, you can end the call by just ending of the communicate software, pressing  [End] or by closing the folder.

### **Receiving Data or Fax Calls**

If you have separate numbers for voice, data and fax calls, your phone recognizes the type of call.

#### **Receiving Data or Fax Calls - Separate numbers (Multi-numbers)**

To use a data or a fax service, the display shows which type of call you are receiving.

To receive a data or fax call



1. Connect your computer to the phone.
2. After starting the communicate software, accept a call and receive a data or fax (if it is not answered automatically).
3. After the data or fax reception, you can end the call by just ending of the communicate software, pressing  [End] or by closing the folder.

### Receiving Data or Fax Calls - Single number

If you have a SIM card that does not support separate voice, data and fax numbers, the phone does not recognize the type of incoming call.

To use a data or a fax service, make sure that you want to receive a data or fax call mode. You first have to set the phone to one of these options in the call mode (Settings → Call Setting → Next Incoming) sub menu.

To receive a data or fax call



1. Press  [Menu] in standby mode.
2. Select the Settings → Call setting → Next Incoming.
3. Select the call type you want (Voice, Data or Fax) and press  [Select].
4. Connect your computer to the phone.
5. After starting the communicate software, accept a call and receive a data or fax (if it is not answered automatically).
6. After the data or fax reception, you can end the call by just ending of the communicate software, pressing  [End] or by closing the folder.

Once you have set your phone for a specific incoming call, it remains set until you change it.

During a call, the following menus will be displayed, not in a standby mode.

## 1 During a call



### 1-1 Putting a Call on Hold

You can place a call on hold or retrieve by just pressing the  [Send] key. When a call is made or answered, press the  [Send] key to place it on hold. When a call is held, press the  [Send] key to make it active.

### 1-2 Making a Second Call

You can get a dial number from phonebook to make a second call. Press  [Names] key then select **Search**. To save the dial number into phonebook during call, press  [Names] key then select **Add Entry**.

### 1-3 Swapping Between Two Calls



To switch between two calls, select the  [Menu] key, then select Swap or just press  [Send] key.

You can make one of two calls focused by pressing up/down arrow key. If you want to end one of two calls, make the call you want to end focused, then press  [End] key when the call you want to end is focused.

### 1-4 Answering an Incoming Call

To answer an incoming call, simply press the  [Send] key.

The handset is also able to warn you of an incoming call while you are already in a call. A tone sounds in the earpiece, and the display will show that a second call is waiting.

If Call Waiting is on, you can put the first call on hold and answer the second, by pressing  [Send] or by selecting the  [Menu] key, then **Hold & Answer**.

You can end the current call and answer the waiting call by selecting the  [Menu] key, then **End & Answer**.

### 1-5 Rejecting an Incoming Call



You can reject an incoming call without answering by simply pressing the  [End] key.

When in a call you can reject an incoming call by pressing the  [Menu] key and selecting **Multiparty/Reject** or by pressing  [End] key.

### 1-6 Controlling the volume during a call

You can control the volume during a call by pressing  [Menu] key and selecting **Volume**.

### 1-7 Muting the Microphone

You can mute the microphone during a call by pressing the  [Menu] key then selecting **Mute**. The handset can be unmuted by pressing the  [Unmute] .

When the handset is muted, the caller cannot hear you, but you can still hear them.

### 1-8 Switching DTMF Tones on During a Call

To turn DTMF tones on during a call, for example, to allow your handset to make use of an automated switchboard, select the  [Menu] key, then **DTMF On**. DTMF tones can be turned off the same way.

### 1-9 Calling up the Main Menu

The Messages and SIM Tool kit main menu options can be reached from the in-call menu by selecting the  [Menu] key, then **Main Menu**. SIM Tool kit menu is shown only when SIM in the handset supports SIM Tool kit service.



## 2 Multiparty or Conference Calls

The multiparty or conference service provides you with the ability to have a simultaneous conversation with more than one caller, if your network service provider supports this feature.

A multiparty call can only be set up when you have one active call and one call on hold, both calls having been answered. Once a multiparty call is set up, calls may be added, disconnected or separated (that is, removed from the multiparty call but still connected to you) by the person who set up the multiparty call. These options are all available from the in-call menu and are listed in Section.

The maximum callers in a multiparty call is five. Once started, you are in control of the multiparty call, and only you can add calls to the multiparty call.

### 2-1 Making a Second Call

You can make a second call while you are already in a call. To do this, enter the second number and press  [Send]. When you get second call the first call is automatically put on hold. You can swap between calls by selecting the  [Menu] key then **Swap**.

### 2-2 Setting up a Multiparty Call

You can connect a call on hold to the currently active call to form a multiparty call by selecting the  [Menu] key then **Multiparty/Join all**.

### 2-3 Putting the Multiparty Call on Hold

To put a multiparty call on hold, select the  [Menu] key then **Multiparty/Hold all**.



### 2-4 Activate the Multiparty Call on Hold

To make a multiparty call on hold active, select the  [Menu] key then **Multiparty/Join all**.

### 2-5 Adding Calls to the Multiparty Call

To join an active call to the held multiparty call, select the  [Menu] key then **Multiparty/Join all**.

### 2-6 Displaying Callers in a Multiparty Call

To scroll through the numbers of the callers who make up a multiparty call on the handset screen, press  and  keys.



### 2-7 Putting a Member of a Multiparty Call on Hold

To place one selected caller (whose number is currently displayed on-screen) of a multiparty call on hold, select the  [Menu] key then **Multiparty/Exclude**.

### 2-8 A Private Call in a Multiparty Call

To have a private call with one caller of a multiparty call, display the number of the caller you wish to talk to on the screen, then select the  [Menu] key and **Multiparty/Private** to put all the other callers on hold.

### 2-9 Ending a Multiparty Call

The currently displayed caller of a multiparty call can be disconnected by pressing the  [End] key. To end a multiparty call, press the  [Menu] key then select **Multiparty/End** multiparty.

Selecting the  [Menu] key then **Multiparty/End all**, will end all the active and held calls.

### 2-10 Explicit Call Transfer (ECT)

If you have one caller on hold and another active call, you may connect one call party to another call party and then leave the call. This is done by selecting the **Multiparty/Transfer** option from the in-call menu.

**When using this unit, basic safety precautions as below should be always followed.**

- Do not touch the adapter with wet hands.
- Do not disassemble this unit. (Take it to a qualified service technician when repair work is required.)
- Away from electrical appliance such as a TV, radio or personal computer.
- The unit should be situated from heat sources such as radiators or cookers.
- Do not drop.
- Do not subject this unit to mechanical vibration or shock.
- The coating of the phone may be damaged if covered with wrap or vinyl wrapper.
- Use dry cloth to clean the exterior of the unit. (Do not use solvent such as benzene, thinner or alcohol.)
- Do not subject this unit to excessive smoke or dust.
- Do not keep the phone next to credit cards or transport tickets; it can be affect the information on the magnetic strips.
- Do not tap the screen with a sharp object; otherwise, it may damage the phone.
- Do not expose the phone to liquid or moisture.
- Use the accessories like an earphone cautiously. Do not touch the antenna unnecessarily.

### ■ Caring for the Battery

- You do not need to completely discharge the battery before recharging. Unlike other battery systems, there is no memory effect that could compromise the battery's performance.
- Use only LG batteries and chargers. LG chargers are designed to maximize the battery life.
- Do not disassemble or short-circuit the battery pack.
- Keep the metal contacts of the battery pack clean.
- Replace the battery when it no longer provides acceptable performance. The battery pack may be recharged hundreds of times until it needs replacing.
- Recharge the battery if it has not been used for a long time to maximize usability.
- Do not expose the battery charger to direct sunlight or use it in high humidity, such as the bathroom.
- Do not leave the battery in hot or cold places, this may deteriorate the battery performance.

### General

---

Product Name : W3000

System : GSM 900/DCS 1800

### Ambient Temperatures

---

Max : +55°C

Min : -10°C







