





ENGLISH  
MALAY

# GSM Phone

USER'S MANUAL

MODEL : LG - 600

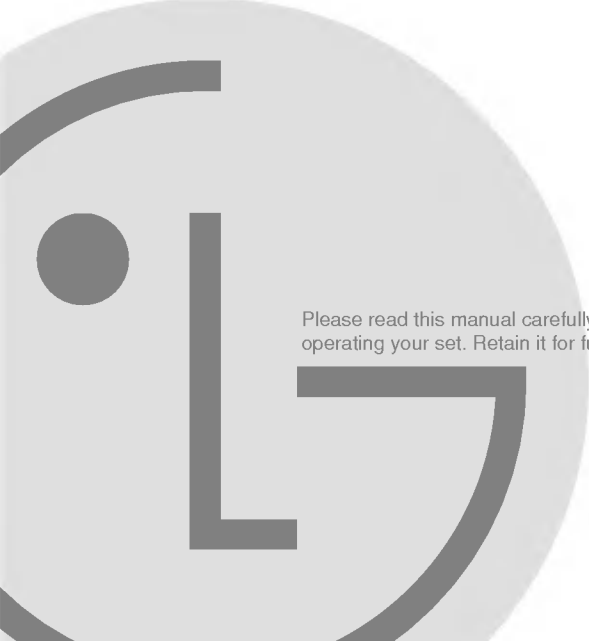
A large, light gray watermark of the LG logo is positioned in the lower-left quadrant of the page, partially overlapping the text.

Please read this manual carefully before operating your set. Retain it for future reference.



# GSM Phone

USER'S MANUAL

MODEL : LG - 600

Please read this manual carefully before operating your set. Retain it for future reference.



**LG-600 has a polished style which provides users' a better feel and convenience.**

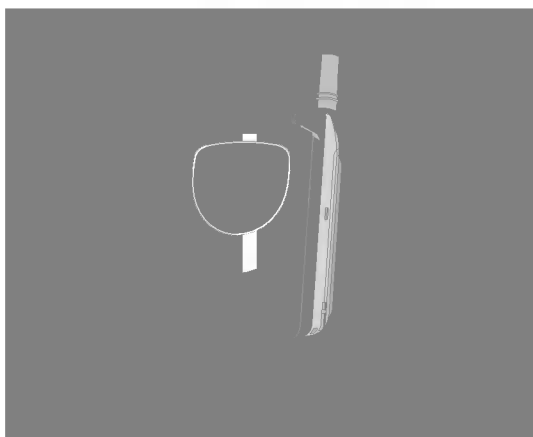

All radio transmitters carry risks of interference with electronics in close proximity.



GSM Phones must be switched off at all times in an aircraft.



Do not activate near petrol stations, fuel depots, chemical plants or blasting operations.



Avoid use in hospitals : medical electronics, e.g. pacemakers and hearing aids can be affected.



Minor interference may affect TVs, radios, PCs, etc.



Do not hold the phone in your hand while driving.



Do not dismantle phone or battery.

## Please note:



Use only specified batteries and chargers as others can damage the phone.



Unusable batteries should be disposed of in accordance with relevant legislation.



Only use ORIGINAL accessories to avoid damage to your phone.

## Important Information

This user's guide contains important information on the use and operation of this phone. Please read all the information carefully for optimal performance and to prevent any damage to or misuse of the phone. Any changes or modifications not expressly approved in this user's guide could void your warranty for this equipment.

## Overview

<b>Accessories</b> .....	<b>10</b>
<b>Part of the Phone</b> .....	<b>11</b>
• Front of the Phone .....	11
• Rear of the Phone .....	12
<b>Key Description</b> .....	<b>13</b>
• Side of the Phone .....	14
• Alphanumeric Keys .....	14

## Display Information

<b>Display Information</b> .....	<b>15</b>
• On-Screen Icons .....	15

## Getting Started

<b>Installation</b> .....	<b>17</b>
• Installing the SIM Card .....	17
• Installing the Battery .....	18
• Charging the Battery .....	18
• Disconnecting the Charger .....	19
<b>Powering On Sequence</b> .....	<b>20</b>
<b>Access Codes</b> .....	<b>21</b>
• PIN1 code (4 to 8 digits) .....	21
• PIN2 code (4 to 8 digits) .....	21
• PUK1 code (4 to 8 digits) .....	21
• PUK2 code (4 to 8 digits) .....	21
• Security code (4 to 8 digits) .....	21
<b>Write and Read Messages</b> .....	<b>22</b>
• Write message .....	22
• Read message .....	22
<b>eZi Text</b> .....	<b>23</b>
• How to Use eZi Text .....	23

## Call Functions

<b>Making and Answering Calls</b> .....	<b>26</b>
• Making Calls .....	26
• Answering Calls .....	27
<b>Recent Numbers</b> .....	<b>28</b>
• Dialed Number .....	28
• Received Number .....	28
• Missed Number .....	28

## Accessing the Menu

<b>Phonebook</b> .....	<b>29</b>
• Search [Names 1] .....	29
• Search E-Mail [Names 2] .....	30
• Add Entry [Names 3] .....	30
• Add E-Mail [Names 4] .....	31
• Groups [Names 5] .....	31
• Speed Dials [Names 6] .....	33
• Delete all [Names 7] .....	33
• Memory [Names 8] .....	33
• Copy [Names 9] .....	33
• Service Dial Number [Names 10] (SIM dependent) .....	34
• Own Number [Names 11] .....	34
<b>MMI Structure</b> .....	<b>35</b>
<b>Using the Menu</b> .....	<b>38</b>
<b>Menu Navigation by scrolling</b> .....	<b>38</b>
<b>Shortcuts into Menus</b> .....	<b>38</b>
<b>Messages [Menu 1]</b> .....	<b>39</b>
• Write Message [Menu 1-1] .....	39
• Outbox [Menu 1-2] .....	40
• Inbox [Menu 1-3] .....	40
• Status Report [Menu 1-4] .....	41

• Call Voicemail [Menu 1-5] .....	42
• Cell Broadcast [Menu 1-6] .....	42
• Memory Status [Menu 1-7] .....	43
• Setting [Menu 1-8] .....	43
<b>Call Option [Menu 2] .....</b>	<b>45</b>
• Call Divert [Menu 2-1] .....	45
• Call Barring [Menu 2-2] .....	46
• Call Waiting [Menu 2-3] .....	47
• Sending Number [Menu 2-4] .....	47
• Closed User Group [Menu 2-5] .....	47
<b>Call Charge [Menu 3] - (SIM dependent) .....</b>	<b>48</b>
• Call Duration [Menu 3-1] .....	48
• Call Costs [Menu 3-2] .....	48
• Cost Settings [Menu 3-3] .....	49
<b>Security [Menu 4] .....</b>	<b>50</b>
• PIN Enable [Menu 4-1] .....	50
• Change Codes [Menu 4-2] .....	50
• Fixed Dial Number [Menu 4-3] .....	51
<b>Setting [Menu 5] .....</b>	<b>52</b>
• Network Selection [Menu 5-1] .....	52
• Phone Setting [Menu 5-2] .....	52
• Call Setting [Menu 5-3] .....	53
• Time Setting [Menu 5-4] .....	54
• Profiles [Menu 5-5] .....	55
<b>Accessories [Menu 6] .....</b>	<b>56</b>
• Scheduler [Menu 6-1] .....	56
• World Time [Menu 6-2] .....	57
• Calculator [Menu 6-3] .....	57
• Unit Convert [Menu 6-4] .....	57
• Game [Menu 6-5] .....	58
• PC Sync .....	58

<b>Voice Dial [Menu 7]</b> .....	<b>59</b>
• Training [Menu 7-1] .....	59
• Search [Menu 7-2] .....	59
• Setting [Menu 7-3] .....	60
• Delete all [Menu 7-4] .....	60
<b>Internet [Menu 8]</b> .....	<b>61</b>
• Home [Menu 8-1] .....	61
• Bookmarks [Menu 8-2] .....	61
• Profiles [Menu 8-3] .....	62
• Empty Cache [Menu 8-4] .....	62
<b>In Internet Menu</b> .....	<b>63</b>

### Additional Functions

<b>How to Send DTMF tones</b> .....	<b>64</b>
• Wait Characters .....	64
• Interrogating your Answering Machine(example) .....	64
• During a Call .....	64
<b>In-Call Options</b> .....	<b>65</b>
<b>How to Use Data and Fax Call</b> .....	<b>68</b>
• Making a Data or Fax call .....	68
• Making a Voice & Fax call .....	68
<b>Voice Memo</b> .....	<b>70</b>
• Voice Memo .....	70
• Voice Memo Menu .....	70
<b>Care and Maintenance</b> .....	<b>71</b>
<b>Technical Data</b> .....	<b>72</b>
• General .....	72
• Dimensions .....	72
• Ambient Temperatures .....	72

Check to make sure that you have all the parts shown below.



Handset



Belt Clip



Neckstrap

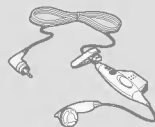

Handsfree Portable



Warranty Card



User's Guide



Travel Adapter



Standard Battery

### <Optional Accessories>

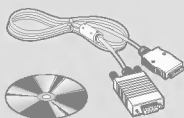

Data Kit/CD  
(DK-10G)

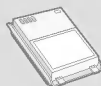

Extended Battery  
(BEL-11G)



Desktop Charger  
(DC-11G)

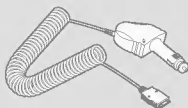

Cigar Lighter Adapter  
(CLA-10G)

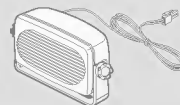

Hands-Free Car Kit  
(IHF-11G)

## Front of the Phone

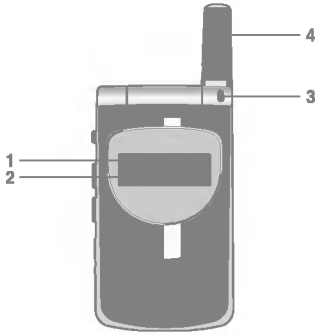

- 1 Front LCD Screen
- 2 Hard Icons
- 3 Call Indicator Light
- 4 Antenna

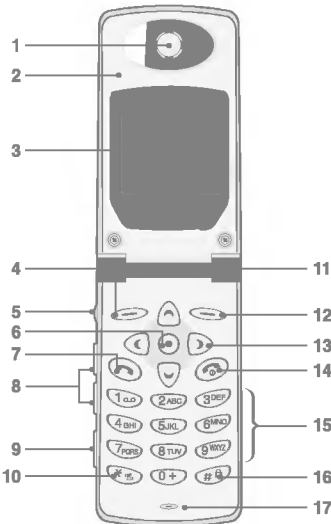

- 1 Earpiece
- 2 Active Folder
- 3 Display Screen
- 4 Soft Left Key
- 5 Record Key
- 6 Confirm Key
- 7 Send Key
- 8 Up/Down Side Key
- 9 Ear Microphone
- 10 Star Key
- 11 Call Indicator Light
- 12 Soft Right Key
- 13 Navigation Keys
- 14 END/PWR Key
- 15 Numeric Keys
- 16 Hash Key
- 17 Microphone

## Rear of the Phone

---

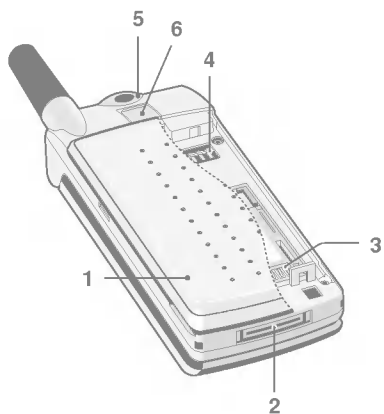













- 1 Battery Cover
- 2 Cable Connector/  
Battery Charging  
Connector/  
Hands-Free Car kit  
Connector

- 3 SIM Card Socket
- 4 Battery Terminals
- 5 Handstrap Hole
- 6 Battery Lock



The following shows key components of the phone.

## Keypad Description

Key	
	<b>Soft Left Key / Soft Right Key</b> Each of these keys performs the function indicated by the text on the display immediately above it.
	<b>WAP Hotkey</b> You can directly connect to WAP by pressing this key.
 <b>Easy Key</b>	<b>Navigation Keys</b> You can use these keys to scroll through names, phone numbers, menus or setting options. In a standby mode, if you press up/down navigation keys, you can see the "Dialed Number" "Received Number" and "Missed Number".
	<b>Send Key</b> You can dial a phone number and answer a call. If you press this key without entering a number, your phone shows the most recently dialed number.
	<b>Numeric Keys</b> These keys are used mainly to dial in standby mode and enter numbers or characters in editing mode. When you press these keys for a long time. <ul style="list-style-type: none"><li>• Used to call your voice mail box by  .</li><li>• Used to call for international call by  .</li><li>• Used to call speed dials by  ~  .</li></ul>
	<b>Star Key</b> Used to enter to vibration mode by pressing this key for a long time.
	<b>Hash Key</b> Used to lock key by pressing this key for a long time.
	<b>END/PWR Key</b> Used to end or reject a call. This key is also used as Power Key. You can power on and off by pressing this key for a long time.







## Side of the Phone

### Keypad Description







Key	
	<p><b>Record Key</b> You can use voice memo by pressing this key for a long time.</p> <p><b>Reject Key</b> You can reject an incoming call by pressing this key for a few seconds without opening the folder.</p>
	<p><b>Up/Down Side Key</b> You can control the volume of key tone in standby mode with opened folder and also the listening volume during a call.</p>

### Alphanumeric Keys

The alphabet and numeric keypad mapping relation are listed as the following table.

Key	
	. ! ' ' , - ? @ 1 _
	A B C 2 Ä À Á Â Ã Ä Æ Ç a b c ä à á â ã ä æ ç
	D E F 3 Ě Ě Ě Ě ě d e f è è é ê
	G H I 4 Ĩ Ĩ Ĩ Ĩ ħ i 4 ĩ ĩ ĩ ĩ ħ i
	J K L 5 j k l
	M N O 6 Ñ Ö Ó Ô Õ Œ m n o ñ ö ó ô õ œ
	P Q R S 7 Þ Š p q r s š
	T U V 8 Ů Ú Ů Ů Ů t u v Ů ú ú ú
	W X Y Z 9 w x y z
	[Space Key] 0 Ø ø

#### ● Notice

- In case of symbol mode, after entering the character, the mode is automatically converted to Capital letter mode. And if you want to enter another symbol character, find it to use the navigation keys,  and  key, press  key or  key to save. Also you can use the next symbol page with , .





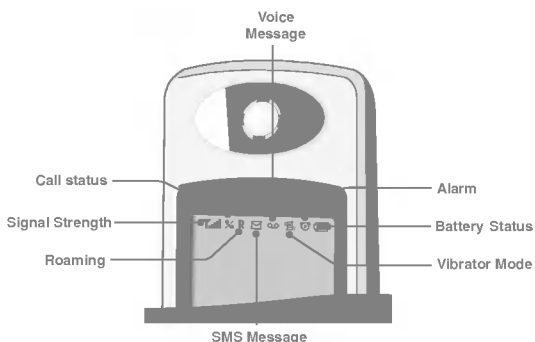



The screen displays several icons the following describe each of them you may see on the phone.

## On-Screen Icons







Icon/Indicator	
	Tells you the strength of the network signal.
	You are in no service area. / Call is connected.
	Shows that you are using a roaming service.
	You have received a new text message.
	You have received a voice message, depending on your subscription.
	All audible signals are turned off.
	All tones are switched off.
	The alarm has been set and is on.
	Tells you the status of the battery.

## Top Menu Icons

Icon	
	Messages
	Call Option
	Call Charge
	Security
	Setting
	Accessories
	Voice Dial
	Internet

## Result Icons

Icon	
	<b>Completed Message</b> Displayed when menu navigation is completed.
	<b>Information Message</b>
	<b>Save Message</b>
	<b>Warning Message</b> Displayed with error or warning message.

## Installing the SIM Card

Locate the SIM card socket in the back of the phone. Follow the steps below to install the SIM card.



1. Unlock the battery cover ❶ and lift it off ❷.



2. Flip the SIM holder ❸.



3. Slide the SIM card into the holder ❹.
  - Ensure the angled corner is positioned correctly and the contact is made.

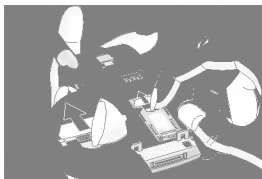

4. Close the SIM card holder, and move the holder lock lever up.

### Notice

- Before installing SIM card, please make sure that the phone is switched off and the battery is removed.
- The metal contact of the SIM card can be easily damaged by scratches. Pay special attention to the SIM card when you handle and install. Follow the instructions supplied with the SIM card.

## Installing the Battery

---

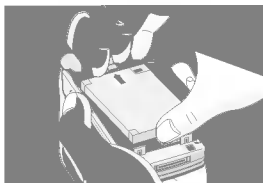

1. Place the top end of the battery on the phone. (See the picture left for purposes of illustration.)

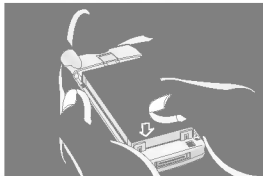

2. Push the battery in until you hear a "CLICK" sound.

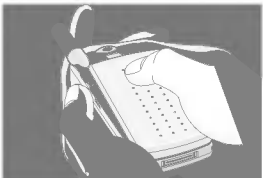

3. Close the battery cover.

## Charging the Battery

---

To connect the travel adapter to the phone you must install the battery.



1. Insert one end of the travel adapter into the bottom of the phone.

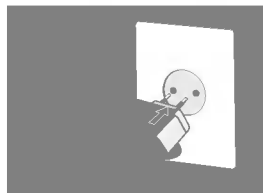

2. Connect the adapter to an AC wall outlet. Use only the included packing charger.



The usage times may be different depending on network service.

Battery Type	Charging Times	Usage Times	
		Standby	Talk
Standard	2.5 hours	100~150 hours	2 hours 30 min
Extended	3 hours	250 hours	4 hours

### Note

- The usage time may be different depending on the network environment and personal usage. For example, it can be affected by setting the light-up duration of backlight.

## Disconnecting the Charger

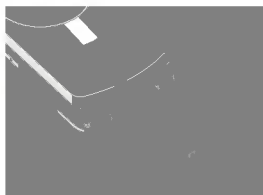

Disconnect the travel adapter from the phone by pressing its side buttons.

### Notice

- The battery delivered with your phone has to be fully charged before using it.
- Do not remove your battery or SIM card while charging.
- “Battery Charging” is displayed on the screen after connecting the travel adapter. Only if the battery is totally empty, Call Indicator Light will be on without displaying “Battery Charging”.
- The moving bars of battery icon will stop after charging completely.

### Note

- In case of the battery is not charged properly...
  1. After switching On/Off Power key, please try to recharge it.
  2. In case the battery is attached, please detach it from the phone. Then place it back to recharge it again.

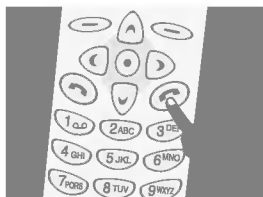

In order to get started with your phone, follow the steps.

1. Press and hold  button until you hear a tone from your phone to switch on.
2. If PIN code request of your SIM card is enabled, your phone asks you to enter PIN code. Enter the PIN code, then your phone connects to a GSM network and the network name appears on the display shortly.
3. And then your phone goes to standby mode. If the PIN code is disabled, your phone connects to the network without the request of entering PIN code.

You can use the access codes described in this section to avoid unauthorised use of your phone. PIN1 / PIN2 codes and Security code can be changed by using [Menu 4-2]. See the following section.

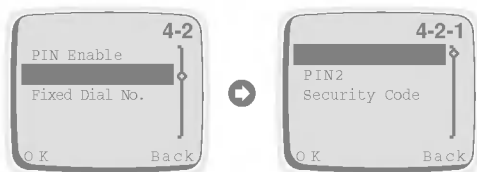

### **PIN1 code (4 to 8 digits)**

---

The PIN (Personal Identification Number) code protects your SIM card against unauthorized use. The PIN code is usually supplied with the SIM card. When the PIN code request is enabled [Menu 4-1-1], the code is asked each time you try to change PIN code or enable/disable PIN code request, or your phone is switched on. If you change the PIN code, mark a note of it but keep separate from the phone.

### **PIN2 code (4 to 8 digits)**

---

The PIN2 code, supplied with some SIM cards, is required to access some functions such as Advice of call charge, Fixed Dial number. These functions are only available if supported by your SIM card.

### **PUK1 code (4 to 8 digits)**

---

The PUK(Personal Unblocking Key) code is required to change a blocked PIN code. The PUK code may be supplied with the SIM card. If not, contact your local service provider for the code. If you lose the code, also contact your service provider.

### **PUK2 code (4 to 8 digits)**

---

The PUK2 code, supplied with some SIM cards, is required to change a blocked PIN2 code. If you lose the code, also contact your service provider.

### **Security code (4 to 8 digits)**

---

The security code protects the unauthorized use of your phone. It is usually supplied with the phone. This code is required to delete all phonebook entries.

## Write Message

---

If you want to write the short message, you will follow the next procedure.

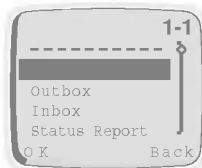

1. Press [Menu].
2. Select **Messages** in main menu by pressing [OK]. And then If you want to write a new message, select **Write Message** in the menu. If you want to modify the previous message, select **Outbox** in the menu, then you can edit the message by using eZi text editor or normal editor. If you want to write a reply message, select **Inbox** in the menu.

## Read Message

---

If you want to read the previous stored short message received before, you will follow the next steps.

1. Press [Menu].
2. Then you can see the top menu. And select **Messages** by pressing [OK].
3. When **Messages** menu is displayed, scroll to **Inbox** by using and and press [OK].
4. Once you enter this menu, you can see the last received messages. Scroll to the desired message by using , . And if you want to exit Inbox menu, press [Back]. While reading message, press [Opt] to access the available options. You can see the explanation of **Option** in [Menu 1-3].

If you want to read the short message just received, you will follow the next steps.

1. When received a short message, will be displayed on the screen.
2. Press [OK], then you can read the just received message.

## How to Use eZi Text

The eZi Text allows the user to type easily and quickly. Simply pressing each key once for each character, you can get the words you want. Furthermore, the candidate is predicted along with other candidates that fit the letters typed thus far. So, you don't need to input entire characters to make the word.



### ■ How to change mode

This phone supports three kinds of edit mode : **eZi mode**, **Numeric mode** and **Letter mode**. To change mode just press  key, then you can select the one among three modes.

### ■ How to use in eZi mode



To input text in eZi mode, simply press each key once for each letter.

After inputting the character, you can see that the candidate is appeared in text box, which has a high priority. Also you can choose other candidates using  and .





### E.g. If you want to enter “Meet at church after lunch”.

To type “Meet”, the user types the letters on the keys requiring only one key-hit per letter. The candidate “Meet” is predicted along with other candidates which fit the letters typed thus far. The user uses the select “Meet”.

The user continues inputting characters in a similar manner for the rest of the message. Each candidate only requires a couple of key hits to find the target word.



Now lets demonstrate the predictive power. The word “lunch” is 5 letters long. Text input only requires 4 key hits before the word is predicted.

If at any time the user wants to input some punctuation, they press only  key to input punctuation.

For example, if you want to enter “you”, then press  key once. You can see “we”. Next, press  key, then you can see “you” in the text box. If the word isn't shown, press  key, or search the word with  and .

After entering characters, select the candidate you want with  key.

### ● Notice

- You can change a language with  . And you can also change the capital form with  and  .  
For example : you → You → YOU → Y.O.U → y.o.u.

## ■ How to use in numeric mode



You can use this mode to input number, change another mode by  key.

1. Change the input mode to Numeric.
2. Press the key you want to enter.

## ■ How to use in Letter mode

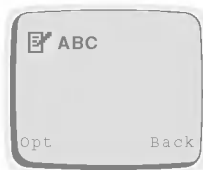

**Capital Mode**

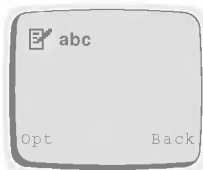



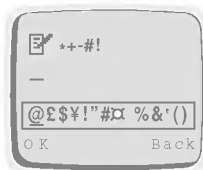

**Small Mode**



**Symbol Mode**

There are three sub modes in Letter mode: **Capital mode**, **Small mode**, and **Symbol mode**.

Key	
	changes another mode e.g. eZi mode → Numeric mode.
	changes Capital mode to Small mode or Small mode to Capital mode.
	enters Symbol mode by pressing this key for a long time.
 	moves next Symbol page in Symbol mode.





### ● Notice

- In case of Symbol mode, after entering the character, mode is automatically converted to CAP letter mode.



## ■ How to use user's dictionary

You can use user's dictionary in case of writing SMS. The eZi Text has user's dictionary. You can add a few words to user's dictionary and then the word has a high priority.





## ■ How to add word to user's dictionary

1. In the screen of eZi text mode press  [Opt] key.
2. Scroll to **Dictionary** menu, press  [OK] key.
3. Press  [Opt] key after entering word you want.
4. Scroll to **Add to UPD** menu, press  [OK] key.
5. If **Done** message is displayed in phone, it is added successfully to user's dictionary.
6. And you can check the word is added on **List Dictionary** menu.

## ■ How to erase word from user's dictionary

1. Scroll to **List Dictionary** menu.
2. Press  [OK] key after selecting word you want to delete.
3. In next screen, press  [Opt] key.
4. Press  [OK] key after selecting **Del from UPD**.
5. If **Done** message is displayed in phone, then it is deleted successfully from user's dictionary.

## Making Calls

1. Key in phone number including the area code. To edit a number on the display, press  to move cursor to the left, and press  to move cursor to the right.
2. Press  to call the number.
3. Press  to end the call (or to cancel the call attempt).

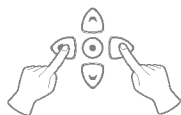



### ■ Voice Dial

1. If you select **Enable** in Setting [7-3], you can call by only voice.
2. When you open the flip, your phone display “Guide Message” and you will hear “Please say name”.
3. Then you must speak a programmed name which you want to call within 5 seconds.
4. Your phone will dial the number associated with that programmed name.







### ● Note

- You have to associate your voice to the desired no. in order to use this function. Refer to Menu 7 (Voice Dial Menu) for further information.



### ■ International Calls

1. Press and hold the  key for the international prefix. (+character replaces the international access code.)
2. Enter the country code, area code and phone number.
3. To call the number, press .

### ■ Making a Call using the Phonebook

1. In a standby mode, select **Names** by pressing  [Names] key.
2. When phonebook menu is displayed, you can select **Search** by pressing  [OK].
3. Key in the first letter of the name and press  [Search].
4. Use  and  key, reach the desired name.
5. Press  to dial.

### ■ Last Number Redial

1. Press  and then you will see the last dialed number.
2. Then press  one more if you want to dial to the number again.
3. If you want to dial the latest number by one key stroke, press and hold .

## ■ Calling your Voicemail Service

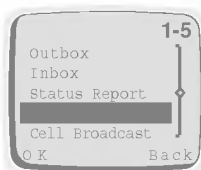

1. Press until your phone goes to calling mode. Or you can call it by using [Menu 1-5]. If you want to use menu, see [Menu 1-5]. (Voicemail Services must be set up with your network operator.)
2. If the phone asks for the voicemail number, key it in and press [OK]. You can obtain this number from your service provider. Also, you can edit this number later on.

## ■ Making Call by Speed Dials

See the Section **Phonebook - Speed Dials**.

## Answering Calls

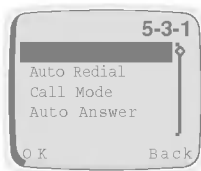

---



1. The way to answer an incoming call is dependent on setting of [Menu 5-3-1].
2. If you select **On** in Any Key Answer [Menu 5-3-1], you can answer an incoming call by pressing any key except . If you select **Off**, you can do it by opening the folder. If folder is already opened, you can also answer the call by pressing .
3. Press or close folder to end the call.

## ■ Answering call during use of Ear-mike (Handsfree Portable):

Press the button on ear-mike for a few seconds to receive an incoming call while ear-mike is connected to the phone.

In a standby mode, when you press  or , these menu items below will be displayed. Dialed Number, Received Number and Missed Number can be saved in a Phonebook.

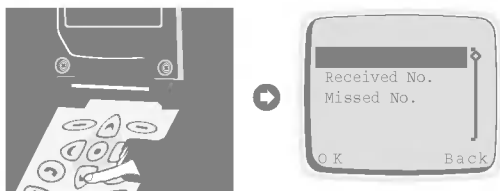

### **Dialed Number**

---

Shows recently dialed phone numbers that were not answered. After locating a phone number, you can make a call or erase the phone number.

### **Received Number**

---

Shows recently received phone numbers up to 10. After locating a phone number you can make a call(if the network provides the service) or erase the phone number.

### **Missed Number**

---

Shows recently missed incoming phone numbers up to 10. Those numbers that were called but were not answered. After locating a phone number, you can make a call or erase the phone number.

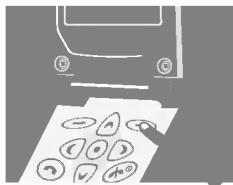

The phonebook has several menus from which you can choose. Press [Names] in a standby mode and then scroll to the desired item.

1	<b>Search</b>	Allows you to search for a specific name.
2	<b>Search E-Mail</b>	Allows you to search for E-Mail address by name.
3	<b>Add Entry</b>	Allows you to add new names and numbers.
4	<b>Add E-Mail</b>	Allows you to add new names and E-mail address.
5	<b>Groups</b>	Allows you to show group list.
6	<b>Speed Dials</b>	Allows you to assign up to 8(2-9) one- touch dial allocations.
7	<b>Delete all</b>	Allows you to erase all the data in either your phonebook or the SIM card by selecting the memory.
8	<b>Memory</b>	Allows you to select the preferred memory of Phone/SIM card or to view the memory status.
9	<b>Copy</b>	Allows you to copy entries from your Phone memory to SIM card or from SIM card to Phone memory.
10	<b>SDN</b>	Allows you to show the Service Dial Number entries.
11	<b>Own Number</b>	Allows you to enter and show your own numbers

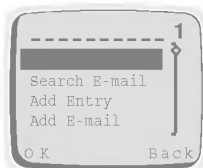

## Search [Names 1]

(Calling from phonebook)







1. Open the phonebook first by pressing [Names] in a standby mode.
2. Select **Search** by pressing [OK] key.
3. Write the first letter or all character of required name and press [Search] then the name(s) will be displayed on the screen.
4. Scroll to highlight required name.
5. Press [OK] to display the name and phone number.
6. If you want to call, press .

### ● Note

- In this menu, you can edit or delete the number you selected. If you do not enter the name and press  [Search], then all entries will be displayed. If you want to find the name "David", you may enter "D" by using the digit keys then you will see names starting with "D", and you choose "David" by scrolling up/down to the required name "David". On the window displayed name and phone number, you can edit or delete them by pressing  [Opt].

## Search E-Mail [Names 2]

---

1. Open the phonebook first by pressing  [Names] in a standby mode.
2. Scroll to highlight **Search E-Mail**, and press  [OK] to enter.
3. Write the first letter or all character of required name and press  [Search], then the name(s) will be displayed on the window.
4. Scroll to highlight the desired name.
5. Press  [OK] to display the E-mail address.

### ● Note

- On the window displayed name and E-mail address, you can edit or delete the name and E-mail address by pressing  [Opt].





## Add Entry [Names 3]

---

You can add name and phone number by using this function. After editing, you can save either to the SIM card or to the Phone memory.

Phone memory capacity is 500 entries of personal number, and SIM card memory capacity of personal number depends on the service provider.

You can also save 20 characters of name in the Phone memory and the SIM card memory each. The number of characters is dependent on SIM feature.





1. Open the phonebook first by pressing  [Names] in a standby mode.
2. Scroll to highlight **Add Entry**, and press  [OK] to enter.
3. Input a name to add.
4. Press  [OK], then the window for inputting number will be displayed.
5. Edit phone number.
6. Press  [OK], then memory selection window will be displayed. In this window, you can store the phone number in, either the SIM card or the Phone.
7. If the memory is available, you can add the entry. However, if the memory is full, then error message will be displayed and the menu will move to the previous step.

## Add E-Mail [Names 4]

---

You can add name and E-Mail address by using this function. After editing, you can save E-mail address only to the phone memory.

You can save up to 30 characters of E-mail name and 50 characters of E-mail address only in a Phone memory.

1. Open the phonebook first by pressing  [Names] in a standby mode.
2. Scroll to highlight **Add E-Mail**, and press  [OK] to enter.
3. Input the name using the keypad.
4. Press  [OK].
5. If Phone memory is available, then the message for inputting E-mail address will be displayed. However, if Phone memory is full, error message will be displayed. In order to add new entry, you need to delete old E-mail list first in Search E-mail menu.
6. Edit E-Mail Address.
7. Press  [OK] to save.





## Groups [Names 5]

---

By choosing this function, you can manage Group list, such as Member list, Add, Delete, Rename.

If you use **Add** menu, you can save up to 20 members in each group.

You can save up to 10 groups only in the Phone memory.



1. Open the phone book first by pressing  [Names] in a standby mode.
2. Scroll to **Groups** item then press  [OK] to enter this menu.
3. Every Group list will be displayed.
4. If you want to Add Group, select <Empty> and press  [Add].
5. Select and input a Group name that you want.
6. After pressing  [Opt] for a selected group, submenus below will be displayed.

### ● Notice

- Selecting this item does not mean that you can add new entry in the Groups. In order to add new entry in the Group, you need to choose Member list.





## ■ Member list:

This menu item has three submenus: Add New Entry, Add Being Entry and Delete Entry.

1. Select **Member list**, then press  [OK] to enter.
2. Then Member list will be displayed.
3. Select Member, and press  [Opt] to enter.
4. Then **Add New Entry**, **Add Being Entry** and **Delete Entry** will show up.
  - **Add New Entry** : You can add a new entry in the selected Group or phonebook.
  - **Add Being Entry** : You can add an existing entry by searching from phone book.
  - **Delete Entry** : You can delete a selected entry in a Group.

## ■ Delete:

You can delete Group in the Group list.





1. Scroll to highlight **Groups**, then press  [OK] to enter.
2. Scroll to highlight **Delete**, then press  [OK] to enter.
3. Then confirmation message will be displayed.
4. Press  [OK] to delete, or press  [Back] to cancel.

### ● Notice

- Even though you delete a Group in the Group list, the entries will remain in memory.

## ■ Rename:



You can change group name.

1. Scroll to highlight **Groups**, then press  [OK] to enter.
2. Scroll to highlight **Rename** item, then press  [OK] to enter.
3. Then Group Name editing window will be displayed.
4. Press  [OK] to rename, and press  [Back] to cancel.

## Speed Dials [Names 6]

---





You can associate any of the keys  to  with a Name list entry to give you direct access, with a single long key press in a standby mode.

1. Open the phonebook first by pressing  [Names] in a standby mode.
2. Scroll to **Speed Dials**, then press  [OK] to enter this menu.
3. Then Speed Dials list will be displayed.
4. There are three submenus: **Add**, **Change** and **Delete**. If you want to add Speed Dials number, select **<Empty>** and press  [**Add**]. You can change the Speed Dials number allocation by entering **Change** and delete the allocated speed dials number by entering **Delete**.

## Delete all [Names 7]



---

You can delete all stored numbers and names. This function may require Security code.

1. Open the phonebook first by pressing  [Names] in a standby mode.
2. Scroll to **Delete all**, then press  [OK] to enter this menu.
3. Then select the memory to erase: SIM card or Phone.
4. Warning message will be displayed to make sure your decision.
5. If you press  [OK] then you may be requested to enter Security Code '0000'.
6. Press  [OK] to erase, press  [Back] to cancel.

## Memory [Names 8]



---

1. Open the phonebook first by pressing  [Names] in a standby mode.
2. Scroll to **Memory**, then press  [OK] to enter this menu.
3. Then menu items below will be displayed.
  - **Select** : This feature allows you to select the memory: SIM card or Phone.
  - **Show Status** : This feature allows you to check the total memories and how many memories are used in your phonebook.

## Copy [Names 9]

---

You can copy entries from one memory to another. You can copy/move entries from SIM card memory to Phone memory once at a time or all at once. And you can copy/move entries from Phone memory to SIM card memory once at a time or all at once.

1. Open the phonebook first by pressing  [Names] in a standby mode.
2. Scroll to **Copy**, then press  [OK] to enter this menu.
3. Then submenus below will be displayed.

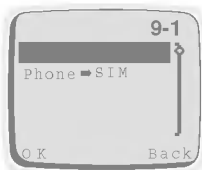

**SIM → Phone** : You can copy/move the entry from SIM Card to Phone memory.

**Phone → SIM** : You can copy/move the entry from Phone memory to SIM Card.

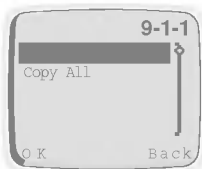

**One by One** : You can copy/move an entry once at a time.

**Copy All** : You can copy/move all entries at once.

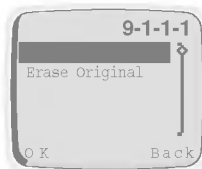

**Keep Original** : Both original and located entries are kept in memories.

**Erase Original** : Original entry is erased whereas located entry remains in the memory.

4. Select the entry to copy/move in the phonebook.
5. Press [OK] to copy/move, and press [Back] to cancel.

## Service Dial Number [Names 10] (SIM dependent)

---

Use this function to access a particular list of services provided by your network operator (if supported by the SIM card).

1. Open the phonebook first by pressing [Names] in a standby mode.
2. Scroll to **SDN**, then press [OK] to enter.
3. The names of the available services will be shown.
4. Use and to select a service.
5. Press to call the service.

## Own Number [Names 11]

---

If you input your phone number, Own Number will show up.

1. Open the phonebook first by pressing [Names] in a standby mode.
2. Scroll to **Own Number**, then press [OK] to enter this menu.
3. The names of the available own number will be shown, if you input your name and number.



## 1 Messages

- 1-1 Write Message
- 1-2 Outbox
- 1-3 Inbox
- 1-4 Status Report
- 1-5 Call Voicemail
- 1-6 Cell Broadcast
  - 1-6-1 CB Option
    - 1-6-1-1 On
    - 1-6-1-2 Off
  - 1-6-2 Read
  - 1-6-3 Topics
    - 1-6-3-1 SIM
      - 1-6-3-1-1 Add
      - 1-6-3-1-2 Delete
    - 1-6-3-2 Phone
      - 1-6-3-2-1 Add
      - 1-6-3-2-2 Select
      - 1-6-3-2-3 Delete
  - 1-6-4 Languages
- 1-7 Memory Status
- 1-8 Setting
  - 1-8-1 Status Report
  - 1-8-2 Message Type
  - 1-8-3 Expiry Period
  - 1-8-4 SMS Centre
  - 1-8-5 Voice Centre
  - 1-8-6 Alert



## 2 Call Option

- 2-1 Call Divert
  - 2-1-1 Voice Calls
    - 2-1-1-1 Divert All Voice Calls
    - 2-1-1-2 Divert if not Reachable
    - 2-1-1-3 Divert if Busy
    - 2-1-1-4 Divert if No Reply
    - 2-1-1-5 Cancel All
  - 2-1-2 All Data Call
  - 2-1-3 All Fax Call
  - 2-1-4 Cancel All
- 2-2 Call Barring
  - 2-2-1 All Outgoing Calls
  - 2-2-2 Outgoing International calls
  - 2-2-3 International except Home
  - 2-2-4 All Incoming Calls
  - 2-2-5 Incoming Calls When Roaming
  - 2-2-6 Cancel All
  - 2-2-7 Password Change
- 2-3 Call Waiting
- 2-4 Sending Number
- 2-5 CUG



## 3 Call Charge

- 3-1 Call Duration
  - 3-1-1 Last Call
  - 3-1-2 All Calls
  - 3-1-3 Incoming Call
  - 3-1-4 Outgoing Call
  - 3-1-5 Reset
- 3-2 Call Costs
  - 3-2-1 Last Call
  - 3-2-2 All Calls
  - 3-2-3 Reset
- 3-3 Cost Settings
  - 3-3-1 Call Cost Limit
  - 3-3-2 Set Tariff
  - 3-3-3 Sum. After Call



## 4 Security

- 4-1 PIN Enable
- 4-2 Change Codes
  - 4-2-1 PIN1
  - 4-2-2 PIN2
  - 4-2-3 Security Code
- 4-3 Fixed Dial No.



## 5 Setting

- 5-1 Network Selection
  - 5-1-1 Automatic
  - 5-1-2 Manual
- 5-2 Phone Setting
  - 5-2-1 Alert
  - 5-2-2 Backlight
  - 5-2-3 Key Tone Volume
  - 5-2-4 Ring Volume
  - 5-2-5 LCD Contrast
  - 5-2-6 Ring Pattern
  - 5-2-7 Language
  - 5-2-8 Welcome Display
  - 5-2-9 Standby Display
- 5-3 Call Setting
  - 5-3-1 Any Key Answer
  - 5-3-2 Auto Redial
  - 5-3-3 Call Mode
  - 5-3-4 Auto Answer
- 5-4 Time Setting
  - 5-4-1 Clock
    - 5-4-1-1 Set Time
    - 5-4-1-2 Set Time Format
  - 5-4-2 Date
    - 5-4-2-1 Set Date
    - 5-4-2-2 Set Date Format
  - 5-4-3 Alarm
    - 5-4-3-1 Set Alarm
    - 5-4-3-2 Cancel Alarm
    - 5-4-3-3 Power Off Alarm
- 5-5 Profiles



## 6 Accessories

- 6-1 Scheduler
  - 6-1-1 View day
    - 6-1-1-1 Delete
    - 6-1-1-2 Edit
    - 6-1-1-3 Send Note
  - 6-1-2 Make
    - 6-1-2-1 Schedule
    - 6-1-2-2 Call
    - 6-1-2-3 Memo
    - 6-1-2-4 Anniversary
  - 6-1-3 Delete
    - 6-1-3-1 Of Chosen Day
    - 6-1-3-2 One by One
    - 6-1-3-3 All At Once
  - 6-1-4 View All
- 6-2 World Time
- 6-3 Calculator
- 6-4 Unit Convert
  - 6-4-1 Length
  - 6-4-2 Weight
  - 6-4-3 Volumes
  - 6-4-4 Surface
- 6-5 Game
  - 6-5-1 Corsair
  - 6-5-2 Crazy Race
  - 6-5-3 Diamond King
  - 6-5-4 Stone Axe
  - 6-5-5 Black Jack



## 7 Voice Dial



- 7-1 Training
- 7-2 Search
  - 7-2-1 Voice Search
    - 7-2-1-1 Edit Voice
    - 7-2-1-2 Edit Number
    - 7-2-1-3 Delete
  - 7-2-2 Number Search
    - 7-2-2-1 Edit Voice
    - 7-2-2-2 Edit Number
    - 7-2-2-3 Delete
- 7-3 Setting
  - 7-3-1 Enable
  - 7-3-2 Disable
- 7-4 Delete all



## 8 Internet









- 8-1 Home
- 8-2 Bookmarks
  - 8-2-1 Go to
  - 8-2-2 Edit
  - 8-2-3 Erase
  - 8-2-4 Add Bookmark
- 8-3 Profiles
- 8-4 Empty cache

## Using the Menu

Your phone offers the functions which allow you to tailor the phone to your needs. These functions are arranged in menus and submenus. The menus and submenus can be accessed by scrolling  and  or by using appropriate shortcut.

### Menu Navigation by scrolling

The Main menu gives you access to all the other menus.

1. Press  or  to reach the desired main menu (e.g. Security). Then press  [Menu] to enter the main menu; on the contrary, press  [Back] to get out of the menus.
2. If you want to enter the submenu, find the one you want by pressing  or . And press  [OK] to enter the submenu, press  [Back] to exit the submenu.

### Shortcuts into Menus

When you know the menu numbers, you can use them to get into a menu quickly. In this book, the menu numbers are shown like this.

1. Press  [Menu].
2. Key in quickly the index number of the menu function you want to access.

For example, to set on the anykey function :

 : for **Entering the menu.**

 : for **Setting.**

 : for **Call Setting.**

 : for **Any Key Answer.**

This menu in your phone includes functions related to text message, voice message, cell broadcast message, as well as setting for message.

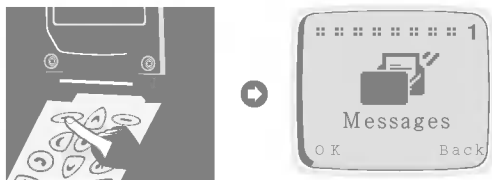

## Write Message [Menu 1-1]

With the **Write Message** menu, you can write and edit text message up to 160 characters. When you have finished writing your message, press [Opt]. Then following menu will be displayed.

### ■ **Send** : Sends the edited message.

1. Once you enter this menu, your phone asks you to enter the number that you want to send it to.
2. After sending it, your phone asks whether you will store the edited message.
3. Press [OK] if you want to store it in Outbox and press [Back] if you don't want to.

### ■ **Store** : Stores the message in Outbox.

1. Your phone asks whether you will store the edited message or not.
2. Press [OK] if you want to store it in Outbox and press [Back] if you don't want to.

■ **Edit eZi Mode** : If you select this, you can write a message by eZi text input method.

■ **Edit LTR Mode** : If you select this, you can write a message in letter mode.

■ **Edit Num Mode** : If you select this, you can write a message in numeric mode.

■ **Dictionary** : In this option, you can add or delete a word to user's dictionary.

1. Press [Opt] key after entering word you want, then you can see the following menu.

**Add to UPD**

**Del from UPD**

2. Select **Add to UPD** if you want to add the word entered before in the user's dictionary of current selected eZi language. This word will be searched by the eZi when you edit in eZi mode.

## Messages [Menu 1]





3. Select **Del from UPD**, if you want to delete word entered before in the user's dictionary or current selected eZi language.



The added word will be searched by the eZi when you edit in eZi mode.

- **List Dictionary** : If you select this, you can see additional words in user dictionary of current selected eZi language. Select a word which you want to edit or delete, and you can select to add or delete new edited word in the following the menu.

### Outbox [Menu 1-2]

---

When you enter this menu, you can see the stored messages. Scroll to the desired message by using  ,  and you can see upper or lower page using  ,  . And if you want to exit Outbox menu, press  [Back].

If you want to edit the message, press  [Edit] and you can edit the message selected. When you have finished editing the message and press the  [Opt], you can show the next menu: **Send, Save, Delete, Delete all**.

- **Send:**

You can send the selected message. The sequence is identical with Send option in Write message.



- **Save:**

You can save the selected message. The sequence is identical with Save option in Write message.

- **Delete:**







The message is deleted.

- **Delete all:**

All messages in Outbox will be deleted. In this menu, your phone will ask you if you really want to delete all messages for safety. Then press  [OK] to remove all messages, and press  [Back] if you don't want to.

### Inbox [Menu 1-3]



---

When a text message is received, your phone shows  and stores it in the incoming message list. It shows the symbol until you read the message. Once you enter this menu, you can see the last received message. Scroll to the desired message by using  ,  and see upper or lower page by using  ,  . If you want to exit Inbox menu, press  [Back]. While reading message, press  [Opt] to access the available options.

#### ■ Delete:

The message is deleted.

#### ■ Reply:

You can reply to the sender by message. Once you enter in this menu, you can edit the message you want to send and press  [OK] to send it or press  [Back] to cancel it.

#### ■ Forward:

You can forward the selected message to another phone number. In this menu, your phone asks you to enter the number and then sends it.



#### ■ Return Call:

You can call back to the sender who sent the message. If you select this item, your phone will dial automatically.

#### ■ Extract number:

With this function, you will be able to extract numbers displayed on the phone. It extracts only the first numbers displayed in the content. Numbers should be composed of more than 2 and less than 21 figures, but for international numbers, more than 8 and less than 21 figures including '+'. There should be no space between the numbers.

#### ■ Delete all:





All messages in Inbox will be deleted. Your phone asks you if you really want to delete all messages for safety. Then press  [OK] to remove them, and press  [Back] if you don't want to.

### Status Report [Menu 1-4]

---

You can receive a status report for sending message by setting it. When you receive a text message of status report, your phone stores it in the status report message lists.

If the memory for status report is full, the phone will delete the oldest status report automatically and store the latest status report.



Once you enter this menu, you can see the previous stored status report. Scroll to the desired message by using  ,  and see upper or lower page by using  ,  . And if you want to exit Status Report menu, press  [Back]. While reading message, press  [Opt] to access the available options.

# Messages [Menu 1]

## ■ Delete

The selected status report message is deleted.

## ■ Delete All

All messages in Status Report will be deleted. Your phone asks you if you really want to delete all messages for safety. Then press  [OK] to remove all messages, and press  [Back] if you don't want to.

## Call Voicemail [Menu 1-5]



---

In this menu, you can listen to your voice messages. If your phone stores voice message centre address, it will call automatically, otherwise, it will ask to enter address.

## Cell Broadcast [Menu 1-6]

---

Cell broadcast messages are text messages broadcasted by the network to groups of GSM phone users. They provide general information such as weather reports, traffic news, and stock market prices. Each type of information has an associated information type number. When you receive broadcast message, you can read it following sequence :





1. When you receive broadcast message, it is automatically displayed on the window. If the message is so long that cannot be displayed all in a window, you can read it by scrolling  and .
2. After reading the message, press  [OK] to return to the Idle mode.
3. Your phone will store it until a new message of the channel is reached.
4. If you want to read it again, see the [Menu 1-6-2](Read).

## ■ CB Option [Menu 1-6-1]

- **On [1-6-1-1]** : If you select this menu, your phone will receive Cell Broadcast messages.
- **Off [1-6-1-2]** : If you select this menu, your phone will not receive the Cell Broadcast messages anymore.

## ■ Read (Dependent on network and subscription) [Menu 1-6-2]

You can read the stored broadcast messages in this menu. In addition, your phone stores only the last message of each channel.

1. If you select this menu, your phone will display the message.
2. You can read it. If it is so long that cannot be displayed in a screen, scroll by pressing  and .
3. After reading, press  key to read next message, and press  [Exit] to exit this menu.



## ■ Topics (Dependent to network and subscription) [Menu 1-6-3]

### SIM

If you select this menu, you can add or delete the CB message category in SIM memory. If you select the **Add** menu, you can enter the only category numbers which consists in a pair of number.

If you select **Delete** menu, you can see the list of CB message category and delete it by using  [Delete].

### Phone

If you select this menu, you will add, select and delete the CB message category in Phone memory. If you select the **Add** menu, you will add the CB message category numbers with its nickname. If you select **Select** menu, you can see the list of CB message category numbers with its nickname and select them by using  [OK] to activate or deactivate them. If you select the **Delete** menu, you can see the list of CB message category numbers with its nickname and an delete them by using  [Delete].

## ■ Languages [Menu 1-6-4]

You can select languages in this menu. Then your phone will receive the cell broadcast messages written in the selected language.

1. In this menu, you can see several languages. (e.g.- English, French, ...)
2. Scroll to highlight the language you want, select on/off.
3. You can select more than one item through the procedure of 1~2.

## Memory Status [Menu 1-7]

---

If the user selects this menu, the phone shows an used memory and total amount of memory. The total memory is sum of SIM and Phone memory.

## Setting [Menu 1-8]

---

### ■ Status Report [Menu 1-8-1]

In this menu, you can set the message service to receive messages which will be sent. This report is represented whether the message is sent to destination successfully or not.

- **On** : If you select this menu, you will receive the status report of message.
- **Off** : If you select this menu, you will not receive the status report of message.

## ■ Message Type [Menu 1-8-2]

:Text, Voice, Fax, X.400, E-mail, ERMES

Usually, this menu choice should be set to “Text”. Your message service may, however, offer you the facility of converting your text message into alternative formats which are suitable for the equipment that will be receiving messages. Contact your service provider for the availability of this function.

## ■ Expiry Period [Menu 1-8-3]

This network service allows you to set how long your text messages will be stored at the message centre while attempts are made to deliver them to you: **1 hour, 6 hours, 12 hours, 1 day, 2 days, 1 Week, Max.**

## ■ SMS Centre [Menu 1-8-4]

In this menu, your phone asks for the address of your SMS centre. This is needed for sending text messages.

## ■ Voice Centre [Menu 1-8-5]

In this menu, your phone asks to enter the number for your voice message. This is needed for listening to your voice messages.

## ■ Alert [Menu 1-8-6]

The user can set how many times and how often the phone alerts the user to incoming messages.

Use the "Call Option" menu to access supplementary services provided by the GSM network.







### Note

- The Call Divert, Call Barring, and Call Waiting menus each contains an option for displaying the current status of the service. This function makes a call to the network. This call may be charged to you. Check with your service provider.

## Call Divert [Menu 2-1]

(network and subscription dependent)





The Call Divert service diverts incoming voice calls, fax calls, and/or data calls to another number.

1. Press  [Menu] in a standby mode.
2. Press  for direct access or use  and  to enter Call Option.
3. Select **Call Divert** menu and press  [OK] to enter.
4. Select **Voice Calls**.

### ■ Voice Calls [Menu 2-1-1]





- **Divert All Voice Calls** : Divert calls unconditionally.
- **Divert if not Reachable** : Divert calls when the network cannot reach you.
- **Divert if Busy** : Divert calls when the phone is busy.
- **Divert if No Reply** : Divert calls which you do not answer.
- **Cancel All** : Only cancel voice call divert.

### ■ All Data Call [Menu 2-1-2] : Divert all data calls unconditionally.





1. Press  [Menu] in a standby mode.
2. Press  for direct access or use  and  to enter Call Option.
3. Select **Call Divert** menu and press  [OK] to enter.
4. Select **All Data Call**.

## Call Option [Menu 2]

### ■ All Fax Call [Menu 2-1-3] : Divert all fax calls unconditionally.

1. Press  [Menu] in a standby mode.
2. Press  for direct access or use  and  to enter Call Option.
3. Select **Call Divert** menu and press  [OK] to enter.
4. Select **All Fax Call**.

### ■ Cancel All [Menu 2-1-4] : Cancel all voice, data and fax call divert.





1. Press  [Menu] in a standby mode.
2. Press  for direct access or use  and  to enter Call Option.
3. Select **Call Divert** menu and press  [OK] to enter.
4. Select **Cancel All**.

## Call Barring [Menu 2-2]

---

(network and subscription dependent)

The Call barring service prevents your phone from making and/or receiving certain categories of calls. This function requires the call barring password obtained from your service provider.





1. Press  [Menu] in a standby mode.
2. Press  for direct access or use  and  to enter Call Option.
3. Scroll to highlight **Call Barring** menu and press  [OK] to enter.
  - **All Outgoing Calls** : The barring service of all outgoing calls.
  - **Outgoing International Calls** : The barring service of outgoing international calls
  - **International except Home** : The barring service of all international outgoing calls, except to your home network.
  - **All Incoming Calls** : The barring service of all incoming calls.
  - **Incoming Calls When Roaming** : The barring service of all incoming calls when roaming.
  - **Cancel All** : Only cancels the barring service of voice call.
  - **Password Change** : Changes Call Barring password.

## Call Waiting [Menu 2-3]

---

(network and subscription dependent)

Activate or deactivate the Call Waiting service. If this service is activated, the user can accept a waiting(incoming) call. If this service is deactivated, the user cannot accept a waiting(incoming) call and cannot recognize it.

1. Press  [Menu] in a standby mode.
2. Press  for direct access or use  and  to enter Call Option.
3. Scroll to highlight **Call Waiting** menu and press  [OK] to enter.





## Sending Number [Menu 2-4]

---

(network and subscription dependent)

This menu is valid only when the user subscribes temporary mode.

If you Select **On**, you allow your phone number to be displayed to the other party. Also, you can change this mode On/Off you want.





1. Press  [Menu] in a standby mode.
2. Press  for direct access or use  and  to enter Call Option.
3. Scroll to highlight **Sending Number** and press  [OK] to enter.

## Closed User Group [Menu 2-5]

---

(network dependent)

Use this function to restrict usage of the phone to calls with numbers that belong to certain user groups. When this function is used, every outgoing call is associated with a group index. If a group index is specified, it is used for all outgoing calls. If no group index is specified, the network will use the preferential index (a specific index that is stored in the network).

1. Press  [Menu] in a standby mode.
2. Press  for direct access or use  and  to enter Call Option.
3. Scroll to highlight **CUG** and press  [OK] to enter.



## Call Duration [Menu 3-1]

---

This function allows you to view the duration of your Last Call, All Calls, Incoming Call and Outgoing Call in hours, minutes and seconds. You can also clear the call timers.

1. Press [Menu] in a standby mode.
2. Press for direct access or use and to enter Call Charge.
3. Select **Call Duration** and press [OK] to enter.
4. This menu has 5 submenus. You can choose the item that you want to see.

## Call Costs [Menu 3-2]

---

This network service allows you to check the costs of your last call or all calls and clear the counters. To clear the counters you need the PIN2 code. The Costs are shown for each SIM card independently in terms of the unit set within [Menu 3-3-2].

### ● Note

- The actual cost invoiced for calls by your service provider may vary depending upon network features, rounding-off for billing, taxes, etc.

1. Press [Menu] in a standby mode.
2. Press for direct access or use and to enter Call Charge.
3. Scroll to highlight **Call Costs** and press [OK] to enter.
4. This menu has 3 Submenus. Select the item that you want to.

## Cost Settings [Menu 3-3]





---

(SIM dependent)

### ■ Call Cost Limit [Menu 3-3-1]





This network service allows you to limit the costs of your calls to a selected number of charging units. If you have selected **On**, you can set cost limit in terms of unit and use your phone to a selected number of charging units. If you have selected **Off**, you can use your phone without cost limitation. When all units have been used, no calls can be made except emergency calls.

To set a call cost limit, you need the PIN2 code.

1. Press  [Menu] in a standby mode.
2. Press  for direct access or use  and  to enter Call Charge.
3. Scroll to highlight **Cost Settings** and press  [OK] to enter.
4. Select **Call Cost Limit** to enter.



### ■ Set Tariff [Menu 3-3-2]

You can set currency name and unit price. Contact your service provider to set the chargeable unit prices. To select the currency or unit in this menu, you will need the PIN2 code.

1. Press  [Menu] in a standby mode.
2. Press  for direct access or use  and  to enter Call Charge.
3. Scroll to highlight **Cost Settings** and press  [OK] to enter.
4. Select **Set Tariff** to enter.

### ■ Sum. After Call [Menu 3-3-3]

You can check the duration and the cost of call during a call or after ending a call if you set **On**.

1. Press  [Menu] in a standby mode.
2. Press  for direct access or use to enter Call Charge.
3. Scroll to highlight **Cost Settings** and press OK to enter.
4. Select **Sum After Call**.



<Press three times>



## PIN Enable [Menu 4-1]

---

Within this menu, you can set the phone to ask for the PIN code of your SIM card when the phone is switched on. To use this function, you will be requested to enter the PIN code.

1. Enter this menu by selecting **PIN Enable**. Then your phone requests to enter PIN code if PIN request is enabled.
2. Key in your PIN code.
3. Press [OK] to verify entered PIN code, and press [Back] to erase a character you entered.
4. Then following menu will be displayed.
  - **Enable** : Enable PIN code request.
  - **Disable** : Disable PIN code request.

## Change Codes [Menu 4-2]

---

This menu provides you with the function of changing access codes : **PIN1**, **PIN2 code**, and **Security code '0000'**.

1. Enter this menu by selecting **Change Codes**.
2. And select **PIN1**, **PIN2**, or **Security Code**.
3. Input your original PIN codes and press [OK].
4. Your phone asks you to enter the PIN1/PIN2 code or Security Code which would replace ones and press [OK]. Then phone requests the new PIN codes or Security Code again.
5. If you key in correct original PIN1/PIN2 code or Security Code and make correct confirmation for new ones, they will be changed.

## Fixed Dial Number [Menu 4-3]

---

You can restrict your outgoing calls to selected phone numbers, if this function is supported by your SIM card. These numbers are protected by your PIN2.

1. Enter this menu by selecting **Fixed Dial No.** Your phone will request the PIN2 code.
2. Key in your original PIN2 code and press  [OK]. If you key in PIN2 code is correct, following menu will be displayed.
  - **Enable** : Providing the function for you of restricting your outgoing calls to selected phone numbers, if it is supported by your SIM card.
  - **Disable** : No restriction on outgoing calls.
  - **Number** : Allows to add, to edit and to delete the Fixed Dial Number.



<Press four times>

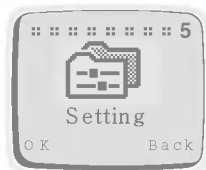

## Network Selection [Menu 5-1]

---

You can select the network which you will be registered either automatically or manually.

### ■ Automatic [Menu 5-1-1]

The phone automatically selects network which is available in the area.

### ■ Manual [Menu 5-1-2]

The phone will find the list of available networks and show it to you. Then you can select the network which you want to use if this network has a roaming agreement with your home network operator.

## Phone Setting [Menu 5-2]

---

### ■ Alert [Menu 5-2-1]

This setting defines how the phone will notify you about an incoming voice call: **Ring**, **Vibrate**, **Vibrate & Ring**, **Ring After Vibrate**, and **Silent**. Once you select this menu, the following is possible.

This phone shows the menu : Ring, Vibrate, Vibrate & Ring, Ring After Vibrate, Silent by pressing  and  and select one.

### ■ Backlight [Menu 5-2-2]

You can set how long you want the keypad and display to light up each time you press a key : **Off**, **Always Open Flip**, **20 seconds**, **10 seconds**, **5 seconds**.

### ■ Key Tone Volume [Menu 5-2-3]

You can set the volume level for the pressed key tone : **Level 1~5**, and **Off**.

### ■ Ring Volume [Menu 5-2-4]





You can set the volume level for the ringing tone : **Level 1~5**, and **Off**.

### ■ LCD Contrast [Menu 5-2-5]

You can set the color contrast of the characters on the LCD: Value 0~9.

### ■ Ring Pattern [Menu 5-2-6]

If you select this menu, you can select the various ring pattern and ring tone.

1. Enter this menu. Your phone will ask to select the ring tone and the ring pattern.
2. Your phone shows the list of ring pattern. Select one out of them by pressing , . Also, you can change the ring tone by pressing , .

### ■ Language [Menu 5-2-7]

This menu provides you with selection of the language in which the display texts will be shown. If the setting Automatic is selected, the language used is chosen based on the current SIM card. English will be used if the language on the SIM card is not found in the phone.

### ■ Welcome Display [Menu 5-2-8]

This menu allows you to set the text or animation which is shown briefly when the phone is switched on.

1. Scroll to highlight **Welcome Display**.
2. Then following menu will be displayed.
  - **Text** : Your own text can be displayed. If you select this item, your phone asks you to edit the message.
  - **Animation** : Animation will be displayed.

### ■ Standby Display [Menu 5-2-9]

This menu allows you to select the standby window display. You can select one out of **Zodiac (User Own, Monthly)**, **Digital Clock**, **Analog Clock**, **Normal**, and **Text**. In text mode, you can edit the text.

## Call Setting [Menu 5-3]

---

### ■ Any Key Answer [Menu 5-3-1]

- **On** : If you select this, you can answer the phone either by opening the folder or pressing any keys except END/PWR key while folder is opened.
- **Off** : If you select this, you can answer the phone only by pressing .

### ■ Auto Redial [Menu 5-3-2]

- **On** : When this function is set on, your phone will make up to 10 attempts to connect the call after an unsuccessful call attempt.
- **Off** : When this function is set on, your phone will not make any attempts to connect the call after an unsuccessful call attempt.

## ■ Call Mode [Menu 5-3-3]

In this menu, you can use the phone and a connected PC to send and receive faxes, data, and voice. Once you enter this menu, the following options are displayed.

- **Single Mode** :  
To use a data or a fax service, make sure that call mode is **Single mode**. In this mode, you can communicate voice, data or fax.
- **Voice and Fax** :  
In this mode, you can transmit voice and also fax.
- **(SINGLE NUMBER) RX VOICE AND FAX**
- **(SINGLE NUMBER) RX FAX**
- **(SINGLE NUMBER) RX DATA**

In case of single numbering service, you can use these modes. If you select mode, you can receive data, fax or fax with voice each mode.

### ● Notice

- Single numbering service means that the number of fax or data service is identical with the number of voice service. And, these modes depend on network feature.

## ■ Auto Answer [Menu 5-3-4]

This function will be activated only when your phone is attached to the Handsfree kit or Portable Handsfree.

- **Off** : When the phone rings, you must actively answer it.
- **5 Seconds** : After 5 seconds, your phone will answer automatically.
- **10 Seconds** : After 10 seconds, your phone will answer automatically.

## Time Setting [Menu 5-4]

---

### ■ Clock [Menu 5-4-1]

The phone has its own clock. In this menu you can set the time and select between the 12-hour or 24-hour time formats.

- **Set Time** : You can set time of your phone in this menu. After setting the time, press  [OK] to store it.
- **Set Time Format** : You can select time format between 12-hours or 24-hours.

## ■ Date [Menu 5-4-2]

- **Set Date** : You can set the date on your phone.(year, month, day) The way to edit the date is identical to “Clock”
- **Set Date Format** : You can set the date format in this menu:  
yyyy/mm/dd or dd/mm/yyyy or mm/dd/yyyy.

## ■ Alarm [Menu 5-4-3]

Your phone can be used as an alarm. The setting is made by the same method as used in time setting.

- **Set Alarm** : You can set alarm which your phone will raise according to Hour and Minute.
  1. Select Alarm.
  2. Set the time your phone will raise the alarm. The way to edit time is identical to “Clock”.
  3. Then your phone raises alarm every day until you will cancel in following “Cancel Alarm”.
- **Cancel Alarm** : You can cancel the alarm which was set.
  1. In this menu, you may select the alarm which you will cancel.
  2. Then your phone cancels alarm.
- **Power Off Alarm** : The alarm signal sounds at the time set, even if the phone is turned off.

## Profiles [Menu 5-5]

---

In this Menu, You can select a group of settings to adjust a variety of environments. (e.g. When you are in outdoor, you can choose the outdoor profile, Etc) Environments are Normal, Silent, Outdoors, and User Own.

A group of settings are Alert, Key Tone Volume, Ring Volume.

### ■ Normal/Silent/Outdoors

- **Activate** : You can adjust the profile as environments.  
Alert, Key Tone Volume, and Ring Volume are set simultaneously.
- **Change** : You can change the value of settings.  
; Alert, Key Tone Volume, Ring Volume.

### ■ User Own

- **Edit Name** : You can edit Profile Name.
- **Activate** : You can adjust the profile as your own environment.
- **Change** : You can change the value of settings.

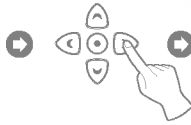

<Press five times>

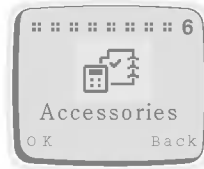

## Scheduler [Menu 6-1]

When you enter this menu, a Calendar will be displayed. On top of the screen there are sections for date and icons. You can change the day, month and year by using navigation keys and numeric keys. A square cursor will highlight the selected day. An underscore on a particular date means there is an entry for that day. An alarm can be set to remind you of scheduled events.

### ■ View day

Shows notes set for the chosen day. Use  $\Delta$ ,  $\nabla$  to browse through the note(s). If you set alarm for the note, alarm watch is displayed. Press  $\odot$  [Opt] to delete, edit, send note you select.

- **Delete** : allows you to delete the note.
- **Edit** : allows you to edit the note.
- **Send Note** : allows you to send the note as Short Message (SMS). For details see Messages [Menu 1].

### ■ Make

Allows you to write a note. You can choose the following types of note. You can edit a maximum of 40 characters, and make a maximum of 50 schedules.

- **Schedule** : Input the subject time and alarm time and the press  $\odot$  [OK].
- **Call** : Input the phone number(or recall it from the Phone Book), the time and alarm time and then press  $\odot$  [OK].
- **Memo** : Input the subject and alarm time and then press  $\odot$  [OK].
- **Anniversary** : Input the subject time and alarm time and then press  $\odot$  [OK]. You can select a title from the submenu **Birth day, Wedding, Memorial, Etc.**

## ■ Delete

Allows you to delete for the selected note(s).

- Of Chosen Day
- One by One
- All At Once

## ● Note

- On the selected date, the alarm will sound and the note will be displayed.

## ■ View All

Shows the notes that are set for all days. Use  $\Delta$  and  $\nabla$  to browse through the note(s). Pressing  $\ominus$  [opt] allows to access to the same menu as in 'View day'.

## World Time [Menu 6-2]

---

This function shows the world map, cities and local time. The Current time is displayed according to time format(12/24 Hours). Press  $\leftarrow$ ,  $\rightarrow$  to change the time zone and  $\Delta$ ,  $\nabla$  to browse city names. Press  $\ominus$  [Set] to set your phone time to the local time of the selected city.

## Calculator [Menu 6-3]

---

This function supports basic mathematical calculations such as addition, subtraction, multiplication and division.

1. Input the numbers you want to calculate.
2. In order to select the function, use  $\leftarrow$  and  $\rightarrow$ . The selected operator will be highlighted with square cursor. Press  $\text{EQ}$  [Easy Key] to make sure your choice.
3. When you have finished the calculation, you can choose "=" operator or  $\ominus$  [Result] key to see the result.

## Unit Convert [Menu 6-4]

---

1. Select the menu items that you want to convert.  
**Length, Weight, Volumes, Surface.**
2. Put the numbers to convert by using  $\leftarrow$  and  $\rightarrow$  and numeric keys.
3. And select the unit which is related to the current value.
4. Finally select the unit which you want to convert current value to.
5. Then required value and unit will be displayed.

## Game [Menu 6-5]

---

The following games are programmed in the phone.

- Corsair
- Crazy Race
- Diamond King
- Stone Axe
- Black Jack

### ● Note

The Control keys are different for each game.

But each game has screens to explain the main control key.

Other common control keys are below.

[Common Key Function]

-  [Soft 1 Key] : Pause Game
-  [Soft 2 Key] : Continue Game
-  [Send Key] : Start Game, Save Score
-  [Power Key] : Exit Game

### PC Sync

PC Sync is a program for data exchange PC & Phone by data cable.

Therefore, if you want to use this function, you have to purchase accessory kit. About more detail for using guide refers to PC Sync help file on the PC Sync CD.

You can dial a number by speaking to your GSM Phone.



## Training [Menu 7-1]

---

You can programme your phone to associate a voice tag with the number which will be entered. Once you select this menu, you should speak a word within 2 seconds, and the phone asks you to speak it again to ensure the accuracy of voice recognition. After voice recognition has finished, you can enter the associated number.

## Search [Menu 7-2]

---

You can use this menu to edit, delete, and ensure what voice exists.



### ■ Voice Search [Menu 7-2-1]

You can find the number you want by voice.

The procedure is similar except the result. The result is another menu.

- **Edit voice** : You can change a voice tag. It is similar to training except putting the number.
- **Edit number** : You can change a number. It will show the number related with the voice tag. After editing it, press  [OK].
- **Delete** : You can delete the voice tag and number.

### ■ Number Search [Menu 7-2-2]

You can find the only numbers recorded by number. You don't have to type all numbers. It will show the numbers including part for to type in. You can hear the voice and see the number using  and . You can hear the voice positioned the number by pressing  on the side of the phone. The submenus are same to Voice Search submenu.

## Voice Dial [Menu 7]

### Setting [Menu 7-3]

---

- **Enable** : You can call by voice if you select this function.
- **Disable** : You cannot call by voice.

### Delete all [Menu 7-4]

---

This menu provides you with the ability of deleting all voice dial numbers.

You can surf the Internet and get the latest information. This information is made available in a special format (WAP) adapted to the display options available in the phone. Accessing the Internet may be required registration with your Service Provider.

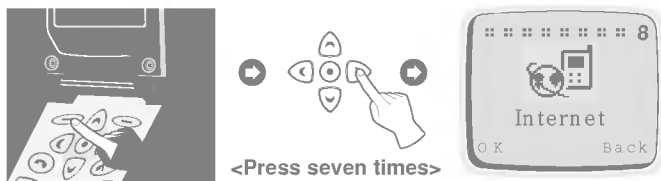

## Home [Menu 8-1]



---

Return to homepage. The homepage may be the site which is defined in activated profile by your service provider.

To activate WAP, either press  key for a few seconds in Standby mode or press  [OK] button in Home menu [Menu 8-1].

## Bookmarks [Menu 8-2]

---

When you enter this menu, your personal list of bookmarks will be displayed. Also, you can save bookmarks up to 9. Then press  [OK] to access available option, or press  [Back] to exit it.

- **Go to** : Move to selected bookmarks.
- **Edit** : Edit the address and title of selected bookmark.
- **Erase** : Erase selected bookmarks from the bookmark list.
- **Add Bookmark** : Edit the address and title of the site which you want to add your favourite bookmark list.

## Profiles [Menu 8-3]

---

Display or enter your own profile settings for the internet connection. You can make up to 5 profiles and activate the required option. Scroll to desired profile and press  [OK] to access available options.

- **Activate** : Activate the selected profile.
- **Setting** : Set the profile details.
  - 4 **Profile Name** : Edit the Profile Name.
  - 4 **Dial-up Number** : Edit the data call number.
  - 4 **Call type** : Select the call type.
  - 4 **IP Address** : Edit the IP address of gateway which you want to connect to.
  - 4 **IP Port** : Edit the IP port number of gateway which you want to connect to.
  - 4 **Log-in name** : Edit the login name of the homepage defined in selected profile.
  - 4 **Password** : Edit the password of the homepage defined in this profile.
  - 4 **Homepage** : You can edit the address of site. This address will be connected when you select the menu Internet - Home or start Internet through .

## Empty Cache [Menu 8-4]

---

Your phone will remove the contents of Cache memory.

# In Internet Menu

## ■ Home

Refers to [Menu 8-1].

## ■ Bookmarks

Refers to [Menu 8-2].

## ■ Save as Bookmark

You can add the site which your phone is connecting to bookmark list in this menu.

## ■ Go to URL

Moves to the site you require. In this menu, you can edit the site address.

## ■ Show URL

In this menu, it will show you the URL of current connected page.

## ■ Reload

Reloads current connected page.

## ■ Empty Cache

Refers to [Menu 8-4].

## ■ Exit

Disconnects and exits WAP.

# How to Send DTMF tones

Some telephone services (such as telephone answering machine and pager) require your telephone to transmit DTMF tones (Dual Tone Multi-Frequency), also known as “touch tones”. These are used to communicate passwords, call back numbers, and so on.

## Wait Characters

---

To obtain a wait character, press and hold . The display shows **P** for a wait. The phone always interprets the **P** as a wait character.

When you dial a number containing a wait character, your phone dials the first part (the phone number) and then waits for the call to be connected before sending the rest of the digits as DTMF tones.

## Interrogating your Answering Machine (example)

---

**For example:** To hear all messages on your answering machine (password 5452) at phone number 12345678, you can call: 12345678P5452. The phone dials 12345678 and waits for the call to connect. When connected, the phone transmits 5452 (the password).

## During a Call

---

When you need to send DTMF tone, just press the numbers, then DTMF tone will be sent.

# In-Call Options

The phone provides a number of control functions that you can use during a call. You cannot utilize all of these functions at all times. Most of the In-Call options are network services. By pressing  [Opt] during a call, the following In-Call options may be available:

## ■ Hold Call

(network dependent)

During a call, you can put an active call on hold.

1. During a call, press  [OK] to enter In-Call Option.
2. Select **Hold Call** to put an active call on hold.

## ■ Retrieve Call

(network dependent)

If you have a call already on hold, you can retrieve that call.

1. During a call, press  [OK] to enter In-Call Option.
2. Select **Retrieve Call** to retrieve a held call.

## ■ Swap Call

(network dependent)







When there are an active call and a held call, this menu places the active call on hold and the Held call on active. You may swap back and forth required.

1. During a call, press  [OK] to enter "In-Call Option".
2. Select **Swap Call** to swap an active call and a held call.

## ■ Conference Call

(network dependent)

This feature allows up to six persons to take part in a conference call (network dependent.).

1. While in a call, dial phone number and press . The first call is put on hold.
2. To join the first conference participant in the call, press  [Opt], choose conference call, select join and press  [OK].
3. To add a new participant to the call, repeat steps 1 and 2.
4. To drop a single participant from the call, press  [Opt], choose conference call, select private and press  [OK]. Select the participant that you want to drop and press .
5. To end the conference call, close the flip.

## ■ Disconnect

You can disconnect the call that is already on hold, currently active and all calls by scrolling up and down the menu items such as Active call, Hold call, and All calls.

- Active call
- Hold call
- All calls

## ■ Mute On

If this function is selected, the other party cannot hear you but you can hear the other party's voice. When the call is disconnected, the Mute Off will be activated automatically. Default Setting is Mute Off.

1. During a call, press  [Opt] to enter In-Call Option.
2. Select **Mute On** to mute your phone.

## ■ Mute Off

If this function is selected, the other party can hear you. Default Setting is Mute Off.

## ■ DTMF On

If this function is selected, you can send DTMF tones. Default Setting is DTMF ON. For details, see how to send DTMF.

1. During a call, press  [Opt] to enter In-Call Option.
2. Select **DTMF On** to send DTMF tones.

## ■ DTMF Off

If this function is selected, you cannot send DTMF tones. Default Setting is DTMF ON.





1. During a call, press  [Opt] to enter In-Call Option.
2. Select **DTMF Off** to prohibit from sending DTMF tones.

## ■ Scratch PAD

You can take a note(phone number) while a call is in a progress by using this function. After disconnecting the call, the phone number will be displayed on the screen and you can save it a phonebook and connect a call by pressing .

1. During a call, press  [Opt] to enter In-Call Option.
2. Select **Scratch PAD** to take a note(phone number).

## ■ Recording

When you need to record your call, press and hold  then your call will be recorded. To stop the recording, press ,  or just close the flip. To play back your recordings, see the <Voice Memo> section. For details, see <Voice Memo>. During a call, press and hold  on the right side of the phone.

## ■ Message

If you select this function, you can go to the message menu [Menu 1].  
For details see <Message> [Menu 1].

1. During a call, press  [Opt] to enter In-Call Option.
2. Select **Message** to send message.

## ■ SIM SERVICE

Your service provider can offer special application through SIM card, such as homebanking, stock market, etc. If you are registered for one of these services, the service name will appear at the end of the Main Menu. With the SIM Services menu your phone is future-proof and will support additions to your service provider's service. For further information contact your service provider.

To be able to data or fax service, you need the communicate software such as a data or a fax program. Before using these functions, you need to connect your phone to a computer or make sure that your phone is in connection with a compatible device.

## Making a Data or Fax call

---

To use a data or a fax service, make sure that call mode is “single mode” (Setting → Call Setting → Call Mode → Single Mode). In this mode, you can communicate voice, data or fax. If you set call mode to be “voice & fax mode” (Setting → Call Setting → Call Mode → Voice & Fax mode), you can transmit voice and fax without voice call release.

### ■ Sending a data or fax call

1. Connect your computer to the phone.
2. After starting the communicate software, make a call and transmit a data or fax.
3. After the data or fax transmission, you can end the call by just ending of the communicate software, pressing  or by closing the flip.

### ■ Receiving a data or fax call

1. Connect your computer to the phone.
2. After starting the communicate software, accept a call and receive a data or fax.
3. After the data or fax reception, you can end the call by just ending of the communicate software, pressing  or by closing the flip.

## Making a Voice & Fax call



---

In this mode, you can transmit voice and also fax without voice call release.

### ● Note

- This mode is network feature. If the network doesn't support this mode, you can't use a voice & fax call.

## ■ Sending voice and fax calls

1. Connect your computer to the phone.
2. Select **Voice and Fax mode**. **Voice and fax mode** allows you to switch from voice mode to fax mode during call.
3. If **Selected** message is displayed in phone, it is ready for transmission.
4. Key in or recall the desired phone number and press .
5. After the voice transmission, you can start a fax transmission.
6. After the fax transmission, you can end the call by just ending of fax software, pressing  or by closing the flip.

## ■ Receiving voice and fax calls



1. Connect your computer to the phone.
2. After the voice transmission, you can answer the fax call by starting the software program (if it does not answer automatically).

# Voice Memo

The voice memo features you to record up to 3 voice messages and each one is up to 30 seconds. This is useful when you don't have a pen and paper to hand for taking directions or a messages.





## Voice Memo

---

1. To use this function, press  [Record Key] for a long time during a call or in a standby mode.
2. Recording is started and display will show the message **Recording** and the recording time.
3. If you want to finish recording, press  [Record Key] shortly.

## Voice Memo Menu

---

The phone shows voice memo information which includes the recording time and date by pressing  [Record Key] for a short time. After you selected the memo by using  and , press  [Opt], you can see this menu.

### ■ Play [Voice Memo Menu 1]

You can play the selected voice memo in this menu. Also, you can hear your voice memo through speaker on the rear of the phone.

### ■ Delete [Voice Memo Menu 2]

You can delete the selected voice memo.

### ■ Delete All [Voice Memo Menu 3]

Your phone will delete all recorded voice memos.

# Care and Maintenance

**When using this unit, basic safety precautions as below should be always followed.**

- Do not touch the adapter with wet hands.
- Do not disassemble this unit. (Take it to a qualified service technician when repair work is required.)
- Away from electrical appliance such as a TV, radio or personal computer.
- The unit should be situated from heat sources such as radiators or cookers.
- Do not drop.
- Do not subject this unit to mechanical vibration or shock.
- The coating of the phone may be damaged if covered with wrap or vinyl wrapper.
- Use dry cloth to clean the exterior of the unit. (Do not use solvent such as benzene, thinner or alcohol.)
- Do not subject this unit to excessive smoke or dust.

## ■ Caring for the Battery

- The battery delivered with your phone has to be fully charged before using it.
- You do not need to completely discharge the battery before recharging. Unlike other battery systems, there is no memory effect that could compromise the battery's performance.
- Use only LG batteries and chargers. LG chargers are designed to maximize the battery life.
- Do not disassemble or short-circuit the battery pack.
- Keep the metal contacts of the battery pack clean.
- Replace the battery when it no longer provides acceptable performance. The battery pack may be recharged hundreds of times until it needs replacing.
- Recharge the battery if it has not been used for a long time to maximize usability.
- Do not expose the battery charger to direct sunlight or use it in high humidity, such as the bathroom.
- Do not leave the battery in hot or cold places, this may deteriorate the battery performance.

# Technical Data

## General

---

Product Name : LG-600

System : GSM 900/DCS 1800

SIM Card : Small plug-in card, 3V or 5V type

## Dimensions

---

Size : 80 X 44 X 25 mm

Weight with Standard battery : 90.4g

## Ambient Temperatures

---

Max : +55°C

Min : -10°C



# Telefon GSM

BUKU PANDUAN PENGGUNA

MODEL : LG - 600

Sila baca buku panduan ini dengan teliti sebelum menggunakan telefon anda. Simpan ia  
dalam tempat yang selamat dan mudah dijangkau.



**LG-600 mempunyai gaya yang memberikan pengguna lebih keselesaan dan kemudahan**

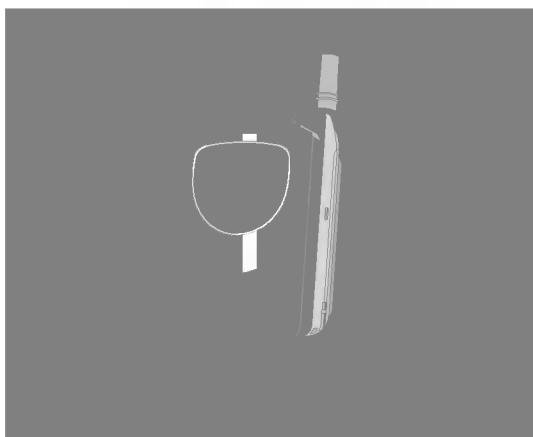

Semua pemancar radio membawa risiko gangguan dengan barangan elektronik yang berdekatan.



Telefon-telefon GSM mestilah sentiasa dimatikan di dalam kapal terbang.



Jangan aktifkan berdekatan dengan stesen minyak, depo bahan bakar, loji kimia atau operasi peletupan.



Elakkan penggunaan di hospital: alat perubatan elektronik, misalnya perentak jantung dan alat bantuan pendengaran boleh terjejas.



Sedikit gangguan mungkin menjejaskan TV, radio, PC, dan lain-lain.



Jangan pegang telefon di dalam tangan semasa memandu.



Jangan buka telefon atau bateri.

## Sila ambil perhatian:



Gunakan hanya bateri dan pengecas yang ditentukan kerana bateri dan pengecas lain boleh merosakkan telefon.



Bateri yang tidak boleh digunakan harus dibuang menurut undang-undang yang berkenaan.



Gunakan hanya aksesori ASLI bagi mengelakkan kerosakan pada telefon anda.

### Maklumat Penting

Panduan pengguna ini mengandungi maklumat penting mengenai penggunaan dan operasi telefon ini. Sila baca semua maklumat dengan teliti untuk prestasi optimum dan untuk mengelakkan sebarang kerosakan atau penyalahgunaan telefon ini. Sebarang perubahan atau pengubahsuaian yang tidak diluluskan secara nyata di dalam panduan pengguna ini boleh mentaksahkan waranti anda untuk alat ini.

## Gambaran Keseluruhan

<b>Aksesori</b> .....	<b>10</b>
<b>Bahagian Telefon</b> .....	<b>11</b>
• Bahagian Depan Telefon .....	11
• Bahagian Belakang Telefon .....	12
<b>Penerangan Kekunci</b> .....	<b>13</b>
• Bahagian Tepi Telefon .....	14
• Kekunci Abjad Angka .....	14

## Maklumat Paparan

<b>Maklumat Paparan</b> .....	<b>15</b>
• Ikon-Ikon Pada Skrin .....	15

## Bermula

<b>Pemasangan</b> .....	<b>17</b>
• Memasang Kad SIM .....	17
• Memasang Bateri .....	18
• Mengecas Bateri .....	18
• Memutuskan Sambungan Pengecas .....	19
<b>Urutan Menghidupkan Telefon</b> .....	<b>20</b>
<b>Kod Akses</b> .....	<b>21</b>
• PIN1 code (4 to 8 digits) .....	21
• PIN2 code (4 to 8 digits) .....	21
• PUK1 code (4 to 8 digits) .....	21
• PUK2 code (4 to 8 digits) .....	21
• Security code (4 to 8 digits) .....	21
<b>Tulis dan Baca Mesej</b> .....	<b>22</b>
• Write Message (Tulis Mesej) .....	22
• Read Message (Baca Mesej) .....	22
<b>Teks eZi</b> .....	<b>23</b>
• Bagaimana Menggunakan Teks eZi .....	23

## Fungsi-Fungsi Panggilan

<b>Membuat dan Menjawab Panggilan</b> .....	<b>26</b>
• Membuat Panggilan .....	26
• Menjawab Panggilan .....	27
<b>Nombor-Nombor Terbaru</b> .....	<b>28</b>
• Dialed Number(Nombor yang telah Didail) .....	28
• Received Number(Nombor yang Diterima).....	28
• Missed Number(Nombor yang Tidak Dijawab) .....	28

## Mengakses Menu

<b>Buku Telefon</b> .....	<b>29</b>
• Search (Cari) [Names 1] .....	29
• Search E-Mail (Cari E-Mel ) [Names 2] .....	30
• Add Entry (Tambah Entri) [Names 3] .....	30
• Add E-Mail (Tambah E-Mel) [Names 4] .....	31
• Groups (Kumpulan) [Names 5] .....	31
• Speed Dials (Dail Cepat) [Names 6] .....	33
• Delete all (Padam semua) [Names 7] .....	33
• Memory (Memori) [Names 8] .....	33
• Copy (Salin) [Names 9].....	33
• Service Dial Number (Nombor Dail Khidmat) [Names 10] (Bergantung kepada SIM).....	34
• Own Number (Nombor Sendiri) [Names 11] .....	34
<b>Struktur MMI</b> .....	<b>35</b>
<b>Menggunakan Menu</b> .....	<b>38</b>
<b>Pemanduan Arah Menu Dengan Menatal</b> .....	<b>38</b>
<b>Jalan Pintas ke dalam Menu</b> .....	<b>38</b>
<b>Messages (Mesej) [Menu 1]</b> .....	<b>39</b>
• Write Message (Tulis Mesej) [Menu 1-1].....	39
• Outbox (Peti keluar) [Menu 1-2] .....	40
• Inbox (Peti masuk) [Menu 1-3] .....	41
• Status Report (Laporan Status) [Menu 1-4] .....	42

• Call Voicemail (Mel Suara Panggilan) [Menu 1-5] .....	42
• Cell Broadcast (Siaran Sel) [Menu 1-6] .....	42
• Memory Status (Status Memori) [Menu 1-7] .....	44
• Setting (Tetapan) [Menu 1-8] .....	44
<b>Call Option (Pilihan Panggilan) [Menu 2] .....</b>	<b>45</b>
• Call Divert (Alihan Panggilan) [Menu 2-1].....	45
• Call Barring (Sekatan Panggilan) [Menu 2-2] .....	46
• Call Waiting (Panggilan Menunggu) [Menu 2-3] .....	47
• Sending Number (Nombor yang Menghantar) [Menu 2-4] .....	47
• Closed User Group (Kumpulan Pengguna Terhad) [Menu 2-5] ..	47
<b>Call Charge (Caj Panggilan) [Menu 3] (Bergantung kepada SIM) .....</b>	<b>48</b>
• Call Duration (Tempoh Panggilan) [Menu 3-1] .....	48
• Call Costs (Kos Panggilan) [Menu 3-2] .....	48
• Cost Settings (Tetapan Kos) [Menu 3-3] .....	49
<b>Security (Keselamatan) [Menu 4] .....</b>	<b>50</b>
• PIN Enable (Upaya PIN) [Menu 4-1] .....	50
• Change Codes (Tukar Kod) [Menu 4-2].....	50
• Fixed Dial Number (Nombor Dail Tetap) [Menu 4-3] .....	51
<b>Setting (Tetapan) [Menu 5] .....</b>	<b>52</b>
• Network Selection (Pemilihan Rangkaian) [Menu 5-1] .....	52
• Phone Setting (Tetapan Telefon) [Menu 5-2] .....	52
• Call Setting (Tetapan Panggilan) [Menu 5-3] .....	53
• Time Setting (Tetapan Masa) [Menu 5-4] .....	54
• Profiles (Profil) [Menu 5-5] .....	55
<b>Accessories (Aksesori) [Menu 6] .....</b>	<b>56</b>
• Scheduler (Penjadual) [Menu 6-1] .....	56
• World Time (Masa Sedunia) [Menu 6-2] .....	57
• Calculator (Kalkulator) [Menu 6-3].....	57
• Unit Convert (Tukar Unit) [Menu 6-4].....	58
• Game (Permainan) [Menu 6-5] .....	58
• PC Sync .....	58

<b>Voice Dial (Dail Suara) [Menu 7]</b> .....	<b>59</b>
• Training (Latihan) [Menu 7-1] .....	59
• Search (Cari) [Menu 7-2] .....	59
• Setting (Tetapan) [Menu 7-3].....	60
• Delete all (Padam semua) [Menu 7-4] .....	60
<b>Internet [Menu 8]</b> .....	<b>61</b>
• Home (Lelaman) [Menu 8-1] .....	61
• Bookmarks (Penanda Buku) [Menu 8-2] .....	61
• Profiles (Profil) [Menu 8-3] .....	62
• Empty Cache (Kosongkan Cache) [Menu 8-4] .....	62
<b>Di Dalam Menu Internet</b> .....	<b>63</b>

### Fungsi-Fungsi Tambahan

<b>Bagaimana Menghantar nada DTMF</b> .....	<b>64</b>
• Aksara Tunggu .....	64
• Menyoal selidik Mesin Jawab anda (contoh) .....	64
• Semasa Panggilan .....	64
<b>Pilihan Dalam Panggilan</b> .....	<b>65</b>
<b>Bagaimana Menggunakan Panggilan Data dan Faks.</b> .....	<b>68</b>
• Membuat Panggilan Data atau Faks .....	68
• Membuat Panggilan Suara & Faks(making a voice&fax call) .....	68
<b>Memo Suara</b> .....	<b>70</b>
• Memo Suara .....	70
• Menu Memo Suara .....	70
<b>Penjagaan dan Penyelenggaraan</b> .....	<b>71</b>
<b>Data Teknikal</b> .....	<b>72</b>
• Umum .....	72
• Dimensi .....	72
• Suhu Ambien .....	72

Periksa bagi memastikan bahawa anda mempunyai semua bahagian yang ditunjukkan di bawah.



Telefon



Klip Tali Pinggang



Tali leher

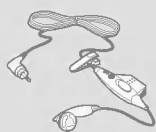

Bebas Tangan Mudah Alih



Kad Waranti



Panduan Pengguna



Penyesuai Kembara



Bateri Biasa

### <Aksesori Pilihan>

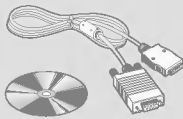

Kit Data/CD (DK-10G)

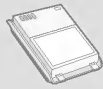

Bateri Tahan Lama (BEL-11G)



Pengecap Atas Meja (DC-11G)

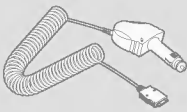

Penyesuai Pemetik Api Cerut (CLA-10G)

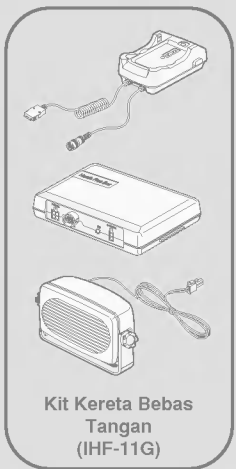

Kit Kereta Bebas Tangan (IHF-11G)

## Bahagian Depan Telefon

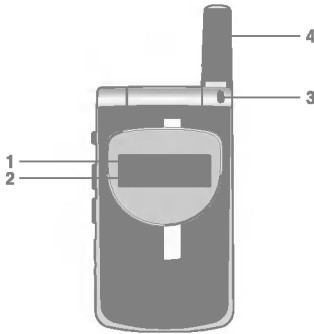

- 1 Skrin LCD Depan
- 2 Ikon Keras
- 3 Lampu Penunjuk Panggilan
- 4 Antena

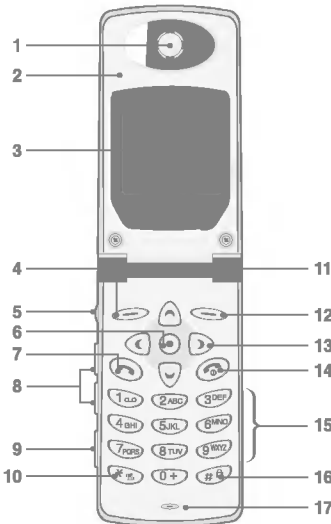

- 1 Cuping Telinga
- 2 Pelipat Aktif
- 3 Skrin Paparan
- 4 Kekunci Kiri Lembut
- 5 Kekunci Rakam
- 6 Kekunci Pengesahan
- 7 Kekunci Hantar
- 8 Kekunci Tepi Atas/Bawah
- 9 Mikrofon Telinga
- 10 Kekunci Bintang
- 11 Lampu Penunjuk Panggilan
- 12 Kekunci Kanan Lembut
- 13 Kekunci-Kekunci Pandu Arah
- 14 Kekunci TAMAT/KUASA
- 15 Kekunci-Kekunci Angka
- 16 Kekunci Dwipangkah
- 17 Mikrofon

## Bahagian Belakang Telefon

---

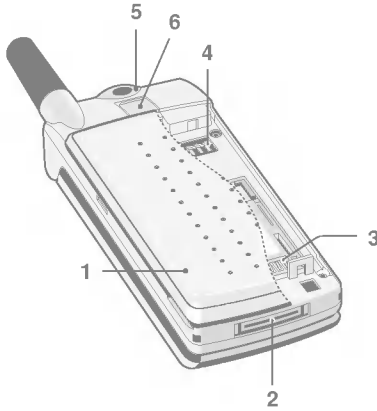

**1 Penutup Bateri**

**2 Penyambung Kabel  
/Pengecasan Bateri  
Penyambung / Kit Kereta  
Bebas Tangan  
Penyambung**

**3 Soket kad SIM**





**4 Terminal-Terminal Bateri**

**5 Lubang Tali Bimbit**

**6 Kunci Bateri**



Berikut ditunjukkan komponen-komponen kekunci telefon.

## Penerangan Pad Kekunci

Kekunci	
	<p><b>Kekunci Kiri Lembut / Kekunci Kanan Lembut</b> Setiap daripada kekunci-kekunci ini melaksanakan fungsi yang ditunjukkan oleh teks pada paparan di atas kekunci tersebut.</p>
  <b>Easy Key</b>	<p><b>Kekunci Panas WAP</b> Anda boleh menyambung langsung kepada WAP dengan menekan kekunci ini.</p> <p><b>Kekunci-Kekunci Pandu Arah</b> Anda boleh menggunakan kekunci-kekunci ini untuk menatal nama, nombor telefon, menu atau pilihan tetapan. Dalam mod tunggu sedia, jika anda menekan kekunci-kekunci pandu arah atas/bawah, anda boleh melihat “Nombor yang Telah Didail” “Nombor yang Diterima” dan “Nombor yang Tidak Dijawab”.</p>
	<p><b>Kekunci Hantar</b> Anda boleh mendail nombor telefon dan menjawab panggilan. Jika anda menekan kekunci ini tanpa memasukkan nombor, telefon anda akan menunjukkan nombor yang paling terbaru didail.</p>
  	<p><b>Kekunci-Kekunci Angka</b> Kekunci-kekunci ini selalunya digunakan untuk mendail dalam mod tunggu sedia dan memasukkan nombor atau aksara dalam mod mengedit. Apabila anda menekan kekunci-kekunci ini untuk masa yang lama.</p> <ul style="list-style-type: none"><li>• Digunakan untuk memanggil peti mel suara anda dengan </li><li>• Digunakan untuk membuat panggilan antarabangsa dengan </li><li>• Digunakan untuk memanggil dail cepat dengan </li></ul>
	<p><b>Kekunci Bintang</b> Digunakan untuk memasuki mod getaran dengan menekan kekunci ini untuk masa yang lama. Berikut menunjukkan komponen-komponen utama telefon.</p>
	<p><b>Kekunci Dwipangkah</b> Digunakan untuk mengunci kekunci dengan menekan kekunci ini untuk masa yang lama.</p>
	<p><b>Kekunci TAMAT/KUASA</b> Digunakan untuk menamatkan atau menolak panggilan. Kekunci ini juga digunakan sebagai Kekunci Kuasa. Anda boleh menghidupkan dan mematikan telefon dengan menekan kekunci ini untuk masa yang lama.</p>

## Bahagian Tepi Telefon

### Penerangan Pad Kekunci







Kekunci	
	<b>Kekunci Rakam</b> Anda boleh menggunakan memo suara dengan menekan kekunci ini untuk masa yang lama. <b>Kekunci Tolak</b> Anda boleh menolak panggilan masuk dengan menekan kekunci ini selama beberapa saat tanpa membuka pelipat.
	<b>Kekunci Tepi Atas/Bawah</b> Anda boleh mengawal kelantangan nada kekunci dalam mod tunggu sedia dengan pelipat terbuka dan juga kelantangan mendengar semasa panggilan.

### Kekunci Abjad Angka

Hubungan pemetaan pad kekunci abjad dan angka disenaraikan seperti jadual berikut.

Kekunci	
	. ! ' , - ? @ 1 _
	A B C 2 Ä Å Æ Ç a b c ä å æ ç
	D E F 3 Ę Ě Ê e f è é ê
	G H I 4 Ĩ Ī Ĵ ħ i ĵ ĩ ħ ĩ
	J K L 5 j k l
	M N O 6 Ñ Ö Ó Ô Õ OE m n o ñ ö ó ô õ œ
	P Q R S 7 B Š š p q r s š
	T U V 8 Ü Û Ú ú t u v ü ú ú
	W X Y Z 9 w x y z
	[Kekunci Ruang] 0 Ø ø

#### ● Notis

- Dalam hal mod simbol, selepas memasukkan aksara, mod ditukar secara automatik kepada mod Huruf besar. Dan jika anda mahu memasukkan aksara simbol lain, cari ia untuk menggunakan kekunci-kekunci pandu arah, kekunci  dan , tekan kekunci  atau kekunci  untuk menyimpan. Anda juga boleh menggunakan halaman simbol seterusnya dengan , .





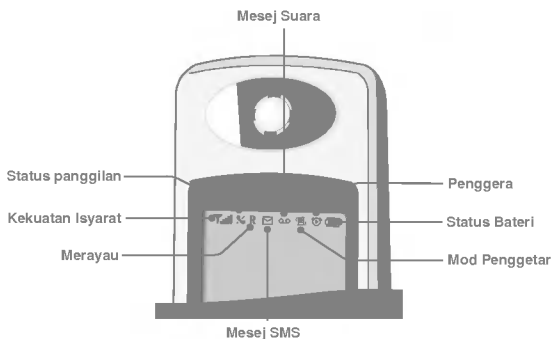



Skrin memaparkan beberapa ikon dan berikut diterangkan setiap satu ikon yang anda mungkin lihat pada telefon.

## Ikon-Ikon Pada Skrin







Ikon/Penunjuk	
	Memberitahu anda kekuatan isyarat rangkaian.
	Anda berada di dalam kawasan tiada khidmat. / Panggilan disambungkan.
	Menunjukkan bahawa anda sedang menggunakan khidmat rayau.
	Anda telah menerima satu mesej teks baru.
	Anda telah menerima satu mesej suara, bergantung kepada langganannya anda.
	Semua isyarat yang boleh didengar dimatikan.
	Semua nada dimatikan.
	Penggera telah ditetapkan dan sedang aktif.
	Memberitahu anda status bateri.

## Ikon-Ikon Menu Atas

Ikon	
	Messages (Mesej)
	Call Option (Pilihan Panggilan)
	Call Charge (Caj Panggilan)
	Security (Keselamatan)
	Setting (Tetapan)
	Accessories (Aksesori)
	Voice Dial (Dail Suara)
	Internet

## Ikon-Ikon Hasil.

Ikon	
	<b>Mesej Selesai</b> Dipaparkan apabila pemanduan arah menu diselesaikan.
	<b>Mesej Maklumat</b>
	<b>Mesej Simpan</b>
	<b>Mesej Amaran</b> Dipaparkan dengan mesej ralat atau amaran.

## Memasang Kad SIM

Cari soket kad SIM di belakang telefon. Ikut langkah-langkah di bawah untuk memasang kad SIM.



1. Buka kunci penutup bateri ❶ dan tanggalkan ia ❷.



2. Terbalikkan pemegang SIM ❸.



3. Gelongsorkan kad SIM ke dalam pemegang ❹.
  - Pastikan sudut serong diletakkan dengan betul dan sentuhan dibuat.

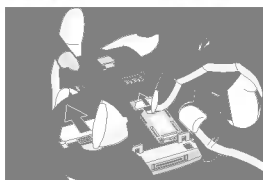

4. Tutup pemegang kad SIM, dan gerakkan tuil kunci pemegang ke atas.

### Notis

- Sebelum memasang kad SIM, pastikan bahawa telefon dimatikan dan bateri ditanggalkan.
- Sentuhan logam kad SIM mudah rosak disebabkan tercalar. Beri perhatian khusus pada kad SIM apabila anda memegang dan memasang. Ikut arahan yang dibekalkan dengan kad SIM.

## Memasang Bateri

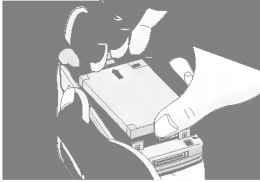

1. Letakkan bahagian atas bateri pada telefon. (Lihat gambar di kiri untuk tujuan ilustrasi.)

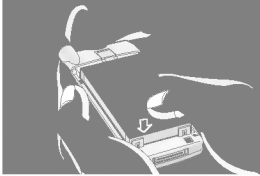

2. Tolak bateri ke dalam sehingga anda mendengar bunyi "KLIK".



3. Tutup penutup bateri.

## Mengecas Bateri

Untuk menyambungkan penyesuai kembra kepada telefon anda mestilah memasang bateri.



1. Masukkan satu hujung penyesuai kembra ke dalam bahagian bawah telefon.

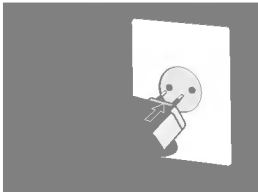

2. Sambungkan penyesuai kepada soket dinding AC. Gunakan hanya pengecas yang disertakan di dalam bungkusan.



Masa-masa penggunaan boleh berbeza-beza bergantung kepada khidmat rangkaian.

Jenis Bateri	Masa Mengecas	Masa Penggunaan	
		Tunggu	Sedia Bual
Biasa	2.5 jam	100~150 jam	2 jam 30 min
Tahan Lama	3 jam	250 jam	4 jam

### Note

- Apabila masa operasi (masa bual dan masa tunggu-sedia). Contohnya apabila set lambu latar kemungkinan mengakibatkan masa penggunaan bateri lebih pendek daripada biasa.

## Memutuskan Sambungan Pengecas

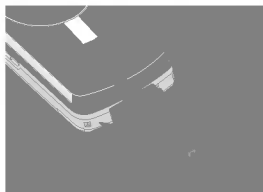

Putuskan sambungan penyesuai kembara dari telefon dengan menekan butang-butang tepinya.

### Notis

- Ingat untuk mengecas bateri baru sepenuhnya selepas menukarnya.
- Jangan tanggalkan bateri atau kad SIM anda semasa pengecasan.
- "Battery Charging" ("Mengecas Bateri") dipaparkan pada skrin selepas menyambungkan penyesuai kembara. Hanya jika bateri benar-benar kosong, Lampu Penunjuk Panggilan akan bernyala tanpa memaparkan "Battery Charging".
- Palang-palang bergerak ikon bateri akan berhenti selepas pengecasan penuh.

### Perhatian

- Sekiranya bateri tidak dicas sepenuhnya...
  1. Selepas menekan kekunci Menghidupkan/Mematikan, cubalah mengecas ia semula.
  2. Sekiranya bateri terpasang, harap tanggalkan ia dari telefon. Kemudian letakkan ia semula untuk mengecas ia sekali lagi.

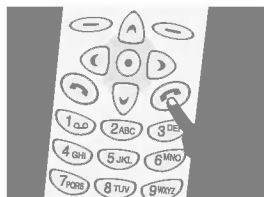

Untuk mula menggunakan telefon anda, ikut langkah-langkahnya.

1. Tekan dan tahan butang  sehingga anda mendengar satu nada dari telefon anda bagi menghidupkan.
2. Jika permintaan kod PIN kad SIM anda diupayakan, telefon anda akan meminta anda memasukkan kod PIN. Masukkan kod PIN, kemudian telefon anda akan menyambung kepada rangkaian GSM dan nama rangkaian akan muncul pada paparan sejourus kemudian.
3. Dan kemudian telefon anda akan berada dalam mod tunggu sedia. Jika kod PIN dilumpuhkan, telefon anda menyambung kepada rangkaian tanpa meminta kod PIN dimasukkan.

Anda boleh menggunakan kod-kod akses yang diterangkan di dalam bahagian ini untuk mengelakkan penggunaan telefon anda tanpa izin. Kod-kod PIN1 / PIN2 dan Kod keselamatan boleh ditukar dengan menggunakan [Menu 4-2]. Lihat bahagian yang berikut.

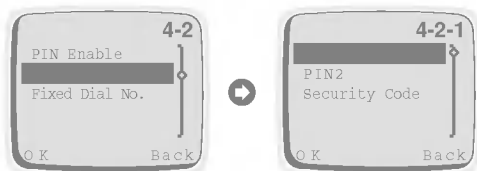

### **PIN1 code (4 to 8 digits)**

---

Kod PIN (Nombor Pengenalan Peribadi) melindungi kad SIM anda daripada digunakan tanpa izin. Kod PIN biasanya dibekalkan dengan kad SIM. Apabila permintaan kod PIN diupayakan [Menu 4-1-1], kod diminta setiap kali anda cuba menukar kod PIN atau mengupaya/melumpuhkan permintaan kod PIN, atau telefon anda dihidupkan. Jika anda menukar kod PIN, buat catatan kod tersebut tetapi simpan ia berasingan dengan telefon.

### **PIN2 code (4 to 8 digits)**

---

Kod PIN2, dibekalkan dengan sesetengah kad SIM, diperlukan bagi mengakses beberapa fungsi seperti Pemberitahuan caj panggilan, Nombor dail tetap. Fungsi-fungsi ini hanya terdapat jika disokong oleh kad SIM anda.

### **PUK1 code (4 to 8 digits)**

---

Kod PUK (Kunci Nyah-Halang Peribadi) diperlukan bagi menukar kod PIN yang terhalang. Kod PUK boleh dibekalkan dengan kad SIM. Jika tidak, hubungi pembekal khidmat setempat anda untuk kod tersebut. Jika anda kehilangan kod, hubungi juga pembekal khidmat anda.

### **PUK2 code (4 to 8 digits)**

---

Kod PUK2, dibekalkan dengan sesetengah kad SIM, diperlukan bagi menukar kod PIN2 yang terhalang. Jika anda kehilangan kod, hubungi juga pembekal khidmat anda.

### **Security code (4 to 8 digits)**

---



Kod keselamatan melindungi telefon anda daripada digunakan tanpa izin. Ia biasanya dibekalkan dengan telefon. Kod ini diperlukan bagi menghapus semua entri buku telefon.

## Write Message (Tulis Mesej)

---

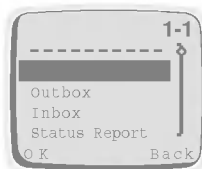
Jika anda mahu menulis mesej ringkas, anda harus menurut prosedur seterusnya.











1. Tekan  [Menu].
2. Pilih Messages di dalam menu utama dengan menekan  [OK]. Dan kemudian jika anda mahu menulis mesej baru, pilih **Write Message** di dalam menu ini. Jika anda mahu mengubah suai mesej yang sebelumnya, pilih **Outbox** (Peti keluar) di dalam menu, kemudian anda boleh mengedit mesej dengan menggunakan editor teks eZi atau editor biasa. Jika anda mahu menulis mesej balasan, pilih **Inbox** (Peti masuk) di dalam menu ini.



## Read Message (Baca Mesej)

---

Jika anda mahu membaca mesej ringkas yang diterima yang telah disimpan sebelumnya, anda harus menurut langkah-langkah seterusnya ini.

1. Tekan  [Menu].
2. Kemudian anda boleh melihat menu atas. Dan pilih **Messages** dengan menekan  [OK].
3. Apabila menu **Messages** dipaparkan, tatal ke **Inbox** dengan menggunakan  dan  dan tekan  [OK].
4. Setelah anda memasuki menu ini, anda boleh melihat mesej-mesej yang terakhir diterima. Tatal ke mesej yang diinginkan dengan menggunakan  dan . Dan jika anda mahu keluar dari menu Peti masuk, tekan  [Back]. Semasa membaca mesej, tekan  [Opt] bagi mengakses pilihan-pilihan yang terdapat. Anda boleh melihat penerangan **Option** di dalam [Menu 1-3].

Jika anda mahu membaca mesej ringkas yang baru saja diterima, anda harus menurut langkah-langkah seterusnya ini.

1. Apabila anda menerima mesej ringkas,  akan dipaparkan pada skrin.
2. Tekan  [OK], kemudian anda boleh membaca mesej yang baru saja diterima.

## Bagaimana Menggunakan Teks eZi



Teks eZi membolehkan pengguna menaip dengan mudah dan cepat. Dengan menekan sahaja setiap kekunci sekali untuk setiap aksara, anda boleh mendapatkan perkataan-perkataan yang anda mahu. Selain itu, calon perkataan diramal dengan calon-calon lain yang sesuai dengan huruf-huruf yang ditaip sejauh itu. Jadi, anda tidak perlu memasukkan seluruh aksara-aksara untuk membuat perkataan.

### ■ Bagaimana menukar mod

Telefon ini menyokong tiga jenis mod edit: **Mod eZi**, **mMod angka** dan **Mod huruf**. Untuk menukar mod tekan saja kekunci , kemudian anda boleh memilih satu antara tiga mod tersebut.

### ■ Bagaimana menggunakan mod eZi.









Untuk memasukkan teks dalam mod eZi, tekan saja setiap kekunci sekali untuk setiap huruf. Selepas memasukkan aksara, anda boleh melihat bahawa calon perkataan muncul di dalam kotak teks, yang mempunyai keutamaan tinggi. Anda juga boleh memilih calon-calon lain menggunakan  dan .

### Contohnya, jika anda mahu memasukkan “Meet at church after lunch”.



Untuk menaip “Meet”, pengguna menaip huruf-huruf pada kekunci yang memerlukan hanya satu tekanan kekunci untuk setiap huruf. Calon “Meet” diramalkan bersama calon-calon lain yang sesuai dengan huruf-huruf yang ditaip sejauh itu. Pengguna menggunakan “Meet” yang telah dipilih.

Pengguna terus memasukkan aksara-ksara dengan cara yang serupa bagi baki mesej. Setiap calon hanya memerlukan beberapa tekanan kekunci bagi mencari perkataan sasaran. Sekarang mari kita tunjukkan kuasa ramalannya. Perkataan “lunch” adalah 5 aksara panjangnya. Input teks hanya memerlukan 4 tekanan kekunci sebelum perkataan itu diramalkan.

Jika pada bila-bila masa pengguna mahu memasukkan beberapa tanda baca, mereka tekan hanya kekunci  bagi memasukkan tanda baca.

Sebagai contoh, jika anda mahu memasukkan “you”, tekan kekunci  sekali. Anda boleh melihat “we”. Seterusnya, tekan kekunci , kemudian anda boleh melihat “you” di dalam kotak teks. Jika perkataan tidak ditunjukkan, tekan kekunci , atau cari perkataan dengan  dan . Selepas memasukkan aksara-aksara, pilih calon yang anda mahu dengan kekunci .

## ● Perhatian

- Anda boleh menukar bahasa dengan . Dan anda juga boleh menukar bentuk huruf besar dengan  dan . Sebagai contoh : you You →YOU →Y.O.U →y.o.u.

## ■ Bagaimana menggunakan dalam mod angka



Anda boleh menggunakan mod ini untuk memasukkan nombor, tukar kepada mod lain dengan kekunci .

1. Tukar mod input kepada Angka.
2. Tekan kekunci yang ingin anda masukkan.

## ■ Bagaimana menggunakan mod Huruf

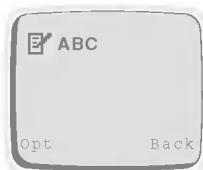

**Mod huruf besar**



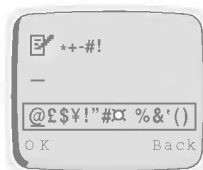

**Mod huruf kecil**



**Mod simbol**

Terdapat tiga sub mod di dalam mod Huruf: **Mod huruf besar**, **Mod huruf kecil**, dan **Mod simbol**.

Kekunci	
	menukar kepada mod lain contohnya mod eZi → mod Angka.
	menukar mod Huruf besar kepada Huruf kecil atau mod Huruf kecil kepada mod Huruf besar.
	memindahkan ke halaman Simbol yang seterusnya dalam mod Simbol.





## ● Notis

- Dalam hal mod Simbol, selepas memasukkan aksara, mod ditukar secara automatik kepada mod huruf besar CAP.



### ■ Bagaimana menggunakan kamus pengguna

Anda boleh menggunakan kamus pengguna semasa menulis SMS. eZi Text mempunyai kamus pengguna. Anda boleh menambahkan beberapa perkataan kepada kamus pengguna dan kemudian perkataan itu mempunyai keutamaan tinggi.

### ■ Bagaimana menambahkan perkataan kepada kamus pengguna

1. Di dalam skrin mod teks eZi tekan kekunci  [Opt].
2. Tatal ke menu **Dictionary**, tekan kekunci  [OK].
3. Tekan kekunci  [Opt] selepas memasukkan perkataan yang anda mahu.
4. Tatal ke menu **Add to UPD**, tekan kekunci  [OK].
5. Jika mesej **Done** dipaparkan pada telefon, ia telah berjaya ditambahkan kepada kamus pengguna.
6. Dan anda boleh memeriksa bagi memastikan perkataan tersebut telah ditambahkan pada menu **List Dictionary**.

### ■ Bagaimana memadam perkataan dari kamus pengguna

1. Tatal ke menu **List Dictionary**.
2. Tekan kekunci  [OK] selepas memilih perkataan yang ingin anda padam.
3. Di skrin seterusnya, tekan kekunci  [Opt].
4. Tekan kekunci  [OK] selepas memilih **Del from UPD**.
5. Jika mesej **Done** dipaparkan pada telefon, ia telah berjaya dipadam dari kamus pengguna.

## Membuat Panggilan

1. Masukkan nombor telefon termasuk kod kawasan.  
Untuk mengedit nombor di paparan, tekan ◀ untuk menggerakkan kursor ke kiri, dan tekan ▶ untuk menggerakkan kursor ke kanan.
2. Tekan ⏪ untuk memanggil nombor.
3. Tekan ⏩ untuk menamatkan panggilan (atau untuk membatalkan percubaan memanggil).



### ■ Dail Suara

1. Jika anda memilih **Enable** dalam Tetapan [7-3], anda boleh memanggil dengan hanya menggunakan suara.
2. Apabila anda membuka penutup telefon, telefon anda memaparkan "Guide Message" dan anda akan mendengar "Please say name".
3. Kemudian anda harus menyebut nama yang telah diprogram yang ingin anda panggil dalam masa 5 saat.
4. Telefon anda akan mendail nombor yang dikaitkan dengan nama yang telah diprogram itu.

### ● Perhatian

- Anda harus mengaitkan suara anda kepada no. yang diingini untuk menggunakan fungsi ini. Rujuk kepada Menu 7 (Menu Dail Suara) untuk maklumat lanjut.



### ■ Panggilan Antarabangsa

1. Tekan dan tahan kekunci Ⓡ+ untuk awalan antarabangsa. (aksara + menggantikan kod akses antarabangsa.)
2. Masukkan kod negara, kod kawasan dan nombor telefon.
3. Untuk memanggil nombor, tekan ⏪ .

### ■ Membuat Panggilan menggunakan Buku Telefon



1. Dalam mod tunggu sedia, pilih **Names** dengan menekan kekunci Ⓛ [Names].
2. Apabila menu buku telefon dipaparkan, anda boleh memilih **Search** (Cari) dengan menekan Ⓛ [OK].
3. Masukkan huruf pertama nama dan tekan Ⓛ [Search].
4. Gunakan kekunci ▲ dan ▼, untuk sampai ke nama yang diingini.
5. Tekan ⏪ untuk mendail.

## ■ Dail Semula Nombor Terakhir

1. Tekan  dan anda akan melihat nombor terakhir yang didail.
2. Kemudian tekan  sekali lagi jika anda mahu mendail nombor sekali lagi.
3. Jika anda mahu mendail nombor terbaru dengan satu tekanan kekunci, tekan dan tahan .

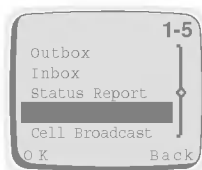
## ■ Memanggil Khidmat Mel Suara anda







1. Tekan  sehingga telefon anda pergi ke mod memanggil. Atau anda boleh memanggil menggunakan [Menu 1-5]. Jika anda mahu menggunakan menu, lihat [Menu 1-5].(Khidmat Mel Suara mestilah disediakan bersama dengan operator rangkaian anda.)
2. Jika telefon meminta nombor mel suara, masukkan ia dan tekan  [OK]. Anda boleh mendapatkan nombor ini daripada pembekal khidmat anda. Anda juga boleh mengedit nombor ini pada lain kali.

## ■ Membuat Panggilan Melalui Dail Cepat

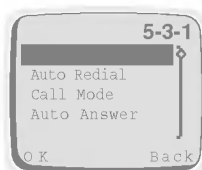
Lihat Bahagian **Buku Telefon - Dail Cepat**.



## Menjawab Panggilan



1. Cara menjawab panggilan masuk bergantung kepada tetapan bagi [Menu 5-3-1].
2. Jika anda memilih **On** dalam Any Key Answer (Jawab Menggunakan Sebarang Kekunci) [Menu 5-3-1], anda boleh menjawab panggilan masuk dengan menekan sebarang kekunci kecuali . Jika anda memilih **Off**, anda boleh melakukannya dengan membuka pelipat. Jika pelipat sudahpun dibuka, anda boleh juga menjawab panggilan dengan menekan .
3. Tekan  atau tutup pelipat untuk menamatkan panggilan.

## ■ Menjawab panggilan semasa menggunakan Mikrofon Telinga (Mudah Alih Bebas Tangan):

Tekan butang pada mikrofon telinga selama beberapa saat untuk menerima panggilan masuk semasa mikrofon telinga disambungkan kepada telefon.

Dalam mod tunggu sedia, Apabila anda menekan  atau , butiran-butiran menu di bawah ini akan dipaparkan. Nombor yang telah Didail, Nombor yang Diterima dan Nombor yang Tidak Dijawab boleh disimpan di dalam Buku Telefon.



### **Dialed Number(Nombor yang telah Didail)**

---

Menunjukkan nombor-nombor telefon yang terbaru didail yang tidak dijawab. Selepas mengesan nombor telefon, anda boleh membuat panggilan atau memadam nombor telefon.

### **Received Number(Nombor yang Diterima)**

---

Menunjukkan nombor-nombor telefon yang terbaru diterima sehingga 10. Selepas mengesan nombor telefon anda boleh membuat panggilan (jika rangkaian menyediakan khidmat ini) atau memadam nombor telefon itu.

### **Missed Number(Nombor yang Tidak Dijawab)**

---

Menunjukkan nombor-nombor telefon panggilan masuk terbaru yang tidak dijawab sehingga 10. Nombor-nombor yang dipanggil tetapi tidak dijawab. Selepas mengesan nombor telefon, anda boleh membuat panggilan atau memadam nombor telefon itu.



Buku telefon mempunyai beberapa menu yang boleh anda pilih. Tekan [Names] dalam mod tunggu sedia dan kemudian tatal ke butiran yang diingini.

1	<b>Search</b>	Membolehkan anda mencari nama tertentu.
2	<b>Search E-Mail</b>	Membolehkan anda mencari alamat E-mel melalui nama.
3	<b>Add Entry</b>	Membolehkan anda menambahkan nama-nama dan nombor-nombor baru.
4	<b>Add E-Mail</b>	Membolehkan anda menambahkan nama-nama dan alamat E-mel baru.
5	<b>Groups</b>	Membolehkan anda menunjukkan senarai kumpulan.
6	<b>Speed Dials</b>	Membolehkan anda memberi sehingga 8(2-9) peruntukan dail satu sentuhan.
7	<b>Delete all</b>	Membolehkan anda memadam semua data di dalam sama ada buku telefon atau kad SIM anda dengan memilih memori.
8	<b>Memory</b>	Membolehkan anda memilih memori Telefon/Kad SIM yang lebih digemari atau melihat status memori.
9	<b>Copy</b>	Membolehkan anda menyalin entri-entri dari memori Telefon ke kad Sim atau dari kad SIM ke memori Telefon.
10	<b>SDN</b>	Membolehkan anda menunjukkan entri-entri Nombor Dail Khidmat.
11	<b>Own Number</b>	Membolehkan anda memasukkan dan menunjukkan nombor-nombor anda sendiri

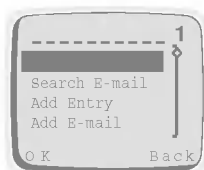

## Search (Cari) [Names 1]

(Memanggil dari buku telefon)







1. Buka buku telefon dahulu dengan menekan [Names] dalam mod tunggu sedia.
2. Pilih **Search** dengan menekan kekunci [OK].
3. Tulis huruf pertama atau semua aksara bagi nama yang diperlukan dan tekan [Search] dan kemudian nama(-nama) akan dipaparkan di paparan.
4. Tatal untuk menyerlahkan nama yang diperlukan.
5. Tekan [OK] untuk memaparkan nama dan nombor telefon.
6. Jika anda mahu, tekan .

## ● Perhatian

- Di dalam menu ini, anda boleh mengedit atau memadam nombor yang anda pilih. Jika anda tidak memasukkan nama dan menekan  [Search], semua entri akan dipaparkan. Jika anda mahu mencari nama "David", anda boleh memasukkan "D" menggunakan kekunci angka dan anda akan melihat nama-nama yang bermula dengan "D", dan anda pilih "David" dengan menatal ke atas/ke bawah ke nama "David" yang diperlukan. Nama dan nombor yang dipaparkan pada tettingkap boleh anda edit atau padam dengan menekan  [Opt].

## Search E-Mail (Cari E-Mel) [Names 2]

---

1. Buka buku telefon dahulu dengan menekan  [Names] dalam mod tunggu sedia.
2. Tatal untuk menyerlahkan **Search E-Mail**, dan tekan  [OK] untuk memasuki.
3. Tulis huruf pertama atau semua aksara bagi nama dan tekan  [Search], kemudian nama(-nama) akan dipaparkan pada tettingkap.
4. Tatal untuk menyerlahkan nama yang diinginkan.
5. Tekan  [OK] untuk memaparkan alamat E-mel.





## ● Perhatian

- Nama dan alamat E-mel yang dipaparkan pada tettingkap boleh anda edit atau padam dengan menekan  [Opt].

## Add Entry (Tambah Entri) [Names 3]

---

Anda boleh menambahkan nama dan nombor telefon dengan menggunakan fungsi ini. Selepas mengedit, anda boleh menyimpan sama ada ke kad SIM atau memori Telefon. Muatan memori telefon ialah 500 entri bagi nombor peribadi, dan muatan memori kad SIM bagi nombor peribadi bergantung kepada pembekal khidmat. Anda juga boleh menyimpan 20 aksara bagi nama di dalam memori Telefon dan memori kad SIM setiap satu. Bilangan aksara bergantung kepada ciri kad SIM.

1. Buka buku telefon dahulu dengan menekan  [Names] dalam mod tunggu sedia.
2. Tatal untuk menyerlahkan **Add Entry**, dan tekan  [OK] untuk memasuki.
3. Masukkan nama untuk ditambahkan.
4. Tekan  [OK], kemudian tettingkap untuk memasukkan nombor akan dipaparkan.
5. Edit nombor telefon.
6. Tekan  [OK], kemudian tettingkap pemilihan memori akan dipaparkan. Di dalam tettingkap ini, anda boleh menyimpan nombor telefon di dalam, sama ada kad SIM atau Telefon.





7. Jika terdapat memori, anda boleh menambahkan entri. Bagaimanapun, jika memori telah penuh, mesej ralat akan dipaparkan dan menu akan berpindah ke langkah yang sebelumnya.

### **Add E-Mail (Tambah E-Mel) [Names 4]**

---

Anda boleh menambah nama dan alamat E-mel dengan menggunakan fungsi ini. Selepas mengedit, anda boleh menyimpan alamat E-mel hanya ke memori telefon.

Anda boleh menyimpan sehingga 30 aksara bagi nama E-mel dan 50 aksara bagi alamat E-mel hanya di dalam memori telefon.

1. Buka buku telefon dahulu dengan menekan  [Names] dalam mod tunggu sedia.
2. Tatal untuk menyerlahkan **Add E-Mail**, dan tekan  [OK] untuk memasuki.
3. Masukkan nama menggunakan pad kekunci.
4. Tekan  [OK].
5. Jika terdapat memori Telefon, mesej untuk memasukkan alamat E-mel akan dipaparkan. Bagaimanapun, jika memori Telefon telah penuh, mesej ralat akan dipaparkan. Untuk menambahkan entri baru, anda perlu memadam senarai E-mel yang lama dahulu di dalam menu Search E-mail.
6. Edit alamat E-mel.
7. Tekan  [OK] untuk menyimpan.





### **Groups (Kumpulan) [Names 5]**

---

Dengan memilih fungsi ini, anda boleh mengurus senarai Kumpulan, seperti senarai Ahli, Tambah, Padam, Tukar Nama.

Jika anda menggunakan menu **Add**, anda boleh menyimpan sehingga 20 ahli di dalam setiap kumpulan.

Anda boleh menyimpan sehingga 10 kumpulan sahaja di dalam memori Telefon.



1. Buka buku telefon dahulu dengan menekan  [Names] dalam mod tunggu sedia.
2. Tatal ke butiran **Groups** kemudian tekan  [OK] untuk memasuki menu ini.
3. Setiap senarai Kumpulan akan dipaparkan.
4. Jika anda mahu Menambahkan Kumpulan (Add Group), pilih <Empty> dan tekan  [Add].
5. Pilih dan masukkan nama Kumpulan yang anda mahu.
6. Selepas menekan  [Opt] untuk sesuatu kumpulan yang dipilih, submenu-submenu di bawah akan dipaparkan.

## ● Notis

- Memilih butiran ini tidak bermakna bahawa anda boleh menambah entri baru di dalam Kumpulan-Kumpulan. Untuk menambah entri baru di dalam Kumpulan, anda perlu memilih senarai Ahli.





## ■ Member list (Senarai ahli):

Butiran menu ini mempunyai tiga submenu: Tambah Entri Baru, Tambah Entri yang Ada dan Padam Entri.

1. Pilih **Member list**, kemudian tekan  [OK] untuk memasuki.
2. Setelah itu senarai Kumpulan akan dipaparkan.
3. Pilih Member, dan tekan  [Opt] untuk memasuki.
4. Setelah itu **Add New Entry**, **Add Being Entry** dan **Delete Entry** akan dipaparkan.
  - **Add New Entry** : Anda boleh menambah entri baru di dalam Kumpulan atau buku telefon yang terpilih.
  - **Add Being Entry** : Anda boleh menambah entri yang sedia ada dengan mencari dari buku telefon.
  - **Delete Entry** : Anda boleh memadam entri terpilih di dalam sesuatu Kumpulan.

## ■ Delete (Padam):

Anda boleh memadam Kumpulan di dalam senarai Kumpulan.





1. Tatal untuk menyerlahkan **Groups**, kemudian tekan  [OK] untuk memasuki.
2. Tatal untuk menyerlahkan **Delete**, kemudian tekan  [OK] untuk memasuki.
3. Setelah itu mesej pengesahan akan dipaparkan.
4. Tekan  [OK] untuk memadam, atau tekan  [Back] untuk membatalkan.

## ● Notis

- Meskipun anda memadam Kumpulan di dalam senarai Kumpulan, entri-entri akan kekal di dalam memori.

## ■ Rename (Tukar Nama):



Anda boleh menukar nama kumpulan.

1. Tatal untuk menyerlahkan Groups, kemudian tekan  [OK] untuk memasuki.
2. Tatal untuk menyerlahkan butiran Rename, kemudian tekan  [OK] untuk memasuki.
3. Tetingkap mengedit Nama Kumpulan akan dipaparkan.
4. Tekan  [OK] untuk menukar nama, dan tekan  [Back] untuk membatalkan.

## Speed Dials (Dail Cepat) [Names 6]

---





Anda boleh mengaitkan sebarang kekunci dengan entri senarai Nama untuk memberikan anda akses langsung, dengan satu tekanan kekunci yang panjang dalam mod tunggu sedia.

1. Buka buku telefon dahulu dengan menekan  [Names] dalam mod tunggu sedia.
2. Tatal ke **Speed Dials**, kemudian tekan  [OK] untuk memasuki menu ini.
3. Setelah itu senarai Dail Cepat akan dipaparkan.
4. Terdapat tiga submenu: **Add (Tambah)**, **Change (Tukar)** and **Delete (Padam)**. Jika anda mahu menambahkan nombor Dail Cepat, pilih **<Empty>** dan tekan  [Add]. Anda boleh menukar peruntukan nombor Dail Cepat dengan memasukkan **Change** dan memadam nombor dail cepat yang telah diperuntukkan dengan memasukkan **Delete**.

## Delete all (Padam semua) [Names 7]



---

Anda boleh memadam semua nombor dan nama yang tersimpan. Fungsi ini mungkin memerlukan kod Keselamatan.

1. Buka buku telefon dahulu dengan menekan  [Names] dalam mod tunggu sedia.
2. Tatal ke **Delete all**, kemudian tekan  [OK] untuk memasuki menu ini.
3. Kemudian pilih memori yang ingin dipadam: Kad SIM atau Telefon.
4. Mesej amaran akan dipaparkan bagi memastikan keputusan anda.
5. Jika anda menekan  [OK] anda mungkin diminta memasukkan Kod Keselamatan '0000'.
6. Tekan  [OK] untuk memadam, tekan  [Back] untuk membatalkan.

## Memory (Memori) [Names 8]



---

1. Buka buku telefon dahulu dengan menekan  [Names] dalam mod tunggu sedia.
2. Tatal ke **Memory**, kemudian tekan  [OK] untuk memasuki menu ini.
3. Butiran-butiran menu di bawah akan dipaparkan.
  - **Select** : Ciri ini membolehkan anda memilih memori: Kad SIM atau Telefon.
  - **Show Status** : Ciri ini membolehkan anda memeriksa jumlah memori-memori dan berapa banyak memori yang digunakan di dalam buku telefon anda.

## Copy (Salin) [Names 9]

---

Anda boleh menyalin entri-entri dari satu memori ke memori yang lain. Anda boleh menyalin/memindahkan entri-entri dari memori kad SIM ke memori Telefon satu persatu atau semua sekali gus. Dan anda boleh menyalin/memindahkan entri-entri dari memori Telefon ke memori kad SIM satu persatu atau semua sekali gus.

1. Buka buku telefon dahulu dengan menekan  [Names] dalam mod tunggu sedia.
2. Tatal ke **Copy**, kemudian tekan  [OK] untuk memasuki menu ini.
3. Setelah itu submenu-submenu di bawah akan dipaparkan.

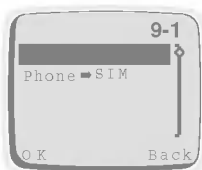

**SIM → Phone** : Anda boleh menyalin/memindahkan entri dari Kad SIM ke memori Telefon.

**Phone → SIM** : Anda boleh menyalin/memindahkan entri dari memori Telefon ke Kad SIM.

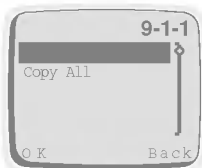

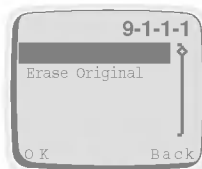

**One by One** : Anda boleh menyalin/memindahkan satu entri pada satu masa.

**Copy All** : Anda boleh menyalin/memindahkan semua entri sekali gus.



**Keep Original** : Kedua-dua entri asal dan entri yang dikesan disimpan di dalam memori-memori.





**Erase Original** : Entri asal dipadam sementara entri yang dikesan kekal di dalam memori.

4. Pilih entri untuk disalin/dipindahkan di dalam buku telefon.
5. Tekan  [OK] untuk menyalin/memindahkan, dan tekan  [Back] untuk membatalkan.

## Service Dial Number (Nombor Dail Khidmat) [Names 10] (Bergantung kepada SIM)

---



Gunakan fungsi ini untuk mengakses senarai tertentu bagi khidmat-khidmat yang disediakan oleh operator rangkaian anda (jika disokong oleh kad SIM).

1. Buka buku telefon dahulu dengan menekan  [Names] dalam mod tunggu sedia.
2. Tatal ke **SDN**, kemudian tekan  [OK] untuk memasuki.
3. Nama-nama khidmat yang terdapat akan dipaparkan.
4. Gunakan  dan  untuk memilih sesuatu khidmat.
5. Tekan  untuk memanggil khidmat.

## Own Number (Nombor Sendiri) [Names 11]

---

Jika anda memasukkan nombor telefon anda, Own Number akan dipaparkan.

1. Buka buku telefon dahulu dengan menekan  [Names] dalam mod tunggu sedia.
2. Tatal ke **Own Number**, kemudian tekan  [OK] untuk memasuki menu
3. Nama-nama nombor sendiri yang terdapat akan dipaparkan, jika anda memasukkan nama dan nombor anda.



## 1 Messages

- 1-1 Write Message
- 1-2 Outbox
- 1-3 Inbox
- 1-4 Status Report
- 1-5 Call Voicemail
- 1-6 Cell Broadcast
  - 1-6-1 CB Option
    - 1-6-1-1 On
    - 1-6-1-2 Off
  - 1-6-2 Read
  - 1-6-3 Topics
    - 1-6-3-1 SIM
      - 1-6-3-1-1 Add
      - 1-6-3-1-2 Delete
    - 1-6-3-2 Phone
      - 1-6-3-2-1 Add
      - 1-6-3-2-2 Select
      - 1-6-3-2-3 Delete
  - 1-6-4 Languages
- 1-7 Memory Status
- 1-8 Setting
  - 1-8-1 Status Report
  - 1-8-2 Message Type
  - 1-8-3 Expiry Period
  - 1-8-4 SMS Centre
  - 1-8-5 Voice Centre
  - 1-8-6 Alert



## 2 Call Option

- 2-1 Call Divert
  - 2-1-1 Voice Calls
    - 2-1-1-1 Divert All Voice Calls
    - 2-1-1-2 Divert if not Reachable
    - 2-1-1-3 Divert if Busy
    - 2-1-1-4 Divert if No Reply
    - 2-1-1-5 Cancel All
  - 2-1-2 All Data Call
  - 2-1-3 All Fax Call
  - 2-1-4 Cancel All
- 2-2 Call Barring
  - 2-2-1 All Outgoing Calls
  - 2-2-2 Outgoing International calls
  - 2-2-3 International except Home
  - 2-2-4 All Incoming Calls
  - 2-2-5 Incoming Calls When Roaming
  - 2-2-6 Cancel All
  - 2-2-7 Password Change
- 2-3 Call Waiting
- 2-4 Sending Number
- 2-5 CUG



## 3 Call Charge

- 3-1 Call Duration
  - 3-1-1 Last Call
  - 3-1-2 All Calls
  - 3-1-3 Incoming Call
  - 3-1-4 Outgoing Call
  - 3-1-5 Reset
- 3-2 Call Costs
  - 3-2-1 Last Call
  - 3-2-2 All Calls
  - 3-2-3 Reset
- 3-3 Cost Settings
  - 3-3-1 Call Cost Limit
  - 3-3-2 Set Tariff
  - 3-3-3 Sum. After Call



## 4 Security

- 4-1 PIN Enable
- 4-2 Change Codes
  - 4-2-1 PIN1
  - 4-2-2 PIN2
  - 4-2-3 Security Code
- 4-3 Fixed Dial No.



## 5 Setting

- 5-1 Network Selection
  - 5-1-1 Automatic
  - 5-1-2 Manual
- 5-2 Phone Setting
  - 5-2-1 Alert
  - 5-2-2 Backlight
  - 5-2-3 Key Tone Volume
  - 5-2-4 Ring Volume
  - 5-2-5 LCD Contrast
  - 5-2-6 Ring Pattern
  - 5-2-7 Language
  - 5-2-8 Welcome Display
  - 5-2-9 Standby Display
- 5-3 Call Setting
  - 5-3-1 Any Key Answer
  - 5-3-2 Auto Redial
  - 5-3-3 Call Mode
  - 5-3-4 Auto Answer
- 5-4 Time Setting
  - 5-4-1 Clock
    - 5-4-1-1 Set Time
    - 5-4-1-2 Set Time Format
  - 5-4-2 Date
    - 5-4-2-1 Set Date
    - 5-4-2-2 Set Date Format
  - 5-4-3 Alarm
    - 5-4-3-1 Set Alarm
    - 5-4-3-2 Cancel Alarm
    - 5-4-3-3 Power Off Alarm
- 5-5 Profiles



## 6 Accessories

- 6-1 Scheduler
  - 6-1-1 View day
    - 6-1-1-1 Delete
    - 6-1-1-2 Edit
    - 6-1-1-3 Send Note
  - 6-1-2 Make
    - 6-1-2-1 Schedule
    - 6-1-2-2 Call
    - 6-1-2-3 Memo
    - 6-1-2-4 Anniversary
  - 6-1-3 Delete
    - 6-1-3-1 Of Chosen Day
    - 6-1-3-2 One by One
    - 6-1-3-3 All At Once
  - 6-1-4 View All
- 6-2 World Time
- 6-3 Calculator
- 6-4 Unit Convert
  - 6-4-1 Length
  - 6-4-2 Weight
  - 6-4-3 Volumes
  - 6-4-4 Surface
- 6-5 Game
  - 6-5-1 Corsair
  - 6-5-2 Crazy Race
  - 6-5-3 Diamond King
  - 6-5-4 Stone Axe
  - 6-5-5 Black Jack



## 7 Voice Dial



- 7-1 Training
- 7-2 Search
  - 7-2-1 Voice Search
    - 7-2-1-1 Edit voice
    - 7-2-1-2 Edit number
    - 7-2-1-3 Delete
  - 7-2-2 Number Search
    - 7-2-2-1 Edit voice
    - 7-2-2-2 Edit number
    - 7-2-2-3 Delete
- 7-3 Setting
  - 7-3-1 Enable
  - 7-3-2 Disable
- 7-4 Delete all



## 8 Internet









- 8-1 Home
- 8-2 Bookmarks
  - 8-2-1 Go to
  - 8-2-2 Edit
  - 8-2-3 Erase
  - 8-2-4 Add Bookmark
- 8-3 Profiles
- 8-4 Empty cache

## Menggunakan Menu

Telefon anda menawarkan fungsi-fungsi yang membolehkan anda menyesuaikan telefon mengikut keperluan anda. Fungsi-fungsi ini disusun di dalam menu-menu dan submenu-submenu. Menu-menu dan submenu-submenu boleh diakses dengan menatal  dan  atau dengan menggunakan jalan pintas yang sesuai.





## Pemanduan Arah Menu Dengan Menatal

Menu Utama memberikan anda akses kepada semua menu lain.

1. Tekan  atau  untuk mencapai menu utama yang diinginkan (contohnya Keselamatan). Kemudian tekan  [Menu] untuk memasuki menu utama; sebaliknya, tekan  [Back] untuk keluar dari menu.
2. Jika anda mahu memasuki submenu, cari submenu yang anda mahu dengan menekan  atau . Dan tekan  [OK] untuk memasuki submenu, tekan  [Back] untuk keluar dari submenu.

## Jalan Pintas ke dalam Menu

Apabila anda mengetahui nombor-nombor menu, anda boleh menggunakannya untuk masuk dan keluar dari sesuatu menu dengan cepat. Di dalam buku ini, nombor-nombor menu ditunjukkan seperti ini.

1. Tekan  [Menu].
2. Masukkan dengan cepat nombor indeks fungsi menu yang ingin anda akses. Sebagai contoh, untuk mengaktifkan fungsi sebarang kekunci :
  -  : untuk **Entering the menu (Memasuki menu)**.
  -  : untuk **Setting (Tetapan)**.
  -  : untuk **Call setting (Tetapan Panggilan)**.
  -  : untuk **Any Key Answer (Jawab Menggunakan Sebarang Kekunci)**.

Menu di dalam telefon anda ini menyertakan fungsi-fungsi yang berhubung dengan mesej teks, mesej suara, mesej siaran sel, serta tetapan untuk mesej.

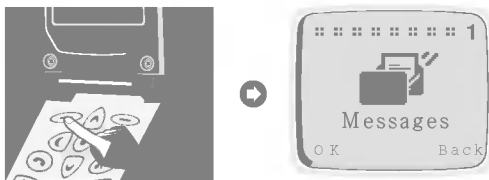

## Write Message (Tulis Mesej) [Menu 1-1]

Dengan menu **Write Message**, anda boleh menulis dan mengedit mesej teks sehingga 160 aksara. Apabila anda telah selesai menulis mesej anda, tekan [Opt]. Menu berikut akan dipaparkan.

### ■ Send: Menghantar mesej yang telah diedit.

1. Setelah anda memasuki menu ini, telefon anda akan meminta anda memasukkan nombor untuk menghantar mesej tersebut.
2. Selepas menghantarnya, telefon anda akan bertanya sama ada anda akan menyimpan mesej yang telah diedit.
3. Tekan [OK] jika anda mahu menyimpannya di dalam Outbox (Peti keluar) dan tekan [Back] jika anda tidak mahu.

### ■ Store: Menyimpan mesej di dalam

1. Telefon anda bertanya sama ada anda akan menyimpan mesej yang telah diedit atau
2. Tekan [OK] jika anda mahu menyimpannya di dalam Outbox dan tekan [Back] jika anda tidak mahu.

■ **Edit eZi Mode** : Jika anda memilih ini, anda boleh menulis mesej dengan kaedah input teks eZi.

■ **Edit LTR Mode** : Jika anda memilih ini, anda boleh menulis mesej dalam mod huruf.

■ **Edit Num Mode** : Jika anda memilih ini, anda boleh menulis mesej dalam mod angka.

■ **Dictionary** : Dalam pilihan ini, anda boleh menambah atau memadam perkataan di dalam kamus pengguna.

1. Tekan kekunci [Opt] selepas memasukkan perkataan yang anda mahu, dan anda boleh melihat menu yang berikut.

**Add to UPD**

**Del from UPD**

## Messages (Mesej) [Menu 1]





2. Pilih **Add to UPD** jika anda mahu menambah perkataan yang telah dimasukkan sebelumnya di dalam kamus pengguna bahasa eZi yang sedang dipilih. Perkataan ini akan dicari oleh aZi apabila anda mengedit dalam mod eZi.
3. Pilih **Del from UPD**, jika anda mahu memadam perkataan yang telah dimasukkan sebelumnya di dalam kamus pengguna atau bahasa eZi yang sedang dipilih.



Perkataan yang ditambahkan akan dicari oleh eZi apabila anda mengedit dalam mod eZi.

- **List Dictionary** : Jika anda memilih ini, anda boleh melihat perkataan perkataan tambahan di dalam kamus pengguna bahasa eZi yang sedang dipilih. Pilih satu perkataan yang ingin anda edit atau padam, dan anda boleh memilih untuk menambah atau memadam perkataan yang baru diedit di dalam menu berikut.

### Outbox (Peti keluar) [Menu 1-2]

---

Apabila anda memasuki menu ini, anda boleh melihat mesej-mesej yang disimpan. tatal ke mesej yang diinginkan dengan menggunakan  ,  dan anda boleh melihat halaman atas atau bawah menggunakan  ,  . Dan jika anda mahu keluar dari menu outbox, tekan  [Back].

Jika anda mahu mengedit mesej, tekan  [Edit] dan anda boleh mengedit mesej yang dipilih. Apabila anda telah selesai mengedit mesej dan menekan  [Opt], anda boleh memaparkan menu seterusnya: **Send, Save, Delete, Delete all**.

#### ■ **Send:**

Anda boleh menghantar mesej yang terpilih. Urutannya sama dengan pilihan Send (Hantar) di dalam mesej Write (Tulis).



#### ■ **Save:**

Anda boleh menyimpan mesej yang terpilih. Urutannya sama dengan pilihan Save (Simpan) di dalam mesej Write (Tulis).

#### ■ **Delete:**







Mesej telah dipadam.

#### ■ **Delete all:**

Semua mesej di dalam Outbox akan dipadam. Di dalam menu ini, telefon anda akan bertanya sama ada anda benar-benar mahu memadam semua mesej untuk keselamatan. Kemudian tekan  [OK] untuk membuang semua mesej, dan tekan  [Back] jika anda tidak mahu.

## Inbox (Peti masuk) [Menu 1-3]



---

Apabila mesej teks diterima, telefon anda memaparkan  dan menyimpannya di dalam senarai mesej masuk. Ia menunjukkan simbol sehingga anda membaca mesej. Setelah anda memasuki menu ini, anda boleh melihat mesej terakhir diterima. Tatal ke mesej yang diinginkan dengan menggunakan ,  dan lihat halaman atas atau bawah dengan menggunakan , . Jika anda mahu keluar dari menu Inbox, tekan  [Back]. Semasa membaca mesej, tekan  [Opt] untuk mengakses pilihan-pilihan yang terdapat.

### ■ Delete:

Mesej dipadam.

### ■ Reply:

Anda boleh menghantar mesej balasan kepada penghantar. Setelah anda memasuki menu ini, anda boleh mengedit mesej yang ingin anda hantar dan tekan  [OK] untuk menghantarnya atau tekan  [Back] untuk membatalkannya. Di paparan, hanya nombor telefon penghantar akan ditunjukkan tanpa kandungan mesej dari penghantar.

### ■ Forward:

Anda boleh menghantar lanjut mesej terpilih kepada nombor telefon lain. Di dalam menu ini, telefon anda meminta anda memasukkan nombor dan kemudian menghantarnya.



### ■ Return call:

Anda boleh memanggil balik penghantar yang menghantar mesej. Jika anda memilih butiran ini, telefon anda akan mendail secara automatik.

### ■ Extract Number:

Dengan fungsi ini, anda akan dapat mengambil nombor-nombor yang dipaparkan di telefon. Ia mengambil hanya nombor-nombor pertama yang dipaparkan di dalam kandungan. Nombor-nombor haruslah lebih daripada 2 dan kurang daripada 21 angka, tetapi untuk nombor-nombor antarabangsa, lebih daripada 8 dan kurang daripada 21 angka termasuk '+'. Tidak harus terdapat ruang di antara nombor-nombor.

### ■ Delete all:

Semua mesej di dalam Inbox akan dipadam. Telefon anda akan bertanya sama ada benar-benar mahu memadam semua mesej untuk keselamatan. Kemudian tekan  [OK] untuk membuangnya, dan tekan  [Back] jika anda tidak mahu.

# Messages (Mesej) [Menu 1]

## Status Report (Laporan Status) [Menu 1-4]

---

You can receive a status report for sending message by setting it. When you receive a text message of status report, your phone stores it in the status report message lists.



If the memory for status report is full, the phone will delete the oldest status report automatically and store the latest status report.

Once you enter this menu, you can see the previous stored status report. Scroll to the desired message by using  ,  and see upper or lower page by using  ,  . And if you want to exit Status Report menu, press  [Back]. While reading message, press  [Opt] to access the available options.

### ■ Delete

Mesej laporan status yang terpilih dipadam.

### ■ Delete All

Semua mesej di dalam Status Report akan dipadam. Telefon anda akan bertanya sama ada anda benar-benar mahu memadam semua mesej untuk keselamatan. Kemudian tekan  [OK] untuk membuang semua mesej, dan tekan  [Back] jika anda tidak mahu.

## Call Voicemail (Mel Suara Panggilan) [Menu 1-5]



---

Di dalam menu ini, anda boleh mendengarkan mesej suara anda. Jika telefon anda menyimpan alamat pusat mesej suara, ia akan memanggil secara automatik, jika tidak, ia akan meminta nombor itu dimasukkan.

## Cell Broadcast (Siaran Sel) [Menu 1-6]

---

Mesej-mesej siaran sel adalah mesej-mesej teks yang disiarkan oleh rangkaian kepada kumpulan-kumpulan pengguna telefon GSM. Ia memberi maklumat umum seperti laporan cuaca, berita lalu lintas, dan harga-harga pasaran saham. Setiap jenis maklumat mempunyai nombor jenis maklumat yang berkaitan. Apabila anda menerima mesej siaran, anda boleh membacanya menurut urutan :





1. Apabila anda menerima mesej siaran, ia dipaparkan secara automatik pada tettingkap. Jika mesej terlalu panjang untuk dipaparkan semua di dalam satu tettingkap, anda boleh membacanya dengan menatal  dan  .
2. Selepas membaca mesej, tekan  [OK] untuk kembali ke mod melahu.
3. Telefon anda akan menyimpannya sehingga mesej baru saluran itu dicapai.
4. Jika anda mahu membacanya sekali lagi, lihat [Menu 1-6-2](Baca).

## ■ CB Option (Pilihan CB) [Menu 1-6-1]

- **On (Hidup) [1-6-1-1]** : Jika anda memilih menu ini, telefon anda akan menerima mesej Siaran Sel.
- **Off (Mati) [1-6-1-2]** : Jika anda memilih menu ini, telefon anda tidak akan menerima mesej-mesej Siaran Sel lagi.

## ■ Read (Baca) (Bergantung kepada rangkaian dan langganan) [Menu 1-6-2]

Anda boleh membaca mesej siaran yang disimpan di dalam menu ini. Selain itu, telefon anda menyimpan hanya mesej terakhir setiap saluran.

1. Jika anda memilih menu ini, telefon anda akan memaparkan mesej.
2. Anda boleh membacanya. Jika ia terlalu panjang sehingga tidak dapat dipaparkan pada satu skrin, tatal dengan menekan  dan .
3. Selepas membaca, tekan kekunci  untuk membaca mesej seterusnya, dan tekan  [Exit] untuk keluar dari menu ini.



## ■ Topics (Topik) (Bergantung kepada rangkaian dan langganan) [Menu 1-6-3]

### SIM

Jika anda memilih menu ini, anda boleh menambah atau memadam kategori mesej CB di dalam memori SIM. Jika anda memilih menu **Add**, anda boleh memasukkan hanya nombor-nombor kategori yang terdiri daripada sepasang nombor.

Jika anda memilih menu **Delete**, anda boleh melihat senarai kategori mesej CB dan memadam ia dengan menggunakan  [Delete].

### Phone

Jika anda memilih menu ini, anda akan menambah, memilih dan memadam kategori mesej CB di dalam memori Telefon. Jika anda memilih menu **Add**, anda akan menambah nombor-nombor kategori mesej CB dengan nama gelarnya. Jika anda memilih menu **Select**, anda boleh melihat senarai nombor-nombor kategori mesej CB dengan nama gelarnya dan memilih ia dengan menggunakan  [OK] untuk mengaktifkan atau menyahaktifkannya. Jika anda memilih menu **Delete**, anda boleh melihat senarai nombor-nombor kategori mesej CB dengan nama gelarnya dan memadam ia dengan menggunakan  [Delete].

## ■ Languages (Bahasa) [Menu 1-6-4]

Anda boleh memilih bahasa di dalam menu ini. Setelah itu telefon anda akan menerima mesej-mesej siaran sel yang ditulis dalam bahasa yang terpilih.

1. Di dalam menu ini, anda boleh melihat beberapa bahasa. (contohnya – Inggeris, Perancis ...)

# Messages (Mesej) [Menu 1]

2. Tatal untuk menyerlahkan bahasa yang anda mahu, pilih hidup/mati.
3. Anda boleh memilih lebih daripada satu butiran menerusi prosedur 1~2.

## Memory Status (Status Memori) [Menu 1-7]

---

Jika pengguna memilih menu ini, telefon menunjukkan memori yang telah digunakan dan jumlah memori. Jumlah memori ialah jumlah memori SIM dan memori Telefon.

## Setting (Tetapan) [Menu 1-8]

---

### ■ Status Report (Laporan Status) [Menu 1-8-1]

Di dalam menu ini, anda boleh menetapkan khidmat mesej untuk menerima mesej-mesej yang akan dihantar. Laporan ini sampaikan sama ada mesej berjaya dihantar ke destinasi atau tidak.

- **On** : Jika anda memilih menu ini, anda akan menerima laporan status mesej.
- **Off** : Jika anda memilih menu ini, anda tidak akan menerima laporan status mesej.

### ■ Message Type (Jenis Mesej) [Menu 1-8-2]

**:Text, Voice, Fax, X.400, E-mail, ERMES**

Biasanya, pilihan menu ini harus ditetapkan ke “Text”. Khidmat mesej anda mungkin, bagaimanapun, menawarkan anda kemudahan bagi menukar mesej teks anda kepada format-format alternatif yang sesuai untuk alat yang akan menerima mesej. Hubungi pembekal khidmat anda untuk ketersediaan fungsi ini.

### ■ Expiry Period (Tempoh Tamat Tempoh) [Menu 1-8-3]

Khidmat rangkaian ini membolehkan anda menetapkan berapa lama mesej-mesej teks anda akan disimpan di pusat mesej sementara percubaan dibuat untuk menghantanya kepada anda: **1 jam, 6 jam, 12 jam, 1 hari, 2 hari, 1 Minggu, Maksimum.**

### ■ SMS Centre (Pusat SMS) [Menu 1-8-4]

Di dalam menu ini, telefon anda meminta alamat pusat SMS anda. Ini diperlukan untuk menghantar mesej teks.

### ■ Voice Centre (Pusat Suara) [Menu 1-8-5]

Di dalam menu ini, telefon anda meminta anda memasukkan untuk mesej suara anda. Ini diperlukan untuk mendengarkan mesej-mesej suara anda.

### ■ Alert (Isyarat) [Menu 1-8-6]

Pengguna boleh menetapkan berapa kali dan berapa kerap telefon memberi isyarat kepada pengguna tentang mesej yang masuk.

Gunakan menu "Call Option" untuk mengakses khidmat-khidmat tambahan yang disediakan oleh rangkaian GSM.



### ● Perhatian

- Menu-menu Call Divert (Alihan Panggilan), Call Barring (Sekatan Panggilan), dan Call Waiting (Panggilan Menunggu) setiap satu mengandungi pilihan untuk memaparkan status semasa khidmat. Fungsi ini membuat panggilan kepada rangkaian. Anda boleh dikenakan bayaran untuk panggilan ini. Periksa dengan pembekal khidmat anda.

## Call Divert (Alihan Panggilan) [Menu 2-1]

(bergantung kepada rangkaian dan langganan)

Khidmat Call Divert mengalihkan panggilan suara, panggilan faks, dan/atau panggilan data yang masuk ke nombor lain.

1. Tekan [Menu] dalam mod tunggu sedia.
2. Tekan untuk akses langsung atau gunakan dan untuk memasuki Call Option.
3. Pilih menu **Call Divert** dan tekan [OK] untuk memasuki.
4. Pilih **Voice Calls**.

### ■ Voice Calls (Panggilan Suara) [Menu 2-1-1]

- **Divert All Voice Calls** (Alih Semua Panggilan Suara)  
: Alihkan panggilan tanpa syarat.
- **Divert if not Reachable** (Alih jika Tidak Dapat Dihubungi)  
: Alihkan panggilan apabila rangkaian tidak dapat menghubungi anda.
- **Divert if Busy** (Alih jika Sibuk)  
: Alihkan panggilan apabila telefon sedang sibuk.
- **Divert if No Reply** (Alih jika Tiada Jawapan)  
: Alihkan panggilan yang tidak anda jawab.
- **Cancel All** (Batal Semua)  
: Hanya batalkan alihan panggilan suara.





### ■ All Data Call (Semua Panggilan Data) [Menu 2-1-2] : Mengalihkan semua panggilan data tanpa syarat.

1. Tekan [Menu] dalam mod tunggu sedia.
2. Tekan untuk akses langsung atau gunakan dan untuk memasuki Call Option.





## Call Option (Pilihan Panggilan) [Menu 2]

3. Pilih menu **Call Divert** dan tekan  [OK] untuk memasuki.
4. Pilih **All Data Call**.

### ■ All Faks Call (Semua Panggilan Faks) [Menu 2-1-3] : Mengalihkkan semua panggilan faks tanpa syarat.

1. Tekan  [Menu] dalam mod tunggu sedia.
2. Tekan  untuk akses langsung atau gunakan  dan  untuk memasuki Call Option.
3. Pilih menu **Call Divert** dan tekan  [OK] untuk memasuki.
4. Pilih **All Fax Call**.

### ■ Cancel All (Batal Semua) [Menu 2-1-4] : Membatalkan semua alihan panggilan suara, data dan faks.





1. Tekan  [Menu] dalam mod tunggu sedia.
2. Tekan  untuk akses langsung atau gunakan  dan  untuk memasuki Call Option.
3. Pilih menu **Call Divert** dan tekan  [OK] untuk memasuki.
4. Pilih **Cancel All**.

## Call Barring (Sekatan Panggilan) [Menu 2-2]

---

(bergantung kepada rangkaian dan langganan)

Khidmat Call barring mencegah telefon anda daripada membuat dan/atau menerima kategori-kategori panggilan yang tertentu. Fungsi ini memerlukan kata laluan sekatan panggilan dari pembekal khidmat.





1. Tekan  [Menu] dalam mod tunggu sedia.
2. Tekan  untuk akses langsung atau gunakan  dan  untuk memasuki Call Option.
3. Tatal untuk menyerlahkan menu Call Barring dan tekan  [OK] untuk memasuki.
  - **All Outgoing Calls** (Semua Panggilan Keluar)  
: Khidmat sekatan bagi semua panggilan keluar.
  - **Outgoing International Calls** (Panggilan Keluar Antarabangsa)  
: Khidmat sekatan bagi panggilan antarabangsa yang keluar
  - **International except Home** (Keluar Antarabangsa kecuali keTanah Air)  
: Khidmat sekatan bagi semua panggilan antarabangsa yang keluar, kecuali ke rangkaian tanah air anda.
  - **All Incoming Calls** (Semua Panggilan Masuk)  
: Khidmat sekatan bagi semua panggilan masuk.

- **Incoming Calls When Roaming** (Panggilan Masuk Apabila Merayau)  
: Khidmat sekatan bagi semua panggilan masuk apabila merayau.
- **Cancel All** (Batal Semua)  
: Hanya membatalkan khidmat sekatan bagi panggilan suara.
- **Password Change** (Tukar Kata Laluan)  
: menukar kata laluan Call Barring (Sekatan Panggilan).

### **Call Waiting (Panggilan Menunggu) [Menu 2-3]**

(bergantung kepada rangkaian dan langganan)





Mengaktif atau menyahaktifkan khidmat Call Waiting (Panggilan Menunggu). Jika khidmat ini diaktifkan, pengguna boleh menerima panggilan (masuk) yang menunggu. Jika khidmat ini diaktifkan, pengguna tidak boleh menerima panggilan (masuk) yang menunggu dan tidak dapat mengenalinya.

1. Tekan  [Menu] dalam mod tunggu sedia.
2. Tekan  untuk akses langsung atau gunakan  dan  untuk memasuki Call Option.
3. Tatal untuk menyerlahkan menu Call Waiting dan tekan  [OK] untuk memasuki.

### **Sending Number (Nombor yang Menghantar) [Menu 2-4]**

(bergantung kepada rangkaian dan langganan)





Menu ini sah hanya apabila pengguna melanggan mod sementara. Jika anda memilih On (Aktif), anda membenarkan nombor telefon anda dipaparkan kepada pihak yang lain. Anda juga boleh menukar mod On/Off seperti yang anda mahu.

1. Tekan  [Menu] dalam mod tunggu sedia.
2. Tekan  untuk akses langsung atau gunakan  dan  untuk memasuki Call Option.
3. Tatal untuk menyerlahkan menu Sending Number dan tekan  [OK] untuk memasuki.

### **Closed User Group (Kumpulan Pengguna Terhad) [Menu 2-5]**

(bergantung kepada rangkaian)

Gunakan fungsi ini untuk menyekat penggunaan telefon kepada panggilan-panggilan dengan nombor-nombor di dalam kumpulan-kumpulan pengguna tertentu. Apabila fungsi ini digunakan, setiap panggilan keluar dikaitkan dengan indeks kumpulan. Jika sesuatu indeks kumpulan ditentukan, ia digunakan untuk semua panggilan keluar. Jika tiada indeks kumpulan yang ditentukan, rangkaian akan menggunakan indeks utama (suatu indeks tertentu yang disimpan di dalam rangkaian).

1. Tekan  [Menu] dalam mod tunggu sedia.
2. Tekan  untuk akses langsung atau gunakan  dan  untuk memasuki Call Option (Pilihan Panggilan).
3. Tatal untuk menyerlahkan CUG dan tekan  [OK] untuk memasuki.

## (Bergantung kepada SIM)







<Tekan dua kali>



### Call Duration (Tempoh Panggilan) [Menu 3-1]

Fungsi ini membolehkan anda melihat tempoh Panggilan Terakhir, Semua Panggilan, Panggilan Masuk dan Panggilan Keluar anda dalam kiraan jam, minit dan saat. Anda juga boleh mengosongkan pengira masa panggilan.





1. Tekan  [Menu] dalam mod tunggu sedia.
2. Tekan  untuk akses langsung atau gunakan  dan  untuk memasuki Call Charge.
3. Pilih Call Duration dan tekan  [OK] untuk memasuki.
4. Menu ini mempunyai 5 submenu. Anda boleh memilih butiran yang ingin anda lihat.

### Call Costs (Kos Panggilan) [Menu 3-2]

Khidmat rangkaian ini membolehkan anda memeriksa kos-kos panggilan terakhir atau semua panggilan anda dan mengosongkan pengira masa. Untuk mengosongkan pembilang anda memerlukan kod PIN2. Kos ditunjukkan untuk setiap kad SIM secara erasingan dari segi unit yang ditetapkan dalam masa [Menu 3-3-2].

#### ● Perhatian

- Kos sebenar yang diinvois bagi panggilan-panggilan oleh pembekal khidmat anda mungkin berbeza-beza bergantung kepada ciri-ciri rangkaian, pembulatan untuk bil, cukai, dll.





1. Tekan  [Menu] dalam mod tunggu sedia.
2. Tekan  untuk akses langsung atau gunakan  dan  untuk memasuki Call Charge.
3. Tatal untuk menyerlahkan Call Costs dan tekan  [OK] untuk memasuki.
4. Menu ini mempunyai 3 Submenu. Pilih butiran yang anda mahu.

## Cost Settings (Tetapan Kos) [Menu 3-3]

(bergantung kepada SIM)





### ■ Call Cost Limit (Had Kos Panggilan) [Menu 3-3-1]

Khidmat rangkaian membolehkan anda menyekat kos panggilan-panggilan anda kepada satu bilangan unit mengecaj yang terpilih. Jika anda telah memilih **On**, anda boleh menetapkan had kos dari segi unit dan menggunakan telefon anda bagi satu bilangan unit mengecaj yang terpilih. Jika anda telah memilih **Off**, anda boleh menggunakan telefon anda tanpa sebarang had kos. Apabila semua unit telah digunakan, tiada panggilan yang boleh dibuat kecuali panggilan kecemasan. Untuk menetapkan had kos panggilan, anda memerlukan kod PIN2.

1. Tekan  [Menu] dalam mod tunggu sedia.
2. Tekan  untuk akses langsung atau gunakan  dan  untuk memasuki Call Charge.
3. Tatal untuk menyerlahkan **Cost Settings** dan tekan  [OK] untuk memasuki.
4. Pilih **Call Cost Limit** untuk memasuki.



### ■ Set Tariff (Tetapan Tarif) [Menu 3-3-2]

Anda boleh menetapkan nama mata wang dan harga unit. Hubungi pembekal khidmat anda untuk menetapkan harga-harga unit yang boleh dikenakan caj. Untuk memilih mata wang atau unit di dalam menu ini, anda akan memerlukan kod PIN2.

1. Tekan  [Menu] dalam mod tunggu sedia.
2. Tekan  untuk akses langsung atau gunakan  dan  untuk memasuki Call Charge.
3. Tatal untuk menyerlahkan **Cost Settings** dan tekan  [OK] untuk memasuki.
4. Pilih **Set Tariff** untuk memasuki.

### ■ Sum. After Call (Ringkasan Selepas Panggilan) [Menu 3-3-3]

Anda boleh memeriksa tempoh dan kos panggilan semasa panggilan atau selepas menamatkan panggilan jika anda menetapkan kepada On.

1. Tekan  [Menu] dalam mod tunggu sedia.
2. Tekan  untuk akses langsung atau gunakan untuk memasuki Call Charge.
3. Tatal untuk menyerlahkan **Cost Settings** dan tekan OK untuk memasuki.
4. Pilih **Sum After Call**.





<Tekan tiga kali>



## **PIN Enable (Upaya PIN) [Menu 4-1]**

---



Di dalam menu ini, anda boleh menetapkan telefon supaya meminta kod PIN kad SIM anda apabila telefon dihidupkan. Untuk menggunakan fungsi ini, anda akan diminta memasukkan kod PIN.

1. Masuki menu ini dengan memilih **PIN Enable**. Telefon anda akan meminta anda memasukkan kod PIN jika permintaan PIN diupaya.
2. Masukkan kod PIN anda.
3. Tekan  [OK] untuk menentusahkan kod PIN, dan tekan  [Back] untuk memadam aksara yang anda masukkan.
4. Menu berikut akan dipaparkan.
  - **Enable** : Mengupaya permintaan kod PIN.
  - **Disable** : Melumpuhkan permintaan kod PIN.

## **Change Codes (Tukar Kod) [Menu 4-2]**

---

Menu ini memberi anda fungsi menukar kod-kod akses : **PIN1**, **PIN2 code**, dan **Security code '0000'**.

1. Masuki menu ini dengan memilih **Change Codes**.
2. Dan pilih **PIN1**, **PIN2**, atau **Security Code**.
3. Masukkan kod-kod PIN asal anda dan tekan  [OK].
4. Telefon anda meminta anda memasukkan kod PIN1/PIN2 atau Security Code (Kod Keselamatan) yang akan menggantikan yang lama dan tekan  [OK]. Telefon kemudian meminta kod-kod PIN baru atau Kod Keselamatan sekali lagi.
5. Jika anda memasukkan PIN1/PIN2 yang asal atau Kod Keselamatan yang salah dan membuat pengesahan benar bagi yang baru, ia akan ditukar.

## **Fixed Dial Number (Nombor Dail Tetap) [Menu 4-3]**

---

Anda boleh menyekat panggilan-panggilan keluar anda kepada nombor-nombor telefon yang terpilih, jika fungsi ini disokong oleh kad SIM anda. Nombor-nombor ini dilindungi oleh PIN2 anda.

1. Masuki menu ini dengan memilih **Fixed Dial No.** Telefon anda akan meminta kod PIN2.
2. Masukkan kod PIN2 asal anda dan tekan  [OK]. Jika anda memasukkan kod PIN2 yang betul, menu berikut akan dipaparkan.
  - **Enable** : Memberi fungsi menyekat panggilan keluar anda kepada nombor-nombor telefon yang terpilih, jika ia disokong oleh kad SIM anda.
  - **Disable** : Tiada sekatan untuk panggilan keluar.
  - **Number** : Membolehkan anda menambah, mengedit dan memadam Nombor Dail Tetap.



<Tekan empat kali>

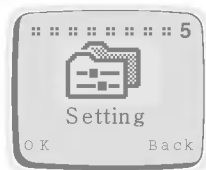

## Network Selection (Pemilihan Rangkaian) [Menu 5-1]

---

Anda boleh memilih rangkaian yang anda akan berdaftar dengannya secara automatik atau manual.

### ■ Automatic [Menu 5-1-1]

Telefon secara automatik memilih rangkaian yang terdapat di kawasan itu.

### ■ Manual [Menu 5-1-2]

Telefon akan mencari senarai rangkaian-rangkaian yang terdapat dan menunjukkannya kepada anda. Anda boleh memilih rangkaian yang anda mahu gunakan jika rangkaian ini mempunyai persetujuan merayau dengan operator rangkaian tanah air anda.

## Phone Setting (Tetapan Telefon) [Menu 5-2]

---

### ■ Alert (Isyarat) [Menu 5-2-1]

Tetapan ini mentakrifkan cara telefon memberitahu anda tentang panggilan suara yang masuk: **Ring** (Berdering), **Vibrate** (Bergetar), **Vibrate & Ring** (Bergetar & Berdering), **Ring After Vibrate** (Berdering Selepas Bergetar), dan **Silent** (Senyap). Setelah anda memilih menu ini, perkara berikut mungkin berlaku.

Telefon ini menunjukkan menu : Ring, Vibrate, Vibrate & Ring, Ring After Vibrate, Silent dengan menekan  dan  dan pilih satu.

### ■ Backlight (Lampu Latar) [Menu 5-2-2]

Anda boleh menetapkan berapa lama anda mahu lampu pad kekunci dan paparan beryala setiap kali anda menekan kekunci : **Off** (Mati), **Always Open Flip** (Sentiasa Buka Penutup), **20 seconds** (20 saat), **10 seconds** (10 saat), **5 seconds** (5 saat).

### ■ Key Tone Volume (Kelantangan Nada Kekunci) [Menu 5-2-3]

Anda boleh menetapkan tahap kelantangan bagi nada kekunci yang ditekan : **Level** (Tahap) 1~5, dan **Off** (Mati).

### ■ Ring Volume (Kelantangan Deringan) [Menu 5-2-4]





Anda boleh menetapkan tahap kelantangan bagi nada deringan : **Level** 1~5, dan **Off**.

### ■ LCD Contrast (Kontras LCD) [Menu 5-2-5]

Anda boleh menetapkan kontras warna bagi aksara-aksara pada LCD: Nilai 0~9.

## ■ Ring Pattern (Corak Deringan) [Menu 5-2-6]

Jika anda memilih menu ini, anda boleh memilih pelbagai corak deringan dan nada deringan.

1. Masuki menu ini. Telefon anda akan meminta anda memilih nada deringan dan corak deringan.
2. Telefon anda memaparkan senarai corak deringan. Pilih salah satu dengan menekan , . Anda juga boleh menukar nada deringan dengan menekan , .

## ■ Language (Bahasa) [Menu 5-2-7]

Menu ini memberi anda pilihan bahasa bagi teks paparan yang ditunjukkan. Jika tetapan Automatic dipilih, bahasa yang digunakan dipilih berdasarkan kad SIM yang sedang digunakan. Bahasa Inggeris akan digunakan jika bahasa pada kad-kad SIM tidak ditemui di dalam telefon.

## ■ Welcome Display (Paparannya Pembukaan) [Menu 5-2-8]

Menu ini membolehkan anda menetapkan teks atau animasi yang ditunjukkan sebentar apabila telefon dihidupkan.

1. Tatal untuk menyerlahkan **Welcome Display**.
2. Kemudian menu berikut akan dipaparkan.
  - **Text** : Teks anda sendiri boleh dipaparkan. Jika anda memilih butiran ini, telefon anda meminta anda mengedit mesej.
  - **Animation** : Animasi akan dipaparkan.

## ■ Standby Display (Paparannya Tunggu Sedia) [Menu 5-2-9]

Menu ini membolehkan anda memilih paparan tettingkap tunggu sedia. Anda boleh memilih salah satu **Zodiac (User Own (Pengguna Sendiri), Monthly (Bulanan)), Digital Clock (Jam Digital), Analog Clock, Normal, dan Text. Dalam mod teks**, anda boleh mengedit teks.

## Call Setting (Tetapan Panggilan) [Menu 5-3]

### ■ Any Key Answer (Jawab Menggunakan Sebarang Kekunci) [Menu 5-3-1]

- **On** : Jika anda memilih ini, anda boleh menjawab telefon sama ada dengan membuka pelipat atau menekan sebarang kekunci kecuali kekunci END/PWR (TAMAT/KUASA) semasa pelipat dibuka.
- **Off** : Jika anda memilih ini, anda boleh menjawab telefon hanya dengan menekan .

### ■ Auto Redial (Dail Semula Auto) [Menu 5-3-2]

- **On** : Apabila fungsi ini diaktifkan, telefon anda akan membuat sehingga 10 percubaan selepas satu percubaan memanggil yang gagal.
- **Off** : Apabila fungsi ini diaktifkan, telefon anda tidak akan membuat sebarang percubaan untuk menyambung selepas satu percubaan memanggil yang gagal.

## ■ Call Mode (Mod Panggilan) [Menu 5-3-3]

Di dalam menu ini, anda boleh menggunakan telefon dan sebuah PC yang disambungkan untuk menghantar dan menerima faks, data dan suara. Setelah anda memasuki menu ini, pilihan-pilihan berikut dipaparkan.

- **Single Mode :**  
Untuk menggunakan khidmat data atau faks, pastikan bahawa mod panggilan ialah **Single mode** (Mod Tunggal). Dalam mod ini, anda boleh berkomunikasi melalui suara, data atau faks.
- **Voice and Fax :**  
Dalam mod ini, anda boleh menghantar suara dan juga faks.
- **(SINGLE NUMBER) RX VOICE AND FAX**
- **(SINGLE NUMBER) RX FAX**
- **(SINGLE NUMBER) RX DATA**

Dalam hal khidmat per nomboran tunggal, anda boleh menggunakan mod-mod ini. Jika anda memilih mod ini, anda boleh menerima data, faks atau faks dengan suara setiap mod.

### ● Notis

- Khidmat per nomboran tunggal bermakna bahawa nombor khidmat faks atau data adalah sama dengan nombor khidmat suara. Dan, mod-mod ini bergantung kepada ciri rangkaian.

## ■ Auto Answer (Jawapan Auto) [Menu 5-3-4]

Fungsi ini akan diaktifkan hanya apabila telefon anda terpasang pada kit Bebas Tangan atau Bebas Tangan Mudah Alih.

- **Off** : Apabila telefon berdering, anda mestilah menjawabnya secara aktif.
- **5 Seconds** : Selepas 5 saat, telefon anda akan menjawab secara automatik.
- **10 Seconds** : Selepas 10 saat, telefon anda akan menjawab secara automatik.

## Time Setting (Tetapan Masa) [Menu 5-4]

---

### ■ Clock (Jam) [Menu 5-4-1]

Telefon mempunyai jamnya sendiri. Di dalam menu ini anda boleh menetapkan masa dan memilih antara format 12 jam dan 24 jam.

- **Set Time** (Tetapkan Jam.) : Anda boleh menetapkan masa telefon anda di dalam menu ini. Selepas menetapkan masa, tekan  [OK] untuk menyimpannya.
- **Set Time Format** (Tetapkan Format Jam.) : Anda boleh memilih format masa antara 12 jam dan 24 jam.

## ■ Date (Tarikh) [Menu 5-4-2]

- **Set Date** (Tetapkan Tarikh) : Anda boleh menetapkan tarikh pada telefon anda (tahun, bulan, hari). Cara mengedit tarikh adalah sama dengan "Clock" ("Jam").
- **Set Date Format** (Tetapkan Format Tarikh) : Anda boleh menetapkan format tarikh di dalam menu ini. tttt/bb/hh atau hh/bb/tttt atau bb/hh/tttt.

## ■ Alarm (Penggera) [Menu 5-4-3]

Telefon anda boleh digunakan sebagai penggera. Tetapan dibuat melalui kaedah yang sama dengan kaedah yang digunakan dalam penetapan masa.

- **Set Alarm** (Tetapkan Penggera) : Anda boleh menetapkan penggera yang dibunyikan oleh telefon mengikut Jam dan Minit.
  1. Pilih Alarm (Penggera).
  2. Tetapkan masa telefon anda akan membunyikan penggera. Cara mengedit masa adalah sama dengan "Clock".
  3. Telefon anda akan membunyikan penggera setiap hari sehingga anda membatalkannya menurut "Cancel Alarm ("Batalkan Penggera") yang berikut.
- **Cancel Alarm** (Batalkan Penggera) : Anda boleh membatalkan penggera yang telah ditetapkan.
  1. Di dalam menu ini, anda boleh memilih penggera yang ingin anda batalkan.
  2. Telefon anda akan membatalkan penggeraan.
- **Power Off Alarm** (Penggeraan Semasa Telefon Dimatikan) : Isyarat penggera membunyikan pada masa yang ditetapkan, walaupun ketika telefon dimatikan.

## Profiles (Profil) [Menu 5-5]

---

Di dalam Menu ini, anda boleh memilih sekumpulan tetapan untuk melaras perbagai sekitaran. (contohnya, Apabila anda berada di luar, anda boleh memilih profil luar, DII) Sekitaran adalah Normal, Silent (Senyap), Outdoors (Luar), and User Own (Pilihan Pengguna). Sekumpulan tetapan adalah Alert (Isyarat), Key Tone Volume (Kelantangan Nada Kekunci), Ring Volume (Kelantangan Deringan).

### ■ Normal/Outdoors (Biasa/Luar)

- **Activate** : Anda boleh melaras profil sebagai sekitaran. Alert, Key Tone Volume, dan Ring Volume ditetapkan secara serentak.
- **Change** : Anda boleh menukar nilai tetapan-tetapan. ; Alert, Key Tone Volume, Ring Volume.

### ■ User Own (Pilihan Pengguna)

- **Edit Name** : Anda boleh mengedit Profile Name (Nama Profil).
- **Activate** : Anda boleh melaras profil sebagai sekitaran anda sendiri.
- **Change** : Anda boleh menukar nilai tetapan-tetapan.

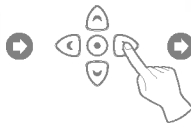

<Tekan lima kali>

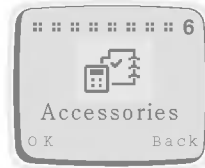



## Scheduler (Penjadual) [Menu 6-1]

Apabila anda memasuki menu ini, Calendar akan dipaparkan. Di bahagian atas skrin terdapat bahagian-bahagian untuk tarikh dan ikon-ikon. Anda boleh menukar hari, bulan dan tahun dengan menggunakan kekunci-kekunci pemanduan dan kekunci-kekunci angka. Kursor empat segi akan menyerlahkan hari yang terpilih. Garis bawah pada tarikh tertentu bermakna terdapat entri untuk hari itu. Penggera boleh ditetapkan untuk mengingatkan anda tentang acara-acara yang dijadualkan.

### ● Perhatian

- Telefon anda harus dihidupkan untuk menggunakan fungsi ini.



### ■ View day (Lihat hari)

Menunjukkan nota-nota yang ditetapkan untuk hari terpilih. Gunakan ,  untuk menyemak imbas nota(-nota). Jika anda menetapkan penggera untuk nota, jam penggera dipaparkan. Tekan  [OK] untuk memadam, mengedit, menghantar nota yang anda pilih.

- **Delete (Padam)** : membolehkan anda memadam nota.
- **Edit** : membolehkan anda mengedit nota.
- **Send Note (Hantar Nota)** : membolehkan anda menghantar nota sebagai Mesej Ringkas (SMS). Untuk perincian lihat Messages [Menu 1].

### ■ Make (Buat)

Membolehkan anda menulis nota. Anda boleh memilih jenis-jenis nota yang berikut. Anda boleh mengedit maksimum 40 aksara, dan membuat maksimum 50 jadual.

- **Schedule (Jadual)** : Masukkan masa subjek dan masa penggeraan dan tekan  [OK].
- **Call (Panggilan)** : Masukkan nombor telefon (atau dapatkan dari Buku Telefon), masa dan masa penggeraan dan kemudian tekan  [OK].
- **Memo** : Masukkan subjek dan masa penggeraan dan kemudian tekan  [OK].

- **Anniversary (Ulang Tahun)**

: Masukkan masa subjek dan masa penggeraan dan kemudian tekan  [OK]. Anda boleh memilih satu tajuk dari submenu **BirthDay (Hari Jadi)**, **Wedding (Perkahwinan)**, **Memorial (Peringatan)**, **DII**.

- **Delete (Padam)**



Membolehkan anda memadam untuk nota(-nota) yang terpilih.

- Of Chosen Day (Untuk Hari Terpilih)
- One by One (Satu Persatu)
- All At Once (Semua Sekali Gus)

- **Perhatian**





- Pada tarikh yang terpilih, penggera akan berbunyi dan nota akan dipaparkan.

- **View All (Lihat Semua)**

Memaparkan nota-nota yang ditetapkan untuk semua hari. Gunakan  dan  untuk menyemak imbas nota(-nota). Menekan  [opt] membolehkan akses kepada menu yang sama seperti di dalam 'View Day' ('Lihat Hari')

## **World Time (Masa Sedunia) [Menu 6-2]**





---

Fungsi ini menunjukkan peta dunia, bandar-bandar dan masa tempatan. Masa Semasa dipaparkan menurut format masa (12/24 Jam). Tekan  ,  untuk menukar zon masa dan  ,  untuk menyemak imbas nama-nama bandar. Tekan  [Set] untuk menetapkan masa telefon anda kepada masa tempatan bagi bandar yang terpilih.

## **Calculator (Kalkulator) [Menu 6-3]**

---

Fungsi ini menyokong pengiraan matematik asas seperti campur, tolak, darab dan bahagi.

1. Masukkan nombor-nombor yang ingin anda hitung.
2. Untuk memilih fungsi, gunakan  dan  . Operator yang terpilih akan diserlahkan dengan kursor empat segi. Tekan  [Easy Key] untuk memastikan pilihan anda.
3. Apabila anda selesai membuat pengiraan, anda boleh memilih operator "=" atau kekunci  [Result] untuk melihat hasilnya.

## Unit Convert (Tukar Unit) [Menu 6-4]

---

1. Pilih butiran-butiran menu yang ingin anda tukar.  
**Length (Panjang), Weight (Berat), Volumes (Isi Padu), Surface (Permukaan).**
2. Letakkan nombor-nombor untuk ditukar dengan menggunakan kekunci-kekunci angka.
3. Dan pilih unit yang berkaitan dengan nilai semasa.
4. Akhir sekali pilih unit untuk anda tukar nilai semasa.
5. Nilai dan unit yang diperlukan akan dipaparkan.

## Game (Permainan) [Menu 6-5]

---

Permainan-permainan berikut telah diprogram ke dalam telefon.

- Corsair
- Crazy Race
- Diamond King
- Stone Axe
- Black Jack



### ● Perhatian

Kekunci-kekunci Kawalan adalah berlainan untuk setiap permainan. Tetapi setiap permainan

mempunyai skrin-skrin untuk menerangkan kekunci kawalan utama. Kekunci-kekunci lain yang

sama disebutkan di bawah.

[Fungsi Kekunci Sama]

-  [Soft 1 Key] : Henti Permainan Sebentar
-  [Soft 2 Key] : Teruskan Permainan
-  [Send Key] : Mulakan Permainan, Simpan Skor
-  [Power Key] : Keluar Dari Permainan

## PC Sync

PC Sync ialah program untuk pertukaran data antara PC & Telefon melalui kabel data. Oleh itu, jika anda mahu menggunakan fungsi ini, anda perlu membeli kit aksesori. Untuk perincian lanjut untuk penggunaan panduan rujuk kepada fail bantu PC Sync pada CD PC Sync.

Anda boleh mendail nombor dengan bercakap kepada Telefon GSM anda.



<Tekan enam kali>



## Training (Latihan) [Menu 7-1]

---

Anda boleh memprogram telefon anda supaya mengaitkan tag suara dengan nombor yang akan dimasukkan. Setelah anda memilih menu ini, anda harus menyebut perkataan dalam masa 2 saat, dan telefon akan meminta anda menyebutnya lagi untuk memastikan ketepatan pengenalan suara. Selepas pengenalan suara selesai, anda boleh memasukkan nombor yang berkaitan.

## Search (Cari) [Menu 7-2]

---

Anda boleh menggunakan menu ini untuk mengedit, memadam, dan memastikan suara apa yang ada.



### ■ Voice Search (Cari Suara) [Menu 7-2-1]

Anda boleh mendapatkan nombor yang anda mahu melalui suara. Prosedurnya sama tetapi

hasilnya berlainan. Hasilnya ialah satu lagi menu.

- **Edit voice (Edit Suara)** : Anda boleh menukar tag suara. Ia serupa dengan latihan kecuali memasukkan nombor.
- **Edit number (Edit Nombor)** : Anda boleh menukar nombor. Ia akan memaparkan nombor yang berkaitan dengan tag suara. Selepas mengeditnya, tekan  [OK].
- **Delete (Padam)** : Anda boleh memadam tag suara dan nombor.

### ■ Number Search (Cari Nombor) [Menu 7-2-2]

Anda boleh mendapatkan hanya nombor-nombor yang dirakamkan melalui nombor. Anda tidak perlu menaip semua nombor. Ia akan memaparkan nombor-nombor termasuk bahagian yang hendak ditaipkan. Anda akan mendengar suara dan melihat nombor menggunakan  dan . Anda boleh mendengar suara yang memberi kedudukan nombor dengan menekan  pada tepi telefon. Submenu-submenu adalah sama dengan submenu Voice Search (Cari Suara).

## Voice Dial (Dail Suara) [Menu 7]

### Setting (Tetapan) [Menu 7-3]

---

- **Enable (Upaya)** : Anda boleh memanggil melalui suara jika anda memilih fungsi ini.
- **Disable (Lumpuh)** : Anda tidak boleh memanggil melalui suara.

### Delete all (Padam semua) [Menu 7-4]

---

Menu ini memberi anda keupayaan memadam semua nombor dail suara.

Anda boleh melungsur Internet dan mendapatkan maklumat yang terkini. Maklumat ini terdapat dalam format khas (WAP) yang disesuaikan kepada pilihan-pilihan paparan yang terdapat di dalam telefon. Mengakses Internet mungkin memerlukan pendaftaran dengan Pembekal khidmat anda.



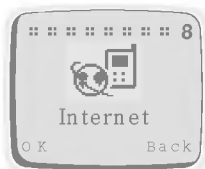

<Tekan tujuh kali>



## Home (Lelaman) [Menu 8-1]



---

Balik ke lelaman. Lelaman boleh jadi tapak yang ditakrifkan di dalam profil aktif oleh pembekal khidmat anda.

Untuk mengaktifkan WAP, sama ada tekan kekunci  beberapa saat dalam mod Tunggu Sedia atau tekan butang  [OK] di dalam menu Home [Menu 8-1].

## Bookmarks (Penanda Buku) [Menu 8-2]

---

Apabila anda memasuki menu ini, senarai peribadi penanda buku anda akan dipaparkan. Anda juga boleh menyimpan penanda buku sehingga 9. Kemudian tekan  [OK] untuk mengakses pilihan yang terdapat, atau tekan  [Back] untuk keluar.

- **Go to (Pergi ke)** : Menggerakkan ke penanda buku yang terpilih.
- **Edit** : Mengedit alamat dan tajuk penanda buku yang terpilih.
- **Erase (Padam)** : Memadam penanda buku yang terpilih dari senarai penanda buku.
- **Add Bookmark (Tambah Penanda Buku)** : Mengedit alamat dan tajuk tapak yang anda ingin tambahkan kepada senarai penanda buku kegemaran anda.

### Profiles (Profil) [Menu 8-3]

---

Paparkan atau masukkan tetapan profil anda sendiri untuk sambungan internet. Anda boleh membuat sehingga 5 profil dan aktifkan pilihan yang diperlukan. Tatal ke profil yang diinginkan dan tekan  [OK] untuk mengakses pilihan-pilihan yang teradapat.

- **Activate** : Aktifkan profil yang terpilih.
- **Setting** : Tetapkan perincian profil :
  - 4 **Profile Name** : edit Profile Name (Nama Profil).
  - 4 **Dial-up Number** : Edit nombor panggilan data.
  - 4 **Call type** : Pilih jenis panggilan.
  - 4 **IP Address** : Edit alamat IP gerbang laluan yang anda ingin membuat sambungan.
  - 4 **IP Port** : Edit nombor port IP gerbang laluan yang anda ingin membuat sambungan.
  - 4 **Log-in name** : Edit nama log masuk leلمان yang ditakrifkan di dalam profil yang terpilih.
  - 4 **Password** : Edit kata laluan leلمان yang ditakrifkan di dalam profil yang terpilih.
  - 4 **Homepage** : Anda boleh mengedit alamat tapak. Alamat ini akan disambungkan apabila anda memilih menu Internet – Home atau mulakan Internet melalui  .

### Empty Cache (Kosongkan Cache) [Menu 8-4]

---

Telefon anda akan membuang kandungan memori Cache.

### ■ Home

Rujuk kepada [Menu 8-1].

### ■ Bookmarks

Rujuk kepada [Menu 8-2].

### ■ Save as Bookmark

Anda boleh menambahkan tapak yang bersambung kepada telefon anda kepada senarai penanda buku di dalam menu ini.

### ■ Go to URL

Menggerakkan ke tapak yang anda perlukan. Di dalam menu ini, anda boleh mengedit alamat tapak.

### ■ Show URL

Di dalam menu ini, ia akan menunjukkan kepada anda URL halaman yang sedang tersambung.

### ■ Reload

Memuat semula halaman yang sedang tersambung.

### ■ Empty Cache

Rujuk kepada [Menu 8-4].

### ■ Exit

Memutuskan sambungan dan keluar dari WAP.

## Bagaimana Menghantar nada DTMF

Sesetengah khidmat telefon (seperti mesin jawab telefon dan kelui) memerlukan telefon anda menghantar nada DTMF (Frekuensi Berbilang Nada Dual), juga dikenali sebagai “nada sentuh”. Ini digunakan untuk menyampaikan kata laluan, nombor-nombor panggil balik, dan sebagainya.

### Aksara Tunggu

---

Untuk mendapatkan aksara tunggu, tekan dan tahan . Paparan menunjukkan **P** untuk tunggu. Telefon sentiasa menterjemahkan **P** sebagai aksara tunggu. Apabila anda mendail nombor yang mengandungi aksara tunggu, telefon anda mendail bahagian pertama nombor (nombor telefon) dan kemudian menunggu panggilan disambungkan sebelum menghantar angka-angka yang selebihnya sebagai nada DTMF.

### Menyoal selidik Mesin Jawab anda (contoh)

---

**Sebagai contoh:** Untuk mendengar semua mesej pada mesin jawab anda (kata laluan 5452) di nombor telefon 12345678, anda boleh memanggil: 12345678P5452. Telefon mendail 12345678 dan menunggu panggilan disambungkan. Apabila tersambung, telefon menghantar 5452 (kata laluan).

### Semasa Panggilan

---

Apabila anda perlu menghantar nada DTMF, tekan sahaja nombor-nombor, kemudian nada DTMF akan dihantar.

## Pilihan Dalam Panggilan

The phone provides a number of control functions that you can use during a call. You cannot utilize all of these functions at all times. Most of the In-Call options are network services. By pressing  [Opt] during a call, the following In-Call options may be available:

### ■ Hold Call (Tahan Panggilan) (bergantung kepada rangkaian)

Semasa panggilan, anda boleh menahan panggilan aktif.

1. Semasa panggilan, tekan  [OK] untuk memasuki Pilihan Dalam Panggilan.
2. Pilih **Hold Call** untuk menahan panggilan aktif.

### ■ Retrieve Call (Dapatkan Semula Panggilan) (bergantung kepada rangkaian)

Jika anda mempunyai panggilan yang sedang ditahan, anda boleh mendapatkan semula panggilan tersebut.

1. Semasa panggilan, tekan  [OK] untuk memasuki Pilihan Dalam Panggilan.
2. Pilih **Retrieve Call** untuk mendapatkan semula panggilan yang ditahan.







### ■ Swap Call (Bertukar-tukar Panggilan) (bergantung kepada rangkaian)

Apabila terdapat panggilan aktif dan panggilan yang ditahan, menu ini menahan panggilan aktif, dan mengaktifkan panggilan yang ditahan. Anda boleh bertukar-tukar seperlunya.

1. Semasa panggilan, tekan  [OK] untuk memasuki "In-Call Option" ("Pilihan Dalam Panggilan").
2. Pilih **Swap Call** untuk bertukar-tukar antara panggilan aktif dan panggilan yang ditahan.

### ■ Conference Call (Panggilan Persidangan) (bergantung kepada rangkaian)

Ciri ini membolehkan sehingga enam orang mengambil bahagian dalam panggilan persidangan (bergantung kepada rangkaian).

1. Semasa dalam panggilan, dial nombor telefon dan tekan . Panggilan pertama akan ditahan.
2. Untuk menyertai peserta persidangan yang pertama dalam panggilan, tekan  [Opt], pilih "conference call", pilih "join" dan tekan  [OK].
3. Untuk menambah peserta baru kepada panggilan, ulang langkah 1 dan 2.
4. Untuk menggugurkan seorang peserta dari panggilan, tekan  [Opt], pilih "conference call", pilih "private" dan tekan  [OK]. Pilih peserta yang ingin anda gugurkan dan tekan .
5. Untuk menamatkan panggilan persidangan, tutup penutup telefon.

# Pilihan Dalam Panggilan

## ■ Disconnect (Putuskan)

Anda boleh memutuskan panggilan yang sedang ditahan, panggilan yang sedang aktif dan semua panggilan dengan menatal ke atas dan ke bawah butiran-butiran menu seperti Active call, Hold call, and All calls.

- Active call (Panggilan Aktif)
- Hold call (Panggilan yang Ditahan)
- All calls (Semua panggilan)

## ■ Mute On

Jika fungsi ini dipilih, pihak yang satu lagi tidak dapat mendengar suara anda tetapi anda boleh mendengar suara pihak yang lain itu. Apabila panggilan diputuskan, Mute Off akan diaktifkan secara automatik. Tetapan Lalai adalah Mute Off.

1. Semasa panggilan, tekan  [Opt] untuk memasuki Pilihan Dalam Panggilan.
2. Pilih **Mute On** untuk membisukan telefon anda.

## ■ Mute Off

Jika fungsi ini dipilih, pihak yang satu lagi boleh mendengar suara anda. Tetapan Lalai adalah Mute Off.

## ■ DTMF On

Jika fungsi ini dipilih, anda boleh menghantar nada-nada DTMF. Tetapan Lalai adalah DTMF ON. Untuk perincian, lihat cara menghantar DTMF.

1. Semasa panggilan, tekan  [Opt] untuk memasuki Pilihan Dalam Panggilan.
2. Pilih **DTMF On** untuk menghantar nada DTMF.

## ■ DTMF Off

Jika fungsi ini dipilih, anda tidak boleh menghantar nada-nada DTMF. Tetapan Lalai adalah DTMF ON.





1. Semasa panggilan, tekan  [Opt] untuk memasuki Pilihan Dalam Panggilan.
2. Pilih **DTMF Off** untuk melarang penghantaran nada DTMF.

## ■ Scratch PAD

Anda boleh mengambil nota (nombor telefon) semasa panggilan sedang berlangsung dengan menggunakan fungsi ini. Selepas memutuskan panggilan, nombor telefon akan dipaparkan pada skrin dan anda boleh menyimpannya di dalam buku telefon dan menyambungkan panggilan dengan menekan .

1. Semasa panggilan, tekan  [Opt] untuk memasuki Pilihan Dalam Panggilan.
2. Pilih **Scratch PAD** untuk mengambil nota (nombor telefon).

## ■ Rakaman

Apabila anda perlu merakamkan panggilan anda, tekan dan tahan  kemudian panggilan anda akan dirakamkan. Untuk menghentikan rakaman, tekan ,  atau tutup sahaja penutup telefon. Untuk memainkan balik rakaman anda, lihat bahagian <Voice Memo> (Memo Suara). Untuk perincian, lihat <Voice Memo>. Semasa panggilan, tekan dan tahan  di sebelah kanan telefon.

## ■ Mesej

Jika anda memilih fungsi ini, anda boleh pergi ke menu mesej [Menu 1]. Untuk perincian lihat <Message> (Mesej) [Menu 1].

1. Semasa panggilan, tekan  [Opt] untuk memasuki Pilihan Dalam Panggilan.
2. Pilih **Message** untuk menghantar mesej.

## ■ SIM SERVICE

Pembekal khidmat anda boleh menawarkan aplikasi khas menerusi kad SIM, seperti perbankan rumah, pasaran saham, dll. Jika anda berdaftar untuk salah satu khidmat-khidmat ini, nama khidmat akan muncul di akhir Menu Utama. Dengan menu SIM Services telefon anda siap sedia untuk masa depan dan akan menyokong tambahan-tambahan kepada khidmat-khidmat pembekal khidmat anda. Untuk maklumat lanjut hubungi pembekal perkhidmatan anda.

Untuk dapat menggunakan khidmat data atau faks, anda memerlukan perisian komunikasi seperti program data atau faks. Sebelum menggunakan fungsi-fungsi ini, anda perlu menyambungkan telefon anda kepada komputer atau memastikan telefon anda disambungkan kepada peranti yang serasi.

## Membuat Panggilan Data atau Faks

---

Untuk menggunakan khidmat data atau faks, pastikan mod panggilan ialah "single mode" (mod tunggal). (Setting → Call Setting → Call Mode → Single Mode). Dalam mod ini, anda boleh berkomunikasi dengan suara, data atau faks. Jika anda menetapkan mod panggilan sebagai "voice & fax mode" (Setting → Call Setting → Call Mode → Voice & Fax mode), anda boleh menghantar suara dan faks tanpa melepaskan panggilan suara.

### ■ Menghantar panggilan data atau faks

1. Sambungkan komputer anda kepada telefon.
2. Selepas memulakan perisian komunikasi, buat panggilan dan hantar data atau faks.
3. Selepas penghantaran data atau faks, anda boleh menamatkan panggilan dengan hanya menamatkan perisian komunikasi, menekan  atau dengan menutup penutup telefon.

### ■ Menerima panggilan data atau faks

1. Sambungkan komputer anda kepada telefon.
2. Selepas memulakan perisian komunikasi, terima panggilan dan terima data atau faks.
3. Selepas penerimaan data atau faks, anda boleh menamatkan panggilan dengan hanya menamatkan perisian komunikasi, menekan  atau dengan menutup penutup telefon.

## Membuat Panggilan Suara & Faks(making a voice&fax call)



---

Dalam mod ini, anda boleh menghantar suara dan juga faks tanpa melepaskan panggilan suara.

### ● Perhatian

- Mod ini adalah ciri rangkaian. Jika rangkaian tidak menyokong mod ini, anda tidak boleh menggunakan panggilan suara & faks.

## ■ Menghantar panggilan suara dan faks

1. Sambungkan komputer anda kepada telefon.
2. Pilih Voice and Fax mode. Voice and fax mode membolehkan anda bertukar-tukar dari mod suara kepada mod faks semasa panggilan.
3. Jika mesej **Selected** dipaparkan pada telefon, ia telah bersedia untuk penghantaran.
4. Masukkan atau dapatkan semula nombor telefon yang diingini dan tekan  .
5. Selepas penghantaran suara, anda boleh memulakan penghantaran faks.
6. Selepas penghantaran faks, anda boleh menamatkan panggilan dengan hanya menamatkan perisian faks, menekan  atau dengan menutup penutup telefon.



## ■ Menerima panggilan suara dan faks

1. Sambungkan komputer anda kepada telefon.
2. Selepas penghantaran suara, anda boleh menjawab panggilan faks dengan memulakan program perisian (jika ia tidak menjawab secara automatik).

Ciri-ciri memo suara membolehkan anda merakamkan sehingga 3 mesej suara dan setiap satu sehingga 30 saat. Ini berguna apabila anda tidak mempunyai pen dan kertas untuk mencatatkan arah atau mesej.





## Memo Suara

---

1. Untuk menggunakan fungsi ini, tekan  [Record Key] untuk masa yang lama semasa panggilan atau dalam mod tunggu sedia.
2. Rakaman dimulakan dan paparan akan menunjukkan mesej **Recording** dan masa rakaman.
3. Jika anda mahu menyelesaikan rakaman, tekan  [Record Key] sebentar.

## Menu Memo Suara

---

Telefon memaparkan maklumat memo suara yang termasuk masa dan tarikh rakaman dengan menekan  [Record Key] sebentar. Selepas anda memilih memo dengan menggunakan  dan  , tekan  [Opt], anda boleh lihat menu ini.

### ■ Play [Voice Memo Menu 1]

Anda boleh memainkan memo suara yang terpilih di dalam menu ini. Anda juga boleh mendengarkan memo suara menerusi speaker di belakang telefon.

### ■ Delete [Voice Memo Menu 2]

Anda boleh memadam memo suara yang terpilih.

### ■ Delete All [Voice Memo Menu 3]

Telefon anda akan memadam semua memo suara yang dirakam.

**Apabila menggunakan unit ini, langkah-langkah berhati-hati keselamatan yang asas seperti berikut harus sentiasa dipatuhi.**

- Jangan sentuh penyesuai dengan tangan yang basah.
- Jangan buka bahagian-bahagian unit ini. (Bawa ia kepada seorang juruteknik servis yang berkelayakan apabila kerja pembaikan diperlukan.)
- Jauhkan dari alat elektrik seperti TV, radio atau komputer peribadi.
- Unit ini harus dijauhkan dari sumber-sumber haba seperti penyinar atau alat memasak.
- Jangan jatuhkan.
- Lindungi unit ini daripada getaran atau kejutan mekanikal.
- Salutan telefon boleh rosak jika dibalut dengan pembalut vinil.
- Gunakan kain kering untuk membersihkan bahagian luar unit. (Jangan gunakan pelarut seperti benzena, pencair atau alkohol.)
- Jangan dedahkan unit ini kepada asap atau habuk yang berlebihan.

## ■ Menjaga Bateri

- Pastikan bateri anda dicas sepenuhnya sebelum digunakan.
- Anda tidak perlu menyahcas bateri sepenuhnya sebelum mengecap semula. Tidak seperti sistem-sistem bateri lain, tidak terdapat kesan memori yang dapat menjejaskan prestasi bateri.
- Gunakan hanya bateri-bateri dan pengecas-pengecas LG. Pengecas-pengecas LG direka bentuk untuk memaksimumkan hayat bateri.
- Jangan buka atau litar pintas pek bateri.
- Pastikan sentuhan-sentuhan logam pek bateri sentiasa bersih.
- Gantikan bateri apabila ia tidak lagi memberi prestasi yang boleh diterima. Pek bateri boleh dicas semula beratus-ratus kali sehingga ia perlu diganti.
- Cas semula bateri jika ia tidak digunakan buat masa yang lama untuk memaksimumkan penggunaannya.
- Jangan dedahkan pengecas bateri kepada cahaya matahari langsung atau gunakan ia dalam suasana kelembapan tinggi, seperti di dalam bilik air.
- Jangan tinggalkan bateri di tempat yang panas atau sejuk; ini boleh melemahkan prestasi bateri.

# Data Teknikal

## Umum

---

Nama Produk : LG-600

Sistem : GSM 900/DCS 1800

Kad SIM : Kad palam masuk kecil, jenis 3V atau 5V

## Dimensi

---

Saiz : 80 X 44 X 25 mm

Berat dengan Bateri Biasa : 90.4g

## Suhu Ambien

---

Maks : +55°C

Min : -10°C.