



MALAY
简体中文
ENGLISH

Telefon GPRS

BUKU PANDUAN PENGGUNA

MODEL : G7020

Sila baca buku panduan ini dengan teliti
sebelum menggunakan telefon anda.
Simpan ia untuk rujukan pada masa hadapan.



P/NO : MMBB0079805

ISSUE 1.0
PRINTED IN KOREA





Telefon GPRS

BUKU PANDUAN PENGGUNA

MODEL : G7020

Sila baca buku panduan ini dengan teliti sebelum menggunakan telefon anda. Simpan ia untuk rujukan pada masa hadapan.

G7020 mempunyai gaya yang memberikan pengguna lebih keselesaan dan kemudahan.

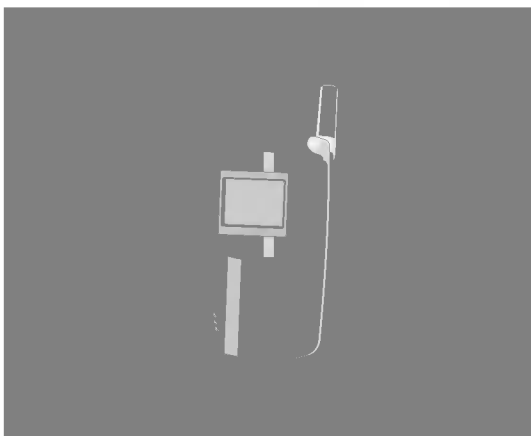

Untuk Keselamatan Anda

Semua pemancar radio membawa risiko gangguan dengan barangan elektronik yang berdekatan.



Telefon-telefon GSM mestilah sentiasa dimatikan di dalam kapal terbang.



Elakkan daripada menghalakan port inframerah yang aktif ke mata.



Jangan aktifkan berdekatan dengan stesen minyak, depo bahan bakar, loji kimia atau operasi peletupan.



Matikan telefon di sebarang tempat di mana peraturan-peraturan khas menghendakinya. Sebagai contoh, telefon tidak dibenarkan digunakan di hospital kerana perentak jantung dan alat bantuan pendengaran boleh terjejas.



Sedikit gangguan mungkin menjejaskan TV, radio, PC, dan lain-lain.



Jangan pegang telefon di dalam tangan semasa memandu.



Jangan buka bahagian-bahagian telefon atau bateri.



Simpan telefon di tempat yang selamat jauh dari jangkauan kanak-kanak kerana ia mengandungi bahagian-bahagian kecil yang boleh ditanggalkan dan menimbulkan bahaya tercekik.



Jangan sentuh pengecas dengan tangan yang basah.



Gunakan hanya bateri dan pengecas yang ditentukan kerana bateri dan pengecas lain boleh merosakkan telefon.

Sila ambil perhatian:



Bateri yang tidak boleh digunakan harus dibuang menurut undang-undang yang berkenaan.



Gunakan hanya aksesori ASLI bagi mengelakkan kerosakan pada telefon anda.



Panggilan kecemasan mungkin tidak boleh dibuat pada semua rangkaian selular. Oleh itu, anda tidak harus bergantung semata-mata kepada telefon ini untuk komunikasi penting seperti kecemasan perubatan.

Maklumat Penting

Panduan pengguna ini mengandungi maklumat penting mengenai penggunaan dan operasi telefon ini. Sila baca semua maklumat dengan teliti untuk prestasi optimum dan untuk mengelakkan sebarang kerosakan atau penyalahgunaan telefon ini. Sebarang perubahan atau pengubahsuaian yang tidak diluluskan dengan nyata di dalam panduan pengguna ini boleh mentaksahkan waranti anda untuk alat ini.

Contents

Gambaran keseluruhan

Aksesori	9
Bahagian Telefon	10
• Bahagian Depan Telefon	10
• Bahagian Belakang Telefon	11
• Sub LCD telefon	11
Penerangan Kekunci	12
• Side of the Key	13
• Kekunci Abjad Angka	13

Maklumat Paparan

Maklumat Paparan	14
• Ikon-Ikon Pada Skrin	14

Bermula

Pemasangan	16
• Menyisipkan Kad SIM	16
• Memasang Bateri	16
• Mengecas Bateri	17
• Memutuskan sambungan pengecas	18
Urutan Menghidupkan Telefon	19
• Untuk mula menggunakan telefon	19
• Untuk mematikan telefon	19
Kod Akses	20
• Kod PIN (4 hingga 8 angka)	20
• Kod PIN2 (4 hingga 8 angka)	20
• Kod PUK (4 hingga 8 angka)	20
• Kod PUK2 (4 hingga 8 angka)	20
• Kod Keselamatan (4 hingga 8 angka)	20
Membuat dan Menjawab panggilan	21
• Membuat panggilan	21
• Membuat panggilan menggunakan  [Kekunci hantar]	21
• Panggilan Antarabangsa	21
• Membuat panggilan menggunakan Buku telefon	21
• Membuat panggilan melalui Dail cepat.	21

Penerangan Menu

Buku Telefon	22
Pohon Menu	23
Mesej [Menu 1]	24
• Tulis mesej [Menu 1-1]	24
• Kotak masuk [Menu 1-2]	28
• Kotak keluar [Menu 1-3]	29
• Servis maklumat [Menu 1-4]	29
• Mesej suara [Menu 1-5]	31
• Laporan kiriman [Menu 1-6]	31
• Templat [Menu 1-7]	31
• Aturan [Menu 1-8]	31
• Padam semua [Menu 1-9]	32
Daftar panggilan [Menu 2]	33
• Panggilan terlepas [Menu 2-1]	33
• Panggilan diterima [Menu 2-2]	33
• Panggilan didail [Menu 2-3]	34
• Padam panggilan terkini [Menu 2-4]	34
• Tempoh panggilan [Menu 2-5]	34
• Kos panggilan [Menu 2-6]	35
• Tetapan panggilan [Menu 2-7]	36
• Maklumat GPRS [Menu 2-8]	36
Profil [Menu 3]	37
• Getaran shj [Menu 3-1]	37
• Senyap [Menu 3-2]	37
• Am [Menu 3-3]	37
• Kuat [Menu 3-4]	38
• Set kepala [Menu 3-5]	38
• Kereta [Menu 3-6]	38
Aturan [Menu 4]	40
• Jam loceng [Menu 4-1]	40
• Tarikh & Masa [Menu 4-2]	41
• Aturan telefon [Menu 4-3]	42
• Aturanpanggilan [Menu 4-4]	43
• Aturan sekuriti [Menu 4-5]	46
• Aturan jaringan [Menu 4-6]	49
• Aturan GPRS [Menu 4-7]	49
• Kembalikan tetapan kilang [Menu 4-8]	49

Alihan panggilan [Menu 5]	50
• Panggilan semua suara [Menu 5-1]	50
• Jika sibuk [Menu 5-2]	50
• Jika tak jawab [Menu 5-3]	50
• Jika tak sampai [Menu 5-4]	50
• Panggilan semua data [Menu 5-5]	50
• Panggilan semua faks [Menu 5-6]	51
• Batal semua pesongan [Menu 5-7]	51
Penyelenggara [Menu 6]	52
• Jadual [Menu 6-1]	52
• Memo [Menu 6-2]	53
• Buku telefon [Menu 6-3]	53
Mainan & Utiliti [Menu 7]	59
• Permainan [Menu 7-1]	59
• Fail saya [Menu 7-2]	59
• Pengubah unit [Menu 7-3]	60
• Kalkulator [Menu 7-4]	60
• Masa dunia [Menu 7-5]	61
• Perakam suara [Menu 7-6]	61
• Inframerah [Menu 7-7]	61
Internet [Menu 8]	62
• Rumah [Menu 8-1]	62
• Penanda [Menu 8-2]	62
• Alihkan mesej [Menu 8-3]	63
• Profil [Menu 8-4]	63
• Pergi ke URL [Menu 8-5]	65
• Aturan Cache [Menu 8-6]	65
• Maklumat WAP [Menu 8-7]	65
• Reset profil [Menu 8-8]	65
Penerangan Menu	66
Khidmat SIM [Menu 9]	67
Penjagaan dan Penyelenggaraan	68
Data Teknikal	70

Periksa bagi memastikan anda mempunyai semua bahagian yang ditunjukkan di bawah.

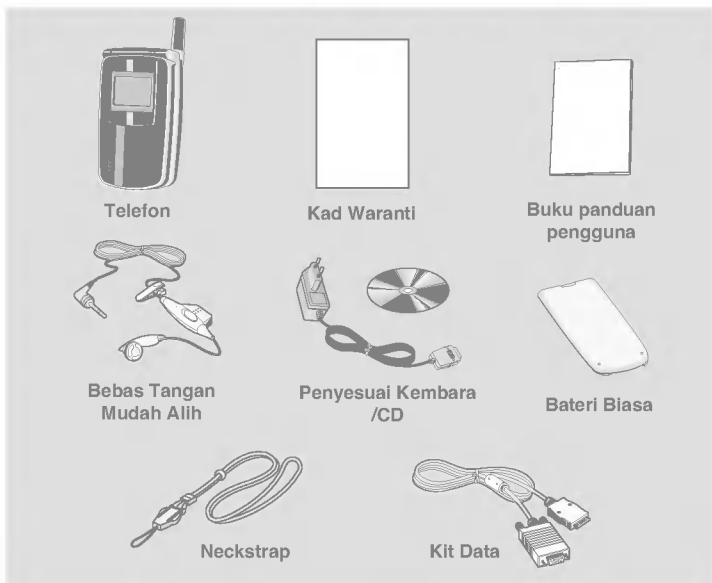

<Aksesori Pilihan>

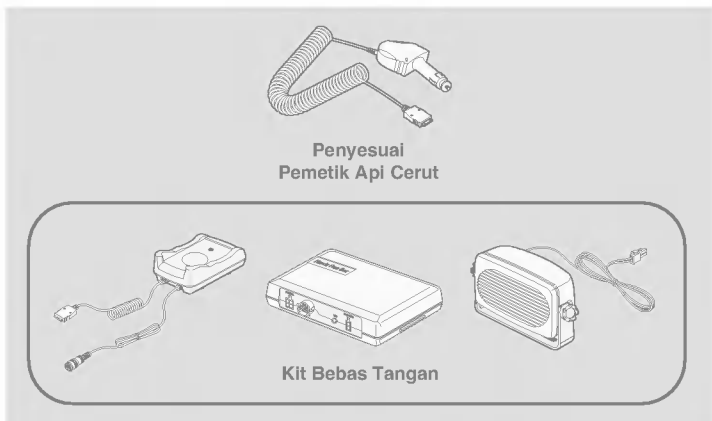

Bahagian Depan Telefon

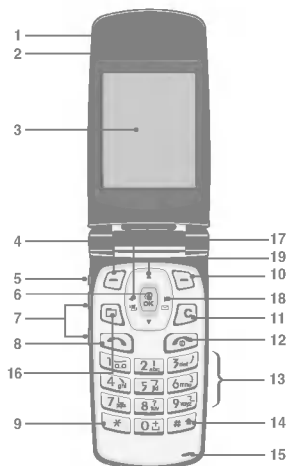

- | | |
|---------------------------|--------------------------------|
| 1 Cuping Telinga | 11 Kekunci Padam |
| 2 Pelipat Aktif | 12 Kekunci TAMAT/KUASA |
| 3 Skrin Paparan | 13 Kekunci Angka |
| 4 Kekunci Kiri Lembut | 14 Kekunci Dwipangkah |
| 5 Kekunci Rakam | 15 Mikrofon |
| 6 Kekunci Pengesahan | 16 Kekunci Penanda buku |
| 7 Kekunci Tepi Atas/Bawah | 17 Kekunci oandu arah kanan |
| 8 Kekunci Hantar | 18 Kekunci Pandu Arah |
| 9 Kekunci Bintang | 19 Kekunci -Kekunci Pandu Arah |
| 10 Kekunci Kanan Lembut | |

Bahagian Belakang Telefon

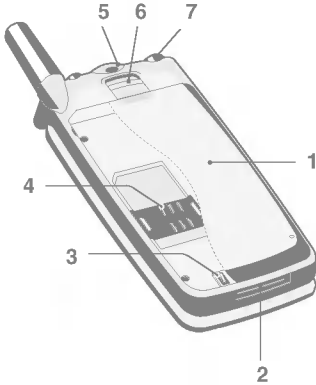

- 1 Bateri
- 2 Penyambung Kabel Pengcasan Bateri Penyambung Kit Kereta Bebas Tangan
- 3 Terminal-Terminal Bateri
- 4 Soket Kad SIM
- 5 Lubang Tali Bimbit
- 6 Kunci Bateri
- 7 Penyambung

Sub LCD telefon



Anda boleh melihat ikon menerima mesej teks atau mel suara walaupun tanpa membuka pelipat. Selain itu, anda boleh memeriksa nama dan nombor untuk panggilan masuk.

● **Perhatian!**

- Jika nama atau nombor entri tidak disimpan di dalam buku telefon, "Panggilan baru" akan dipaparkan apabila anda menerima panggilan.

Berikut ditunjukkan komponen-komponen kekunci telefon.

Penerangan Kekunci

Kekunci

Kekunci Kiri Lembut / Kekunci Kanan Lembut



Setiap daripada kekunci-kekunci ini melaksanakan fungsi yang ditunjukkan oleh teks pada paparan di atas kekunci tersebut.

Kekunci-Kekunci Pandu Arah

Kekunci pandu arah kiri

Digunakan untuk kekunci penting Profil dan kekunci pilihan Menu.

Kekunci pandu arah kanan

Digunakan untuk kekunci penting Mesej dan kekunci pilihan Menu.

Kekunci pandu arah atas/bawah

Digunakan untuk mencari nama di dalam Buku telefon dan kekunci pilihan Menu.

Kekunci mengesah

Anda boleh pergi langsung ke WAP jika anda menekan kekunci ini untuk masa yang lama.



Kekunci Penanda buku / Kekunci Padam



Anda boleh pergi langsung ke menu penanda buku dengan menekan . Anda boleh memadam aksara-aksara yang anda masukkan dengan menekan .

Kekunci Hantar



Anda boleh mendail nombor telefon dan menjawab panggilan. Jika anda menekan kekunci ini tanpa memasukkan nombor, telefon anda akan memaparkan nombor-nombor yang paling baru didail, diterima dan tidak dijawab.

Kekunci Angka

Kekunci-kekunci ini selalunya digunakan untuk mendail dalam mod tunggu sedia dan memasukkan nombor atau aksara dalam mod mengedit. Apabila anda menekan kekunci-kekunci ini untuk masa yang lama.



?





- Digunakan untuk panggilan antarabangsa dengan .
- Digunakan untuk memanggil nombor-nombor Dail cepat dari hingga .
- Digunakan untuk memeriksa mel suara dengan .

Kekunci TAMAT/KUASA



Digunakan untuk menamatkan atau menolak panggilan. Kekunci ini juga digunakan sebagai Kekunci Kuasa. Menekan dan menahan kekunci ini untuk beberapa saat.

Side of the Key

Kekunci	
	Kekunci Tepi Atas/Bawah Anda boleh mengawal kelantangan nada kekunci dalam mod tunggu sedia dan juga mengawal kelantangan semasa panggilan.
	Kekunci Rakam Anda boleh menggunakan memo suara dengan menekan dan menahan kekunci ini untuk beberapa saat. Apabila pelipat ditutup, anda boleh menolak panggilan jika anda menekan kekunci ini.

Kekunci Abjad Angka

Hubungan pemetaan pad kekunci abjad dan angka disenaraikan seperti jadual berikut.

Kekunci	
	. ! ' 1 , - ? @ _
	A B C 2 Ä Å Á Â Ã Æ Ç a b c ä å á â ã ä ç
	D E F 3 È É Ê Ë d e f è é ê ë
	G H I Ì Í Î Ñ Ğ 4 g h i ì í î ñ
	J K L 5 j k l
	M N O 6 Ñ Ö Õ Ò Ó Ô Õ m n o ñ ö õ ó ô õ ö
	P Q R S \$ 7 p q r s \$ B
	T U V 8 Ü Ú Û Ü t u v ü ú û ü
	W X Y Z 9 w x y z
	0, ø [Kekunci Ruang]

Skrin memaparkan beberapa ikon dan berikut diterangkan setiap satu ikon yang anda mungkin lihat pada telefon.

Ikon-Ikon Pada Skrin

Ikon/Penunjuk	
	Memberitahu anda kekuatan isyarat rangkaian.
	Panggilan disambungkan.
	Menunjukkan bahawa anda sedang menggunakan khidmat rayau.
	Penggera telah ditetapkan dan sedang aktif.
	Memberitahu anda status bateri.
	Anda telah menerima satu mesej teks.
	Anda telah menerima satu mesej suara bergantung kepada langganan anda.
	Semua isyarat yang dapat didengar dimatikan.
	Anda telah menerima satu E-mel.
	Menu kuat di dalam profil audio.
	Menu perlahan di dalam profil audio.
	Menu Alat dengar di dalam profil audio.
	Menu kereta di dalam profil audio.
	General menu in profiles.
	Menunjukkan bahawa anda sedang menggunakan khidmat rayau.
	You can set your own schedule.

Ikon-Ikon Menu Atas

Ikon	
	Mesej
	Daftar panggilan
	Profil
	Aturan
	Alihan panggilan
	Penyelenggara
	Mainan & Utiliti
	Internet
	Khidmat SIM

1 Menyisipkan Kad SIM

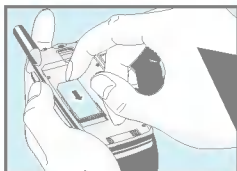

Cari soket kad SIM di belakang telefon. Ikut langkah-langkah di bawah untuk memasang kad SIM.

1. Tanggalkan bateri jika ia terpasang.
2. Gelongsorkan kad SIM ke dalam lubang alur, di bawah pemegang-pemegang perak, dengan penyambung-penyambung emas menghadap bawah dan sudut terpotong di sebelah kanan.

● Notis

- Sebelum memasang pastikan bahawa telefon dimatikan dan tanggalkan bateri.
- Sentuhan logam kad SIM mudah rosak disebabkan tercalar. Beri perhatian khusus pada kad SIM apabila anda memegang dan memasang. Ikut arahan yang dibekalkan dengan kad SIM.

2 Memasang Bateri

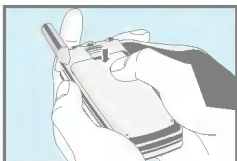

1. Letakkan bateri di belakang telefon.
2. Tolak ia sehingga anda mendengar bunyi klik.

3 Mengecas Bateri

Untuk menyambungkan penyesuai kembara kepada telefon, anda mestilah memasang bateri.

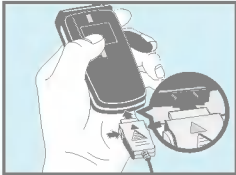

1. Masukkan satu hujung penyesuai kembara ke dalam bahagian bawah telefon.

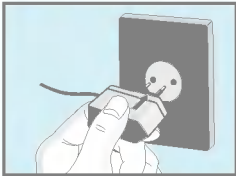

2. Sambungkan hujung penyesuai kembara yang satu lagi kepada soket dinding AC. Gunakan hanya pengecas yang disertakan di dalam bungkusan.



● Amaran

- Jangan paksa penyambung kerana ini boleh merossakkan telefon dan/atau penyesuai kembara.

4 Memutuskan sambungan pengecas

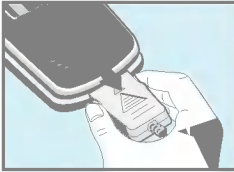

Putuskan sambungan penyesuai kembara dari telefon dengan menekan butang-butang tepinya.

● Notis

- Bateri yang dihantar bersama telefon anda perlu dicas sepenuhnya sebelum digunakan.
- Jangan tanggalkan bateri anda atau kad SIM semasa mengecas.
- Palang-palang bergerak ikon bateri akan berhenti selepas bateri dicas sepenuhnya.
- Semasa mengecas telefon, anda boleh memeriksa status bateri melalui warna LED penunjuk. [Cas penuh: Biru, Sedang mengecas: Merah]

● Perhatian

- Sekiranya bateri tidak dicas dengan betul...
 1. Selepas menekan kekunci Menghidupkan/Mematikan, cubalah mengecas ia semula.
 2. Sekiranya bateri terpasang, sila tanggalkan ia dari telefon. Dan kemudian letakkan ia balik, dan cuba cas ia semula.

1 Untuk mula menggunakan telefon

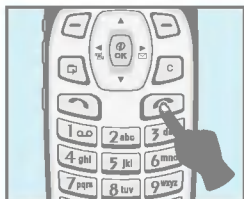

1. Tekan dan tahan  [Kekunci Kuasa/Tamat] sehingga anda dengar bunyi satu nada.
2. Bergantung kepada tetapan **Permintaan kod PIN** [Menu 4-5-1], anda boleh memasukkannya atau pun tidak.
3. Jika telefon menyambung kepada rangkaian, nama rangkaian akan dipaparkan sejeurus kemudian.

2 Untuk mematikan telefon

Dalam mod tunggu sedia, tekan dan tahan kekunci  sehingga anda dengar bunyi satu nada.

Anda boleh menggunakan kod-kod akses yang diterangkan di dalam bahagian ini untuk mengelakkan penggunaan telefon anda tanpa izin. Kod-kod akses (kecuali kod PUK dan PUK2) boleh ditukar dengan menggunakan [Menu 4-5-4].

Kod PIN (4 hingga 8 angka)

Kod PIN (Nombor Pengenalan Peribadi) melindungi kad SIM anda daripada digunakan tanpa izin. Kod PIN biasanya dibekalkan dengan kad SIM. Apabila permintaan **PIN code** ditetapkan ke **Enable**, telefon anda akan meminta kod PIN setiap kali ia dihidupkan. Sebaliknya, apabila **PIN code** ditetapkan ke **Disable**, telefon anda akan menyambung langsung kepada rangkaian tanpa meminta kod PIN.

Kod PIN2 (4 hingga 8 angka)

Kod PIN2, dibekalkan dengan sesetengah kad SIM, diperlukan bagi mengakses beberapa fungsi seperti Pemberitahuan caj panggilan, Nombor Dail tetap. Fungsi-fungsi ini hanya terdapat jika disokong oleh kad SIM anda.

Kod PUK (4 hingga 8 angka)

Kod PUK (Kunci Nyah-Halang Peribadi) diperlukan bagi menukar kod PIN yang terhalang. Kod PUK boleh dibekalkan dengan kad SIM. Jika tidak, hubungi pembekal khidmat setempat anda untuk kod tersebut. Jika anda kehilangan kod, hubungi juga pembekal khidmat anda.

Kod PUK2 (4 hingga 8 angka)

Kod PUK2, dibekalkan dengan sesetengah kad SIM, diperlukan bagi menukar kod PIN2 yang terhalang. Jika anda kehilangan kod, hubungi juga pembekal khidmat anda.

Kod Keselamatan (4 hingga 8 angka)

Kod keselamatan melindungi telefon anda daripada digunakan tanpa izin. Ia biasanya dibekalkan dengan telefon. Kod ini diperlukan untuk memadam semua entri telefon dan untuk mengaktifkan menu "Kembalikan tetapan kilang". Nombor lalainya ialah "0000". Anda juga boleh menukar ia di dalam menu tetapan Keselamatan.

Membuat panggilan

1. Masukkan nombor telefon termasuk kod kawasan, Untuk mengedit nombor di paparan, tekan (←, →) untuk menggerakkan kursor ke kiri dan tekan untuk menggerakkan kursor ke kanan.
2. Tekan (↩) untuk memanggil nombor tersebut.
3. Tekan (⏏) untuk menamatkan panggilan.

Membuat panggilan menggunakan (↩) [Kekunci hantar]

1. Tekan (↩) [Kekunci hantar], dan kemudian anda boleh memeriksa nombor-nombor telefon yang paling baru tidak dijawab, diterima, dan didail.
2. Pilih nombor yang anda mahu pada senarai.
3. Tekan (↩) [Kekunci hantar].

Panggilan Antarabangsa

1. Tekan dan tahan kekunci (0+) untuk awalan antarabangsa. Aksara “+” mungkin menggantikan kod akses antarabangsa.
2. Masukkan kod negara, kod kawasan, dan nombor telefon.
3. Tekan (↩) .

Membuat panggilan menggunakan Buku telefon



1. Dalam mod tunggu sedia, tekan (🔍) [Nama].
2. Apabila menu dipaparkan, anda pilih **Cari** dengan menekan (OK) [OK].
3. Jika anda mendapati butir yang diinginkan menerusi pencarian melalui nama atau nombor, tekan (↩) untuk memanggil.

Membuat panggilan melalui Dail cepat

Lihat menu **Buku telefon – Dail laju** [Menu 6-3-4] untuk perincian.



Untuk memilih menu di dalam buku telefon, tekan  [Nama] dalam mod tunggu sedia dan kemudian tatal ke butir yang diinginkan. Anda juga boleh Penerangan Menu ini melalui **Penyelenggara**.

1	Cari	Membolehkan anda mencari nama tertentu.
2	Tambah baru	Membolehkan anda menambah nama-nama dan nombor-nombor baru.
3	Kump.pemanggil	Membolehkan anda memaparkan senarai kumpulan, dan memilihnya. Anda boleh mengedit namanya, dan menetapkan deringan, ikon warna LED untuk setiap Kumpulan.
4	Dail laju	Membolehkan anda memberi sehingga 8( - ) peruntukan dail satu sentuh.
5	Set Memori	Membolehkan anda memilih memori.
6	Padam semua	Membolehkan anda memadam semua data di dalam memori SIM atau Telefon.
7	Salin semua	Membolehkan anda menyalin entri-entri dari memori Telefon anda ke kad SIM atau dari kad SIM ke memori Telefon.
8	Maklumat	Membolehkan anda memeriksa status memori, No.dail diservis dan Nombor sendiri.



1 Mesej

- 1 Tulis mesej
- 2 Kotak masuk
- 3 Kotak keluar
- 4 Servis maklumat
- 5 Mesej suara
- 6 Laporan kiriman
- 7 Templat
- 8 Aturan
- 9 Padam semua



2 Daftar panggilan

- 1 Panggilan terlepas
- 2 Panggilan diterima
- 3 Panggilan didail
- 4 Padam panggilan terkini
- 5 Tempoh panggilan
- 6 Kos panggilan
- 7 Tetapan panggilan
- 8 Maklumat GPRS



3 Profil

- 1 Getaran shj
- 2 Senyap
- 3 Am
- 4 Kuat
- 5 Set kepala
- 6 Kereta



4 Aturan

- 1 Jam loceng
- 2 Tarikh & Masa
- 3 Aturan telefon
- 4 Aturan panggilan
- 5 Aturan sekuriti
- 6 Aturan jaringan
- 7 Aturan GPRS
- 8 Kembalikan tetapan kilang



5 Alihan panggilan

- 1 Panggilan semua suara
- 2 Jika sibuk
- 3 Jika tak jawab
- 4 Jika tak sampai
- 5 Panggilan semua data
- 6 Panggilan semua faks
- 7 Batal semua pesongan



6 Penyelenggara

- 1 Jadual
- 2 Memo
- 3 Buku telefon



7 Mainan & Utiliti

- 1 Permainan
- 2 Fail saya
- 3 Pengubah unit
- 4 Kalkulator
- 5 Masa dunia
- 6 Perakam suara
- 7 Inframerah



8 Internet

- 1 Rumah
- 2 Penanda
- 3 Alihkan mesej
- 4 Profil
- 5 Pergi ke URL
- 6 Aturan Cache
- 7 Maklumat WAP
- 8 Reset profil



9 Khidmat SIM

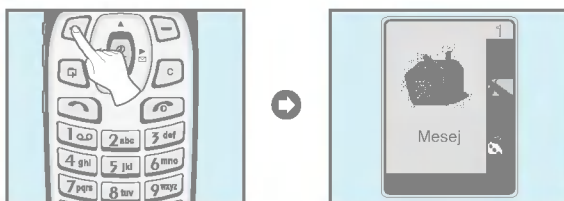

Menu ini bergantung kepada SIM dan khidmat-khidmat rangkaian.



Menu ini termasuk fungsi-fungsi yang berkaitan dengan SMS (Khidmat Mesej Ringkas), mel suara, serta mesej-mesej khidmat rangkaian.



Tulis mesej [Menu 1-1]

Anda boleh menulis dan mengedit mesej teks sehingga 480 aksara.

1. Masukkan menu **Mesej** dengan menekan  [OK].
2. Jika anda mahu menulis mesej baru, pilih **Tulis mesej** di dalam menu.
3. Masukkan mesej.
4. Setelah anda selesai menulis mesej, tekan  [Pilihan]. Menu pilihan berikut akan dipaparkan.



Hantar

Menghantar mesej teks.

1. Masukkan nombor telefon untuk menghantar mesej.
2. Tekan  [OK]. Jika anda tidak mahu menghantarnya, tekan  [Kembali].

Simpan

Menyimpan mesej di dalam Peti keluar.

Jika anda mahu menyimpannya di dalam Peti keluar, tekan  [OK].
Jika anda tidak mahu, tekan  [Kembali].

Masuk templat

Templat ialah mesej yang telah dipraktakrif. Anda boleh memilih satu daripada templat-templat dan tambahkan ia kepada mesej yang akan anda hantar.

Fungsi EMS

Anda boleh menggunakan EMS hanya jika rangkaian menyokong khidmat ini.

Lampir gambar

Jika anda mahu melampirkan gambar apabila menghantar mesej, anda boleh memilihnya menerusi EMS. Anda juga boleh memilih satu daripada pelbagai gambar.

Lampir animasi

Jika anda mahu melampirkan animasi apabila menghantar mesej, anda boleh memilihnya menerusi EMS. Selain itu, anda boleh memilih satu daripada 15 animasi yang anda mahu.

Lampir bunyi

Jika anda mahu melampirkan bunyi apabila menghantar mesej, anda boleh memilihnya menerusi EMS.



● Perhatian

- Anda tidak boleh menghantar atau menerima mesej menerusi EMS disebabkan ketakserasian antara telefon G7020 dan telefon-telefon lain.

Kamus eZi

Anda boleh menambah, memadam dan mengedit perkataan di dalam kamus eZi. Jika anda menyimpannya di dalam kamus, perkataan ini mempunyai keutamaan yang lebih tinggi daripada perkataan-perkataan lain.

• Bagaimana menambah perkataan di dalam kamus

1. Tatal untuk menyerlahkan **Kamus eZi**.
2. Mesej **<Tidak boleh masuk>** akan dipaparkan apabila tiada perkataan yang di simpan. Setelah sesuatu perkataan disimpan di dalam kamus, anda boleh melihat senarai perkataan.
3. Tekan .
4. After entering a word, press  [OK].

• Bagaimana memadam perkataan dari kamus

1. Tatal untuk menyerlahkan **Kamus eZi**.
2. Pilih perkataan yang ingin anda padam, dan kemudian tekan  [Pilihan].
3. Pilih menu **Padam**.

• Bagaimana mengedit perkataan di dalam kamus

1. Tatal untuk menyerlahkan **Kamus eZi**.
2. Pilih perkataan yang ingin anda edit dan kemudian tekan  [Pilihan].
3. Pilih menu **Edit**.

Bagaimana menggunakan teks eZi





Mod teks eZi membolehkan anda menaip perkataan dengan mudah dan cepat. Hanya dengan menekan kekunci sekali untuk setiap aksara, anda boleh mendapatkan perkataan yang anda mahu. Oleh itu, anda tidak perlu memasukkan semua aksara untuk membuat perkataan.

• Bagaimana menukar mod







Terdapat 4 mod. : **Mod eZi, Mod angka, Mod huruf (Huruf besar dan Huruf kecil)**. Anda boleh menukar dan memilih salah satu daripada mod-mod editor dengan menekan .

• Bagaimana menggunakan mod eZi







1. Pilih **Mesej** dengan menekan  [OK].
2. Tatal ke **Tulis mesej** dengan menekan  [OK].
3. Dalam mod teks eZi, anda hanya menekan kekunci yang bertandakan sesuatu aksara pada pad kekunci. Selain itu, anda boleh menambah ruang dengan menekan kekunci .
4. Selepas menulis mesej, tekan  [OK].
5. Jika anda mahu menghantar atau menyimpan mesej, tekan  [Pilihan].

● Sebagai contoh

Untuk membuat "Tomorrow", anda hanya menekan    →  →  →  mengikut urutan.

● Notis

1. Anda boleh menukar bahasa dengan kekunci .
2. Setelah anda menekan kekunci yang sepadan, kekunci  akan bertukar kepada "Tukar". Kemudian anda boleh menukar bentuk huruf besar dengan  [Tukar] Sebagai contoh : you → y.o.u. → Y.O.U. → YOU. Selepas memilih calon, kekunci  akan kembali kepada "Simbol".

• Bagaimana menggunakan Mod angka



Anda boleh menggunakan mod ini untuk memasukkan nombor, tukar kepada mod lain dengan kekunci .

• Bagaimana menggunakan mod huruf





Terdapat dua submod dalam mod huruf. Anda boleh menukar submod dengan kekunci . Anda boleh memasukkan huruf besar.







Anda boleh memasukkan huruf kecil.

● Perhatian

1. Jika anda mahu menambah ruang,  tekan.
2. Untuk memadam huruf, gunakan kekunci .

Kotak masuk [Menu 1-2]

Apabila anda menerima mesej teks, simbol  dipaparkan pada skrin. Anda boleh menyimpan ia di dalam senarai mesej masuk. Pilih mesej yang diingini dengan menatal  ,  , anda boleh memadam semua mesej masuk dengan memilih **Padam semua** di bawah senarai. Selepas membaca mesej, tekan  [Pilihan] untuk mengakses pilihan-pilihan yang terdapat.

Jawab [Menu 1-2-1]

Anda boleh membalas penghantar melalui mesej, jika anda menekan  [OK].

Ke depan [Menu 1-2-2]

Anda boleh menghantar lanjut mesej terpilih kepada pihak lain, jika anda menekan  [OK].

Padam [Menu 1-2-3]

Anda boleh memadam mesej jika anda menekan  [OK].

Dapatkan nombor [Menu 1-2-4]

Jika mesej mempunyai nombor, anda bukan sahaja boleh mengambilnya tetapi juga boleh menyimpannya di dalam buku telefon. Anda juga boleh memanggil melalui nombor ini.





Simpan lampiran [Menu 1-2-5]

Anda boleh menyimpan fail lampiran seperti gambar dan bunyi, dan animasi.

Balas panggilan [Menu 1-2-6]

Anda boleh memanggil balik penghantar dengan menekan  [Hantar].

Kotak keluar [Menu 1-3]

Apabila anda memasuki menu ini, anda boleh melihat senarai mesej keluar. Anda boleh memilih mesej yang diinginkan dengan menatal ,  dan menekan  [OK] untuk membaca. Dan jika anda mahu keluar dari menu **Kotak keluar**, tekan  [Kembali]. Selain itu, anda boleh memadam semua mesej keluar dengan menekan menu **Padam semua** di bawah senarai.

Selepas membaca mesej, tekan  [Pilihan] untuk mengakses submenu-submenu berikut.

Ke depan [Menu 1-3-1]

Anda boleh menghantar lanjut mesej kepada pihak lain.

Padam [Menu 1-3-2]

Anda boleh memadam mesej.

Dapatkan nombor [Menu 1-3-3]

Jika mesej mempunyai nombor telefon, anda bukan sahaja boleh mengambilnya tetapi juga boleh menyimpannya di dalam buku telefon. Anda boleh memanggil melalui nombor ini.

● Notis

Jika anda menambah ruang semasa memasukkan nombor-nombor, penerima boleh memeriksa masing-masing nombor tersebut.

Servis maklumat [Menu 1-4]

Mesej-mesej Siaran Sel (mesej CB) adalah mesej-mesej teks yang dihantar oleh rangkaian kepada pengguna-pengguna telefon GSM. Rangkaian menyediakan maklumat umum seperti laporan cuaca, berita lalu lintas, cukai, farmasi dan harga saham. Setiap jenis maklumat mempunyai nombor; oleh itu, anda boleh menghubungi pembekal khidmat. Apabila anda menerima mesej CB, anda boleh melihat submenu-submenu di bawah:



Terima [Menu 1-4-1]

- **Ya** : Jika anda memilih menu ini, telefon anda akan menerima mesej Siaran Sel.
- **Tidak** : Jika anda memilih menu ini, telefon anda tidak akan menerima mesej Siaran Sel.

Kotak masuk [Menu 1-4-2]

Anda boleh membaca dan memadam mesej CB yang diterima.

Topik [Menu 1-4-3]

Jika anda mahu mencipta topik-topik baru, tekan  [OK]. Kemudian, anda pilih menu Topik baru melalui  [Pilih]. Jika anda sudah mempunyai topik-topik, anda boleh memadam mengedit, dan mengaktifkan dengan menekan  [Pilihan].

Awas [Menu 1-4-4]



• Pasang

Apabila mesej Siaran sel tiba, telefon anda akan memberitahu anda melalui bunyi bip.

• Tutup

Apabila mesej Siaran sel tiba, telefon anda tidak akan berbunyi bip.

Auto pamer [Menu 1-4-5]

Apabila anda menerima mesej CB, ia dipaparkan secara automatik pada tettingkap. Anda boleh membacanya dengan menatal  ,  .

• Pasang

Mesej akan dipaparkan pada skrin secara automatik.

• Tutup

Mesej tidak akan dipaparkan pada skrin secara automatik.

Bahasa [Menu 1-4-6] (Bergantung kepada Rangkaian)

Anda boleh memilih bahasa dengan menekan  [OK]. Kemudian, mesej sel akan dipaparkan dalam bahasa yang anda pilih. Jika anda menggunakan semua bahasa yang disokong telefon, pilih **Semua** di bawah senarai.

Mesej suara [Menu 1-5]

Dengar mesej [Menu 1-5-1]

Di dalam menu ini, anda boleh mendengar mesej suara anda. Jika alamat pusat mel suara telahpun disimpan di dalam telefon, telefon anda meyambung kannya secara automatik. Jika tidak, telefon memerlukan anda memasukkan alamatnya.

No.mel suara [Menu 1-5-2]

Anda boleh memasukkan nombor alamat peti mel suara.

Laporan kiriman [Menu 1-6]

Anda boleh membaca dan memadam mesej laporan penghantaran.

Templat [Menu 1-7]

Anda boleh melihat 10 mesej yang telah dipraktifik di dalam senarai. Anda boleh melihat templat-templat yang telah disimpan di dalam senarai sebelum menge ditnya. Anda boleh mengubahnya. Yang lain adalah <Kosong>. Anda boleh menambah yang baru.

Edit [Menu 1-7-1]

Anda boleh mengedit templat.

Padam [Menu 1-7-2]

Anda boleh memadam templat.

Hantar [Menu 1-7-3]

Anda boleh menghantar mesej teks dengan templat.

Aturan [Menu 1-8]

No.pusat mesej [Menu 1-8-1]

Anda boleh memasukkan alamat pusat mesej.

Jenis mesej [Menu 1-8-2]

Teks, Suara, Faks, Mengelui, X.400, E-mel, ERMES

Biasanya, jenis mesej ditetapkan ke jenis **Teks**. Anda boleh menggantikan teks anda dengan format-format lain, yang sesuai bagi peranti yang akan menerima mesej tersebut. Hubungi pembekal khidmat anda untuk ketersediaan fungsi ini.

Tempoh sah [Menu 1-8-3]

Khidmat rangkaian ini membolehkan anda menetapkan berapa lama mesej teks anda akan disimpan di pusat mesej.

Laporan kiriman [Menu 1-8-4]

Jika anda menetapkan **Ya** dalam menu ini, anda boleh memeriksa sama ada mesej anda berjaya dihantar kepada pihak lain atau tidak.

Bayar utk balas [Menu 1-8-5]

Apabila pihak lain membalas mesej anda, anda boleh membayar untuknya.

Aturan pembawa [Menu 1-8-6]

Anda boleh aturkan Rangkaian Data servis mengikut sebagai.

- Dua
- GPRS Sahaja
- GSM Sahaja

Periksa memori [Menu 1-8-7]

Jika anda memilih menu ini, anda boleh memeriksa memori yang digunakan dan jumlah memori. Jumlah memori ialah jumlah memori SIM dan memori Telefon.

Padam semua [Menu 1-9]

Ya [Menu 1-9-1]

Anda boleh memadam semua mesej di dalam Peti masuk/Peti keluar.

Tidak [Menu 1-9-2]

Anda boleh membatalkan pemadaman semua mesej di dalam Peti masuk/Peti keluar.

Daftar panggilan [Menu 2]

(Bergantung kepada khidmat rangkaian)

Penerangan Menu



[Tekan sekali]

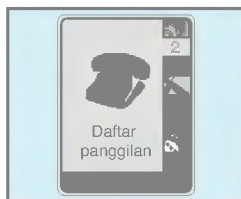

Anda boleh memeriksa rekod panggilan yang tidak dijawab, yang diterima dan yang didail hanya jika rangkaian menyokong pengenalan Talian Pemanggilan (CLI) di dalam kawasan khidmat.

Di dalam pilihan-pilihan bagi panggilan yang tidak dijawab, panggilan yang diterima, dan nombor yang didail anda boleh memeriksa:

- Panggil melalui nombor ini.
- Simpan nombor di dalam buku telefon.
- Lihat tarikh dan masa panggilan.
- Edit, padam atau simpan nombor dari senarai di dalam buku telefon.

Panggilan terlepas [Menu 2-1]

Fungsi ini membolehkan anda melihat senarai 10 nombor telefon terbaru yang tidak anda terima.

Panggilan diterima [Menu 2-2]

Fungsi ini membolehkan anda melihat senarai 20 nombor telefon dari mana anda mendapat at panggilan terbaru yang diterima.

(Bergantung kepada khidmat rangkaian)

Panggilan didail [Menu 2-3]

Fungsi ini membolehkan anda melihat senarai 20 nombor telefon yang terbaru anda panggil atau cuba memanggil.

Submenu di dalam setiap menu:

Lihat perincian

Anda boleh memeriksa nombor yang didail dengan terperinci.

Padam

Anda boleh memadam rekod nombor-nombor yang didail.

Simpan

Anda boleh menyimpan maklumat panggilan yang didail.

Panggil

Anda boleh memanggil melalui nombor ini.

Padam panggilan terkini [Menu 2-4]

Fungsi ini membolehkan anda memadam senarai-senarai Panggilan yang tidak dijawab, Panggilan yang didail, dan Panggilan yang diterima. Anda boleh memadam semua senarai panggilan pada satu masa.

Tempoh panggilan [Menu 2-5]

Fungsi ini membolehkan anda melihat tempoh panggilan masuk dan keluar. Anda boleh memadam rekod tempoh dengan menggunakan kekunci Tetap semula selepas memasukkan kod keselamatan.

Panggilan Akhir [Menu 2-5-1]

Jika anda menekan  [Tetap semula], anda boleh memadam tempoh panggilan terakhir.

Panggilan diterima [Menu 2-5-2]

Jika anda menekan  [Tetap semula], anda boleh memadam tempoh Panggilan yang diterima. Anda perlu memasukkan kod Keselamatan.

Panggilan didail [Menu 2-5-3]

Jika anda menekan  [Tetap semula], anda boleh memadam tempoh panggilan keluar.

Anda perlu memasukkan kod Keselamatan.

Semua panggilan [Menu 2-5-4]

Jika anda menekan  [Tetap semula], anda boleh memadam tempoh Panggilan terakhir, panggilan yang diterima, dan panggilan keluar. Anda perlu memasukkan kod Keselamatan.

Kos panggilan [Menu 2-6]

Khidmat rangkaian ini membolehkan anda memeriksa kos-kos panggilan terakhir dan semua panggilan anda. Untuk mengosongkan pembilang, anda memerlukan Kod PIN 2.

Kos panggilan Akhir [Menu 2-6-1]

Fungsi ini membolehkan anda menetapkan semula kos panggilan terakhir. Anda perlu memasukkan kod PIN 2.

Kos semua panggilan [Menu 2-6-2]

Fungsi ini membolehkan anda menetapkan semula kos semua panggilan. Anda perlu memasukkan kod PIN2.

● Perhatian

- Kos sebenar yang diinvois untuk panggilan oleh pembekal khidmat anda mungkin beruba h-ubah bergantung kepada ciri-ciri rangkaian, pembulatan untuk bil, cukai, dll.

Tetapan panggilan [Menu 2-7]**Had kos panggilan [Menu 2-7-1]**

Khidmat rangkaian ini membolehkan anda menghadkan kos panggilan anda kepada bilangan unit mengecaj atau unit mata wang. Jika anda memilih berdasarkan bilangan yang tinggal, kos akan dipaparkan dalam mod tunggu sedia.

Anda boleh membuat atau menerima panggilan asalkan had kos yang ditetapkan tidak dilebihi.

(Bergantung kepada khidmat rangkaian)

Set tarif [Menu 2-7-2]

Telefon boleh menukar unit dan nama mata wang. Hubungi pembekal khidmat anda untuk harga unit mengecaj. Anda mungkin memerlukan kod PIN2 untuk memilih mata wang atau unit di dalam menu ini.

Auto pamer [Menu 2-7-3]

Apabila tetapannya **Pasang**, kos yang tinggal dipaparkan dalam mod tunggu sedia, Apabila panggilan tamat, kos panggilan terakhir dipaparkan.

Maklumat GPRS [menu 2-8]

Anda boleh semak data Pindahan ke Jaringan melalui GPRS tambahan. Anda juga boleh lihat sebanyak masa anda gunakan talian.

1. Pilih .
2. Skrol untuk informasi yang anda periksa pilihan anda juga termasuk yang bersama.

WAP [Menu 2-8-1]

Anda boleh periksa sebanyak Data Jankamasa melalui WAP.

• Sesi terakhir [Menu 2-8-1-1]

• Semua sesi [Menu 2-8-1-2]

Peranti luaran [Menu 2-8-2]

Anda boleh periksa Data sebanyak dengan Jangkamasa melalui GPRS boleh gunakan alat seperti Serial Port.

Jumlah data [Menu 2-8-3]



Anda boleh periksa Jumlah kegunaan data melalui WAP dengan kegunaan alat lain.



[Tekan dua kali]



Di dalam menu ini, anda boleh melaraskan dan mengkhususkan nada-nada telefon untuk acara-acara, sekitaran dan kumpulan pemanggil yang berbeza. (misalnya, Apabila anda berada di dalam kereta, anda boleh memilih profil **Kereta**, Dll.)

1. Tekan  [Menu] dalam mod tunggu sedia.
2. Tekan  untuk akses langsung bagi memasuki **Profil**.

Getaran shj [Menu 3-1]

Aktifkan [Menu 3-1-1]

Anda boleh melaraskan profil sebagai Getaran jika anda memerlukan mod getaran.

Senyap [Menu 3-2]

Aktifkan [Menu 3-2-1]

Anda boleh melaraskan profil sebagai Senyap jika anda berada di tempat yang sunyi.

Pemeribadian [Menu 3-2-2]

Anda boleh menukar nilai-nilai submenu Profil.

Am [Menu 3-3]

Aktifkan [Menu 3-3-1]

Anda boleh melaraskan profil sebagai Umum jika anda memerlukan mod Umum.

Pemeribadian [Menu 3-3-2]

Anda boleh menukar nilai-nilai submenu Profil.

Kuat [Menu 3-4]

Aktifkan [Menu 3-4-1]

Anda boleh melaras profil sebagai di luar jika anda berada di sekitaran yang bisung.

Pemeribadian [Menu 3-4-2]

Anda boleh menukar nilai-nilai submenu Profil.

Set kepala [Menu 3-5]

Aktifkan [Menu 3-5-1]

Anda boleh melaras profil sebagai Alat dengar apabila anda memakai alat dengar.

Pemeribadian [Menu 3-5-2]

Anda boleh menukar nilai-nilai submenu Profil.

Kereta [Menu 3-6]

Aktifkan [Menu 3-6-1]

Anda boleh melaras profil ini apabila anda mengaktifkan Kit Bebas tangan.

Pemeribadian [Menu 3-6-2]

Anda boleh menukar nilai-nilai submenu Profil.

● Perhatian

Jika anda menyambungkan alat dengar atau kit bebas tangan kepada telefon, setiap menu profil yang berkaitan dengannya akan dipaparkan secara automatik.

Sekumpulan submenu yang Diperibadikan [Menu 3-x-x]

Menu **Pemeribadian** mempunyai submenu-submenu seperti yang ditunjukkan di bawah.

Jenis waspada pangg. Masuk [Menu 3-x-x-1]

Membolehkan anda menetapkan jenis isyarat panggilan masuk untuk menyesuainya pada sekitaran. **Berdering, Bergetar, Berdering & Bergetar, Berdering selepas bergetar, Tak aktif.**

Nada deringan [Menu 3-x-x-2]

Membolehkan anda menetapkan nada dering untuk menyesuainya pada sekitaran.

Tahap deringan [Menu 3-x-x-3]

Membolehkan anda menetapkan kelantangan deringan untuk menyesuainya pada sekitaran.

Jenis waspada mesej [Menu 3-x-x-4]

Membolehkan telefon memberi isyarat apabila ia menerima mesej untuk menyesuainya pada sekitaran. **Dering sekali, Dering berkala, Getaran, Dering & Getar, Tutup.**

Nada isyarat mesej [Menu 3-x-x-5]

Membolehkan anda menetapkan nada isyarat mesej untuk menyesuainya pada sekitaran.

Saiz utama [Menu 3-x-x-6]

Membolehkan anda menetapkan nada pad kekunci untuk menyesuainya pada sekitaran.

● Perhatian

Jawab automatik

- Fungsi ini akan diaktifkan hanya apabila telefon anda disambungkan kepada kit bebas tangan atau alat dengar.
 - **Tutup** : Telefon tidak akan menjawab secara automatik.
 - **Selepas 5 saat** : Selepas 5 saat, telefon akan menjawab secara automatik.
 - **Selepas 10 saat** : Selepas 10 saat, telefon akan menjawab secara automatik.

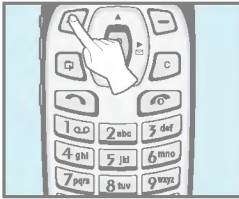

[Tekan tiga kali]



Jam loceng [Menu 4-1]

Anda boleh menetapkan masa penggeraan telefon di dalam menu ini.

• Pasang

Anda boleh menetapkan masa (Jam dan Minit) untuk membunyikan penggera.

1. Masuki menu.
2. Pilih **Pasang** dengan menekan (☰, ☑) [Aktif/Tak aktif].
3. Jika anda mahu menetapkan masa membunyikan penggera, tekan (⌚, ⌚).
4. Pilih tempoh mengulang dengan menekan (☰, ☑) : **Sekali, Setiap hari, Setiap minggu, dan Setiap bulan.**
5. Tekan ☑ [Tetapkan].

• Tutup

Anda boleh membatalkan masa penggeraan.



1. Masuki menu.
2. Pilih **Tutup** dengan menekan (☰, ☑) [Aktif/Tak aktif].
3. Anda boleh memeriksa mesej "Penggera tak aktif".

Tarikh & Masa [Menu 4-2]

Telefon mempunyai jamnya sendiri. Di dalam menu ini anda boleh menetapkan format masa antara 12 jam dan 24 jam.

Set masa [Menu 4-2-1]

Anda boleh menetapkan masa telefon anda di dalam menu ini.

1. Pilih **Set masa** dengan menekan  [Pilih].
2. Masukkan nombor yang ingin anda tetapkan masanya.
3. Tekan  [tetapkan].



Format masa [Menu 4-2-2]

Anda boleh memilih format masa antara 12 jam dan 24 jam.

1. Tatal untuk menyerlahkan **Format masa** dengan menekan  [Pilih].
2. Pilih 12 jam atau 24 jam yang anda mahu dengan menekan  [OK].

Set tarikh [Menu 4-2-3]

Di dalam menu ini, anda boleh menetapkan tarikh telefon anda.

1. Masuki menu.
2. Pilih **Set tarikh** dengan menekan  [Pilih].
3. Masukkan nombor yang ingin anda tetapkan tarikhnya.
4. Tekan  [Tetapkan].

Format tarikh [Menu 4-2-4]

Anda boleh menetapkan format Tarikh di dalam menu ini.

[Y: Tahun, M: Bulan, D: Hari]

- TTTT/BB/HH
- HH/BB/TTTT
- BB/HH/TTTT

Aturan telefon [Menu 4-3]

Anda boleh menetapkan telefon seperti yang anda mahu. Tatal untuk menyerlahkan menu **Aturan telefon**, dan kemudian tekan  [Pilih].

Bahasa [Menu 4-3-1]

Menu ini menyediakan anda pilihan bahasa. Jika **Automatik** ditetapkan, bahasa dipilih berdasarkan kad SIM semasa. Bahasa Inggeris akan ditetapkan jika bahasa kad SIM tidak disokong di dalam telefon.

Kertas dinding [Menu 4-3-2]

Anda boleh memilih salah satu gambar dengan menekan .

Penunjuk LED [Menu 4-3-3]



Anda boleh menetapkan status rangkaian menerusi Lampu Penunjuk Panggilan. Jika anda berada di dalam kawasan khidmat, Lampu Penunjuk Panggilan akan berkelipke Hijau. Sebaliknya, jika anda berada di dalam kawasan tiada khidmat, lampu ini berubah kepada Merah.

• Panggilan masuk [Menu 4-3-3-1]

Menu ini membolehkan anda memilih warna penunjuk LED untuk panggilan masuk. Selain itu, anda boleh menetapkan warna LED bergantung kepada kumpulan-kumpulan lain.

• Terbiar [Menu 4-3-3-2]

Anda boleh memeriksa status rangkaian melalui warna LED dalam mod tunggu sedia.

- Boleh

- Tak Boleh

Lampu belakang [Menu 4-3-4]

Anda boleh menetapkan tempoh pencahayaan yang anda mahu setiap kali anda menekan kekunci atau membuka pelipat.

Kontras [Menu 4-3-5]

Aturan panggilan [Menu 4-4]

Anda boleh menetapkan menu yang relevan kepada panggilan dengan menekan  [OK] di dalam menu **Aturan**.



Mod Jawapan [Menu 4-4-1]

• Pd kibasan buka [Menu 4-4-1-1]

Jika anda memilih menu ini, anda boleh menerima panggilan masuk hanya apabila pelipat dibuka.

- **Ya** : Anda boleh mengaktifkan fungsi ini.
- **Tidak** : Anda boleh menyahaktifkan fungsi ini.

• Tekan sebrg kunci [Menu 4-4-1-2]

Jika anda memilih menu ini, anda boleh menerima panggilan masuk dengan menekan sebarang kekunci kecuali kekunci  ,  .

- **Ya** : Anda boleh mengaktifkan fungsi ini.
- **Tidak** : Anda boleh menyahaktifkan fungsi ini.

Kirim no.sendiri [Menu 4-4-2]

(bergantung kepada rangkaian dan langganan)

Anda boleh menghantar nombor telefon anda kepada pihak lain bergantung kepada penet aapan fung si ini.

• Diset olh jaringan [Menu 4-4-2-1]

Jika anda memilih ini, anda boleh menghantar nombor telefon anda bergantung kepada khidmat dua talian seperti talian 1 atau talian 2.

• Pasang [Menu 4-4-2-2]

Jika anda memilih menu ini, anda boleh menghantar nombor telefon anda kepada pihak lain. Iaitu, nombor telefon anda akan dipaparkan pada telefon penerima.

• Tutup [Menu 4-4-2-3]

Jika anda memilih menu ini, anda tidak boleh menghantar nombor telefon anda.

Servis tunggu panggilan [Menu 4-4-3]

Jika khidmat ini diupayakan, anda boleh menerima panggilan (masuk) yang menunggu. Jika khidmat ini dilumpuhkan, anda tidak boleh mengenali panggilan (masuk) yang menunggu.

- **Aktifkan [Menu 4-4-3-1]**

Mengaktifkan khidmat yang sepadan.

- **Batal [Menu 4-4-3-2]**

Menyahaktifkan khidmat yang sepadan.

- **Periksa status [Menu 4-4-3-3]**

Memeriksa status khidmat.

Dail semula auto [Menu 4-4-4]

- **Pasang [Menu 4-4-4-1]**

Apabila fungsi ini diaktifkan, telefon anda akan cuba membuat panggilan sekiranya ia gagal menyambungkan.

- **Tutup [Menu 4-4-4-2]**

Telefon anda tidak akan membuat sebarang percubaan untuk menyambungkan panggilan selepas ia gagal menyambungkan.

Pengawas minit [Menu 4-4-5]

Jika anda memilih **Pasang**, anda boleh memeriksa tempoh panggilan melalui bunyi bip setiap minit semasa panggilan.

Fon sdg diguna [Menu 4-4-6]

Fungsi ini hanya digunakan jika **Khidmat dua talian** disokong oleh Pembekal Khidmat. Dua nombor telefon berasingan didaftarkan untuk telefon. Fungsi ini memberi anda pemilihan nombor telefon yang sedang digunakan.

1. **Talian 1** : Pilih Talian 1 sebagai nombor telefon semasa.

2. **Talian 2** : Pilih Talian 2 sebagai nombor telefon semasa.

● **Perhatian**

- Jika anda memilih Talian 2 di dalam kawasan di mana khidmat talian alternatif tidak disokong, anda tidak boleh membuat panggilan.

Mod pindah data [Menu 4-4-7]

(bergantung kepada rangkaian)

Dalam hal Khidmat Penomboran Tunggal, anda boleh mengganakan telefon dan PC yang disambungkan untuk menghantar dan menerima faks, data dan suara. Jika anda memilih mod ini, anda boleh menerima data, faks, atau suara untuk setiap mod. Setelah anda memasuki menu ini, pilihan-pilihan berikut dipaparkan.

• Mode sehalu

Anda boleh menerima panggilan suara, panggilan faks, dan panggilan data.

• Suara & Faks

Anda boleh menerima panggilan data selepas panggilan suara.

● Perhatian

- Khidmat Penomboran Tunggal bermakna bahawa nombor khidmat faks atau data adalah sama dengan nombor khidmat suara. Dan, mod-mod ini bergantung kepada ciri rangkaian.

Kump pengguna tertutup [Menu 4-4-8]

(bergantung kepada rangkaian)

Gunakan fungsi ini untuk mengehadkan penggunaan telefon dkepada nombor-nombor yang di dalam kumpulan-kumpulan pengguna tertentu. Apabila fungsi ini digunakan, setiap panggilan masuk dan keluar dikaitkan dengan suatu indeks kumpulan. Jika sesuatu indeks kumpulan ditentukan, ia digunakan untuk semua panggilan keluar. Jika tiada indeks kumpulan yang ditentukan, rangkaian akan menggunakan indeks utama (suatu indeks tertentu yang disimpan di dalam rangkaian).

A. Pratetap : Menetapkan Indeks CUG yang terpilih.





B. Aktif : Mengaktifkan dan mengedit indeks CUG.

C. Tak aktif : Memadam CUG terpilih.

Aturan sekuriti [Menu 4-5]

Mohon kod PIN [Menu 4-5-1]

Di dalam menu ini, anda boleh menetapkan telefon supaya meminta kod PIN kad SIM anda apabila telefon dihidupkan. Jika fungsi ini diaktifkan, anda akan diminta memasukkan kod PIN.

1. Tekan  [Menu] dalam mod tunggu sedia.
2. Tekan kekunci  untuk akses langsung atau gunakan  dan  untuk memasuki **Aturan**.
3. Tatal untuk menyerlahkan menu **Aturan sekuriti**.
4. Pilih **Mohon kod PIN** dengan menekan  [OK].
5. Anda boleh melihat submenu-submenu berikut.
 - **Upayakan** : Anda boleh mengaktifkan fungsi ini.
 - **Lumpuhkan** : Anda boleh membatalkan penetapan fungsi ini.

Servis sekat panggilan [Menu 4-5-2]

(Bergantung kepada rangkaian)

Khidmat Sekatan panggilan mencegah telefon anda daripada membuat atau menerima kategori panggilan tertentu. Fungsi ini memerlukan kata laluan sekat panggilan. Anda boleh melihat submenu-submenu berikut.

- **Panggilan keluar [Menu 4-5-2-1]**
Anda boleh menyekat semua panggilan keluar.
- **Panggilan keluar a/bangsa [Menu 4-5-2-2]**
Anda boleh menyekat panggilan keluar antarabangsa.
- **Keluar a/bangsa kecuali rumah [Menu 4-5-2-3]**
Anda boleh menyekat panggilan keluar merayau antarabangsa.

- **Semua panggilan masuk [Menu 4-5-2-4]**
Anda boleh menyekat panggilan masuk.
- **Panggilan masuk semasa merantau [Menu 4-5-2-5]**
Anda boleh menyekat panggilan masuk apabila merayau.
- **Panggilan semua data [Menu 4-5-2-6]**
Anda boleh menyekat semua panggilan data.
- **Panggilan semua faks [Menu 4-5-2-7]**
Anda boleh menyekat semua panggilan faks.
- **Batal panggilan [Menu 4-5-2-8]**
Anda boleh membatalkan semua khidmat sekatan.

Submenu Khidmat Sekatan Panggilan







- **Aktifkan [Menu 4-5-2-x-1]**
Jika anda memohon untuk mendapatkan khidmat sekatan daripada pembekal khidmat anda, anda boleh menggunakannya.
- **Batal [Menu 4-5-2-x-2]**
Anda boleh membatalkan fungsi ini.
- **Periksa status [Menu 4-5-2-x-3]**
Anda boleh memeriksa status semasa khidmat sekatan panggilan.

● Perhatian

- Untuk menggunakan khidmat Sekatan panggilan, anda mestilah memasukkan kata laluan rangkaian.







Nombor dail tetap [Menu 4-5-3] (bergantung kepada SIM)

Nombor-nombor tersebut dilindungi oleh kod PIN2 anda.

1. Tekan  [Menu] dalam mod tunggu sedia.
2. Tekan  untuk akses langsung atau gunakan  dan  untuk memasuki **Aturan**.
3. Tatal untuk menyerlahkan menu **Aturan sekuriti**.
4. Pilih **Nombor dail tetap** dengan menekan  [OK].
5. Masukkan kod PIN2, dan kemudian tekan  [OK].
6. Jika kod PIN2 betul, anda boleh melihat submenu-submenu berikut.
 - **Boleh** : Anda boleh menghadkan panggilan keluar anda kepada nombor-nombor telefon terpilih.
 - **Tak Boleh** : Anda boleh memanggil tanpa menghadkan nombor-nombor telefon.
 - **Senarai nombor** : Anda boleh melihat nombor-nombor dail tetap dan menambah, mengedit, memadam.

Tukar kod [Menu 4-5-4]

Anda boleh menukar kod-kod akses: PIN, PIN2, Kod keselamatan, Kata laluan sekatan.

1. Tekan  [Menu] dalam mod tunggu sedia.
2. Tekan kekunci  untuk akses langsung atau gunakan  dan  untuk memasuki **Aturan**.
3. Tatal untuk menyerlahkan menu **Aturan sekuriti**.
4. Pilih **Tukar kod** dengan menekan  [OK].
5. Jika anda mahu menukar kod Keselamatan/PIN/PIN2/ Kata laluan sekatan, tekan  [OK].
6. Masukkan kod Keselamatan/PIN/PIN2/Kata laluan sekatan baru (Bergantung kepada Rangkaian).

Aturan jaringan [Menu 4-6]

Anda boleh memilih rangkaian, yang akan anda daftarkan sama ada secara automatik atau manual. Biasanya, pemilihan rangkaian ditetapkan ke **Automatik**.

Automatik [Menu 4-6-1]

Telefon memilih secara automatik rangkaian yang terdapat di kawasan itu.

Manual [Menu 4-6-2]

Telefon akan mencari senarai rangkaian-rangkaian yang terdapat dan menunjukkannya kepada anda. Kemudian anda boleh memilih rangkaian yang ingin anda gunakan jika rangkaian ini mempunyai persetujuan merayau dengan operator rangkaian tanah air anda.

Aturan GPRS [Menu 4-7]

Bila anda guna GPRS untuk sambung ke Internet, anda boleh buat Data Panggilan untuk GPRS , anda perlu aturkan mengikut pilihan.

Jenis terminal [Menu 4-7-1]

- Dua
- GPRS Sahaja
- GSM Sahaja

Sesi GPRS masuk [Menu 4-7-2]

- Automatik
- Manual

Peranti luaran [Menu 4-7-3]

Bila anda gunakan Internet melalui GPRS untuk alat lain anda perlu aturkan APN, alamat IP, PNS kegunaan ID dan kata laluan untuk 5 profil. Selain dari itu, anda mungkin dapat tawaran informasi melalui Rangkaian.

Kembalikan tetapan kilang [Menu 4-8]

Anda boleh menetap telefon kepada tatarajah lalai dengan memilih pilihan menetap semula Tetapan/Kilang. Anda memerlukan kod keselamatan untuk mengaktifkan fungsi ini.





Alihan panggilan [Menu 5]

(bergantung kepada rangkaian dan langganan)

Penerangan Menu



Khidmat Alihan panggilan membolehkan anda mengalihkan panggilan suara, panggilan faks, dan panggilan data yang masuk ke nombor lain. Untuk maklumat lanjut, hubungi pembekal khidmat anda.

1. Tekan  [Menu] dalam mod tunggu sedia.
2. Tekan  untuk akses langsung atau gunakan  dan  untuk memasuki **Alihan panggilan**.

Panggilan semua suara [Menu 5-1]

Mengalihkan semua panggilan tanpa syarat.

Jika sibuk [Menu 5-2]

Mengalihkan semua panggilan suara apabila telefon sedang digunakan.

Jika tak jawab [Menu 5-3]

Mengalihkan panggilan yang tidak anda jawab.

Jika tak sampai [Menu 5-4]

Mengalihkan panggilan suara apabila telefon dimatikan atau di luar kawasan khidmat.

Panggilan semua data [Menu 5-5]

Mengalihkan ke nombor dengan sambungan PC tanpa syarat.

Panggilan semua faks [Menu 5-6]

(bergantung kepada rangkaian dan langganan)

Mengalihkan ke nombor dengan sambungan faks tanpa syarat.

Submenu [Menu 5-x-x]

Menu Alihan Panggilan mempunyai submenu-submenu seperti yang ditunjukkan di bawah.

Aktifkan [Menu 5-x-1]

Mengaktifkan khidmat yang sepadan.

- **Ke petimel suara**

Menghantar lanjut kepada pusat mesej. Fungsi ini tidak disertakan di dalam menu-menu **Panggilan semua data** dan **Panggilan semua faks**.

- **Ke nombor lain**

Memasukkan nombor untuk pengalihan.

Batalkan [Menu 5-x-2]

Menyahaktifkan khidmat yang sepadan.

Periksa status [Menu 5-x-3]

Memeriksa status khidmat yang sepadan.

Batal semua pesongan [Menu 5-7]

Membatalkan semua khidmat alihan panggilan.



[Tekan lima kali]



Jadual [Menu 6-1]

Apabila anda memasuki menu ini Kalendar akan dipaparkan. Di bahagian atas skrin terdapat bahagian-bahagian untuk tarikh dan ikon-ikon. Anda boleh menukar hari, bulan dan tahun dengan menggunakan (←, →). Setiap kali anda menukar tarikh, kalendar akan dikemaskini menurut tarikh ini. Dan kursor empat segi tepat akan ditempatkan pada hari itu. Jika anda melihat kursor empat segi tepat merah jambu di tarikh pada kalendar, ia bermakna terdapat hari jadual.

Fungsi ini menolong mengingatkan anda tentang jadual-jadual anda, hari-hari peringatan, dan tugas yang perlu anda lakukan. Jika anda menetapkan jadual, anda boleh melihat submenu-submenu berikut.

Edit [Menu 6-1-1]

Anda boleh menambah nota pada tarikh yang terpilih dan menukarnya.

Padam [Menu 6-1-2]

Anda boleh memadam nota-nota yang telah anda tetapkan.

Tambah baru [Menu 6-1-3]

Anda boleh memasukkan maksimum 30 aksara dan 30 nota.



Lihat semua jadual [Menu 6-1-4]

Memaparkan nota-nota yang ditetapkan untuk semua jadual.

Pergi ke tarikh [Menu 6-1-5]

Anda boleh memeriksa tarikh yang telah anda masukkan.

Memo [Menu 6-2]

1. Tatal untuk menyerlahkan **Memo**.
2. Tekan  [OK].
3. Masukkan memo dan kemudian tekan .
4. Anda boleh melihat submenu-submenu berikut.

Edit [Menu 6-2-1]

Anda boleh mengedit memo yang terpilih.

Padam [Menu 6-2-2]

Anda boleh memadam memo yang terpilih.

Tambah baru [Menu 6-2-3]

Anda boleh menambah memo baru sehingga 20 memo dan 40 aksara.

Padam semua [Menu 6-2-4]





Anda boleh memadam semua memo yang anda buat sebelumnya.



Buku telefon [Menu 6-3]

Anda boleh mencipta buku telefon peribadi dengan menyimpan nombor-nombor telefon dan nama-nama untuknya. Cara mudah membuat panggilan ialah dengan mendapatkan nombor telefon dan nama yang tersimpan di dalam buku telefon anda.

Cari [Menu 6-3-1]





(Memanggil dari buku telefon)

1. Buka buku telefon dahulu dengan menekan  [Nama] dalam mod tunggu sedia. Anda juga boleh pergi ke **Pengatur – Buku telefon** dengan menatal , .
2. **Cari** dengan menekan  [OK] untuk memasuki.
3. Anda boleh mencari sesuatu entri melalui nama dan nombor.
4. Pilih  [Cari].





5. Jika anda mahu mengedit, melihat, memadam, menyalin dan memanggil melalui entri, pilih  [Option]. Menu di bawah akan dipaparkan.
 - **Edit** : Anda boleh mengedit nama, nombor, E-mel, dan faks dengan menekan  [OK].
 - **Lihat perincian** : Anda boleh melihat nama dan nombor secara terperinci.
 - **Padam** : Anda boleh memadam sesuatu entri.
 - **Salin** : Anda boleh menyalin sesuatu entri dari SIM ke telefon atau dari telefon ke SIM.
 - **Panggil** : Anda boleh memanggil melalui entri yang terpilih.

Tambah baru [Menu 6-3-2]

Anda boleh menambah entri buku telefon dengan menggunakan fungsi ini. Muatan memori telefon ialah 255 entri. Muatan memori kad SIM bergantung kepada pembekal khidmat selular. Anda juga boleh menyimpan 20 aksara bagi nama di dalam memori Telefon, dan anda boleh menyimpan 12 aksara di dalam kad SIM. Bilangan aksara adalah ciri yang bergantung kepada SIM. Anda boleh menyimpan entri buku telefon di dalam memori SIM atau memori telefon. Jika anda mahu menukar memori, pergi ke **Tetapkan memori** [Menu 6-3-5] dan pilih **SIM** atau **Memori telefon**.











1. Buka buku telefon dahulu dengan menekan  [Nama] dalam mod tunggu sedia. Anda juga boleh pergi ke **Buku telefon** dengan menatal ,  .
2. Tatal untuk menyerlahkan **Tambah baru**, dan tekan  [OK] untuk memasuki.
 - **SIM** :

Anda boleh menambah nama, nombor, dan tetapan kumpulan untuk sesuatu entri.

 - a. Tulis nama untuk ditambahkan.
 - b. Tekan  . Kemudian anda boleh memasukkan nombor.
 - c. Tekan  . Kemudian anda boleh memilih satu daripada kumpulan-kumpulan dengan menggunakan  ,  .
 - d. Tekan  [OK].



• Telefon :

Anda boleh menambah nama, nombor (telefon bimbit, rumah, pejabat), alamat E-mel, kumpulan memo.

- a. Tulis nama untuk ditambahkan.
- b. Tekan  [OK] dan kemudian pilih nombor yang ingin anda masukkan dengan menekan  ,  .
- c. Anda boleh memilih entri nombor yang ingin anda masukkan dengan menekan  ,  dan kemudian menekan  .
- d. Anda boleh memilih satu kumpulan dengan menekan  ,  .
- e. Tekan  , dan kemudian tulis memo sehingga 50 aksara.
- f. Tekan  [OK].

Kump.pemanggil [Menu 6-3-3]

Terdapat 6 kumpulan dan lain-lain yang boleh anda buat senarai untuknya.

1. Tekan  [Nama] untuk memasukkan ke dalam buku telefon dalam mod tunggu sedia.
2. Tatal ke butir **Kump.pemanggil** kemudian tekan  [OK] untuk memasuki menu ini.
3. Setiap Senarai kumpulan akan dipaparkan: **Keluarga, Orang Kenamaan, Kawan, Rakan Sekerja, Kumpulan 1, Kumpulan 2, Lain-Lain.**
4. Pilih Nama kumpulan yang ingin anda uruskan dengan menekan  [Pilihan].
5. Submenu-submenu di bawah akan dipaparkan kecuali **Lain –Lain.**

• Senarai ahli

Anda boleh mengedit, memadam, menyalin kumpulan pemanggil.

• Namakan semula

Anda boleh mengedit nama kumpulan.

• Nada deringan kump.

Anda boleh memilih bunyi deringan setiap kumpulan.



• Ikon kumpulan





Anda boleh memilih Ikon untuk setiap kumpulan.

• Warna LED

Anda boleh memilih warna LED setiap kumpulan.



Dail laju [Menu 6-3-4]

Anda boleh mengaitkan sebarang kekunci  hingga  dengan entri Senarai nama. Anda boleh memanggil langsung dengan menekan kekunci ini selama 2-3 saat.

1. Buka buku telefon dahulu dengan menekan  [Nama] dalam mod tunggu sedia. Anda juga boleh pergi ke menu Buku telefon dengan menatal ( , ) .
2. Tatal ke **Dail laju**, kemudian tekan  [OK] untuk memasuki menu ini.
3. Setiap Dail cepat akan dipaparkan.
4. Jika anda mehu menambah Dail cepat, pilih **<Kosong>**. Kemudian, anda boleh cari nama di dalam buku telefon.
5. Jika anda memilih nama yang diperuntukkan dengan dail cepat, anda boleh melihat submenu-submenu berikut.
 - **Tukar** : Anda boleh menukar peruntukan untuk Dail cepat.
 - **Padam** : Anda boleh memadam nombor dail cepat yang diperuntukkan.





Set Memori [Menu 6-3-5]

Anda boleh menetapkan memori yang lebih digemari, yang termasuk **SIM atau Telefon**.

1. Buka buku telefon dahulu dengan menekan  [Nama] dalam mod tunggu sedia.
2. Tatal ke **Set Memori**, kemudian tekan  [OK] untuk memasuki.
3. Submenu-submenu di bawah akan dipaparkan.
4. Pilih **SIM atau Telefon**, kemudian tekan  [OK]



Padam semua [Menu 6-3-6]

Anda boleh memadam semua entri di dalam **SIM, Telefon**. Fungsi ini memerlukan kod Keselamatan.

1. Tekan  [Nama] untuk memasuki buku telefon dalam mod tunggu sedia.
2. Tatal ke **Padam semua**, kemudian tekan  [OK].
3. Kemudian pilih memori untuk dipadam: **SIM, Telefon**.
4. Dan kemudian anda akan diminta memasukkan kod Keselamatan.
5. Tekan  [OK] atau, tekan  [Kembali] untuk membatalkan.

Salin semua [Menu 6-3-7]

Anda boleh menyalin/memindahkan entri dari memori Kad SIM ke memori Telefon atau dari memori Telefon ke memori Kad SIM.

1. Buka buku telefon dahulu dengan menekan  [Nama] dalam mod tunggu sedia.
2. Tatal ke Salin semua, kemudian tekan  [OK] untuk memasuki menu ini.
3. Submenu-submenu di bawah akan dipaparkan.

• SIM kepada Fon [Menu 6-3-7-1]

Anda boleh menyalin entri dari Kad SIM ke memori Telefon.

• Fon kepada SIM [Menu 6-3-7-2]

Anda boleh menyalin entri dari memori Telefon ke Kad SIM.

- Simpan asal [Menu 6-3-7-x-1]

Kedua-dua entri asal dan entri yang dialihkan disimpan di dalam memori-memori.

- Padam asal [Menu 6-3-7-x-2]





Entri yang asal dipadam sementara entri yang dialihkan kekal di dalam memori.

Maklumat [Menu 6-3-8]

Anda boleh memilih nombor dail khidmat, periksa memori dan senarai nombor sendiri





• No.dail diservis [Menu 6-3-8-1]

Gunakan fungsi ini untuk mengakses senarai tertentu bagi khidmat-khidmat yang disediakan oleh operator rangkaian anda (jika disokong oleh kad SIM).

1. Buka buku telefon dahulu dengan menekan  [Nama] dalam mod tunggu sedia.
2. Tatal ke **Maklumat** dan tatal ke nombor dail khidmat, kemudian tekan  [OK] untuk memasuki.
3. Nama-nama khidmat yang terdapat akan dipaparkan.
4. Gunakan ,  dan untuk memilih khidmat, tekan  [Hantar].

• Set Memori [Menu 6-3-8-2]

Ciri ini membolehkan anda melihat berapa banyak memori bebas dan sedang digunakan di dalam buku telefon anda.

1. Buka buku telefon dahulu dengan menekan  [Nama] dalam mod tunggu sedia. Anda juga boleh pergi ke menu **Buku telefon** dengan menatal , . Pilih **Maklumat** dengan menekan  [OK].
2. Tatal ke **Set Memori**, dan kemudian tekan  [OK] untuk memasuki menu ini.

• Nombor sendiri (SIM dependent) [Menu 6-3-8-3]

Anda boleh memeriksa nombor anda sendiri di dalam kad SIM. Jika nombor sendiri kosong, anda boleh menambahkan yang baru. Anda juga boleh mengedit dan memadamnya.



[Tekan enam kali]

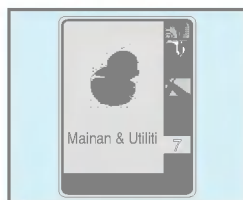

Permainan [Menu 7-1]

Anda boleh menikmati permainan di dalam telefon ini.

Fail saya [Menu 7-2]

Anda boleh melihat, memadam, dan mengawal kandungan muat turun.

Gambar [Menu 7-2-1]

Animasi [Menu 7-2-2]

Bunyi [Menu 7-2-3]

Submenu untuk setiap menu utama [Menu 7-2-x-x]

• Tajuk edit [Menu 7-2-x-1]

Anda boleh mengedit tajuk bagi setiap kandungan muat turun.

• Padam [Menu 7-2-x-2]









Anda boleh memadam setiap kandungan muat turun.

• Padam semua [Menu 7-2-x-3]

Anda boleh memadam semua kandungan muat turun.









Pengubah unit [Menu 7-3]

Ini menukarkan sebarang ukuran ke dalam unit yang anda mahu. Terdapat 4 jenis yang boleh ditukarkan ke dalam unit-unit: **Kepanjangan, Permukaan, Berat, dan Isi padu**.

1. Anda boleh memilih satu daripada empat jenis unit dengan menekan kekunci  [Seterusnya].
2. Pilih nilai semasa dengan menggunakan  ,  dan kemudian, anda boleh menetapkan nilai standard dengan menggunakan  ,  .
3. Pilih nilai untuk ditukar dengan menggunakan  ,  .
4. Masukkan nombor-nombor di dalam ruang kosong.
5. Tekan  atau  [Kembali] jika anda mahu menamatkan proses tersebut.





Kalkulator [Menu 7-4]

Ini mengandungi fungsi-fungsi standard seperti +, -, *, ÷ : **Tambah, Tolak, Darab, dan Bahagi**.

1. Masukkan nombor-nombor dengan menekan kekunci-kekunci angka.
2. Gunakan  ,  ,  ,  , untuk memilih tanda bagi pengiraan.
3. Kemudian masukkan nombor-nombor diikuti oleh tanda.
4. Anda boleh melihat hasilnya dengan menekan kekunci  [Hasil] atau kekunci  [OK].
5. Jika anda mahu teruskan pengiraan, ulang proses tersebut.
6. Gunakan kekunci  [Tetap semula] untuk memadam sebarang nombor atau tanda. Tekan kekunci  jika anda mahu manamatkan proses pengiraan.

Masa dunia [Menu 7-5]

Anda boleh melihat masa untuk setiap bandar di seluruh dunia. Anda juga boleh menetapkan masa semasa kepada masa bandar yang anda pilih.

1. Pilih bandar yang di dalam zon masa dengan menekan kekunci  ,  .
2. Jika anda menggunakan  ,  , anda boleh memeriksa bandar lain yang di dalam zon masa yang sama dengan negara yang terpilih.
3. Anda boleh menetapkan masa semasa kepada masa bandar yang anda pilih. Tekan kekunci  [Kembali] untuk keluar dari menu.

Perakam suara [Menu 7-6]

Anda boleh menyimpan dan memainkan 3 mesej suara dan setiap satu boleh dirakamkan sehingga 30 saat.

Inframerah [Menu 7-7]

Jika anda mengaktifkan fungsi ini, anda boleh menggunakan PC-sync melalui inframerah. Selain itu, anda tidak boleh menggunakan fungsi Bebas tangan dan inframerah pada masa yang sama.

PC Sync!

PC Sync ialah satu program untuk tukaran data antara PC dan telefon melalui kabel data. Untuk maklumat lebih terperinci bagi panduan penggunaan, rujuk kepada fail Bantu PC Sync di dalam CD.

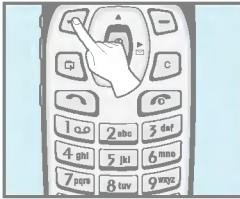

[Tekan tujuh kali]

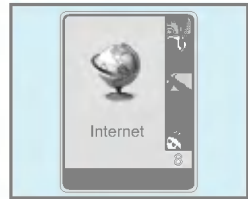

Telefon anda menyokong khidmat internet yang berdasarkan Protokol Aplikasi Wayarles (WAP). Anda boleh mengakses khidmat-khidmat yang disokong oleh rangkaian anda. Menu khidmat membolehkan anda mendapatkan maklumat seperti berita, ramalan cuaca, dan masa penerbangan.

Rumah [Menu 8-1]

Anda boleh menyambungkan lelaman yang ditakrif di dalam profil yang diaktifkan.

Penanda [Menu 8-2]

Anda boleh menyimpan sehingga 50 penanda buku. Tatal ke penanda buku yang diinginkan dan tekan kekunci  [Pilihan] untuk mengendalikan pilihan-pilihan berikut.

- **Sambung** : Sambung kepada penanda buku yang terpilih.
- **Tambah baru** : Simpan penanda buku baru secara manual.
- **Edit** : Edit tajuk dan alamat penanda buku.
- **Padam** : Padam penanda buku yang terpilih.

● **Perhatian**

- Jika belum ada penanda buku yang telah disimpan, hanya menu "Tambah baru" yang terdapat.

Alihkan mesej [Menu 8-3]

Anda boleh menguruskan satu peti masuk dan mesej untuk menggunakan khidmat tolak.

Kotak masuk [Menu 8-3-1]

Anda boleh membaca atau memadam mesej tolak.

Terima [Menu 8-3-2]

Anda boleh menetapkan pilihan sama ada anda akan menerima mesej atau tidak.

Profil [Menu 8-4]

Anda boleh membuat sehingga 5 profil dan aktifkan hanya satu daripadanya. Tatal ke profil yang diinginkan  dan tekan untuk mengakses pilihan-pilihan yang terdapat.

Aktifkan [Menu 8-4-1]

Aktifkan profil yang terpilih.

Aturan [Menu 8-4-2]

Edit dan tukar tetapan WAP profil yang terpilih.

• Laman Utama [Menu 8-4-2-1]

Tetapan ini membolehkan anda memasukkan alamat (URL) tapak yang ingin anda gunakan sebagai laman. Anda tidak perlu menaip "http://" di hadapan setiap URL kerana Penyemak imbas WAP akan menambahkannya secara automatik.

• Pamer imej [Menu 8-4-2-2]

Anda boleh memilih sama ada imej-imej pada kad-kad WAP dipaparkan atau tidak.

• Jenis sambungan [Menu 8-4-2-3]

Pilihan-pilihan untuk jenis sambungan ialah Sementara atau Berterusan dan bergantung kepada gerbang laluan yang anda gunakan.

Berterusan : Khidmat berorientasikan sambungan

Sementara : Khidmat tanpa sambungan

• **Tetapan selamat [Menu 8-4-2-4]**

Pilihan ini boleh ditetapkan ke **Tiada** atau Selamat bergantung kepada gerbang laluan. Jika anda mahu menyambung dengan "Selamat", pilih **Selamat**. Jika tidak, anda pilih **Tiada**. Gerbang laluan harus menyokong pilihan ini.

• **Maklumat gerbang laluan [Menu 8-4-2-5]**

Hampir semua gerbang laluan WAP tidak meminta ID Pengguna dan kata laluan, Jika gerbang laluan tidak mempunyainya, ia harus disediakan oleh rangkaian. Selain itu, ia mestilah ditetapkan sebelum menyemak imbas tapak-tapak WAP.

• **Aturan GPRS [Menu 8-4-2-6]**

Aturan khidmat hanya boleh didapati apabila GPRS dipilih sebagai khidmat pembawa.

• **Tetapan data [Menu 8-4-2-7]**

Alamat IP : Masukkan alamat IP gerbang laluan WAP yang anda akses.

Nombor dailan : Masukkan nombor telefon untuk didail bagi mengakses gerbang laluan WAP anda.

ID Pengguna : Pengenalan pengguna bagi pelayan pendailan anda (dan BUKAN gerbang laluan).

Kata laluan : Kata laluan yang diperlukan oleh pelayan dailan anda (dan BUKAN get laluan WAP) untuk mengenali diri anda.

Jenis panggilan : Pilih jenis panggilan data: Analog atau Digital(ISDN).

Kelajuan panggilan : Kelajuan sambungan data anda.

• **Masa lengah [Menu 8-4-2-8]**

Selepas menetapkan masa terhad (30~300 saat), khidmat ini akan diputuskan sambungannya jika tiada terdapat masukan atau pemindahan data.

Nama Semula [Menu 8-4-3]

Edit Nama Profil.

Pelayan E-mel [Menu 8-4-4]

Simpan alamat URL E-mel yang sering anda gunakan.

- **Sambung**

Sambung kepada URL yang anda tatarajah sebagai pelayan E-mel.

- **Edit alamat**

Masukkan alamat URL E-mel.

Pergi ke URL [Menu 8-5]

Anda boleh pindah ke tapak yang anda mahu. Anda perlu menaip alamat URL tapak tersebut sebelum penyambungan.

Aturan Cache [Menu 8-6]

Anda boleh membuang kandungan memori cache atau menukar mod Cache.

Kosongkan cache [Menu 8-6-1]

Kandungan memori Cache akan dibuang.

Cache periksa [Menu 8-6-2]

Anda boleh memeriksa memori cache.

- **Sentiasa [Menu 8-6-2-1]**

Cache sentiasa diperiksa apabila terdapat pemuatan atau pemanduan arah URL.

- **Mula sahaja [Menu 8-6-2-2]**

Cache hanya diperiksa apabila WAP dimulakan.

- **Tak aktif [Menu 8-6-2-3]**

Cache tidak pernah diperiksa.

Maklumat WAP [Menu 8-7]

Anda boleh melihat maklumat mengenai G7020 WAP.

Reset profil [Menu 8-8]

Anda boleh menetapkan semula semua nilai tetapan kepada nilai lalai kilang.

Jika anda dalam talian, anda boleh melihat menu-menu berikut.

Lelaman

Ini adalah sama dengan [Menu 8-1].

Muat semula

Ini memuat semula halaman semasa.

Penanda buku

Ini sama dengan [Menu 8-2].

Simpan sebagai penanda buku

Simpan URL semasa sebagai penanda buku. Anda juga boleh mengedit tajuk penanda buku.

Mesej

Alihkan mesej

Pergi ke URL

Sama dengan [Menu 8-5].

Pergi ke pelayan e-mel

Sambungkan URL semasa sebagai pelayan E-mel.

Tetap sebagai pelayan e-mel

Simpan URL semasa sebagai pelayan E-mel.

Kosongkan cache

Buang kandungan memori cache.

Pembekal khidmat anda boleh menawarkan aplikasi khas menerusi kad SIM, seperti perbankan di rumah, pasaran saham, dll. Jika anda telah mendaftar untuk salah satu khidmat-khidmat ini, nama khidmat akan muncul di akhir Menu Utama. Dengan menu **Khidmat SIM** telefon anda siap sedia untuk masa depan dan akan menyokong tambahan-tambahan kepada khidmat-khidmat pembekal khidmat anda. Untuk maklumat lanjut hubungi pembekal khidmat anda.

Apabila menggunakan unit ini, langkah-langkah berhati-hati keselamatan yang asas seperti di bawah harus sentiasa dipatuhi.

- Jangan sentuh penyesuai dengan tangan yang basah.
- Jangan buka bahagian-bahagian unit ini. (Bawa ia kepada seorang juruteknik servis yang berkelayakan apabila kerja pembaikan diperlukan.)
- Jauhkan dari alat elektrik seperti TV, radio atau komputer peribadi.
- Unit ini harus dijauhkan dari sumber-sumber haba seperti penyinar atau alat memasak.
- Jangan jatuhkan.
- Lindungi unit ini daripada getaran atau kejutan mekanikal.
- Salutan telefon boleh rosak jika dibalut dengan pembalut vinil.
- Gunakan kain kering untuk membersihkan bahagian luar unit. (Jangan gunakan pelarut seperti benzena, pencair atau alkohol.)
- Jangan dedahkan unit ini kepada asap atau habuk yang berlebihan.
- Jangan simpan telefon bersebelahan kad kredit atau tiket pengangkutan; ia boleh menjejaskan maklumat pada jalur-jalur magnet.
- Jangan ketuk skrin dengan benda tajam; ini boleh merosakkan telefon.
- Jangan dedahkan telefon kepada cecair atau lembapan.
- Gunakan aksesori-aksesori seperti cuping telinga dengan berhati-hati. Jangan sentuh antena jika tidak perlu.

■ Menjaga Bateri

- Anda tidak perlu menyahcas bateri sepenuhnya sebelum mengecas semula. Tidak seperti sistem-sistem bateri lain, tidak terdapat kesan memori yang dapat menjejaskan prestasi bateri.
- Gunakan hanya bateri-bateri dan pengecas-pengecas LG. Pengecas-pengecas LG direka bentuk untuk memaksimumkan hayat bateri.
- Jangan buka atau litar pintas pek bateri.
- Pastikan sentuhan-sentuhan logam pek bateri sentiasa bersih.
- Gantikan bateri apabila ia tidak lagi memberi prestasi yang boleh diterima. Pek bateri boleh dicas semula beratus-ratus kali sehingga ia perlu diganti.
- Cas semula bateri jika ia tidak digunakan buat masa yang lama untuk memaksimumkan penggunaannya.
- Jangan dedahkan pengecas bateri kepada cahaya matahari langsung atau gunakan ia dalam suasana kelembapan tinggi, seperti di dalam bilik air.
- Jangan tinggalkan bateri di tempat yang panas atau sejuk; ini boleh melemahkan prestasi bateri.

Umum

Nama Produk : G7020

Sistem : GSM 900/ DCS 1800

Suhu Ambien

Maks : +55°C

Min : -10°C



GPRS手机

用户手册

型号: G7020

操作前请仔细阅读该手册。
留作以后参考。

G7020造型优美，手感更亲切，使用更方便。



安全措施

所有无线设备在靠近其它电子装备时都会对其产生一些干扰。



在飞机上，请始终关闭GSM手机。



在加油站、燃料仓库、化工厂或爆破活动附近请关机。



在医院内请关机：否则心脏起搏器和助听器等电子医疗设备将会受到影响。



手机可能对电视、收音机、电脑等造成轻微干扰。



开车时请不要手持手机。



切勿拆除手机或电池。



手机置于小孩接不到的安全地方，以免其可的小部件造成窒息危。



不要用手充电器。



只可使用指定电池和充电器以防损坏手机。

请注意：



废旧电池应按相关法规进行适当处理。



只可使用原厂附件以防损坏手机。



该手册中所提及的某些服务并非所有网络都支持。

重要資訊

本用户指南内含有有关本手机之操作与使用的重要资讯。请务必仔细阅读所有资讯，以便能发挥最好的手机性能，并防止手机遭受任何损坏或不当使用。未经本用户指南中明确许可的任何变更或改装，将会使您的产品保修無效。

概述

附件	9
手机部位图解	10
手机正面	10
手机背面	10
手机LCD小屏幕	11
按键描述	12
侧键	13
字母数字键	13

显示信息

显示信息	14
屏幕上的图标	14

第一次使用前

安装	16
插入SIM卡	16
安装电池	16
给电池充电	17
断开充电器	17
开关机顺序	18
开机	18
关机	18
存取码	19
PIN码（4至8位数字）	19
PIN2码（4至8位数字）	19
PUK码（4至8位数字）	19
PUK2码（4至8位数字）	19
安全性密码（4至8位数字）	19
接听及拨打电话	20
拨打电话	20
用  [发送键] 打电话	20
国际电话	20
从电话簿拨号	20
快速拨号	20
电话本	21

进入功能表

菜单结构	22
信息[菜单1]	24
写信息[菜单1-1]	24
收件箱[菜单1-2]	31
发件箱[菜单1-3]	31
信息服务[菜单1-4]	32
语音信息[菜单1-5]	33
信息报告[菜单1-6]	33
常用短语[菜单1-7]	34
设定[菜单1-8]	34
全部删除[菜单1-9]	35
通话记录[菜单2]	36
未接来电[菜单2-1]	36
已接来电[菜单2-2]	36
拨出电话[菜单2-3]	36
清除近期呼叫[菜单2-4]	37
通话计时[菜单2-5]	37
通话计费[菜单2-6]	38
费用设定[菜单2-7]	38
GPRS信息[菜单2-8]	39
情景模式[菜单3]	40
只振动[菜单3-1]	40
无声[菜单3-2]	40
标准[菜单3-3]	40
大声[菜单3-4]	41
耳机[菜单3-5]	41
车内[菜单3-6]	41
设定[菜单4]	43
闹钟[菜单4-1]	43
日期和时间[菜单4-2]	43
手机设定[菜单4-3]	44
通话设定[菜单4-4]	45
安全设定[菜单4-5]	48
网络设定[菜单4-6]	50
GPRS设定[菜单4-7]	51
恢复初始设定[菜单4-8]	51

呼叫转移[菜单5]	52
所有语音来电[菜单5-1]	52
占线时转移[菜单5-2]	52
无应答时转移[菜单5-3]	52
不在服务区转移[菜单5-4]	52
所有数据来电[菜单5-5]	52
所有传真来电[菜单5-6]	52
取消全部转移[菜单5-7]	53
记事本[菜单6]	54
日程表[菜单6-1]	54
备忘录[菜单6-2]	54
电话本[菜单6-3]	55
娱乐和应用[菜单7]	60
游戏[菜单7-1]	60
我的文件夹[菜单7-2]	60
单位转换器[菜单7-3]	60
计算器[菜单7-4]	61
世界时间[菜单7-5]	61
语音录音机[菜单7-6]	61
红外线[菜单7-7]	61
互联网[菜单8]	62
主页[菜单8-1]	62
书签[菜单8-2]	62
Push 信息[菜单8-3]	62
情景模式[菜单8-4]	63
转到URL[菜单8-5]	64
缓存设定[菜单8-6]	64
WAP信息[菜单8-7]	65
重设情景模式[菜单8-8]	65
在线功能表	66
SIM服务[菜单9]	67
保养和维护	68
技术规范	69

检查以确保您拥有如下显示的所有部件。



<可选附件>

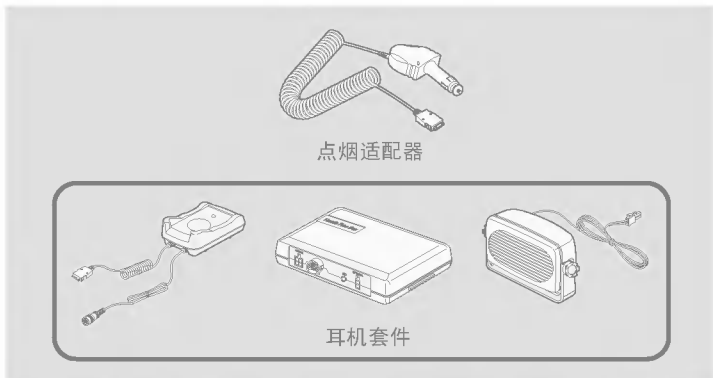

手机正面

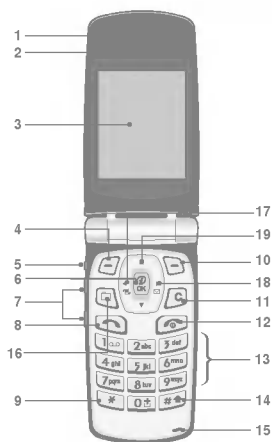

- 1 听筒
- 2 活动折叠盖
- 3 显示屏
- 4 左软键
- 5 录音键
- 6 OK/WAP热键
- 7 上/下侧键
- 8 发送键
- 9 *键
- 10 右软键
- 11 清除键
- 12 结束/开关键
- 13 数字键
- 14 #键
- 15 话筒
- 16 书签键
- 17 情景模式热键
- 18 讯息键
- 19 导航键

手机背面

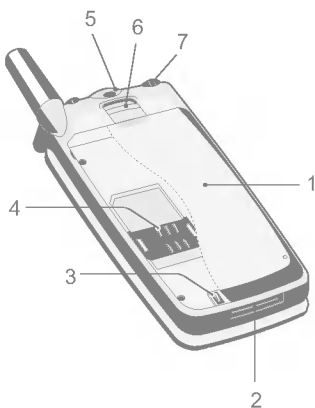

- 1 电池
- 2 电缆接口/
电池充电接口/
免提车用组合接口
- 3 电池终端
- 4 SIM卡插槽
- 5 手带孔
- 6 电池锁
- 7 耳机接口

手机LCD小屏幕















您不须打开翻盖即可看到接收文字讯息或语音讯息的屏幕图标。此外，您也可在接到来电及拨湖电话时查看对方的姓名及号码。

● 注意



- 如果接听电话时，对方姓名或电话号码未存在电话簿中，屏幕上会显示「新来电」。

以下是手机的主要元件。

键盘描述

按 键	
	<p>左软键/右软键 此软键执行出现在其上方屏幕上所指示的功能。</p>
	<p>导航键 可在姓名、电话号码、功能表或设定选项中翻阅。 确认键 可直接进入情景模式菜单，长按该键也可以进入振动模式。 讯息键 可直接进入信息菜单。 OK/WAP热键 按该键可以直接连接到WAP。</p>
	<p>书签键 / 删除键 按  键可直接进入书签表。按  键可删除您输入的字元。</p>
	<p>发送键 您可以拨打电话号码及接听来电。如果您直接按该键而没有输入任何号码，您的手机将显示您最后拨打的号码。</p>
	<p>数字键 这些键主要用来在待机模式下拨号以及在编辑模式下输入。数字或字符。如果长按以下各键：</p> <ul style="list-style-type: none"> • 长按  进入语音信箱。 • 长按  拨打国际电话。 • 长按  至  可以快速拨号。
	<p>结束话 / 开关键 用来结束通话或拒接来电。该键也可以用作开关键。按住该键几秒即可开机或关机。</p>

侧键

按键	
	上/下侧键 您可以在待机模式下控制按键音量，也可以在通话过程中控制音量。
	录音键 长按该键即可启用录音功能。

字母数字键

字母和数字键的对应关系如下。









按键	
	. ! ' 1 , - ? @ _
	A B C 2 Ä Å Á Â Ã Ä Æ Ç a b c ä å á â ã ä å ç
	D E F 3 È Ê Ë É Ê Ë d e f è é ê ë
	G H I J K L 4 G H I J K L g h i j k l
	J K L 5 j k l
	M N O 6 Ñ Ò Ó Ô Õ Æ m n o ñ ò ó ô õ æ
	P Q R S T 7 p q r s t
	T U V 8 Ù Ú Û Ü t u v ù ú û ü
	W X Y Z 9 w x y z
	0, ø [空格键]

以下为手机屏幕显示的常见图标描述。

屏幕上的图标

图标/指示符	
	表示网络信号的强度
	连接成功。
	您正在使用漫游服务。
	此图标表示您可使用GPRS服务。
	闹铃已设定并启动。
	显示电池电量
	收到文本信息。
	收到语音信息，这需要您申请的网路支持。
	所有音频信号已关闭。
	收到电子邮件。
	音频情景模式中的大声菜单。
	音频情景模式中的静音菜单。
	音频情景模式中的耳机菜单。
	音频情景模式中的车用菜单。
	音频情景模式中的标准菜单。
	您可以通过WAP使用Push资讯服务。
	查看日程表

顶部菜单图标

图 标	
	信息
	通话记录
	情景模式
	设定
	呼叫转移
	记事本
	娱乐和应用
	互联网
	SIM服务(该功能视SIM卡和网络服务而定)

① 插入SIM卡

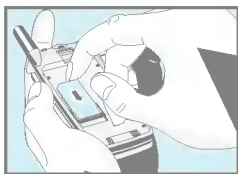

在手机背面查找SIM卡插槽的位置。
遵循以下步骤插入SIM卡。

1. 如果装有电池，则先移除电池。
2. 将SIM卡滑入银色弹夹下的插槽中，金色连接器向下，切角向右。

● 注意

- 安装前请确保手机关机并移除电池。
- SIM卡的金属接触片很容易刮伤。操作和安装过程需要特别小心。请遵循SIM卡安装指南。

② 安装电池

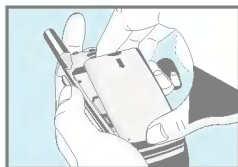

1. 将电池置于手机背面。

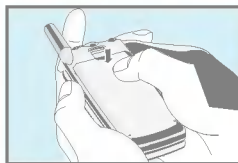

2. 向下推，直到听见一声卡嗒声。

③ 给电池充电

要用旅行充电器为手机充电，您必须先装上电池。



1. 将旅行充电器的一端插入手机底部。

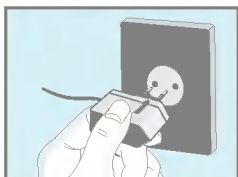

2. 将旅行充电器的另一端连接到墙上的AC电源插座。
只可使用原装充电器。



● 警告

- 不可强行插入充电接口，因为这将损坏手机和/或旅行充电器。

④ 断开充电器

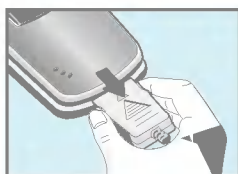



按充电器适配器两侧的按钮，
将其与手机断开。

● 注意

- 更换电池后，记得将已用过的电池充满电。
- 充电时不要移除电池或SIM卡。

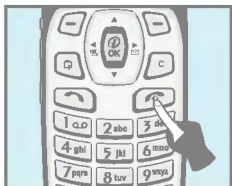
① 开机



1. 按住  键直到听见一声提示音。
2. 取决于PIN码设定，您可以输入或不输入PIN码。
3. 如果您的手机连接到网络，则会显示网络名称。

② 关机

在待机模式下，按住  键，直到您听见一声提示音。

您可以使用该节中描述的访问密码来避免他人使用您的手机。可以利用 [菜单4-5-4] 来更改访问密码（除PUK和PUK2码外）。

PIN码（4至8位数字）

PIN码(个人识别号码)防止他人在未经授权的情况下使用您的SIM卡。PIN码通常与SIM卡一起提供。当PIN码设定为启动时，您的手机每次开机时都会要求您输入PIN码。相反，当PIN码设定为关闭时，您的手机则无需PIN码即可直接连接到网络。

PIN2码（4至8位数字）

某些SIM卡会提供PIN2码，用于访问一些功能，例如：通话费用通知、固定电话号码。这些功能只有在您的SIM卡支持下才可用。

PUK码（4至8位数字）

更改锁定的PIN码需要PUK码(私人解锁密码)。PUK码与SIM卡一起提供。否则，请与您的服务提供商联系以索取密码。如果您丢失此密码，请同样与您的服务提供商联系。

PUK2码（4至8位数字）

某些SIM卡会提供PUK2码，用于更改锁定的PIN2码。如果您丢失了该密码，请同样与您的服务提供商联系。



安全性密码（4至8位数字）

安全密码可以防止他人在未经授权的情况下使用您的手机。通常与手机一起提供，此密码用于删除所有电话条目和启动初始设定菜单。原始手机安全密码为“0000”。



拨打电话

1. 输入电话号码（加上区码）。要修改屏幕上的号码时，请按 ，。
2. 按  键拨打号码。
3. 要结束通话时，按  键。



用 [发送键] 打电话

1. 按  [发送键]，您即可查看最近未接、已接及曾拨的电话号码。
2. 选择列表中您要拨打的号码。
3. 按  [发送键]。

国际电话

1. 按住  键可输入国际拨号前码。“+”键可取代国际拨号前码。
2. 输入国码、区码和电话号码。
3. 按  键。

从电话簿拨号



1. 在待机模式下，按  键 [电话本]。
2. 当屏幕上显示电话簿的目录时，请按  键选择搜寻。
3. 依姓名或号码搜寻出您要拨号的项目之後，按  键拨号。

快速拨号

请参阅电话簿 - 快速拨号 [菜单6-3-4] 的详细说明。



要在电话簿中选择一个功能表，在待机模式下按  [电话本]，然后滚动到所要的项目。您也可以通过记事本进入该功能表。

1	查找	查找特定姓名。
2	添加新姓名	添加新姓名。
3	通话群组	可让您显示群组列表并作选择。您可以编辑其名称，并为每个群组设定铃声、图标、LED颜色。
4	快速拨号	最多可指定8个( - )单键拨号。
5	设定内存	设定内存并通过变量、姓名和号码查找对象。
6	全部删除	删除电话簿或SIM卡及手机内存的所有数据。
7	全部复制	将手机内存中的条目复制到SIM卡或将SIM卡中的条目复制到手机内存。
8	信息	可以检查内存状态、SDN(服务拨号)、以及本手机号码。



1 信息

- 1 写信息
- 2 收件箱
- 3 发件箱
- 4 信息服务
- 5 语音信息
- 6 信息报告
- 7 常用短语
- 8 设定
- 9 全部删除



2 通话记录

- 1 未接来电
- 2 已接来电
- 3 拨出电话
- 4 清除近期呼叫
- 5 通话计时
- 6 通话计费
- 7 费用设定
- 8 GPRS信息



3 情景模式

- 1 只振动
- 2 无声
- 3 标准
- 4 大声
- 5 耳机
- 6 车内



4 设定

- 1 闹钟
- 2 日期和时间
- 3 手机设定
- 4 通话设定
- 5 安全设定
- 6 网络设定
- 7 GPRS设定
- 8 恢复初始设定



5 呼叫转移

- 1 所有语音来电
- 2 占线时转移
- 3 无应答时转移
- 4 不在服务区转移
- 5 所有数据来电
- 6 所有传真来电
- 7 取消全部转移



6 记事本

- 1 日程表
- 2 备忘录
- 3 电话本



7 娱乐和应用

- 1 游戏
- 2 我的文件夹
- 3 单位转换器
- 4 计算器
- 5 世界时间
- 6 语音录音机
- 7 红外线



8 互联网

- 1 主页
- 2 书签
- 3 Push 信息
- 4 情景模式
- 5 转到URL
- 6 缓存设定
- 7 WAP信息
- 8 重设情景模式



9 SIM服务



该功能视SIM卡和网络服务而定。



该功能表包括与SMS（短信息服务）、语音邮件、及网络服务信息相关的功能。



写信息[菜单1-1]

您最多可写入并编辑480个字符的文本信息。此外，您可以查询正在写入的信息中剩余的字符数。

1. 按  [确定] 进入信息功能表。
2. 如果您想编写新信息，在功能表中选择写信息。
3. 输入信息。
4. 当您写完信息后，按  [选项]。接下来，手机屏幕将显示下列选项。

发送

发送文本信息。

1. 输入信息接收方的手机号码。
2. 按  [确定]。如果您不想发送，则按  [返回]。

保存

将信息储存在发件箱中。

如果信息保存到发件箱，按  [确定]。如果不要保存，则按  [返回]。

插入常用短语

名片项目为姓名、手机号码、公司电话、传真和电子邮件。您可以将名片添加到信息中。

EMS服务

您的网络必须支援此服务，您才能使用EMS。

附加图片

如果您想在发送信息时附加图片，您可以通过EMS选择。预设图片为LG徽标。

附加动画

如果您想在发送信息时附加动画，您可以通过EMS选择。此外，您可以从15种动画中选择想要的一种。

附加声音

如果您想在发送信息时附加声音，您可以通过EMS选择。



● 注意

- 因为G7020手机与其它手机未必兼容，您可能无法利用EMS收发讯息。

eZi字典

您可添加、删除及修改eZi字典内的字辞。如果您将字辞储存在字库内，它的优先顺序将比其它字辞高。

• 如何将文字加入字库中

1. 翻阅功能表以标示出eZi字典。
2. 若字库内尚未储存任何文字，屏幕上会出现<无文字>的讯息。当您将一个文字存入字库后，即可看到一个文字表。
3. 按  键。
4. 输入一个字之后，按  [确定]。

• 如何删除字库中的文字

1. 翻阅功能表以标示出eZi字典。
2. 选择您要删除的文字，然后按  [选项]。
3. 选择删除 功能表。

• 如何修改字库中的文字

1. 翻阅功能表以标示出eZi字典。
2. 选择您要修改的文字，然后按  [选项]。
3. 选择修改菜单。

如何使用eZi文本

eZi文本模式可让您快速简单地输入文字。只要每个字符按键一次，即可得到想要的文字。因此，您无需输入所有字符以组成一个字。

• 如何改变模式

共有4种模式。（eZi模式、数字模式、字母大写模式、字母小写模式）。您可以按 **[05]** 改变并选择其中一种编辑模式。

• 如何使用eZi模式



1. 按 **[确定]** 选择信息。
2. 按 **[确定]** 滚动到写信息。
3. 在eZi文本模式中，您只要按键盘上标有字符的键。此外，您可以按 **[05]** 键加入空格。
4. 写完信息后，按 **[确定]**。

5. 如果您想发送或储存信息，按 **[选项]**。

● 示例

- 要输入“Tomorrow”，您只要按顺序按 **[8 luv]** → **[6 mnc]** → **[6 mnc]**
→ **[6 mnc]** → **[7 pur]**。

● 注意

1. 您可以使用 **[*]** 键更改语言。
2. 一旦按了相应的键，**[更改]** 键则变为“更改”。然后您可以使用 **[更改]** 键（按更改）切换大写形式。例如：you→y.o.u
→Y.O.U→YOU。选定后，**[更改]** 键将重新变为“符号”。

• 如何使用数字模式



您可以使用该模式输入数字，或按  键更改为其它模式。

• 如何使用大写模式





字母模式中有两种子模式。您可以使用  键更改子模式。

• 如何使用小写模式



您可以输入小写字母。

● 注意

1. 如果您想加入空格，按  。
2. 要删除字母，使用  键。

「iChE」输入法

1) 笔画 (ST)：如何使用笔画来输入汉字

随着您逐一地输入汉字笔划，一系列汉字将显示出来。使用 **[*]** 和 **[#*]** 键查看其它汉字选项，并按 **[0 志]** 选择一个汉字。同时，使用 **[0 志]** 和 **[0 志]** 键查找更多汉字。

例如：要输入‘你好’，依次按数字键 **[3 def]**，**[2 abc]**，**[3 def]**；然后您将可以看到第四个字‘你’。按 **[#*]** 键移动光标，再按 **[0 志]** 按钮选择‘你’，然后该字后面将显示可能出现第二个字。另外，您也可以从最开始便一笔一画地输入来查找汉字。

按键	笔划	按键	笔划
[1 a.o]	一	[6 mno]	丿
[2 abc]	丨	[7 pqr]	乚
[3 def]	丿	[8 tuv]	?
[4 ghi]	丶	[9 wxyz]	乙
[5 jkl]	フ	[0 志]	选择键

<汉字笔画表>



● 注意

- **[8 tuv]** 键可以帮助用户在输入第一画后直接查找所需汉字。因此，如果您输入第一画后按 **[8 tuv]** 键，您可以从屏幕上显示的完整汉字列表选择一个汉字。

2) 拼音 (PY) : 如何使用拼音选择汉字。

‘拼音’可以根据汉字对应的英文字母发音查找汉字。

拼音 : 在您输入第一个拼音字母后, 它可以帮您直接查找汉字。

例如 : 要输入‘国民’, 依次按数字键  和 , 屏幕上将显示‘guo’的拼音。选择‘guo’后, 将出现具有此发音的所有汉字。然后您可以从中选择‘国’。继而将出现多个可能接在国之后的汉字。使用  键选择‘民’。



按键	英文字母	按键	英文字母
			MNO
	ABC		PQRS
	DEF		TUV
	GHI		WXYZ
	JKL		选择键

<汉语拼音表>





3) 注音 (Bopomofo) :

若以英文拼音來输入文字, 你可一览所有同音字。

例如你要输入‘你好’, 请按  及  键。接著, 按  找寻‘你’字。再按  键[选择]或  键。

按键	注音	按键	注音
	ㄅ ㄆ ㄇ ㄏ		ㄩ ㄛ ㄜ ㄝ
	ㄉ ㄊ ㄋ ㄌ		ㄝ ㄟ ㄨ ㄩ
	ㄍ ㄎ ㄏ		ㄛ ㄜ ㄝ ㄟ
	ㄐ ㄑ ㄒ		ㄟ ㄨ ㄩ
	ㄙ ㄨ ㄩ ㄜ	 	选择键
	ㄗ ㄘ ㄙ		

收件箱[菜单1-2]

当您收到文本信息时， 符号将显示在屏幕上。您可以将它保存在接收的信息列表中。滚动、选择想要的信息，您可以选择列表下方的全部删除来删除所有接收的信息。读取信息后，按 [选项]访问可用选项。

回复

如果您按 [确定]，则可以发送信息回复发送者。

转发

如果您按 [确定]，则可以将所选信息转发给第三方。

删除

如果您按 [确定]，则可以删除信息。

查找号码

如果信息附有电话号码，您可以提取电话号码并将它保存在电话簿中。同样，您也可以通过该号码呼叫对方。





保存附件

您可以保存附件，例如：图片、声音和动画。

回复来电

您可以按 [发送]回复发送者。

发件箱[菜单1-3]

进入该功能表时，您可以看到发出的信息列表。您可以滚动、选择想要的信息，并按 [确定]读取。如果您想退出发件箱功能表，按 [返回]。此外，您可以选择列表底部的全部删除来删除所有发出的信息。读取信息后，按 [选项]访问以下子功能表。

转发

您可以将信息转发给第三方。

删除

您可以删除信息。

回复

如果信息附有电话号码，您可以提取电话号码并将它保存在电话簿中。同样，您也可以通过该号码呼叫对方。

● 注意

如果您输入数字时隔开，接收方可以分别查看。例如：在示例“12345 67890”中，该号码将在发件箱中显示为 1, 12345 2, 67890

信息服务[菜单1-4]

小区广播信息（CB信息）是网络向手机用户提供的文本信息。他们提供大众信息，例如，天气预报、交通新闻、出租车信息、药品信息和股票价格。每种信息类型都配有一个号码；因此，您可以与服务提供商联系。当您接收到CB信息时，您可以按以下顺序读取：

接收[菜单1-4-1]

- 是

如果您选择该功能表，您的手机将接收小区广播信息。



- 否

如果您选择该功能表，您的手机将不再接收小区广播信息。

收件箱[菜单1-4-2]

您可以读取和删除收到的CB信息。

栏目[菜单1-4-3]

如果您想创建新栏目，按  [确定]。然后，您可以按  [选择] 选择新栏目。如果您已经拥有栏目，您可以按  [选项] 以进行删除、编辑和启动。

提示 [菜单1-4-4]

- 开启

如果您选择该功能，当您收到小区广播信息时，手机会发出一声蜂鸣声。

- 关闭

如果您选择该功能表，尽管您收到小区广播信息，您的手机也不会发出蜂鸣声。

自动显示 [菜单1-4-5]

当您收到CB信息时，将在窗口中自动显示。您可以滚动 、 来读取。

- 开启

信息将自动显示在窗口。

- 关闭

信息不会自动显示在窗口。

语言 [菜单1-4-6] (视网络而定)

您可以按  [确定] 选择语言。然后，团体广播将以您所选的语言显示。如果您使用手机支持的所有语言，选择列表底部的自动。

语音信息 [菜单1-5]

听取语音信息 [菜单1-5-1]

通过该功能表，您可以听取您的语音信息。如果SIM卡或手机中已存有语音邮件中心地址，您的手机将自动连接。否则，手机将要求您输入地址。

语音信箱号码 [菜单1-5-2]

您可以输入语音信箱地址号码。

信息报告 [菜单1-6]

您可以读取和删除信息报告。

常用短语[菜单1-7]

您可以在列表中查看10条预设信息。您可以在编辑前查看10条已保存在列表中的常用短语。其余为<空>。您可以添加新的常用短语。

编辑[菜单1-7-1]

您可以编辑常用短语。

删除[菜单1-7-2]

您可以删除常用短语。

发送[菜单1-7-3]

您可以发送包含常用短语的文本信息。

设定[菜单1-8]

信息中心号码[菜单1-8-1]

您可以输入信息中心地址。

信息类型[菜单1-8-2]

文本、语音、传真、传呼、**X.400**、电子邮件、**ERMES**

通常，信息类型设定为**文本**格式。您可以将文本信息转换为其它格式，以配合接收信息的设备。要获取有关该功能的信息，请与您的服务提供商联系。

信息有效期[菜单1-8-3]

该网络服务可让您设定发送给您的文本信息在信息中心的储存期限。

信息报告[菜单1-8-4]

如果您在该功能表中设定是，您即可查询您的信息是否已成功发送。

回复付费[菜单1-8-5]

发送信息时，可以让接收信息者回复并将回复费用记入您的话费清单。

载体设定[菜单1-8-6]

你可设定连接方式。

- 双重服务
- 只适用于GPRS
- 只适用于GSM

检查内存[菜单1-8-7]

如果您选择该功能表，您将可查看已用内存和内存总量。内存总量是SIM卡和手机内存之和。

全部删除[菜单1-9]

是[菜单1-9-1]

您可以删除收件箱/发件箱中的所有信息。

否[菜单1-9-2]

您可以取消删除收件箱/发件箱中的所有信息。

通话记录[菜单2]

(视网络服务而定)

进入功能表



如果您的网络在服务区内支持呼叫线路识别，您可以查询未接来电、已接来电和拨出电话的记录。

在未接来电、已接来电和拨出电话选项中，您可以：

- 拨打该号码
- 将号码保存在手机中。
- 查看通话日期和时间。
- 修改、删除列表中的号码，或将它保存在手机中。

未接来电[菜单2-1]

该功能表显示最近的已接呵的电话。您可以拨打该号码，也可以保存及查看日期和时间。

已接来电[菜单2-2]

该功能表显示最近的已接呵的电话。您可以拨打该号码，也可以保存及查看日期和时间。

拨出电话[菜单2-3]

该功能表显示最近拨打的电话。您可以拨打该号码，也可以保存及查看日期和时间。

每个功能表中的子菜单：

各目录中的子目录：

查看详细内容

您可以查看拨出号码的详细资料。

删除

您可以删除拨出号码的记录。

储存

您可以储存拨出号码的资料。

呼叫

您可以拨打这个号码。

清除近期呼叫[菜单2-4]

您可以删除所有通话记录。

通话计时[菜单2-5]

该功能表可让您查看最后通话、所有通话、已接来电和拨出电话的确切持续时间。您也可以将通话计时器清零。

最后通话[菜单2-5-1]

如果按  [重设]，您可删除最后通话时间。

已接来电[菜单2-5-2]

如果按  [重设]，您可删除已接来电时间。您需要输入保密码。

拨出电话[菜单2-5-3]

如果按  [重设]，您可以删除拨出电话时间。您需要输入保密码。

所有通话[菜单2-5-4]

如果按  [重设]，您可以删除最后通话/已接来电/拨出电话时间。您需要输入保密码。

通话记录[菜单2]

(视网络服务而定)

进入功能表

通话计费[菜单2-6]

在这些子功能表中，您可以查看通话持续时间和通话费用。

最后通话费用[菜单2-6-1]

该功能可让您查看最后通话费用。您需要输入PIN2码。

所有通话费用[菜单2-6-2]

该功能表可让您查询最后通话、所有通话的费用，余额并将费用清零。要将费用清零，您需要PIN2码。

● 注意

- 您的服务提供商所收取的实际通话费用可能会因网络功能、金额四舍五入和税收等而有所不同。

费用设定[菜单2-7]

通话费用限制[菜单2-7-1]

该网络服务可让您按照计费单位或货币单位限制通话费用。如果您选择剩余金额，待机模式下将显示费用。只要未超过特定通话费用，您即可拨打或接听电话。

设定费率[菜单2-7-2]

手机可以更改费用单位和货币名称。请联系您的服务提供商以获取单位价格。该功能表中，您可能需要PIN2码来选择货币或单位。

自动显示[菜单2-7-3]

当该项设定为开启时，待机模式下将显示提示费用。通话结束时，将显示最后通话费用。

GPRS信息[菜单2-8]

您可查询已在GPRS网络传送的数据量。而且，您亦可查看网上连接时间。

1. 按  键。

1. 卷轴您想查询的资料。选择包括如下：

WAP[菜单2-8-1]

您可以查看使用WAP期间的数据量和在线时间。

- 上次会议[菜单2-8-1-1]

- 所有会议[菜单2-8-1-2]

外接设备[菜单2-8-2]



您可以利用外置式设备（例如序列埠）查看透过GPRS传输的数据量和在线时间。

全部数据[菜单2-8-3]

您可以查看透过WAP和外置式设备传输的总数据量。



在该菜单中，您可以为不同事件、环境和来电群组调节并定制电话提示音。（例如：如果您在汽车内，可以选择车内情景模式等等）

1. 待机模式下，按  [菜单]。
2. 按  直接进入情景模式。

只振动[菜单3-1]

启动

如果您需要振动模式，可以将情景模式调节为只振动。

无声[菜单3-2]

启动

如果您在安静的场所，可以将情景模式调节为无声。

个性化

您可以改变音频情景模式子功能表的设定类型。

标准[菜单3-3]

启动

如果您需要普通模式，可以将情景模式调节为标准。

个性化

您可以改变音频情景模式子功能表的设定类型。

大声[菜单3-4]

启动[菜单3-4-1]

如果您处于嘈杂的环境中，可以将情景模式调节为大声。

个性化[菜单3-4-2]

您可以改变音频情景模式子功能表的设定类型。

耳机[菜单3-5]

启动[菜单3-5-1]

当您戴上耳机时，可以将情景模式调节为耳机。

个性化[菜单3-5-2]

您可以改变音频情景模式子功能表的设定类型。

车内[菜单3-6]

启动[菜单3-6-1]

当您启动免提车用组合时，可以调节该情景模式。

个性化[菜单3-6-2]

您可以更改情景模式子功能表的值。

一组个性化子功能表[菜单3-x-x]

个性化功能表的子功能表如下所示。

响铃方式类型[菜单3-x-x-1]

根据不同环境设定来电提示。

铃声类型[菜单3-x-x-2]

根据不同环境设定铃声类型。

铃声音量[菜单3-x-x-3]

根据不同环境设定铃声音量。

信息提示[菜单3-x-x-4]

当收到信息时，根据不同环境发出提示音：蜂鸣一次、定期响铃、振动、响铃并振动、关闭。

信息提示类型[菜单3-x-x-5]

当收到信息时，根据不同环境设定信息提示音。

按键音量[菜单3-x-x-6]

根据不同环境设定按键音。

● 注意

自动应答

- 该功能只有在您的手机连接到免提车用组合或耳机时启动。
 - 关闭 : 即使您的手机发出响铃，它也不会自动应答。
 - 5秒后 : 5秒后您的手机会自动应答。
 - 10秒后 : 10秒后您的手机会自动应答。



闹钟[菜单4-1]

在该功能表中，您可以设定手机在规定时间发出闹铃。

• 开启

您可以设定启动闹铃的时间[小时和分钟]。

1. 进入功能表
2. 按 $\text{[*]} \text{[0]} \text{[0]}$ [开/关] 选择开启。
3. 如果您想设定启动闹铃的时间，按 $\text{[*]} \text{[时]}$ 、 $\text{[*]} \text{[分]}$ 。
4. 按 $\text{[*]} \text{[0]} \text{[0]}$ 选择重复周期：一次、每天、每周和每月。
5. 按 $\text{[*]} \text{[设定]}$ [设定]。

• 关闭

您可以取消闹铃时间。

1. 进入功能表。
2. 按 $\text{[*]} \text{[0]} \text{[0]}$ [开/关] 选择关闭。
3. 您可以查看信息“关闭闹钟”。

日期和时间[菜单4-2]

手机自身拥有时钟。在该功能表中，您可以设定时间格式为12小时或24小时。



设定时间[菜单4-2-1]

在该功能表中，您可以设定手机时间。

1. 按 $\text{[*]} \text{[选择]}$ 选择设定时间。
2. 输入您想要设定的时间。
3. 按 $\text{[*]} \text{[设定]}$ [设定]。



时间格式[菜单4-2-2]

您可以选择时间格式为12小时或24小时。

1. 按  [选择] 滚动到突出显示的时间格式。
2. 按  [确定] 选择您想要的12小时或24小时格式。

设定日期[菜单4-2-3]

在该功能表中，您可以设定手机日期。

1. 进入功能表。
2. 按  [选择] 选择设定日期。
3. 输入您想要的日期。
4. 按  [设定]。

日期格式[菜单4-2-4]

在该功能表中，您可以设定日期格式。

[Y: 年, M: 月, D: 日]

- 年/月/日
- 日/月/年
- 月/日/年

手机设定[菜单4-3]

您可以按需要完成手机设定。滚动屏幕到手机设定功能表，然后按  [选择]。

语言[菜单4-3-1]

该功能表可让您选择文本显示使用的语言。如果选择自动设定，将根据当前SIM卡选择语言。如果手机不支持SIM卡上的语言，则设定为英语。

墙纸[菜单4-3-2]

您可以按 、 选择一张图片。

LED指示[菜单4-3-3]

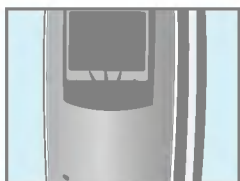

您可以通过来电指示灯设定网络状态。如果您在服务区域内，来电指示灯会闪烁绿灯。相反，如果您不在服务区域内，指示灯将变为红灯。您还可以根据电话簿中的组群设定指示灯颜色。

- **来电[菜单4-3-3-1]**

该功能表可让您选择来电指示灯颜色。

- **待机[菜单4-4-3-2]**

您可以设定待机模式下的指示灯颜色。

- 启动
- 关闭

背景灯[菜单4-3-4]

您可以设定按键时或打开文件夹时背景灯开启的时间长度。

屏幕对比度[菜单4-3-5]

您可以通过按 (⊕, ⊖) 设定需要的LCD亮度。

通话设定[菜单4-4]

在设定功能表中，您可以按 [确定] 设定和通话相关的功能表。

接听模式[菜单4-4-1]

- **打开文件夹[菜单4-4-1-1]**

如果您选择该功能表，仅需打开手机折叠盖便可接听来电。

- 是：您可以启动本功能。
- 否：您可以关闭本功能。

- **按任何键[菜单4-4-1-2]**

如果您选择该功能表，可以按除 [接听]，[挂断] 外的任意键接听来电。

- 是：您可以启动本功能。
- 否：您可以关闭本功能。

发送本机号码[菜单4-4-2]

(需要网络支持及预先注册)

设定该功能后，您可以将手机号码发送给第三方。

- **通过网络设定[菜单4-4-2-1]**

如果您选择该功能，您可以根据两条服务线路，例如，线路1或线路2，发送您的手机号码。

- **开启[菜单4-4-2-2]**

如果您选择该功能，您可以将手机号码发送给第三方。即，接收方手机上将显示您的手机号码。

- **关闭[菜单4-4-2-3]**

如果您选择该功能，您将不能发送您的手机号码。

呼叫等待服务[菜单4-4-3]

如果启用该服务，您可以接收待接来电。如果关闭该服务，您则不能识别待接来电。

- **启动[菜单4-4-3-1]**

启动相应服务。

- **取消[菜单4-4-3-2]**

取消相应服务。

- **查询状态[菜单4-4-3-3]**

查询服务状态。

自动重拨[菜单4-4-4]

- **开启[4-4-4-1]**

如果启动该功能，您的手机会在拨号无法接通后自动重拨10次。

- **关闭[4-4-4-2]**

您的手机不会在未接通后重拨。

分钟提示[菜单4-4-5]

如果您选择开启，可以在通话期间通过每分钟的蜂鸣声检查通话时间。

使用的线路[菜单4-4-6]

该功能只有在服务提供商支持双线路服务时使用。手机需要注册两个独立的号码。由您选择当前使用的手机号码。如果您的服务提供商支持该功能，会显示下列功能表。

1. **线路1**：选择线路1作为当前的手机号码。
2. **线路2**：选择线路2作为当前的手机号码。

● 注意

- 如果您在不支援双线路服务的范围内选择线2，您将无法拨打电话。

数据传输模式[菜单4-4-7]

（需网络支持）

在单一号码服务的情况下，您可以使用手机和连网的PC来发送和接收传真、数据及语音。如果您选择该模式，您可以用任意模式接收数据、传真或语音。一旦您进入该功能表，将显示以下选项。

- **单一模式**
您可以接收语音来电。
- **语音和传真**
您可以在语音来电后接收数据来电

● 注意

- 单一号码服务是指传真号码或数据服务号码与语音服务号码一致。这些模式视网络功能而定。

封闭用户群组[菜单4-4-8]

(视网络而定)

使用该功能可以限制手机拨打属于某个用户组群的号码。当使用该功能时，每个拨出电话会联接一个组群目录。如果已经指定一个组群目录，它将适用于所有拨出电话。如果没有指定组群目录，网络会使用优先目录(一个储存在网络中的特定目录)。

预设：设定所选的封闭用户群组目录。





开启：启动并编辑封闭用户群组名称和封闭用户群组目录。

关闭：删除所选的封闭用户群组。

安全设定[菜单4-5]

要求PIN码[菜单4-5-1]

在该功能表中，您可以设定手机在开机时需要SIM卡PIN码。如果启动该功能，您将被要求输入PIN码。

1. 在待机模式下按  [菜单]。
2. 按  键直接进入或使用  和  进入设定。
3. 滚动到突出显示的安全设定菜单。
4. 按  [确定] 选择要求PIN码。
5. 您可以查看以下子功能表。
 - 启动：启动PIN码要求。
 - 关闭：关闭PIN码要求。

呼叫限制服务[菜单4-5-2]

(视网络而定)

呼叫限制服务可以防止您的手机拨打或接听某种电话。该功能需要呼叫限制密码。您可以查看以下子菜单。

- **所有拨出电话**
所有拨出电话的限制服务。
- **拨出国际长途**
所有拨出的国际电话的限制服务。

- **国际除本地**
除本地网络外所有拨出的国际电话的限制服务。
- **所有来电**
所有来电的限制服务。
- **漫游时来电**
当漫游时所有来电的限制服务。
- **所有数据来电**
您可以限制所有数据来电。
- **所有传真来电**
您可以限制所有传真来电。
- **所有呼叫限制取消**
您可以取消所有通话限制服务。

呼叫限制服务子功能表







- **启动[菜单4-5-2-x-1]**
如果您向服务提供商申请呼叫限制服务，即可使用。
- **取消[菜单4-5-2-x-2]**
您可以取消该功能。
- **查询状态[菜单4-5-2-x-3]**
您可以查询呼叫限制服务的当前状态。

● 注意

- 如要使用通话限制服务，您必须输入网络密码。







固定拨号[菜单4-5-3] (视SIM卡而定)

您可以限制拨打所选的电话号码。这些号码由PIN2码保护。

1. 在待机模式下按  [菜单]。
2. 按  键直接进入或使用  和  进入设定。
3. 滚动到突出显示的**安全设定**菜单。
4. 按  [确定]选择固定拨号。
5. 输入PIN2码，然后按  [确定]。
6. 如果PIN2码正确，您可以查看以下子菜单。
 - 启动 : 您可以限制拨打所选的电话号码。
 - 关闭 : 您可以不限制号码拨打电话。
 - 固定拨号 : 您可以查看固定拨号并添加、编辑、删除。

更改密码[菜单4-5-4]

您可以更改访问密码：PIN、PIN2、安全性密码、限制密码。

1. 在待机模式下按  [菜单]。
2. 按  键直接进入或使用  和  进入设定。
3. 滚动到突出显示的**安全设定**菜单。
4. 按  [确定]选择更改密码。
5. 如果您想更改保密码/PIN/PIN2/限制密码，按  [确定]。
6. 输入新的保密码/PIN/PIN2/限制密码（需网络支持）。

网络设定[菜单4-6]

您可以选择能够自动或手动注册的网络。通常，网络选择设定为**自动**。

自动[菜单4-6-1]

手机会自动选择在您区域内的可用网络。

手动[菜单4-6-2]

手机会找到可用的网络列表并显示出来。然后您可以选择您想使用的网络，前提是该网络与您本地网络运营商有漫游协议。

GPRS设定[菜单4-7]

当您使用GPRS接驳互联网时，您可建立数据通讯。为能使用GPRS，您必须先设定以下选项：

终端类型[菜单4-7-1]

- 双重服务[菜单4-7-1-1]
- 只适用于GPRS[菜单4-7-1-2]
- 只适用GSM[菜单4-7-1-3]

首选GPRS[菜单4-7-2]

- 自动[菜单4-7-2-1]
- 手动[菜单4-7-2-2]

外接设备[菜单4-7-3]

当您利用外置式设备透过GPRS使用互联网时，您可以设定包含APN、IP地址、DNS、使用者ID和密码设定的5组上网设定。网络亦可能会提供您这些资讯。

恢复初始设定[菜单4-8]

您可以通过选择设定/初始设定选项将手机恢复为预设配置，然后确认该项选择。另外，要启动该功能，您需要保密码。





呼叫转移[菜单5]

(需网络支持)

进入功能表



呼叫转移服务可让您将语音来电、传真来电和数据来电转移到其它号码。要获取更多信息，请联系您的服务提供商。

1. 在待机模式下按  [菜单]。
2. 按  [确定] 直接进入或使用  和  进入呼叫转移。

所有语音来电[菜单5-1]

无条件转移语音来电。

占线时转移[菜单5-2]

手机正在通话时转接语音来电。

无应答时转移[菜单5-3]

无人接听时转接语音来电。

不在服务区转移[菜单5-4]

手机关机或不在服务区时转接语音来电。

所有数据来电[菜单5-5]

无条件转接到与PC连接的号码。

所有传真来电[菜单5-6]

无条件转接到与传真连接的号码。

子功能表[菜单5-x-x]

呼叫转移功能表的子功能表，如下所示。

启动[菜单5-x-1]

启动相应服务。

- **转移到语音信箱**

转发到信息中心。不是所有数据来电和所有传真来电功能表都包括此功能。

- **转移到其它号码**

输入要转接的号码。

取消[菜单5-x-2]

关闭相应服务。

查询状态[菜单5-x-3]

查询相应服务的状态。

取消全部转移[菜单5-7]

取消所有呼叫转接服务。



日程表[菜单6-1]

当您进入该菜单后会出现一个日历。屏幕顶端是日期和图标部分。如果您更改日期，日历会按照日期更新。方形光标用于定位某天。如果您看到日历上的某天有下划线，即代表当天有一个对应的日程表。该功能可以提醒您记住日程表和备忘录。如果您设定提示闹钟，手机会发出闹钟声。

编辑[菜单6-1-1]

您可以在所选日期上添加提示，也可以更改该日期。

删除[菜单6-1-2]

您可以删除已设定的提示。

添加新姓名[菜单6-1-3]

您最多可以添加30条提示，每条最长为30个字符。



查看所有日程表[菜单6-1-4]

显示所有日程表中设定的提示。

转到日期[菜单6-1-5]

您可以查询已经输入了的日期。

备忘录[菜单6-2]

1. 滚动屏幕以突出显示备忘录。
2. 按  [确定]。
3. 输入备忘录，然后按 。
4. 您可以查看以下子功能表。

编辑[菜单6-2-1]

您可以编辑所选备忘录。

删除[菜单6-2-2]

您可以删除所选备忘录。

添加新姓名[菜单6-2-2]

您最多可以添加20个备忘录，每个备忘录最多40个字符。

全部删除[菜单6-2-4]







您可以删除以前设置的所有备忘录。

电话本[菜单6-3]

您可以创建个人电话簿，将电话号码和相应姓名保存在其中。拨打电话的简便方法是拨打手机中保存的电话号码和姓名。

查找[菜单6-3-1]













(从电话簿呼叫)

1. 首先，在待机模式下按  [电话本] 打开电话簿。您也可以滚动 、 进入电话簿。
2. 按  [确定] 进入查找。
3. 您可以通过姓名和查找条目。
4. 选择  [查找]。
5. 如果您想编辑、查看、删除、复制和呼叫条目，选择  [选项]。将显示以下功能表。
 - 编辑 : 您可以按  [确定] 来编辑姓名、号码、电子邮件和传真。
 - 查看详细内容 : 您可以查看姓名和号码的详细内容。
 - 删除 : 您可以删除条目。
 - 复制 : 您可以将条目从SIM卡复制到手机或从手机复制到SIM卡。
 - 呼叫 : 您可以呼叫所选条目。

添加新姓名[菜单6-3-2]



您可以使用该功能添加电话簿条目。

手机内存容量为255个条目。SIM卡内存容量取决于移动电话服务提供商。您可以在手机内存中保存含50个字符的姓名，或将其保存在SIM卡上。可保存的数量取决于SIM卡。您也可以在SIM卡或手机内存中保存电话簿条目。如果您想更改内存，可以转到设定内存[菜单6-3-5]并选择SIM卡或手机。

1. 首先，在待机模式下按  [电话本] 打开电话簿。您也可以滚动 、 转到电话簿功能表。
2. 滚动屏幕以突出显示添加新姓名，并按  [确定] 进入。
 - **SIM卡：**您可以添加条目的姓名和号码。
 - a. 输入要添加的姓名。
 - b. 按  [确定]，然后输入号码。
 - c. 按  [确定]，然后选择群组。
 - d. 按  [确定]。
 - **手机：**您可以添加姓名、手机号码、家庭电话号码、公司电话号码、电子邮件地址、群组和备忘录。
 - a. 输入要添加的姓名。
 - b. 按  [确定]。
 - c. 按  [确定] 输入以下手机号码、家庭电话、公司电话、电子邮件地址。您也可以按 、 选择一个群组并输入备忘录（最长50个字符）。
 - d. 按  [确定]。

通话群组[菜单6-3-3]

您可以设定6个群组列表和其它。

1. 在待机模式下按  [电话本] 进入电话簿。
2. 滚动到通话群组对象，然后按  [确定] 进入该功能表。
3. 将显示每个群组列表：**家庭、重要人士、朋友、同事、群组1、群组2、其它。**
4. 按  [选项] 选择要管理的群组名称。
5. 然后将显示除其它外的下列子功能表。

- **成员列表**

您可以编辑、删除、复制和呼叫群组。

- **重命名**

您可以修改群组名称。

- **群组铃声类型**

您可以选择每个群组的铃声。

- **群组图标**





您可以选择每个群组的图标。

- **LED颜色**

您可以选择每个群组的LED指示灯颜色。



快速拨号[菜单6-3-4]

您可以为姓名列表指定 按键  -  中的任一键。长按2-3秒即可直接呼叫。

1. 首先在待机模式下按  [电话本] 打开电话簿。您也可以滚动 ()、() 进入电话簿。
2. 滚动到快速拨号，然后按  [确定] 进入该功能表。
3. 将显示每个快速拨号。
4. 如果您想添加快速拨号，选择<空>。然后，您可以在电话簿中查找姓名。
5. 如果您选择快速拨号指定的姓名，您可以查看下列子功能表。
 - **更改：** 您可以更改指定的快速拨号。
 - **删除：** 您可以删除指定的快速拨号号码。





设定内存[菜单6-3-5]

您可以设定首选内存，包括SIM卡或手机。

1. 首先，在待机模式下按  [电话本] 打开电话簿。
2. 滚动到**设定内存**，然后按  [确定] 进入。
3. 然后将显示下列子功能表。
4. 选择SIM卡或手机，然后按  [确定]。



全部删除[菜单6-3-6]

您可以删除SIM卡、手机中的所有条目。该功能需要密码。

1. 在待机模式下按  [电话本] 进入电话簿。
2. 滚动到全部删除，然后按  [确定]。
3. 然后选择要清除的内存：**SIM卡、手机**。
4. 然后您将被要求输入密码。
5. 按  [确定]，或按  [返回] 取消。

全部复制[菜单6-3-7]

您可以将条目从SIM卡内存复制/移动到手机内存或从手机内存复制/移动到SIM卡内存。

1. 首先，在待机模式下按  [电话本] 打开电话簿。
2. 滚动到全部复制，然后按  [确定] 进入该菜单。
3. 然后将显示下列子功能表。

- **从SIM卡转到手机[菜单6-3-7-1]**

将SIM卡中的条目复制到手机内存。

- **从手机转到SIM卡[菜单6-3-7-2]**

将手机内存中的条目复制到SIM卡。

- **保持原有记录[菜单6-3-7-x-1]**

所有原有条目和重新定位的条目都将保存在内存中。

- **删除原有记录[菜单6-3-7-x-2]**





删除原有条目，将重新定位的条目保存在内存中。

信息[菜单6-3-8]

您可以选择服务拨号、查询内存和本手机号码列表。





- **服务拨号[菜单6-3-8-1]**

使用该功能访问您的网络提供商提供的特殊服务列表（如果SIM卡支持）。

1. 首先，在待机模式下按  [电话本] 打开电话簿。
2. 滚动到信息的服务拨号，然后按  [确定] 进入。
3. 将显示可用服务的名称。
4. 使用 、 选择一个服务，按  [发送]。

- **检查内存[菜单6-3-8-2]**

该功能可让您查看电话簿的可用内存和已用内存。

1. 首先，在待机模式下按  [电话本] 打开电话簿。您也可以滚动 、 转到电话簿功能表。按  [确定] 选择信息。
2. 滚动到查询内存，然后按  [确定] 进入该功能表。

- **本机号码(需SIM卡支持)[菜单6-3-8-3]**

您可以通过SIM卡上查询本手机号码。

如果本手机号码为空，您可以添加新号码。您也可以修改和删除号码。



游戏[菜单7-1]

您的手机为您提供游戏。

我的文件夹[菜单7-2]

你可以查看，删除以及处理下载的内容。

图片[菜单7-2-1]

动画[菜单7-2-2]

声音[菜单7-2-3]

每一个主要目录的子菜单 [菜单7-2-x-x]

- 编辑主题 [菜单7-2-x-1]

你可以查看，删除以及处理下载的内容。

- 删除 [菜单7-2-x-2]

您可以删除某一个下载内容。

- 全部删除 [菜单7-2-x-3]

您可删除所有下载内容。









单位转换器[菜单7-3]

该功能可将任何单位转换为您需要的单位。有4种可以转换的单位类型：长度、宽度、重量和体积。

1. 您可以通过按 [下一个] 键选择4种单位类型中的一种。
2. 使用 、 选择当前值，然后您可以使用 、 设定标准值。
3. 使用 、 选择您想转换的值。
4. 在空白处输入数字。
5. 如果您想结束转换过程，按 或 [返回]。





计算器[菜单7-4]

该功能表包含的标准功能包括：+、-、×、÷：加、减、乘、除。

1. 通过按数字键输入数字。
2. 使用 、、、 选择计算符号。
3. 然后在符号后输入数字。
4. 再按  [结果] 键或  [确定] 键查看计算结果。
5. 如果您想继续计算，重复上述步骤。
6. 使用  [返回] 键清除所有数字或符号。如果您想结束计算过程，按  键。

世界时间[菜单7-5]

您可以查看世界各个城市的时间，也可以设定当前时间为所选的城市时间。

1. 按 、 选择某时区内的一个城市。
2. 如果您使用  键， 可以查询处于所选国家同一时区内的其它城市。您可以设定当前时间为所选的城市时间。按  [返回] 键退出功能表。

语音录音机[菜单7-6]

您可以保存和播放3条语音信息。每条信息最长为30秒。

红外线[菜单7-7]

如果您启动该功能，您可以通过红外线使用PC同步。

● PC同步化

电脑同步是一个透过数据传输线在电脑与手机之间交换数据的程式。因此，如果您要使用这项功能，您必须购买相关配件套件。如需更多资讯，请参阅光碟内的电脑同步说明档案。



您的手机支持基于无线应用协议(WAP)的服务。您可以访问您的网络运营商所支持的服务。该服务功能表可让您获取有关新闻、天气预报和飞机时刻表之类的信息。

主页[菜单8-1]

返回主页。主页可以是所使用的情景模式下定义的网站。如果没有在情景模式下定义，则由服务提供商定义。

书签[菜单8-2]

您最多可以保存50个书签。滚动到想要的书签并按  [选项] 键使用下列选项。

- 连接 : 连接到所选书签。
- 添加新姓名 : 手动保存新书签。
- 修改 : 修改所选书签的地址。
- 删除 : 从书签列表中删除所选书签。

● 注意

- 如果还没有保存任何书签，则只有“添加新姓名”功能表可用。

Push 信息[菜单8-3]

您可以管理Push 信息和信息。

收件箱[菜单8-3-1]

你可以读取或删除Push资讯。

接收[菜单8-3-2]

你可以设置选项以决定是否接收资讯。

情景模式[菜单8-4]

您最多可以设定5个情景模式，但每次只能启动其中的一个。滚动屏幕到所要的情景模式并按  进入可用的选项。

启动[菜单8-4-1]

启动所选的情景模式

设定[菜单8-4-2]

编辑和更改所选情景模式的WAP设定。

- **主页[菜单8-4-2-1]**

该设定可让您输入您想作为主页使用的网站地址(URL)。您不需要在每个URL前键入“http://”，因为WAP浏览器会自动加入。

- **显示图像[菜单8-4-2-2]**

您可以选择是否要显示WAP卡上的图像。

- **连接类型[菜单8-4-2-3]**

连接类型的选项为**临时**或**持续**，视您所使用的网关而定。

连续：以连接为导向的服务。

临时：无连接服务。

- **安全设定[菜单8-4-2-4]**

该选项可以设定为**无**或**安全**，视网关而定。如果您想连接“安全”，请选择**安全**。否则，请选择**无**。网关应该支持该功能。

- **网关信息[菜单8-4-2-5]**

- **载体[菜单8-4-2-6]**

你可设定连接方式：**GPRS** 或**数据**设定。

- 数据设定
- GPRS

- **数据设定[菜单8-4-2-7]**

当载体[菜单8-4-2-6]设定为数据时显示该功能表。

IP地址 : 输入访问WAP网关的IP地址。

拨号 : 输入访问WAP网关的拨号号码。

用户ID : 拨号服务器(不是WAP网关)的用户身份。

密码 : 拨号服务器(不是WAP网关)识别您身份所需的密码。

呼叫类型 : 选择数据来电的类型: 模拟或数字(ISDN)。

呼叫速度 : 数据连接的速度。

- **待机计时[菜单8-4-2-8]**

超过设定的限制时间(30-300秒)后, 如果没有数据传输, 服务连接将自动断开。

重命名[菜单8-4-3]

修改情景模式名称。

邮件服务器[菜单8-4-4]

保存您经常使用的电子邮件URL地址。

- **连接**

连接到您配置为电子邮件服务器的URL。

- **修改地址**

输入电子邮件URL地址。

转到URL[菜单8-5]

您可直接移至您想要浏览的网站。在此功能表下, 您也可以修改网址。

缓存设定[菜单8-6]

您可以删除缓存内容或更改缓存模式。

清空缓存[菜单8-6-1]

缓存内容将被清除。

缓存查询[菜单8-6-2]

您可以查询缓存。

- **经常查询[菜单8-6-2-1]**
只要下载或浏览URL，就会查询缓存。
- **只适用启动[菜单8-6-2-2]**
只有启动WAP时才查询缓存。
- **关闭[菜单8-6-2-3]**
从不查询缓存。在该设定中，缓存可以被视作取消。

WAP信息[菜单8-7]

您可以查看关于G7020 WAP的信息。

重设情景模式[菜单8-8]

您可以重设情景模式，返回初始设定。

在线时，您可以查看下列数据。

■ 主页

相同于[菜单8-1]

■ 再载

再下载当前页面。

■ 书签

与[菜单8-2]相同

■ 另存为书签

将当前URL保存为书签。您也可以修改书签标题。

■ 讯息

■ 加入讯息

■ 转到URL

与[菜单8-5]相同。

■ 到电邮服务器

将当前URL连接到电子邮件服务器。

■ 设电邮服务器

将当前URL保存为电子邮件服务器。

■ 清除缓存

删除缓存内容。

您的服务供应商可透过SIM卡提供特殊的应用服务，例如家庭银行、股市等等。如果您已申请这类服务，该服务名称将会出主目录的尾端现在。有了SIM卡服务目录，您的手机即可应付未来的应用需要，而且可支援您的服务供应商提供新增的服务。欲知详情，请联络您的服务供应商。

使用手机时，请遵循以下基本安全注意事项。

- 请勿用湿手接触适配器。
- 请勿拆卸手机。（如果需要修理，请找合格的专业技术人员帮忙。）
- 请远离电子仪器，例如：电视机、收音机或个人计算机。
- 请将手机远离热源，例如：电器或电热烹饪设备。
- 小心轻放。
- 请勿使手机受到机械振动或晃动。
- 如果使用手机套或塑料手机套可能会损坏手机外壳涂层。
- 请用干布擦拭手机外壳。（请勿使用溶解物，如：苯、稀释剂或酒精。）
- 请勿将手机暴露在过多烟雾或灰尘的环境中。
- 请勿让手机接近信用卡或其他附有磁带的卡，否则可能损坏磁带内的资料。
- 请勿让硬物碰撞显示屏，以免损坏机身。
- 请勿让手机受潮或弄湿。
- 使用如耳筒等配件时请份外小心，如无必要，请勿触摸天线。

■ 保管电池

- 在重新充电前，不必完全放电。与其他电池不同，本电池不会因内存原素而影响性能。
- 请只使用LG电池和充电器。LG充电器是特别为发挥电池最长使用寿命而设计的。
- 请勿拆卸或使电池短路。
- 请保持金属触点和电池清洁。
- 请在电池无法满足性能要求时进行更换。电池可以充数百次电，直到需要更换。
- 如果长时间不用电池，请重新充电，以延长使用时间。
- 请勿在阳光下或在湿度高的地方使用电池充电器，如浴室。
- 请勿将电池放置在过热或过冷的地方，这样会影响电池性能。

技术规范

常规

产品名称：G7020

适用网络：GSM 900/DCS 1800

环境温度

最高：+55 °C

最低：-10 °C



GPRS Phone

USER'S MANUAL

MODEL : G7020

Please read this manual carefully before operating your set.

Retain it for future reference.

G7020 has a polished style which provides users' a better feel and convenience.

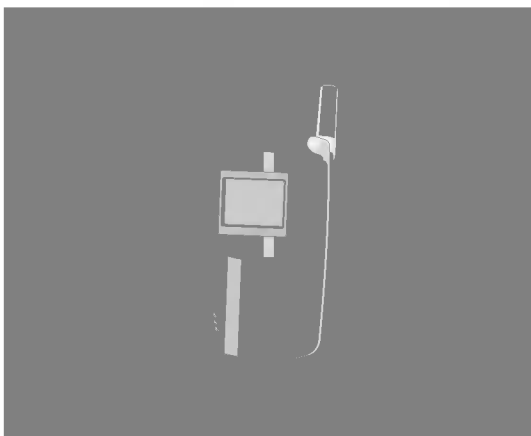

For Your Safety

All radio transmitters carry risks of interference with electronics in close proximity.



GSM Phones must be switched off at all times in an aircraft.



Avoid pointing active infrared port at eyes.



Do not activate near petrol stations, fuel depots, chemical plants or blasting operations.



Switch off the phone in any area where are forced by special regulations. For example, the phone does not allow to be used in hospital because pacemakers and hearing aids can be affected.



Minor interference may affect TVs, radios, PCs, etc.



Do not hold the phone in your hand while driving.



Do not dismantle phone or battery.



Keep the phone in a safe place out of children's reach since it contains the detachable small parts and create a choking hazard.



Do not touch the charger with wet hands.



For your safety, use **ONLY** specified **ORIGINAL** batteries and chargers.

Please note:



Unusable batteries should be disposed of in accordance with relevant legislation.



Only use **ORIGINAL** accessories to avoid damage to your phone.



Emergency call may not be available under all cellular networks. Therefore, you should never depend solely on the phone for essential communications such as medical emergencies.

Important Information

This user's guide contains important information on the use and operation of this phone. Please read all the information carefully for optimal performance and to prevent any damage to or misuse of the phone. Any changes or modifications not expressly approved in this user's guide could void your warranty for this equipment.

Contents

Overview

Accessories	9
Part of the Phone	10
• Front of the Phone	10
• Rear of the Phone	11
• Sub LCD of the phone	11
Key Description	12
• Side of the Key	13
• Alphanumeric Keys	13

Display Information

Display Information	14
• On-Screen Icons	14

Getting Started

Installation	16
• Inserting the SIM Card	16
• Installing the Battery	16
• Charging the Battery	17
• Disconnecting the charger	18
Powering On Sequence	19
• To get started with the phone	19
• To turn off the phone	19
Access Codes	20
• PIN code (4 to 8 digits)	20
• PIN2 code (4 to 8 digits)	20
• PUK code (4 to 8 digits)	20
• PUK2 code (4 to 8 digits)	20
• Security code (4 to 8 digits)	20
Making and Answering calls	21
• Making a call	21
• Making a call by  [Send key]	21
• International Calls	21
• Making a call using the Phonebook	21
• Making call by Speed dials.	21

Menu Description

Phonebook	22
Menu Tree	23
Messages [Menu 1]	24
• Write message [Menu 1-1]	24
• Inbox [Menu 1-2]	28
• Outbox [Menu 1-3]	29
• Info service [Menu 1-4]	29
• Voice messages [Menu 1-5]	31
• Delivery reports [Menu 1-6]	31
• Templates [Menu 1-7]	31
• Settings [Menu 1-8]	31
• Delete all [Menu 1-9]	32
Call register [Menu 2]	33
• Missed calls [Menu 2-1]	33
• Received calls [Menu 2-2]	33
• Dialed calls [Menu 2-3]	34
• Clear recent calls [Menu 2-4]	34
• Call durations [Menu 2-5]	34
• Call costs [Menu 2-6]	35
• Cost settings [Menu 2-7]	36
• GPRS information [Menu 2-8]	36
Profiles [Menu 3]	37
• Vibrate only [Menu 3-1]	37
• Silent [Menu 3-2]	37
• General [Menu 3-3]	37
• Loud [Menu 3-4]	38
• Headset [Menu 3-5]	38
• Car [Menu 3-6]	38
Settings [Menu 4]	40
• Alarm clock [Menu 4-1]	40
• Date & time [Menu 4-2]	41
• Phone settings [Menu 4-3]	42
• Call settings [Menu 4-4]	43
• Security settings [Menu 4-5]	46
• Network settings [Menu 4-6]	49
• Restore factory settings [Menu 4-7]	49

Call divert [Menu 5]	50
• All voice calls [Menu 5-1]	50
• If busy [Menu 5-2]	50
• If not answered [Menu 5-3]	50
• If out of reach [Menu 5-4]	50
• All data calls [Menu 5-5]	50
• All fax calls [Menu 5-6]	51
• Cancel all divers [Menu 5-7]	51
Organizer [Menu 6]	52
• Schedule [Menu 6-1]	53
• Memo [Menu 6-2]	53
• Phonebook [Menu 6-3]	53
Fun & Tools [Menu 7]	59
• Game [Menu 7-1]	59
• My folder [Menu 7-2]	59
• Unit converter [Menu 7-3]	60
• Calculator [Menu 7-4]	60
• World time [Menu 7-5]	60
• Voice recorder [Menu 7-6]	61
• Infrared [Menu 7-7]	61
Internet [Menu 8]	62
• Home [Menu 8-1]	62
• Bookmarks [Menu 8-2]	62
• Push messages [Menu 8-3]	63
• Profiles [Menu 8-4]	63
• Go to URL [Menu 8-5]	65
• Cache settings [Menu 8-6]	65
• WAP information [Menu 8-7]	65
• Reset profiles [Menu 8-8]	65
Internet On- line menu	66
SIM service [Menu 9]	67
Care and Maintenance	68
Technical data	70

Check to make sure that you have all the parts shown below.

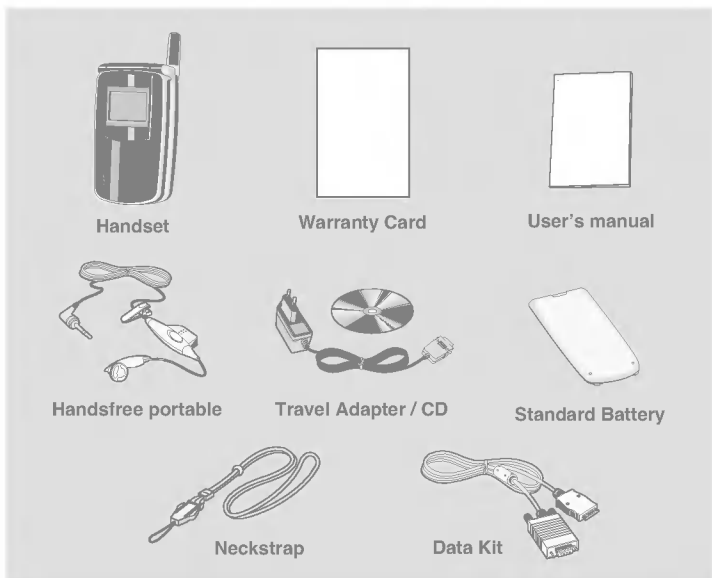

<Optional Accessories>

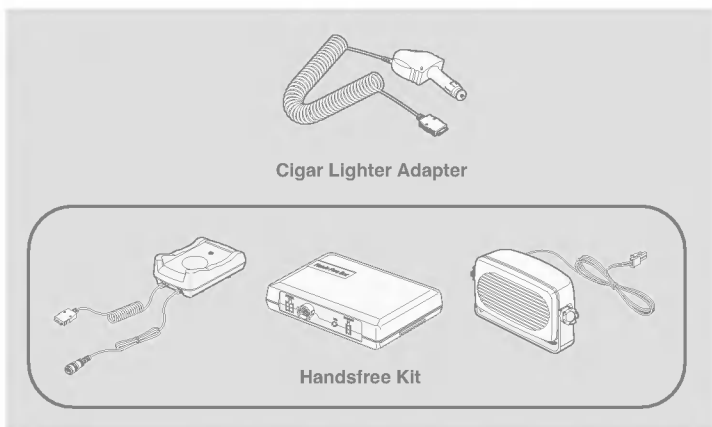

Front of the Phone

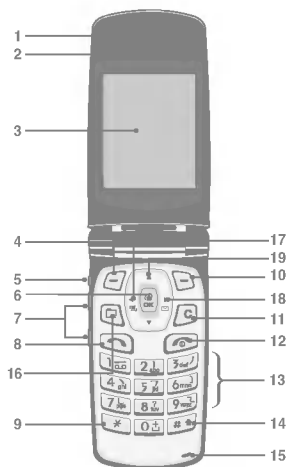

- | | |
|--------------------|--------------------|
| 1 Earpiece | 10 Soft Right Key |
| 2 Active Folder | 11 Clear Key |
| 3 Display Screen | 12 End / Power Key |
| 4 Soft Left Key | 13 Numeric Keys |
| 5 Record Key | 14 Hash Keys |
| 6 Confirm Key | 15 Microphone |
| 7 Up/Down Side Key | 16 Bookmark Key |
| 8 Send Key | 17 Profile Hot Key |
| 9 Star Key | 18 Message Hot Key |
| | 19 Navigation Key |

Rear of the Phone

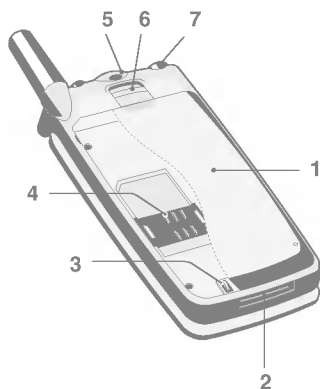

- 1 Battery
- 2 Cable Connector/
Battery Charging Connector/
Hands-Free Car kit Connector
- 3 Battery Terminals
- 4 SIM Card Socket
- 5 Handstrap Hole
- 6 Battery Lock
- 7 Ear microphone connector

Sub LCD of the phone

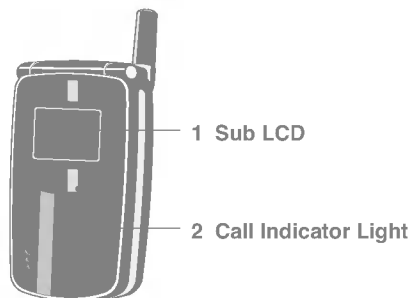













You can view the icon of receiving text message or voicemail even not opening folder. In addition, you can check the name and number for incoming calls.

● **Note!**



- If the name or number of entry is not saved in phonebook, "New call" will be displayed when receiving a call.

The following shows key components of the phone.

Keypad Description

Key	
	<p>Soft Left Key / Soft Right Key Each of these keys performs the function indicated by the text on the display immediately above it.</p>
	<p>Navigation Keys</p> <p>Left navigation key Used to Profile hot key and Menu options key.</p> <p>Right navigation key Used to Message hot key and Menu options key.</p> <p>Up/ Down navigation key Used to search name of Phonebook and Menu options key.</p> <p>Confirm key You can go WAP directly if you press this key for a long time.</p>
	<p>Bookmark Key / Clear Key You can go directly bookmark menu by pressing  . You can delete the characters you input by pressing  .</p>
	<p>Send Key You can dial a phone number and answer a call. If you press this key without entering a number, your phone shows the most recently dialed, received, and missed numbers.</p>
	<p>Numeric Keys These keys are used mainly to dial in standby mode and enter numbers or characters in editing mode. When you press these keys for a long time.</p> <ul style="list-style-type: none"> Used to call for international call by  . Used to call Speed dials by from  to  . Used to check voicemail by  .
	<p>END/PWR Key Used to end or reject a call. This key is also used as Power Key. Pressing and holding this key for a few seconds.</p>

Side of the Key

Key	
	Up/Down Side Key You can control the volume of key tone in standby mode and also control the volume during a call.
	Record Key You can use voice memo by pressing and holding this key for a few seconds. In case of closing a folder, you can reject a call if you press this key.

















Alphanumeric Keys

The alphabet and numerical keypad mapping relation are listed as the following table.









Key	
	.!'1,-?@_
	A B C 2 Ä Å Á Â Ã Æ Ç a b c ä å á â ã ä ç
	D E F 3 È É Ê Ë d e f è é ê ë
	G H I 4 Ì Í Î Ï Ĝ g h i ì í î ï ğ
	J K L 5 j k l
	M N O 6 Ñ Ö Õ Ò Ó Ô Õ m n o ñ ö ò ó ô õ ö
	P Q R S 7 p q r s ş ß
	T U V 8 Ü Ú Ú Û Ů t u v ü ú û
	W X Y Z 9 w x y z
	0, ø [Space Key]

The screen displays several icons the following describe each of them you may see on the phone.

On-Screen Icons

Icon/Indicator	
	Tells you the strength of the network signal.
	Call is connected.
	Shows that you are using a roaming service.
	The alarm has been set and is on.
	Tells you the status of the battery.
	You have received a text message.
	You have received a voice message.
	You can set the vibration mode.
	You have received e-mail.
	Loud menu in Profiles.
	Quiet menu in Profiles.
	Headset menu in Profiles.
	Car menu in Profiles.
	General menu in profiles.
	Shows that you can use push message service.
	You can set your own schedule.

Top Menu Icons

Icon	
	Messages
	Call register
	Profiles
	Settings
	Call divert
	Organizer
	Fun & Tools
	Internet
	SIM service (Dependent on SIM card)

① Inserting the SIM Card

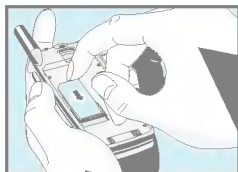

Locate the SIM card socket in the back of the phone.

Follow the steps below to install the SIM card.

1. Remove the battery if attached.
2. Slide the SIM card into the slot, under the silvery holders, with the golden connectors facing down and the cut corner to the right.

● Notice

- Before installing always make sure that the phone is switched off and remove the battery.
- The metal contact of the SIM card can be easily damaged by scratches. Pay special attention to the SIM card when you handle and install. Follow the instructions supplied with the SIM card.

② Installing the Battery

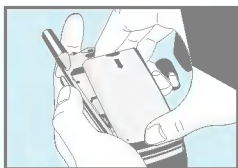

1. Place the battery on the back of the phone.

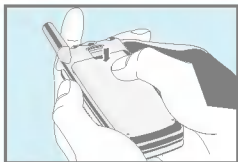

2. Push it until you hear a click.

3 Charging the Battery

To connect the travel adapter to the phone, you must have installed the battery.



1. Insert one end of the travel adapter into the bottom of the phone.

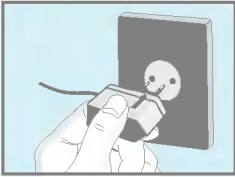

2. Connect the other end of the travel adapter to an AC wall outlet.
Use only the included packing charger.



● Warning

- Do not force the connector as this may damage the phone and/or the travel adapter.

4 Disconnecting the charger

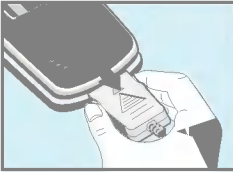

Disconnect the travel adapter from the phone by pressing its side buttons.

● Notice

- The battery delivered with your phone has to be fully charged before using it.
- Do not remove your battery or the SIM card while charging.
- The moving bars of battery icon will stop after charging completely.
- On charging the phone, you can check the status of battery by the color of the indicator LED. [Full charge: Blue, In progress of charging: Red]

● Note

- In case of not charging the battery properly...
 1. After switching On/Off Power key, please try to recharge it.
 2. In case of the battery is attached, please detach it from the phone. And then place it back, please try to recharge it.

① To get started with the phone

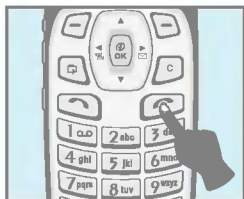

1. Press and hold  [Power/End Key] until you hear a tone.
2. Depending on setting **PIN code request** [Menu 4-5-1], you can enter it or not.
3. If your phone connects to a network, the network name will be displayed shortly.

② To turn off the phone

In a standby mode, press and hold  key until you hear a tone.

You can use the access codes described in this section to avoid unauthorized use of your phone. The access codes (except PUK and PUK2 codes) can be changed by using **Change codes** [Menu 4-5-4].

PIN code (4 to 8 digits)

The PIN (Personal Identification Number) code protects your SIM card against unauthorized use. The PIN code is usually supplied with the SIM card. When **PIN code request** is set Enable, your phone will request the PIN code every time it is switched on. On the contrary, when **PIN code request** is set **Disable**, your phone connects to the network directly without PIN code.

PIN2 code (4 to 8 digits)

The PIN2 code, supplied with some SIM cards, is required to access some functions such as Advice of call charge, Fixed Dial number. These functions are only available if supported by your SIM card.

PUK code (4 to 8 digits)

The PUK (PIN Unblocking Key) code is required to change a blocked PIN code. The PUK code may be supplied with the SIM card. If not, contact your local service provider for the code. If you lose the code, also contact your service provider.



PUK2 code (4 to 8 digits)

The PUK2 code, supplied with some SIM cards, is required to change a blocked PIN2 code. If you lose the code, also contact your service provider.



Security code (4 to 8 digits)

The security code protects the unauthorized use of your phone. It is usually supplied with the phone. This code is required to delete all phone entries and to activate "Restore factory settings" menu. The default number is "0000". You also can change it in Security settings menu.



Making a call

1. Key in phone number including the area code, To edit a number on the display, press (←, →) to move cursor to the left and press → to move cursor to the right.
2. Press  to call the number.
3. Press  to end the call.



Making a call by [Send key]

1. Press  [Send key], and then you can check the latest missed, received, and dialled phone numbers.
2. Select the number you want on the list.
3. Press  [Send key].

International Calls

1. Press and hold the  key for the international prefix.
“+” character may replace with the international access code.
2. Enter the country code, area code, and the phone number.
3. Press .

Making a call using the Phonebook



1. In a standby mode, press  [Names].
2. When the menu is displayed, you select **Search** by pressing  [OK].
3. If you find out the desired item through searching by a name or a number, press  to call.

Making call by Speed dials.

See the menu **Phonebook - Speed dials** [Menu 6-3-4] in detail.



To select a menu in phonebook, press  [Names] in standby mode and then scroll to a desired item. You can also access this menu through **Organizer**.

1	Search	Allows you to search for a specific name.
2	Add new	Allows you to add new names and numbers.
3	Caller groups	Allows you to show group list, and select it. You can edit the its name, and set a ring, icon, LED color for each Group.
4	Speed dials	Allows you to assign up to 8( - ) one-touch dial allocations.
5	Set memory	Allows you to select memory.
6	Delete all	Allows you to erase all data in SIM or Phone memory.
7	Copy all	Allows you to copy entries from your Phone memory to SIM card or from SIM card to Phone memory.
8	Information	Allows you to check the status of memory, SDN(Service Dial Number), and Own number.



1 Messages

- 1 Write message
- 2 Inbox
- 3 Outbox
- 4 Info service
- 5 Voice messages
- 6 Delivery reports
- 7 Templates
- 8 Settings
- 9 Delete all



2 Call register

- 1 Missed calls
- 2 Received calls
- 3 Dialed calls
- 4 Clear recent calls
- 5 Call durations
- 6 Call costs
- 7 Cost settings
- 8 GPRS information



3 Profiles

- 1 Vibrate only
- 2 Silent
- 3 General
- 4 Loud
- 5 Headset
- 6 Car



4 Settings

- 1 Alarm clock
- 2 Date & Time
- 3 Phone settings
- 4 Call settings
- 5 Security settings
- 6 Network settings
- 7 Restore factory settings



5 Call divert

- 1 All voice calls
- 2 If busy
- 3 If not answered
- 4 If out of reach
- 5 All data calls
- 6 All fax calls
- 7 Cancel all diverts



6 Organizer

- 1 Schedule
- 2 Memo
- 3 Phonebook



7 Fun & Tools

- 1 Game
- 2 My folder
- 3 Unit converter
- 4 Calculator
- 5 World time
- 6 Voice recoder
- 7 Infrared



8 Internet

- 1 Home
- 2 Bookmarks
- 3 Push messages
- 4 Profiles
- 5 Go to URL
- 6 Cache settings
- 7 WAP information
- 8 Reset profiles



9 SIM Service

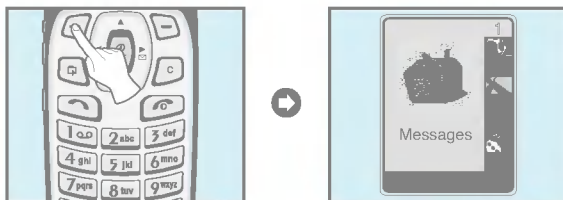

This menu depends on SIM and the network services.



This menu includes functions related to SMS (Short Message Service), voice mail, as well as the network's service messages.



Write message [Menu 1-1]

You can write and edit text message up to 480 characters.

1. Enter the **Messages** menu by pressing  [OK].
2. If you want to write a new message, select **Write message** in the menu.
3. Input the message.
4. When you finish writing the message, press  [Option].
Then following option menu will be displayed.

Send

Sends the text message.

1. Enter the phone number to send the message.
2. Press  [OK]. If you don't want to send it, press  [Back].

Save

Stores the message in Outbox.

If you want to save it in Outbox, press  [OK]. If you don't want, press  [Back].

Insert template

The template is pre-defined message. You can select one of the templates and add it to the message you will send.

EMS function

You can use EMS only if the network supports this service.

Attach picture

If you want to append the picture on sending message, you can select it through EMS. You can also select one of the various pictures.

Attach animation

If you want to append the animation on sending message, you can select it through EMS. In addition, You can select the one of 15 animations which you want.

Attach sound

If you want to append the sound on sending message, you can select it through EMS.



Note

- You may not send or receive the message through EMS due to the incompatibility between G7020 phone and the others.

eZi dictionary

You can add, delete and edit a word in eZi dictionary. If you save it in a dictionary, this word has a high priority than others.

• How to add a word in a dictionary

1. Scroll to highlight **eZi dictionary**.
2. **<No word>** message will be displayed when nothing is saved. Once a word is saved in a dictionary, you can view the word list.
3. Press  [Add].
4. After entering a word, press  [OK].

• How to delete a word from a dictionary

1. Scroll to highlight **eZi dictionary**.
2. Select a word you want to delete, and then press  [Option].
3. Select **Delete** menu.

• How to edit a word in a dictionary

1. Scroll to highlight **eZi dictionary**.
2. Select a word you want to edit, and then press  [Option].
3. Select **Edit** menu.

How to use eZi text





eZi text mode allows you to type a word easily and quickly. Simply pressing each key once for each character, you can get the word you want. Therefore, you don't need to input all characters to make a word.

• How to change mode





There are 4 modes. : **eZi mode, Numeric mode, Letter mode (Capital and Small)**. You can change and choose one among the editor modes by pressing  .

• How to use in eZi mode







1. Select **Messages** by pressing  [OK].
2. Scroll to **Write message** by pressing  [OK].
3. In eZi text mode, you just press a key marked a character on the keypad. In addition, you can space out by pressing  key.
4. After writing the message, press  [OK].
5. If you want to send or save the message, press  [Option].

● Example

For making "Tomorrow", you just press  →  →  →  →  in sequence.

● Notice

1. You can change a language with  key.
2. Once you press corresponding key,  key will be changed to "Change". Then you can change the capital form with  [Change] For example : you → y.o.u. → Y.O.U. → YOU After choose the candidate,  key will be return to "Symbol".

• How to use Numeric mode

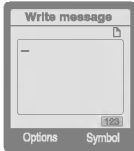

You can use this mode to input number, change another mode by  key.

• How to use in letter mode





There are two sub-modes in letter mode. You can change sub-mode with  key. You can input a capital letter.







You can input a small letter.

● Note

1. If you want to space, press  .
2. To delete a letter, use  key.

Inbox [Menu 1-2]

When you receive a text message, the symbol  is displayed on the screen. You can save it in the incoming message lists. Select the desired message by scrolling  ,  , you can delete all incoming messages by selecting **Delete all** at the bottom of the list. After reading the message, press  [Option] to access the available options.

Reply [Menu 1-2-1]

You can reply to the sender by message, if you press  [OK].

Forward [Menu 1-2-2]

You can forward the selected message to the other party, if you press  [OK].

Delete [Menu 1-2-3]

You can delete the message if you press  [OK].

Get number [Menu 1-2-4]

If the message has the number, you can not only extract it but also save it in a phonebook. You can also call by this number.





Save attachments [Menu 1-2-5]

You can save the attachment file such as picture and sound, and animation.

Return call [Menu 1-2-6]

You can call back to sender by pressing  [Send].

Outbox [Menu 1-3]

When you enter this menu, you can see the outgoing message list. You can select the desired message by scrolling ,  and press  [OK] to read it. And if you want to exit **Outbox** menu, press  [Back]. In addition, you can delete all outgoing message by selecting **Delete all** menu at the bottom of the list. After reading message, press  [Option] to access the following submenus.

Forward [Menu 1-3-1]

You can forward the message to the other party.

Delete [Menu 1-3-2]

You can delete the message.

Get number [Menu 1-3-3]

If the message has the phone number, you can not only extract it also save it in a phonebook. You can call by this number.

● Notice

If you space out as inputting numbers, the receiver can check them respectively.

Info service [Menu 1-4]

Cell Broadcast messages (CB message) are text ones that are sent by the network to GSM phone users. The network provides general information such as weather reports, traffic news, tax, pharmacies, and stock prices. Each type of information has the number; therefore, you can contact service provider. When you receive CB message, you can view the submenus below:



Receive [Menu 1-4-1]

- **Yes** : If you select this menu, your phone will receive the Cell Broadcast message.
- **No** : If you select this menu, your phone will not receive the Cell Broadcast message.

Inbox [Menu 1-4-2]

You can read and delete received CB messages.

Topics [Menu 1-4-3]

If you want to create new topics, press  [OK]. Then, you select New topics menu by  [Select]. If you have already topics, you can delete, edit, and activate by pressing  [Option].

Alert [Menu 1-4-4]



• On

When Cell broadcast message is arrived, your phone will inform you by beep.

• Off

When Cell broadcast message is arrived, your phone will not beep.

Auto display [Menu 1-4-5]

When you receive CB message, it is automatically displayed on the window. You can read it by scrolling  ,  .

• On

The message will be displayed on the screen automatically.

• Off

The message will not be displayed on the screen automatically.

Language [Menu 1-4-6] (Dependent upon the Network)

You can select the language pressing  [OK]. Then, the cell broadcast message will be displayed in the language that you selected. If you use all languages supported by phone, select **All** at the bottom of the list.

Voice messages [Menu 1-5]

Listen to voice messages [Menu 1-5-1]

In this menu, you can listen to your voice messages. If the address of voicemail centre is already saved in phone, your phone connects it automatically. Otherwise, the phone requires entering the address.

Voice mailbox number [Menu 1-5-2]

You can input voice mailbox address number.

Delivery reports [Menu 1-6]

You can read and delete delivery report messages.

Templates [Menu 1-7]

You can see 10 pre-defined messages in the list. You can view templates already saved in a list before editing it. You can change those ones. The rest ones are <Empty>. You can add the new one.

Edit [Menu 1-7-1]

You can edit a template.

Delete Menu 1-7-2]

You can delete a template.

Send [Menu 1-7-3]

You can send the text message with a template.

Settings [Menu 1-8]

Message centre number [Menu 1-8-1]

You can input the address of message centre.

Message types [Menu 1-8-2]

Text, Voice, Fax, Paging, X.400, E-mail, ERMES

Usually, the type of message is set to **Text** type. You can replace your text with the alternative formats, which are suitable for the device that will be received the message. Contact your service provider for the availability of this function.

Validity period [Menu 1-8-3]

This network service allows you to set how long your text messages will be stored at the message center.

Delivery reports [Menu 1-8-4]

If you set **Yes** in this menu, you can check whether your message is sent to the other party successfully or not.

Pay for reply [Menu 1-8-5]

When the other party replies to your message, you can pay for this.

Bearer setting [Menu 1-8-6]

You can set the bearer data service.

- Dual
- GPRS only
- GSM only

Check memory [Menu 1-8-7]

If you select this menu, you can check the used and total memories. The total memory is the sum of SIM and Phone memory.

Delete all [Menu 1-9]

Yes [Menu 1-9-1]

You can delete all messages in Inbox/Outbox.

No [Menu 1-9-2]

You can cancel deleting all messages in Inbox/Outbox.

Call register [Menu 2]

(Dependent on the network service)

Menu Description

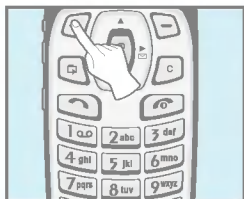

[Press once]

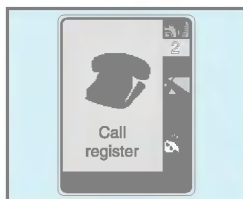

You can check the record of missed, received, and dialled calls only if the network supports the Calling Line identification (CLI) within the service area.

In the options of missed calls, received calls, and dialled numbers you can check:

- Call by this number.
- Save the number in the phonebook.
- View the date and the time of the call.
- Edit, delete or save the number from the list in phonebook.

Missed calls [Menu 2-1]

This function allows you to view a list of the latest 10 phone numbers you didn't receive.

Received calls [Menu 2-2]

This function allows you to view a list of 20 phone numbers from which you've got the latest received calls.

(Dependent on the network service)

Dialled calls [Menu 2-3]

This function allows you to view a list of 20 phone numbers that you have recently called or tried to call.

Submenus in each menu :

View detail

You can check the dialed number in detail.

Delete

You can delete the record of the dialed numbers.

Save

You can save the information of dialed call.

Call

You can call by this number.

Clear recent calls [Menu 2-4]

This function allows you to delete Missed, Dialled, and Received call lists. You can delete all call lists at a time.

Call durations [Menu 2-5]

This function allows you to view the duration of incoming and outgoing calls. You can clear the duration record by using Reset key after entering the security code.

Last call [Menu 2-5-1]

If you press  [Reset], you can delete last call duration.

Received Call [Menu 2-5-2]

If you press  [Reset], you can delete Received call duration. You need to input Security code.

Outgoing Call [Menu 2-5-3]

If you press  [Reset], you can delete outgoing call duration. You need to input Security code.

All calls [Menu 2-5-4]

If you press  [Reset], you can delete the duration of Last call, received call, and outgoing call. You need to input Security code.

Call costs [Menu 2-6]

This network service allows you to check the costs of your last call costs and all call costs. To clear the counters, you need the PIN 2 Code.

Last call's cost [Menu 2-6-1]

This function allows you to reset the last call costs. You need to input PIN2 code.

All call's cost [Menu 2-6-2]

This function allows you to reset the all call costs. You need to input PIN2 code.

Note

- The actual cost invoiced for calls by your service provider may vary depending upon network features, rounding-off for billing, taxes, etc.

(Dependent on the network service)

Cost settings [Menu 2-7]

Call cost's limit [Menu 2-7-1]

This network service allows you to limit the costs of your calls to the number of charging units or units of currency. If you select on the number of remaining, the cost will be displayed in standby mode. You can make or receive a call as far as the specified cost limit is not exceeded.

Set tariff [Menu 2-7-2]

The phone can change units and currency name. Contact your service provider for charging unit price. You may need the PIN2 code to select the currency or unit in this menu.

Auto display [Menu 2-7-3]

When setting **On**, show the reminder cost in standby mode, When call end, show the last call costs.

GPRS information [Menu 2-8]

You can check the amount of data transferred over the network through GPRS. In addition, you can also view how much time you are online.

1. Press .
2. Scroll to the information you want to check. Your options include the following:

WAP [Menu 2-8-1]

You can check the data volume and the duration through WAP.

- **Last session [Menu 2-8-1-1]**
- **All session [Menu 2-8-1-2]**

External device [Menu 2-8-2]

You can check the data volume and the duration through GPRS by using external device such as serial port.

Total data [Menu 2-8-3]

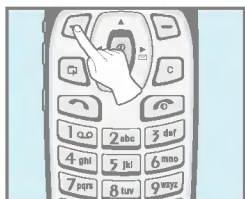

You can check the total amount of data through WAP and external device.

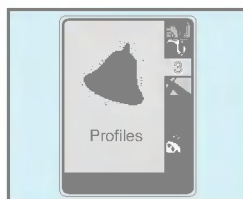

[Press twice]



In this menu, you can adjust and customize the phone tones for different events, environments and caller's group. (e.g. When you are in car, you can choose the **Car** profile, Etc)

1. Press  [Menu] in standby mode.
2. Press  for direct access to enter **Profiles**.

Vibrate only [Menu 3-1]

Activate [Menu 3-1-1]

You can adjust the profile as Vibration if you need vibration mode.

Silent [Menu 3-2]

Activate [Menu 3-2-1]

You can adjust the profile as Silent if you are in quiet place.

Personalise [Menu 3-2-2]

You can change the values of Profile submenus.

General [Menu 3-3]

Activate [Menu 3-3-1]

You can adjust the profile as General if you need General mode.

Personalise [Menu 3-3-2]

You can change the values of Profile submenus.

Loud [Menu 3-4]

Activate [Menu 3-4-1]

You can adjust the profile as outdoor if you are in a noisy environment.

Personalise [Menu 3-4-2]

You can change the values of Profile submenus.

Headset [Menu 3-5]

Activate [Menu 3-5-1]

You can adjust the profile as Headset when you put on a headset.

Personalise [Menu 3-5-2]

You can change the values of Profiles submenus.

Car [Menu 3-6]

Activate [Menu 3-6-1]

You can adjust this profile when you activate Handsfree Kit.

Personalise [Menu 3-6-2]

You can change the values of Profile submenus.

Note

If you connect headset or handsfree kit to a phone, each profile menu related to them will be displayed automatically.

A Group of Personalise submenus [Menu 3-x-x]

Personalise menu have the submenus as shown below.

Incoming call alert [Menu 3-x-x-1]

Allows to set the incoming call alert type for adjusting environment.

Ring, Vibrate, Ring & Vib, Ring after vib, Off.

Ring tone [Menu 3-x-x-2]

Allows to set the ring tone for adjusting environment.

Ring volume [Menu 3-x-x-3]

Allows to set the ring volume for adjusting environment.

Message alert type [Menu 3-x-x-4]

Allows to alert when receiving a message for adjusting environment.

Ring once, Ring periodic, Vibrate, Ring & Vib, Off.

Message alert tone [Menu 3-x-x-5]

Allows to set the message alert tone for adjusting environment.

Key volume [Menu 3-x-x-6]

Allows to set the keypad tone for adjusting environment.

● Note

Automatic answer

- This function will be activated only when your phone is connected to the handsfree kit or headset.
 - **Off** : The phone will not answer automatically.
 - **After 5 sec** : After 5 seconds, the phone will answer automatically.
 - **After 10 sec** : After 10 seconds, the phone will answer automatically.



[Press three times]

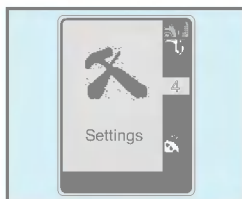

Alarm clock [Menu 4-1]

You can set the phone to alarm time within this menu.

• On

You can set the time (Hour and Minute) for raising the alarm.

1. Enter the menu.
2. Select **On** by pressing (☰, ☑) [On/Off].
3. If you want to set the time for raising the alarm, press (⌚, ⌚).
4. Select the repeat period by pressing (☰, ☑) : **Once, Daily, Weekly, and Monthly.**
5. Press (☑) [Set].

• Off

You can cancel the alarm time.



1. Enter the menu.
2. Select **Off** by pressing (☰, ☑) [On/Off].
3. You can check the message "Alarm off".

Date & Time [Menu 4-2]

The phone has its own clock. In this menu you can set the time format between 12-hour and 24-hour.



Set the time [Menu 4-2-1]

You can set time of your phone in this menu.

1. Select **Set the time** by pressing  [Select].
2. Enter the number you want to set the time.
3. Press  [set].



Time format [Menu 4-2-2]

You can select time format between 12-hour and 24-hour.

1. Scroll to highlight **Time format** by pressing  [Select].
2. Select 12 hour or 24 hour you want by pressing  [OK].

Set the date [Menu 4-2-3]

In this menu, you can set the date of your phone.

1. Enter the menu.
2. Select **Set the date** by pressing  [Select].
3. Enter the number you want to set the date.
4. Press  [Set].

Date format [Menu 4-2-4]

You can set the Date format in this menu.

[Y: Year, M: Month, D: Day]

- YYYY/MM/DD
- DD/MM/YYYY
- MM/DD/YYYY

Phone settings [Menu 4-3]

You can set the phone as you want. Scroll to highlight **Phone settings** menu, and then press  [Select].

Language [Menu 4-3-1]

This menu provides you with selection of the language.

If **Automatic** is set, the language is chosen based on the current SIM card. English will be set if the language on the SIM card is not supported in the phone.

Wallpaper [Menu 4-3-2]

You can select one of the pictures by pressing ( , ).

LED indicator [Menu 4-3-3]

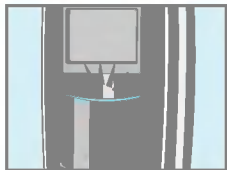

You can set the network status thru Call Indicator Light. If you are in service area, Call Indicator Light will flicker to Green. On the contrary, if you are in no service area, this light will change to Red.

• Incoming call [Menu 4-3-3-1]

This menu allows you to select the color of LED indicator for incoming call. In addition, You can set LED color depending on other groups.

• Idle [Menu 4-3-3-2]

You can check the network status by LED color in a standby mode.

- Enable
- Disable

Backlight [Menu 4-3-4]

You can set the light-up duration you want every time you press a key or open folder.

Contrast [Menu 4-3-5]

You can set the brightness of LCD you want by pressing ( , ).

Call settings [Menu 4-4]

You can set the menu relevant to a call by pressing  [OK] in **Setting** menu.

Answer mode[Menu 4-4-1]

• On folder open [Menu 4-4-1-1]

If you select this menu, you can receive an incoming call when only opening folder.

- **Yes** : You can activate the function.
- **No** : You can deactivate the function.

• Press any key [Menu 4-4-1-2]

If you select this menu, you can receive an incoming call by pressing any key except  ,  key.

- **Yes** : You can activate the function.
- **No** : You can deactivate the function.

Own number sending [Menu 4-4-2]

(network and subscription dependent)

You can send your phone number to the other party dependent on setting this function.

• Set by network [Menu 4-4-2-1]

If you select this, you can send your phone number depending on two line service such as line 1 or line 2.

• On [Menu 4-4-2-2]

If you select this, you can send your phone number to the other party. That is, your phone number will be displayed on receiver's phone.

• Off [Menu 4-4-2-3]

If you select this, you can't send your phone number.

Call wait service [Menu 4-4-3]

If this service is enabled, you can accept a waiting (incoming) call. If this service is disabled, you cannot recognize the waiting (incoming) call.

- **Activate [Menu 4-4-3-1]**

Activating the corresponding service.

- **Cancel [Menu 4-4-3-2]**

Deactivating the corresponding service.

- **Check status [Menu 4-4-3-3]**

Checking the status of the service.

Automatic redial [Menu 4-4-4]

- **On [Menu 4-4-4-1]**

When this function is activated, your phone will try to make a call in case of failing to connect.

- **Off [Menu 4-4-4-2]**

Your phone will not make any attempts to connect the call after failing to connect.

Minute minder [Menu 4-4-5]

If you select **On**, you can check the call duration by beep sound every minute during a call.

Phone line in use [Menu 4-4-6]

This function is only used if **Two-line service** is supported by the Service Provider. Two independent phone numbers are registered for the phone. This function provides you with the selection the currently used phone number.

1. **Line 1** : Select Line 1 as the current phone number.

2. **Line 2** : Select Line 2 as the current phone number.

● **Note**

- If you select Line 2 in the area where alternative line service is not supported, you can't make a call.

Data transfer mode [Menu 4-4-7]

(network dependent)

In case of Single Numbering Service, you can use the phone and the connected PC to send and receive fax, data, and voice. If you select the mode, you can receive data, fax, or voice for each mode. Once you enter this menu, following options are displayed.

• Single mode

You can receive a voice call, fax call, and data call respectively.

• Voice & Fax

You can receive a data call after voice call.

● Note

- Single Numbering Service means that the number of fax or data service is identical with the number of voice service. And, these modes depend on network feature.

Closed User Group [Menu 4-4-8]

(network dependent)





Use this function to restrict usage of the phone calls with numbers that belong to certain user groups. When this function is used, every outgoing and incoming call is associated with a group index. If a group index is specified, it is used for all outgoing calls. If no group index is specified, the network will use the preferential index (a specific index that is stored in the network).

- A. Preset** : Setting the selected CUG Index.
B. On : Activating and editing the CUG Index.
C. Off : Deleting the selected CUG.

Security settings [Menu 4-5]

PIN code request [Menu 4-5-1]

In this menu, you can set the phone to ask for the PIN code of your SIM card when the phone is switched on. If this function is activated, you'll be requested to enter the PIN code.

1. Press  [Menu] in standby mode.
2. Press key  for direct access or use  and  to enter **Settings**.
3. Scroll to highlight **Security settings** menu.
4. Select **PIN code request** by pressing  [OK].
5. You can view the following submenus.
 - **Enable** : You can activate this function.
 - **Disable** : You can cancel setting this function.

Call barring service [Menu 4-5-2]

(Network dependent)

The Call barring service prevents your phone from making or receiving certain category of calls. This function requires the call barring password. You can view the following submenus.

- **All outgoing calls [Menu 4-5-2-1]**
You can bar all outgoing calls.
- **Outgoing international [Menu 4-5-2-2]**
You can bar outgoing international calls.
- **Outgoing international roaming [Menu 4-5-2-3]**
You can bar outgoing international roaming call.

- **Incoming calls [Menu 4-5-2-4]**
You can bar incoming calls.
- **Incoming calls when roaming [Menu 4-5-2-5]**
You can bar incoming calls when roaming.
- **All data calls [Menu 4-5-2-6]**
You can bar all data calls.
- **All fax calls [Menu 4-5-2-7]**
You can bar all fax calls.
- **Cancel all barring [Menu 4-5-2-8]**
You can cancel all call barring services.

The Submenus of Call Barring Service







- **Activate [Menu 4-5-2-x-1]**
If you apply call barring service to service provider, you can use it.
- **Cancel [Menu 4-5-2-x-2]**
You can cancel the function.
- **Check status [Menu 4-5-2-x-3]**
You can check the current status of call barring service.

● Note

- To use Call barring service, you must input the network password.







Fixed dial number [Menu 4-5-3] (SIM dependent)

You can restrict your outgoing calls to selected phone numbers. The numbers are protected by your PIN2 code.

1. Press  [Menu] in standby mode.
2. Press  key for direct access or use  and  to enter **Settings**.
3. Scroll to highlight **Security settings** menu.
4. Select **Fixed dial number** by pressing  [OK]
5. Input PIN2 code, and then press  [OK].
6. If the PIN2 code is correct, you can view the following submenus.
 - **Enable** : You can restrict your outgoing calls to selected phone numbers.
 - **Disable** : You can call without restricting phone numbers.
 - **Number list** : You can view fixed dial numbers and add, edit, delete.

Change codes [Menu 4-5-4]

You can change the access codes: PIN, PIN2, Security code, Barring password .

1. Press  [Menu] in standby mode.
2. Press  key for direct access or use  and  to enter **Settings**.
3. Scroll to highlight **Security settings** menu.
4. Select **Change codes** by pressing  [OK].
5. If you want to change the Security code/PIN/PIN2/ Barring password, press  [OK].
6. Input new Security code/PIN/PIN2/Barring password (Network Dependent).

Network settings [Menu 4-6]

You can select the network, which you will be registered either automatically or manually. Usually, the network selection is set **Automatic**.

Automatic [Menu 4-6-1]

The phone automatically selects available network in the area.

Manual [Menu 4-6-2]

The phone will find the list of available networks and show you them. Then you can select the network that you want to use if this network has a roaming agreement with your home network operator.

GPRS settings [Menu 4-7]

When you use GPRS to connect to the Internet, you can make a data call. In order to use GPRS, you set the following options.

Terminal type [Menu 4-7-1]

- Dual [Menu 4-7-1-1]
- GPRS only [Menu 4-7-1-2]
- GSM only [Menu 4-7-1-3]

Incoming GPRS session [Menu 4-7-2]

- Automatic [Menu 4-7-2-1]
- Manual [Menu 4-7-2-2]

External device [Menu 4-7-3]

When you use Internet via GPRS by using external device, you can set APN, IP address, DNS, User ID, and password as to 5 profiles. Otherwise, you may be offered those information by network.

Restore factory settings [Menu 4-8]

You can set the handset to the default configuration by selecting the Settings/Factory reset option. You need a security code to activate this function.

Call divert [Menu 5]

(network and subscription dependent)



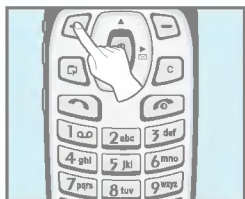

Menu Description

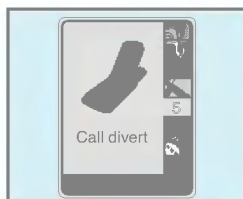

[Press four times]



The Call divert service allows you to divert incoming voice calls, fax calls, and data calls to another number. For more information, contact your service provider.

1. Press  [Menu] in standby mode.
2. Press  for direct access or use ( and ) to enter **Call divert**.

All voice calls [Menu 5-1]

Diverts voice calls unconditionally.

If busy [Menu 5-2]

Diverts voice calls when the phone is in progress.

If not answered [Menu 5-3]

Diverts voice calls which you do not answer.

If out of reach [Menu 5-4]

Diverts voice calls when the phone is switched off or out of service area.

All data calls [Menu 5-5]

Diverts to a number with a PC connection unconditionally.

All fax calls [Menu 5-6]

(network and subscription dependent)

Diverts to a number with a fax connection unconditionally.

The submenus [Menu 5-x-x]

Call Divert menu has the submenus as shown below.

Activate [Menu 5-x-1]

Activating the corresponding service.

- **To voice mailbox**

Forwards to message center. This function is not included in **All data calls** and **All fax calls** menus.

- **To other no.**

Inputs the number for diverting.

Cancel [Menu 5-x-2]

Deactivating the corresponding service.

Check status [Menu 5-x-3]

Checking the status of the corresponding service.

Cancel all diverts [Menu 5-7]

Cancels all call divert service.



[Press five times]



Schedule [Menu 6-1]

When you enter this menu Calendar will show up. On top of the screen there are sections for date and icons. You can change the day, month and year by using (←, →). Whenever you change the date, the calendar will be updated according to the date. And square cursor will be located on the day. If you see pink color square cursor in a date on the calendar, it means that there is a schedule day. This function helps to remind you of your schedules, memorial days, and what to do. If you set the schedule, you can view the following submenus.

Edit [Menu 6-1-1]

You can add the notes on the selected date and change it.

Delete [Menu 6-1-2]

You can delete the notes you've already set.

Add new [Menu 6-1-3]

You can input maximum 30 characters and 30 notes.



View all schedules [Menu 6-1-4]

Shows the notes that are set for all schedules.

Go to date [Menu 6-1-5]

You can check the date you've already input.

Memo [Menu 6-2]

1. Scroll to highlight **Memo**.
2. Press  [OK].
3. Input the memo and then press  [Save].
4. You can view the following submenus.

Edit [Menu 6-2-1]

You can edit the selected memo.

Delete [Menu 6-2-2]

You can delete the selected memo.

Add new [Menu 6-2-3]

You can add a new memo up to 20 memos and 40 characters.

Delete all [Menu 6-2-4]





You can delete all the memos you made before.



Phonebook [Menu 6-3]

You can create a personal phonebook by saving phone numbers and accompanying names. An easy to make calls is by recalling the phone numbers and names saved in your phonebook.

Search [Menu 6-3-1]

(Calling from phonebook)





1. Open the phonebook first by pressing  [Names] in standby mode.
You can also go **Organizer- Phonebook** by scrolling  , .
2. **Search** pressing  [OK] to enter.
3. You can find an entry by name and number.
4. Select  [Search].

5. If you want to edit, view, delete, copy and call by the entry, select  [Option]. The below menu will be displayed.
- **Edit** : You can edit the name, number, E-mail, and fax by pressing  [OK].
 - **View detail** : You can view the name and number in detail.
 - **Delete** : You can delete an entry.
 - **Copy** : You can copy an entry from SIM to phone or from phone to SIM.
 - **Call** : You can call by the chosen entry.

Add new [Menu 6-3-2]





You can add phonebook entry by using this function.

Phone memory capacity is 255 entries. SIM card memory capacity depends on the cellular service provider. You can also save 20 characters of name in the Phone memory, and you can save 12 characters in the SIM card. The number of character is SIM dependent feature. You can save phonebook entry in SIM or phone memory. If you want to change the memory, go to **Set memory** [Menu 6-3-5] and select **SIM** or **Phone memory**.

1. Open the phonebook first by pressing  [Names] in standby mode.
You can also go **Phonebook** by scrolling  , .
2. Scroll to highlight **Add new**, and press  [OK] to enter.







• SIM :

You can add name, number, and group setting for an entry.

- a. Write a name to add.
- b. Press  . Then you can input a number.
- c. Press  . Then you can select one of the groups by using  , .
- d. Press  [OK].



• Phone :

You can add name, number (mobile, home, office), E-mail address, group and memo.

- a. Write a name to add.
- b. Press  [OK] and then select number you want to input by pressing .
- c. You can select the number entry you want to input by pressing  and then press .
- d. You can select a group by pressing .
- e. Press , and then write a memo up to 50 characters.
- f. Press  [OK].

Caller Groups [Menu 6-3-3]

There are 6 groups and others you can make lists to.

1. Press  [Names] to enter into the phonebook in standby mode.
2. Scroll to **Caller Group** item then press  [OK] to enter this menu.
3. Every Group list will be displayed: **Family, VIP, Friends, Colleague, Group 1, Group 2, Others.**
4. Select Group name that you want to manage by pressing  [Option].
5. Then submenus below will be displayed except **Others**.

• Member list

You can edit, delete, copy, and caller's group.

• Rename

You can edit a group name.

• Group ring tone

You can choose ring sound of each group.

• Group icon





You can select Icon of each group.

• LED color

You can select LED color of each group.



Speed dials [Menu 6-3-4]

You can associate any of the keys  to  with a Name list entry. You can call directly by pressing this key for 2-3 seconds.

1. Open the phonebook first by pressing  [Names] in standby mode. You can also go Phonebook menu by scrolling (, ).
2. Scroll to **Speed dials**, then press  [OK] to enter this menu.
3. Every Speed dial will be displayed.
4. If you want to add Speed dial, select **<Empty>**. Then, you can search the name in phonebook.
5. If you select allocated name by speed dial, you can view following the submenus.
 - **Change** : You can change the allocation of Speed dial.
 - **Delete** : You can delete the allocated speed dial number.





Set memory [Menu 6-3-5]

You can set preferred memory, which includes **SIM or Phone**

1. Open the phonebook first by pressing  [Names] in a standby mode.
2. Scroll to **Set memory**, then press  [OK] to enter.
3. Then submenus below will be displayed.
4. Select SIM or Phone, then press  [OK]

Delete all [Menu 6-3-6]

You can delete all entries in **SIM, Phone**. This function requires Security code.

1. Press  [Names] to enter the phonebook in standby mode.
2. Scroll to **Delete all**, then press  [OK].
3. Then select a memory to erase: **SIM, Phone**.
4. And then you will be requested to enter Security code.
5. Press  [OK] or, press  [Back] to cancel.

Copy all [Menu 6-3-7]

You can copy/move entries from SIM card memory to Phone memory or from Phone memory to SIM card memory.

1. Open the phonebook first by pressing  [Names] in standby mode.
2. Scroll to **Copy all**, then press  [OK] to enter this menu.
3. Then submenus below will be displayed.

- **SIM to Phone [Menu 6-3-7-1]**

You can copy the entry from SIM Card to Phone memory.

- **Phone to SIM [Menu 6-3-7-2]**

You can copy the entry from Phone memory to SIM Card.

- **Keep original [Menu 6-3-7-x-1]**

Both original and relocated entries are kept in memories.

- **Delete original [Menu 6-3-7-x-2]**





Original entry is deleted whereas relocated entry remains in the memory.

Information [Menu 6-3-8]

You can select a service dial number, check memory and own number list

- **Service Dial Number [Menu 6-3-8-1]**

Use this function to access a particular list of services provided by your network operator (if supported by the SIM card).

1. Open the phonebook first by pressing  [Names] in standby mode.
2. Scroll to **Information** and scroll to service dial number, then Press  [OK] to enter.
3. The names of the available services will be shown.
4. Use ,  and to select a service, press  [Send].

• **Check memory [Menu 6-3-8-2]**

This feature allows you to see how many free and in-use are in your phonebook.

1. Open the phonebook first by pressing  [Names] in standby mode.
You can also go **Phonebook** menu by scrolling  ,  .
Select **Information** by pressing  [OK].
2. Scroll to **Check memory**, and then press  [OK] to enter this menu.

• **Own number (SIM dependent) [Menu 6-3-8-3]**

You can check your own number in SIM card.

If own number is empty, you can add new one. You can also edit and delete it.



[Press six times]

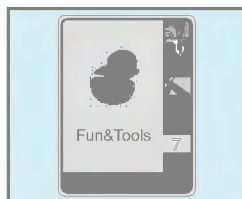

Game [Menu 7-1]

You can enjoy the games in a phone.

My folder [Menu 7-2]

You can view, delete, and control download contents.

Picture [Menu 7-2-1]

Animation [Menu 7-2-2]

Sound [Menu 7-2-3]

The Submenus for each main one [Menu 7-2-x-x]

- **Edit title [Menu 7-2-x-1]**

You can edit the title for each download contents.

- **Delete [Menu 7-2-x-2]**









You can delete each download contents.

- **Delete all [Menu 7-2-x-3]**

You can delete all download contents.







Unit converter [Menu 7-3]

This converts any measurement into a unit you want. There are 4 types that can be converted into units: **Length, Surface, Weight, and Volume.**

1. You can select one of four unit types by pressing  [Next] key.
2. Select the current value by using  ,  and then, you can set the standard value by using  , .
3. Select the value to convert by using  , .
4. Input the numbers in blank.
5. Press  or  [Back] if you want to finish the process.





Calculator [Menu 7-4]

This contains the standard functions such as +, -, *, ÷ : **Addition, Subtraction, Multiplication, and Division.**

1. Input the numbers by pressing numeric keys.
2. Use a  ,  ,  to select a sign for calculation.
3. Then input the numbers followed by the sign.
4. You can view the result by pressing  [Result] key or  [OK] key.
5. If you want to continue the calculation, repeat the process.
6. Use  [Reset] key to erase any numbers or signs. Press  key if you want to end the calculation process.

World time [Menu 7-5]

You can view the time for each city around the world. Also, you can set the current time to the city time you select.

1. Select the city belonged to the time zone by pressing  ,  key.
2. If you use  ,  , you can check the other city belonged to the same time zone of selected country.
3. You can set the current time to the city time you select. Press  [Back] key to exit the menu.

Voice recorder [Menu 7-6]

You can save and play 3 voice messages and each one can be recorded up to 30 seconds.

Infrared [Menu 7-7]

If you activate this function, you can use PC-sync by infrared. In addition, you can't use Handsfree and infrared function at the same time.

PC Sync!

PC Sync is a program for data exchange PC and a phone by a data cable. About more detail for using guide refers to PC Sync Help file in CD.



[Press seven times]

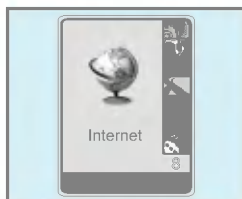

Your phone supports internet services based on Wireless Application Protocol (WAP). You can access services supported by your network. The services menu allows you to get the information such as news, weather forecast, and flight time.

Home [Menu 8-1]

You can connect the defined homepage in the activated profile.

Bookmarks [Menu 8-2]

You can save up to 50 bookmarks. Scroll to the desired bookmark and press  [Option] key to operate the following options.

- **Connect** : Connect to selected bookmark.
- **Add new** : Save a new bookmark manually.
- **Edit** : Edit the title and address of bookmark.
- **Delete** : Erase the selected bookmark.

● Note

- If any bookmarks are not saved yet, only "Add new" menu is available.

Push messages [Menu 8-3]

You can manage an inbox and a message for using push service.

Inbox[Menu 8-3-1]

You can read or delete the push messages.

Receive [Menu 8-3-2]

You can set the option whether you will receive the message or not.

Profiles [Menu 8-4]

You can make up to 5 profiles and activate only one out of them.

Scroll to desired profile  and press to access available options.

Activate [Menu 8-4-1]

Activate the selected profile.

Settings [Menu 8-4-2]

Edit and change WAP settings of selected profile.

• Homepage [Menu 8-4-2-1]

This setting allows you to enter the address (URL) of site you want to use as homepage. You do not need to type "http://" at the front of each URL the WAP Browser will automatically add it.

• Display image [Menu 8-4-2-2]

You can select whether images on WAP cards are displayed or not.

• Connect type [Menu 8-4-2-3]

The options for connection type are Temporary or Continuous and depend on the gateway you are using.

Continuous : Connection-oriented service

Temporary : Connectionless service

• Secure setting [Menu 8-4-2-4]

This option can be set None or Secure depends on the gateway. If you want to connect "Secure", select **Secure**. If not, you select **None** . The gateway should support this option.

• Gateway information [Menu 8-4-2-5]

Almost WAP gateways do not request Use ID and password, If the gateway doesn't have ones, those should be provided by the network. In addition, they must be set before browsing WAP sites.

• GPRS settings [Menu 8-4-2-6]

The service settings are only available when GPRS is chosen as a bearer service.

• Data settings [Menu 8-4-2-7]

IP address : Enter the IP address of the WAP gateway you access.

Dial up number : Enter the telephone number to dial to access your WAP gateway.

User ID : The users identity for your dial-up server (and NOT the WAP gateway).

Password : The password required by your dial-up server (and NOT the WAP gateway) to identify you.

Call type : Select the type of data call.: Analogue or Digital(ISDN).

Call speed : The speed of your data connection.

• Linger time [Menu 8-4-2-8]

After setting the limited time (30~300 sec.), the service will be disconnected if there was no Inputting or transferring data.

Rename [Menu 8-4-3]

Edit the Profile Name.

E-mail server [Menu 8-4-4]

Save the URL address of the E-mail that you frequently use.

• Connect

Connect to the URL that you configured as the E-mail server.

• Edit address

Enter the URL address of the E-mail.

Go to URL [Menu 8-5]

You can move to the site that you want. You need to type URL address of the site before connecton.

Cache settings [Menu 8-6]

You can remove the contents of Cache memory or change the Cache mode.

Clear cache [Menu 8-6-1]

The contents of Cache memory will be removed.

Cache check [Menu 8-6-2]

You can check Cache memory.

• Always [Menu 8-6-2-1]

The cache is always checked whenever URL loading or navigating.

• Start only [Menu 8-6-2-2]

The cache is only checked when the WAP is started.

• Off [Menu 8-6-2-3]

The cache is never checked.

WAP information [Menu 8-7]

You can view the information about G7020 WAP.

Reset profiles [Menu 8-8]

You can reset all setting values to the factory default.

If you are on line, you can view the following menus.

Home

This is the same as [Menu 8-1].

Reload

This reloads the current page.

Bookmarks

This is the same as [Menu 8-2].

Save as bookmarks

Save the current URL as a bookmark. You can also edit the bookmark title.

Message

Push message

Go to URL

Same as [Menu 8-5].

Go to e-mail server

Connect the current URL as an E-mail server.

Set as e-mail server

Save the current URL as an E-mail server.

Clear cache

Remove the contents of cache memory.

SIM service [Menu 9]

Menu Description

Your service provider can offer special application through SIM card, such as home banking, stock market, etc. If you are registered for one of these services, the service name will appear at the end of the Main Menu. With the SIM Services menu your phone is future-proof and will support additions to your service provider's service. For more information contact your service provider.

When using this unit, basic safety precautions as below should be always followed.

- Do not touch the adapter with wet hands.
- Do not disassemble this unit. (Take it to a qualified service technician when repair work is required.)
- Away from electrical appliance such as a TV, radio or personal computer.
- The unit should be situated from heat sources such as radiators or cookers.
- Do not drop.
- Do not subject this unit to mechanical vibration or shock.
- The coating of the phone may be damaged if covered with wrap or vinyl wrapper.
- Use dry cloth to clean the exterior of the unit. (Do not use solvent such as benzene, thinner or alcohol.)
- Do not subject this unit to excessive smoke or dust.
- Do not keep the phone next to credit cards or transport tickets; it can be affect the information on the magnetic strips.
- Do not tap the screen with a sharp object; otherwise, it may damage the phone.
- Do not expose the phone to liquid or moisture.
- Use the accessories like an earphone cautiously. Do not touch the antenna unnecessarily.

■ Caring for the Battery

- You do not need to completely discharge the battery before recharging. Unlike other battery systems, there is no memory effect that could compromise the battery's performance.
- Use only LG batteries and chargers. LG chargers are designed to maximize the battery life.
- Do not disassemble or short-circuit the battery pack.
- Keep the metal contacts of the battery pack clean.
- Replace the battery when it no longer provides acceptable performance. The battery pack may be recharged hundreds of times until it needs replacing.
- Recharge the battery if it has not been used for a long time to maximize usability.
- Do not expose the battery charger to direct sunlight or use it in high humidity, such as the bathroom.
- Do not leave the battery in hot or cold places, this may deteriorate the battery performance.

Technical data

General

Product name : G7020

System : GSM 900/ DCS 1800

Ambient temperatures

Max : +55°C

Min : -10°C

Declaration of Conformity



This model complies with the essential requirements of Article 3 of the R&TTE 1999/5/EC Directive, if used for its intended use.

1. Health (Article 3.1.a of the R&TTE Directive)
2. Safety (Article 3.1.a of the R&TTE Directive)
3. Electromagnetic compatibility (Article 3.1.b of the R&TTE Directive)
4. Efficient use of the radio frequency spectrum (Article 3.2 of the R&TTE Directive)

I hereby declare under our sole responsibility that the product mentioned above to which this declaration relates complies with the above mentioned articles of the directive.

If available, write the contact person(s)

Mr. Jin Seog, Klim
LG Amsterdam Branch Office
Capronilaan 6, 1119 NR Schiphol-rijik,
The Netherlands
(Tel.) +31-20-655 7774

Mr. Ji Jong, Jeon
LG Electronics Inc. GSM Division
Emerald BD, 1042 Hogye-Dong, Dongan-Gu
Anyang-city, Kyuonki-Do
431-080, Korea

CE 0168

