



# DVD & HDD RECORDER

## OWNER'S MANUAL

MODEL: RH4820V



Before connecting, operating or adjusting this product,  
please read this instruction booklet carefully and completely.





**CAUTION**  
RISK OF ELECTRIC SHOCK  
DO NOT OPEN



**CAUTION:** TO REDUCE THE RISK OF ELECTRIC SHOCK DO NOT REMOVE COVER (OR BACK) NO USER-SERVICEABLE PARTS INSIDE REFER SERVICING TO QUALIFIED SERVICE PERSONNEL.



This lightning flash with arrowhead symbol within an equilateral triangle is intended to alert the user to the presence of uninsulated dangerous voltage within the product's enclosure that may be of sufficient magnitude to constitute a risk of electric shock to persons.



The exclamation point within an equilateral triangle is intended to alert the user to the presence of important operating and maintenance (servicing) instructions in the literature accompanying the product.

**WARNING:** TO REDUCE THE RISK OF FIRE OR ELECTRIC SHOCK, DO NOT EXPOSE THIS PRODUCT TO RAIN OR MOISTURE.

**WARNING:** Do not install this equipment in a confined space such as a book case or similar unit.

CLASS 1 LASER PRODUCT  
KLASSE 1 LASER PRODUKT  
LUOKAN 1 LASER LAITE  
KLASS 1 LASER APPARAT  
CLASSE 1 PRODUIT LASER

**CAUTION:**

This recorder employs a Laser System.

To ensure proper use of this product, please read this owner's manual carefully and retain for future reference should the unit require maintenance, contact an authorized service location (see service procedure).

Use of controls, adjustments, or the performance of procedures other than those specified herein may result in hazardous radiation exposure.

To prevent direct exposure to laser beam, do not try to open the enclosure. Visible laser radiation when open. DO NOT STARE INTO BEAM.

**CAUTION:** The apparatus should not be exposed to water (dripping or splashing) and no objects filled with liquids, such as vases, should be placed on the apparatus.



This product is manufactured to comply with the radio interference requirements of EEC DIRECTIVE 89/336/EEC, 93/68/EEC and 73/23/EEC.



**NOTES ON COPYRIGHTS:**

It is forbidden by law to copy, broadcast, show, broadcast via cable, play in public, or rent copyrighted material without permission.

This product features the copy protection function developed by Macrovision. Copy protection signals are recorded on some discs. When recording and playing the pictures of these discs on a VCR, picture noise will appear.

This product incorporates copyright protection technology that is protected by method claims of certain U.S. patents and other intellectual property rights owned by Macrovision Corporation and other rights owners. Use of this copyright protection technology must be authorized by Macrovision Corporation, and is intended for home and other limited viewing uses only unless otherwise authorized by Macrovision Corporation. Reverse engineering or disassembly is prohibited.

**SERIAL NUMBER:** The serial number is found on the back of this unit. This number is unique to this unit and not available to others. You should record requested information here and retain this guide as a permanent record of your purchase.

Model No. \_\_\_\_\_

Serial No. \_\_\_\_\_

## INTRODUCTION

<b>Safety Precautions</b> .....	2
<b>Table of Contents</b> .....	3-4
<b>DVD &amp; HDD Recorder Overview</b> .....	5-9
Recordable Discs .....	5
Playable Discs .....	5
Disc-related terms .....	5
Types of video CDs .....	5
About DVD-R and DVD-RW disc .....	6
• What are 'recording modes'? .....	6
• Is editing a DVD like editing a video tape? .....	6
• About word 'Original' and 'Playlist' .....	6
Reset the recorder .....	6
About the internal hard disk drive .....	7
Cards capable of displaying and saving .....	7
• Regarding Write Protect .....	7
• Inserting/Removing the Memory Card .....	7
Notes on JPEG Recordings .....	8
Notes on MP3 Recordings .....	8
Precautions .....	9
• Handling the unit .....	9
• Cleaning the unit .....	9
• Remote Control Operation Range .....	9
• Remote Control Battery Installation .....	9
Notes on Discs .....	9
• Handling discs .....	9
• Storing discs .....	9
• Cleaning discs .....	9
About Symbols .....	9
• About the $\emptyset$ symbol display .....	9
• About the disc symbols for instructions .....	9
<b>Front Panel</b> .....	10
<b>Function Display Window</b> .....	11
<b>Remote Control Overview</b> .....	12
<b>Rear Panel</b> .....	13

## PREPARATION

<b>Connections</b> .....	14-18
Connecting to the Aerial .....	14
Connections to Your TV .....	15
Connecting to a cable box or satellite receiver .....	16
Connecting an external decoder box .....	16
Connecting to an Amplifier .....	17
Accessory Audio/Video (A/V) Connections to Recorder .....	18
Connecting a Digital Camcorder .....	18
<b>Before Operation</b> .....	19-33
Initial Settings .....	19
General Operation .....	19
General .....	19-23
• Auto Program .....	19
• Program Edit .....	20-21
• Auto Clock Set .....	22
• Manual Clock Set .....	22
• TV Aspect .....	22
• Progressive Scan .....	23
• AV1 Decoder .....	23
• PBC .....	23
• Initialize .....	23

Language .....	24
• Display Menu .....	24
• Disc Language .....	24
Audio .....	25
• Dolby Digital .....	25
• DTS .....	25
• MPEG .....	25
• Sampling Frequency .....	25
• Vocal .....	25
• DRC (Dynamic Range Control) .....	25
Lock (Parental Control) .....	26-27
• Set Password .....	26
• Rating .....	26
• Country Code .....	27
Recording .....	27-28
• Record Mode .....	27
• Record Aspect .....	27
• Auto Chapter .....	28
• DV Rec Audio .....	28
• Video Rec Audio .....	28
Disc .....	28-29
• Disc Format .....	28
• Finalize .....	29
• Disc Label .....	29
• Disc Protect .....	29
Using the Home Menu .....	30
General Explanation of On-Screen Display .....	31-33
• Displaying Information While Watching TV .....	31
• Displaying Disc Information on-screen .....	31-33

## PLAYBACK

<b>Operation with HDD, DVD and Video CD</b> ..	34-37
Playing a HDD, DVD, or Video CD .....	34
General Feature .....	34
• Moving to another TITLE .....	34
• Moving to another CHAPTER/TRACK .....	34
• Search .....	34
• Still Picture and Frame-by-Frame Playback .....	34
• Slow Motion .....	35
• Random .....	35
• Repeat .....	35
• Repeat A-B .....	35
• Time Search .....	35
• Zoom .....	36
• Marker Search .....	36
• Checking the contents of DVD Video discs: Menus .....	36
• Title Menu .....	36
• Disc Menu .....	36
• Camera Angle .....	36
• Changing the Audio Soundtrack .....	36
• Changing the Audio Channel .....	37
• 3D Surround .....	37
• Subtitles .....	37
• Instant Skip .....	37
• Finding Locations on a Disc .....	37
• Last Condition Memory .....	37
• PIP (Picture in Picture) .....	37

**Audio CD and MP3 Operation . . . . . 38-40**

- Playing an Audio CD or MP3 file . . . . . 38
  - Audio CD menu options . . . . . 38
  - Music menu options . . . . . 38
  - Erasing MP3 file(s) or folder(s) from the HDD or Memory Card . . . . . 38
  - Moving MP3 files . . . . . 39
  - Copying MP3 files to another media . . . . . 39
  - Naming an MP3 file . . . . . 39
  - Pause . . . . . 40
  - Moving to Another Track . . . . . 40
  - Repeat . . . . . 40
  - Random . . . . . 40
  - 3D Surround . . . . . 40
  - Changing the Audio Channel . . . . . 40
  - Search . . . . . 40
  - Repeat A-B . . . . . 40

**Programmed Playback with Audio CD and MP3 . 41**

**JPEG File Operation . . . . . 42-44**

- Viewing a JPEG Disc . . . . . 42
  - Photo menu options . . . . . 42
  - Skip Images . . . . . 42
  - Rotate Images . . . . . 42
  - Erasing JPEG file(s) or folder(s) from the HDD or Memory Card . . . . . 42
  - View Slide Shows . . . . . 43
  - To listen to music while slide show simultaneously . . . . . 43
  - Naming a JPEG File . . . . . 43
  - Moving JPEG files . . . . . 44
  - Copying JPEG files . . . . . 44

**RECORDING**

**Recording Overview . . . . . 45-46**

- About DVD recording . . . . . 45
  - Disc types and recording formats, modes, and settings . . . . . 45
- About HDD recording . . . . . 45
  - Notes for recording . . . . . 45
  - Recording TV audio channels . . . . . 45
- Recording time and picture quality . . . . . 45
  - Restrictions on video recording . . . . . 46
  - What is 'CPRM'? . . . . . 46
  - Copyright . . . . . 46
- Additional Information for Recording . . . . . 46
  - Clean-up Recording . . . . . 46
  - Playing Your Recordings on Other DVD Players (Finalizing a Disc) . . . . . 46

**Timeshift (Pause, Live TV/Playback) Setup and Operation . . . . . 47**

- Basic Recording . . . . . 48**
  - Basic Recording from a TV . . . . . 48
  - Instant Timer Recording . . . . . 48

**Timer Recording . . . . . 49-50**

- Checking Timer Recording Details . . . . . 50
  - Canceling a Timer Recording . . . . . 50
  - Stopping a Timer Recording in Progress . . . . . 50
- Timer Recording Troubleshooting . . . . . 50

**Recording from External Input . . . . . 51-52**

- Recording from External Components . . . . . 51
- Recording from a Digital Camcorder . . . . . 51
- What is DV? . . . . . 52
  - DV-Related Messages . . . . . 52
  - Troubleshooting . . . . . 52

**EDITING**

**Title List and Chapter List Menu Overview 53-54**

- Title List-HDD menu options . . . . . 54
- Title List-Original menu options . . . . . 54
- Chapter List-Original menu options . . . . . 54
- Title List-Playlist menu options . . . . . 54
- Chapter List-Playlist menu options . . . . . 54

**HDD, VR Mode: Original and Playlist Editing . 55-60**

- Titles, Chapters and Parts . . . . . 55
- Adding Chapter Markers . . . . . 55
- Changing Title or Chapter Thumbnails . . . . . 55
- Making a New Playlist . . . . . 56
- Adding Additional Title/Chapters to the Playlist . . . . . 56
- Deleting an Original or Playlist Title/Chapter . . . . . 57
- Deleting a Part . . . . . 57
- Naming a Title . . . . . 58
- Sort . . . . . 58
- Combining Two Titles Into One . . . . . 59
- Divide One Titles Into Two . . . . . 59
- Combining Two Chapters Into One . . . . . 60
- Moving a Playlist Chapter . . . . . 60

**Copying . . . . . 61-62**

- Introduction . . . . . 61
  - Restrictions on copying . . . . . 61
  - Copyright . . . . . 61
  - High-speed copying . . . . . 61
- One Touch Copy (HDD to DVD) . . . . . 61
- One Touch Copy (DVD to HDD) . . . . . 61
- Dubbing from HDD to DVD . . . . . 62
- Dubbing from DVD to HDD . . . . . 62



**Video Mode: Original Editing . . . . . 63**

- Using the Title List . . . . . 63
- Deleting a Title . . . . . 63
- If the disc has already been finalized . . . . . 63

**REFERENCE**

- Language Code List . . . . . 64**
- Country Code List . . . . . 65**
- Controlling Your TV with the Supplied Remote Control . . . . . 66**
- Troubleshooting . . . . . 67-68**
- Specifications . . . . . 69**

**About the symbols for instructions**

-  Indicates hazards likely to cause harm to the unit itself or other material damage.
-  Indicates special operating features of this unit.
-  Indicates tips and hints for making the task easier.

## Recordable Discs



12cm/8cm, single-sided, single layer disc  
Approx. max. recording time (LQ mode):  
240 minutes (4.7GB), 80 minutes (1.46GB)



12cm/8cm, single-sided, single layer disc  
Approx. max. recording time (LQ mode):  
240 minutes (4.7GB), 80 minutes (1.46GB)

### Notes

- This recorder cannot record CD-R or CD-RW discs.
- DVD-R/RW and CD-R/RW discs recorded using a personal computer or a DVD or CD recorder may not play if the disc is damaged or dirty, or if there is dirt or condensation on the recorder's lens.
- If you record a disc using a personal computer, even if it is recorded in a compatible format, there are cases in which it may not play because of the settings of the application software used to create the disc. (Check with the software publisher for more detailed information.)

## Playable Discs



DVD  
(8 cm/12 cm disc)



Video CD (VCD)  
(8 cm / 12 cm disc)



Audio CD  
(8 cm/12 cm disc)

In addition, this unit can play DVD-R/DVD-RW discs; CD-R/CD-RW discs that contain audio titles, MP3 files, or JPEG files; SVCD; and Kodak picture CDs.

### Notes

- Depending on the conditions of the recording equipment or the CD-R / RW (or DVD-R / RW, DVD+R / RW) disc itself, some CD-R/RW (or DVD-R / RW, DVD+R / RW) discs cannot be played on the unit.
- Do not attach any seal or label to either side (the labeled side or the recorded side) of a disc.
- Do not use irregularly shaped CDs (e.g., heart-shaped or octagonal). Doing so may result in malfunctions.

### Regional code of the recorder and DVDs

This recorder is designed and manufactured for playback of Region 2 encoded DVD software. The region code on the labels of some DVD discs indicates which type of the recorder can play those discs. This unit can play only DVD discs labeled 2 or ALL. If you try to play any other discs, the message "Incorrect region code. Can't play back" will appear on the TV screen. Some DVD discs may not have a region code label even though their playback is prohibited by area limits.



### Notes on DVDs and Video CDs

Some playback operations of DVDs and Video CDs may be intentionally fixed by software manufacturers. As this unit plays DVDs and Video CDs according to disc content designed by the software manufacturer, some playback features of the unit may not be available or other functions may be added. Refer also to the instructions supplied with the DVDs and Video CDs. Some DVDs made for business purposes may not be played on the unit.

### Disc-related terms

#### Title (DVD only)

The main film content or accompanying feature content or music album.

Each title is assigned a title reference number enabling you to locate it easily.

#### Chapter (DVD only)

Sections of a picture or a musical piece that are smaller than titles. A title is composed of one or several chapters. Each chapter is assigned a chapter number to enable you to locate the chapter you want. Depending on the disc, chapters may not be labeled.

#### Track (Video CD and audio CD only)

Sections of a picture or a musical piece on a video CD or an audio CD. Each track is assigned a track number, enabling you to locate the track you want.

#### Scene

On a video CD with PBC (Playback control) functions, moving pictures and still pictures are divided into sections called "Scenes". Each scene available is displayed on the Scene menu and assigned a scene number, enabling you to locate the scene you want.

A scene may be composed of one or several tracks.

### Types of video CDs

There are two types of video CDs:

#### Video CDs equipped with PBC (Version 2.0)

PBC (Playback control) functions allow you to interact with the system via menus, search functions, or other typical computer-like operations. Moreover, high resolution still pictures can be played if they are included on the disc.

#### Video CDs not equipped with PBC (Version 1.1)

Operated in the same way as audio CDs, these discs allow playback of video pictures as well as sound, but they are not equipped with PBC.

## About DVD-R and DVD-RW disc

### How are DVD-R and DVD-RW discs different?

The essential difference between DVD-R and DVD-RW is that DVD-R is a record-once medium, while DVD-RW is a re-recordable/erasable medium. You can re-record/erase a DVD-RW disc approximately 1,000 times.

### Can I play my recordable discs in a regular DVD player?

Generally, DVD-R discs and DVD-RW discs recorded in Video mode are playable in a regular DVD player, but they must be 'finalized' first. This process fixes the contents of the disc to make them readable to other DVD players as DVD-Video discs.

DVD-RW discs recorded in VR (Video Recording) mode are playable in some players.



This indicates a product feature that is capable of playing DVD-RW discs recorded with Video Recording format.

### What are 'recording modes'?



There are two recording modes available using this recorder: VR mode and Video mode. When recording to a DVD-R disc, recordings are always in Video mode. DVD-RW discs can be formatted for VR mode recording or Video mode recording.

#### VR mode recording

- 3 different picture quality/recording time settings available (HQ, SQ, LQ)
- Not playable on regular DVD players
- Recordings can be extensively edited

#### Video mode recording

- 3 different picture quality/recording time settings available (HQ, SQ, LQ)
- Playable on regular DVD players (after finalizing)
- Limited editing features

Many functions of this recorder are dependent on the recording mode. One or more of the symbols ( ,  ) appear by each function explained in this manual so that you can see at a glance whether it's relevant for the disc loaded.

You can find more information on disc formats and recording modes on page 45.



DVD-Video Format (Video mode) is a new format for recording on DVD-R/RW discs that was approved by the DVD Forum in 2000. You may therefore experience problems playing recordable DVD discs in some players. Symptoms include video artifacts, audio and/or video dropouts and playback suddenly stopping. Our company cannot take responsibility for problems playing discs recorded on this recorder in other players.

### Is editing a DVD like editing a video tape?

No. When you edit a video tape you need one video deck to play the original tape and another to record the edits. With DVD, you edit by making a 'Playlist' of what to play and when to play it. On playback, the recorder plays the disc according to the Playlist.

### About word 'Original' and 'Playlist'

Throughout this manual, you will often see the words Original and Playlist to refer to the actual content and the edited version.

- **Original:** content refers to what's actually recorded on the disc.
- **Playlist:** content refers to the edited version of the disc — how the Original content is to be played.

### Reset the recorder

If you observe any of the following symptoms...

- The unit is plugged in, but the power will not turn on or off.
- The front panel display is not working.
- The recorder is not operating normally.

...you can reset the recorder as follows:

- Press and hold the POWER button for at least five seconds. This will force the unit to power off. Press the POWER button again to turn the unit back on.
- Unplug the power cord, wait at least five seconds, and then plug it in again.

Disc type	Disc format	Recording mode	Functions
DVD-Video	Video format	n/a	Playback only
DVD-RW	Video Recording format (default)	VR mode	Playback, recording, Original/Playlist editing
	Video format	Video mode	Playback, limited recording, limited editing
DVD-R	Video format	Video mode	Playback, limited recording, limited editing

## About the internal hard disk drive

The internal hard disk drive (HDD) is a fragile piece of equipment. Please use the recorder following the guidelines below to protect against possible HDD failure.

We recommend that you back up your important recordings onto DVD-R/RW discs in order to protect against accidental loss.

- Do not move the recorder while it is on.
- Install and use the recorder on a stable, level surface.
- Do not block the rear vent/cooling fan.
- Do not use the recorder in excessively hot or humid places, or in places that may be subject to sudden changes in temperature. Sudden changes in temperature can cause condensation to form inside the recorder. This can be a cause of HDD failure.
- While the recorder is switched on, do not unplug from the wall socket or switch the electricity off from the breaker switch.
- Do not move the recorder immediately after switching it off. If you need to move the recorder, please follow the steps below:
  1. After the message POWER OFF is shown in the display, wait at least two minutes.
  2. Unplug from the wall socket.
  3. Move the player.
- If there's a power failure while the recorder is on there is a chance that some data on the HDD will be lost.
- The HDD is very delicate. If used improperly or in an unsuitable environment, it is possible that the HDD will fail after a few years of use. Signs of problems include playback unexpectedly freezing and noticeable block noise (mosaic) in the picture. However, sometimes there will be no warning signs of HDD failure.  
If the HDD fails, no playback of recorded material will be possible. In this case it will be necessary to replace the HDD unit.

## Cards capable of displaying and saving

- SD Memory Card
- Multi Media Card (MMC)
- Memory Stick (MS)
- Compatible with: FAT 12, FAT 16, or FAT 32
- Use this unit to format a memory card when using for the first time. Note that the memory card may no longer be usable on other equipment once formatted on this unit.
- Only use the memory cards recommended above.

### Regarding Write Protect

For cards that have a write protect switch, if the switch is on it will not be possible to write, erase or format the card.

## Inserting/Removing the Memory Card

We recommend to insert or remove the memory card after turning the unit off.

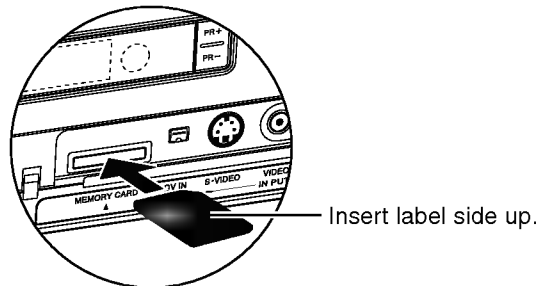

### Inserting the card.

Insert straight-in until it fits into place.

### Removing the card

Press on the center of the card.

### Notes

- Keep the memory card out of reach of children. If swallowed, seek medical advice immediately.
- A memory card may not be used for this recorder

## Notes on JPEG Recordings

- Depending on the size and number of JPEG files, it may take several minutes for the recorder to read the content. If you don't see an on-screen display after several minutes, some of the files are too big — reduce the resolution of the JPEG files to less than 4 megapixels.
- The total number of files and folders on a media are free but the total number of files and folders on the folder should be less than 1999.
- Some media may be incompatible due to different recording formats or the condition of the media.
- When you are using software such as “Easy CD Creator” to burn JPEG files on a CD-R, ensure that all selected files have the “.jpg” extension before copying them into the CD layout.
- If the files have “.jpe” or “.jpeg” extensions, please rename them as “.jpg” files.
- File names without the “.jpg” extension cannot be read by this DVD player, even though the files are shown as JPEG image files in Windows Explorer®.

## Notes on MP3 Recordings

### **About MP3**

- An MP3 file is audio data compressed using the MPEG1 audio layer 3 file-encoding scheme. Files that have the “.mp3” file extension are called “MP3 files”.
- The recorder cannot read MP3 files that have file extensions other than “.mp3”.

### **MP3 file compatibility with the recorder is limited as follows:**

1. CD-R/RW physical format should be “ISO 9660” and “JOLIET”.
2. If you record MP3 files using software which cannot create a FILE SYSTEM (e.g., Direct-CD, etc.), it is impossible to playback MP3 files. “Easy-CD Creator” is recommended.
3. The total number of files and folders on the media are free but the total number of files and folders on the folder should be less than 1999.

This recorder requires discs/recordings to meet certain technical standards in order to achieve optimal playback quality. Pre-recorded DVDs are automatically set to these standards. There are many different types of recordable disc formats (including CD-R containing MP3 files) that require certain pre-existing conditions (see above) to insure compatible playback.

**Please note that permission is required in order to download MP3 files and music from the Internet. Our company has no right to grant such permission. Permission should always be sought from the copyright owner.**

## Precautions

### Handling the unit

#### **When shipping the unit**

The original shipping carton and packing materials come in handy. For maximum protection, re-pack the unit as it was originally packaged at the factory.

#### **When setting up the unit**

The picture and sound of a nearby TV, VCR, or radio may be distorted during playback. In this case, position the unit away from the TV, VCR, or radio, or turn off the unit after removing the disc.

#### **To keep the surface clean**

Do not use volatile liquids, such as insecticide spray, near the unit. Do not leave rubber or plastic products in contact with the unit for a long period of time. They will leave marks on the surface.

### Cleaning the unit

#### **To clean the cabinet**

Use a soft, dry cloth. If the surfaces are extremely dirty, use a soft cloth lightly moistened with a mild detergent solution. Do not use strong solvents such as alcohol, benzene, or thinner, as these might damage the surface of the unit.

#### **To obtain a clear picture**

The recorder is a high-tech, precision device. If the optical pick-up lens and disc drive parts are dirty or worn, the picture quality will be poor.

Regular inspection and maintenance are recommended after every 1,000 hours of use. (This depends on the operating environment.)

For details, please contact your nearest dealer.

### Remote Control Operation Range

Point the remote control at the remote sensor and press the buttons.

### Remote Control Battery Installation

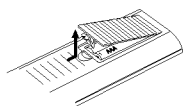

Detach the battery cover on the rear of the remote control, and insert two R03 (size AAA) batteries with  $\oplus$  and  $\ominus$  aligned correctly.

#### **Caution**

Do not mix old and new batteries. Never mix different types of batteries (standard, alkaline, etc.).

## Notes on Discs

### Handling discs

Do not touch the playback side of the disc. Hold the disc by the edges so that fingerprints will not get on the surface. Do not stick paper or tape on the disc.



### Storing discs

After playing, store the disc in its case.

Do not expose the disc to direct sunlight or sources of heat, or leave it in a parked car exposed to direct sunlight, as there may be a considerable temperature increase inside the car.

### Cleaning discs

Fingerprints and dust on the disc can cause poor picture quality and sound distortion. Before playing, clean the disc with a clean cloth. Wipe the disc from the center outward.



Do not use strong solvents such as alcohol, benzene, thinner, commercially available cleaners, or anti-static spray intended for older vinyl records.

## About Symbols

### About the $\emptyset$ symbol display

" $\emptyset$ " may appear on the TV screen during operation. This icon means the function explained in this owner's manual is not available on that specific disc.

### About the disc symbols for instructions

A section whose title has one of the following symbols are applicable only to those discs represented by the symbol.

-  Hard Disk Drive
-  Memory Card
-  DVD-R/RW with Video recording mode
-  DVD-RW with VR recording mode
-  DVD-Video disc
-  Video CDs
-  Audio CDs
-  MP3 Discs
-  JPEG Disc





Go to NEXT chapter/track.  
Press and hold for two seconds for a fast forward search during playback.

**STOP (■)**

Stops playback or recording.



Go to beginning of current chapter/ track or to previous chapter/track.  
Press and hold for two seconds for a fast reverse search during playback.

**PAUSE (II)**

Pause playback or recording temporarily, press again to exit pause mode.

**POWER button and indicator**

Switches the recorder ON or OFF.  
Lights up red when the recorder is in standby mode.

**REC (●)**

Starts recording. Press repeatedly to set the recording time.

**PLAY (▶)**

Starts playback.

**TIMESHIFT**

Activates pause live TV/playback (timeshift) for a live TV program.

**PR (+/-)**

Scans up or down through memorized channels.

**Remote Sensor**

Point the recorder remote control here.

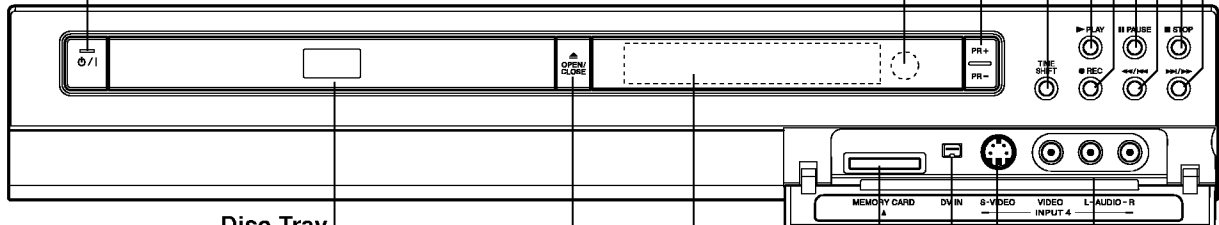

**Disc Tray**

Insert a disc here.

**OPEN/CLOSE (▲)**

Opens or closes the disc tray.

**Display window**

Shows the current status of the recorder.

**MEMORY CARD Slot**

Insert a memory card (SD, MMC or MS).

**DV IN**

Connect the DV output of a digital camcorder.

**INPUT 4 (S-VIDEO IN)**

Connect the S-Video output of an external source (TV/ Monitor, VCR, Camcorder, etc.).

**INPUT4 (VIDEO IN/AUDIO IN (Left/Right))**

Connect the audio/video output of an external source (Audio system, TV/ Monitor, VCR, Camcorder, etc.).



**REC** The recorder is recording.

 Indicates when the recorder is in timer recording or a timer recording is programmed.

**HQ, SQ, LQ**  
Indicates recording mode.

**ST** Indicates a stereo broadcast is being received.

**BIL** Indicates when a BILINGUAL broadcast is being received.

**CHP** Indicates current chapter number.

**TRK** Indicates current track number.

**TV** Indicates when the recorder is in TV tuner mode.

**TITLE** Indicates current title number

**T/S** Indicates the timeshifting mode.

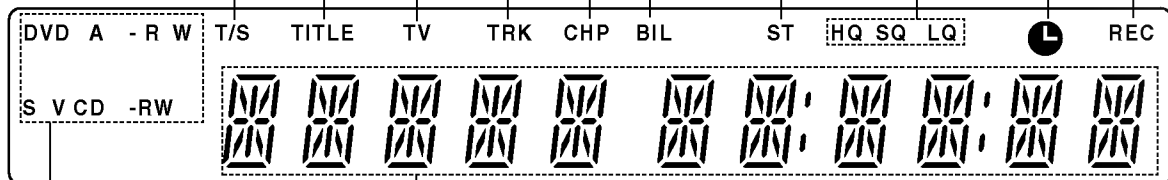

**Character indicators**

Indicates clock, total playing time, elapsed time, title number, chapter/track number, channel, etc.

**Disc type indicators**

Indicates the type of disc loaded.

**POWER**  
Switches the recorder ON or OFF.

**TV/DVD**  
To view channels selected by the recorder tuner or by the TV tuner.

**3D SURR.**  
Selects 3D SURROUND during playback.

**PIP**  
Selects PIP function on or off.

**0-9 numerical buttons**  
Selects numbered options in a menu.

**AV**  
Changes the input to use for recording (Tuner, AV1-4, or DV IN).

**AUDIO**  
Selects an audio language (DVD) or an audio channel (CD).

**SUBTITLE**  
Selects a subtitle language.

**ANGLE**  
Selects a DVD camera angle, if available.

**REC (●)**  
Starts recording. Press repeatedly to set the recording time.

**REC MODE**  
Selects the recording mode: HQ, SQ, or LQ.

**TIMER REC**  
Displays Timer Record menu.

**TIMESHIFT**  
Activates pause live TV/playback (timeshift) for a live TV program.

**MARKER**  
Marks any point during playback.

**SEARCH**  
Displays Marker Search menu.

**SETUP**  
Accesses or removes the Setup menu.

**DUBBING**  
Copies DVD to HDD (or HDD to DVD).

**I.SKIP (INSTANT SKIP)**  
Skips 15 seconds forward on the disc (about the length of a typical TV commercial).

**TITLE**  
Displays the disc's Title menu, if available.

**CHP ADD**  
Inserts a chapter marker when playing/recording a VR mode DVD-RW disc.

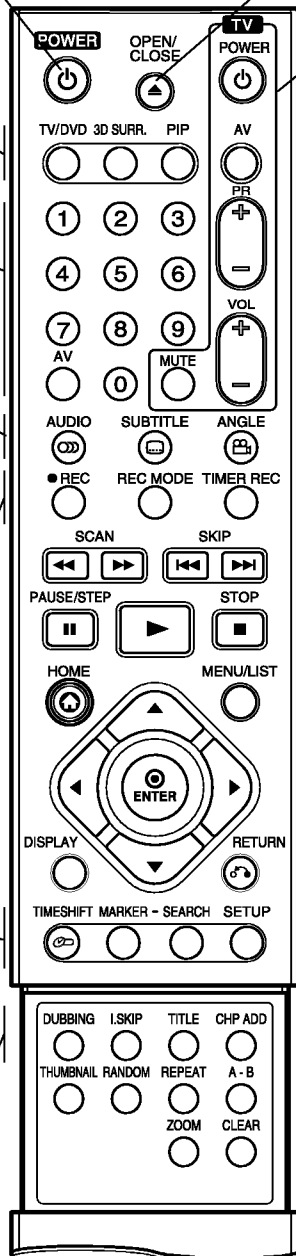

**OPEN/CLOSE (▲)**  
Opens and closes the disc tray.

**TV Control Buttons**  
**POWER:** Turns the TV on or off.  
**AV:** Selects the TV's source.  
**PR +/-:** Selects TV's channel.  
**VOL +/-:** Adjusts TV's volume.  
**MUTE:** Temporarily turns TV sound OFF, press again to restore.

**SKIP (I◀◀ / ▶▶I)**  
Go to next chapter or track. Returns to beginning of current chapter or track or go to previous chapter or track.

**SCAN (◀◀ / ▶▶)**  
Search backward or forward.

**PAUSE/STEP (II)**  
Pause playback or recording temporarily, press again to exit pause mode.

**▶ (PLAY)**  
Starts playback.

**STOP (■)**  
Stops playback or recording.

**HOME**  
Accesses or removes the HOME menu.

**MENU/LIST**  
Accesses menu on a DVD disc Switches between Title List-Original and Title List-Playlist menu.

**ENTER**  
- Acknowledges menu selection.  
- Displays information while viewing a TV program.

**◀ / ▶ / ▲ / ▼ (left/right/up/down)**  
Selects an option in the menu.

**▲ / ▼ (up/down)**  
Scans up or down through memorized channels.

**DISPLAY**  
Accesses On-Screen Display.

**RETURN (↶)**  
- Removes the menu.  
- Displays the menu of a video CD with PBC.

**THUMBNAIL**  
Selects a thumbnail picture for the current title and chapter for use in the Original and Playlist menu.

**RANDOM**  
Plays tracks in random order.

**REPEAT**  
Repeat chapter, track, title, all.

**A-B**  
Repeat sequence.

**ZOOM**  
Enlarges DVD video image.

**CLEAR**  
Removes a track number on the Program List or a mark on the Marker Search menu.

**AERIAL**

Connect the aerial to this terminal.

**EURO AV 2 DECODER**

Connect the audio/video output of an external source (Pay-TV decoder, Set Top Box, VCR, etc.).

**COAXIAL (Digital audio out jack)**

Connect to digital (coaxial) audio equipment.

**COMPONENT VIDEO OUT / PROGRESSIVE SCAN (Y Pb Pr)**

Connect to a TV with Y Pb Pr inputs.

**VIDEO OUT/AUDIO OUT (Left/Right)**

Connect to a TV with video and audio inputs.

**VIDEO IN 3 / AUDIO IN 3 (Left/Right)**

Connect the audio/video output of an external source (Audio system, TV/Monitor, VCR, Camcorder).

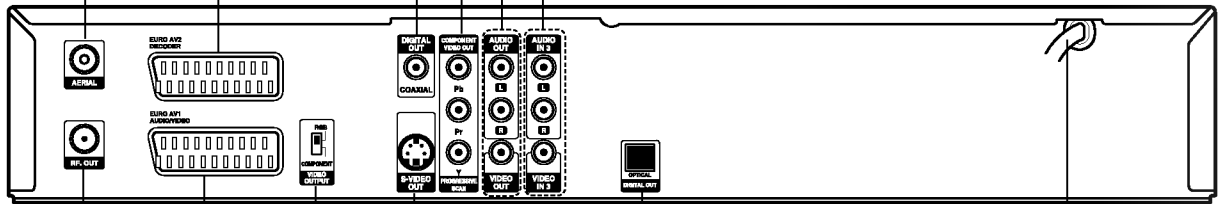

**AC Power Cord**

Plug into the power source.

**OPTICAL (Digital audio out jack)**

Connect to digital (optical) audio equipment.

**S-VIDEO OUT**

Connect to a S-Video Input on TV.

**VIDEO OUTPUT Switch**

Select either COMPONENT VIDEO OUT / PROGRESSIVE SCAN or RGB signal of EURO AV1 AUDIO/ VIDEO terminal depending on how you connect the recorder to the TV.

**EURO AV 1 AUDIO/VIDEO**

Connect to a TV with SCART jack.

**RF. OUT**

Passes the signal from the AERIAL to your TV/monitor

**Caution**

Do not touch the inner pins of the jacks on the rear panel. Electrostatic discharge may cause permanent damage to the unit.

## Connecting to the Aerial

Remove the aerial cable plug from your TV set and insert it into the aerial socket at the back of the recorder. Plug one end of the aerial cable into the TV socket on the recorder and the other end into the aerial input socket on your TV set.

### RF coaxial connection

Connect the RF. OUT jack on the recorder to the aerial input jack on the TV using the 75-ohm Coaxial Cable supplied (R). The RF. OUT jack passes the signal through from the AERIAL jack.

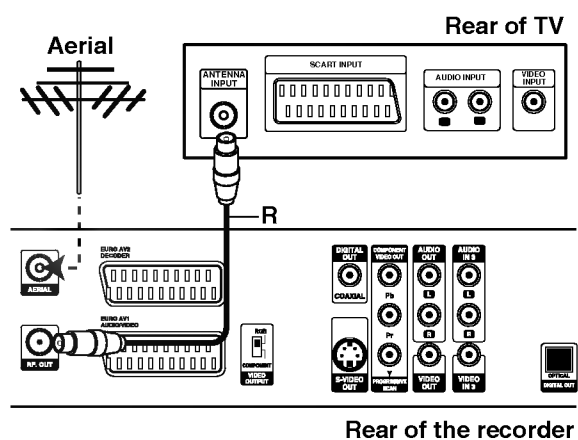

## Tips

- Depending on your TV and other equipment you wish to connect, there are various ways you could connect the recorder. Use only one of the connections described below.
- Please refer to the manuals of your TV, VCR, Stereo System or other devices as necessary to make the best connections.

## Caution

- Make sure the recorder is connected directly to the TV. Tune the TV to the correct video input channel.
- Do not connect the recorder's AUDIO OUT jack to the phono in jack (record deck) of your audio system.
- Do not connect your recorder via your VCR. The DVD image could be distorted by the copy protection system.

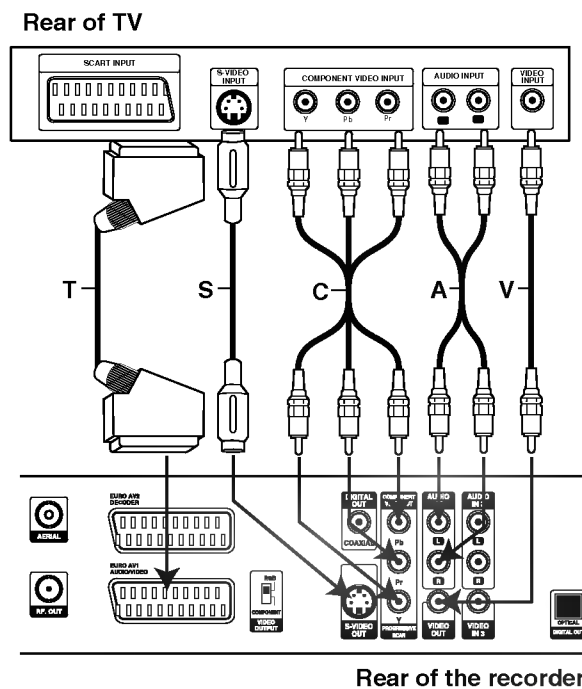

## Connections to Your TV

- Make one of the following connections, depending on the capabilities of your existing equipment.
- When using the COMPONENT VIDEO OUT / PROGRESSIVE SCAN jacks, set the VIDEO OUTPUT switch to COMPONENT. When using the SCART jack, set the VIDEO OUTPUT switch to RGB.

### SCART connection

Connect the EURO AV1 AUDIO/VIDEO scart jack on the recorder to the corresponding in jacks on the TV using the scart cable (T).

### Video connection

Connect the VIDEO OUT jack on the recorder to the video in jack on the TV using the video cable (V).

### S-Video connection

Connect the S-VIDEO OUT jack on the recorder to the S-Video in jack on the TV using the S-Video cable (S).

### Component Video connection

Connect the COMPONENT VIDEO OUT / PROGRESSIVE SCAN jacks on the recorder to the corresponding input jacks on the TV using an Y Pb Pr cable (C).

### Progressive Scan (ColorStream®Pro) connection

If your television is a high-definition or "digital ready" television, you may take advantage of the recorder's progressive scan output for the highest video resolution possible. If your TV does not accept the Progressive Scan format, the picture will appear scrambled if you try Progressive Scan on the recorder.

Connect the COMPONENT VIDEO OUT / PROGRESSIVE SCAN jacks on the recorder to the corresponding in jacks on the TV using the Y Pb Pr cable (C).

## Notes

- Set the Progressive to "On" on the setup menu for progressive signal, see page 23.
- Set the progressive to "Off" by removing any disc from the unit and close the disc tray. See that "no disc" is displayed on the display window. Then press STOP and hold it for five seconds before releasing it.
- Progressive scan does not work with the analog video connections (yellow VIDEO OUT jack) or S-VIDEO connection.

### Audio (Left/Right) Connection

Connect the left and right AUDIO OUT jacks of the recorder to the audio left and right IN jacks on the TV using the audio cables (A). Do not connect the recorder's AUDIO OUT jack to the phono in jack (record deck) of your audio system.

## Connecting to a cable box or satellite receiver

If you have a cable or satellite receiver with a built-in decoder, connect it to this recorder and your TV as shown on this page. If you are using a separate decoder box for your cable/satellite TV, set up following the instructions on the right.

Using the setup on this page you can:

- Record any channel by selecting it on the cable box/satellite tuner.

- 1 Connect RF cables as shown. This enables you to watch and record TV channels.
- 2 Use the SCART cable to connect the EURO AV1 AUDIO/VIDEO connector to a SCART AV connector on your TV. This enables you to watch discs.
- 3 Use a SCART cable to connect the EURO AV2 DECODER connector to a SCART AV connector on your satellite/cable box. This enables you to record scrambled TV channels.

### Tip

This recorder has a 'loop through' function. This feature allows you to record a TV program from the built-in TV tuner in this recorder, while watching a satellite or cable channel (see page 48).

### Caution:

Do not connect this recorder 'through' your VCR, satellite receiver or cable box. Always connect each component directly to your TV or AV receiver.

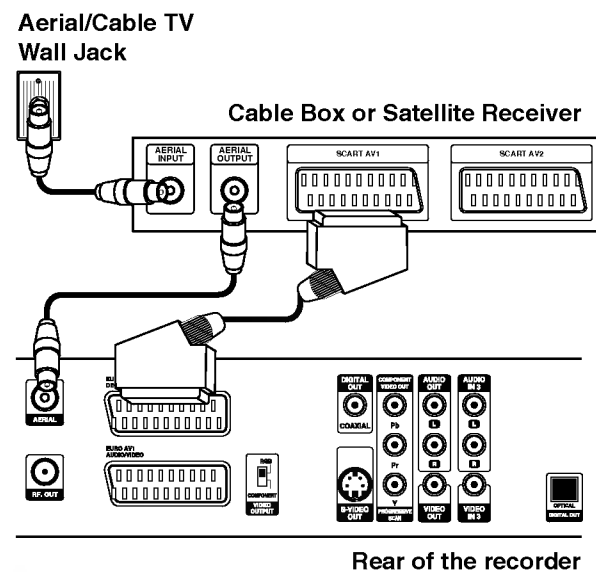

## Connecting an external decoder box

If you have an external, dedicated decoder box for your satellite or cable TV system, use the setup described on this page.

- 1 Connect the cable from the aerial/cable TV outlet to the aerial input on your cable/satellite tuner.
- 2 Use a SCART cable to connect your decoder to your cable/satellite tuner. See the manual for your decoder box for more detailed instructions.
- 3 Use a SCART cable to connect the EURO AV2 DECODER connector to a SCART AV connector on your satellite/cable box.
- 4 Use the SCART cable to connect the EURO AV1 AUDIO/VIDEO connector to a SCART AV connector on your TV.

### Caution:

- Do not connect your decoder box directly to this recorder.
- Information from the decoder (for example, relating to pay TV services), is only viewable when this recorder is off (in standby).
- For timer recording to work properly on this recorder, the satellite/cable box must also be switched on during recording.
- It is not possible to watch one TV program and record another using this setup.

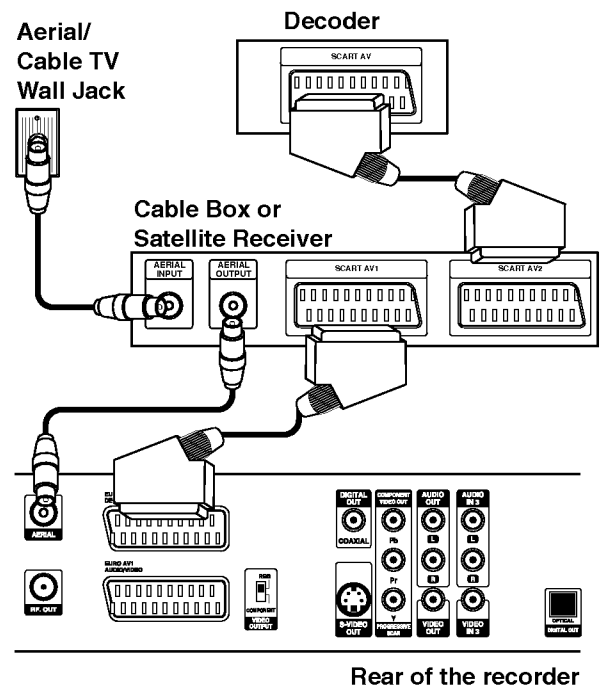

## Connecting to an Amplifier

### Connecting to an amplifier equipped with two channel analog stereo or Dolby Pro Logic II/ Pro Logic

Connect the Left and Right AUDIO OUT jacks on the recorder to the audio left and right in jacks on your amplifier, receiver, or stereo system, using the audio cables (A).

### Connecting to an amplifier equipped with two channel digital stereo (PCM) or to an Audio/Video receiver equipped with a multi-channel decoder (Dolby Digital™, MPEG 2, or DTS)

- 1 Connect one of the recorder's DIGITAL AUDIO OUT jacks (OPTICAL O or COAXIAL X) to the corresponding in jack on your amplifier. Use an optional digital (optical O or coaxial X) audio cable.
- 2 You will need to activate the recorder's digital output. (See "Audio" on page 25).

#### Digital Multi-channel sound

A digital multi-channel connection provides the best sound quality. For this you need a multi-channel Audio/Video receiver that supports one or more of the audio formats supported by your recorder (MPEG 2, Dolby Digital and DTS). Check the receiver manual and the logos on the front of the receiver.

#### Caution:

Due to the DTS Licensing agreement, the digital output will be in DTS digital out when DTS audio stream is selected.

#### Notes

- If the audio format of the digital output does not match the capabilities of your receiver, the receiver will produce a strong, distorted sound or no sound at all.
- Six Channel Digital Surround Sound via digital connection can only be obtained if your receiver is equipped with a Digital Multi-channel decoder.
- To see the audio format of the current DVD in the on-screen display, press AUDIO.
- This recorder does not perform internal (2 channel) decoding of a DTS sound track. To enjoy DTS multi channel surround, you must connect this recorder to a DTS compatible receiver via one of this recorder's digital audio outputs.

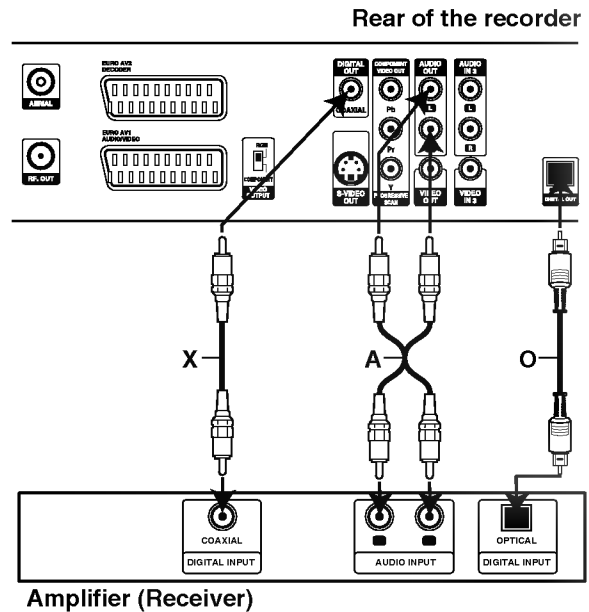

## Accessory Audio/Video (A/V) Connections to recorder

Connect the input jacks (AV3, AV4) on the recorder to the audio/video out jacks on your accessory component, using audio/video cables.

### Note

If you use the S-VIDEO IN jack on the front panel, the VIDEO IN jack on the front panel is not available.

Jack panel of Accessory Component  
(VCR, Camcorder, etc.)

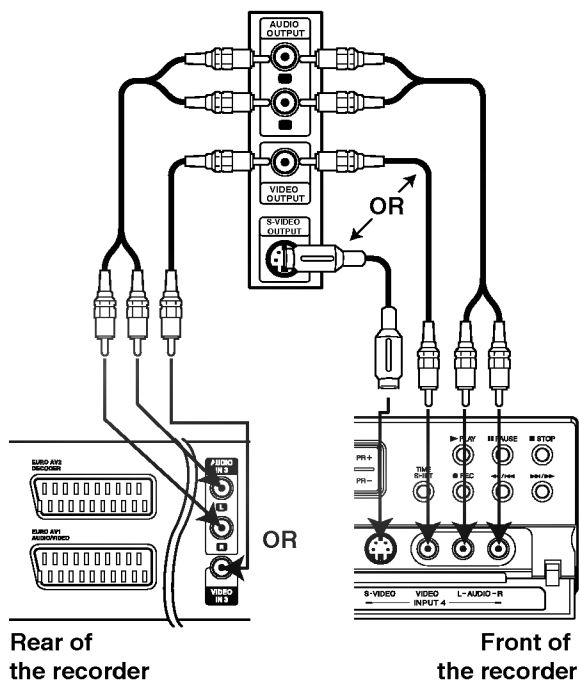

## Connecting a Digital Camcorder

Using the front panel DV IN jack, it is possible to connect a DV digital camcorder and digitally transfer DV tapes or DVD-R/RW discs to DVD-R/RW or HDD.

Use a DV cable (not supplied) to connect the DV in/out jack of your DV camcorder to the front panel DV IN jack of this recorder.

### Note

This jack is for connection to DV equipment only. It is not compatible with digital satellite tuners or D-VHS video decks.

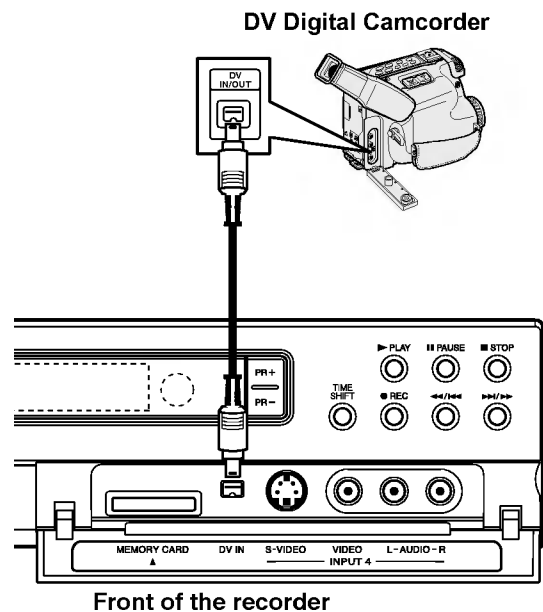

## Initial Settings

In this menu system, there are several ways to customize the settings provided. Most menus consist of three levels to set up the options, but some require greater depth for the variety of settings. If you press SETUP, only the first and second level of the menu system will appear on the TV screen. The third level can be displayed by pressing ►. For navigating the menu levels, you will see “►” on the right side of the menu label to help you go to the next level.

### To bring up and exit the Menu:

Press SETUP to bring up the menu. A second press of SETUP will take you back to initial screen.

### To go to the next level:

Press ► on the remote control.

### To go back to the previous level:

Press ◀ on the remote control.

## General Operation

- 1** Press SETUP.  
The Setup menu appears.
- 2** Use ▲ / ▼ to select the desired option.
- 3** While the desired item is selected, press ► to move to the second level.
- 4** Use ▲ / ▼ to select the second desired option.
- 5** Press ► to move to the third level.
- 6** Use ▲ / ▼ to select the desired setting then press ENTER to confirm your selection.  
Some items require additional steps.
- 7** Press SETUP to exit the Setup menu.

## General

### Auto Program

This recorder is equipped with a frequency synthesized tuner capable of receiving up to 88 TV channels.

#### Preparation:

Connect the recorder to the desired type of aerial, as shown in Connecting to the Aerial on page 14.

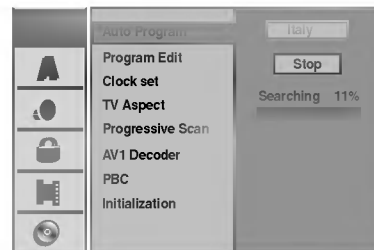

- 1** Press SETUP.  
The Setup menu appears.
- 2** Use ▲ / ▼ to select the General option.
- 3** While the General option is selected, press ► to move to the second level.
- 4** Use ▲ / ▼ to select the Auto Program option.
- 5** Press ► to move to the third level.  
Country option is highlighted.
- 6** Use ▲ / ▼ to select a country then press ►.  
“Start” icon is highlighted.
- 7** Press ENTER to begin the channel search.  
The tuner will automatically cycle through all available channels in the area and place them in the tuner’s memory.

## Program Edit

You can edit a channel manually (add, delete, name, move, etc.).

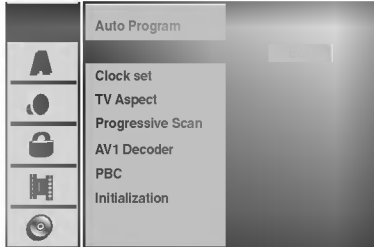

- 1** Press **SETUP**.  
The Setup menu appears.
- 2** Use **▲ / ▼** to select the **General** option.
- 3** While the **General** option is selected, press **▶** to move to the second level.
- 4** Use **▲ / ▼** to select the **Program Edit** option then press **▶** to move to the third level.  
"Edit" icon is highlighted.
- 5** Press **ENTER**.  
Program List menu appears.

PR	Ch.	MFT	Station
01	C 22	+10	BBC1
	C 23	0	ITV
03	C 7	0	ITV
04	C 27	-10	CH2
05	C 17	0	CHTV
06	C 33	0	WEST
07	C 34	+20	ANGLI
08	C 47	0	ABC
09	C 10	-60	TV2
10			
11			

- 6** Use **▲ / ▼** to select a **PR** number then press **ENTER**.  
Program List options appears on the left side of the menu display.
- 7** Use **▲ / ▼** to select an option then press **ENTER** to confirm.

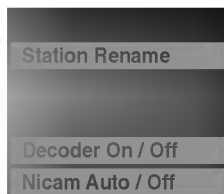

**Program Edit:** Edits the selected program.

**Station Rename:** Edits the station name.

**Move:** Moves the program's location on the program list.

**Delete:** Deletes the program from program list.

**Decoder On / Off:** Set the decoder for the program to On or Off.

**Nicam Auto / Off :** Set the NICAM function to for the program Auto or Off.

**8** Press **RETURN** (↵) repeatedly to exit **Program List** menu.

## Program Edit

You can perform a search to select and store TV channels manually.

1. Use **▲ / ▼** to select a program on the Program List menu then press **ENTER**.  
The menu options appears on the left side of the menu.
2. Use **▲ / ▼** to select 'Program Edit' option from the options then press **ENTER**.  
Program Edit menu appears.

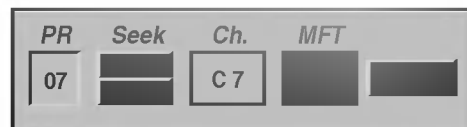

3. See the descriptions on below to use Program Edit menu.
  - ◀ / ▶ (left/right): Moves the cursor to the previous or next column.
  - ▲ / ▼ (up/down): Changes the setting at the current cursor position.
  - PR:** Indicates program number (display only)
  - Seek:** Searches a station automatically. Use **◀ / ▶** to select **Seek** option then press **▲ / ▼**.  
Searching stops when the recorder tunes in a station.
  - Ch.:** Changes the channel number to edit. Use **◀ / ▶** to select **Ch.** option then press **▲ / ▼**.
  - MFT:** Changes the frequency for fine tuning. Use **◀ / ▶** to select **MFT** option then press **▲ / ▼**.
4. Choose **OK** then press **ENTER** to confirm the setting and returns to the Program List menu.

## Program Edit (Continued)

### Station Rename

You can name stations independently. Names can be up to 5 characters long.

1. Use ▲ / ▼ to select a program on the Program List menu then press ENTER.  
The menu options appears on the left side of the menu.
2. Use ▲ / ▼ to select 'Station Rename' option from the options then press ENTER.  
Keyboard menu appears.

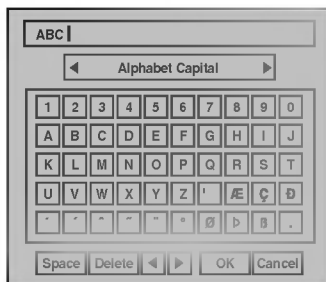

3. Enter a name for the station. Use ◀ / ▶ / ▲ / ▼ to select a character then press ENTER to confirm your selection.
  - **Alphabet Capital:** Switches the keyboard upper case characters.
  - **Alphabet Small:** Switches the keyboard to lower case characters.
  - **Symbol:** Switches the keyboard to symbol characters.
  - **OK:** Select to finish.
  - **Cancel:** Cancels all entered characters.
  - **Space:** Inserts a space at the cursor position.
  - **Delete:** Deletes the previous character at the cursor position.
  - **◀ / ▶:** Moves cursor to left or right.

### Remote control buttons for entering a name

- ▶ (PLAY): Inserts a space at the cursor position.
- || (PAUSE/STEP): Deletes the after character at the cursor position.
- (STOP), CLEAR: Deletes the previous character at the cursor position.
- ◀◀ / ▶▶: Moves cursor to left or right.
- Numbers (0-9):** Enters the character of corresponding location on the selected column.
- MENU/LIST, DISPLAY:** Switches the keyboard type (Alphabet Capital, Alphabet Small, Symbols)

4. Choose 'OK' icon then press ENTER to fix the name and returns to the Program List menu.

### Sort TV channels manually

You can sort the program's position on the Program List menu.

1. Use ▲ / ▼ to select a program on the Program List menu then press ENTER.  
The menu options appears on the left side of the menu.
2. Use ▲ / ▼ to select 'Move' option from the options then press ENTER.
3. Use ▲ / ▼ to select a desired position then press ENTER to store.

### Deleting a program

You can delete a program on the Program List menu.

1. Use ▲ / ▼ to select a program on the Program List menu then press ENTER.  
The menu options appears on the left side of the menu.
2. Use ▲ / ▼ to select 'Delete' option from the options then press ENTER. The Program is deleted.

### Setting the Decoder On/Off

1. Use ▲ / ▼ to select the program you wish to link with the decoder function on the Program List menu then press ENTER.  
The menu options appears on the left side of the menu.
2. Use ▲ / ▼ to select 'Decoder On/ Off' option from the options then press ENTER. If you select On, 'Decoder' appears on the menu screen.

### Setting the NICAM Auto/Off

This recorder can receive Hi-Fi sound transmissions in NICAM Stereo. However, if sound distortion occurs, due to poor reception, you can switch Off

1. Use ▲ / ▼ to select a program on the Program List menu then press ENTER.  
The menu options appears on the left side of the menu.
2. Use ▲ / ▼ to select 'Nicom Auto / Off' option from the options then press ENTER. If you select Auto, 'NICAM' appears on the menu screen.

## Auto Clock Set

When Channel auto search is completed the actual Time and Date are also set automatically. If the time in the recorder display is not correct, the clock must be set manually.

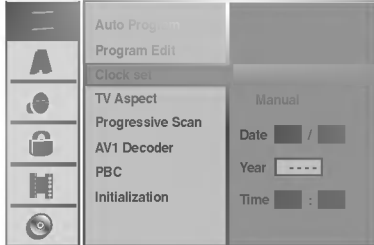

- 1** Press **SETUP**.  
The Setup menu appears.
- 2** Use **▲ / ▼** to select the **General** menu.
- 3** While the **General** option is selected, press **▶** to move to the second level.
- 4** Use **▲ / ▼** to select the **Clock set** option.
- 5** Press **▶** to move to the third level.
- 6** Use **▲ / ▼** to select the **Auto** option then press **ENTER**.
- 7** Press **SETUP** to exit the Setup menu.

### Note

There are cases where the TV station does not send, or sends wrong date and/or time information and the recorder sets the incorrect time. If this happens, we recommend that you set the clock manually.

## Manual Clock Set

- 1** Follow steps 1-5 as shown above (**Auto Clock Set**).
- 2** Use **▲ / ▼** to select the **Manual** option then press **ENTER**.

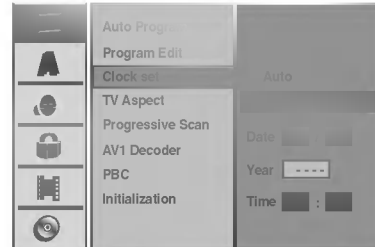

- 3** Enter the necessary information for date and time.
  - ◀ / ▶** (left/right): Moves the cursor to the previous or next column.
  - ▲ / ▼** (up/down): Changes the setting at the current cursor position.
- 4** Press **ENTER** to confirm your setting, then press **SETUP** to exit the Setup menu.

### Note

After manual clock setting, the clock will be updated automatically but the date will not updated.

## TV Aspect

You can choose:

- **4:3 Letter Box**: Select when a standard 4:3 TV is connected. Displays theatrical images with masking bars above and below the picture.
- **4:3 Pan Scan**: Select when a conventional TV set is connected. The video material formatted in the Pan & Scan style is played back in that style (Both sides of the picture are cut off).
- **16:9 Wide**: Select when a 16:9 wide TV is connected.

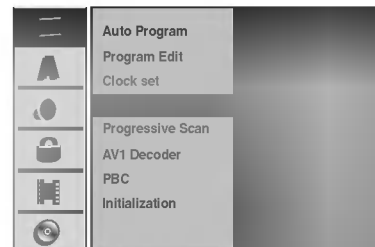

## Progressive Scan

Progressive Scan Video provides the highest quality pictures with less flickering.

If you are using the COMPONENT VIDEO OUT / PROGRESSIVE SCAN jacks, but are connecting the recorder to a standard (analog) television, set Progressive Scan to OFF.

If you are using the Component Video jacks for connection to a TV or monitor that is compatible with a progressive scan signal, set Progressive Scan to ON.

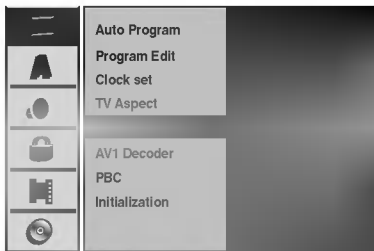

### Note

Progressive Scan will not be displayed in the setup menu when the VIDEO OUTPUT switch is set at RGB position.

### Caution

Once the setting for progressive scan output is entered, an image will only be visible on a progressive scan compatible TV or monitor. If you set Progressive Scan to On in error, you must reset the unit.

- 1) Remove any disc from the unit and close the disc tray. See that "NO DISC" is displayed on the display window.
- 2) Press STOP and hold it for five seconds before releasing it. The video output will be restored to the standard setting and a picture will once again be visible on a conventional analog TV or monitor.

## AV1 Decoder

We have already described, how to connect a decoder for pay-TV station on page 16. For viewing or recording of an encoded program from EURO AV1 AUDIO/VIDEO connector, you do not have to control anything. You just select AV1 source by pressing AV button and wait shortly until the decoding will start.

Choose 'ON' if your recorder is connected with a decoder, otherwise leave it set to 'OFF'.

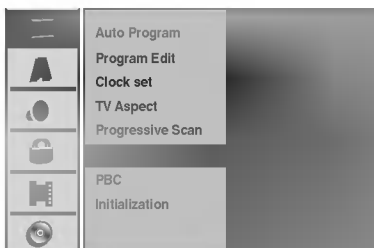

## PBC

The PBC setting can be changed. Set Playback Control (PBC) to ON or OFF.

- ON: Video CDs with PBC are played according to the PBC.
- OFF: Video CDs with PBC are played the same way as Audio CDs.

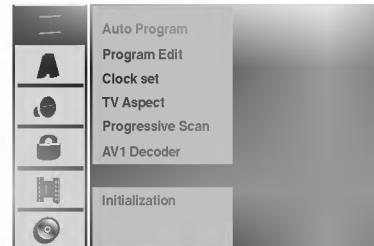

## Initialization

You can reset the recorder or initialize the HDD and Memory Card.

1. Press ▲ / ▼ to select the desired option then press ENTER. The confirm message will appear.
2. Use ◀ / ▶ to select "OK" or "Cancel" then press ENTER.

- **Factory Set:** If you need to, you can reset the recorder to all its factory settings. Some options can not be reset. (Rating, Password, and Country Code)
- **HDD format:** Initializes the HDD (Hard Disk Drive): everything recorded on the HDD will be erased.
- **M/C format:** Initializes the M/C (Memory Card): everything recorded on the Memory Card will be erased.

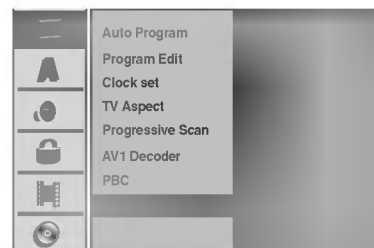

## Language

### Display Menu

Select a language for the Setup menu and on-screen display.

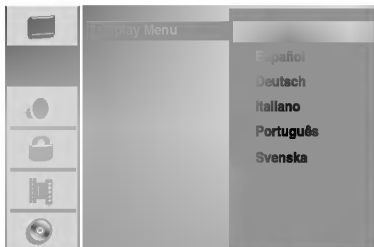

### Disc Language

Select a language for the disc's Menu, Audio, and Subtitle.

- Original: The original language set for the disc is selected.
- Other: To select another language, select Other option then press ENTER. Use the numbered and ENTER buttons to key-in the corresponding 4-digit number according to the language code list on page 64. If you a mistake before pressing ENTER, press ◀ repeatedly to delete one by one and correct it.

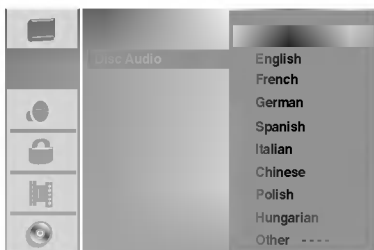

## Audio

Each DVD disc has a variety of audio output options. Set the recorder's Audio Output according to the type of audio system you use.

### Dolby Digital

**PCM:** Select when connected to a 2-channel digital stereo amplifier. The recorder's digital audio outputs sounds in the PCM 2ch format when you play a DVD video disc recorded on the Dolby Digital recording system.

**Bitstream:** Select "Bitstream" if you connected the recorder's DIGITAL OUT jack to a Dolby Digital decoder (or an amplifier or other equipment with a Dolby Digital decoder).

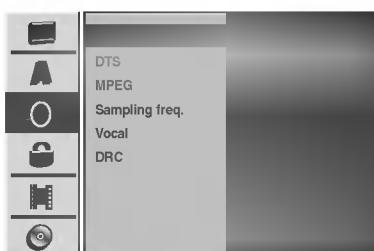

### DTS

**OFF:** If you select "OFF", the DTS signal is not output through the DIGITAL OUT jack.

**Bitstream:** Select "Bitstream" if you connected the recorder's DIGITAL OUT jack to a DTS decoder (or an amplifier or other equipment with a DTS decoder).

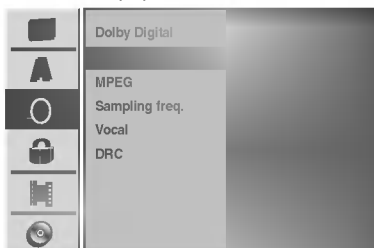

### MPEG

**PCM:** Select when connected to a 2-channel digital stereo amplifier. The recorder's digital audio outputs sounds in the PCM 2ch format when you play a DVD video disc recorded on the MPEG2 recording system.

**Bitstream:** Select "Bitstream" if you connected the recorder's DIGITAL OUT jack to a MPEG decoder (or an amplifier or other equipment with a MPEG decoder).

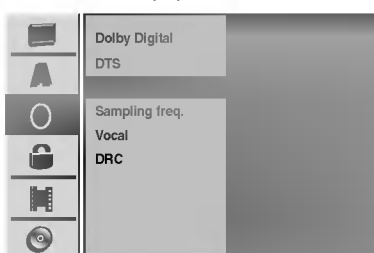

### Sampling Frequency

If your receiver or amplifier is NOT capable of handling 96 kHz signals, select 48 kHz. When this choice is made, this unit will automatically convert any 96 kHz signals to 48 kHz so your system can decode them. If your receiver or amplifier is capable of handling 96 kHz signals, select 96 kHz. When this choice is made, this unit will pass each type of signal through without any further processing.

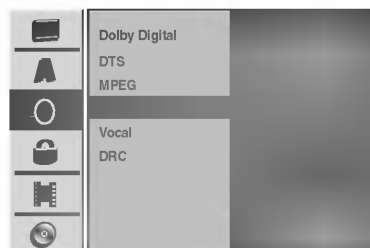

### Vocal

Set Vocal to ON only when a multi-channel karaoke DVD is playing. The karaoke channels on the disc will mix into normal stereo sound.

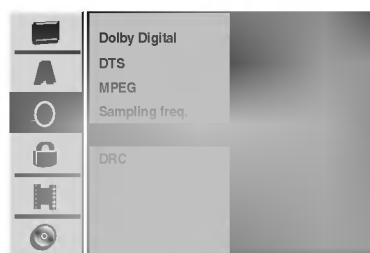

### DRC (Dynamic Range Control)

With the DVD format, you can hear a program's soundtrack in the most accurate and realistic presentation possible, thanks to digital audio technology. However, you may wish to compress the dynamic range of the audio output (the difference between the loudest sounds and the quietest ones). Then, you may listen to a movie at a lower volume without losing clarity of sound. Set DRC to ON for this effect.

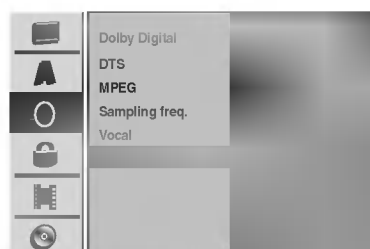

## Lock (Parental Control)

### Set Password



- 1** Press **SETUP**.  
The Setup menu appears.
- 2** Use **▲ / ▼** to select the **Lock** option.
- 3** While the **Lock** option is selected, press **▶** to move to the second level.
- 4** Use **▲ / ▼** to select the **Set Password** option.
- 5** Press **▶** to move to the third level.
- 6** When you have not entered a password yet; Enter a 4-digit password using the numbered buttons to create a personal 4-digit security password, then press **ENTER**. Enter the 4-digit password again and press **ENTER** to verify.  
**When you have already entered a password;** Enter a 4-digit password using the numbered buttons to confirm the personal 4-digit security password, then press **ENTER**.

#### **T**ip

If you make a mistake before pressing **ENTER**, press **◀** repeatedly to delete password numbers one by one then correct it.

- 7** While “**Change**” is selected, press **ENTER**.  
If you select “**Delete**” then press **ENTER**. The password is deleted.
- 8** Enter a 4-digit password using the numbered buttons to create a personal 4-digit security password then press **ENTER**.
- 9** Enter the 4-digit password again and press **ENTER** to verify.

#### **T**ip

If you a mistake before pressing **ENTER**, press **◀** repeatedly to delete password numbers one by one then correct it.

### If you forget your 4-digit code

If you forget your password, to clear the current password, follow the procedure below.

1. Press **SETUP** to display the Setup menu.
2. Use the Number buttons to enter the 6-digit number “210499”.
3. Select “**Yes**” then press **ENTER**. The 4-digit password is cleared. Enter a new code as shown left.

### Rating

Movies on DVDs may contain scenes not suitable for children. Therefore, discs may contain Parental Control information that applies to the complete disc or to certain scenes on the disc. These scenes are rated from Level 1 to 8, and alternatively, more suitable scenes are available for selection on some discs. Ratings are country-dependent. The Parental Control feature allows you to prevent discs from being played by your children or to have certain discs played with alternative scenes.

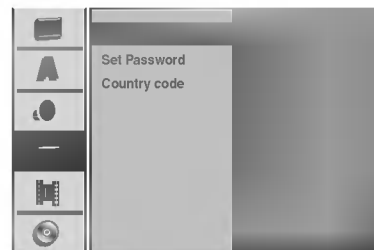

- 1** Follow steps 1-3 as shown above to the left (**Set Password**).
- 2** Use **▲ / ▼** to select the **Rating** option.
- 3** Press **▶** to move to the third level.
- 4** Follow step 6 as shown above to the left (**Set Password**).
- 5** Select a rating from 1 to 8 using the **▲ / ▼** buttons. One (1) has the least playback restrictions. Eight (8) has the most playback restrictions.  
**No Limit:** If you select **No Limit**, Parental Control is not active. The disc will play in full.  
**Level 1 to 8:** Some discs contain scenes not suitable for children. If you set a rating for the recorder, all disc scenes with the same rating or lower will be played. Higher rated scenes will not be played unless an alternative scene is available on the disc. The alternative must have the same rating or a lower one. If no suitable alternative is found, playback will stop. You must enter the 4-digit password or change the rating level in order to play the disc.
- 6** Press **ENTER** to confirm your rating selection, then press **SETUP** to exit the menu.



## Country Code

Enter the code of a country/area whose standards were used to rate the DVD video disc, referring to the list (See "Country Code List", page 65.).

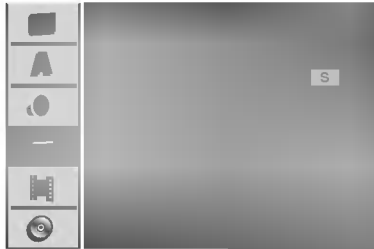

- 1** Press **SETUP**.  
The Setup menu appears.
- 2** Use **▲ / ▼** to select the **Lock** option.
- 3** While the **Lock** option is selected, press **▶** to move to the second level.
- 4** Use **▲ / ▼** to select the **Country code** option.
- 5** Press **▶** to move to the third level.
- 6** When you have not entered a password yet;  
Enter a 4-digit password using the numbered buttons to create a personal 4-digit security password, then press **ENTER**. Enter the 4-digit password again and press **ENTER** to verify.  
When you have already entered a password;  
Enter a 4-digit password using the numbered buttons to confirm the personal 4-digit security password, then press **ENTER**.

### Tip

If you a mistake before pressing **ENTER**, press **◀** repeatedly to delete password numbers one by one then correct it.

- 7** Select the first character using the **▲ / ▼** buttons.
- 8** Shift the cursor using **▶** buttons and select the second character using **▲ / ▼** buttons.
- 9** Press **ENTER** to confirm your country code selection, then press **SETUP** to exit the menu.

## Recording

### Record Mode

You can set the picture quality for recording; HQ (High Quality), SQ (Standard Quality), LQ (Low Quality).



- 1** Press **SETUP**.  
The Setup menu appears.
- 2** Use **▲ / ▼** to select the **Recording** option.
- 3** While the **Recording** option is selected, press **▶** to move to the second level.
- 4** Use **▲ / ▼** to select the **Rec Mode Set** option.
- 5** Press **▶** to move to the third level.  
The **HDD Mode** option is highlighted.
- 6** Use **▲ / ▼** to select a desired **Record Mode** for **HDD** (**HQ**, **SQ**, or **LQ**)
- 7** Press **▶** to move to **VR Mode** option then use **▲ / ▼** to select a desired **Record Mode** for **DVD-VR** disc (**HQ**, **SQ**, or **LQ**)
- 8** Press **▶** to move to **Video Mode** option then use **▲ / ▼** to select a desired **Record Mode** for **DVD-Video** Mode (**HQ**, **SQ**, or **LQ**).
- 9** Press **ENTER** to confirm your selection, then press **SETUP** to exit the menu.

### Record Aspect

When DVD recording, you can set the recording aspect ratio to suit the material you're recording (16:9 or 4:3).

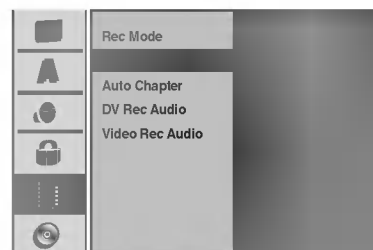

## Auto Chapter

When recording in Video mode, chapter markers are put in specified setting. You can change this interval to 3 minutes, 5 minutes or 10 minutes. If you select None, switch off automatic chapter marking altogether with the No Separation setting.

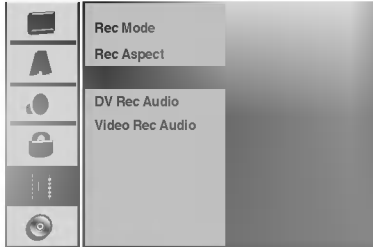

## DV Rec Audio

You need to set this if you have a camcorder using 32kHz/12-bit sound connected to the front panel DV IN jack. Some digital camcorders have two stereo tracks for audio. One is recorded at the time of shooting; the other is for overdubbing after shooting. On the Audio 1 setting, the sound that was recorded while shooting is used. On the Audio 2 setting, the overdubbed sound is used.

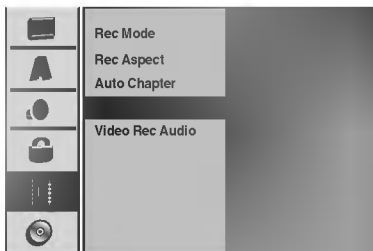

## Video Rec Audio

When DVD recording in Video mode and if the broadcast is bilingual, the recorder records left audio (Main language) or right audio (Bilingual language). It prevent to listen to both language simultaneously during playback the disc.

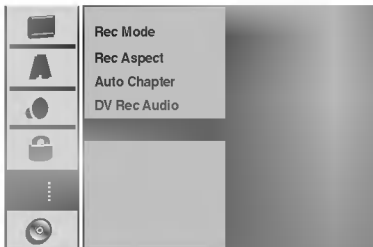

## Disc

### Disc Format

If you're recording on a DVD-R disc, the recording mode will always be Video mode. If you are using a DVD-RW disc, by default it will be VR mode. You can change this to Video mode from the Setup menu.

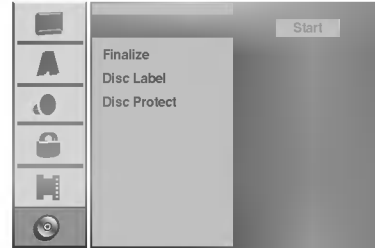

- 1** Press **SETUP**.  
The Setup menu appears.
- 2** Use **▲ / ▼** to select the **Disc** option.
- 3** While the **Disc** option is selected, press **▶** to move to the second level.
- 4** Use **▲ / ▼** to select the **Disc Format** option.
- 5** Press **▶** to move to the third level.  
Start icon is highlighted.
- 6** Press **ENTER**.  
Format Disc menu appears.



- 7** Use **◀ / ▶** to select a desired **Mode (VR Mode or Video Mode)** then press **ENTER**.  
Confirm message will appear.
- 8** Use **◀ / ▶** to select **"OK"** then press **ENTER**.  
It takes a few moments to initialize the disc.

### ⚠ Caution

If you want to change the disc format, everything recorded on the disc will be erased.

- 9** Press **SETUP** to exit the menu.



## Finalize

Finalizing 'fixes' the recordings in place so that the disc can be played on a regular DVD player or computer equipped with a suitable DVD-ROM drive.

Finalizing a Video mode disc creates a menu screen for navigating the disc. This is accessed by pressing MENU/LIST or TITLE.

### ⚠ Caution

- Once you've finalized a disc recording, you can't edit or record anything else on that disc.

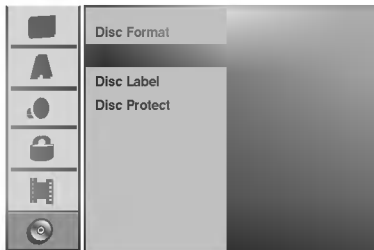

- 1 Follow steps 1-3 as shown on page 28 (Disc Format).
- 2 Use ▲ / ▼ to select the Finalize option.
- 3 Press ► to move to the third level. Finalize is highlighted.
- 4 Press ENTER. Finalize menu appears.

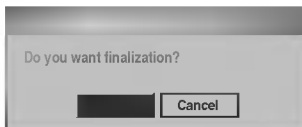

- 5 Select OK then press ENTER. The recorder starts finalizing the disc.

### Note

How long finalization takes depends on the type of disc, how much is recorded on the disc, and the number of titles on the disc. A disc recorded can take up to 3-4 minutes to finalize.

### Tip

If you load a DVD-RW that has already been finalized, you can 'unfinalize' it by choosing Unfinalize from the Finalize menu. After doing this, you can edit and re-record onto the disc.

## Disc Label

Use this to enter a name for the disc. This name appears when you load the disc and when you display disc information on-screen.

- The disc name can be up to 32 characters long.
- For discs formatted on a different recorder, you will see only a limited character set.

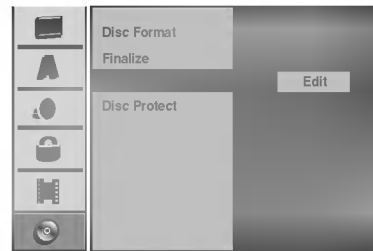

- 1 Follow steps 1-3 as shown Disc Format on page 28.
- 2 Use ▲ / ▼ to select the Disc Label option.
- 3 Press ► to move to the third level. Edit icon is highlighted.
- 4 Press ENTER. Keyboard menu appears.



- 5 Enter a name for the disc. Use ◀ / ▶ / ▲ / ▼ to select a character then press ENTER to confirm your selection. Refer step 3 as shown on page 21 (Station Rename).
- 6 Choose OK then press ENTER to fix the name and return to the Setup menu.
- 7 Press SETUP to exit the menu.

## Disc Protect

When recording in VR mode, set to ON to prevent accidental recording, editing or deleting of the disc loaded. If you need to unlock the disc to make edits, select OFF.

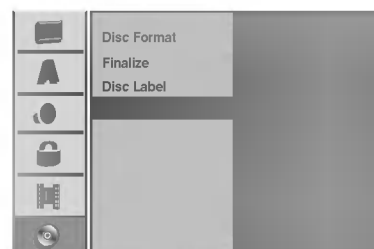

## Using the Home Menu

From the Home Menu screen you can access all the Media (HDD, DISC, MEMORY CARD) for playback and recording of the recorder.

**1** Press HOME to display the Home Menu screen.

**2** Use the ▲/▼/◀/▶ and ENTER buttons to select the option you want.

**3** To exit the HOME menu, press HOME.

- **TV (HDD):** Returns to live TV viewing for HDD recording.
- **TV (DVD):** Returns to live TV viewing for DVD recording.
- **TITLE LIST:** Displays the Title List menu.
- **MUSIC:** Displays Music (or Audio CD) menu.
- **PHOTO:** Displays Photo menu.
- **Movie:** Plays back the movie of the DVD and Video CD.

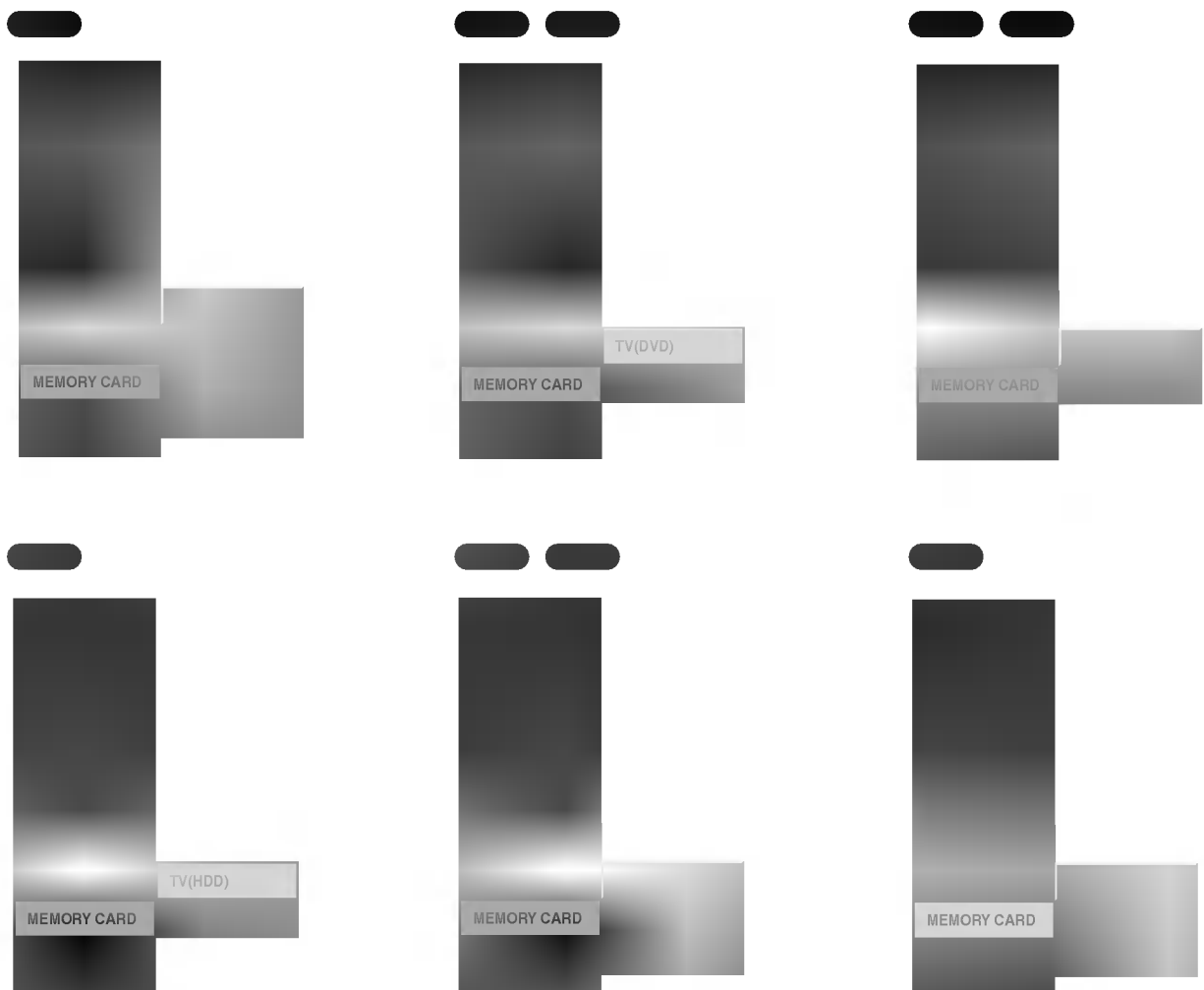

## General Explanation of On-Screen Display

This manual gives basic instructions for operating the recorder. Some DVDs require specific operation or allow only limited operation during playback. When this occurs, the symbol  appears on the TV screen, indicating that the operation is not permitted by the recorder or is not available on the disc.

### Displaying Information While Watching TV

During viewing the TV, press ENTER or DISPLAY to display/remove the information displayed on-screen.

e.g., when DVD-RW in VR mode is inserted.

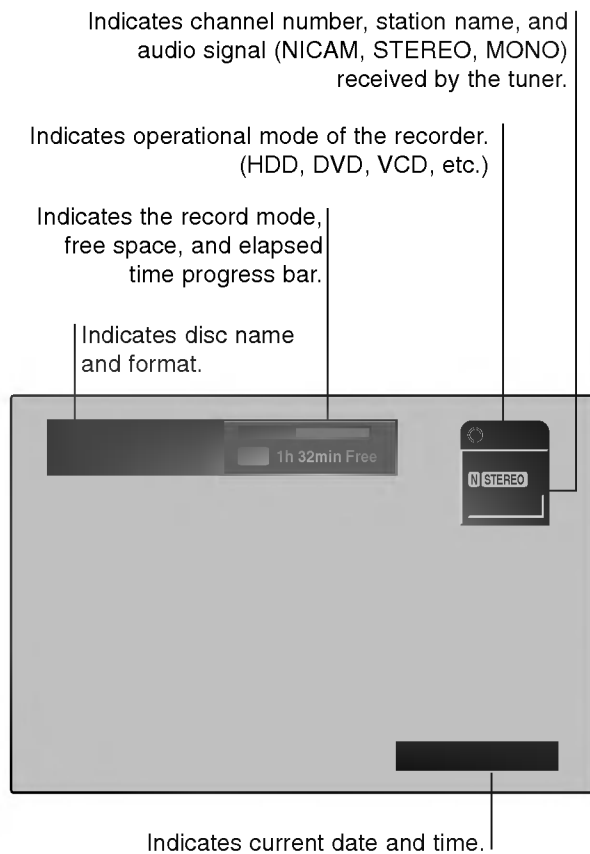

### Displaying Disc Information on-screen



You can display various information about the disc loaded on-screen.

**1** Press DISPLAY repeatedly to display/change the information displayed on-screen.

**2** To remove the on-screen display, press DISPLAY repeatedly until it disappears.

See the descriptions on next pages for detailed explanation during playing a disc.

### Temporary Feedback Field Icons

-  Resume play from this point
-  Action prohibited or not available

### Notes



- Some discs may not provide all of the features on the on-screen display example shown on next pages.
- If no button is pressed for 5 seconds, the on-screen display disappears.

## Displaying Disc Information on-screen (Continued)

Shows the title name, recording date, recording channel, recording mode, etc.

Shows the elapsed playing time and total time.







Shows the current media and playback mode.

Menu Options	Function (Use ▲ / ▼ to select desired option)	Selection Method
Title Number 	Shows the current title number and total number of titles and skip to the desired title number.	◀ / ▶, or Numbers, ENTER
Time 	Shows the elapsed playing time, and searches the point by the elapsed time directly.	◀ / ▶, Numbers, ENTER
Audio Channel 	Shows the audio channel, and changes the audio channel.	◀ / ▶

Shows the current title/chapter number and total number of titles/chapters.

Shows the elapsed playing time and total time.





Shows the current media and playback mode.

Menu Options	Function (Use ▲ / ▼ to select desired option)	Selection Method
Title Number 	Shows the current title number and total number of titles, and skips to the desired title number.	◀ / ▶, or Numbers, ENTER
Chapter Number 	Shows the current chapter number and total number of chapters, and skips to the desired chapter number.	◀ / ▶, or Numbers, ENTER
Time search 	Shows the elapsed playing time, and searches the point by the elapsed time directly.	◀ / ▶, Numbers, ENTER
Audio language and Digital Audio Output mode 	Shows the current audio soundtrack language, encoding method, and channel number, and changes the setting.	◀ / ▶
Subtitle language 	Shows the current subtitles language, and changes the setting.	◀ / ▶
Angle 	Shows the current angle number and total number of angles, and changes the angle number.	◀ / ▶
Sound 	Shows the current sound mode, and changes the setting.	◀ / ▶

Shows the current track number and total number of tracks, or shows PBC On mode.





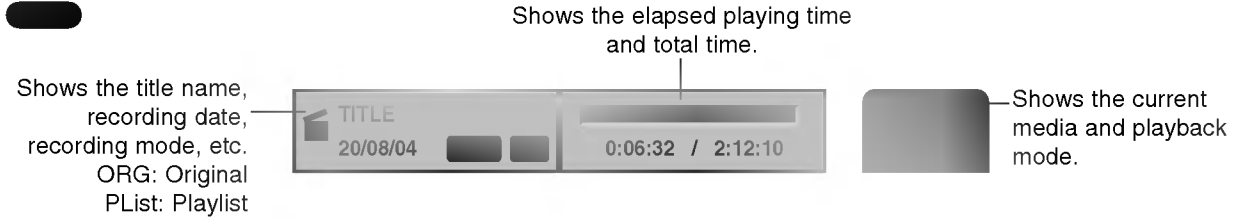

Shows the elapsed playing time and total time.

Shows the current media and playback mode.





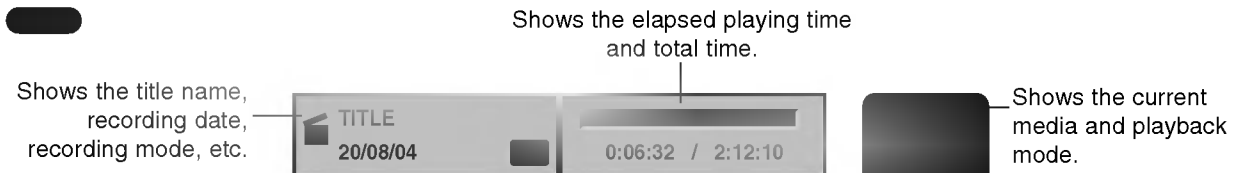

Menu Options	Function (Use ▲ / ▼ to select desired option)	Selection Method
Track Number 	Shows the current track number and total number of tracks or PBC On mode, and skip to the desired track number.	◀ / ▶, or Numbers, ENTER
Time 	Shows the elapsed playing time (Display only).	-
Audio Channel 	Shows the audio channel, and changes the audio channel.	◀ / ▶
Sound 	Shows the current sound mode, and changes the setting.	◀ / ▶

## Displaying Disc Information on-screen (Continued)



Menu Options	Function (Use ▲ / ▼ to select desired option)	Selection Method
Title Number 	Shows the current title number and total number of titles, and skips to the desired title number.	◀ / ▶, or Numbers, ENTER
Chapter Number 	Shows the current chapter number and total number of chapters, and skips to the desired chapter number.	◀ / ▶, or Numbers, ENTER
Time search 	Shows the elapsed playing time, and searches the point by the elapsed time directly.	◀ / ▶, Numbers, ENTER
Digital Audio Output mode 	Shows the current audio encoding method, and channel number, and changes the setting.	◀ / ▶
Subtitle language 	Shows the current subtitles language, and changes the setting.	◀ / ▶
Sound 	Shows the current sound mode, and changes the setting.	◀ / ▶



Menu Options	Function (Use ▲ / ▼ to select desired option)	Selection Method
Title Number 	Shows the current title number and total number of titles, and skips to the desired title number.	◀ / ▶, or Numbers, ENTER
Chapter Number 	Shows the current chapter number and total number of chapters, and skips to the desired chapter number.	◀ / ▶, or Numbers, ENTER
Time search 	Shows the elapsed playing time, and searches the point by the elapsed time directly.	◀ / ▶, Numbers, ENTER
Digital Audio Output mode 	Shows the current audio encoding method, and channel number, and changes the setting.	◀ / ▶
Subtitle language 	Shows the current subtitles language, and changes the setting.	◀ / ▶
Angle 	Shows the current angle number and total number of angles, and changes the angle number.	◀ / ▶
Sound 	Shows the current sound mode, and changes the setting.	◀ / ▶



## Playing a HDD, DVD, or Video CD

### Playback Setup

- Turn the TV on and select the video input source connected to the recorder.
- Audio system: Turn the audio system on and select the input source connected to the recorder.

**1** Choose a media (HDD or DVD) to play using HOME menu. (see page 30).





**2** Load your chosen disc in the tray, with the playback side down.



**3** Press OPEN/CLOSE () to close the tray. READING appears on the display window, and playback starts automatically. If playback does not start, press  (PLAY).  
In some cases, the disc menu might appear instead.

### Tip

#### If a menu screen is displayed

The menu screen may be displayed first after loading a DVD or Video CD which contains a menu.

 Use the  /  /  /  buttons to select the title/chapter you want to view, then press ENTER to start playback. Press TITLE or MENU/LIST to return to the menu screen.

- 
- Use the number buttons to select the track you want to view.  
Press RETURN () to return to the menu screen.
  - Menu setting and the exact operating procedures for using the menu may differ depending on the disc. Follow the instructions on the each menu screen. You may also set PBC to OFF under Setup menu. See page 23.

### Notes

- If Parental Control is set and the disc is not within the Rating settings (not authorized), the 4-digit code must be entered and/or the disc must be authorized (see “Rating”, on page 26).
- DVDs may have a Region Code.  
Your recorder will not play discs that have a region code different from your recorder. The region code for this recorder is 2 (two).

## General Features





### Note

Unless stated otherwise, all operations described use the remote control. Some features may also be available on the Setup menu.

## Moving to another TITLE









When a disc has more than one title, you can move to another title as follows:

- Press DISPLAY twice then use  /  to select the title icon. Then, press the appropriate numbered button (0-9) or  /  to select a title number.



























## Moving to another CHAPTER/TRACK











When a title on a disc has more than one chapter/track, you can move to another chapter/track as follows:

- Press SKIP ( or ) briefly during playback to select the next chapter/track or to return to the beginning of the current chapter/track.
- Press SKIP () twice briefly to step back to the previous chapter/track.
- To go directly to any chapter/track during playback, press DISPLAY twice. Then, use  /  to select chapter icon (or for a Video CD, select track icon). Then, enter the chapter/track number using the numbered buttons (0-9) or press  / .

## Search

-    
- 1 Press SCAN ( or ) during playback. The recorder will now go into SEARCH mode.
  - 2 Press SCAN ( or ) to select the required speed:  (Reverse play), X2, X4, X8, X16, X100 (backward) or X2, X4, X8, X16, X100 (forward).  
With a Video CD, the Search speed changes: X2, X4, X8 (backward) or X2, X4, X8 (forward).
  - 3 To exit SEARCH mode, press  (PLAY).

## Still Picture and Frame-by-Frame Playback

-    
- 1 Press PAUSE/STEP () during playback. The recorder will now go into PAUSE mode.
  - 2 You can advance or back up the picture frame-by-frame by pressing  /  repeatedly during PAUSE mode.
  - 3 To exit PAUSE mode, press  (PLAY).

### Note

The picture frame-by-frame in reverse is not available for Video CD.

### Tip

You can advance the picture frame-by-frame by pressing PAUSE/STEP () repeatedly on the remote control.

## General Features (Continued)

### Slow Motion



- 1 Press PAUSE/STEP (II) during playback. The recorder will now go into PAUSE mode.
- 2 Press SCAN (◀◀ or ▶▶) during PAUSE mode. The recorder will enter SLOW mode.
- 3 Use the SCAN (◀◀ or ▶▶) to select the required speed: ◀◀ 1/16, ◀◀ 1/8, ◀◀ 1/4, or ◀◀ 1/2 (backward), or ▶▶ 1/16, ▶▶ 1/8, ▶▶ 1/4, or ▶▶ 1/2 (forward). With a Video CD, the Slow speed changes: ▶▶ 1/16, ▶▶ 1/8, ▶▶ 1/4 or ▶▶ 1/2 (forward).
- 4 To exit Slow Motion mode, press ▶▶ (PLAY).

#### Note

Slow motion playback in reverse is not possible with Video CDs.

### Random



- 1 Press RANDOM during playback. The unit automatically begins Random Playback and "RANDOM" appears on the TV screen.
- 2 To return to normal playback, press RANDOM until "NORMAL" appears on the TV screen.

#### Tip

By pressing SKIP ▶▶▶ during Random playback, the unit selects another title (track) and resumes Random playback.

#### Note

- This function only works with DVD Karaoke discs or video CDs without PBC.
- On a Video CD with PBC, you must set PBC to OFF in the Setup menu to use the Random function. See page 23.

### Repeat



#### HDD - Repeat Title/Off

Press REPEAT to select a desired repeat mode.

- TITLE: repeats the current title .
- OFF: does not play repeatedly.

#### DVD Discs - Repeat Chapter/Title/All/Off

Press REPEAT to select a desired repeat mode.

- CHAPTER: repeats the current chapter.
- TITLE: repeats the current title .
- ALL: repeats the all titles on the disc. (VR mode DVD-RW disc only)
- OFF: does not play repeatedly.

#### Video CDs - Repeat Track/All/Off

Press REPEAT to select a desired repeat mode.

- TRACK: repeats the current track.
- ALL: repeats the all tracks on the disc.
- OFF: does not play repeatedly.

#### Note

On a Video CD with PBC, you must set PBC to OFF in the Setup menu to use the Repeat function. See page 23.

### Repeat A-B



To repeat a sequence in a title:

- 1 Press A-B at your chosen starting point. Repeat icon and 'A-' appears on the TV screen.
- 2 Press A-B again at your chosen end point. Repeat icon and 'A-B' appears on the TV screen, and the repeat sequence begins.
- 3 To cancel the sequence, press A-B repeatedly to select OFF.

### Time Search



The Time Search function allows you to start playing at any chosen time on the disc.

- 1 Press DISPLAY twice during playback. The on-screen display appears on the TV screen. The Time Search box shows the elapsed playing time of the current disc.
- 2 Within 5 seconds, use ▲ / ▼ to select the Time Search icon in the on-screen display. The "0:00:00" appears in the Time Search box.
- 3 Within 5 seconds, use the number buttons to enter the required start time. Enter hours, minutes, and seconds from left to right in the box. You can not enter an invalid time. If you enter the wrong numbers, press ◀ / ▶ to move the under bar ( ) to the wrong number. Then enter the correct numbers.
- 4 Within 5 seconds, press ENTER to confirm the start time. Playback starts from the selected time on the disc.

## General Features (continued)

### Zoom

The Zoom function allows you to enlarge the video image and to move through the enlarged image.

- 1 Press ZOOM during playback or still playback to activate the Zoom function.

Each press of the ZOOM button changes the TV screen in the sequence shown below.

x1 size → x2 size → x4 size → x1 size (normal size)

- 2 Use the ◀ / ▶ / ▲ / ▼ buttons to move through the zoomed picture.
- 3 To resume normal playback, press CLEAR or press ZOOM repeatedly until the normal picture appears.

### Note

The zoom function may not work for some DVDs.

### Marker Search for disc



#### To enter a Marker

You can start playback from up to six memorized points. To enter a marker, press MARKER at the desired point on the disc. The Marker icon appears on the TV screen briefly. Repeat to enter up to six markers.

#### To Recall or Clear a Marked Scene

1. During disc playback, press SEARCH. The marker search menu appears on the screen.
2. Use ◀ / ▶ / ▲ / ▼ to select a marked scene that you want to recall or clear.
3. Press ENTER and playback starts from the marked scene. Or, press CLEAR and the marked scene is erased from the marker search menu.

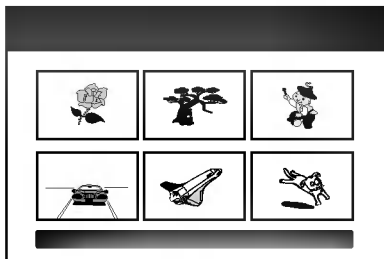

### Marker Search for HDD



During HDD title playback, you can mark only one. Press MARKER at the desired point during playback. Press SEARCH to recall the marked scene.

## Checking the Contents of DVD Video Discs: Menus

DVDs may contain menus that allow you to access special features. To open the disc menu, press MENU/LIST. Then, press the appropriate number button to select an option. Or, use the ◀ / ▶ / ▲ / ▼ buttons to highlight your selection, then press ENTER.

### Title Menu

- 1 Press TITLE.  
If the current title has a menu, the menu will appear on the TV screen. Otherwise, the disc menu may not appear.
- 2 The menu may contain camera angles, spoken language and subtitle options, and chapters for the title.

### Disc Menu

- 1 Press MENU/LIST.  
The disc menu is displayed.
- 2 To remove the disc menu, press MENU/LIST again.

### Camera Angle

If the disc contains scenes recorded at different camera angles, you can change to a different camera angle during playback.

- Press ANGLE then press ◀ / ▶ repeatedly during playback to select a desired angle.  
The number of the current angle appears on the TV screen.

### Tip

The ANGLE indicator will blink on the TV screen at scenes recorded at different angles to indicate that angle switching is possible.

## Changing the Audio Soundtrack



Press AUDIO then press ◀ / ▶ repeatedly during playback to hear a different audio language or audio soundtrack if available.

### Note

Some discs feature both Dolby Digital and DTS soundtracks. There is no analog audio output when DTS is selected. To listen to the DTS soundtrack, connect this recorder to a DTS decoder via one of the digital outputs. See page 17 for connection details.



## Changing the Audio Channel



With a Video CD and HDD, press AUDIO then press ◀ / ▶ repeatedly during playback to hear a different audio channel (STEREO, LEFT or RIGHT).

With DVD-RW discs recorded in VR mode and HDD that have both a main and a Bilingual audio channel, you can switch among Main (L), Sub (R), Main+sub (L+R), or Mono by pressing AUDIO.

## 3D Surround



This unit can produce a 3D Surround effect, which simulates multi-channel audio playback from two conventional stereo speakers, instead of the five or more speakers normally required to listen to multi-channel audio from a home theater system.

- 1 Press 3D SURR. then press ◀ / ▶ repeatedly during playback to select "3D SUR."
- 2 To turn off the 3D Surround effect, select "NORMAL".

## Subtitles



Press SUBTITLE then press ◀ / ▶ repeatedly during playback to see the different subtitle languages.

## Instant Skip



Each press I.SKIP skips forward 15 seconds.



If  appears, the feature is not available on the disc.

## Finding Locations on a Disc

You can directly access any point on a video CD using this function. Use this function only while a video CD is playing. Playback jumps to the point specified.

- 1 Press SEARCH during playback.  
The progress bar appears on the TV screen.



- 2 Use ◀ / ▶ to find a start position for playback.
- 3 Press ENTER to confirm the selected position.  
Playback starts from the selected position.



This function works only when no marker is memorized.

## Last Condition Memory



This recorder memorizes the user settings for the last disc that you have viewed. Settings remain in memory even if you remove the disc from the recorder or switch off the recorder. If you load a disc that had its settings memorized, the latest stop position is automatically recalled.



- Settings are stored in memory for use any time.
- This recorder does not memorize settings of a disc if you switch off the recorder before commencing to play it.

## PIP (Picture in Picture)



This function enables you to view the stored stations in sub picture during playback.

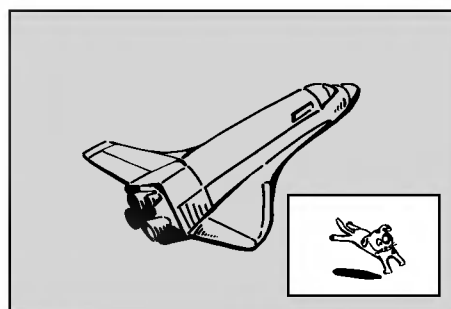

### On and off

Press PIP to switch on the sub picture, press this button again to switch it off.

### Input mode selection for sub picture

Press AV to select the input mode for the sub picture. Each time this button is pressed, each input mode for the sub picture is displayed as shown below.  
Tuner → AV1 → AV2 → AV3 → AV4

### Program selection for sub picture

Use ▲ / ▼ to change the program when sub picture's input is set to tuner. The selected program number is displayed on the TV screen. You can view the selected program by pressing STOP (■).

### Sub picture position change

Press ◀ / ▶ repeatedly until desired position is achieved. The sub picture moves clockwise or counterclockwise.

### Zoom Sub picture

Press ZOOM repeatedly to enlarge the sub picture, the magnification level increases up to three steps.

## Playing an Audio CD or MP3 file

The recorder can play audio CDs and MP3 files on HDD, Memory Card, CD-ROM, CD-R or CD-RW discs. Before playing MP3 files, read "Notes on MP3 Recordings" on page 8.

- 1** Press HOME.  
The HOME menu appears.
- 2** Select a media that contains MP3 or audio title then press ENTER.
- 3** Select 'MUSIC' option then press ENTER.  
The Audio CD or Music menu appears on the TV screen.

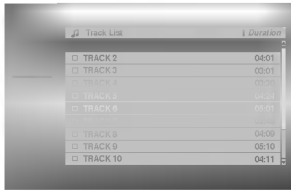

Audio CD Menu



Music Menu

- 4** Use ▲/▼ to select a track then press ► (PLAY).  
Playback starts.  
During playback, the current track's elapsed playing time will appear on the front panel display and menu. Playback will stop at the end of the disc.

### Tips

- Press DISPLAY to view ID3-Tag information for the MP3 file. If ID3-Tag information is not present, "not check" will appear. If you select a folder, the number of subfolders and number of MP3 files in the folder are displayed. Press DISPLAY again to remove the information screen.
- If you want to move to the upper directory, use the ▲ / ▼ to highlight ■. and press ENTER.
- You can also display HOME menu to select another media by pressing RETURN (↵).

- 5** To stop playback at any time, press STOP.

### Tip

You can create new folder. Select 'New Folder' option on the Music-HDD or Music-Memory Card menu then press ENTER. "NONAME##" folder is created.

## Audio CD menu options

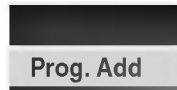

**Play:** Start playback the selected title.

**Prog. Add:** Adds the track(s) to Program List. (page 41)

## Music menu options



**Play:** Start playback the selected title.

**Copy:** Copies the track(s) to another media. (page 39)

**Prog. Add:** Adds the track(s) to Program List. (page 41)

## Music menu options

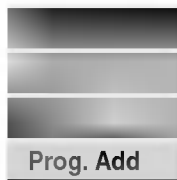

**Play:** Start playback the selected title.

**Delete:** Deletes the file(s) from the media.

**Edit:** Selects Edit options.

- **Rename:** Edits the file name. (page 39)
- **Move:** Moves the file(s) to another folder or media. (page 39)
- **Copy:** Copies the file(s) to another folder or media. (page 39)

**Prog. Add:** Adds the track(s) to Program List. (page 41)

## Erasing MP3 file(s) or folder(s) from the HDD or Memory Card

1. Select an MP3 file you wish to erase on the Music menu.

### Tip

Use the MARKER button to select multiple tracks.

2. Press ENTER.  
The menu options appear on the left side of the menu.
3. Select 'Delete' option then press ENTER.  
The selected file(s) is deleted from HDD or Memory Card.



## Moving MP3 files

You can move MP3 files to another folder or media. After moving, the files are deleted from the current location.

**1** Use ▲ / ▼ to select an MP3 file or folder on the Music menu.

### Tip Selecting multiple tracks (folders)

1. Press MARKER.  
A check mark appears on the track. Press MARKER again to cancel the marked track or folder. Use the MARKER button again to cancel the marked track or folder.
2. Repeat step 1 to mark additional tracks (folders).

**2** Press ENTER.  
The options appear on the left side of the menu.

**3** Use ▲ / ▼ to select the "Move" option then press ENTER.  
Move menu will appear.



**4** Use ▲ / ▼ to select a media then press ►.  
Move option is highlighted.

### Tip

- You can select a album (folder) to move.
1. After selecting a media then press ENTER.  
The album (folder) list appears.
  2. Select a folder.  
You can create new album (folder). Select 'New Album' option on the Move menu then press ENTER.  
"NONAME##" folder is created.

**5** When 'Move' option is highlighted, press ENTER to begin moving.

## Copying MP3 files to another media

**1** Follow steps 1-2 as shown left (Moving MP3 files).

**2** Use ▲ / ▼ to highlight 'Copy' option then press ENTER.  
Copy menu will appear.



**3** Use ▲ / ▼ to select a media then press ►.  
Copy option is highlighted.

### Tip

- You can select a album (folder) to copy.
1. After selecting a media then press ENTER.  
The album (folder) list appears.
  2. Select a folder.  
You can create new album (folder). Select 'New Album' option on the Move menu then press ENTER.  
"NONAME##" folder is created.

**4** When 'Copy' option is highlighted, press ENTER to begin copying.

## Naming an MP3 File

You can name MP3 files independently. Names can be up to 32 characters long.

**1** Choose the file you want to name on the Music menu, then press ENTER.  
The menu options appear on the left side of the menu.

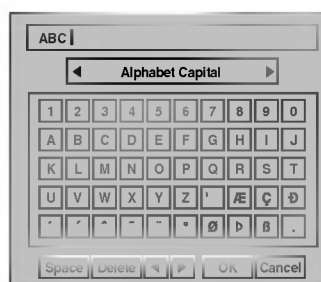

**2** Use ▲/▼ to select 'Rename' option then press ENTER.  
Keyboard menu appears.





**3** Enter a name for the file. Use ◀/▶/▲/▼ to select a character then press ENTER to confirm your selection. Refer step 3 as shown on page 21 (Station Rename).

**4** Choose OK then press ENTER to fix the name and returns to the previous menu screen.

## Pause

- 1 Press PAUSE/STEP () during playback.
- 2 To return to playback, press  (PLAY) or press PAUSE/STEP () again.

## Moving to Another Track

- Press SKIP  or  briefly during playback to go to the next track or to return to the beginning of the current track.
- Press SKIP  twice briefly to step back to the previous track.
- On an Audio CD, to go directly to any track, enter the track number using the numbered buttons (0-9) during playback.

## Repeat

### Audio CDs - Repeat Track/All/Off

Press REPEAT to select a desired repeat mode.

- TRACK: repeats the current track.
- ALL: repeats the all tracks on the disc.
- OFF: does not play repeatedly.

### MP3 - Repeat Track/Folder/Off

Press REPEAT to select a desired repeat mode.

- TRACK: repeats the current track.
- FOLDER: repeats the all tracks in the current folder.
- OFF: does not play repeatedly.

## Random

- 1 Press RANDOM during playback or in stop mode. The unit automatically begins Random Playback and "RANDOM" appears on the menu screen.
- 2 To return to normal playback, press RANDOM repeatedly until "RANDOM" disappears from the menu screen.



By pressing SKIP  during Random playback, the unit selects another track and resumes Random playback.

## 3D Surround











This unit can produce a 3D Surround effect, which simulates multi-channel audio playback from two conventional stereo speakers, instead of the five or more speakers normally required to listen to multi-channel audio from a home theater system.

- 1 Press 3D SURR. during playback to select "3D SUR".
- 2 To turn off the 3D Surround effect, press 3D SURR. until "3D SUR" disappears from the menu screen.

## Changing the Audio Channel

Press AUDIO repeatedly to hear a different audio channel (stereo, left or right).

## Search

- 1 Press SCAN ( or ) during playback. The recorder will now go into SEARCH mode.
- 2 Press SCAN ( or ) to select the required speed: X2, X4, X8 (backward) or X2, X4, X8 (forward). Search speed and direction are indicated on the menu screen.
- 3 To exit SEARCH mode, press  (PLAY).

## Repeat A-B

To repeat a sequence in a track:

- 1 Press A-B at your chosen start point. Repeat icon and 'A' appears on the menu screen.
- 2 Press A-B again at your chosen end point. The Repeat icon and 'A - B' appears on the menu screen, and the repeat sequence begins.
- 3 To exit the sequence and return to normal play, press A-B again. The Repeat icon disappears from the menu screen.



Program Playback enables you to make custom playlists of Audio CD or MP3 tracks. Programs can contain up to 99 Audio CD tracks or 256 MP3 tracks.

**1** Use ▲ / ▼ to select a track (or folder) on the Audio CD or Music menu.

**T** **Selecting multiple tracks (folders)**

1. Press MARKER.  
A check mark appears on the track. Press MARKER again to cancel the marked track or folder. Use the MARKER button again to cancel the marked track or folder.
2. Repeat step 1 to mark additional tracks (folders).

**2** Press ENTER.  
The options appear on the left side of the menu.

**3** Use ▲ / ▼ to select the “Prog. Add” option then press ENTER.

**4** Repeat steps 1-3 to mark additional tracks.

**Note**

If you select a folder for Programmed Playback, all tracks in the folder are added to the Program List.



**5** Use ► to move to the Program list.  
The programmed track you selected last is highlighted on the program list.

**6** Use ▲ / ▼ to select the track you want to start playing.

**7** Press ► (PLAY) to start.  
Playback stops after playing the last programmed track in the program list.

**8** To exit Program Playback and resume normal playback, select a track on the List and press ► (PLAY).

**T** **ip**

You can access or remove the Program List screen by pressing MENU/LIST.

**Program List menu options**

1. To display menu options, select a track on the Program List menu then press ENTER.  
The menu options appear on the left side of the menu.
2. Use ▲ / ▼ to select an option then press ENTER to confirm your selection.

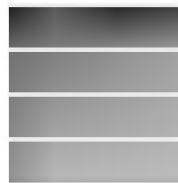

**Play:** Playback begins in the order in which you programmed the tracks from the selected track.

**Delete:** Deletes the track(s) from the Program List menu.

**Move:** Moves the track(s) to change the program order.

**Save:** Memorizes the program list. (HDD only)

**Repeat Programmed Tracks**

Press REPEAT to select the desired Repeat mode.

- TRACK: Repeats the current track.
- ALL: Repeats all tracks on the Program List.
- OFF: Cancels Repeat mode (no display).

**Erasing a Track from the Program List**

1. Select the track you wish to erase from the Program List.

**T** **ip**

Use the MARKER button to select multiple tracks.

2. Press ENTER.  
The menu options appear on the left side of the menu.
3. Select ‘Delete’ option then press ENTER.  
The selected track is deleted from the Program List.

**Changing Track Order in the Program List**

- 1 Select the track you wish to move on the Program List then press ENTER.  
The menu options appear on the left side of the menu.
- 2 Select ‘Move’ option then press ENTER.  
A yellow bar appears in the Program List.
- 3 Use ▲ / ▼ to move the yellow bar to the desired location, then press ENTER.  
The selected track is moved.

**T** **ip**

Use MARKER to move multiple tracks.

**Save Your Program List**

This recorder memorizes the user program list that you have programmed.

- 1 Select a track on the Program List then press ENTER.  
The menu options appear on the left side of the menu.
- 2 Select ‘Save’ option then press ENTER.  
The Program List is saved in the HDD’s program folder.

## Viewing a JPEG File

The recorder can play JPEG files on the CD-R, CD-RW, HDD, or Memory Card. Before playing JPEG recordings, read "Notes on JPEG Recordings" on page 8.

- 1** Press **HOME**.  
The HOME menu appears.
- 2** Select a media that contains JPEG file then press **ENTER**.
- 3** Select '**PHOTO**' option then press **ENTER**.  
The Photo menu appears on the TV screen.



- 4** Use **◀ / ▶ / ▲ / ▼** to select a folder, then press **ENTER**.  
The menu options appear on the left side of the menu.
- 5** Select '**Open**' option then press **ENTER**.  
A list of files in the selected folder appears.



- 6** Use **◀ / ▶ / ▲ / ▼** to select a file, then press **ENTER**.  
The menu options appear on the left side of the menu.

### tips

- If you want to move to the upper directory, use the **▲ / ▼** to highlight **⋮** and press **ENTER**.
- You can also display HOME menu to select another media by pressing **RETURN** (↵).

- 7** Use **▲ / ▼** to select "Full Screen" then press **ENTER**.

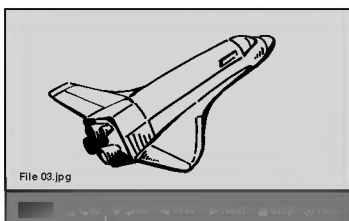

Press **ENTER** to appear or disappear this menu.

- 8** To stop viewing at any time, press **STOP**.  
The Photo menu appears.

### tips

You can create new folder. Select 'New Album' option on the Photo-HDD or Photo-Memory Card menu then press **ENTER**. "NONAME##" folder is created.

## Photo menu options



**Full Screen:** Shows the selected file as full screen.

**Delete:** Deletes the selected file from the media. (HDD, Memory Card only)

**Slide Show:** Displays Slide Show menu.

**Edit:** Selects Edit options.

- **Rename:** Edits the file name. (page 43) (HDD, Memory Card only)
- **Move:** Moves the file(s) to another folder (album) or media. (page 44) (HDD, Memory Card only)
- **Copy:** Copies the file(s) to another folder or media. (page 44)

## Skip Images

While viewing a picture, press **SKIP** (**I◀◀** or **▶▶I**) once to advance to the next file or return to the previous file.

## Rotate Images

Use **▲ / ▼** while viewing a picture to flip the picture clockwise or counterclockwise.

## Erasing JPEG file(s) or folder(s) from the HDD or Memory Card

1. Select an JPEG file you wish to erase on the Photo menu.

### tips

- Use the **MARKER** button to select multiple tracks.
2. Press **ENTER**.  
The menu options appear on the left side of the menu.
3. Select 'Delete' option then press **ENTER**.  
The selected file(s) is deleted from HDD or Memory Card.

## View Slide Shows

1. Select Slide Show option on the Photo menu options.
2. Press ENTER.  
The Slide Show menu appears.

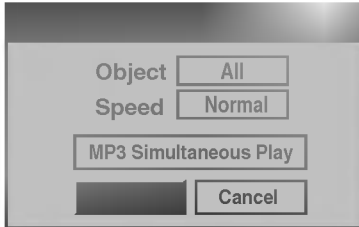

3. Use ◀/▶/▲/▼ to set the options.  
Object:
  - Selected: Views slide show only selected files.  
Use the MARKER button to select multiple files.
  - All: Views slide show all files.Speed:  
Sets the Slide Show speed to Slow, Normal, Fast.
4. Select the "Start" option then press ENTER to start the Slide Show.
5. Press STOP to stop the Slide Show and returns to the Photo menu.

### To Pause the Slide Show

- 1 Press PAUSE/STEP (||) to pause slide show.
- 2 When you want to continue slide show, press ▶ (PLAY).

## To listen to music while slide show simultaneously

You can display photo files while listening to MP3 music files recorded on HDD.

1. Follow steps 1-3 as shown above (View Slide Shows).
2. Select "MP3 Simultaneous Play" option on the Slide Show menu, then press ENTER.  
The menu appears as below.



3. Press MARKER to select multiple tracks.
  - Select "Select All" option to select all tracks then press ENTER.
  - Select "Deselect All" option to deselect all selected tracks then press ENTER.
  - Select "Cancel" option to exit this menu then press ENTER.

4. Use ◀/▶/▲/▼ to highlight 'Start' option then press ENTER.
5. Press STOP to stop the Slide Show and return to the Photo menu.

## Naming a JPEG File

You can name JPEG files on the HDD or Memory Card independently. Names can be up to 32 characters long.

### 1 Choose the file you want to name on the Photo menu, then press ENTER.

The menu options appears on the left side of the menu.

### 2 Use ▲/▼ to select 'Rename' option then press ENTER.

Keyboard menu appears.

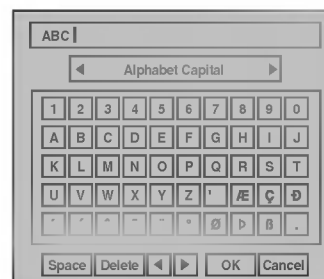

### 3 Enter a name for the file. Use ◀/▶/▲/▼ to select a character then press ENTER to confirm your selection. Refer step 3 as shown on page 21 (Station Rename).

### 4 Choose OK then press ENTER to fix the name and returns to the previous menu screen.

## Moving JPEG files

You can move photo files to another folder or media. After moving, the files are deleted from the current location.

- 1 Press HOME.**  
The HOME menu appears.
- 2 Select a media that contains JPEG file then press ENTER.**
- 3 Select 'PHOTO' option then press ENTER.**  
The Photo menu appears on the TV screen.



- 4 Use ▲ / ▼ to select an JPEG files or albums on the menu then press MARKER.**  
A check mark appears on the JPEG file or album.

### Notes

- Use the MARKER button again to cancel the marked track or folder.
- Press and hold ▼ to move quickly to the next track or folder.
- Press and hold ▲ to move quickly to the previous track or folder.

- 5 Repeat step 4 to mark additional files or folders.**

- 6 Press ENTER.**  
The options appear on the left side of the menu.

- 7 Select 'Move' option on the options.**  
Move menu will appear.

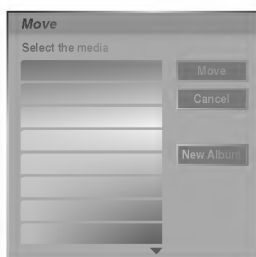

- 8 Use ▲ / ▼ to select a media then press ► .**  
Move option is highlighted.

### Tip

You can select a album (folder) to move.

1. After selecting a media then press ENTER.  
The album list appears.
2. Select a folder.  
You can create new album. Select 'New Album' option on the Move menu then press ENTER.  
"NONAME##" folder is created.

- 9 When 'Move' option is highlighted, press ENTER to begin moving.**

## Copying JPEG files

You can copy photo files to another folder or media.

- 1 Follow steps 1-6 as shown left (Moving JPEG files).**
- 2 Select 'Copy' option on the options.**  
Copy menu will appear.

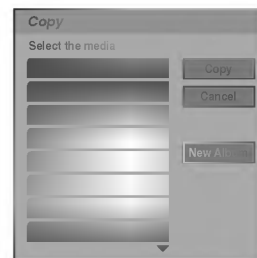

- 3 Use ▲ / ▼ to select a media then press ► .**  
Copy option is highlighted.

### Tip

You can select a album (folder) to copy.

1. After selecting a media then press ENTER.  
The album list appears.
2. Select a folder.  
You can create new album. Select 'New Album' option on the Copy menu then press ENTER.  
"NONAME##" folder is created.

- 4 When 'Copy' option is highlighted, press ENTER to begin copying.**



## About DVD recording

### Notes

- This recorder cannot make recordings on CD-R or CD-RW discs.
- Our company takes no responsibility for recording failure due to power cuts, defective discs, or damage to the recorder.
- Fingerprints and small scratches on a disc can affect playback and/or recording performance. Please take proper care of your discs.

### Disc types and recording formats, modes, and settings

This recorder can play three different kinds of DVD disc: pre-recorded DVD-Video discs, DVD-RW and DVD-R discs. The disc format for DVD-R discs is always “Video format”—the same as pre-recorded DVD-Video discs. This means that once finalized, you can play a DVD-R in a regular DVD player.

By default, the DVD-RW disc format is Video Recording format, though you can change this to Video format, if required. (Reinitializing the disc will erase the contents of the disc.)

The recording mode is closely related to the disc format. If the disc format is Video Recording format, then the recording mode is VR mode; if the disc format is Video mode, then the recording mode is Video mode (except for DVD-Video, which is not recordable, and so does not have a recording mode).

Within the recording modes (which are fixed for the whole disc) are the record settings. These can be changed as required for each recording and determine the picture quality and how much space the recording will take up on the disc.

## About HDD recording

Recording to the internal hard disk drive (HDD) is basically similar to recording to a VR mode DVD-RW disc. You have the full choice of recording quality options, including the manual mode, and of course you can record, erase and re-record as many times as you like. The capacity of the hard disk drive means that you can store many hours of video on it, even in the higher quality recording modes. To help you organize the contents, the HDD is divided into ten groups. You can name and use these groups as you like—for example, you might have a group for movies, another for TV shows, and one for camcorder recordings.

### Note

The maximum number of titles that can be recorded on the HDD is 255.

## Notes for recording

- The recording times shown are not exact because the recorder uses variable bit-rate video compression. This means that the exact recording time will depend on the material being recorded.
- When recording a TV broadcast, if the reception is poor or the picture contains interference, the recording times may be shorter.
- If you record still pictures or audio only, the recording time may be longer.
- The displayed times for recording and time remaining may not always add up to exactly the length of the disc.
- The recording time available may decrease if you heavily edit a disc.
- If using a DVD-RW disc, make sure you change the recording format (Video mode or VR mode) before you record anything on the disc. See page 28 (Disc Format) for how to do this.
- When using a DVD-R disc, you can keep recording until the disc is full, or until you finalize the disc. Before you start a recording session, check the amount of recording time left on the disc.
- When using a DVD-RW disc in Video mode, recording time available will only increase if you erase the last title recorded on the disc.
- The Erase Title option in the Title List-Original menu only hides the title, it does not actually erase the title from the disc and increase the recording time available (except for the last recorded title on a DVD-RW disc in Video mode).

## Recording TV audio channels

This recorder can record either NICAM or regular audio. If the NICAM setting (page 21) is set to Auto, then if the broadcast is NICAM, you can record the NICAM audio. If the broadcast is non-NICAM, the regular audio is always recorded.

## Recording time and picture quality

There are four preset recording quality modes:

- **HQ** – Highest quality setting, gives about 1 hour of recording time on a DVD disc.
- **SQ** – Default quality, sufficient for most applications, gives about 2 hours of recording time on a DVD.
- **LQ** – Slightly lower video quality, but doubles the recording time on a DVD to around 4 hours.

### Restrictions on video recording

- You cannot record copy-protected video using this recorder. Copy-protected video includes DVD-Video discs and some satellite broadcasts. If copy-protected material is encountered during a recording, recording will pause or stop automatically and an error message will be displayed on-screen.
- Video that is 'copy-once only' can only be recorded using a DVD-RW disc in VR mode with CPRM (see below).
- NTSC format signals from the analog or the DV inputs is not recorded correctly with this recorder.
- Video signals in SECAM format (from the built-in TV tuner or from the analog inputs) are recorded in PAL format.
- VR mode DVD discs in NTSC format is not available for this recorder.

### What is 'CPRM'?

CPRM is a copy protection system (with scramble system) only allowing the recording of 'copy once' broadcast programs. CPRM stands for Content Protection for Recordable Media.

This recorder is CPRM compatible, which means that you can record copy-once broadcast programs, but you cannot then make a copy of those recordings. CPRM recordings can only be made on DVD-RW discs formatted in VR mode, and CPRM recordings can only be played on players that are specifically compatible with CPRM.

### Copyright

- Recording equipment should be used only for lawful copying and you are advised to check carefully what is lawful copying in the country in which you are making a copy. Copying of copyright material such as films or music is unlawful unless permitted by a legal exception or consented to by the rights owner.
- This product incorporates copyright protection technology that is protected by method claims of certain U.S. patents and other intellectual property rights owned by Macrovision Corporation and other rights owners. Use of this copyright protection technology must be authorized by Macrovision Corporation, and is intended for home and other limited viewing uses only unless otherwise authorized by Macrovision corporation. Reverse engineering or disassembly is prohibited.

- CONSUMERS SHOULD NOTE THAT NOT ALL HIGH DEFINITION TELEVISION SETS ARE FULLY COMPATIBLE WITH THIS PRODUCT AND MAY CAUSE ARTIFACTS TO BE DISPLAYED IN THE PICTURE. IN CASE OF 625 PROGRESSIVE SCAN PICTURE PROBLEMS, IT IS RECOMMENDED THAT THE USER SWITCH THE CONNECTION TO THE 'STANDARD DEFINITION' OUTPUT. IF THERE ARE QUESTIONS REGARDING OUR TV SET COMPATIBILITY WITH THIS MODEL 625p DVD & HDD RECORDER, PLEASE CONTACT OUR CUSTOMER SERVICE CENTER.

## Additional Information for Recording

### Clean-up Recording

You can simply clean-up (erase) all contents on the disc then start recording from the first section of the disc. The disc format is not changed.

**1** Load a recordable disc.

**2** Press and hold REC (●) button for more than 3 seconds.

The message will appear on the TV screen.

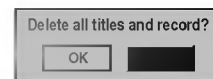

**3** Use ◀ / ▶ to select "OK" then press ENTER. Recording will start. (The REC indicator lights in the display window.)

### Playing Your Recordings on Other DVD Players (Finalizing a Disc)

Most regular DVD players can play finalized discs recorded in Video mode. A small number of players can also play DVD-RW discs recorded in VR mode, finalized or not. Check the manual that came with the other player to check what kinds of discs it will play.

Finalizing 'fixes' the recordings in place so that the disc can be played on a regular DVD player or computer equipped with a suitable DVD-ROM drive.

Finalizing a Video mode disc creates a menu screen for navigating the disc. This is accessed by pressing MENU/LIST or TITLE.

**To finalize a disc, refer to "Finalize" on page 29.**



## Introduction

Do not miss a scene from a live broadcast. If the telephone rings while you are watching your favorite live broadcast, just press "TIMESHIFT" and "PAUSE" before answering the phone. The timeshift function will be activated and the broadcast is then recorded for later viewing.

After the phone call or viewing interruption, press "PLAY" or "SCAN" to watch the program.

Press "STOP" to return to the live broadcast.

## Timeshift (Pause, Live TV/Playback)

### Operation

You can store a program in the HDD storage cache temporarily.

Press **TIMESHIFT** while watching a TV program. The Progress Bar display appears on the screen as shown below. The Progress Bar changes to timeshift icon after 5 seconds.

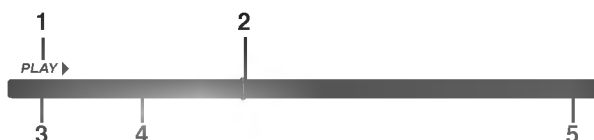

1. Indicates playback mode.
2. Indicates current Timeshift position.
3. Indicates Timeshift start time.
4. Indicates Timeshift elapsed time.
5. Indicates the time that is one hour from Timeshift start time.

### Tips

- You can use trick play functions (Slow, Scan, etc.) during timeshift. Refer to Playback Operation on pages 34-37.
- You can edit the cached clip during Timeshift to retain the program on the HDD. Refer to Clip Record on the right.

### Note

If the timeshift operation is elapsed for more than 6 hours, the oldest timeshift section of the cache will be incrementally deleted.

## Clip Record

You can edit during Timeshift to store the program on the HDD (Hard Disk Drive).

### 1 During Timeshift, use pause step, search and slow-motion to find the starting point.

● CLIPREC ▶

### 2 Press RECORD at the starting point of the section you want to record.

Progress of the edit is indicated in red on the Progress Bar.

### 3 Use pause step, search and slow-motion to find the ending point.

### 4 Press RECORD at the ending point of the section you want to record.

Normal playback continues.

### 5 Repeat steps 1 and 4 to make several Clip Records of a program.

### 6 Press STOP to stop Timeshift.

Confirm message will appear.

### 7 Use ◀ / ▶ to select 'OK' then press ENTER. Or, press STOP again.

The current broadcast is displayed on the screen.

### Notes

- Selected sections are recorded on the HDD.
- If you want to stop Clip recording, press the STOP button. If you press POWER to stop Clip recording, the program may not be recorded on the HDD.
- Clip records cannot be made for sections lasting less than 5 seconds.

## Jump to Start during Timeshift

1. Press ENTER during timeshift. The menu will appear.
2. Press ◀ and playback starts from the very beginning of the timeshift.

## Jump to End during Timeshift

1. Press ENTER during timeshift. The menu will appear.
2. Press ▶ and jumps to the very end of the timeshift then goes to pause mode.

## To Exit the Timeshift

1. Press STOP to exit Timeshift function. Confirm message will appear.
2. Use ◀ / ▶ to select 'OK' then press ENTER. The current broadcast is displayed on the screen.

## Basic Recording from a TV

Follow the instructions below to record a TV program. Recording starts immediately and continues until the disc is full or you stop the recording.

### Note

You must load a recordable disc for DVD recording.

- 1 Press HOME.**  
The HOME menu appears.
- 2 Select a media (HDD or DISC) to record TV program then press ENTER.**
- 3 Select 'TV (HDD)' or 'TV (DVD)' option then press ENTER.**  
Also make sure that the TV input is set to this recorder.  
If you load a completely blank disc, the recorder takes a short while to initialize the disc.
- 4 Set a recording mode as necessary by pressing REC MODE repeatedly. (HQ, SQ, LQ)**
- 5 Use ▲ / ▼ buttons to select the TV channel to record.**

### Changing TV Audio Channel

You can select the audio channel (language) to listen by pressing AUDIO during viewing TV program. The current audio channel is displayed on-screen.

Stereo or mono broadcast: Stereo → Left → Right → Mono

Bilingual broadcast: Main+Sub → Main → Sub → Mono

- When DVD recording in Video mode and if the broadcast is bilingual, set audio channel from the Video Rec Audio in sub-menu of the Setup menu (see page 28).
- If the sound is of poor quality when set to Stereo, you can often improve it by changing to Mono (Left or Right).
- This recorder can record either NICAM or regular audio. If the NICAM setting (page 21) is set to Auto, then if the broadcast is NICAM, the audio automatically changes to NICAM and you can record the NICAM audio. If the broadcast is non-NICAM, the regular audio is always recorded.  
If NICAM sound distortion occurs, due to poor reception, you can switch off NICAM setting of the program.

- 6 Press REC (●) once.**  
Recording will start. (The REC indicator lights in the display window.)
  - Recording continues until you press STOP (■) or the disc or HDD is full.
  - To record for a fixed length of time, see Instant Timer Recording on right.

- 7 Press STOP (■) to stop recording.**

## To Pause the Recording

- 1 Press PAUSE/STEP (||) to pause recording.
- 2 When you want to continue recording, press PAUSE/STEP (||).

## To record one TV program while watching another

- 1 Press TV/DVD to select the TV mode during recording. The TV indicator appears.
- 2 Using the TV, select the channel to be viewed.

## Instant Timer Recording

Instant Timer Recording allows you to make a recording easily of a preset length without using the program timer.

- 1 Follow steps 1-4 as shown left (Basic Recording from a TV).**
- 2 Press REC (●) repeatedly to select the recording time length.**  
Recording starts after the first press. Each subsequent press increases the recording time within free space (maximum 240 minutes).  
The recording time is displayed on the TV screen.  
At the end of the recording, the recorder will stop recording and shut off.

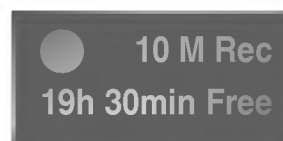

Instant Timer Record Menu

## Checking the Recording Time

Press REC (●) once to check the recording time. The recalled setting will automatically return to the TV screen for a moment.

Also, remaining time of recording is shown in the display window.

## To Extend the Recording Time

The recording time can be extended anytime by pressing REC (●).

Each subsequent press increases the recording time within free space (maximum 240 minutes).

### Caution

If the recorder is unplugged (or there is a power failure) while the recorder is recording, the recording will be lost.

This recorder can be programmed to record up to 7 programs within a period of 1 month. For unattended recording, the timer needs to know the channels to be recorded, the starting time and length.

- 1 Press TIMER REC.**  
The Timer Record menu will appear.

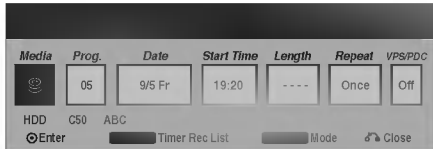

- **Media** – Choose a media to record (HDD or DVD).
- **Prog.** – Choose a memorized program number, or one of the external inputs from which to record.
- **Date** – Choose a date up to 1 month in advance.
- **Start Time** – Set the recording start time.
- **Length** – Set the recording length.
- **Repeat** – Choose a desired repeat (Once, Daily (Monday - Friday), or Weekly).
- **VPS/PDC** – The VPS/PDC system automatically adjusts the recording time so that even if a program is not running to schedule, you won't miss it. For VPS/PDC to work properly, you must input the correct announced time and date of the program you want to record.  
Note that VPS/PDC may not work with every station.

#### **N**otes

- Stations that use VPS/PDC typically include VPS/PDC information in the teletext TV guide pages. Please refer to these pages when setting a timer recording.
- This recorder takes approximately 1 - 2 minutes to start recording. This means that when using VPS/PDC, there may be instances where the beginning of the program is not recorded.

- 2 Enter the necessary information for your timer recording(s).**

- ◀ / ▶ (left/right) – move the cursor left/right
- ▲ / ▼ (up/down) – change the setting at the current cursor position
- Press RETURN (↵) to exit the Timer Record menu.
- Press ENTER after filling in all the program information.
- Press TIMER REC to display Timer Record List.

- 3 Set a recording mode as necessary by pressing REC MODE repeatedly. (HQ, SQ, LQ)**

- 4 Press ENTER, the program will be memorized by the recorder.**

To check the programming, the Timer Record List will appear.

Check field's "Rec. OK" on the Timer Record List indicates that the timer recording is programmed correctly.

- 5 Press RETURN (↵) to exit the Program List.**

- 6 Make sure that you load a recordable disc for DVD recording and press POWER to switch your unit to Standby.**

#### **N**otes

- The timer indicator lights in the display window when the recorder is in standby with the timer active.
- When DVD recording in Video mode and if the broadcast is bilingual, set audio channel from the Video Rec Audio in sub-menu of the Setup menu (see page 28).
- You must press POWER to stop the timer recording.
- If you set a timer recording to record to DVD but there isn't a recordable DVD loaded at the time of the recording, the Recovery Recording feature will automatically record the program to the HDD for you.

## Checking Timer Recording Details

Programming can be checked whenever the recorder is turned on. Press TIMER REC twice.

- Use ▲ / ▼ to select a timer recording.
- Press **ENTER** to edit the selected program. Timer Record menu appears.
- Press **CLEAR** to delete the selected program from the Timer Record List.

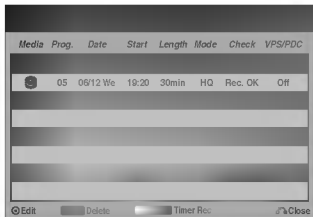

## Canceling a Timer Recording

You can clear a timer setting anytime before the recording actually starts.

- Use ▲ / ▼ to select a program you want to erase on the Timer Recorder List. If you want to erase the program, press **CLEAR**.

## Stopping a Timer Recording in Progress

After a timer recording has started, you can still cancel the program.

- Press **POWER**.

## Timer Recording Troubleshooting

**Even though the timer is set, the recorder will not record when:**

- There is no disc loaded and there is not free space on the HDD.
- A non-recordable disc is loaded and there is not free space on the HDD.
- Disc Protect is set to On in the Setup menu and there is not free space on the HDD. (see page 29).
- Power is turned on.
- There are already 99 titles recorded on the disc and there are already 255 titles recorded on the HDD.

**You cannot enter a timer program when:**

- A recording is already underway.
- The time you're trying to set has already passed.
- There are already 7 timer programs set.

**If two or more timer programs overlap:**

- The earlier program takes priority.
- When the earlier program finishes, the later program starts.
- If two programs are set to start at exactly the same time, the program entered first takes priority.

If the disc is damaged, the recording may not complete successfully. In this case even though the Check field shows "Rec. OK", it may not be.



## Recording from External Components

You can record from an external component, such as a camcorder or VCR, connected to any of the recorder's external inputs.

- 1 Make sure that the component you want to record from is connected properly to the recorder. See page 18.**
- 2 Choose a media (HDD or DVD) to record using HOME menu. (see page 30).**
- 3 Press AV repeatedly to select the external input to record from.**
  - Tuner: Built-in tuner
  - AV1: EURO AV1 AUDIO VIDEO mounted on back panel
  - AV2: EURO AV2 DECODER mounted on back panel
  - AV3: AUDIO IN 3 / VIDEO IN 3 mounted on back panel
  - AV4: INPUT 4 (VIDEO, AUDIO (L/R), S-VIDEO IN) mounted on front panel
  - DV: DV IN mounted on front panel

- 4 Select the recording mode as necessary by pressing REC MODE repeatedly. (HQ, SQ, LQ)**  
HQ; High Quality, SQ; Standard Quality, LQ: Low Quality

- 5 Press REC (●) once.**  
Recording will start. (The REC indicator lights in the display window.)
  - Recording continues until you press STOP (■) or the disc is full.
  - To record for a fixed length of time, see Instant Timer Recording on page 48.

- 6 Press STOP (■) to stop recording.**

### Note

If your source is copy-protected using CopyGuard, you will not be able to record it using this recorder. See Copyright on page 46 for more details.

## Recording from a Digital Camcorder

You can record from a digital camcorder connected to the DV IN jack on the front panel of this recorder. Using the recorder's remote, you can control both the camcorder and this recorder.

Before recording, make sure that the audio input for the DV IN jack is set up (see page 28).

### Tips

- The source signal must be DVC-SD format.
- Some camcorders cannot be controlled using this recorder's remote.
- If you connect a second recorder using a DV cable, you cannot control the second DVD from this one.
- You can't control this unit remotely from a component connected to the DV IN jack.
- You can't record date and time information from a DV cassette.

- 1 Make sure your digital camcorder is connected to the front panel DV IN jack. See page 18.**

- 2 Choose a media (HDD or DVD) to record using HOME menu. (see page 30).**

- 3 Check that the DV audio input is as you require.**  
You can choose between Audio 1 (original audio) and Audio 2 (overdubbed audio).
  - DV Input is set from the DV Rec Audio in sub-menu of the Setup menu. See DV Rec Audio on page 28 for more information.

- 4 Press AV repeatedly to select the DV input.**  
DV appears in the display window and on the TV screen.

- 5 Find the place on the camcorder tape that you want to the recording to start from.**  
For best results, pause playback at the point from which you want to record.

- Depending on your camcorder, you can use this recorder's remote to control the camcorder using the STOP, PLAY and PAUSE functions.

- 6 Press REC (●) once to start recording.**

- Recording is automatically stopped if the recorder detects no signal.
- You can pause or stop the recording by pressing PAUSE/STEP (||) or STOP (■). You cannot control the camcorder from this remote control during recording.
- In Video mode, the final frame of the recording may remain displayed on screen for a while after recording stops.
- For timer recording to work properly on this recorder, the digital camcorder must also be switched on and in operating.

## What is DV?

Using DV, also known as i.LINK, you can connect a DV-equipped camcorder to this recorder using a single DV cable for input and output of audio, video, data and control signals.

The i.LINK interface is also known as IEEE 1394-1995. "i.LINK" and the "i.LINK" logo are trademarks.

- This recorder is only compatible with DV-format (DVC-SD) camcorders. Digital satellite tuners and Digital VHS video recorders are not compatible.
- You cannot connect more than one DV camcorder at a time to this recorder.
- You cannot control this recorder from external equipment connected via the DV IN jack (including two recorders).
- It may not always be possible to control the connected camcorder via the DV IN jack.
- Digital camcorders can usually record audio as stereo 16-bit/48kHz, or twin stereo tracks of 12-bit/32kHz. This recorder can only record one stereo audio track. Set DV Rec Audio to Audio 1 or Audio 2 as required (see page 28).
- Audio input to the DV IN jack should be 32 or 48kHz (not 44.1kHz).
- Picture disturbance on the recording may occur if the source component pauses playback or plays an unrecorded section of tape, or if the power fails in the source component, or the DV cable becomes disconnected.
- Although DV Rec Audio is set to Audio 2 and Audio 2 signal is not present, DV Rec Audio will be reset to Audio 1 automatically.

## DV-Related Messages

You may see the following messages appear on your TV screen when using the DV IN jack.

### **Not connected to camcorder**

The camcorder is not connected properly, or the camcorder is switched off.

### **Too many devices connected**

The DV jack on this recorder supports connection to just one camcorder.

### **Check the tape**

There is no cassette loaded into the connected equipment.

### **Uncontrollable device**

This recorder cannot control the camcorder.

### **Updating Information**

Camcorder is updating information for DV.

### **Camera mode**

Camcorder is set to camera mode.

## Troubleshooting

If you can't get a picture and/or audio through the DV IN jack, check the bullet points:

- Make sure the DV cable is properly connected.
- Try switching off the connected equipment then switch back on.
- Try switching the audio input.

### **ote**

Depending on the connected camcorder, you may not be able to control it using the remote control supplied with this recorder.

Using the Title List menu you can edit video content on unfinalized VR mode DVD discs, as well as video content on the internal hard disk drive (HDD). The editing features available in the Title List menu depend on whether you are editing video on a VR mode DVD, or the HDD, and whether you're editing Original content, or a Playlist.

With unfinalized Video mode DVDs, there are a limited number of editing commands, including naming and erasing titles. Once a Video mode disc has been finalized, further editing is not possible. You can still use the Title List menu to select titles for playback.

There are two ways to edit VR mode DVD-RW discs. You can directly edit the Original content of the disc, or you can create and edit a Playlist. The Playlist doesn't actually change any of the content on the disc, but just controls how the content is played back.

Editing material recorded on the HDD is similar to editing the Original content of a VR mode DVD-RW, with similar commands for erasing and naming titles, as well as fine control over the content of chapters within titles for DVD disc.

**Note**

During recording, if you display the Title List menu for the HDD, some of the titles may appear with a mark. These titles were recorded with a Line Input setting different to the current setting of the recorder. During recording, these titles cannot be played.

**1 Choose a media (HDD or DVD) to edit using HOME menu. (see page 30).**

**2 Press MENU/LIST to display the Title List menu.** Playback should be stopped when you do this.

- You can also access it using HOME menu, select TITLE LIST then press ENTER.
- When selecting titles, use the ▲ / ▼ buttons to display the previous/next page if there are more than six titles.
- If you are editing a VR mode disc, press MENU/LIST to switch between Original and Playlist menu.

On the left side of the screen are the Title List menu options. The main part of the screen shows thumbnails of the titles (or chapter) on the disc or HDD. You can change these thumbnails using the THUMB-NAIL button—see Changing Title Thumbnails on page 55.

Press DISPLAY to display the information of selected title on the Title List menu.

After selecting a title or chapter on the Title List of Chapter List menu, then press ENTER. The menu options on the left side of the menu. Use ▲ / ▼ to select a option then press ENTER to confirm your selection. (Details for menu options -see page 54)

**3 To exit the Title List menu, press RETURN (↵) repeatedly.**

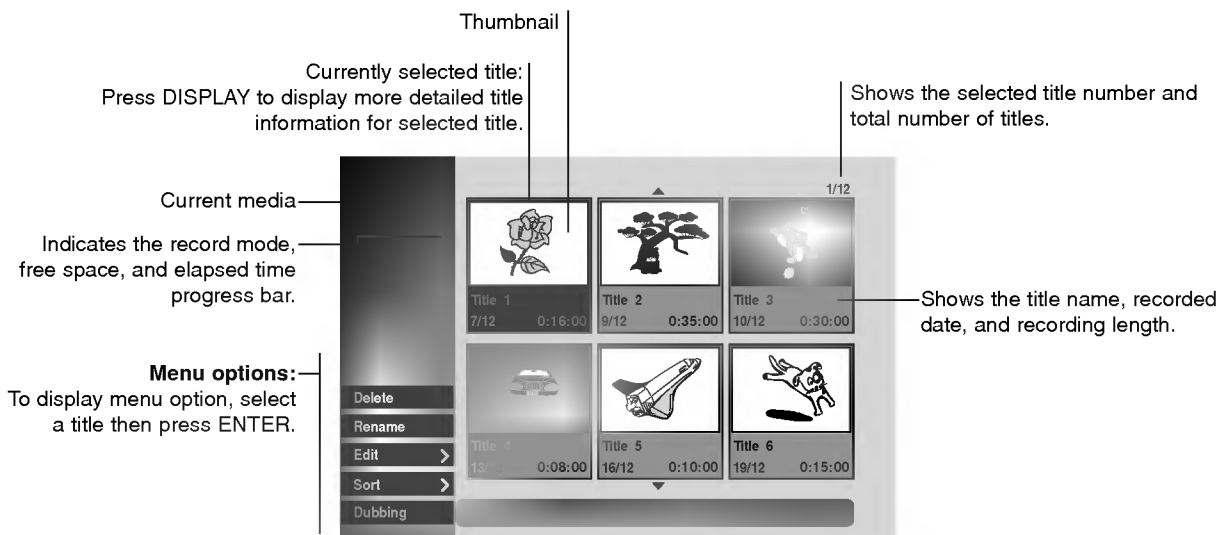

## Title List-HDD menu options

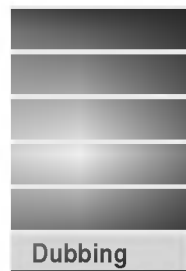

**Play:** Start playback of the selected title.

**Delete:** Deletes the title. (page 57)

**Rename:** Edits the title name. (page 58)

**Edit:** Selects Edit options.

- **Combine:** Combines two titles into one (page 59).
- **Divide:** Divides a title into two (page 59).
- **Delete Parts:** Deletes a part of the Title (page 57).

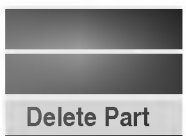

**Sort:** Lists the programs on the Title List menu by Date, Title, or Category. (page 58)

- **Date:** Lists the programs by recorded date.
- **Title:** Lists the programs by title name.
- **Category:** Lists the programs by category.

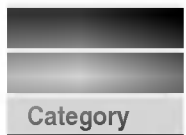

**Dubbing:** Copies the title to another media. (page 62)

## Title List-Original menu options

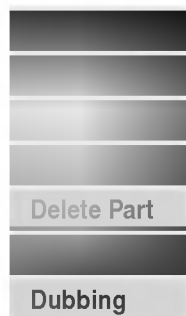

**Play:** Start playback the selected title.

**Chapter:** Displays Chapter List-Original menu of the title.

**Rename:** Edits the title name. (page 58)

**Delete:** Deletes the title. (page 57)

**Delete Parts:** Deletes a part of the Title. (page 57)

**Playlist:** Adds the title to the Playlist. (page 56)

**Dubbing:** Copies the title to another media. (page 62)

## Chapter List-Original menu options

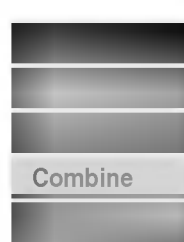

**Play:** Starts playback of the selected chapter.

**Title:** Displays Title List-Original menu of the chapter.

**Delete:** Deletes the chapter. (page 57)

**Combine:** Combines two chapters into one. (page 60)

**Playlist:** Adds the chapter to the Playlist. (page 56)

## Title List-Playlist menu options

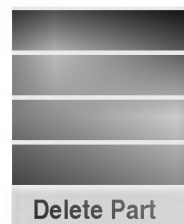

**Play:** Start playback the selected title.

**Chapter:** Displays Chapter List-Playlist menu of the title.

**Rename:** Edits the title name. (page 58)

**Delete:** Deletes the title from the Title List-Playlist menu. (page 57)

**Delete Part:** Deletes a part of the Title. (page 57)

## Chapter List-Playlist menu options

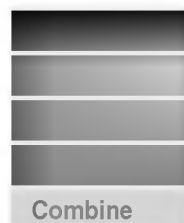

**Play:** Starts playback of the selected chapter.

**Title:** Displays Title List-Playlist menu of the chapter.

**Delete:** Deletes the chapter from the Chapter List-Playlist menu. (page 57)

**Move:** Moves a chapter on the Chapter List-Playlist menu to a position on the menu. (page 60)

**Combine:** Combines two chapters into one. (page 60)

## Titles, Chapters and Parts

Titles in the disc's original content contain one or more chapters. When you insert a disc's title into the Playlist, all the chapters within that title also appear. In other words, chapters in the Playlist behave exactly as chapters on a DVD-Video disc do. Parts are sections of Original or Playlist titles. From the Original and Playlist menu you can add or delete parts. Adding a chapter or title to the Playlist creates a new title made up of a section (ie., chapter) of an Original title. Deleting a part removes part of a title from the Original or Playlist menu.

### Caution

- When editing using the Delete, Add and Move functions, the start and end frames may not be exactly as set in the start and end point display.
- During Playlist playback, you may notice a momentary pause between edits. This is not a malfunction.

## Adding Chapter Markers



You can put a chapter marker anywhere in a Playlist or Original title during recording or playback.

Once the chapter is marked, you can use the Chapter Search feature, as well as delete, combine and move chapters in the Chapter List-Original or Chapter List-Playlist menu.

You can insert up to 999 chapter markers in both the Original and Playlist contents.

### Note

In Video mode, chapter markers are inserted at regular intervals automatically. You can change this interval from the Initial Setup menu (see Auto Chapter on page 28).

### **1** Play the title (Original or Playlist).

### **2** At the point you want to start a new chapter, press **CHP ADD**.

A chapter marker icon appears on the TV screen.

- You can also put chapter markers in during recording.

## Changing Title Thumbnails



Each title and chapter displayed in the Original or Playlist menu is represented by a thumbnail picture taken from the start of that title or chapter.

If you prefer, select a different still picture from within a title.

### **1** Play the title (Original or Playlist).

### **2** Press **THUMBNAIL** to make the currently displayed picture the one that appears in the Title List menu.

The still picture that you choose appears in both the Original or Playlist menu.

### Tip

You can also change the thumbnail picture of the title on the Chapter List-Original or Chapter List-Playlist menu. Select a chapter on the Chapter List-Original or Chapter List-Playlist menu then press **THUMBNAIL**. The thumbnail picture of the title that includes the chapter is changed.

## Making a New Playlist

Use this function to add an Original title or chapter to the Playlist. When you do this, the whole title is put into the Playlist (you can delete bits you don't need later — see Deleting an Original or Playlist title/chapter on page 57).

The title appears in the Playlist complete with the chapter markers that appear in the Original. However, if you add more chapter markers to the Original later, these are not automatically copied over into the Playlist title.

You can add up to 999 chapters to one disc. If you only want to add a chapter of a title, use the Adding a title/chapter to the Playlist on this page.

### 1 Choose a title or chapter on the Title List-Original menu or Chapter List-Original menu to put into the Playlist, then press ENTER.

The menu options appears on the left side of the menu.

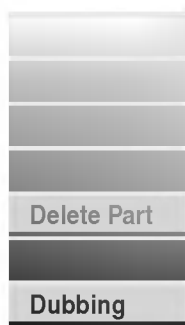

Title List-Original

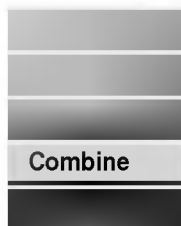

Chapter List-Original

### 2 Use ▲ / ▼ to select 'Playlist' from the menu options then press ENTER.

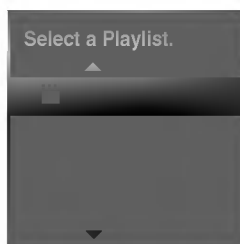

### 3 Select 'New Playlist' then press ENTER.

The new title appears in the updated Playlist. All chapters of the title are added to the Playlist.

## Adding Additional Title/Chapters to the Playlist

You can add an Original title or chapter to add to a Playlist title even if it is already registered.

### 1 Choose a title or chapter on the Title List-Original menu or Chapter List-Original menu to put into the Playlist, then press ENTER.

The menu options appears on the left side of the screen.

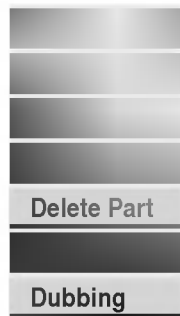

Title List-Original

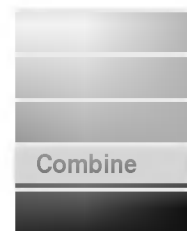

Chapter List-Original

### 2 Use ▲ / ▼ to select 'Playlist' from menu options then press ENTER.

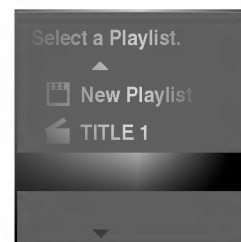

### 3 Choose a Title List-Playlist that is already registered to insert a title or chapter, then press ENTER.

The title or chapter appears in the updated Playlist menu.

### 4 Repeat steps 1-3 to add additional title or chapter on the Playlist.

### 5 Press RETURN (↵) to exit, or MENU/LIST to go back to the Title List-Original menu.

## Deleting an Original or Playlist

### Title/Chapter

When you erase a title or chapter from the Playlist menu, you only remove it from the Playlist; the title/chapter remains in the Original menu.

If you choose to delete a title or chapter from the Original (title/chapter) menu, the title or chapter is actually deleted from the disc and the remaining time available for recording increases. Titles/chapters deleted from the Original are also removed from the Playlist.

#### Note

It may not be possible to delete chapters that are less than 5 seconds long.

**1** Use ◀ / ▶ / ▲ / ▼ to choose a chapter or title you want to delete on the Title List or Chapter List menu then press ENTER.

The menu options appears on the left side of the screen.

**2** Select 'Delete' option from the options on the menu.

e.g., If you select "Delete" option on the Title List-HDD menu.

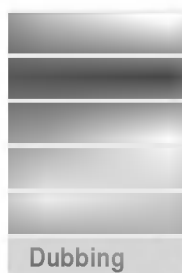

**3** Press ENTER to confirm.  
The confirm message for deleting will appear.

**4** Use ◀ / ▶ to select 'OK' then press ENTER.  
The selected chapter or title is deleted.  
After pressing ENTER, the new, updated menu is displayed.

**5** Repeat steps 1 - 4 to continue to delete from the menu.

**6** Press RETURN (↵) repeatedly to exit the menu.

## Deleting a Part

You can delete a part which you do not want in the title.

**1** Use ◀ / ▶ / ▲ / ▼ to choose a title you want to delete on the Title List menu then press ENTER.  
The options appears on the left side of the menu.

**2** Select 'Delete Part' from the options on the menu.

**3** Press ENTER.  
Title Edit (Delete Part) menu appears on the TV screen.  
'Start Point' icon is highlighted.

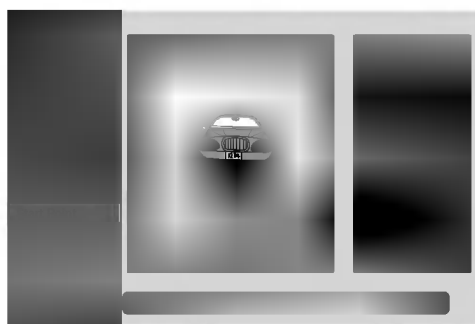

**4** Starts playback and use pause step, search and slow-motion to find the starting point.

**5** Press ENTER at the starting point of the section you want to delete.  
'End Point' icon is highlighted.  
The part is indicated on the Progress Bar.

**6** Use pause step, search and slow-motion to find the ending point.

**7** Press ENTER at the ending point of the section you want to delete.  
You can cancel the selected point, use ▲ / ▼ to select 'Cancel' icon then press ENTER.

#### Tip

With HDD recordings, you can delete additional part. Select 'Next Part' icon on the menu then press ENTER, then repeat steps 4-7.

**8** If you finish to edit, select 'Done' icon then press ENTER.  
The selected part is deleted from the title and Title List menu appears.  
When recording in VR mode, the confirm message for deleting will appear. Use ◀ / ▶ to select 'OK' then press ENTER.

#### Note

It may not be possible to delete parts that are less than 3 seconds long.

## Naming a Title

You can name Original and Playlist titles independently. Names can be up to 32 characters long.

**1** Choose the title you want to name on the Title List menu, then press ENTER.

The menu options appears on the left side of the menu.

**2** Use ▲/▼ to select 'Rename' option then press ENTER.

Keyboard menu appears.

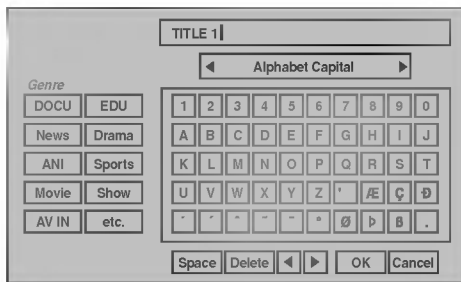

**3** Enter a name for the title. Use ◀/▶/▲/▼ to select a character then press ENTER to confirm your selection. Refer step 3 as shown on page 21 (Station Rename).



You can add the genre only for HDD title name.

**4** Choose OK then press ENTER to fix the name and return to the previous menu screen.

**5** Press RETURN (↵) repeatedly to exit the menu.

### Notes

- Names can be up to 32 characters long.
- For discs formatted on a different recorder, you will see only a limited character set.

## Sort

This function allows you to access show listings organized by Date, Title, or Category on the Title List-HDD menu. So you can find title you want to watch easily.

**1** Choose any title on the Title List-HDD menu, then press ENTER.

The menu options appears on the left side of the menu.

**2** Use ▲/▼ to select 'Sort' option then press ENTER.

Sort options appears.

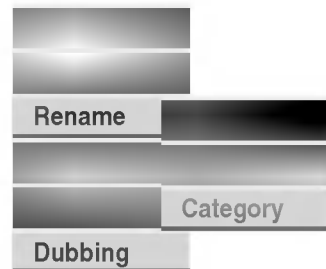

**3** Use ▲/▼ to select 'Date', 'Title' or 'Category' option then press ENTER.

After pressing ENTER, the sorted menu is displayed.



## Combining Two Titles Into One

Use this function to combine two adjacent Original-HDD titles into one.

### Note

This function is not available if there is only one title within the HDD.

- 1 On the Title List-HDD menu, select the first title of the two titles you want to combine then press ENTER.

The menu options appears on the left side of the screen.

- 2 Select 'Combine' from the menu options.

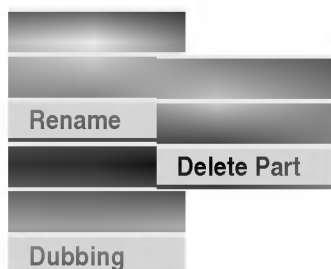

- 3 Select the second title of the two titles you want to combine then press ENTER.

Confirm message appears.

- 4 Use ◀ / ▶ to select 'OK' then press ENTER. After pressing ENTER, the updated menu is displayed.

## Divide One Titles Into Two

Use this command to split a title up into two new titles.

- 1 On the Title List-HDD menu, select a title you want to divide then press ENTER.

The menu options appears on the left side of the screen.

- 2 Select 'Divide' from the Title List-HDD menu options.

Title Edit-Divide menu appears and playback starts. 'Divide' option is highlighted on the left side of the screen.

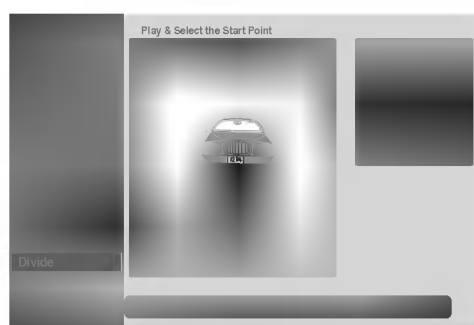

- 3 Use pause step, search and slow-motion to find the starting point you want to divide the title.

- 4 When 'Divide' option is highlighted, press ENTER at the point.

You can clear the dividing point and exit the Title Edit-Divide menu, use ▲ / ▼ to select 'Cancel' option then press ENTER. The dividing point is clear.

- 5 Choose 'Done' option then press ENTER to fix the dividing point.

The title is divided into two new titles.

## Combining Two Chapters Into One



Use this function to combine two adjacent Playlist or Original chapters into one.

### Note

This function is not available if there is only one chapter within the title.

- 1** On the Chapter List menu, select the second chapter of the two chapters you want to combine then press ENTER on the Chapter List-Original or Chapter List-Playlist menu.

The menu options appears on the left side of the screen.

- 2** Use ▲ / ▼ to select 'Combine'.

The combine indicator appears between the two chapters you want to combine.

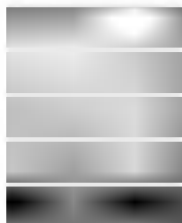

- 3** Press ENTER to confirm.  
Confirm message appears.

- 4** Use ◀ / ▶ to select 'OK' then press ENTER.  
After pressing ENTER, the updated menu is displayed.

## Moving a Playlist Chapter

Use this function to re-arrange the playing order of Playlist chapters on the Title List-Playlist menu.

### Note

This function is not available if there is only one chapter.

- 1** Select a chapter on the Chapter List-Playlist menu.

- 2** Press ENTER.  
The menu options appears on the left side of the menu.

- 3** Use ▲ / ▼ to select 'Move' option from Playlist options then press ENTER.

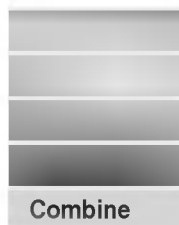

- 4** Use ◀ / ▶ / ▲ / ▼ to choose the place you want to move the chapter to then press ENTER.  
Confirm message appears.

- 5** Use ◀ / ▶ to select 'OK' then press ENTER.  
After pressing ENTER, the updated menu is displayed.

## Introduction

Use the copying features of this recorder to:

- Back up important recordings stored on the HDD to a DVD.
- Make a DVD copy of a recording on the HDD to play in another player.
- Transfer video from a DVD to the HDD for editing.
- Transfer edited video from the HDD to DVD.

The simplest method of copying is to use the One Touch Copy feature. Using this you can very simply copy the title that's currently playing from HDD to DVD, or the other way around.

## Restrictions on copying

Some video material is copy-once protected. This means that it can be recorded to HDD, but it can't then be freely copied again. If you want to transfer copy-once protected material from HDD to DVD, you'll need to use a VR mode DVD-RW disc compatible with CPRM Ver. 1.1 (see CPRM on page 46 for more on this), and the following restrictions apply:

After copying a copy-once protected title to DVD it is automatically erased from the HDD. It is not therefore possible to copy a locked title that is copy-once protected.

You can identify copy-once protected material during playback by displaying disc information on-screen.

- A media in NTSC format can not be copied.

## Copyright

Recording equipment should be used only for lawful copying and you are advised to check carefully what is lawful copying in the country in which you are making a copy. Copying of copyright material such as films or music is unlawful unless permitted by a legal exception or consented to by the right owners.

## High-speed copying

Copying between DVD and HDD is a completely digital process and therefore involves no loss of quality in the audio or video. This means that you can transfer back and forth without having to worry about the quality getting worse with each copy 'generation'. It also means that copying can be carried out at the maximum speed possible.

When copying from HDD to DVD, the speed of copying depends on the recording mode and the kind of DVD disc you're using.

## One Touch Copy (HDD to DVD)

The One Touch Copy feature copies the currently playing title from the HDD to DVD. The whole title is copied, regardless of where in the title you start copying. The recorder copies at the maximum speed possible.

For One Touch Copy to work, make sure that a recordable DVD-R/RW disc is loaded.

### **During HDD playback, press DUBBING to copy the current title to DVD.**

The on-screen display indicates that the title is being copied. Playback continues while copying.

- Title name, chapter markers, as well as thumbnail picture markers for the Title List menu, are also copied. However, if you copy to a Video mode DVD-R/RW, only the first 32 characters of a name are copied.
- The chapter markers in the copy may not be in exactly the same positions as the original when recording on to a Video mode disc.
- You can't use the One Touch Copy function to copy a title if any part of the title is copy-once protected.
- A title that contains mixed aspect ratios can't be copied to a Video mode disc. Use a VR mode DVD-RW disc for this type of material.
- Low resolution (LQ) widescreen material can't be copied to a Video mode disc. Use a VR mode DVD-RW disc for this type of material.

## One Touch Copy (DVD to HDD)

One Touch Copy from DVD to HDD copies a single title to the HDD in real time. When you start copying, playback jumps back to the start of the title, then continues through to the end of the title, when recording automatically stops. The copy will be made in the recording mode (HQ, SQ, LQ) that is currently set.

### **During DVD playback, press DUBBING to copy the current title to HDD.**

Playback starts again from the beginning of the current title. The on-screen display indicates that the title is being copied.

### **Notes**

- The maximum title length for copying is 6 hours.
- The copying stops when the recorder detects a badly scratched or copy protected part.
- Title name and chapter markers are also copied, except when copying from a finalized Video mode disc.
- Thumbnail picture markers and chapter markers for the Title List menu are copied, but their position in the copy may be slightly changed from the original.
- If some part of the title being copied is copy-protected, copying will start, but the copy-protected portions will not be copied.

### **Tip**

To stop dubbing at any other time, press STOP (■).

## Dubbing from HDD to DVD

- 1** On the Title List-HDD menu, select a title you want to dub then press **ENTER**.  
The menu options appears on the left side of the screen.

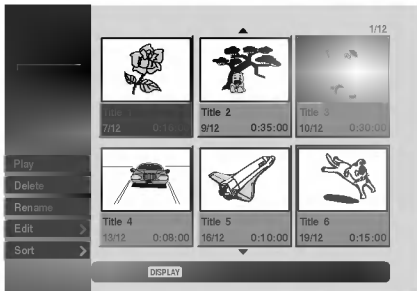

- 2** Use **▲ / ▼** to select 'Dubbing' from the options. Dubbing menu appears.

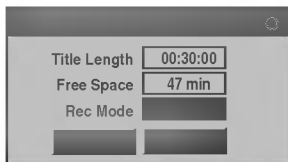

- 3** Use **◀ / ▶** to select Rec.Mode (HQ, SQ, LQ, Fast), then press **▼**.  
'Start' icon is highlighted.  
Fast: Only available when copying Original content to a VR mode disc. (See page 61 for more information on high-speed copying.)
- 4** When 'Start' icon is highlighted, press **ENTER**.  
Dubbing starts.
- 5** To stop dubbing at any other time, press **STOP (■)**.

## Dubbing from DVD to HDD

- 1** On the Title List-Original menu, select a title you want to dub then press **ENTER**.  
Menu options appears on the left side of the screen.

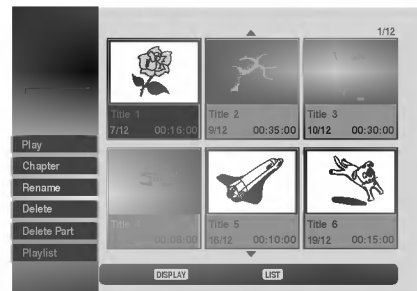

- 2** Use **▲ / ▼** to select 'Dubbing' from the options. Dubbing menu appears.

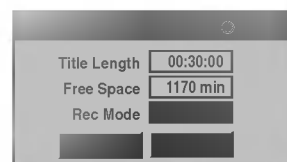

- 3** Use **◀ / ▶** to select Rec.Mode (HQ, SQ, LQ, Fast), then press **▼**.  
'Start' icon is highlighted.  
Fast: Only available when copying Original content to a VR mode disc. (See page 61 for more information on high-speed copying.)
- 4** When 'Start' icon is highlighted, press **ENTER**.  
Dubbing starts.
- 5** To stop dubbing at any other time, press **STOP (■)**.

### Note

Depending on the conditions of the recording equipment or the disc itself, the dubbing may not be capable.



## Using the Title List

From the Title List display you can play, name and delete titles.

Once a Video mode disc is finalized, the Title List screen changes its appearance and all you can do is select titles to play.

### 1 Press MENU/LIST to display the Title List.



### 2 Use ▲ / ▼ to choose a title then press ENTER.

Title List options appears on the left side of the Title List display.

### 3 Use ▲ / ▼ to select an option then press ENTER to confirm.

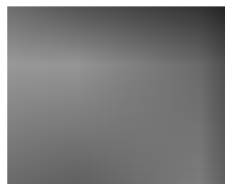

**Play:** Start playback the selected title.

**Rename:** Edits the title name. (page 58)

**Delete:** Deletes the title from the Title List.

**Dubbing:** Copies the title to another media. (page 62)

### 4 Press RETURN (↵) repeatedly to exit Title List.

## Deleting a Title

Before a disc is finalized, you can delete titles recorded on the disc.

### ⚠ Caution

- If you delete a title from a DVD-R disc, the title will disappear from the Title List, but the available recording time will not increase.
- When deleting a title from a DVD-RW disc, the remaining time available for recording will only increase if it is the last title on the disc.

### 1 Press MENU/LIST to display Title List

### 2 Use ◀ / ▶ / ▲ / ▼ to choose a title you want to delete then press ENTER.

Title List options appears on the left side of the Title List menu.

### 3 Use ▲ / ▼ to select 'Delete' then press ENTER to confirm.

After pressing ENTER, the new, updated title list is displayed.

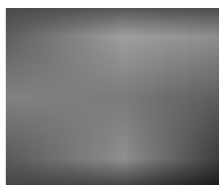

### 4 Repeat steps 2-3 to delete additional titles from the Title List.

### 5 Press RETURN (↵) repeatedly to remove the Title List display.

## If the disc has already been finalized

You should see a screen like the one below.

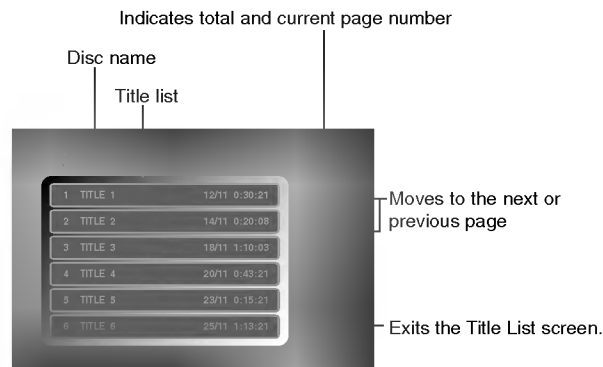

- Also you can exit the Title List display using TITLE or MENU/LIST.

Enter the appropriate code number for the initial settings “Disc Audio”, “Disc Subtitle” and/or “Disc Menu” (See page 24).

<b>Code</b>	<b>Language</b>	<b>Code</b>	<b>Language</b>	<b>Code</b>	<b>Language</b>	<b>Code</b>	<b>Language</b>
6566	Abkhazian	7074	Fiji	7678	Lingala	8373	Singhalese
6565	Afar	7073	Finnish	7684	Lithuanian	8375	Slovak
6570	Afrikaans	7082	French	7775	Macedonian	8376	Slovenian
8381	Albanian	7089	Frisian	7771	Malagasy	8379	Somali
6577	Amharic	7176	Galician	7783	Malay	6983	Spanish
6582	Arabic	7565	Georgian	7776	Malayalam	8385	Sudanese
7289	Armenian	6869	German	7784	Maltese	8387	Swahili
6583	Assamese	6976	Greek	7773	Maori	8386	Swedish
6589	Aymara	7576	Greenlandic	7782	Marathi	8476	Tagalog
6590	Azerbaijani	7178	Guarani	7779	Moldavian	8471	Tajik
6665	Bashkir	7185	Gujarati	7778	Mongolian	8465	Tamil
6985	Basque	7265	Hausa	7865	Nauru	8484	Tatar
6678	Bengali; Bangla	7387	Hebrew	7869	Nepali	8469	Telugu
6890	Bhutani	7273	Hindi	7879	Norwegian	8472	Thai
6672	Bihari	7285	Hungarian	7982	Oriya	6679	Tibetan
6682	Breton	7383	Icelandic	8065	Panjabi	8473	Tigrinya
6671	Bulgarian	7378	Indonesian	8083	Pashto, Pushto	8479	Tonga
7789	Burmese	7365	Interlingua	7065	Persian	8482	Turkish
6669	Byelorussian	7165	Irish	8076	Polish	8475	Turkmen
7577	Cambodian	7384	Italian	8084	Portuguese	8487	Twi
6765	Catalan	7465	Japanese	8185	Quechua	8575	Ukrainian
9072	Chinese	7487	Javanese	8277	Rhaeto-Romance	8582	Urdu
6779	Corsican	7578	Kannada	8279	Romanian	8590	Uzbek
7282	Croatian	7583	Kashmiri	8285	Russian	8673	Vietnamese
6783	Czech	7575	Kazakh	8377	Samoan	8679	Volapük
6865	Danish	7589	Kirghiz	8365	Sanskrit	6789	Welsh
7876	Dutch	7579	Korean	7168	Scots Gaelic	8779	Wolof
6978	English	7585	Kurdish	8382	Serbian	8872	Xhosa
6979	Esperanto	7679	Laothian	8372	Serbo-Croatian	7473	Yiddish
6984	Estonian	7665	Latin	8378	Shona	8979	Yoruba
7079	Faeroese	7686	Latvian, Lettish	8368	Sindhi	9085	Zulu



Enter the appropriate code number for the initial setting "Country Code" (See page 27).

Code	Country	Code	Country	Code	Country	Code	Country
AD	Andorra	ER	Eritrea	LC	Saint Lucia	SC	Seychelles
AE	United Arab Emirates	ES	Spain	LI	Liechtenstein	SD	Sudan
AF	Afghanistan	ET	Ethiopia	LK	Sri Lanka	SE	Sweden
AG	Antigua and Barbuda	FI	Finland	LR	Liberia	SG	Singapore
AI	Anguilla	FJ	Fiji	LS	Lesotho	SH	Saint Helena
AL	Albania	FK	Falkland Islands	LT	Lithuania	SI	Slovenia
AM	Armenia	FM	Micronesia	LU	Luxembourg	SJ	Svalbard and Jan Mayen Islands
AN	Netherlands Antilles	FO	Faroe Islands	LV	Latvia	SK	Slovak Republic
AO	Angola	FR	France	LY	Libya	SL	Sierra Leone
AQ	Antarctica	FX	France (European Territory)	MA	Morocco	SM	San Marino
AR	Argentina	GA	Gabon	MC	Monaco	SN	Senegal
AS	American Samoa	GB	Great Britain	MD	Moldavia	SO	Somalia
AT	Austria	GD	Grenada	MG	Madagascar	SR	Suriname
AU	Australia	GE	Georgia	MH	Marshall Islands	ST	Saint Tome and Principe
AW	Aruba	GF	French Guyana	MK	Macedonia	SU	Former USSR
AZ	Azerbaijan	GH	Ghana	ML	Mali	SV	El Salvador
BA	Bosnia-Herzegovina	GI	Gibraltar	MM	Myanmar	SY	Syria
BB	Barbados	GL	Greenland	MN	Mongolia	SZ	Swaziland
BD	Bangladesh	GM	Gambia	MO	Macau	TC	Turks and Caicos Islands
BE	Belgium	GN	Guinea	MP	Northern Mariana Islands	TD	Chad
BF	Burkina Faso	GP	Guadeloupe (French)	MQ	Martinique (French)	TF	French Southern Territories
BG	Bulgaria	GQ	Equatorial Guinea	MR	Mauritania	TG	Togo
BH	Bahrain	GR	Greece	MS	Montserrat	TH	Thailand
BI	Burundi	GS	S. Georgia & S. Sandwich Isls.	MT	Malta	TJ	Tadjikistan
BJ	Benin	GT	Guatemala	MU	Mauritius	TK	Tokelau
BM	Bermuda	GU	Guam (USA)	MV	Maldives	TM	Turkmenistan
BN	Brunei Darussalam	GW	Guinea Bissau	MX	Mexico	TN	Tunisia
BO	Bolivia	GY	Guyana	MY	Malaysia	TO	Tonga
BR	Brazil	HK	Hong Kong	MZ	Mozambique	TP	East Timor
BS	Bahamas	HM	Heard and McDonald Islands	NA	Namibia	TR	Turkey
BT	Bhutan	HN	Honduras	NC	New Caledonia (French)	TT	Trinidad and Tobago
BV	Bouvet Island	HR	Croatia	NE	Niger	TV	Tuvalu
BW	Botswana	HT	Haiti	NF	Norfolk Island	TW	Taiwan
BY	Belarus	HU	Hungary	NG	Nigeria	TZ	Tanzania
BZ	Belize	ID	Indonesia	NI	Nicaragua	UA	Ukraine
CA	Canada	IE	Ireland	NL	Netherlands	UG	Uganda
CC	Cocos (Keeling) Islands	IL	Israel	NO	Norway	UK	United Kingdom
CF	Central African Republic	IN	India	NP	Nepal	UM	USA Minor Outlying Islands
CG	Congo	IO	British Indian Ocean Territory	NR	Nauru	US	United States
CH	Switzerland	IQ	Iraq	NU	Niue	UY	Uruguay
CI	Ivory Coast	IR	Iran	NZ	New Zealand	UZ	Uzbekistan
CK	Cook Islands	IS	Iceland	OM	Oman	VA	Vatican City State
CL	Chile	IT	Italy	PA	Panama	VC	Saint Vincent & Grenadines
CM	Cameroon	JM	Jamaica	PE	Peru	VE	Venezuela
CN	China	JO	Jordan	PF	Polynesia (French)	VG	Virgin Islands (British)
CO	Colombia	JP	Japan	PG	Papua New Guinea	VI	Virgin Islands (USA)
CR	Costa Rica	KE	Kenya	PH	Philippines	VN	Vietnam
CS	Former Czechoslovakia	KG	Kyrgyzstan	PK	Pakistan	VU	Vanuatu
CU	Cuba	KH	Cambodia	PL	Poland	WF	Wallis and Futuna Islands
CV	Cape Verde	KI	Kiribati	PM	Saint Pierre and Miquelon	WS	Samoa
CX	Christmas Island	KM	Comoros	PN	Pitcairn Island	YE	Yemen
CY	Cyprus	KN	Saint Kitts & Nevis Anguilla	PR	Puerto Rico	YT	Mayotte
CZ	Czech Republic	KP	North Korea	PT	Portugal	YU	Yugoslavia
DE	Germany	KR	South Korea	PW	Palau	ZA	South Africa
DJ	Djibouti	KW	Kuwait	PY	Paraguay	ZM	Zambia
DK	Denmark	KY	Cayman Islands	QA	Qatar	ZR	Zaire
DM	Dominica	KZ	Kazakhstan	RE	Reunion (French)	ZW	Zimbabwe
DO	Dominican Republic	LA	Laos	RO	Romania		
DZ	Algeria	LB	Lebanon	RU	Russian Federation		
EC	Ecuador			RW	Rwanda		
EE	Estonia			SA	Saudi Arabia		
EG	Egypt			SB	Solomon Islands		
EH	Western Sahara						

You can control the sound level, input source, and power switch of your LG TV with the supplied remote.

You can control your TV using the buttons below.

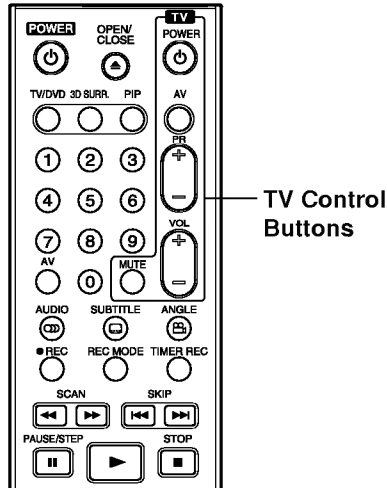

By pressing	You can
POWER	Turn the TV on or off.
AV	Switch the TV's input source between the TV and other input sources.
PR +/-	Scans up or down through memorized channels.
VOL +/-	Adjust the volume of the TV.
MUTE	Temporarily turns TV sound OFF, press again to restore.

## Controlling other TVs with the remote

You can control the sound level, input source, and power switch of non-LG TVs as well. If your TV is listed in the table below, set the appropriate manufacturer code.

1. While holding down TV POWER button, press the number buttons to select the manufacturer code for your TV (see the table below).
2. Release TV POWER button.

## Code numbers of controllable TVs

If more than one code number is listed, try entering them one at a time until you find the one that works with your TV.

Manufacturer	Code Number
LG / GoldStar	1 (Default), 2
Zenith	1, 3, 4
Samsung	6, 7
Sony	8, 9
Hitachi	4

### Notes

- Depending on your TV, some or all buttons may not function on the TV, even after entering the correct manufacturer code.
- If you enter a new code number, the code number previously entered will be erased.
- When you replace the batteries of the remote, the code number you have set may be reset to the default setting. Set the appropriate code number again.

Check the following guide for the possible cause of a problem before contacting service.

Symptom	Cause	Solution
No power.	<ul style="list-style-type: none"> <li>The power cord is disconnected.</li> </ul>	<ul style="list-style-type: none"> <li>Plug the power cord into the wall outlet securely.</li> </ul>
No picture.	<ul style="list-style-type: none"> <li>TV/DVD mode for the recorder is set to TV.</li> </ul>	<ul style="list-style-type: none"> <li>Press TV/DVD on the remote control repeatedly to choose DVD mode. TV indicator disappears in the display window.</li> </ul>
	<ul style="list-style-type: none"> <li>The TV is not set to receive recorder signal output.</li> </ul>	<ul style="list-style-type: none"> <li>Select the appropriate video input mode on the TV so the picture from the recorder appears on the TV screen.</li> </ul>
	<ul style="list-style-type: none"> <li>The video cable is not connected securely.</li> </ul>	<ul style="list-style-type: none"> <li>Connect the video cable securely.</li> </ul>
	<ul style="list-style-type: none"> <li>The connected TV power is turned off.</li> </ul>	<ul style="list-style-type: none"> <li>Turn on the TV.</li> </ul>
No sound.	<ul style="list-style-type: none"> <li>The equipment connected with the audio cable is not set to receive recorder signal output.</li> </ul>	<ul style="list-style-type: none"> <li>Select the correct input mode on the audio receiver so you can listen to the sound from the recorder.</li> </ul>
	<ul style="list-style-type: none"> <li>The audio cables are not connected securely.</li> </ul>	<ul style="list-style-type: none"> <li>Connect the audio cable securely.</li> </ul>
	<ul style="list-style-type: none"> <li>The power of the equipment connected with the audio cable is turned off.</li> </ul>	<ul style="list-style-type: none"> <li>Turn on the equipment connected with the audio cable.</li> </ul>
	<ul style="list-style-type: none"> <li>The audio connecting cord is damaged.</li> </ul>	<ul style="list-style-type: none"> <li>Replace it with new one.</li> </ul>
The playback picture is poor.	<ul style="list-style-type: none"> <li>The disc is dirty.</li> </ul>	<ul style="list-style-type: none"> <li>Clean the disc.</li> </ul>
The recorder does not start playback.	<ul style="list-style-type: none"> <li>No disc is inserted.</li> </ul>	<ul style="list-style-type: none"> <li>Insert a disc. (Check that the disc indicator in the display window is lit.)</li> </ul>
	<ul style="list-style-type: none"> <li>An unplayable disc is inserted.</li> </ul>	<ul style="list-style-type: none"> <li>Insert a playable disc. (Check the disc type, color system, and regional code.)</li> </ul>
	<ul style="list-style-type: none"> <li>The disc is placed upside down.</li> </ul>	<ul style="list-style-type: none"> <li>Place the disc with the playback side down.</li> </ul>
	<ul style="list-style-type: none"> <li>The disc is not placed within the guide.</li> </ul>	<ul style="list-style-type: none"> <li>Place the disc on the disc tray correctly inside the guide.</li> </ul>
	<ul style="list-style-type: none"> <li>The disc is dirty.</li> </ul>	<ul style="list-style-type: none"> <li>Clean the disc.</li> </ul>
	<ul style="list-style-type: none"> <li>The Rating level is set.</li> </ul>	<ul style="list-style-type: none"> <li>Cancel the Rating function or change the rating level.</li> </ul>
The picture from the external input is distorted	<ul style="list-style-type: none"> <li>The video signal from the external component is copy-protected.</li> </ul>	<ul style="list-style-type: none"> <li>You cannot connect via this recorder. Connect the component directly to your TV.</li> </ul>
Some channels are skipped over when using ▲ / ▼.	<ul style="list-style-type: none"> <li>Those channels are not stored in the recorder.</li> </ul>	<ul style="list-style-type: none"> <li>Restore channels. See "Program Edit" on page 20-21.</li> </ul>
The picture or sound of broadcasting channel is weak or missing.	<ul style="list-style-type: none"> <li>Aerial or cables are loose.</li> </ul>	<ul style="list-style-type: none"> <li>Tighten connections or replace cable.</li> </ul>
Camcorder image is not shown.	<ul style="list-style-type: none"> <li>Camcorder is off.</li> </ul>	<ul style="list-style-type: none"> <li>Turn camcorder on and operate properly.</li> </ul>
Camcorder image via A/V input or DV IN to recorder is not shown on TV screen.	<ul style="list-style-type: none"> <li>The recorder INPUT SELECT is incorrect.</li> </ul>	<ul style="list-style-type: none"> <li>Use AV to select input channel (AV1, AV2, DV, etc.)</li> </ul>

Symptom	Cause	Solution
Can't play a disc recorded using this recorder on another player.	• The disc was recorded in Video mode.	• Finalize the disc. (page 29)
	• Some players will not play even a finalized disc recorded in Video mode.	• No solution.
	• The disc was recorded in VR mode,	• The other player must be RW compatible in order to play it.
	• Discs recorded with copy-once material cannot be played on other players.	• No solution.
Cannot record or did not record successfully.	• The remaining blank space on the disc is insufficient.	• Use another disc.
	• The source you are trying to record is copy protected.	• You cannot record the source.
	• When setting the recording channel, the channel is tuned on the TV's own tuner.	• Select the channel on the recorder's built-in TV tuner.
	• When recording to a Video mode disc, programs that are copy-once protected cannot be recorded.	• Use a VR mode formatted disc for copy-once material.
Timer recording is not possible.	• Clock in recorder is not set to correct time.	• Set clock to correct time. See "Auto Clock Set" or "Manual Clock Set" on page 22.
	• Timer has been programmed incorrectly.	• Reprogram Timer. See "Timer Recording" on page 49.
	• Timer record indicator light does not appear after programming timer.	• Reprogram Timer.
Stereo Audio Record and/or Playback is not present.	• TV is not Stereo-compatible.	• No solution.
	• Broadcast program is not in stereo format.	• No solution.
	• The recorder A/V Out jacks are not connected to TV A/V In jacks.	• Make A/V connections. Stereo is available only via A/V output from the recorder.
	• The recorder Audio/Video Out is not selected for viewing at the TV.	• Select AUX or A/V source as TV input.
	• The recorder's TV audio channel is set to mono.	• Set TV audio channel mode to Stereo. See "Changing TV audio channel" on page 48.
The remote control does not work properly.	• The remote control is not pointed at the remote sensor of the recorder.	• Point the remote control at the remote sensor of the recorder.
	• The remote control is too far from the recorder.	• Operate the remote control within 7 m.
	• There is an obstacle in the path of the remote control and the recorder.	• Remove the obstacle.
	• The batteries in the remote control are exhausted.	• Replace the batteries with new ones.

#### Moisture Condensation

Moisture condensation can occur:	In locations where moisture condensation may occur:
<ul style="list-style-type: none"> <li>• When the recorder is moved from a cold place to a warm place.</li> <li>• Under extremely humid conditions.</li> </ul>	<ul style="list-style-type: none"> <li>• Keep the recorder plugged into an AC power outlet with POWER On. This will help prevent condensation.</li> <li>• When condensation has occurred, wait a few hours for the recorder to dry before using it.</li> </ul>

## General

Power requirements	AC 110-240V, 50/60 Hz
Power consumption	40W
Dimensions (approx.)	430 X 69 X 377 mm (w x h x d) without foot
Mass (approx.)	6.4 kg
Operating temperature	5°C to 35°C
Operating humidity	5 % to 90 %
Television system	PAL B/G colour system
Recording format	PAL

## Recording

Recording format	DVD Video Recording, DVD-VIDEO
Recordable media	HDD (80GB), DVD-RW (DVD-Re-recordable), DVD-R (DVD-Recordable)
Recordable time	DVD: Approx. 1 hour (HQ mode), 2 hours (SQ mode), 4 hours (LQ mode) HDD: Approx. 20 hour (HQ mode), 40 hours (SQ mode), 80 hours (LQ mode)
<b>Video recording format</b>	
Sampling frequency	27MHz
Compression format	MPEG 2 (VBR support)
<b>Audio recording format</b>	
Sampling frequency	48kHz
Compression format	Dolby Digital

## Playback

Frequency response	DVD (PCM 48 kHz): 8 Hz to 22 kHz, CD: 8 Hz to 20 kHz DVD (PCM 96 kHz): 8 Hz to 44 kHz
Signal-to-noise ratio	More than 100 dB (AUDIO OUT connector)
Harmonic distortion	Less than 0.008% (AUDIO OUT connector)
Dynamic range	More than 95 dB (AUDIO OUT connector)

## Inputs

AERIAL IN	Aerial input, 75 ohms
VIDEO IN	1.0 Vp-p 75 ohms, sync negative, RCA jack x 2 / SCART x 2
AUDIO IN	0 dBm more than 47 kohms, RCA jack (L, R) x 2 / SCART x 2
DV IN	4 pin (i.LINK/IEEE 1394 standard)

## Outputs

VIDEO OUT	1 Vp-p 75 $\Omega$ , sync negative, RCA jack x 1 / SCART
S-VIDEO OUT	(Y) 1.0 V (p-p), 75 $\Omega$ , negative sync, Mini DIN 4-pin x 1 (C) 0.3 V (p-p) 75 $\Omega$
COMPONENT VIDEO OUT / PROGRESSIVE SCAN	(Y) 1.0 V (p-p), 75 $\Omega$ , negative sync, RCA jack x 1 (Pb)/(Pr) 0.7 V (p-p), 75 $\Omega$ , RCA jack x 2
Audio output (digital audio)	0.5 V (p-p), 75 $\Omega$ , RCA jack x 1
Audio output (optical audio)	3 V (p-p), 75 $\Omega$ , Optical connector x 1
Audio output (analog audio)	2.0 Vrms (1 KHz, 0 dB), 600 $\Omega$ , RCA jack (L, R) x 1 / SCART

## Accessory:

Scart cable . . . . .	1	Video cable . . . . .	1
Audio cable (L, R) . . . . .	1	RF Coaxial Cable . . . . .	1
Remote control . . . . .	1	Batteries . . . . .	2

- Design and specifications are subject to change without notice.
- Manufactured under license from Dolby Laboratories. "Dolby", "Pro Logic" and the double-D symbol are trademarks of Dolby Laboratories.
- DTS and DTS Digital Out are registered trademarks of Digital Theater Systems, Inc.