



# DVD PLAYER/ VIDEO CASSETTE RECORDER

## OWNER'S MANUAL

MODEL : VC8606V



## ENGLISH

Before connecting, operating or adjusting this product,  
please read this instruction booklet carefully and  
completely.

**CAUTION**  
RISK OF ELECTRIC SHOCK  
DO NOT OPEN



**Warning:** To reduce the risk of electric shock, do not remove the cover or back of this product. There are no user-serviceable parts inside. Refer servicing to qualified service personnel.



**Warning:** To reduce the risk of fire or electric shock, do not expose this product to dripping or splashing water, rain, or moisture. Do not place objects filled with water such as vases, on the product.

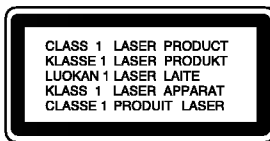

**Warning:** This digital video disc player employs a laser system. Use of controls, adjustments, or the performance of procedures other than those specified herein may result in hazardous radiation exposure.



**Warning:** To prevent direct exposure to laser beam, do not open the enclosure. Visible laser radiation when open.



**Warning:** Never stare directly into the laser beam.



**Caution:** Do not install this product in a confined space such as a book case or similar unit.



This product is manufactured to comply with the radio interference requirements of EEC DIRECTIVE 89/336/EEC, 93/68/EEC and 73/23/EEC.

**Notes on Copyrights:**

It is forbidden by law to copy, broadcast, show, broadcast via cable, play in public, or rent copyrighted material without permission. This product features the copy protection function developed by Macrovision. Copy protection signals are recorded on some discs. When recording and playing the pictures of these discs picture noise will appear. This product incorporates copyright protection technology that is protected by method claims of certain U.S. patents and other intellectual property rights owned by Macrovision Corporation and other rights owners. Use of this copyright protection technology must be authorized by Macrovision Corporation, and is intended for home and other limited viewing uses only unless otherwise authorized by Macrovision Corporation. Reverse engineering or disassembly is prohibited.

CONSUMERS SHOULD NOTE THAT NOT ALL HIGH DEFINITION TELEVISION SETS ARE FULLY COMPATIBLE WITH THIS PRODUCT AND MAY CAUSE ARTIFACTS TO BE DISPLAYED IN THE PICTURE. IN CASE OF 625 PROGRESSIVE SCAN PICTURE PROBLEMS, IT IS RECOMMENDED THAT THE USER SWITCH THE CONNECTION TO THE 'STANDARD DEFINITION' OUTPUT. IF THERE ARE QUESTIONS REGARDING OUR TV SET COMPATIBILITY WITH THIS MODEL 625p DVD PLAYER, PLEASE CONTACT OUR CUSTOMER SERVICE CENTER.

**SERIAL NUMBER:**

You can find the serial number on the back of the unit. This number is unique to this unit and not available to others. You should record requested information here and retain this guide as a permanent record of your purchase.

Model No. \_\_\_\_\_

Serial No. \_\_\_\_\_

Date of Purchase \_\_\_\_\_

**Features:**

- Complete versatility to play DVD, DivX, VCDs, audio CDs or VHS Tapes.
- Watch a DVD while recording a TV show to the VCR.
- Remote controls both DVD and VCR decks.
- Records from DVD to VHS (unless DVD is copy protected with Macrovision).
- Hi-Fi Stereo VCR.

**Important notes on controlling this unit**

This unit uses one set of controls to operate both DVD and VCR. The following buttons are helpful in successfully controlling each part.

1. **POWER Button**  
Press the POWER button on the remote control or front panel to turn on this unit.
2. **DVD Button**  
Press DVD button on the remote control when you want to control the DVD.  
The DVD indicator will light on the front panel display to show that the DVD is selected.
3. **VCR Button**  
Press the VCR button on the remote control when you want to control the VCR.  
The VCR indicator will light on the front panel display to show that the VCR is selected.
4. **DVD/VCR Button**  
Press the DVD/VCR button on the front panel to toggle control between the DVD and the VCR.

## Contents

<b>Introduction</b> .....	<b>4</b>
<b>Symbol Used in this Manual</b> .....	<b>4</b>
<b>About the  Symbol Display</b> .....	<b>4</b>
<b>Notes on Discs</b> .....	<b>4</b>
Handling Discs .....	4
Storing Discs .....	4
Cleaning Discs .....	4
<b>Types of Playable Discs</b> .....	<b>5</b>
<b>Regional code</b> .....	<b>5</b>
<b>Disc-related terms</b> .....	<b>6</b>
<b>Front Panel</b> .....	<b>7</b>
<b>Display Window</b> .....	<b>7</b>
<b>Remote Control</b> .....	<b>8</b>
<b>Rear Panel</b> .....	<b>9</b>
<b>Installation and Setup</b> .....	<b>10</b>
<b>Connecting to a TV &amp; Decoder (or Satellite)</b> ..10	
<b>Connecting to Optional Equipment</b> .....	<b>11</b>
<b>Before Operation-VCR part</b> .....	<b>12-16</b>
Tuning in a video channel on your TV .....	12
Using your VCR for the very first time .....	12
Setting the clock Manually .....	13
To set the colour system .....	13
How to using the main menu .....	14
Tuning in TV Stations Automatically .....	14
Tuning in TV Stations Manually .....	15
Changing the order of TV Stations .....	16
Deleting TV stations .....	16
<b>Before Operation-DVD part</b> .....	<b>17-21</b>
<b>On-Screen Display</b> .....	<b>17</b>
<b>Initial Settings</b> .....	<b>18-21</b>
General Operation .....	18
LANGUAGE .....	18
• Menu Language .....	18
• Disc Audio / Subtitle / Menu .....	18
DISPLAY .....	19
• TV Aspect .....	19
• Display Mode .....	19
• Progressive Scan .....	19
• TV Output Select .....	19
AUDIO .....	20
• Dolby Digital / DTS / MPEG .....	20
• Sample Freq. (Frequency) .....	20
• Dynamic Range Control (DRC) .....	20
• Vocal .....	20
OTHERS .....	21
• PBC .....	21
• Auto Play .....	21
• DivX(R) VOD .....	21
LOCK (Parental Control) .....	22
• Rating .....	22
• Password (Security Code) .....	22
• Country Code .....	22
<b>Operation</b> .....	<b>23</b>
<b>Playing a tape</b> .....	<b>23-25</b>
• CM (Commercial Message) Skip .....	23
• OPR (Optimum Picture Response) .....	23
<b>Instant Timer Recording (ITR)</b> .....	<b>24</b>
<b>Timer recording using On Screen Display</b> .....	<b>25</b>
<b>Playing a DVD or Video CD</b> .....	<b>26-28</b>
<b>General Features</b> .....	<b>26</b>
Moving to another TITLE .....	26
Moving to another CHAPTER/TRACK .....	26
Search .....	26
Changing the Audio Channel .....	26
Still Picture and Frame-by-Frame Playback .....	27
Slow Motion .....	27
Random .....	27
Repeat A-B .....	27
Repeat .....	27
3D Surround .....	27
Time Search .....	27
Zoom .....	28
Marker Search .....	28
<b>Special DVD Features</b> .....	<b>28</b>
Title Menu .....	28
Disc Menu .....	28
Camera Angle .....	28
Changing the Audio Language .....	28
Subtitles .....	28
<b>Playing an Audio CD or MP3/WMA Disc</b> .....	<b>29</b>
<b>Audio CD and MP3 / WMA Disc Features</b> .....	<b>30</b>
Pause .....	30
Moving to another Track .....	30
Repeat Track/All/Off .....	30
Search .....	30
Random .....	30
Repeat A-B .....	30
3D Surround .....	30
<b>Programmed Playback</b> .....	<b>31</b>
Repeat Programmed Tracks .....	31
Erasing a Track from Program List .....	31
Erasing the Complete Program List .....	31
<b>Viewing a JPEG Disc</b> .....	<b>32</b>
Slide Show .....	32
Still Picture .....	32
Moving to another File .....	32
Zoom .....	32
To rotate picture .....	32
To listen to MP3/WMA music watching picture .....	32
<b>Playing a DVD VR format Disc</b> .....	<b>33</b>
<b>Maintenance and Service</b> .....	<b>33</b>
<b>Playing a DivX Movie Disc</b> .....	<b>34</b>
<b>Additional Features-VCR part</b> .....	<b>35-36</b>
On Screen Display .....	35
Tape Counter Memory Stop .....	35
Lock (Child Lock) .....	35
Video Doctor (Self-Diagnosis) .....	35
Hi-Fi Stereo Sound System .....	36
Wide Screen Compatibility 16:9 .....	36
To set the decoder .....	36
<b>Additional Features</b> .....	<b>37</b>
Last Scene Memory .....	37
Screen Saver .....	37
Video Mode Setting .....	37
Controlling other TVs with the remote control .....	37
<b>Copying from DVD To VCR</b> .....	<b>38</b>
<b>Recording from another video recorder</b> .....	<b>38</b>
<b>Reference</b> .....	<b>39</b>
<b>Language Codes</b> .....	<b>39</b>
<b>Country Codes</b> .....	<b>39</b>
<b>Troubleshooting</b> .....	<b>40</b>
<b>Specification</b> .....	<b>41</b>

# Introduction

To ensure proper use of this product, please read this owner's manual carefully and retain for future reference.

This manual provides information on the operation and maintenance of your DVD player. Should the unit require service, contact an authorized service location.

## Symbol Used in this Manual



The lightning flash symbol alerts you to the presence of dangerous voltage within the product enclosure that may constitute a risk of electric shock.



The exclamation point alerts you to the presence of important operating and maintenance / servicing instructions.



Indicates hazards likely to cause harm to the unit itself or other material damage.

### Note:

Indicates special notes and operating features.

### Tip:

Indicates tips and hints for making the task easier.

A section whose title has one of the following symbols is applicable only to the disc represented by the symbol.



DVD and finalized DVD±R/RW



Video CDs



Audio CDs



MP3 Discs



WMA Discs



JPEG Discs



DivX Discs

## About the Symbol Display

" " may appear on your TV display during operation and indicates that the function explained in this owner's manual is not available on that specific DVD video disc.

## Notes on Discs

### Handling Discs

Do not touch the playback side of the disc. Hold the disc by the edges so that fingerprints do not get on the surface. Never stick paper or tape on the disc.



### Storing Discs

After playing, store the disc in its case. Do not expose the disc to direct sunlight or sources of heat and never leave it in a parked car exposed to direct sunlight.

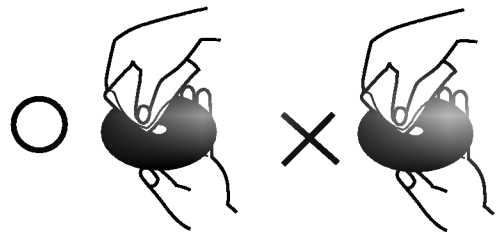

### Cleaning Discs

Fingerprints and dust on the disc can cause poor picture quality and sound distortion. Before playing, clean the disc with a clean cloth. Wipe the disc from the center out.



Do not use strong solvents such as alcohol, benzene, thinner, commercially available cleaners, or anti-static spray intended for older vinyl records.

## Types of Playable Discs

	DVD (8 cm / 12 cm disc)
	Video CD (VCD) (8 cm / 12 cm disc)
	Audio CD (8 cm / 12 cm disc)

In addition, this unit plays DivX file, DVD -R, DVD +R, DVD -RW, DVD +RW, Kodak Picture CDs, SVCD, and CD-R / CD-RW that contains audio titles, MP3, WMA, and/or JPEG files.



This indicates a product feature that is capable of playing DVD-RW discs recorded with Video Recording format.

### Notes:

- Depending on the conditions of the recording equipment or the CD-R/RW (or DVD -R, DVD +R, DVD -RW, DVD +RW) disc itself, some CD-R/RW (or DVD -R, DVD +R, DVD -RW, DVD +RW) discs cannot be played on the unit.
- Do not attach any seal or label to either side (the labeled side or the recorded side) of a disc.
- Do not use irregularly shaped CDs (e.g., heart-shaped or octagonal) since they may result in malfunctions.

### Notes on DVDs and Video CDs

Some playback operations of DVDs and Video CDs may be intentionally programmed by software manufacturers. This unit plays DVDs and Video CDs according to disc content designed by the software manufacturer, therefore some playback features may not be available or other functions may be added.

**Manufactured under license from Dolby Laboratories. “Dolby”, “Pro Logic”, and the double-D symbol are trademarks of Dolby Laboratories.**

**DTS and DTS Digital Out are trademarks of Digital Theater Systems, Inc.**

### Regional code

This DVD player is designed and manufactured for playback of region “2” encoded DVD software. This unit can play only DVD discs labeled “2” or “ALL”.



### Notes on Regional Codes

- Most DVD discs have a globe with one or more numbers in it clearly visible on the cover. This number must match your DVD player’s regional code or the disc cannot play.
- If you try to play a DVD with a different region code from your player, the message “Check Regional Code” appears on the TV screen.

## Disc-related terms

### DVD $\pm$ R / DVD $\pm$ RW

DVD -R and DVD +R are two different standards for recordable DVD drives and discs. This format allows information to be recorded onto the DVD disc only once. DVD +RW and DVD -RW are two standards for re-writable media, meaning the DVD content can be erased and re-recorded. Single-sided discs can hold 4.38 Gigabytes and double-sided discs hold twice as much. There are no dual layer single sided recordable discs.

### VCD (Video CD)

A VCD holds up to 74 minutes (650 MB disc) or 80 minutes (700 MB disc) of MPEG-1 full-motion video along with quality stereo sound.

### MPEG

MPEG is an international standard for video and audio compression. MPEG-1 is used in encoding video for VCD and provides for multichannel surround sound coding such as PCM, Dolby Digital, DTS and MPEG audio.

### MP3

MP3 is a popular compression format used for digital audio files that yields very high near-CD quality.

### WMA

Windows media audio file. A type of coding / decoding developed by Microsoft Corp.

### JPEG

Joint Pictures Expert Group. JPEG is a compressed file format that allows you to save images with no limit on the number of colors.

### DivX

DivX is the name of a revolutionary new video codec which is based on the new MPEG-4 compression standard for video. You will be able to play DivX movies using this DVD player.

### PBC: Playback Control (Video CD only)

Playback control is available for Video CD (VCD) version 2.0 disc formats. PBC allows you to interact with the system via menus, search functions, or other typical computer-like operations. Moreover, still pictures of high resolution can be played if they are included in the disc. Video CDs not equipped with PBC (Version 1.1) operate in the same way as audio CDs.

### Title (DVD video discs only)

A title is generally a distinct section of a DVD disc. For example the main feature could be title 1, a documentary describing how the film was made could be title 2, and cast interviews could be title 3. Each title is assigned a reference number enabling you to locate it easily.

### Chapter (DVD video discs only)

A chapter is a segment of a title such as a scene in a film or one interview in a series. Each chapter is assigned a chapter number, enabling you to locate the chapter you want. Depending on the disc, chapters may not be recorded.

### Scene (VCD)

On a video CD with PBC (playback control) functions, moving pictures and still pictures are divided into sections called "scenes". Each scene is displayed in the menu screen and assigned a scene number, enabling you to locate the scene you want. A scene is composed of one or several tracks.

### Track

A distinct element of audiovisual information, such as the picture or sound track for a specific language (DVD), or a musical piece on a video or audio CD. Each track is assigned a track number, enabling you to locate the track you want. DVD discs allow one track of video (with multiple angles) and several tracks of audio.

## Front Panel

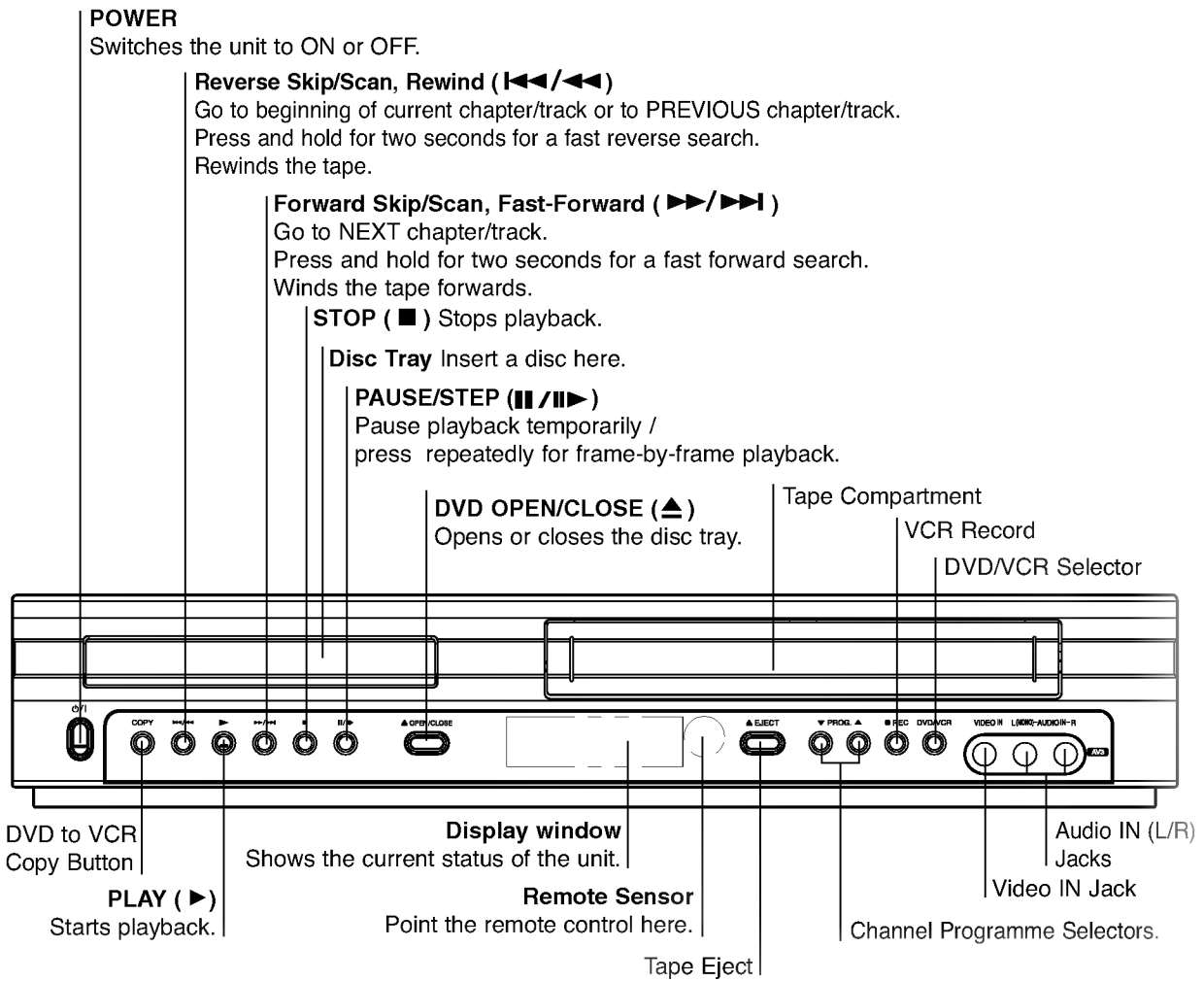

## Display Window

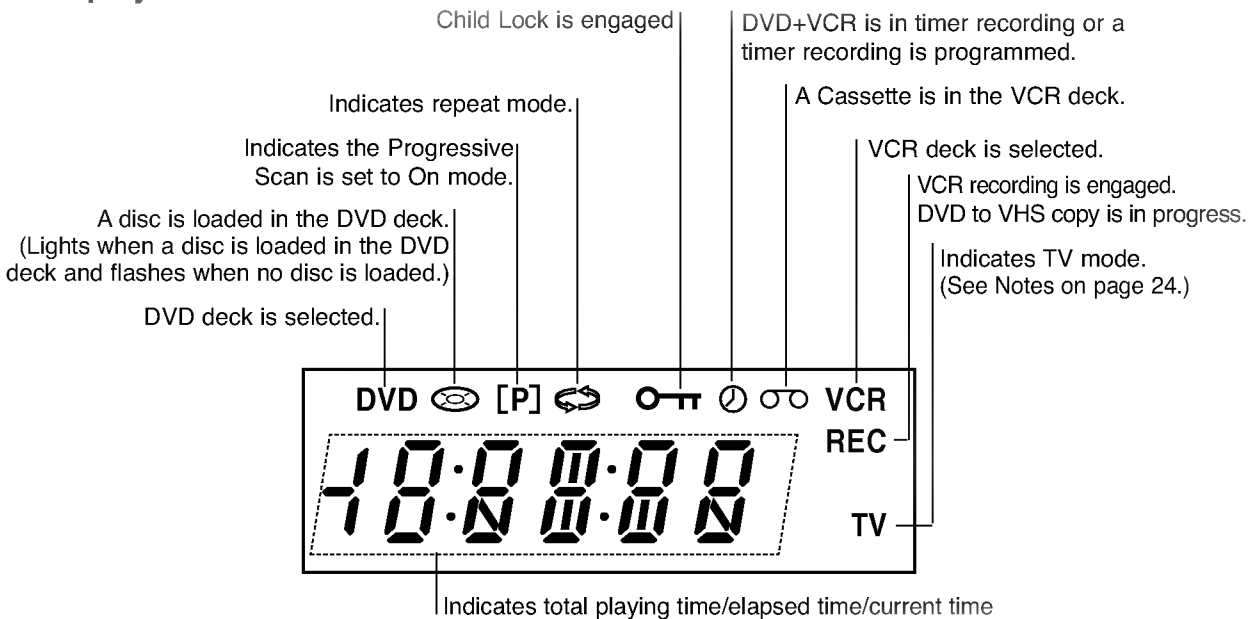

## Remote Control

**POWER**  
Switch this unit ON or OFF.

**DVD/VCR select button**  
Selects operational mode of remote control.

**0-9 numerical buttons**  
Select numbered items in a menu.

**TV/VCR**  
Switch between your TV's tuner and the VCR's internal tuner.

**BACKWARD / FORWARD (◀◀ / ▶▶)**  
- DVD: Search backward or forward.  
- VCR: Rewinds the tape during the STOP mode, for fast reverse picture search and Advances the tape during the STOP mode, fast forward picture search.

**PAUSE/STEP (||)**  
Pause playback temporarily / press repeatedly for frame-by-frame playback.

**PLAY (▶)**  
Starts playback.

**STOP (■)**  
Stops playback.

**DISPLAY CLK/CNT**  
Access the On-Screen Display. Shows you the current time or counter.

**◀ ▶ ▲ ▼ (left/right/up/down)**  
Select an item in the menu

**PR/TRK(+/-)**  
- Select channel programme of VCR.  
- To adjust tracking.  
- To control vertical tremble during picture still.

**ENTER/OK**  
Acknowledge menu selection.

**DISC MENU**  
Access menu of a DVD disc.

**A-B/LP**  
- Repeat sequence.  
- Select the recording speed of the tape.

**RANDOM/CM SKIP**  
- Play tracks in random order.  
- CM SKIP

**OPEN/CLOSE**  
**EJECT**  
- Open or close the the disc tray.  
- Tape Eject.

**AV**  
Select input source for recording into tape.

**TV Control Buttons (see p. 37)**  
**TV POWER:** Turns on or off the TV.  
**TV AV:** Selects the TV's source.  
**TV PR +/-:** Selects TV's channel.  
**TV VOL +/-:** Adjusts TV's volume.  
**MUTE:** Turns on or off TV sound.

**SKIP (◀◀ / ▶▶)**  
Go to next chapter or track. Returns to beginning of current chapter or track or go to previous chapter or track.

**SETUP/ i**  
Access or remove setup menu.

**RETURN**  
Displays the menu of a video CD with PBC.

- **AUDIO**  
Select an audio language (DVD).
- **SUBTITLE**  
Select a subtitle language.
- **ANGLE**  
Select DVD camera angle if available
- **ZOOM**  
Enlarge video image.
- **REC/ITR**  
Record your input sources into tape.
- **LOCK (Child Lock)**  
Switch the Child Lock on and off.
- **TITLE**  
Display the title menu of the disc if available.
- **PROGRAM**  
Access or remove program menu.
- **MARKER**  
Mark any point during playback.
- **SEARCH**  
Display MARKER SEARCH menu.
- **CLEAR**  
- Clear a track number on the program menu or a mark on the MARKER SEARCH menu.  
- Reset tape counter to zero.
- **REPEAT**  
Repeat chapter, track, title, all.

### Remote Control Operation

Point the remote control at the remote sensor and press the buttons.



Do not mix old and new batteries and never mix different types of batteries such as standard, alkaline, etc.

### Remote control battery installation

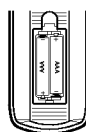

Detach the battery cover on the rear of the remote control, and insert two batteries (size AAA) with + and - aligned correctly.

## Rear Panel

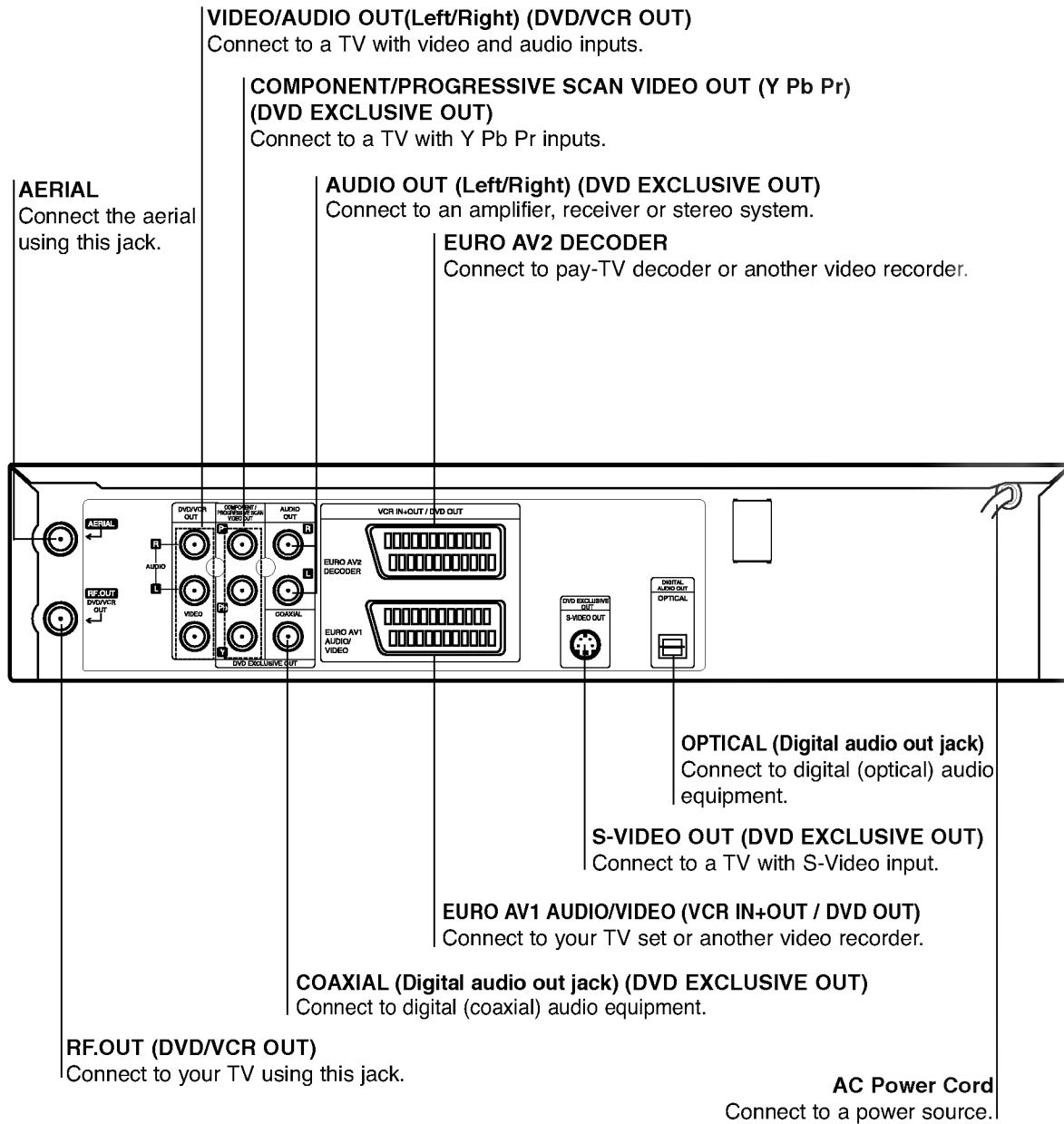

Do not touch the inner pins of the jacks on the rear panel. Electrostatic discharge may cause permanent damage to the unit.

# Installation and Setup

## Tips:

- Depending on your TV and other equipment you wish to connect, there are various ways you could connect the unit.
- Please refer to the manuals of your TV, Stereo System or other devices as necessary to make the best connections.
- For better sound reproduction, connect this unit's AUDIO OUT jacks to the audio in jacks of your amplifier, receiver, stereo or audio/video equipment. See "Connecting to optional equipment" on page 11.

## Caution:

- Make sure this unit is connected directly to the TV. Set the TV to the correct video input channel.
- Do not connect this unit's AUDIO OUT jack to the phono in jack (record deck) of your audio system.

## Connecting to a TV & Decoder (or Satellite)

- Make one of the following connections, depending on the capabilities of your existing equipment.
- You must set the "TV Output Select" option to use COMPONENT/PROGRESSIVE SCAN VIDEO OUT and SCART jacks. (See "TV Output Select" on page 19.)

### Basic connection (AV)

1. Connect the **EURO AV1 AUDIO/VIDEO** on the rear panel of this unit to the SCART input socket on the TV using a SCART lead.
2. Some TV broadcasters transmit encoded television signals which you can only see with a purchased or rented decoder. You can connect such a decoder (descrambler) to this unit.

### Basic connection (RF)

1. Connect the RF antenna cable from your indoor/outdoor antenna to AERIAL jack on the rear panel of this unit.
2. Connect the supplied RF antenna cable from the RF.OUT jack on the rear panel of this unit to your television's Antenna Input.

### DVD exclusive out connection

#### • Component Video (Color Stream®) connection

1. Connect the **COMPONENT/PROGRESSIVE SCAN VIDEO OUT** jacks on the DVD Player to the corresponding in jacks on the TV using the Y Pb Pr cable.
2. Connect the Left and Right **AUDIO OUT** jacks of the DVD Player to the audio left/right in jacks on the TV using the audio cables.

#### • S-Video connection

1. Connect the **S-VIDEO OUT** jack on this unit to the S-Video input jack on the TV using the S-Video cable.
2. Connect the Left and Right **AUDIO OUT** jacks of the DVD Player to the audio left/right in jacks on the TV using the audio cables.

#### Progressive Scan (ColorStream®Pro) connection

- If your television is a high-definition or "digital ready" television, you may take advantage of the DVD Player's progressive scan output for the highest video resolution possible.

- If your TV does not accept the Progressive Scan format, the picture will appear scrambled if you try Progressive Scan on the DVD Player.
1. Connect the **COMPONENT/ PROGRESSIVE SCAN VIDEO OUT** jacks on the DVD Player to the corresponding in jacks on the TV using the Y Pb Pr cable.
  2. Connect the Left and Right **AUDIO OUT** jacks of the DVD Player to the audio left/right in jacks on the TV using the audio cables.

## Notes:

- Set the Progressive to "On" on the setup menu for progressive signal, see page 19.
- Once the setting for progressive scan output is entered, an image will only be visible on a progressive scan compatible TV or monitor. If you set Progressive Scan to On in error, you must reset the unit.
  - 1) Remove any disc from the unit and close the disc tray. See that "DISC" is displayed on the display window.
  - 2) Press STOP and hold it for five seconds before releasing it. The video output will be restored to the standard setting and a picture will once again be visible on a conventional analog TV or monitor.
- Progressive scan does not work with the analog video connections (yellow VIDEO OUT jack) or S-VIDEO connection.

Rear of this unit (DVD exclusive out connection)

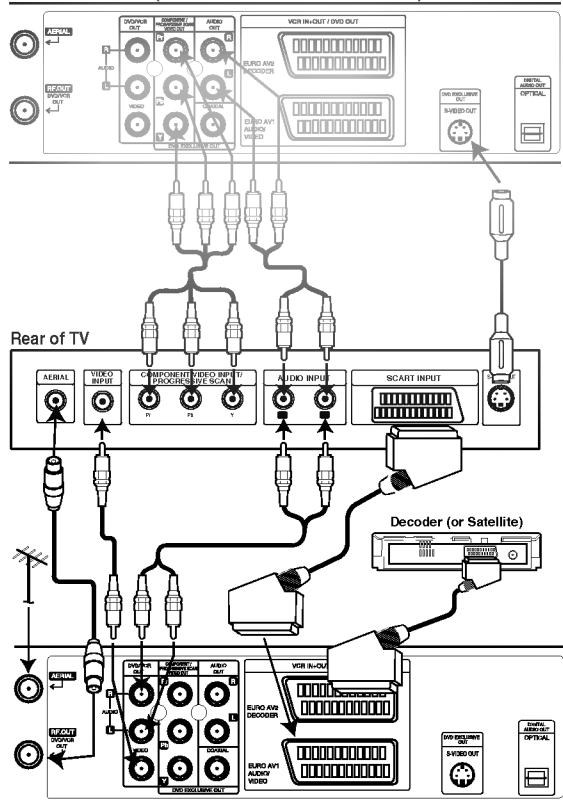

Rear of this unit (Basic connection)

## Note:

If the TV has an S-video input, connect the DVD player with the S-video cable. When using an S-video cable, do not connect the yellow video cable.

## Connecting to Optional Equipment

### Connecting to an amplifier equipped with two channel analog stereo or Dolby Pro Logic II/Pro Logic

Connect the Left and Right AUDIO OUT jacks on this unit to the audio left and right in jacks on your amplifier, receiver or stereo system, using the audio cables.

### Connecting to an amplifier equipped with two channel digital stereo (PCM) or to an Audio/Video receiver equipped with a multi-channel decoder (Dolby Digital™, MPEG 2 or DTS)

1. Connect this unit's DIGITAL AUDIO OUT jack (OPTICAL or COAXIAL) to the corresponding in jack on your amplifier. Use an optional digital (optical or coaxial) audio cable.
2. You will need to activate this unit's digital output. (See "AUDIO" on page 20).

### Digital Multi-channel sound

A digital multi-channel connection provides the best sound quality. For this you need a multi-channel Audio/Video receiver that supports one or more of the audio formats supported by your unit (MPEG 2, Dolby Digital and DTS). Check the receiver manual and the logos on the front of the receiver.

#### Warning:

Due to the DTS Licensing agreement, the digital output will be in DTS digital out when DTS audio stream is selected.

#### Notes:

- If the audio format of the digital output exceeds the capabilities of your receiver, the receiver will produce a strong, distorted sound.
- To see the audio format of the current output, press AUDIO On-Screen Display, press AUDIO

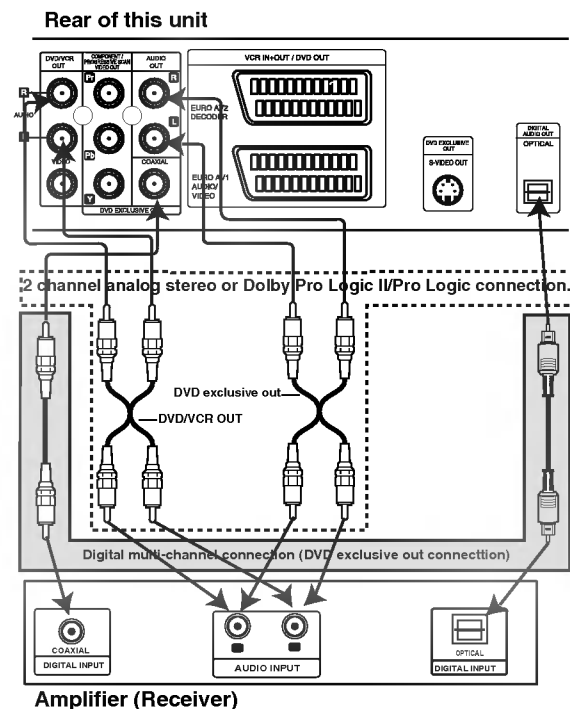

# Before Operation-VCR part

## Tuning in a video channel on your TV

### Notes:

- The output frequency of this video recorder (VCR) is set at UHF channel 36. If channel 36 is already used by another TV station, or if the picture is distorted, you can change the transmitter channel of your VCR. Stages 5 ~ 8 will show you how to change the output frequency of your VCR.
- Your TV receives signals from the video recorder (VCR) like another TV station. You have to select a channel number on your TV and tune it in so that you may watch video tapes. If you have used a **SCART** or **AUDIO** and **VIDEO** cables then your TV should already have a dedicated video channel built into it, usually called **AV**.

1. Make sure that you have correctly installed your VCR as described earlier in this book. Press **POWER** to turn on your VCR. Turn on your TV.
2. Insert a pre-recorded video tape into your VCR and press **PLAY** on the remote control. Select a TV channel number on which you wish to watch video's. Don't worry if you don't have a video-tape to play at this stage! If you switch your VCR on and continue stages 3 ~ 4, instead of seeing video playback tune your TV until you see a bright blue screen.
3. Tune this channel until the video picture is sharp and the sound is clear. If you have used a **SCART** or **AUDIO** and **VIDEO** cables you will not have to tune your TV, simply select the **AV** channel. The **AV** channel is already pre-tuned for optimum video playback on your TV.
4. Store this channel on your TV. You will need to look at the TV instruction book if you do not know how to do this.
5. **Only carry out stages 5 ~ 8 if you cannot obtain clear video playback as described in stages 1 ~ 4.** Select a TV channel number on which you wish to watch video's. Make sure that your VCR is in standby pressing **POWER** on the remote control (only the clock will be displayed).
6. Press **PROG.** ▲ or ▼ on the front of your VCR for more than 4 seconds. **RF36** will appear in the display window. The following picture will be displayed on the TV screen.

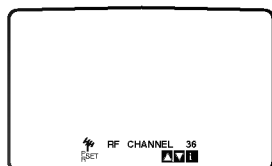

7. Press **PROG.** ▲ or ▼ to select another video channel. You may select any channel number between 22 and 68. You can also set it to "OFF" if there is any interference when your TV is connected to the VCR with a SCART lead.
8. Select a TV channel number on which you wish to watch video's. Press **OK** on the front of your VCR when you have finished. Tune this channel so that a bright blue screen appears. Store this channel on your TV.

### Note:

Make sure that you have correctly installed your VCR and successfully tuned in a dedicated video channel on your TV. If you do not tune in a dedicated video channel on your TV you will be unable to view and record video tapes!

## Initial preset

For the following steps we do assume that you have just connected your video recorder for the very first time. In this case the video recorder is on after mains connection. You should not touch any buttons yet. On the connected TV you will now see.

**Note** - If this menu does not appear, your video recorder was programmed already.

1. Select the country according to your area with ◀ and ▶.  
"A": Austria, "B": Belgium, "CH": Switzerland, "D": Germany, "DK": Denmark, "E": Spain, "F": France, "I": Italy, "N": Norway, "NL": Netherlands, "P": Portugal, "S": Sweden, "SF": Finland, OTHERS.

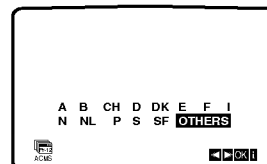

2. Press **OK** to start the automatic storing of the channels of the TV stations in your area.

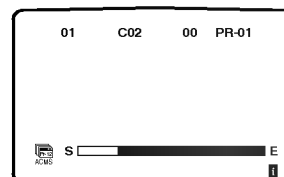

## Setting the clock Manually

The clock in your VCR controls time and date settings for your VCR.

1. Press **i**.  
Press **◀** or **▶** to select **TIME DATE**.  
Press **OK**.

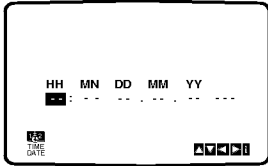

2. Use the **numbered buttons** on the remote control to alter the **HOURS, MINUTES, DAY, MONTH** and **YEAR**.  
Please note your VCR uses a 24 hour clock. e.g. 1pm will be displayed as 13:00.  
The day of the week will appear automatically when you enter the year.

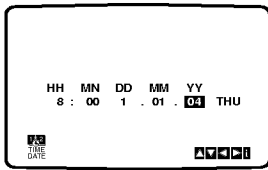

3. If you make a mistake press **◀** or **▶** and enter the correct details.
4. Press **i**.

## To set the colour system

1. Press **i**.
2. The main menu will appear on the TV screen.
3. Press **◀** or **▶** to select the **SYSTEM** and press **OK**.
4. Press **▲** or **▼** to select according to the **COLOUR** system used.

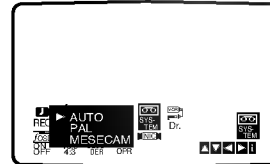

5. Press **◀** or **▶** to select the **RF AUDIO**.  
Press **▲** or **▼** to select according to the **RF AUDIO** used.

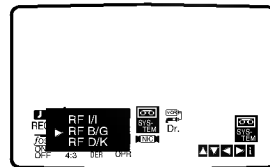

6. Press **i** to remove the menus from the TV screen.

## How to using the main menu

This VCR can easily be programmed by using the menus displayed on screen.

The menus are controlled from the Remote Control Handset.

1. Switch on your TV set and video recorder by pressing the **POWER** button.
2. Press **i** button.  
The main menu will appear on the TV screen.

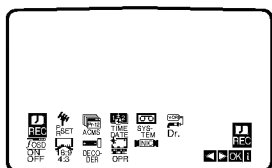

- **REC** - Timer recording setting (see p. 25).
- **PR SET** - Manual tuning setting (see p. 15).
- **ACMS** - ACMS (Automatic Channel Memory System) (see p. 14).
- **TIME DATE** - Date & clock setting (see p. 13).
- **SYSTEM** - To set the Colour TV System (see p. 13).
- **Dr.** - To check a problem with your VCR (see p. 35).
- **F.OSD ON/OFF** - To display the operational mode of your VCR (see p. 35).
- **16:9/4:3** - To select the aspect ratio of your TV (see p. 36).
- **DECODER** - To use a pay-TV decoder (or Satellite) with your VCR (see p. 36).
- **OPR** - To improve the playback picture (see p. 23).
- **NIC** - To activate or deactivate the NICAM digital sound (see p. 36).

### Tip:

You can change the menu language on the DVD setup menu. (See the Menu Language on page 18.)

3. Press **◀** and **▶** to select the desired menu. Press **OK** and press **▲** or **▼** to select.
4. Press **i** to remove the menus from the TV screen.

## Tuning in TV Stations Automatically

If the TV broadcast signal is weak your VCR may not detect the necessary information and will not be able to store them correctly. To overcome this problem please turn to the **MANUAL TUNING** section on page 15.

1. Press **POWER** to turn on your VCR.
2. Press **i** button.  
The main menu will appear on the TV screen. Press **◀** or **▶** to select the **ACMS**. Press **OK**.

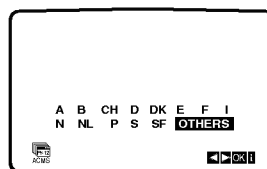
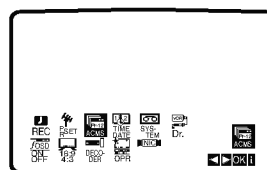

3. Press **◀** or **▶** to select **COUNTRY**. (**A:Austria, B:Belgium, CH:Switzerland, D:Germany, DK:Denmark, E:Spain, F:France, I:Italy, N:Norway, NL:Netherlands, P:Portugal, S:Sweden, SF:Finland, OTHERS**)  
Press **OK** again to start the automatic tuning process.

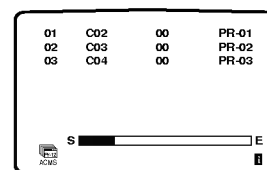

4. The **TV STATION TABLE** will appear when tuning is complete. Press **i** to save your settings.

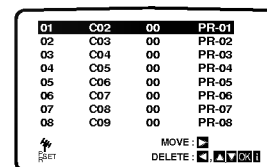



## Changing the order of TV Stations

After tuning TV stations into your VCR you may wish to change the order in which they are stored without having to retune them against! The instructions given on this page will show you how you can simply move them into your desired order.

1. Press **i**.

The main menu will appear on the TV screen. Press **◀** or **▶** to select the **PR SET**. Press **OK**.

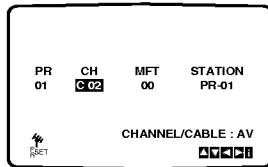
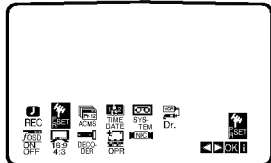

2. Press **i**.

Press **▲** or **▼** to select the **programme number** you want to move (for example, PR 03). Press **▶**.

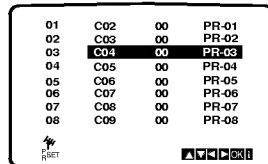
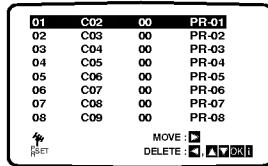

3. Press **▲** or **▼** to select the **programme number** you want to move to (for example, PR 05).

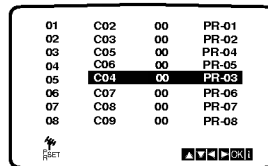

4. Press **OK**.

The selected **programme** will be moved to the **new programme number**.

If you wish to move other TV stations repeat stages 1 - 4. Press **i** to remove the menus from the TV screen.

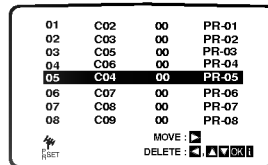

## Deleting TV Stations

After tuning TV stations into your VCR you may wish to delete a station. The instructions given on this page will show you how easily delete any unwanted TV stations.

1. Press **i**.

The main menu will appear on the TV screen. Press **◀** or **▶** to select the **PR SET**. Press **OK**.

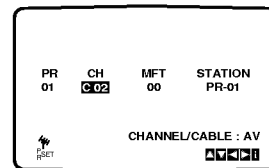

2. Press **i**.

Press **▲** or **▼** to select the **programme number** you want to delete. (for example, PR 03)

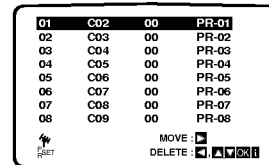

3. Press **◀**.

After a short while, the selected station will be deleted.

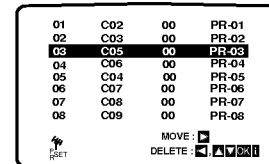

4. Press **i** to remove the menus from the TV screen.

If you wish to delete other TV stations repeat stages 1 - 3.

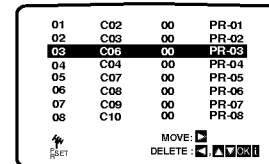

### How to selecting Stored TV stations:

Stored TV stations can be selected in either of two ways.

Press **PROG.** **▲** or **▼** to select different stations that are tuned into your VCR.

You may also directly select stations using the **numbered buttons** on the remote control.

## Before Operation-DVD part

### On-Screen Display







You can display the general playback status on the TV screen. Some items can be changed using the menu. To use the on-screen display:

1. Press DISPLAY during playback.
2. Press ▲ / ▼ to select an item. The selected item is highlighted.
3. Press ◀ / ▶ to change the setting. You can also use the number buttons if appropriate (e.g. inputting the title number). For some functions, press ENTER to execute the setting.





#### Notes:

- Some discs may not provide all of the features shown below.
- If no button is pressed for 10 seconds, the on-screen display disappears.



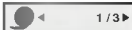

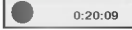
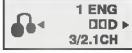
### Playback Status/Restrictions

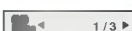
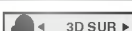
-  TITLE Repeat title
-  A - B Repeat sequence
-  1 / 9 Enter a Marker
-  MARKER SEARCH  
◀ 1 2 3 4 5 6 7 8 9 ▶ Marker Search menu
-  Resume play from this point
-  Action prohibited or not available

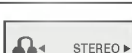

### Example: On-Screen Display during playing DVD Video

Items	Selection Method
Title Number 	◀ / ▶, Numbers ENTER
Chapter Number 	◀ / ▶, Numbers ENTER
Time search 	Numbers, ENTER
Audio language and Digital Audio Output mode 	◀ / ▶ or AUDIO
Subtitle language 	◀ / ▶ or SUBTITLE
Angle 	◀ / ▶ or ANGLE
Sound 	◀ / ▶

### Example: On-Screen Display during playing VCD

Items	Selection Method
Track Number (or PBC mode) 	◀ / ▶, Numbers ENTER
Time search 	Numbers ENTER
Audio Channel 	◀ / ▶ or AUDIO
Sound 	◀ / ▶

### Example: On-Screen Display during playing divx movie disc

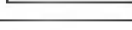
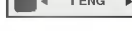
Items	Selection Method
Track Number 	◀ / ▶, Numbers ENTER
Time search 	Numbers, ENTER
Audio language and Digital Audio Output mode 	◀ / ▶ or AUDIO
Subtitle language 	◀ / ▶ or SUBTITLE
Sound 	◀ / ▶

## Initial Settings

By using the Setup menu, you can make various adjustments to items such as picture and sound. You can also set a language for the subtitles and the Setup menu, among other things. For details on each Setup menu item, see pages 18 to 22.

### To display and exit the Menu:

Press **SETUP** to display the menu. A second press of **SETUP** will take you back to initial screen.

### To go to the next level:

Press **▶** on the remote control.

### To go back to the previous level:

Press **◀** on the remote control.

## General Operation

1. Press **SETUP**. The Setup menu appears.
2. Use **▲ / ▼** to select the desired option then press **▶** to move to the second level. The screen shows the current setting for the selected item, as well as alternate setting(s).
3. Use **▲ / ▼** to select the second desired option then press **▶** to move to the third level.
4. Use **▲ / ▼** to select the desired setting then press **ENTER** to confirm your selection. Some items require additional steps.
5. Press **SETUP** or **PLAY** to exit the Setup menu.

## LANGUAGE

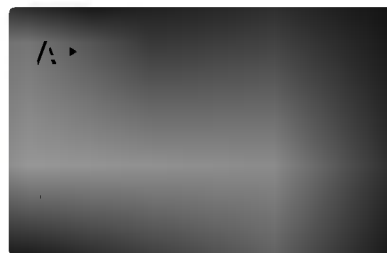

### Menu Language

Select a language for the Setup menu and on-screen display.

### Disc Audio / Subtitle / Menu

Select the language you prefer for the audio track (disc audio), subtitles, and the disc menu.

**Original:** Refers to the original language in which the disc was recorded.

**Other:** To select another language, press number buttons then **ENTER** to enter the corresponding 4-digit number according to the language code list in the reference chapter. If you enter the wrong language code, press **CLEAR**.

## DISPLAY

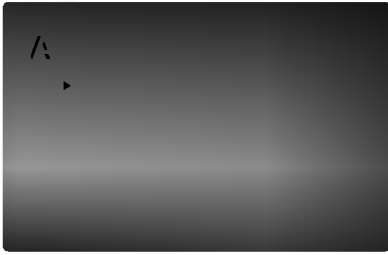

### TV Aspect

**4:3** : Select when a standard 4:3 TV is connected.

**16:9 Wide**: Select when a 16:9 wide TV is connected.

### Display Mode

Display Mode setting works only when the TV Aspect mode is set to "4:3".

**LetterBox**: Displays a wide picture with bands on the upper and lower portions of the screen.

**Panscan**: Automatically displays the wide picture on the entire screen and cuts off the portions that do not fit.

### Progressive Scan

Progressive Scan Video provides the highest quality pictures with less flickering.

If you are using the Component Video jacks for connection to a TV or monitor that is compatible with a progressive scan signal, set Progressive Scan to On.

#### To turn On progressive scan:

Connect component out of this unit to the input of your monitor/television, set your television or monitor to Component Input.

1. Select "Progressive Scan" on the DISPLAY menu then press ►.

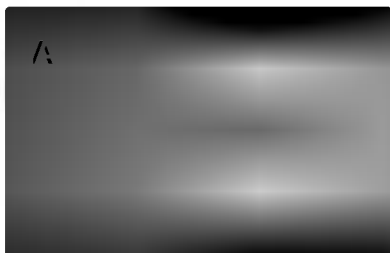

2. Select "On" using the ▲ / ▼ buttons.
3. Press ENTER to confirm your selection. The confirm menu will appear.

#### Note:

If your TV does not accept the Progressive Scan format, the picture will appear scrambled if you try Progressive Scan on the DVD Player.

4. When the confirm menu appears on your screen Cancel is highlighted as default. Use the ◀ button to highlight Enter.
5. Pressing ENTER will set this unit to Progressive scan mode.

#### Caution:

Once the setting for progressive scan output is entered, an image will only be visible on a progressive scan compatible TV or monitor. If you set Progressive Scan to On in error, you must reset the unit.

- 1) Remove any disc from the unit and close the disc tray. See that "DISC" is displayed on the display window.
- 2) Press STOP and hold it for five seconds before releasing it. The video output will be restored to the standard setting and a picture will once again be visible on a conventional analog TV or monitor.

### TV Output Select

Set this unit TV Output Select options according to the TV connection type.

**YPbPr**: When your TV is connected with the COMPONENT/PROGRESSIVE SCAN VIDEO OUT jacks on this unit.

**RGB**: When your TV is connected with the SCART (RGB signal) jack.

## AUDIO

Each DVD disc has a variety of audio output options. Set this unit AUDIO options according to the type of audio system you use.

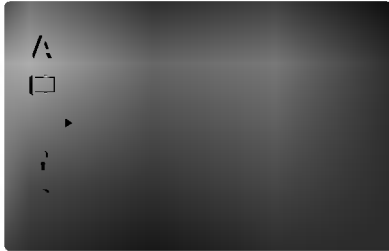

### Dolby Digital / DTS / MPEG

**Bitstream:** Select "Bitstream" if you connect the DVD Player's DIGITAL OUT jack to an amplifier or other equipment with a Dolby Digital, DTS or MPEG decoder.

**PCM (for Dolby Digital / MPEG):** Select when connected to a two-channel digital stereo amplifier. DVDs encoded in Dolby Digital or MPEG will be automatically downmixed to two-channel PCM audio.

**Off (for DTS):** If you select "Off", the DTS signal is not output through the DIGITAL OUT jack.

### Sample Freq. (Frequency)

If your receiver or amplifier is NOT capable of handling 96 kHz signals, select 48 kHz. When this choice is made, this unit automatically converts any 96 kHz signals to 48 kHz so your system can decode them.

If your receiver or amplifier is capable of handling 96 kHz signals, select 96 kHz. When this choice is made, this unit passes each type of signal through without any further processing.

Check the documentation for your amplifier to verify its capabilities.

### Dynamic Range Control (DRC)

With the DVD format, you can hear a program's soundtrack in the most accurate and realistic presentation possible, thanks to digital audio technology. However, you may wish to compress the dynamic range of the audio output (the difference between the loudest sounds and the quietest ones). This allows you to listen to a movie at a lower volume without losing clarity of sound. Set DRC to On for this effect.

### Vocal

Set to On only when a multi-channel karaoke DVD is playing. The karaoke channels on the disc mix into normal stereo sound.

## OTHERS

The PBC, Auto Play and DivX(R) VOD settings can be changed.



### PBC

Set Playback Control (PBC) to On or Off.

**On:** Video CDs with PBC are played according to the PBC.

**Off:** Video CDs with PBC are played the same way as Audio CDs.

### Auto Play

You can set up the DVD Player so a DVD disc automatically starts playing whenever the DVD is inserted. If Auto Play mode is set to On, this DVD player will search for title that has the longest playback time and then play back the title automatically.

**On:** Auto Play function is active.

**Off:** Auto Play function is not active.

### Notes:

The Auto Play function may not work for some DVDs.

### DivX(R) VOD

You can display the DivX DRM (Digital Rights Management) Registration code for your unit only.



The Registration code is used for VOD (Video-On-Demand) service agent. You can purchase or rent an encrypt move file.

### Notes:

If you rent the DivX VOD file, it has several options of viewing limits as shown below.

- Display the number which you can watch the file.

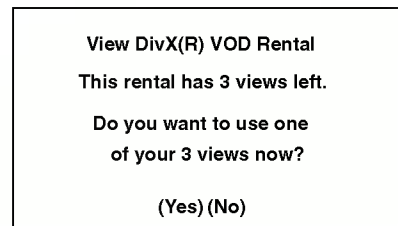

- The rental has been expired.

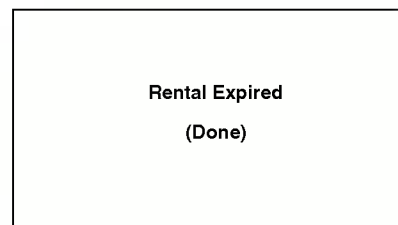

- Display the authorization error.



## LOCK (Parental Control)

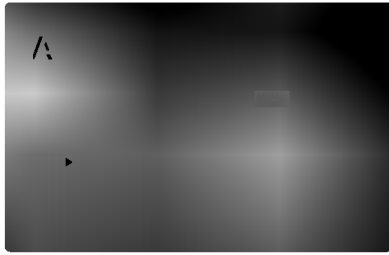

### Rating

Some movies contain scenes that may not be suitable for children to view. Many of these discs contain parental control information that applies to the complete disc or to certain scenes on the disc. Movies and scenes are rated from 1 to 8, depending on the country. Some discs offer more suitable scenes as an alternative.

The parental control feature allows you to block access to scenes below the rating you input, thereby preventing your children from being able to view material you believe is unsuitable.

1. Select "Rating" on the LOCK menu then press ▶.
2. To access the Rating, Password and Country Code features, you must input the 4-digit security code you created. If you have not yet entered a security code you are prompted to do so.

Input a 4-digit code and press ENTER. Enter it again and press ENTER to verify. If you make a mistake before pressing ENTER, press CLEAR.

3. Select a rating from 1 to 8 using the ▲ / ▼ buttons.

**Rating 1-8:** Rating one (1) has the most restrictions and rating eight (8) is the least restrictive.

### Unlock

If you select unlock, parental control is not active and the disc plays in full.

### Notes:

If you set a rating for the player, all disc scenes with the same rating or lower are played. Higher rated scenes are not played unless an alternate scene is available on the disc. The alternative must have the same rating or a lower one. If no suitable alternative is found, playback stops. You must enter the 4-digit password or change the rating level in order to play the disc.

4. Press ENTER to confirm your rating selection, then press SETUP to exit the menu.

## Password (Security Code)

You can enter or change password.

1. Select Password on the LOCK menu then press ▶.
2. Follow step 2 as shown left (Rating). "Change" or "New" is highlighted.
3. Enter the new 4-digit code, then press ENTER. Input it again to verify.
4. Press SETUP to exit the menu.

### If you forget your Security Code

If you forget your security code you can clear it using the following steps:

1. Press SETUP to display the Setup menu.
2. Input the 6-digit number "210499" and the security code is cleared.
3. Enter a new code as described above.

## Country Code

Enter the code of the country/area whose standards were used to rate the DVD video disc, based on the list in the reference chapter.

1. Select "Country Code" on the LOCK menu then press ▶.
2. Follow step 2 as shown left (Rating).
3. Select the first character using ▲ / ▼ buttons.
4. Press ENTER and select the second character using ▲ / ▼ buttons.
5. Press ENTER to confirm your country code selection.

# Operation

## Playing a tape

You will only be able to load and eject video cassettes when your VCR is plugged into the mains. Your VCR may also playback recordings from NTSC tapes (on PAL TV).

### Getting a better picture

When a cassette is inserted and playback started, the automatic tracking function works to get the best possible picture automatically. If the quality of the recording is poor, repeatedly press TRK + or - on the remote control to manually adjust the tracking until any distortions have been removed. Press numbered 0 on the remote control to switch automatic tracking back on again.

1. Make sure that you have correctly connected your VCR as described earlier in this book.  
Turn on your TV.  
Press **POWER** to turn on your VCR.  
Insert the video cassette into your VCR.  
The video cassette should have the window side facing up and the arrow facing away from you.

2. Press **PLAY** to start playing your tape.  
If you load a video cassette which has had its record protection tab removed, playback of the cassette will start automatically.

### AUTO TRACKING

Your VCR will automatically adjust the tracking to give the best picture quality.

3. Press **PAUSE/STEP** to still a picture.  
Press **PAUSE/STEP** repeatedly to advance the tape frame by frame.  
If you press **FORWARD**, the picture will be slowed down at about 1/19 times the normal playback. Tapes can be paused for up to 5 minutes. After 5 minutes your VCR will stop the tape to prevent damaging the tape or your VCR.  
Still picture quality can be improved slightly by pressing TRK + or -.

4. Press **PLAY** to continue playing your tape.

### Picture search:

During playing back press either **FORWARD** or **BACKWARD** and this will enable you to rapidly wind the tape (7 times normal playback) and see where you are on the tape.

### Logic search:

During fast forwarding or rewinding press and hold **FORWARD** or **BACKWARD** the picture will be played back at 7 times normal playback speed.

5. **Slow motion playback, Shuttle :**

During playing back or still picture press ◀ or ▶. You can reach the following playback speeds. (-7xplay, -3xplay, -play, still, 1/19 slow, play, 2xplay, 7xplay)

To switch off the slow motion and shuttle, press the desired function.

During slow motion and shuttle, the noise bars may appear on the picture according to the status of tape.

If distortions can be seen in the picture, reduce them with TRK + or -.

6. Press **STOP** to end playback.

Press **EJECT**.

If the end of the tape is reached, your VCR will stop playback automatically, rewind, stop, eject the tape.

### CM (Commercial Message) Skip:

This feature enables you during playback of a tape to skip a commercial break in a few seconds, then resume normal playback.

While tape is playing press **CM SKIP** on the remote control to skip commercial (or another programme material).

Repeatedly press **CM SKIP** to skip:

- 1 Press 30 seconds
- 2 Press 60 seconds
- 3 Press 90 seconds
- 4 Press 120 seconds
- 5 Press 150 seconds
- 6 Press 180 seconds

### OPR (Optimum Picture Response)

This feature automatically improves playback picture quality by adjusting your VCR to the condition of the tape.

1. Press **i**.
2. Press ◀ or ▶ to select OPR.
3. Press **OK**.

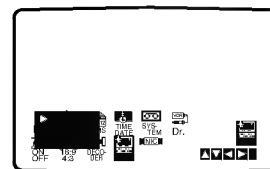

4. Press ▲ or ▼ repeatedly to select: **OFF**, **SOFT** or **SHARP**.

**Please note you may only set OPR when playing a tape.**

5. Press **i** return to screen.

## Instant Timer Recording (ITR)

Your VCR allows you to make recordings using a variety of simple methods:

Instant Timer Recording (ITR) start recording immediately for a set period of time or until the video cassette runs out.

Your VCR incorporates Long Play (LP) which enables you to record up to twice the amount of time on a video cassette. For example an E-180 will record up to 180 minutes using Standard Play (SP); using LP you will be able to record up to 360 minutes. Please note there will be a slight loss in picture and sound quality when using LP.

1. Make sure that you have correctly connected your VCR as described earlier in this book.  
Press **POWER** to turn on your VCR.
2. Insert a video cassette with protection tab into your VCR.  
The video cassette should have the window side facing up and the arrow facing away from you.
3. Press **PR +** or **-** to select the **programme number** you wish to record.  
You may also directly select programme number using the **numbered buttons** on the remote control.
4. If you wish to record directly from the SCART or RCA sockets repeatedly press **AV** until the socket you wish to record from is displayed.  
**AV 1** for recording from EURO AV1 SCART socket on the rear of your unit.  
**AV 2** for recording from EURO AV2 SCART socket on the rear of your unit.  
**AV 3** for recording from VIDEO IN and AUDIO IN (Left & Right) sockets on the front of your unit.

5. Press **LP** if you wish to record in Long Play or Standard Play.  
SP will produce improved picture and sound quality, however LP will provide twice as much recording time as SP.
6. Press **REC/ITR** to start recording.  
RECORD will appear on the TV screen.  
Press **REC/ITR** several times. Each successive press will increase the record time by 30 minutes until you reach a maximum of 9 hours.
7. Press **PAUSE/STEP** to avoid recording unwanted scenes.  
Press **PAUSE/STEP** to continue recording.  
If you press **PAUSE/STEP** during ITR, this unit will enter the record pause mode and ITR is cancelled. Tapes can be paused for up to 5 minutes; RECP will be displayed when a tape is paused. After 5 minutes your VCR will stop recording to prevent damaging the tape or your VCR.
8. Press **STOP** to end recording.  
Press **EJECT**.  
EJECT will appear on the TV screen for a few seconds.

### Notes:

- If you do not wish to record on a tape (this can happen quite easily by accident!) remove the protection tab on the back edge of the video cassette.
- It is possible to record on a video cassette with the record protection tab removed by covering the hole with self adhesive tape.
- Remember you can record one programme while watching another by starting your instant recording, press **TV/VCR** to appear **TV** indicator in the display window and then selecting a different channel on your TV.

## Timer recording using On Screen Display

You may set up to seven timer record events within one month of the current date.

### Note:

Before setting the timer make sure that you have set the VCR clock correctly and you know which stations you have tuned TV stations on your VCR.

1. Insert a video cassette with protection tab into your VCR.  
The video cassette should have the window side facing up and the arrow facing away from you.
2. Press **i**.  
Press **◀** or **▶** to select **REC**.  
Press **OK**.
3. Press **OK** to start setting the timer record event. If all timer record events are full press **▲** or **▼** to select the event that you wish to remove and replace.  
Press **◀** to delete the event.

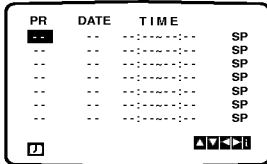

4. Press the **numbered buttons** to enter the station that you wish to record.  
When selecting stations 1 - 9, press 0 first, then the channel number; for example Stations 3 - 03. You may also select Channels by pressing **▲** or **▼**. Once selected press **▶**.  
If you wish to record from AUDIO IN (L/R) and VIDEO IN on the front or from the EURO SCART sockets on the back of your unit, press **AV** to select for correct display (AV1, AV2 or AV3).

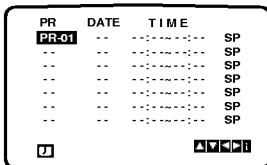

5. Press the **numbered buttons** to enter the date of the programme.  
If you press **OK** before entering the date you may select one of the following automated recording features. Press **◀** or **▶** to select, then press **OK** to confirm.  
**DLY** To record every day (except Saturday and Sunday) at the same time.  
**SU~SA** To record at the same time every week.

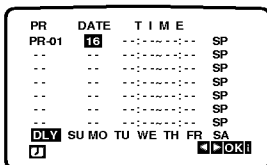

6. Press the **numbered buttons** to enter the recording start and end times of the programme that you wish to record.  
Please note your VCR uses a 24 hour clock. e.g. 1pm will be displayed as 13:00.

You may also select the the start and end times by pressing **▲** or **▼**.

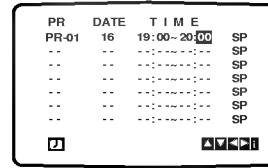

7. Press **▶** to select the recording speed.  
Press **▲** or **▼** to select the desired tape speed (SP, IP, or LP).  
IP mode determines how much tape is left and switches speed from SP to LP, if necessary, to complete recording the program.

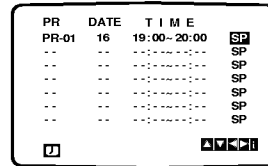

8. Check that the timer event details are correct.  
Press **i** twice.  
If **PLEASE CHECK** is displayed, you have entered incorrect and will need to re-enter the data.  
Press **POWER** to switch your VCR Standby.  
**Ø** will appear in the display window while your VCR waits to make the recording. To watch a DVD during timer recording standby mode, press **POWER** and **DVD** to switch to DVD mode.
9. Press **STOP** to end recording.

### Notes:

- If at a later date you wish to **delete** or **change** any of the settings in timer event memory you may do so without having to enter all the timer event information again. Simply display the timer event screen. Press **▲** or **▼** to select the event that you wish to **delete** or **change**. Press **◀** to delete the event...or Press **OK** to change; then press **◀** or **▶** to select; Station, Date, Start and End times and LP. Press **▲** or **▼** to enter the correct information.
- **If Timer record events Overlap...**  
Make sure that the preset times of the timer recording events do not overlap. If they do, the earlier programme will always be given priority.  
**Example:**  
Programme 1 is programmed to start at 16:00 and end at 17:00.  
Programme 2 is programmed to start at 16:30 and end at 17:30.  
(In this case, Programme 1 will be recorded in its entirety, but only the last 30 minutes of Programme 2 will be recorded.)

## Playing a DVD or Video CD

### Playback Setup

1. Turn on the TV and select the video input source connected to the DVD player.
2. Turn on the audio system (if applicable) and select the input source connected to the DVD player.
3. Press OPEN/CLOSE to open the disc tray and load your chosen disc in the tray, with the playback side down.
4. Press OPEN/CLOSE to close the tray. Playback starts automatically. If playback does not start, press PLAY.

In some cases, the disc menu might appear instead:

#### DVD

Use the ◀ ▶ ▲ ▼ buttons to select the title/chapter you want to view, then press ENTER to start. Press TITLE or DISC MENU to return to the menu screen.

#### VCD

Use the number buttons to select the track you want to view and press RETURN to return to the menu screen. Menu settings and operating procedures may differ. Follow the instructions on the each menu screen. You also may set PBC to Off (See "PBC" on page 21).

### Notes:

- If parental control is set and the disc is not within the rating settings you must input the password. (See "Lock Menu" on page 22.)
- DVDs may have a region code. Your player does not play discs that have a region code different from your player. The region code for this player is 2 (two).
- To watch a DVD during timer recording standby mode, press POWER and DVD to switch to DVD mode.

## General Features

### Note:

Unless stated otherwise, all operations described use the remote control. Some features may also be available on the Setup menu.

### Moving to another TITLE **DVD**

When a disc has more than one title, you can move to another title. Press DISPLAY while playback is stopped then the appropriate number (0-9) or use ◀ / ▶ to move to another title. You can play any title by inputting its number while playback is stopped.

### Moving to another CHAPTER/TRACK

#### DVD VCD DivX

When a title on a disc has more than one chapter or a disc has more than one track, you can move to another chapter/track as follows:

- Press SKIP ◀◀ or ▶▶ briefly during playback to select the next chapter/track or to return to the beginning of the current chapter/track.
- Press SKIP ◀◀ twice briefly to step back to the previous chapter/track.
- To go directly to any chapter during DVD playback, press DISPLAY and press ▲ / ▼ to select the chapter/track icon. Then, input the chapter/track number or use ◀ / ▶.

### Search **DVD VCD DivX**

1. Press ◀◀ or ▶▶ during playback.
2. Press ◀◀ or ▶▶ repeatedly to select the required speed.  
DVD, DivX disc; X2, X4, X16 or X100  
Video CD; X2, X4 or X8
3. To exit SEARCH mode, press PLAY.

### Changing the Audio Channel **VCD**

Press AUDIO repeatedly during playback to hear a different audio channel (Stereo, Left, or Right).

**Still Picture and Frame-by-Frame Playback****DVD VCD DivX**

1. Press PAUSE/STEP on the remote control during playback. Advance the picture frame-by-frame by pressing PAUSE/STEP repeatedly.
2. To exit still motion mode, press PLAY.

**Slow Motion DVD VCD DivX**

1. Press PAUSE/STEP (II) during playback.  
The DVD player will now go into PAUSE mode.
2. Use ◀◀ or ▶▶ to select the required speed: ◀◀ 1/16, ◀◀ 1/8, ◀◀ 1/4, or ◀◀ 1/2 (backward), or ▶▶ 1/16, ▶▶ 1/8, ▶▶ 1/4, or ▶▶ 1/2 (forward).  
With a Video CD, the Slow speed changes: ▶▶ 1/16, ▶▶ 1/8, ▶▶ 1/4 or ▶▶ 1/2 (forward).
3. To exit Slow Motion mode, press PLAY.

**Note:**

Slow motion playback in reverse is not possible with Video CDs and DivX Discs.

**Random VCD Karaoke DVD**

1. Press RANDOM during playback or in stop mode.  
The unit automatically begins random playback and RANDOM appears on the TV screen.
2. Press RANDOM again to normal.

**Tip:**

By pressing SKIP (▶▶) during random playback, the unit selects another title (track) and resumes random playback.

**Note:**

On a Video CD with PBC, You must set PBC to Off on the setup menu to use the random function (See "PBC" on page 21).

**Repeat A-B DVD VCD DivX**

To repeat a sequence.

1. Press A-B at your chosen starting point. "A \* " appears briefly on the TV screen.
2. Press A-B again at your chosen end point.  
"A B" appears briefly on the TV screen and the repeat sequence begins.
3. Press A-B again to cancel.

**Repeat DVD VCD DivX**

You can play a title/chapter/all/track on a disc. Press REPEAT during playback to select a desired repeat mode.

**DVD Video Discs - Repeat Chapter/Title/Off**

- Chapter: repeats the current chapter.
- Title: repeats the current title.
- Off : does not play repeatedly.

**Video CDs - Repeat Track/All/Off**

- Track : repeats the current track
- All : repeats all the tracks on a disc.
- Off : does not play repeatedly.

**Notes:**

- On a Video CD with PBC, you must set PBC to Off on the setup menu to use the repeat function (See "PBC" on page 21).
- If you press SKIP (▶▶) once during Repeat Chapter (Track) playback, the repeat playback cancels.

**3D Surround DVD VCD DivX**

To produce a 3D surround effect that simulates multi-channel audio from two stereo speakers (instead of the five+ speakers normally required for multi-channel audio from a home theater system).

1. Press DISPLAY during playback.
2. Use ▲ or ▼ to select the sound option.  
The sound option will be highlighted.
3. Use ◀ or ▶ to select "3D SUR".  
To turn off the 3D Surround effect, select "Normal".

**Time Search DVD VCD DivX**

To start playing at any chosen time on the disc:

1. Press DISPLAY during playback. The time search box shows the elapsed playing time.
2. Press ▲ / ▼ to select the time clock icon and "--:--" appears.
3. Input the required start time in hours, minutes, and seconds from left to right. If you enter the wrong numbers, press CLEAR to remove the numbers you entered. Then input the correct numbers.
4. Press ENTER to confirm. Playback starts from the selected time.

## Zoom **DVD** **VCD** **DivX**

Use zoom to enlarge the video image.

1. Press ZOOM during playback or still playback to activate the Zoom function. The square frame appears briefly in the right bottom of the picture.
2. Each press of the ZOOM button changes the TV screen in the sequence: 100% size → 400% size → 1600% size → screen fit mode → 100% size  
Screen fit mode:  
You can change the way the image appears on the screen when you're playing a DVD movie. Press ▲/▼ to select between Normal, Enhanced, and Maximum.
3. Use the ◀▶▲▼ buttons to move through the zoomed picture.
4. To resume normal playback, press ZOOM repeatedly or press CLEAR button.

### Notes:

- Zoom may not work on some DVDs.
- Screen fit mode is available for playing the DVD disc, VR disc and movie file.

## Marker Search **DVD** **VCD** **DivX**

### To enter a Marker

You can start playback from up to nine memorized points. To enter a marker, press MARKER at the desired point on the disc. The Marker icon appears on the TV screen briefly. Repeat to enter up to nine markers.

### To Recall or Clear a Marked Scene

1. During disc playback, press SEARCH. The marker search menu appears on the screen.
2. Within 10 seconds, press ◀ / ▶ to select a marker number that you want to recall or clear.
3. Press ENTER and playback starts from the marked scene. Or, press CLEAR and the marker number is erased from the list.
4. You can play any marker by inputting its number on the marker search menu.

## Special DVD Features

### Checking the contents of DVD discs: Menus

DVDs may offer menus that allow you to access special features. To use the disc menu, press DISC MENU. Input the corresponding number or use the ◀▶▲▼ buttons to highlight your selection. Then press ENTER.

### Title Menu **DVD**

1. Press TITLE. If the current title has a menu, the menu appears on the screen. Otherwise, the disc menu may appear.
2. The menu offers features such as camera angles, spoken language and subtitle options, and chapters for the title.
3. Press TITLE to exit.

### Disc Menu **DVD**

Press DISC MENU and the disc menu is displayed. Press DISC MENU again to exit.

### Camera Angle **DVD**

If the disc contains scenes recorded at different camera angles, you can change to a different camera angle during playback. Press ANGLE repeatedly during playback to select a desired angle. Note that the number of the current angle appears on the display.

### Changing the Audio Language **DVD** **DivX**

Press AUDIO repeatedly during playback to hear a different audio language or audio track. With DVD-RW discs recorded in VR mode that have both a main and a Bilingual audio channel, you can switch between Main (L), Bilingual (R), or a mix of both (Main + Bilingual) by pressing AUDIO.

### Subtitles **DVD** **DivX**

Press SUBTITLE repeatedly during playback to see the different subtitle languages.

### Note:

- The subtitle file of the DivX file is displayed only smi, srt and sub.
- If there is no information or there is a code that can not read in the DivX file, " 1 " or etc. are displayed.

## Playing an Audio CD or MP3/WMA Disc

The DVD player can play MP3/WMA formatted recordings on CD-ROM, CD-R, or CD-RW discs.

### Audio CD

Once you insert an audio CD a menu appears on the TV screen. Press ▲ / ▼ to select a track then press PLAY or ENTER and playback starts.



### MP3 / WMA

1. Press ▲ / ▼ to select a folder, and press ENTER to see the folder contents.
2. Press ▲ / ▼ to select a track then press PLAY or ENTER. Playback starts.



### Tip:

- If you are in a file list on the MUSIC menu and want to return to the Folder list, use the ▲ / ▼ to highlight  and press ENTER.
- Press DISC MENU to move to the next page.
- On a CD with MP3/WMA and JPEG you can switch MP3/WMA and JPEG. Press TITLE and MUSIC or PHOTO word on top of the menu is highlighted.
- When playing a file containing information such as track titles, you can see the information by pressing DISPLAY.

### MP3 / WMA disc compatibility with this player is limited as follows:

- Sampling frequency: within 8 - 48 kHz (MP3), within 32 - 48kHz (WMA)
- Bit rate: within 8 - 320kbps (MP3), 32 - 192kbps (WMA)
- The player cannot read an MP3/WMA file that has a file extension other than “.mp3” / “.wma”.
- CD-R physical format should be ISO 9660
- If you record MP3 / WMA files using software that cannot create a file system (eg. Direct-CD) it is impossible to playback MP3 / WMA files. We recommend that you use Easy-CD Creator, which creates an ISO 9660 file system.
- File names should have a maximum of 8 letters and must incorporate an .mp3 or .wma extension.
- They should not contain special letters such as / ? \* : “ < > | etc.
- The total number of files on the disc should be less than 650.

This DVD player requires discs and recordings to meet certain technical standards in order to achieve optimal playback quality. Pre-recorded DVDs are automatically set to these standards. There are many different types of recordable disc formats (including CD-R containing MP3 or WMA files) and these require certain pre-existing conditions (see above) to ensure compatible playback.

**Customers should note that permission is required in order to download MP3 / WMA files and music from the Internet. Our company has no right to grant such permission. Permission should always be sought from the copyright owner.**

## Audio CD and MP3 / WMA Disc Features

### Pause **CD** **MP3** **WMA**

1. Press PAUSE/STEP during playback.
2. To return to playback, press PLAY, ENTER or press PAUSE/STEP again.

### Moving to another Track **CD** **MP3** **WMA**

1. Press SKIP (I◀◀ or ▶▶I) briefly during playback to go to the next track or to return to the beginning of the current track.
2. Press SKIP I◀◀ twice briefly to go back to the previous track.
3. In case of audio CD, to go directly to any track, enter the track number using the numbered buttons (0-9).

### Repeat Track/All/Off **CD** **MP3** **WMA**

You can play a track/all on a disc.

1. Press REPEAT when playing a disc. The repeat icon appears.
2. Press REPEAT to select a desired repeat mode.
  - Track: repeats the current track
  - All: repeats all the tracks on a disc.
  - Off(No display): does not play repeatedly.

#### **Note:**

If you press SKIP (▶▶I) once during Repeat Track playback, the repeat playback cancels.

### Search **CD** **MP3** **WMA**

1. Press ◀◀ or ▶▶ during playback.
2. Press ◀◀ or ▶▶ repeatedly to select the required speed: X2, X4, X8 backward or forward.
3. To exit SEARCH mode, press PLAY.

### Random **CD** **MP3** **WMA**

1. Press RANDOM during playback or when playback is stopped. Random Playback begins immediately and RANDOM appears on the menu screen.
2. To return to normal playback, press RANDOM repeatedly until RANDOM disappears from the menu screen.

#### **Tip:**

By pressing SKIP ▶▶I during random playback, the unit selects another track and resumes random playback.

### Repeat A-B **CD**

1. To repeat a sequence during disc playback press A-B at your chosen starting point. The Repeat icon and "A" appear on the menu screen.
2. Press A-B again at your chosen end point. The Repeat icon and "A-B" appear on the menu screen, and the sequence begins to play repeatedly.
3. To exit the sequence and return to normal play, press A-B again. The Repeat icon disappears from the menu screen.

### 3D Surround **CD**

To produce a 3D surround effect that simulates multi-channel audio from two stereo speakers (instead of the five+ speakers normally required for multi-channel audio from a home theater system).

1. Press AUDIO during playback. "3D SUR." appears on the menu screen.
2. To return to normal playback, press AUDIO repeatedly until "3D SUR." disappears from the menu screen.

## Programmed Playback

The program function enables you to store your favorite tracks from any disc in the player memory. A program can contain 30 tracks.

1. Insert a disc.

### Audio CD or MP3/WMA Discs:

AUDIO CD or MUSIC menu appears.

2. Press PROGRAM.  
The ● mark will appear to the right of the word "Program" on the right side of the menu screen.

### Note:

Press PROGRAM again, then the ● mark will disappear to exit the Program Edit mode.

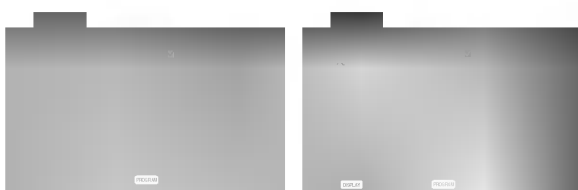

Audio CD Menu

MP3/WMA Menu

**Video CD:** Press PROGRAM while playback is stopped. The program menu appears. Press PROGRAM to exit the menu.

### Note:

On a Video CD with PBC, you must set PBC to Off on the setup menu to use the programmed playback (See "PBC" on page 21).

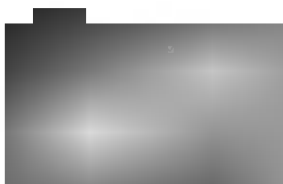

Video CD Menu

3. Select a track on the "List", then press ENTER to place the selected track on the "Program" list. Repeat to place additional tracks on the list.
4. Press ►.  
Select the track you want to start playing on the "Program" list.
5. Press PLAY or ENTER to start. Playback begins in the order in which you programmed the tracks. Playback stops after all of the tracks on the "Program" list have played once.
6. To resume normal playback from programmed playback, select a track of CD (or MP3/WMA) list and then press PLAY.

## Repeat Programmed Tracks

1. Press REPEAT when playing a disc. The repeat icon appears.
2. Press REPEAT to select a desired repeat mode.
  - Track: repeats the current track
  - All: repeats all the tracks on programmed list.
  - Off(No display): does not play repeatedly.

### Note:

If you press SKIP (▶▶) once during Repeat Track playback, the repeat playback cancels.

## Erasing a Track from Program List

1. Video CD : Press PROGRAM in the stop mode to enter Program Edit mode.
2. Press ► to move to the "Program" list.
3. Use ▲/▼ to select the track that you wish to erase from the "Program" list.
4. Press CLEAR. Repeat to erase additional tracks on the list.

## Erasing the Complete Program List

1. Follow steps 1-2 of "Erasing a Track from Program List" as above.
2. Use ▲/▼ to select "Clear All", then press ENTER. The complete Program for the disc will be erased.

### Note:

The programs are also cleared when the disc is removed.

## Viewing a JPEG Disc

Using this DVD Player you can view Kodak PICTURE CDs and discs with JPEG files.

1. Insert a disc and close the tray. The PHOTO menu appears on the TV screen.



2. Press ▲ / ▼ to select a folder, and press ENTER. A list of files in the folder appears. If you are in a file list and want to return to the previous Folder list, use the ▲ / ▼ buttons on the remote to highlight and press ENTER.
3. If you want to view a particular file, press ▲ / ▼ to highlight a file and press ENTER or PLAY. Viewing the file proceeding starts. While viewing a file, you can press STOP to move to the previous menu (PHOTO menu). Press DISC MENU to move to the next page.

### Slide Show

Use ▲ ▼ ◀ ▶ to highlight the (Slide Show) then press ENTER.

#### Tip:

- There are three Slide Speed options : >>> (Fast), >> (Normal) and > (Slow).
- On a disc with MP3/WMA and JPEG you can switch MP3/WMA and JPEG. Press TITLE and MUSIC or PHOTO word on top of the menu is highlighted.
- Press RETURN, information of file is hidden.

### Still Picture

1. Press PAUSE/STEP during slide show. The player will now go into PAUSE mode.
2. To return to the slide show, press PLAY or press PAUSE/STEP again.

### Moving to another File

Press SKIP (◀◀ or ▶▶) or cursor (◀ or ▶) once while viewing a picture to advance to the next or previous file.

### Zoom

Use zoom to enlarge the photo image. (see 28 page)

### To rotate picture

Press ▲ / ▼ during showing a picture to rotate the picture clockwise or counter clockwise.

### To listen to MP3/WMA music watching picture

You can display files while listening to MP3/WMA music files recorded on the same disc.

1. Insert the disc containing the two types of file in the player.
2. Press TITLE to display PHOTO menu.
3. Press ▲ / ▼ to select a photo file.
4. Use ▶ / ▼ to select icon then press ENTER. Playback starts. The playback will continue until STOP is pressed.

#### Tip:

To listen to only the desired music watching picture, programmed the desired tracks from the "MUSIC" menu and then proceed as above.

#### JPEG disc compatibility with this player is limited as follows:

- Depending upon the size and number of JPEG files, it could take a long time for the DVD player to read the disc's contents. If you don't see an on-screen display after several minutes, some of the files may be too large — reduce the resolution of the JPEG files to less than 2M pixels as 2760 x 2048 pixels and burn another disc.
- The total number of files and folders on the disc should be less than 650.
- Some discs may be incompatible due to a different recording format or the condition of disc.
- Ensure that all the selected files have the ".jpg" extensions when copying into the CD layout.
- If the files have ".jpe" or ".jpeg" extensions, please rename them as ".jpg" file.
- File names without ".jpg" extension will not be able to be read by this DVD player. Even though the files are shown as JPEG image files in Windows Explorer.

## Playing a DVD VR format Disc

This unit will play DVD-R/RW discs recorded using the DVD-Video format that have been finalized using a DVD-recorder.

- This unit will play DVD-RW discs recorded using the Video Recording (VR) format.
1. Insert a disc and close the tray. The DVD-VR menu appears on the TV screen.



2. Press ▲ / ▼ to select a track then press PLAY or ENTER and playback starts.
3. Press TITLE to move to the list menu.

### Note:

- Unfinalized DVD-R/RW discs cannot be played in this player.
- Some DVD-VR disc are made with CPRM data by DVD RECORDER. Player does not support these kinds of discs.

### What is 'CPRM'?

CPRM is a copy protection system (with scramble system) only allowing the recording of 'copy once' broadcast programs. CPRM stands for Content Protection for Recordable Media.

This player is CPRM compatible, which means that you can record copy-once broadcast programs, but you cannot then make a copy of those recordings. CPRM recordings can only be made on DVD-RW discs formatted in VR mode, and CPRM recordings can only be played on players that are specifically compatible with CPRM.

## Maintenance and Service

Refer to the information in this chapter before contacting a service technician.

### Handling the Unit

#### When shipping the unit

Please save the original shipping carton and packing materials. If you need to ship the unit, for maximum protection, re-pack the unit as it was originally packed at the factory.

#### Keeping the exterior surfaces clean

- Do not use volatile liquids such as insecticide spray near the unit.
- Do not leave rubber or plastic products in contact with the unit for a long period of time. since they leave marks on the surface.

#### Cleaning the unit

To clean the player, use a soft, dry cloth. If the surfaces are extremely dirty, use a soft cloth lightly moistened with a mild detergent solution.

Do not use strong solvents such as alcohol, benzene, or thinner, as these might damage the surface of the unit.

#### Maintaining the Unit

The DVD player is a high-tech, precision device. If the optical pick-up lens and disc drive parts are dirty or worn, the picture quality could be diminished.

Depending on the operating environment, regular inspection and maintenance are recommended after every 1,000 hours of use.

For details, please contact your nearest authorized service center.

## Playing a DivX Movie Disc

Using this DVD Player you can play DivX disc.

1. Insert a disc and close the tray. The MOVIE menu appears on the TV screen.

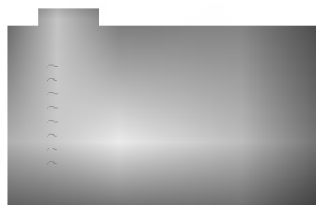

2. Press ▲ / ▼ to select a folder, and press ENTER. A list of files in the folder appears. If you are in a file list and want to return to the Folder list, use the ▲ / ▼ buttons on the remote to highlight [Back] and press ENTER.
3. If you want to view a particular file, press ▲ / ▼ to highlight a file and press ENTER or PLAY.
4. Press STOP to exit.

### Tip:

- Press DISC MENU to move to the next page.
- On a CD with MP3/WMA, JPEG and MOVIE file, you can switch MUSIC, PHOTO and MOVIE menu. Press TITLE and MUSIC, PHOTO and MOVIE word on top of the menu is highlighted.

**DivX disc compatibility with this player is limited as follows:**

- Available resolution size of the DivX file is under 720x576 (W x H) pixel.
- The file name of the DivX subtitle is available by 56 characters.
- If there is impossible code to express in the DivX file, it may be displayed as " \_ " mark on the display.
- **If the number of the screen frame is over 30 per 1 second, this unit may not operate normally.**
- **If the video and audio structure of recorded file is not interleaved, either video or audio is outputted.**
- **If the file is recorded with GMC, the unit supports only 1-point of the record level.**
  - \* GMC?  
GMC is the acronym for Global Motion Compensation. It is an encoding tool specified in MPEG4 standard. Some MPEG4 encoders, like DivX or Xvid, have this option. There are different levels of GMC encoding, usually called 1-point, 2-point, or 3-point GMC.

### Playable DivX file

- ".avi ", ".mpg ", ".mpeg "

### Playable Codec format

- "DIVX3.xx ", "DIVX4.xx ", "DIVX5.xx ", "XVID ", "MP43 ", "3IVX "

### Playable Audio format

- "AC3 ", "DTS ", "PCM ", "MP3 ", "WMA "
  - Sampling frequency: within 8 - 48 kHz (MP3), within 32 - 48kHz (WMA)
  - Bit rate: within 8 - 320kbps (MP3), 32 - 192kbps (WMA)

## Additional Features-VCR part

### On Screen Display

You may easily display the current time or tape counter, amount of tape left, day, month, year, day of week, programme channel, tape speed and operational mode of your VCR will appear on the TV screen. If a recording is taking place these On Screen Displays will not be recorded onto the tape.

1. Press **CLK/CNT** to display.  
Press **CLK/CNT** repeatedly to cycle through the display options. The tape counter and amount of tape left will appear if there is a tape loaded.
2. After 3 seconds the majority of the On Screen Displays will clear leaving only the clock or tape counter and the amount of tape left on the screen. Press **CLK/CNT** again to remove all displays from the TV screen.

### Tape Counter Memory Stop

The **Digital Tape Counter** can be displayed on the display window instead of the time by pressing **CLK/CNT** on the remote control. The Digital Tape Counter indicates the relative positions of recordings on the tape.

1. Press **CLK/CNT**.  
Press **CLEAR** to set the counter to 0:00:00.  
Press **PLAY** or start recording.  
The tape counter will display the actual play time in hours, minutes and seconds.
2. Press **STOP** when playback or recording is complete.  
Press **BACKWARD**.  
The tape will rewind and automatically stop when the counter returns to 0:00:00.

### Lock (Child Lock)

The control buttons on the front of the unit can be switched off so that your unit can only be operated using the remote control.

1. Press **LOCK**.  
**ON** and **SAFE** will appear in the display window. None of the buttons on the front of your unit will work.  
If any buttons on the front of your unit are pressed **SAFE** will flicker in the display window for a few seconds.
2. Press **LOCK** again to switch off the child lock.  
**ON** will disappear in the display window.

### Video Doctor (Self-Diagnosis)

This feature informs you that there is a problem with your VCR. These error messages will appear on the TV screen.

1. Press **i**.  
Press **◀** or **▶** to select **Dr.**  
Press **OK**.

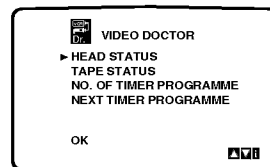
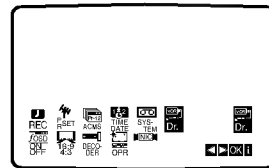

2. Press **▲** or **▼** to check a problem.
  - HEAD STATUS**
    - **PLEASE CLEAN:**  
Clean your video heads.
  - TAPE STATUS**
    - **NOT RECORDABLE:**  
Insert a tape with its protection tab in place
  - NO. OF TIMER PROGRAMME**
    - **2**  
Shows the number of timer recording.
  - NEXT TIMER PROGRAMME**
    - **PR-01 26 10:00~11:00 SP**  
Shows the current status of timer recording.
3. Press **i**.

## Hi-Fi Stereo Sound System

Your VCR will record and playback Hi-Fi stereo sound. In addition it has a stereo NICAM digital stereo sound decoder. This allows you to record and playback the sound in several different ways. Video cassettes recorded on your VCR will have a normal mono audio track and two VHS Hi-Fi stereo audio tracks. These stereo tracks allow you to make audio recordings in Hi-Fi stereo or bilingual mode from a TV broadcast, stereo audio system, video disc or another Hi-Fi VCR.

1. Your VCR's NICAM digital sound decoder allows you to enjoy broadcasts with NICAM sound, as well as standard stereo, bilingual and mono sound. The particular type of sound received or that recorded will be briefly displayed on the TV screen for a couple of seconds:

### STEREO NICAM

Sound is automatically recorded on the Hi-Fi stereo and mono tracks of the video tape.

### BIL NICAM

Both audio channels will be recorded on the Hi-Fi stereo tracks. The primary language channel (left) will be recorded on the mono track of the video tape.

### MONO

The sound is recorded on the Hi-Fi tracks and the mono track of the video tape without any separation.

2. Press **AUDIO** repeatedly until the desired audio mode appears.
3. The choice is **STEREO**, **LEFT**, **RIGHT** and **MONO**. In **BIL NICAM** playback the primary language is output on the left channel and the secondary channel is output simultaneously from the right channel when audio output is set to **STEREO**. The primary language will be output from both channels when the audio setting is **MONO**. Please note that when adjusting the tracking control Hi-Fi stereo sound may revert to **MONO**.

## Wide Screen Compatibility 16:9

Your VCR can record and play back wide screen aspect ratio programmes (16:9). To record a wide screen format programme successfully the correct type of wide screen signal must be broadcast by the TV station.

1. Switch on your VCR.  
Press **i**.  
Press **◀** or **▶** to select **16:9/4:3**.  
Press **OK**.

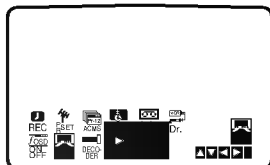
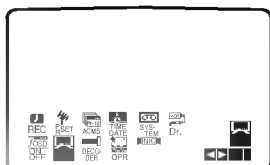

2. Press **▲** or **▼** repeatedly to select: **AUTO**, **4:3** or **16:9**.  
**AUTO:**  
Automatically plays back Wide-Screen programmes as Wide-Screen and Normal programmes as normal.  
**4:3**  
Only for playing back and recording Normal format recordings (4:3).  
**16:9:**  
Only for playing back and recording Wide-Screen format recordings (16:9).

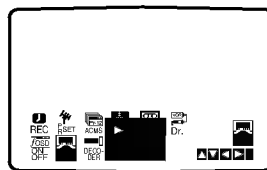

3. Press **i** to remove the menus from the TV screen. To enjoy Wide-Screen playback you must connect your VCR to the TV using a SCART cable.

## To set the decoder

We have already described, how to connect a decoder for pay-TV station as CANAL+ or PREMIERE on page 10. For the recording of an encoded station you do not have to control anything. You just select the station and wait shortly until the decoding will start.

1. Press **i**.  
The main menu will appear on the TV screen.  
Press **◀** or **▶** to select the **DECODER**.  
Press **OK**.
2. Press **▲** or **▼** to select.  
**ON:** When the decoder is connected to the AV2 socket.  
**OFF:** When another VCR is connected to the AV2 socket.
3. Press **i** to return to a TV picture.

## Additional Features

### Last Scene Memory

**DVD** **CD** **VCD**

This player memorizes last scene from the last disc that is viewed. The last scene remains in memory even if you remove the disc from the player or switch off the player. If you load a disc that has the scene memorized, the scene is automatically recalled.

#### Note:

This player does not memorize the scene of a disc if you switch off the player before commencing to play the disc.

### Screen Saver

The screen saver appears when you leave the DVD player in Stop mode for about five minutes.

### Video Mode Setting

**DVD** **VCD**

- With certain discs, the playback picture may be flickering or Dot Crawl is shown on straight lines. That means Vertical interpolation or De-interlace is not perfectly matched with the disc. In this case, the picture quality may be improved by changing the video mode.
- To change the video mode, press and hold DISPLAY about 3 seconds during disc playback. The new video mode number selected is displayed on the TV screen. Check whether the video quality has improved. If not, repeat the above procedure until picture quality is improved.
- Video mode sequence:  
MODE1 → MODE2 → MODE3 → MODE1
- If you turn off the power, the video mode will return to initial default state (MODE1).

### Detailed Description of each Video Mode

**MODE1** : The source material of the DVD video (film material or video material) is determined from disc information.

**MODE2** : Suitable for playing film based content or video based material recorded by the progressive scan method.

**MODE3** : Suitable for playing video based content with comparatively little motion.

#### Note:

The video mode setting only works when the Progressive Scan mode is set to "On" on the setup menu.

### Controlling other TVs with the remote control

You can control the sound level, input source, and power switch of your LG TV with the supplied remote control.

You can control the sound level, input source, and power switch of non-LG TVs as well. If your TV is listed in the table below, set the appropriate manufacturer code.

1. While holding down TV POWER button, press the number buttons to select the manufacturer code for your TV (see the table below).
2. Release TV POWER button.

### Code numbers of controllable TVs

If more than one code number is listed, try entering them one at a time until you find the one that works with your TV.

Manufacturer	Code Number
LG / GoldStar	1 (Default), 2
Zenith	1, 3, 4
Samsung	6, 7
Sony	8, 9
Hitachi	4

#### Note:

- Depending on your TV, some or all buttons may not function on the TV, even after entering the correct manufacturer code.
- If you enter a new code number, the code number previously entered will be erased.
- When you replace the batteries of the remote, the code number you have set may be reset to the default setting. Set the appropriate code number again.

## Copying from DVD To VCR

This unit allows you to copy the contents of a DVD to a VHS tape with a press of the COPY button.

### Notes:

- Be sure to set "Progressive Scan" to "Off" on the setup menu.
- If the DVD you are attempting to copy is copy protected, you may not be able to copy the disc.

#### 1. Insert Disc

Insert the disc you wish to copy in the DVD deck and close the disc tray.

#### 2. Insert VHS Tape

Insert a blank VHS videotape into the VCR deck.

#### 3. Copy the DVD to VHS Tape

Press the COPY button on the unit front panel or press the REC/ITR button.

- The DVD will go into Play mode and the VCR will go into Record mode.
- If the DVD disc menu appears, you may need to press the Play button manually to begin copying.

### Note:

If you press the REC/ITR button, be sure this unit is in DVD mode.

#### 4. Stop the Copy Process

When the DVD is finished playing, press STOP to end the copy.

- You must stop the Copy process manually when the DVD movie ends, or the unit may replay and record over and over again.

## Recording from another video recorder

With this video recorder you can make recordings from an external source, such as copying from another video recorder or a camcorder.

### Note:

In the following description, this video recorder will be one used for recording and will be referred to as VCR B. The other appliance will be used for playback and will be referred to as VCR A.

1. VCR A should be connected to the SCART socket on the rear panel of your unit or the AV sockets on the front panel of your unit.

2. Insert the recorded tape into VCR A and a blank tape into VCR B.

3. Press **AV** until the socket you wish to record from is displayed. (VCR B)

**AV 1** for recording from EURO AV1 SCART socket on the rear of your unit.

**AV 2** for recording from EURO AV2 SCART socket on the rear of your unit.

**AV 3** for recording from VIDEO IN and AUDIO IN (Left & Right) sockets on the front of your unit.

4. To start recording, press the REC/ITR on VCR B and PLAY on VCR A.

5. When you want to finish copying, press the STOP on both video recorders.

# Reference

## Language Codes

Use this list to input your desired language for the following initial settings:  
Disc Audio, Disc Subtitle, Disc Menu.

Language	Code	Language	Code	Language	Code	Language	Code
Abkhazian	6566	Fiji	7074	Lingala	7678	Singhalese	8373
Afar	6565	Finnish	7073	Lithuanian	7684	Slovak	8375
Afrikaans	6570	French	7082	Macedonian	7775	Slovenian	8376
Albanian	8381	Frisian	7089	Malagasy	7771	Somali	8379
Ameharic	6577	Galician	7176	Malay	7783	Spanish	6983
Arabic	6582	Georgian	7565	Malayalam	7776	Sudanese	8385
Armenian	7289	German	6869	Maltese	7784	Swahili	8387
Assamese	6583	Greek	6976	Maori	7773	Swedish	8386
Aymara	6588	Greenlandic	7576	Marathi	7782	Tagalog	8476
Azerbaijani	6590	Guarani	7178	Moldavian	7779	Tajik	8471
Bashkir	6665	Gujarati	7185	Mongolian	7778	Tamil	8465
Basque	6985	Hausa	7265	Nauru	7865	Tatar	8484
Bengali; Bangla	6678	Hebrew	7387	Nepali	7869	Telugu	8469
Bhutani	6890	Hindi	7273	Norwegian	7879	Thai	8472
Bihari	6672	Hungarian	7285	Oriya	7982	Tibetan	6679
Breton	6682	Icelandic	7383	Panjabi	8065	Tigrinya	8473
Bulgarian	6671	Indonesian	7378	Pashto, Pushto	8083	Tonga	8479
Burmese	7789	Interlingua	7365	Persian	7065	Turkish	8482
Byelorussian	6669	Irish	7165	Polish	8076	Turkmen	8475
Cambodian	7577	Italian	7384	Portuguese	8084	Twi	8487
Catalan	6765	Japanese	7465	Quechua	8185	Ukrainian	8575
Chinese	9072	Javanese	7487	Rhaeto-Romance	8277	Urdu	8582
Corsican	6779	Kannada	7578	Rumanian	8279	Uzbek	8590
Croatian	7282	Kashmiri	7583	Russian	8285	Vietnamese	8673
Czech	6783	Kazakh	7575	Samoan	8377	Volapük	8679
Danish	6865	Kirghiz	7589	Sanskrit	8365	Welsh	6789
Dutch	7876	Korean	7579	Scots Gaelic	7168	Wolof	8779
English	6978	Kurdish	7585	Serbian	8382	Xhosa	8872
Esperanto	6979	Laothian	7679	Serbo-Croatian	8372	Yiddish	7473
Estonian	6984	Latin	7665	Shona	8378	Yoruba	8979
Faroese	7079	Latvian, Lettish	7686	Sindhi	8368	Zulu	9085

## Country Codes

Choose a country code from this list.

Country	Code	Country	Code	Country	Code	Country	Code
Afghanistan	AF	Ethiopia	ET	Malaysia	MY	Saudi Arabia	SA
Argentina	AR	Fiji	FJ	Maldives	MV	Senegal	SN
Australia	AU	Finland	FI	Mexico	MX	Singapore	SG
Austria	AT	France	FR	Monaco	MC	Slovak Republic	SK
Belgium	BE	Germany	DE	Mongolia	MN	Slovenia	SI
Bhutan	BT	Great Britain	GB	Morocco	MA	South Africa	ZA
Bolivia	BO	Greece	GR	Nepal	NP	South Korea	KR
Brazil	BR	Greenland	GL	Netherlands	NL	Spain	ES
Cambodia	KH	Islands	HM	Netherlands Antilles	AN	Sri Lanka	LK
Canada	CA	Hong Kong	HK	New Zealand	NZ	Sweden	SE
Chile	CL	Hungary	HU	Nigeria	NG	Switzerland	CH
China	CN	India	IN	Norway	NO	Taiwan	TW
Colombia	CO	Indonesia	ID	Oman	OM	Thailand	TH
Congo	CG	Israel	IL	Pakistan	PK	Turkey	TR
Costa Rica	CR	Italy	IT	Panama	PA	Uganda	UG
Croatia	HR	Jamaica	JM	Paraguay	PY	Ukraine	UA
Czech Republic	CZ	Japan	JP	Philippines	PH	United States	US
Denmark	DK	Kenya	KE	Poland	PL	Uruguay	UY
Ecuador	EC	Kuwait	KW	Portugal	PT	Uzbekistan	UZ
Egypt	EG	Libya	LY	Romania	RO	Vietnam	VN
El Salvador	SV	Luxembourg	LU	Russian Federation	RU	Zimbabwe	ZW

## Troubleshooting

Check the following guide for the possible cause of a problem before contacting service.

Symptom	Cause	Correction
DVD or VCR do not work properly.	<ul style="list-style-type: none"> <li>DVD or VCR button is not switched properly.</li> </ul>	<ul style="list-style-type: none"> <li>Refer to page 2.</li> </ul>
No power.	<ul style="list-style-type: none"> <li>The power cord is disconnected.</li> </ul>	<ul style="list-style-type: none"> <li>Plug the power cord into the wall outlet securely.</li> </ul>
The power is on, but the DVD player does not work.	<ul style="list-style-type: none"> <li>No disc is inserted.</li> </ul>	<ul style="list-style-type: none"> <li>Insert a disc. (Check that the DVD or audio CD indicator in the display window is lit.)</li> </ul>
No picture.	<ul style="list-style-type: none"> <li>The TV is not set to receive DVD signal output.</li> </ul>	<ul style="list-style-type: none"> <li>Select the appropriate video input mode on the TV so the picture from the DVD player appears on the TV screen.</li> </ul>
	<ul style="list-style-type: none"> <li>The video cable is not connected securely.</li> </ul>	<ul style="list-style-type: none"> <li>Connect the video cable into the jacks securely.</li> </ul>
	<ul style="list-style-type: none"> <li>The Progressive Scan is set to "On" on the setup menu but is connected to a standard (analog) television.</li> </ul>	<ul style="list-style-type: none"> <li>Set Progressive Scan to "Off" (see page 19).</li> </ul>
No sound.	<ul style="list-style-type: none"> <li>The equipment connected with the audio cable is not set to receive DVD signal output.</li> </ul>	<ul style="list-style-type: none"> <li>Select the correct input mode of the audio receiver so you can listen to the sound from the DVD player.</li> </ul>
	<ul style="list-style-type: none"> <li>The audio cables are not connected securely.</li> </ul>	<ul style="list-style-type: none"> <li>Connect the audio cable into the jacks securely.</li> </ul>
	<ul style="list-style-type: none"> <li>The power of the equipment connected with the audio cable is turned off.</li> </ul>	<ul style="list-style-type: none"> <li>Turn on the equipment connected with the audio cable.</li> </ul>
	<ul style="list-style-type: none"> <li>The Digital Audio Output is set to the wrong position.</li> </ul>	<ul style="list-style-type: none"> <li>Set the Digital Audio Output to the correct position, then turn on the DVD player again by pressing POWER.</li> </ul>
The picture is poor.	<ul style="list-style-type: none"> <li>The disc is dirty.</li> <li>The TV channels are not tuned in properly.</li> </ul>	<ul style="list-style-type: none"> <li>Clean the disc.</li> <li>Check tuning, carry out tuning again.</li> </ul>
The DVD player does not start playback.	<ul style="list-style-type: none"> <li>An unplayable disc is inserted.</li> </ul>	<ul style="list-style-type: none"> <li>Insert a playable disc. (Check the disc type and Regional code.)</li> </ul>
	<ul style="list-style-type: none"> <li>The disc is placed upside down.</li> </ul>	<ul style="list-style-type: none"> <li>Place the disc with the playback side down.</li> </ul>
	<ul style="list-style-type: none"> <li>The disc is not placed within the guide.</li> </ul>	<ul style="list-style-type: none"> <li>Place the disc on the disc tray correctly inside the guide.</li> </ul>
	<ul style="list-style-type: none"> <li>The disc is dirty.</li> </ul>	<ul style="list-style-type: none"> <li>Clean the disc.</li> </ul>
	<ul style="list-style-type: none"> <li>The Rating level is set.</li> </ul>	<ul style="list-style-type: none"> <li>Cancel the Rating function or change the rating level.</li> </ul>
The remote control does not work properly.	<ul style="list-style-type: none"> <li>There is an obstacle in the path of the remote control and this unit.</li> </ul>	<ul style="list-style-type: none"> <li>Remove the obstacle.</li> </ul>
	<ul style="list-style-type: none"> <li>The batteries in the remote control are exhausted.</li> </ul>	<ul style="list-style-type: none"> <li>Replace the batteries with new ones.</li> </ul>
Video tape cannot be inserted.	<ul style="list-style-type: none"> <li>Is the cassette compartment empty?</li> </ul>	<ul style="list-style-type: none"> <li>Eject the tape in.</li> </ul>
No Hi-Fi sound	<ul style="list-style-type: none"> <li>Audio mode is not set properly.</li> </ul>	<ul style="list-style-type: none"> <li>Select "STEREO" by repeatedly pressing "AUDIO" on the remote control.</li> </ul>
No NICAM sound recording	<ul style="list-style-type: none"> <li>NICAM mode is not set properly.</li> </ul>	<ul style="list-style-type: none"> <li>Make sure NICAM in the menu is set to AUTO for the station to be recorded.</li> </ul>

### Video Head Cleaning

Whenever a video cassette is inserted into or ejected from your VCR the video head is automatically cleaned. This should mean that additional head cleaning should not be necessary.

However dirt accumulating on the head after a long period of time can cause the playback picture to become blurred or broken up. High quality video cassette tapes will not normally deposit dirt onto the video head, but old or damaged tapes might.

## Specification

### General

Power requirements	AC 110-240V, 50/60 Hz
Power consumption	19W
Dimensions (approx.)	430 X 78.5 X 270 mm (w/h/d)
Mass (approx.)	4.2 kg
Operating temperature	5°C to 35°C (41°F to 95°F)
Operating humidity	5 % to 90 %
Timer	24 hours display tape
RF Modulator	UHF 22 - 68 (Adjustable)

### System

Laser	Semiconductor laser, wavelength 650 nm
Video Head system	Double azimuth 6 heads, helical scanning.
Signal system	PAL
Frequency response	DVD (PCM 96 kHz): 8 Hz to 44 kHz DVD (PCM 48 kHz): 8 Hz to 22 kHz CD: 8 Hz to 20 kHz
Signal-to-noise ratio	More than 100dB (ANALOG OUT connectors only)
Harmonic distortion	Less than 0.008%
Dynamic range	More than 100 dB (DVD) More than 95 dB (CD)

### Inputs (VCR)

Audio	-6.0dBm, more than 10 kohms (SCART) -6.0dBm, more than 47 kohms (RCA)
Video	1.0 Vp-p, 75 ohms, unbalanced (SCART/RCA)

### Outputs (DVD)

VIDEO OUT	1 Vp-p 75 ohms, sync negative
S-VIDEO OUT	(Y) 1.0 Vp-p 75 ohms, negative sync., Mini Din 4-pin x 1 (C) 0.3 Vp-p 75 ohms
COMPONENT VIDEO OUT (Progressive Scan)	(Y) 1.0 V (p-p), 75 Ω, negative sync, RCA jack x 1 (Pb)/(Pr) 0.7 V (p-p), 75 Ω, RCA jack x 2
RGB output	0.7 Vp-p, 75 ohms
Audio output (digital audio)	0.5 V (p-p), 75 Ω, RCA jack x 1
Audio output (optical audio)	3 V (p-p), 75 Ω, Optical connector x 1
Audio output (analog audio)	2.0 Vrms (1 KHz, 0 dB), 600 Ω, RCA jack (L, R)x2/SCART (TO TV)

### Outputs (VCR)

Audio	-6.0dBm, less than 1 kohms (SCART)
Video	1.0Vp-p, 75 ohms, unbalanced (SCART)
RGB output	0.7 Vp-p, 75 ohms

- Design and specifications are subject to change without notice.

Manufactured under license from Dolby Laboratories. "Dolby", "Pro Logic", and the double-D symbol are trademarks of Dolby Laboratories.

"DTS" and "DTS Digital Out" are trademarks of Digital Theater Systems, Inc.



P/NO : 3834RV0025L