



STEREO CD CAR RECEIVER



OWNER'S MANUAL

MODEL : TCH-M900/M901

To fully enjoy the features and functions of this new unit,
we recommend that you read this **OWNER'S MANUAL**
carefully and completely.



Precautions

	CAUTION RISK OF ELECTRIC SHOCK DO NOT OPEN	
<p>CAUTION: TO REDUCE THE RISK OF ELECTRIC SHOCK DO NOT REMOVE COVER (OR BACK) NO USER SERVICEABLE PARTS INSIDE. REFER SERVICING TO QUALIFIED SERVICE PERSONNEL.</p>		

Explanation Graphical Symbols:



The lightning flash with arrowhead symbol, within an equilateral triangle is intended to alert the user to the presence of uninsulated dangerous voltage within the product's enclosure that may be of sufficient magnitude to constitute a risk of electric shock to persons.



The exclamation point within an equilateral triangle is intended to alert the user to the presence of important operating and maintenance (servicing) instructions in the literature accompanying the appliance.

WARNING

TO REDUCE THE RISK OF FIRE OF ELECTRIC SHOCK, DO NOT EXPOSE THIS APPLIANCE TO RAIN OR MOISTURE. To avoid electrical shock, do not open the cabinet, Refer servicing to qualified personnel only.

CAUTION

Use of controls or adjustments or performance of procedures other than those specified here in may result in hazardous radiation exposure.

Laser component in this product is capable of emitting radiation exceeding the limit for Class 1.

This label is located on the interior.

CAUTION: INVISIBLE LASER RADIATION WHEN OPEN AND INTERLOCKS DEFEATED. AVOID EXPOSURE TO BEAM.

WARNING: OSYNLIG LASERSTRÅLNING NÄR DENNA DEL ÄR ÖPPNAD STRÅLEN ÄR FARLIG.

Attention: Quand l'appareil est ouvert, ne pas s'exposer aux radiations invisibles du faisceau laser.

CLASS 1	LASER PRODUCT
KLASSE 1	LASER PRODUKT
LUOKAN 1	LASER LAITE
KLASS 1	LASER APPARAT
CLASSE 1	PRODUIT LASER

This Compact Disc player is classified as a CLASS 1 LASER product. The CLASS 1 LASER PRODUCT label is located on the exterior.

The apparatus shall not be exposed to dripping or splashing and that no objects filled with liquids, such as vases, shall be placed on the apparatus.

Warning:

Do not install this equipment in a confined space such a book case or similar unit.

Before Use

- Do not attempt to disassemble this unit. Laser rays from the optical pickup are dangerous to the eyes.
- Make sure that pins or other foreign objects do not inside the unit; they may cause malfunctioning, or a safety hazard such as electrical shock or exposure of laser rays.
- When your car is parked under direct sunlight in summer, there may be a considerable rise in temperature inside the car. Ensure to let the ambient temperature cool down before operating the unit.
- This unit is designed to be operated on a 12 volt DC negative ground electrical system only.
- When replacing the fuse, be sure to use the fuse whose amperage rating is identical. Use of a fuse with higher amperage may cause serious damage to the unit.
- Periodically wipe the contacts on the back of the front panel with a cotton swap moistened with alcohol.

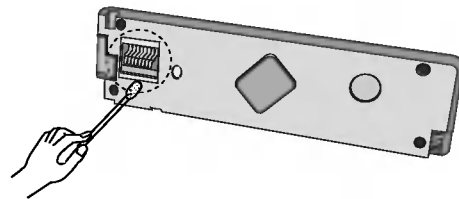

Notes on CD

- A defective or soiled disc inserted into unit can cause sound to drop out during playback.
- Handle the disc by holding its inner and outer edges.
- Do not touch the surface of the unlabeled side of the disc.



- Do not stick paper or tape etc. on the surface.



- Do not expose the disc to direct sunlight or excessive heat.

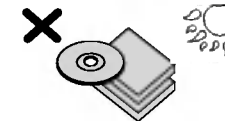

- Clean the disc before playback. Wipe the disc from the center outward with a cleaning cloth.
- Never use solvents such as benzine or alcohol to clean the disc.



- This unit cannot be operated by 8cm disc (using 12cm disc only).

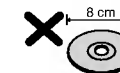

Table of Contents

INTRODUCTION

Precautions.....	2
Before Use.....	3
Table of Contents/Battery Installation	4
Remote control/Display Window.....	5
Front panel/Rear panel	6
Installation.....	7
Connection diagram.....	8
Connection	9
Detachable Front Panel	10

OPERATION

Basic operation	11-13
CD Basic Operation(CD/MP3 CD).....	14
CD Advanced Operation	15
Radio operation.....	16-17
CD changer Player(Optional).....	18-19

REFERENCE

Specifications	20
----------------------	----

Battery Installation

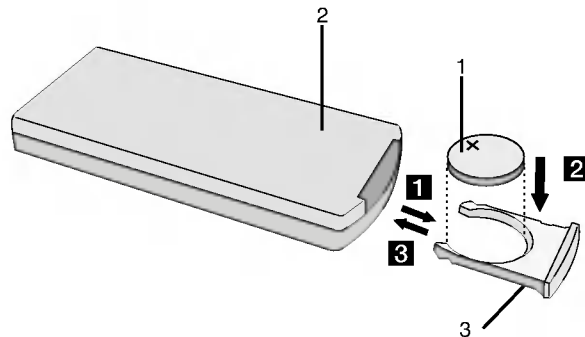

1. LITHIUM BATTERY (CR2025)
2. REMOTE CONTROL BACK SIDE
3. BATTERY HOLDER

Basic Installation

- 1** Remove the battery holder
- 2** Install the battery on the battery holder
- 3** Install the battery holder back into its original position

Notes

- Battery type : Lithium battery (CR2025)
- Battery life : Approximately 6 months with normal use

Remote Control

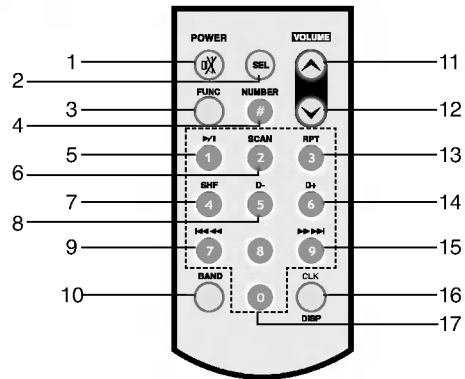

1. POWER (PWR) / MUTE button
2. SELECTION (SEL) button
3. FUNCTION (FUNC) button
4. NUMBER button
5. PLAY/PAUSE (▶/||) button
6. INTRO SCAN (SCAN) button
7. SHUFFLE (SHF) button
8. DISC SELECTOR (D-) button (Optional) MP3 TRACK -10 button
9. CD SKIP/SEARCH (◀◀ ◀) button SEEK/TUNE(-) button
10. BAND button
11. VOLUME UP button
12. VOLUME DOWN button
13. REPEAT (RPT) button
14. DISC SELECTOR (D+) button (Optional) MP3 TRACK +10 button
15. CD SKIP/SEARCH (▶▶ ▶▶) button SEEK/TUNE(+) button
16. CLOCL (CLK) button DISPLAY (DISP) button
17. NUMBER (0-9) button

Display Window

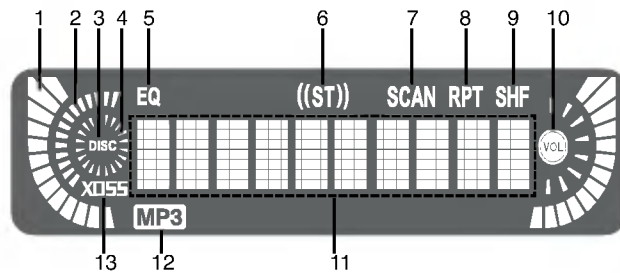

1. SIGNAL LEVEL indicator
2. TUNING indicator
3. DISC indicator
4. DISC PLAY indicator
5. EQUALIZER (EQ) indicator
6. STEREO indicator
7. INTRO SCAN (SCAN) indicator
8. REPEAT (RPT) indicator
9. SHUFFLE (SHF) indicator
10. VOLUME indicator
11. MAIN DISPLAY SECTION
12. MP3 indicator
13. XDSS indicator

Front Panel/Rear Panel

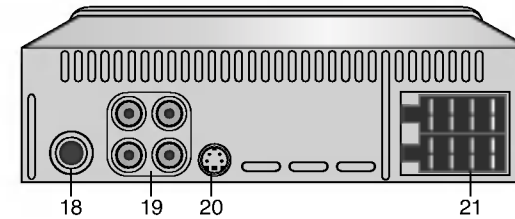
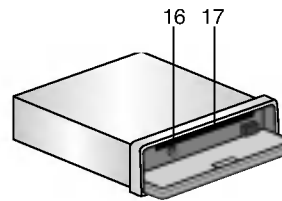
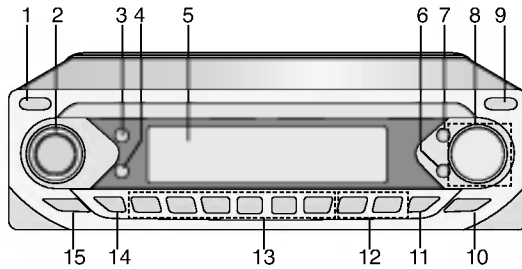

1. POWER (PWR) button
2. CONTROL UP/DOWN dial
3. SELECTION(SEL) button
4. FUNCTION (FUNC) button
5. DISPLAY WINDOW
6. DISPLAY (DISP) button
7. MUTE button
8. • CD SKIP (◀◀/▶▶) button
• SEEK (-/+) button
9. RELEASE (▲) button
10. XDSS button
11. AS/PS (auto store/preset scan) button

12. • CD SEARCH (◀◀/▶▶) button
• TUNE (-/+) button
13. • Preset Station buttons (1~6)
• CD PLAY/PAUSE (▶/||) button
• INTRO SCAN (SCAN) button
• REPEAT (RPT) button
• SHUFFLE (SHF) button
• DISC SELECTOR (D-/+) button (Optional)
• MP3 TRACK -10 /+10 (D-/+) button
14. BAND button
15. EQUALIZER(EQ) button
16. EJECT (▲) button

17. CD disc slot
18. ANTENNA JACK
19. LINE OUT JACK (Optional)
20. CD CHANGER JACK (Optional)
21. POWER/ SPEAKER CONNECTOR

Installation

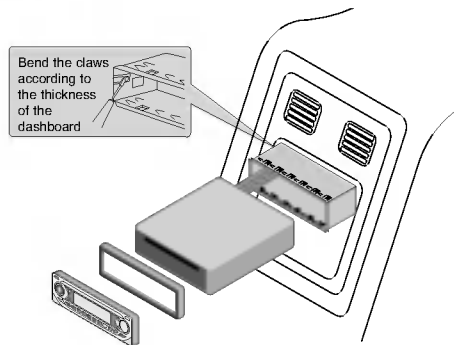

Basic Installation

Before installing, make sure that the ignition-switch is set to OFF and remove the terminal of the car battery to avoid short-circuiting.

- 1 Remove the existing receiver unit.
- 2 Make the necessary connections.
- 3 Install the installation sleeve.
- 4 Install the unit in to the installation sleeve.

Removing existing receiver unit

If there is already an installation sleeve for the receiver unit in the dashboard, it must be removed.

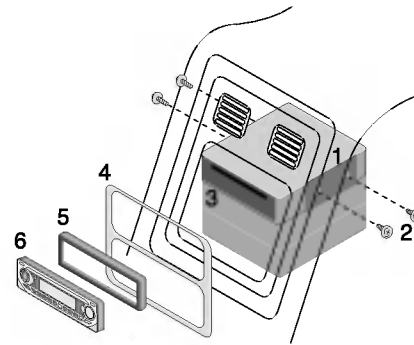

ISO-DIN Installation

- 1 Slide radio into ISO-DIN frame.
- 2 Install screws removed from old radio.
- 3 Slide radio and frame into dash opening.
- 4 Install dash panel or adapter plate.
- 5 Install trim ring to radio. The notch on trim ring must be positioned at the bottom.
- 6 Install faceplate by fitting right edge into position then pushing left edge closed.

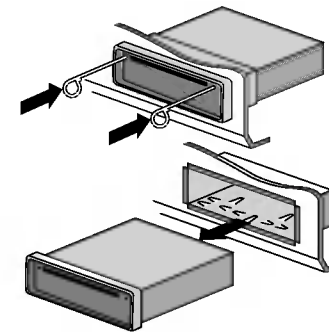

When removing the unit from the installation sleeve

If you need to remove the unit from the installation sleeve, proceed as follows.

- 1 Remove the rear supporter from the unit.
- 2 Remove the front panel from the unit.
- 3 Insert the lever into hole on one side of the unit, and pull the lever toward you. Do the same operation on the other side and pull out the unit from the installation sleeve.

Connection Diagram

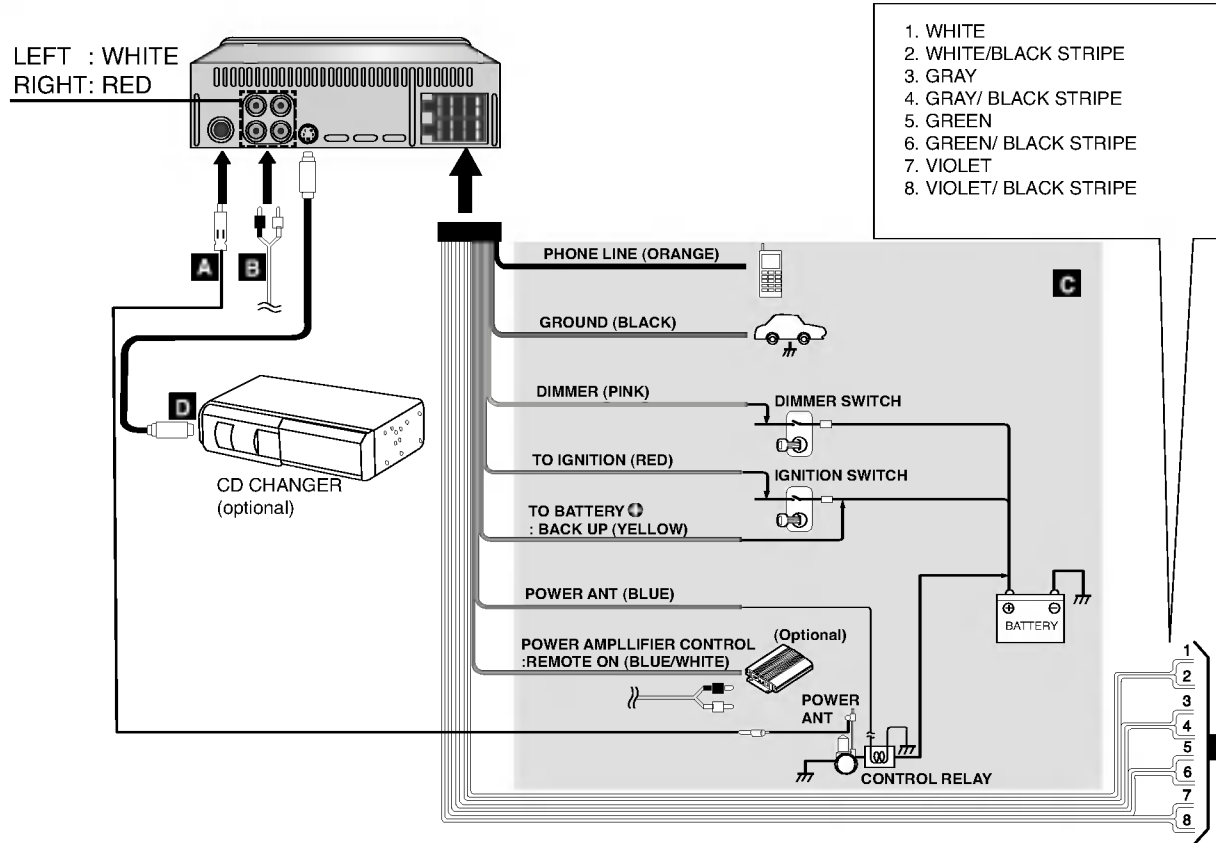

Connection

Precaution

Before connecting, make sure that ignition switch is set to OFF, and remove the \ominus terminal of the battery to avoid short circuits.

Notes

- Make correct connections as illustrated in the connection diagram.
- Never use the \ominus cord of each speaker in common.

A From antenna

B From power amplifier's input jack (2 channel or 4 channel Optional)

C To the wiring of vehicle Colors of leads

- **BLUE/WHITE** : This lead is for connection to the power amplifier (Remote on)
- **ORANGE** : This lead is for connection to the Phone line.
- **YELLOW** : This lead is for connection to the Battery (back-up) terminal from which the power is always supplied.
- **BLUE** : This lead is for connection to the full automatic power antenna. Power antenna load to be connected to

the terminal of the control relay switch for vehicles equipped with a power antenna.

This lead is not used for vehicles with manual or semiautomatic antennas.

- **PINK** : This lead is for connection to the Dimmer line
- **RED** : This lead is for connection to the terminal from which the power is supplied when the ignition switch is set to ACC.
- **BLACK** : This lead is for connection to the Ground.

D Connect the CD changer (optional)

- Your car receiver works as control unit for a CD changer which you can buy, if not yet done, later.
- The suitable cord shown on the scheme will be provided together with the CD changer.

2-Speaker Connections

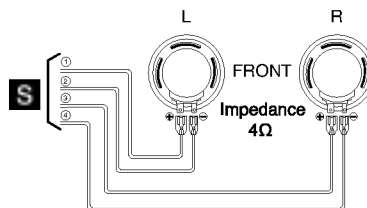

4-Speaker Connections

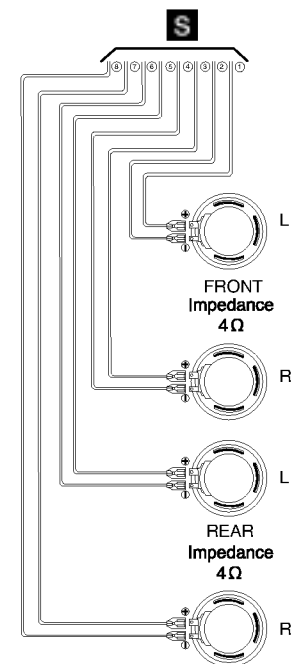

Detachable Front panel

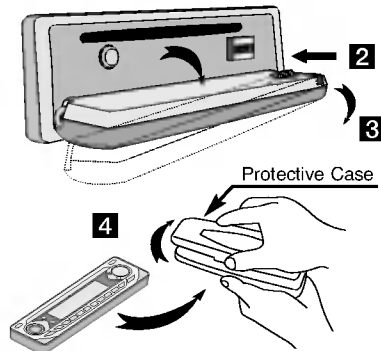

Detachable Front panel

The front panel of this unit can be detached to prevent theft.

- 1 Press the **RELEASE** () button to open the front panel.
- 2 Push the front panel to right.
- 3 Pull the front panel.
- 4 Place the front panel in the supplied protective case.

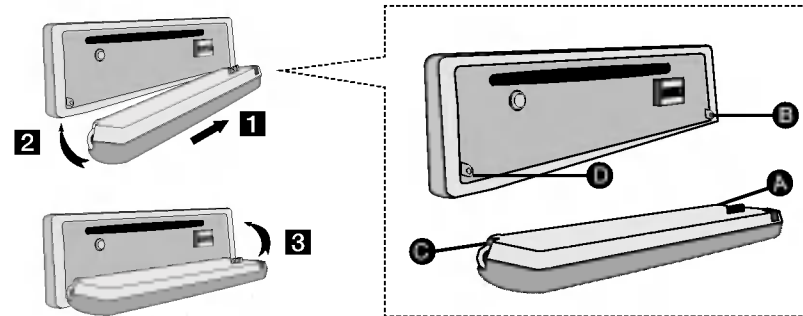

Attachable Front panel

- 1 Join **A** on the front panel to **B** on the main unit.
- 2 Join **C** on the front panel to **D** on the main unit while pushing the front panel to right.
- 3 Close the front panel

Notes

- When detaching or attaching the front panel, do not press the display or control buttons.
- The control buttons may not work properly if the front panel is not attached properly. If this occurs, gently press the front panel.

- Do not leave the front panel in any area exposed to high temperatures or direct sunlight.
- Do not drop the front panel or otherwise subject it to strong impact.
- Do not allow such volatile agents as benzene, thinner, or insecticides to come into contact with the surface of the front panel.
- Do not try to disassemble the front panel.

Basic Operation

POWER ON and OFF

- Press **POWER (PWR)** button or any other button to turn the unit on.
- When you insert the CD in the CD slot, it is turned on.
- Press **POWER (PWR)** to turn it off.
- When the front panel is opened for more than 30 seconds, it is turned automatically off.

Notes

- When you turn off, the unit is memorized automatically the volume level currently before you turn off.
- Whenever you turn on the unit, it will operate at the volume level memorized.

MUTE FUNCTION

- **MUTE** button is operated as Mute state on/off.
- The releasing mode mute state is when any button is pressed again.

EQUALIZER (EQ) Button

Each press of the **EQ** button switches the unit to the other equalizer mode, as follows.

Pop→**Classic**→**Rock**→**Jazz**→**Vocal**

- **Pop** : Optimized for R&B, Soul and Country music.
- **Classic** : Optimized for orchestral music.
- **Rock** : Optimized for Hard Rock and Heavy Metal music.
- **Jazz** : Sweet sound with soft feeling
- **Vocal** : Powerful realism with strong sound quality

XDSS (Extreme Dynamic Sound System)

Press **XDSS** button to reinforce treble, bass and surround effect.

SELECTION (SEL) Button

- 1 Press the **SELECTION (SEL)** button repeatedly to select the mode you want to adjust from volume, bass, treble, balance and fader.
The mode indicator lights up in the following order.

→**VOL**→**BAS**→**TRB**→**BAL**→**FAD**

- 2 Turn left or right **CONTROL UP/DOWN** dial to adjust the sound quality

	Turn right	Turn left
VOL	Increase the volume level.	Decrease the volume level.
BAS	Increase the bass level.	Decrease the bass level.
TRB	Increase the Treble level.	Decrease the Treble level.
BAL	Decrease the level of the left speaker(s).	Decrease the level of the right speaker(s).
FAD	Decrease the level of the front speaker(s).	Decrease the level of the rear speaker(s).

Note

The unit cannot adjust the bass and treble in the **EQ** on mode.

Basic Operation

CONTROL UP/DOWN DIAL

- 1 After you have selected the proper mode by using the **SELECTION (SEL)** button, control the desired function by turning this dial within 6 seconds. After you finish selecting modes, the unit returns to the initial mode.
- 2 Operating display in all modes:
A numeric display is converted by turning this dial.

SETTING THE CLOCK

- 1 Press **DISPLAY (DISP)** button once momentarily to display the time.
- 2 Press the **DISPLAY (DISP)** button for more than 2 seconds, and clock indication will be displayed for 5 seconds. Adjust the clock within 5 seconds.
 - Press **▶▶** to adjust the hour.
 - Press **◀◀** to adjust the minute.
- 3 Press the **DISPLAY (DISP)** button, the display returns to the previous display after 5 seconds.

FUNCTION (FUNC) Button

This button serves to switch over between CD and RADIO operation.
(CD ↔ RADIO)

BEEP SOUND FUNCTION

- 1 Press the **SELECTION (SEL)** button for more than 2 seconds.
"BEEP ALL" or "BEEP 2ND" appear in the Display window.
- 2 Turn left or right **CONTROL UP/DOWN** dial to select the "BEEP ALL" or "BEEP 2ND" indicator.
 - BEEP ALL
When any button is pressed, beep sounds
 - BEEP 2ND
When **preset(1~6)** are pressed for more than 2 seconds, beep sounds

Basic Operation

Except the function which is this page, the Button of the remote control function in the same way as the controls on the main unit.
Point the remote control unit at the sensor

POWER ON and OFF

Press **POWER** button for more than 2 seconds.

MUTE FUNCTION

Press **POWER** button briefly.

Number # FUNCTION

Enters the number input mode.

Number 0 to 9

- Memorizes broadcast stations (1~6)
- Selects preset number (1~6)
- Direct track selection (0~9)

(Example : track number 19)

- 1 press # button
- 2 press 1,9

SOUND adjustments

- 1 press the **SELECTION (SEL)** button repeatedly to select the mode you want to adjust from volume, bass, treble, balance and fader.
- 2 Press and hold down the \wedge or \vee button to adjust the sound quality.

Note: Without selecting any mode with **SELECTION (SEL)**, only the volume level can be adjusted by pressing \wedge or \vee .

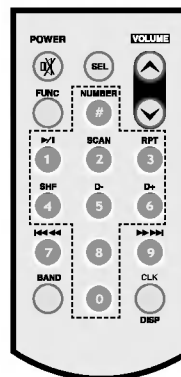

Presetting stations

- **AUTO Tuning**
Press the \lll \lll/\ggg \ggg buttons for more than 1second.
- **MANUAL**
Press the \lll \lll/\ggg \ggg buttons for more than 2 seconds and then buttons repeatedly until the desired station appears.

CD SKIP/SEARCH

- **CD SKIP**
Press the \lll \lll/\ggg \ggg buttons for more than 1second.
- **CD SEARCH(Only CD)**
Press and hold down the \lll \lll/\ggg \ggg buttons until the desired section appears.

DISP FUNCTION

- Press **CLK/DISP** button once briefly to display the time.
- Press **CLK/DISP** button twice briefly to display the ID3 Tag.

CD Basic Operation(CD/MP3 CD)

Basic Playback

1 Insert a disc with the labeled side up to start playback.
If a disc is already inserted, press **FUNCTION (FUNC)** to select the CD operation.
Disc indicator lights up, and the track number and elapsed playing time are displayed.

2 Adjust the volume by turning **CONTROL UP/DOWN** dial.

Switching between audio source

Press **FUNCTION (FUNC)** to stop CD play and switch to radio play.

Press again to resume CD play at beginning of last track played.

Notes

- The disc is either inserted or ejected when the unit is not turned on.
- The playback starts from the first track on the disc only when inserting a disc. In other cases (when switching from the radio operation or turning on the unit), the playback starts from the beginning of the track being played when the playback has stopped.
- A disc can be inserted by putting it into the disc compartment slot, and either pushing it lightly with fingers or pressing
- Suitable CD: This unit is designed to be operated on a 12 Cm(5") disc only.
- This unit can play a CD-R or CD-RW that contains audio titles or MP3 files.

CD/MP3 CD playback button

▲	Eject a disc. To withdraw the CD, firmly depress . The unit automatically switches to radio reception.
▶/	Play or Pause. The track number and elapsed playing time flash on and off. To resume play, press again.
▶▶	Forward on the disc. Press and hold down until the start of the desired passage, then release it. (Only CD)
◀◀	Reverse on the disc. Press and hold down until the start of the desired passage, then release it. (Only CD)
▶▶▶	Skip to the next track with a short press (for less than 1second). Each extra press skips forward one extra track. To skip forward rapidly, press and hold down until the desired track number is displayed, then release it.
◀◀◀	Restart the track currently in play with a short press (for less than 1second). Each extra press skips backward one extra track. To skip backward rapidly, press and hold down until the desired track number is displayed, then release it.

CD Advanced Operation

INTRO SCAN Play

Press **SCAN** during playback.

SCAN indicator lights up and the first 10 seconds of all the tracks on the disc are played in order.

When the desired track is found, press **SCAN** again.

The unit returns to the normal playback.

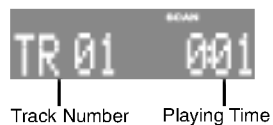

Notes

- The intro scan play cannot be performed with the repeat or shuffle play.
- After the first 10 seconds of all the tracks on the disc are played in order, the unit repeats until the intro scan stopped.

REPEAT Play

Press **RPT** during playback.

RPT indicator lights up and the currently selected track is played repeatedly.

To cancel the repeat play, press **RPT** again.



Notes

- If the repeat play is not selected, all the tracks on the disc are played repeatedly.
- The repeat play cannot be performed with the intro scan or shuffle play.

SHUFFLE Play

Press **SHF** during playback.

SHF indicator lights up and the tracks on the disc are played randomly.

To cancel the shuffle play, press **SHF** again.



Notes

- The shuffle play cannot be performed with the intro play. If the repeat play is selected during the shuffle play, the shuffle play is canceled.
- During the shuffle play, even if **◀◀** is pressed repeatedly, the track currently in play is restarted.

MP3 file information

Press twice the **DISP** button during MP3 file playback.

- The information ID3 TAG(Title, Artist or Album) of the MP3 file will be shown in the display window.
- If there is no the information of the MP3 file, "NO ID3 TAG" indicator will be shown in the display window.

MP3 TRACK -10/+10

During playback, press the -10(D-) button to go back to the previous 10th track, and press +10(D+) button to go forward to the next 10th track.

For your reference

• Auto Loading

When the disc is ejected by pressing **▲** during playback, it will be loaded automatically after 10 seconds unless you pull out the disc from the unit.

Radio Operation

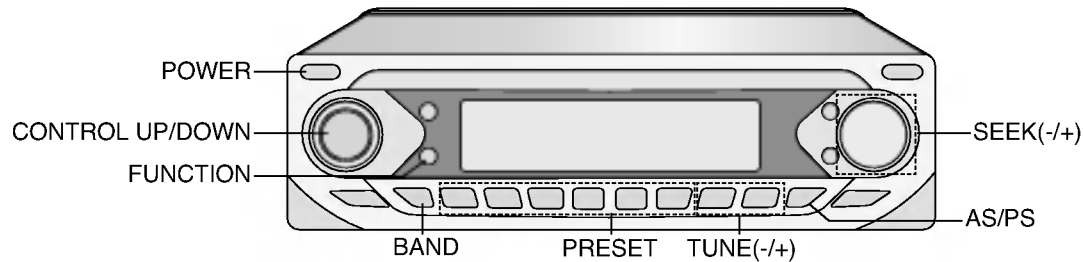

Presetting stations

Up to 6 stations for each band F1, F2, F3, MW can be stored on the preset station buttons.

- 1 Press **BAND** to select the desired band. If a CD is inserted in the unit, press **FUNCTION (FUNC)** button to select radio function.
- 2 Tune in the station to be preset by pressing **SEEK/TUNE(-/+)** button.
 - **AUTO Tuning**
Press the **SEEK(-/+)** buttons for more than 1second.
 - **MANUAL**
Press the **TUNE(-/+)** buttons for more than 1second.

- 3 Press one of the **preset station** buttons (1 - 6) for more than 2 seconds. The number of the pressed preset station button is displayed.
- 4 Repeat steps 2 and 3 to preset other stations.

Notes

- As F1, F2, F3 have the same frequency range, up to 18 station can be preset for FM.
- When a station is preset on the preset station button on which another station of the same band has already been preset, the previously preset station is automatically erased.

Automatic Store Stations

The automatic presetting function is used to automatically preset up to 6 stations for each band.

- 1 Press **BAND** to select the desired band.
- 2 Press and hold **AS/PS** (auto store/preset scan) down for more than 2 seconds. The scanning starts from the currently displayed frequency to higher frequencies and stops when 6 stations have been preset or the receivable frequencies have been scanned once.

Radio Operation

Notes

- The presetting is not performed if there is no station to be tuned in.
- When the automatic presetting is performed, the previously preset stations are automatically erased.
- To stop the automatic presetting, press **AS/PS** (auto store/preset scan) again or press any of the **preset station buttons** (1 - 6)

To scan the preset stations

Press **AS/PS** (auto store/preset scan) button briefly.

Each preset station is tuned in for 5 seconds in order.

To stop the scanning, press **AS/PS** again or any of the preset station buttons (1 - 6).

To tune in the preset stations

Press **BAND** to select the desired band and press the desired preset station buttons (1 - 6).

The number of the **preset station button** is displayed and the preset station is received.

Listening to the radio

- 1** Press any button (except ) to turn on the unit.
The radio frequency is displayed. If the unit is in the CD operation, press **FUNCTION (FUNC)** to select the radio operation.
- 2** Press **BAND** to select the desired band.
The band indicator F1, F2, F3, MW is displayed.
- 3** Press **TUNE(+)** to increase and **TUNE(-)** to decrease the frequency. To change the frequency rapidly, press and hold **TUNE(-/+)** down longer.

Seek Tuning

The seek function is used to search for the station automatically.

- Press **SEEK(-/+)** to start the seek function.
- Press **SEEK(+)** to search for the higher frequencies and **SEEK(-)** for the lower frequencies.
The seeking stops when the nearest station with good reception is tuned in.
- Press **SEEK (-/+)** repeatedly until desired station is received.

CD Changer player(Optional)

You can play CDs with this unit by connecting the optional compact disc changer.

Make sure that the disc magazine loaded with the discs is inserted into the connected compact disc changer.

- 1 Press **POWER** button to turn on the power of the car stereo.
- 2 Slip a CD in the magazine with the sticker upwards.
- 3 Insert the magazine in the CD changer.
- 4 Press **FUNCTION** button to activate the CDC function, one of the disc will be played automatically, If the CD changer is not connected, the CDC function is not activated.
- 5 Press **D +/-** button to select the CD.
- 6 Press one of buttons (**1<<</>>>1**) to select another except of music from the disc being played.
- 7 Press and hold the (**<<</>>>**) button during playback.
The track is scanned by spiral in the forward or backward direction.
Release the button to resume playback at the desired location.

Basic Play

To start play, press the (**▶/||**) button

To pause, press it again.

The disc and track number blinks in the display window.

Repeat Play

- To play one track repeatedly, press **RPT** button (The **RPT** indication is displayed).



- To play all tracks repeatedly, press **RPT** button for more than 1.5 seconds (The **RPT** indication is displayed).



- To cancel the repeat play, press **RPT** button again.

Notes

- If the repeat play is not selected, all the discs are played repeatedly.
- The repeat play cannot be performed with the intro scan or shuffle play.

Shuffle play

- To play one disc randomly, press **SHF** button (The **SHF** indication is displayed).



- To play all discs randomly, press **SHF** button for more than 1.5 seconds (The **SHF** indication is displayed).

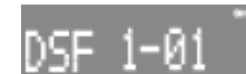

- To cancel the repeat play, press **SHF** button again.

Notes

- The shuffle play cannot be performed with the intro scan play. If the repeat play is selected during the shuffle play, the shuffle play is canceled.
- During the shuffle play, even if **<<<** is pressed repeatedly, the track currently in play is restarted.

CD Changer player(Optional)

Intro Scan

Press **SCAN** button to scan a CD by playing only the first 10 seconds of each track.

- To play one disc intro scan, press **SCAN** button (The **SCAN** indication is displayed).

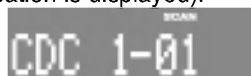

- To play the first 10 seconds of each track on all the discs intro scan, press **SCAN** button for more than 1.5 seconds (The **SCAN** indication is displayed).

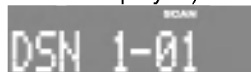

When the desired track is found, press **SCAN** again. The unit returns to the normal playback.

Notes

- The intro scan play cannot be performed with the repeat or shuffle play.

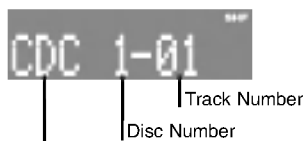

- CD CHANGER indicator
- CDC : CD CHANGER
- DSF : DISC SHUFFLE
- DRT : DISC REPEAT
- DSN : DISC SCAN

Specifications

GENERAL

Output Power	.50W x 4CH(Max.)
Power Source	.DC 12-15 V
Speaker impedance	.4 Ω
Ground System	Negative
Dimensions(W x H x D)	.188 x 58 x 166 mm(Without Front Panel)
Net Weight	.1.3 kg

CD SELECTION

Frequency Response	.40 Hz-20 kHz
S/N Ratio	.60 dB
Distortion	.0.5%
Channel Separation(1kHz)	.50 dB

RADIO SELECTION

FM

Frequency Range	.87.5-108 MHz
S/N Ratio	.55 dB
Distortion	.0.5%
Channel Separation	.25 dB

AM(MW)

Frequency Range	.522-1620 kHz
S/N Ratio	.45 dB
Distortion	.1.0%

LW(Optional)

Frequency Range	.144-281 kHz
S/N Ratio	.45 dB
Distortion	.1.0%

Note

- The design and specification are subject to change without notice in the course of product improvement.





P/NO : 3834RR0002E