

Top-Freezer Refrigerators

<i>Safety Instructions</i>	
Connect Electricity	3
Proper Disposal	2
Safety Precautions	2
<i>Operating Instructions</i>	
Automatic Icemaker	7
Controls	4
Crispers and Pans	6
Shelves and Bins.....	5
<i>Care and Cleaning</i> 7, 8	
Replacing the Light Bulb	9
<i>Installation Instructions</i>	
Preparing to install the Refrigerator.....	10
Reversing the Door Swing.....	12
Water Line installation.....	11
<i>Troubleshooting Tips</i>	
Before You Call For Service.....	18, 19
Normal Operating Sounds	17

**Owner's Manual &
Installation Instructions**

Model 18 & 20

Write the model and serial numbers here:

Model # _____

Serial # _____

Find these numbers on the gray label on the left side, near the top of the refrigerator compartment.

P/no.: 3828JD8463U

IMPORTANT SAFETY INFORMATION. READ ALL INSTRUCTIONS BEFORE USING.

⚠ WARNING!

Use this appliance only for its intended purpose as described in this Owner's Manual.



SAFETY PRECAUTIONS

When using electrical appliances, basic safety precautions should be followed, including the following:

- This refrigerator must be properly installed and located in accordance with the Installation Instructions before it is used. Also see the How To Connect Electricity section.
- Do not attempt to stand on top of the refrigerator. Doing so may result in bodily injury or damage to the refrigerator.
- Do not allow children to play with the refrigerator or tamper with the controls.
- Do not allow children to climb, stand or hang on the shelves in the refrigerator. They could damage the refrigerator and seriously injure themselves.
- Do not touch the cold surfaces in the freezer compartment when hands are damp or wet. Skin may stick to these extremely cold surfaces.
- Do not store or use gasoline or other flammable vapors and liquids in the vicinity of this or any other appliance.
- Keep fingers out of the "Pinch point" areas; clearances between the doors and between the doors and cabinet are necessarily small. Be careful closing doors when children are in the area.
- In refrigerators with automatic icemakers, avoid contact with the moving parts of the ejector mechanism, or with the heating element located on the bottom of the icemaker. Do not place fingers or hands on the automatic icemaking mechanism while the refrigerator is plugged in.
- Unplug the refrigerator before cleaning and making repairs.
NOTE: We strongly recommend that any servicing be performed by a qualified individual.
- Setting either or both controls to the **0 (off)** position does not remove power to the light circuit.
- Do not refreeze frozen foods which have thawed completely.

⚠ DANGER! RISK OF CHILD ENTRAPMENT

PROPER DISPOSAL OF THE REFRIGERATOR

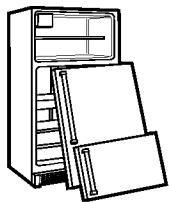

Child entrapment and suffocation are not problems of the past. Junked or abandoned refrigerators are still dangerous...even if they will sit for "just a few days." If you are getting rid of your old refrigerator, please follow the instructions below to help prevent accidents.

Before You Throw Away Your Old Refrigerator or Freezer:

- Take off the doors and discard separately.
- Leave the shelves in place so that children may not easily climb inside.
- If the refrigerator has a lock, make it unusable.

Refrigerants

All refrigeration products contain refrigerants, which must be removed prior to product disposal. If you are getting rid of an old refrigeration product, check with the company handling disposal about what to do.

⚠ WARNING!



HOW TO CONNECT ELECTRICITY

For personal safety, this appliance must be properly earthed.

The power cord of this appliance is equipped with an earthing plug which mates with a standard earthed wall outlet to minimize the possibility of electric shock hazard from this appliance.

Have the wall outlet and circuit checked by a qualified electrician to make sure the outlet is properly earthed.

Where an unearthed wall outlet is encountered, it is your personal responsibility and obligation to have it replaced with a properly earthed wall outlet.

The refrigerator should always be plugged into its own individual electrical outlet.

This provides the best performance and also prevents overloading house wiring circuits which could cause a fire hazard from overheated wires.

Please refer to the rating plate on the refrigerator for the correct voltage, wattage and frequency

If the product plug does not fit your outlet, the product should be fitted with a new plug.

IMPORTANT: *The refitting of electric plugs and cables should be done by a qualified technician or service agent. In some countries the refitting of electric plugs and cables is only permitted when the work is completed by a qualified technician.*

If the power supply cord becomes damaged, it must be replaced by a qualified service agent in order to avoid a safety hazard.

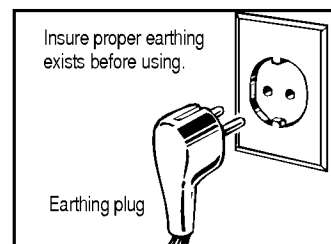

Never unplug your refrigerator by pulling on the power cord. Always grip plug firmly and pull straight out from the outlet.

Repair or replace immediately all power cords that have become frayed or otherwise damaged. Do not use a cord that shows cracks or abrasion damage along its length or at either end.

When moving the refrigerator away from the wall, be careful not to roll over or damage the power cord.

Mains lead replacement

If the mains lead on your refrigerator needs replacing at any time, it must be replaced by a special lead which is obtainable from your local. A charge will be made for the replacement dealer of the mains lead if you have damaged the lead.

The refrigerator must be positioned so that the plug is accessible.



READ AND FOLLOW THIS SAFETY INFORMATION CAREFULLY.

SAVE THESE INSTRUCTIONS

About the controls on the refrigerator.

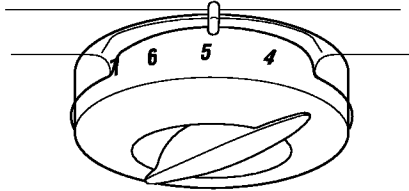

REFRIGERATOR CONTROL
0 IS OFF
9 IS COLDEST

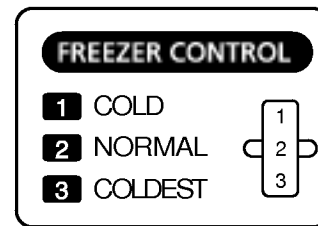
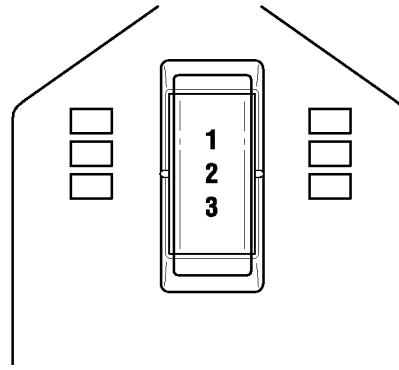

Initially, set the refrigerator control at 5 and the freezer control at 2 and allow 12 hours for the temperature to stabilize.

Several adjustments may be required. Adjust the controls one increment at a time, and allow 12 hours after each adjustment for the refrigerator to reach the temperature you have set.

Setting either or both controls to **0 (off)** stops cooling in both the refrigerator and freezer compartments but does not shut off electrical power to the refrigerator.

Control settings will vary based on personal preferences, usage and operating conditions and may require more than one adjustment.

Ambient Room Temperature Limits

This refrigerator is designed to operate in ambient temperatures specified by its Temperature Class which is marked on the rating plate.

Temperature Class	Symbol	Ambient Temperature	
		Maximum	Minimum
Extended-Temperate	SN	32°C	10°C
Temperate	N	32°C	16°C
Subtropical	ST	38°C	18°C
Tropical	T	43°C	18°C

NOTE : Internal temperature may be affected by such factors as the location of the refrigerator, ambient temperature and frequency of door openings.

Adjust temperature controls as required to compensate for these factors.

About the shelves and bins.

Not all features are on all models.

Freezer Compartment

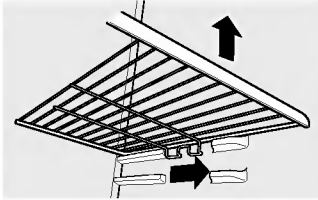

To remove:

Slide the shelf forward until the stops line up with the gaps in the molded shelf supports. Lift the front of the shelf up and pull the shelf out.

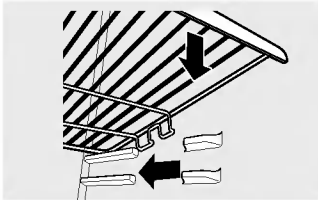

To replace:

Rest the back of the shelf on the back portion of the shelf supports. Lower the front of the shelf, lining up the stops on the shelf with the gaps on the shelf supports.

Slide the shelf back.

NOTE: For models with an automatic icemaker, the freezer shelf must be in the lower position for the ice cube bucket to catch the cubes.

Adjust Bins on the Door

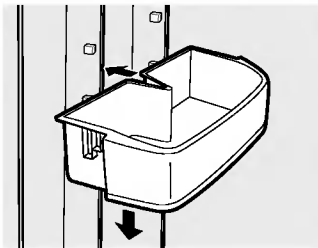

To remove: Lift bin straight up, then pull out.

To replace or relocate: Engage the bin in the molded supports on the door, and push down.

About the shelves and bins.

Not all features are on all models.

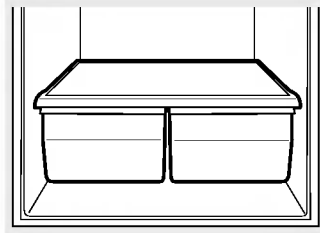

Fruit and Vegetable Crisper

Excess water that may accumulate in the bottom of the drawers or under the drawers should be wiped dry.

To Remove:

These drawers can be removed easily by lifting up slightly while pulling the drawer past the **stop** location.

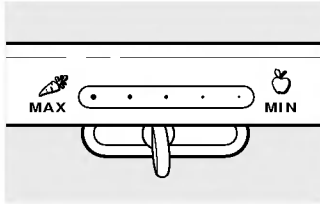

Adjustable Humidity Crisper (on some models)

Slide the control all the way to the **MAX** setting to provide high humidity recommended for most vegetables.

Slide the control all the way to the **MIN** setting to provide lower humidity levels recommended for most fruits.

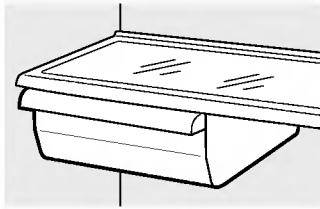

Snack Pan (on some models)

To remove, slide the pan out to the **stop** position, lift the pan up and past the **stop** position and lift it out.

About the automatic icemaker. (on some models)

A newly-installed refrigerator may take 12 to 24 hours to begin making ice.

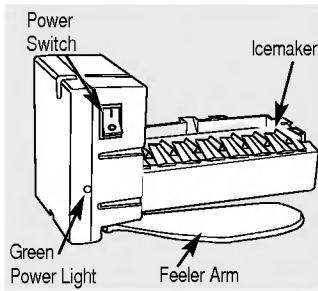

Automatic Icemaker

The icemaker will produce seven cubes per cycle—approximately 100–130 cubes in a 24-hour period, depending on freezer compartment temperature, room temperature, number of door openings and other use conditions.

If the refrigerator is operated before the water connection is made to the icemaker, set the power switch to **O (off)**.

When the refrigerator has been connected to the water supply, set the power switch to **I (on)**.

The green power light will come on.

The icemaker will fill with water when it cools to freezing. A newly installed refrigerator may take 12 to 24 hours to begin making ice cubes.

You will hear a buzzing sound each time the icemaker fills with water.

Throw away the first few batches of ice to allow the water line to clear.

Be sure nothing interferes with the sweep of the feeler arm.

When the bin fills to the level of the feeler arm, the icemaker will stop producing ice.

It is normal for several cubes to be joined together.

If ice is not used frequently, old ice cubes will become cloudy, taste stale and shrink.

If ice cubes get stuck in the icemaker, the green power light will blink. To correct this, set the power switch to **O (off)** and remove the cubes. Set the power switch to **I (on)** to restart the icemaker.

NOTE: In homes with lower-than-average water pressure, you may hear the icemaker cycle multiple times when making one batch of ice.

⚠ WARNING!

Connect to potable water supply only.
Installation of the icemaker must be done by a qualified service technician.

Icemaker Accessory Kit

If your refrigerator did not already come equipped with an automatic icemaker, an icemaker accessory kit is available at extra cost.

Check the back of the refrigerator for the specific icemaker kit needed for your model.

⚠ WARNING!

Connect to potable water supply only.
Installation of the icemaker must be done by a qualified service technician.

Care and cleaning of the refrigerator.

Cleaning the Outside

The door handles and trim. Clean with a cloth dampened with soapy water. Dry with a soft cloth.

Keep the outside clean. Wipe with a clean cloth lightly dampened with mild liquid dish detergent. Dry with a clean, soft cloth.

Do not wipe the refrigerator with a soiled dish cloth or wet towel. These may leave a residue that can erode the paint. Do not use scouring pads, powdered cleaners, bleach or cleaners containing bleach because these products can scratch and weaken the paint finish.

Cleaning the Inside

To help prevent odors, leave an open box of baking soda in the refrigerator and freezer compartments.

Unplug the refrigerator before cleaning. If this is not practical, wring excess moisture out of sponge or cloth when cleaning around switches, lights or controls.

Use warm water and baking soda solution—about a tablespoon (15 ml) of baking soda to a quart (1 liter) of water. This both cleans and neutralizes odors. Thoroughly rinse and wipe dry.

Avoid cleaning cold glass shelves (on some models) with hot water because the extreme temperature difference may cause them to break. Handle glass shelves carefully. Bumping tempered glass can cause it to shatter.

Do not wash any refrigerator parts in the dishwasher.

Wash ice trays in lukewarm water only—do not put them in an automatic dishwasher.

Behind the Refrigerator

Be careful when moving the refrigerator away from the wall. All types of floor coverings can be damaged, particularly cushioned coverings and those with embossed surfaces.

Pull the refrigerator straight out and return it to position by pushing it straight in. Moving the refrigerator in a side direction may result in damage to the floor covering or refrigerator.

When pushing the refrigerator back, make sure you don't roll over the power cord or icemaker supply line (on some models).

Preparing for Vacation

For long vacations or absences, remove food and unplug the refrigerator. Move the freezer control to the **O (off)**

position, and clean the interior with a baking soda solution of one tablespoon (15 ml) of baking soda to one quart (1 liter) of water. Leave the doors open.

Set the icemaker power switch to the **O (off)** position and shut off the water supply to the refrigerator.

If the temperature can drop below freezing, have a qualified servicer drain the water supply system (on some models) to prevent serious property damage due to flooding.

Preparing to Move

Secure all loose items such as base grille, shelves and drawers by taping them securely in place to prevent damage.

Be sure the refrigerator stays in an upright position during moving.

Replacing the light bulb.

Turning the control to the **0 (off)** position does not remove power to the light circuit.

Refrigerator Compartment

CAUTION: Light bulb may be hot.



- 1 Unplug the refrigerator.
- 2 The bulb is located at the top of the refrigerator compartment, behind the temperature control.
- 3 To remove the light shield, grasp the shield with two hands as shown. Bend the sides of the shield slightly toward the center until the tabs release and the back of the shield comes out. Slide the shield back and take it out.
- 4 Replace the bulb with an appliance bulb of the same or lower wattage.
- 5 To replace the light shield, insert the tab at the front of the shield into the opening at the front of the recess and push the back of the shield up until the tabs on the sides of the shield snap into place.
- 6 Plug the refrigerator back in.

BEFORE YOU BEGIN

Read these instructions completely and carefully.

- **IMPORTANT** – Save these instructions for local inspector's use.
- **IMPORTANT** – Observe all governing codes and ordinances.
- **Note to Installer** – Be sure to leave these instructions with the Consumer.
- **Note to Consumer** – Keep these instructions for future reference.
- **Skill level** – Installation of this appliance requires basic mechanical skills.
- **Completion time** – Refrigerator Installation 15 minutes
- Proper installation is the responsibility of the installer.
- Product failure due to improper installation is not covered under the Warranty.

WATER SUPPLY TO THE ICEMAKER (on some models)

If the refrigerator has an icemaker, it will have to be connected to a cold drinking water line. A water supply kit is available at extra cost from your dealer.

Installation of the icemaker must be done by a qualified service technician.

REFRIGERATOR LOCATION

- Do not install the refrigerator where the temperature will go below 60°F (16°C) because it will not run often enough to maintain proper temperatures.
- Do not install the refrigerator where the temperature will go above 100°F (37°C) because it will not perform properly.
- Install it on a floor strong enough to support it fully loaded.

CLEARANCES

Allow the following clearances for ease of installation, proper air circulation and plumbing and electrical connections:

- Sides 1/8" (4 mm)
- Top 3/4" (25 mm)
- Back 3/4" (25 mm)

If the refrigerator is against a wall on either side, allow a 1/8" (3 mm) door clearance.

LEVELING LEGS

The leveling legs have 3 purposes:

Leveling legs adjust so the doors close on their own when opened about 45°.

Leveling legs adjust so the refrigerator is firmly positioned on the floor and does not wobble.

To easily move the refrigerator, raise the leveling legs until the unit is supported by the rollers.

To adjust the leveling legs:

- 1 Remove the base grille by positioning hands as shown.
- 2 Pull the grille straight out until the clips snap out.
- 3 Pull the grille away from the refrigerator.
- 4 Insert a flat blade screwdriver into the slots on the leveling leg and turn **clockwise to raise** the refrigerator, **counterclockwise to lower it**.
- 5 Replace the grille so the notch in the grille will fit around the bottom door hinge.
- 6 Line up the clips on the grille with the openings on the refrigerator and push into place.

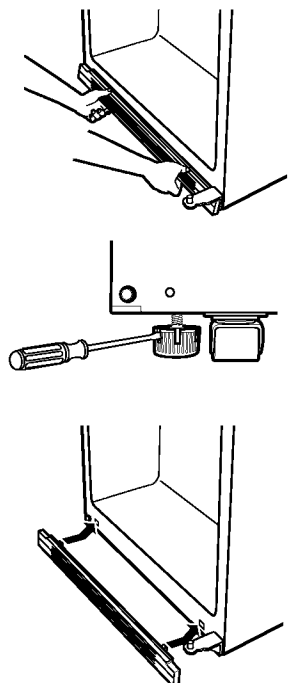

Installation Instructions

INSTALLING THE WATER LINE

BEFORE YOU BEGIN

The water line installation is not warranted by the refrigerator or icemaker manufacturer. Follow these recommendations carefully to minimize the risk of expensive water damage.

Water hammer (water banging in the pipes) in house plumbing can cause damage to refrigerator parts and lead to water leakage or flooding. Call a qualified plumber to correct water hammer before installing the water supply line to the refrigerator.

To prevent burns and product damage, do not hook up the water line to the hot water line.

If you use your refrigerator before connecting the water line, make sure the icemaker power switch is in the **O (off)** position.

BEFORE YOU BEGIN (cont.)

Do not install the icemaker tubing in areas where temperatures fall below freezing.

When using any electrical device (such as a power drill) during installation, be sure the device is insulated or wired in a manner to prevent the hazard of electric shock.

All installations must be in accordance with local plumbing code requirements.

Installation of the icemaker must be done by a qualified service technician.

⚠ WARNING! Connect to potable water supply only.

i CONNECT THE TUBING TO THE REFRIGERATOR

NOTES:

- Before making the connection to the refrigerator, be sure the refrigerator power cord is not plugged into the wall outlet.
- We recommend installing a water filter if your water supply has sand or particles that could clog the screen of the refrigerator's water valve. Install it in the water line near the refrigerator.

Remove the access cover.

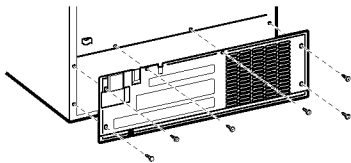

Remove the plastic flexible cap from the water valve.

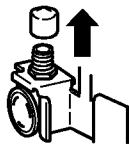

Place the compression nut and ferrule (sleeve) onto the end of the tubing as shown.

Insert the end of the tubing into the water valve connection as far as possible. While holding the tubing, tighten the fitting.

Fasten the tubing into the clamp provided to hold it in a vertical position. You may need to pry open the clamp.

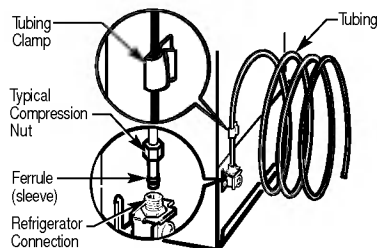

Reattach the access cover.

j TURN THE WATER ON AND PLUG IN THE REFRIGERATOR

Arrange the coil of tubing so that it does not vibrate against the back of the refrigerator or against the wall. Push the refrigerator back to the wall.

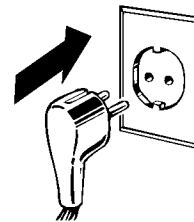

k START THE ICEMAKER

Set the icemaker power switch to the **I (on)** position.

The icemaker will not begin to operate until it reaches its operating temperature of -9°C or below.

It will then begin operation automatically if the icemaker power switch is in the **I (on)** position.

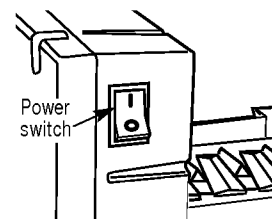

NOTE: In lower water pressure conditions, the water valve may turn on up to 3 times to deliver enough water to the icemaker.

Installation Instructions

REVERSING THE DOOR SWING

IMPORTANT NOTES

When reversing the door swing:

- Read the instructions all the way through before starting.
- Handle parts carefully to avoid scratching paint.
- Set screws down by their related parts to avoid using them in the wrong places.
- Provide a non-scratching work surface for the doors.

IMPORTANT: Once you begin, do not move the cabinet until door-swing reversal is completed.

These instructions are for changing the hinges from the right side to the left side—if you ever want to change the hinges back to the right side, follow these same instructions and reverse all references to left and right.

Unplug the refrigerator from its electrical outlet.

Empty all door shelves, including the dairy compartment.

TOOLS YOU WILL NEED



Phillips screwdriver

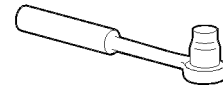

10 mm socket wrench

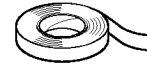

Masking tape

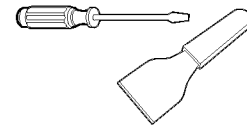

Putty knife or
thin-blade screwdriver

Installation Instructions

i REMOVE THE FREEZER DOOR

Tape the door shut with masking tape.

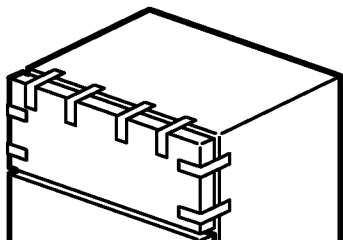

Remove the hinge cover on top of the freezer door. Remove the screws, then lift the hinge straight up to free the hinge pin from the socket in the top of the door.

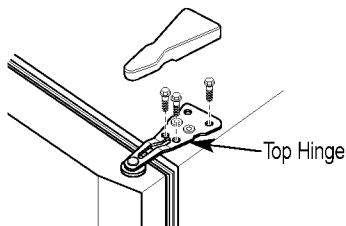

Remove the tape and tilt the door away from the cabinet. Lift it off the center hinge pin.

Set the door on a non-scratching surface with the inside up.

k REMOVE THE REFRIGERATOR DOOR

Tape the door shut with masking tape.

Remove the screws attaching the center hinge to the cabinet. Then lift the hinge straight up to free the hinge pin from the socket in the top of the door. Be sure to keep the washer with the hinge.

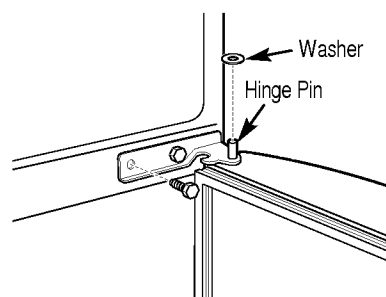

Remove the tape and tilt the door away from the cabinet. Lift the door straight off the bottom hinge bracket.

Set the door on a non-scratching surface, with the inside up.

CAUTION: Do not let door drop to the floor. To do so could damage the door stop.

j TRANSFER THE FREEZER DOOR STOP TO THE LEFT

Remove the freezer door stop, located on the bottom right side of the freezer door, and install it on the left side.

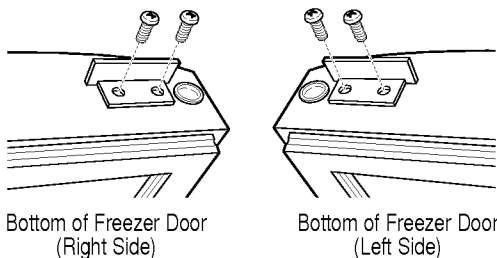

l TRANSFER THE REFRIGERATOR DOOR STOP TO THE LEFT

Remove the 2-piece refrigerator door stop, located on the bottom right side of the refrigerator door, and install it on the left side.

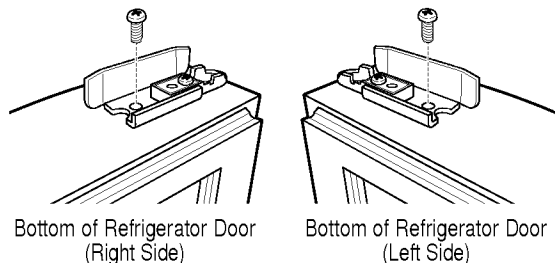

Installation Instructions

REVERSING THE DOOR SWING (CONT.)

m TRANSFER BOTTOM HINGE BRACKET TO THE LEFT

Remove the base grille by pulling it straight out.

Remove the screw attaching the hinge pin to the right side of the hinge bracket. Attach the hinge pin to the left side of the bracket.

Remove the bottom hinge bracket from the right side and install it on the left side.

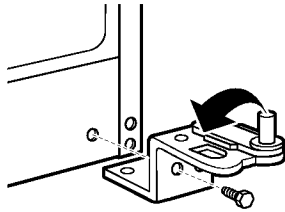

n TRANSFER REFRIGERATOR DOOR HANDLE TO THE RIGHT

Remove the plug button, located on the lower part of the handle, by carefully prying under the edge with a putty knife. Remove the exposed screw holding the handle.

Remove the two screws holding the handle to the top of the door.

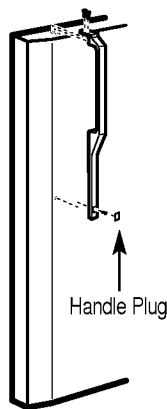

n TRANSFER REFRIGERATOR DOOR HANDLE TO THE RIGHT (Cont.)

Move the screws from the top right side of the door top and insert them into the handle screw holes on the opposite side.

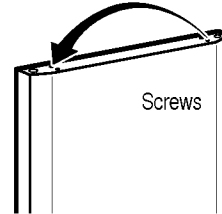

Move the large plug button from the left edge of the door and insert it into the hole on the opposite side.

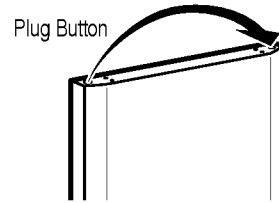

Transfer the door plug button to the opposite side.

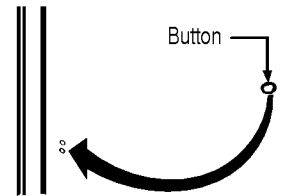

Attach the handle to the right side of the door.

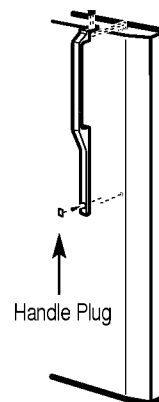

Installation Instructions

○ TRANSFER FREEZER DOOR HANDLE TO THE RIGHT

Remove the screws holding the handle to the top and bottom of the door. Remove handle.

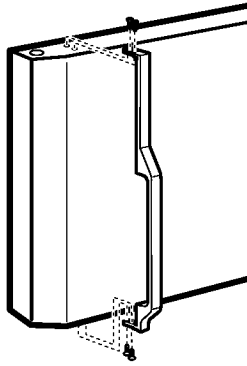

Move the screws on the right side of the door to the handle screw hole on the left side.

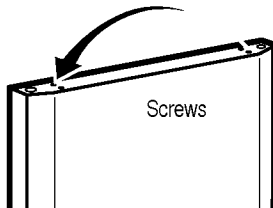

Move the large plug button from the left edge of the door and insert it into the hole on the opposite side.

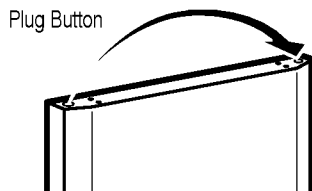

Reattach the handle on the opposite side using the holes closest to the edge of the door.

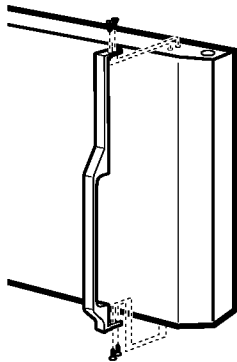

□ REHANG THE REFRIGERATOR DOOR

Replace the base grille. Lower the refrigerator door onto the bottom hinge pin.

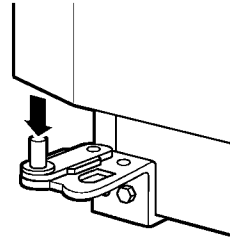

Shut the door, making sure to align the door with the cabinet. Secure the door to the cabinet with masking tape. Make sure the gasket on the door is flush against the cabinet and is not folded.

Installation Instructions

REVERSING THE DOOR SWING (CONT.)

q INSTALL CENTER HINGE BRACKET ON LEFT SIDE

Remove the screw hole cover from the left side and insert it into the screw holes on the right side.

Insert the center hinge pin into the hinge hole on top of the refrigerator door.

Attach the center hinge to the cabinet with screws.

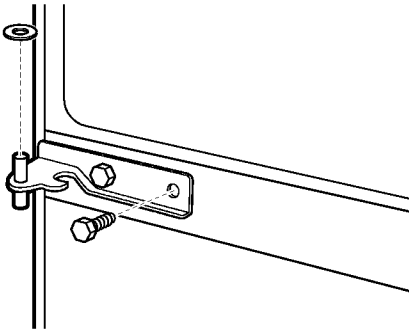

r REHANG THE FREEZER DOOR

Lower the freezer door onto the center hinge pin.

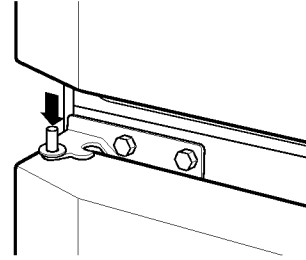

Shut the door, making sure to align the door with the cabinet.

Insert the top hinge pin into the hinge hole on top of the freezer door. Attach the hinge to the top of the cabinet loosely with the screws.

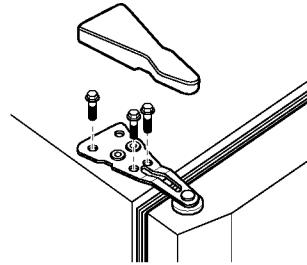

Make sure the gasket on the door is flush against the cabinet and is not folded.

Support the door on the handle side and make sure the door is straight and the gap between the doors is even across the front. While holding the door in place, tighten the top hinge screws. Replace the hinge cover.

Normal operating sounds.



Newer refrigerators sound different from older refrigerators. Modern refrigerators have more features and use newer technology.

Do you hear what I hear? These sounds are normal.

HUMMM... WHOOSH...

- The new high efficiency compressor may run faster and longer than your old refrigerator and you may hear a high-pitched hum or pulsating sound while it is operating.
- Sometimes the refrigerator runs for an extended period, especially when the doors are opened frequently. This means that the **Frost Guard™** feature is working to prevent freezer burn and improve food preservation.
- You may hear a whooshing sound when the doors close. This is due to pressure equalizing within the refrigerator.



- You may hear the fans spinning at high speeds. This happens when the refrigerator is first plugged in, when the doors are opened frequently or when a large amount of food is added to the refrigerator or freezer compartments. The fans are helping to maintain the correct temperatures.
- If either door is open for over 3 minutes, you may hear the fans come on in order to cool the light bulbs.
- The fans change speeds in order to provide optimal cooling and energy savings.

LICKS, POPS, CRACKS and CHIRPS

- You may hear cracking or popping sounds when the refrigerator is first plugged in. This happens as the refrigerator cools to the correct temperature.
- The compressor may cause a clicking or chirping sound when attempting to restart (this could take up to 5 minutes).
- The electronic control board may cause a clicking sound when relays activate to control refrigerator components.
- Expansion and contraction of cooling coils during and after defrost can cause a cracking or popping sound.
- On models with an icemaker, after an icemaking cycle, you may hear the ice cubes dropping into the ice bucket.

WATER SOUNDS



- The flow of refrigerant through the freezer cooling coils may make a gurgling noise like boiling water.
- Water dropping on the defrost heater can cause a sizzling, popping or buzzing sound during the defrost cycle.
- A water dripping noise may occur during the defrost cycle as ice melts from the evaporator and flows into the drain pan.
- Closing the door may cause a gurgling sound due to pressure equalization.



For additional information on normal icemaker operating sounds, see the **About the automatic icemaker section.**

Before You Call for Service



Troubleshooting Tips
Save time and money! Review the charts on the following pages first and you may not need to call for service.

Problem	Possible Causes	What To Do
Refrigerator does not operate	Refrigerator in defrost cycle.	• Wait about 40 minutes for defrost cycle to end.
	Either or both controls set to <i>O (off)</i> position.	• Move the refrigerator and freezer control to a temperature setting.
	Refrigerator is unplugged.	• Push the plug completely into the outlet.
	The fuse is blown/circuit breaker is tripped.	• Replace fuse or reset the breaker.
Vibration or rattling (slight vibration is normal)	Leveling legs need adjusting.	• See <i>Leveling legs</i> .
Motor operates for long periods or cycles on and off frequently. (Modern refrigerators with more storage space and a larger freezer require more operating time. They start and stop often to temperatures.)	Normal when refrigerator is first plugged in.	• Wait 24 hours for the refrigerator to completely cool down.
	Often occurs when large amounts of food are placed in refrigerator.	• This is normal.
	Door left open.	• Check to see if package is holding door open.
	Hot weather or frequent door openings.	• This is normal.
	Temperature controls set at the coldest setting.	• See <i>About the controls</i> .
Refrigerator or freezer compartment too warm	Temperature control not set cold enough.	• See <i>About the controls</i>
	Warm weather or frequent door openings.	• Set the temperature control one step colder. See <i>About the controls</i>
	Door left open.	• Check to see if package is holding door open.
Frost or ice crystals on frozen food Too (frost within package is normal)	Door left open.	• Check to see if package is holding door open.
	Too frequent or too long door openings.	
Automatic icemaker (on some models) does not work	Icemaker power switch is in the <i>O (off)</i> position.	• Set the power switch to the <i>I (on)</i> position.
	Water supply turned off or not connected.	• See <i>Installing the water line</i> .
	Freezer compartment too warm.	• Wait 24 hours for the refrigerator to completely too warm. cool down.
	Piled up cubes in the storage bin cause the icemaker to shut off.	• Level cubes by hand.
Frequent "buzzing" sound	Ice cubes stuck in icemaker. (Green power light on icemaker blinking.)	• Turn off the icemaker, remove cubes and turn the icemaker back on.
	Icemaker power switch is in the <i>I (on)</i> position, but the water supply to the refrigerator has not been connected.	• Set the power switch to the <i>O (off)</i> position. Keeping it in the <i>I (on)</i> position will damage the water valve.

Problem	Possible Causes	What To Do
Ice cubes have odor/taste	Ice storage bin needs cleaning.	• Empty and wash bin. Discard old cubes.
	Food transmitting odor/taste to ice cubes.	• Wrap foods well.
	Interior of refrigerator needs cleaning.	• See <i>Care and cleaning</i> .
Slow ice cube freezing	Door left open.	• Check to see if package is holding door open.
	Temperature control not set cold enough.	• See <i>About the controls</i> .
No ice cube production	Supply line or shutoff valve is clogged.	• Call a plumber.
Refrigerator has odor	Foods transmitting odor to refrigerator.	• Foods with strong odors should be tightly wrapped. • Keep an open box of baking soda in the refrigerator; replace every three months.
	Interior needs cleaning.	• See <i>Care and cleaning</i> .
Moisture collects inside (in humid weather, air carries moisture into refrigerator when doors are opened)	Too frequent or too long door openings.	
Interior light does not work	No power at outlet.	• Replace fuse or reset the breaker.
	Light bulb burned out.	• See <i>Replacing the light bulb</i> .
Hot air from bottom of refrigerator motor.	Normal air flow cooling motor. In the refrigeration process, it is normal that heat be expelled in the area under the refrigerator. Some floor coverings are sensitive and will discolor at these normal and safe temperatures.	
Food freezing in the refrigerator	Food too close to air vent.	• Move the food away from the air vent (near the controls).
	Refrigerator control is set too cold.	• Move the refrigerator control to a warmer temperature.
Door does not close by itself	Leveling legs need adjusting.	• See <i>Leveling legs</i> .
Orange glow in the freezer	Defrost heater is on.	• This is normal.