



# DVD Recorder Receiver System OWNER'S MANUAL

**MODEL : LH-R4400**

(DR6900, LHS-A4400T, LHS-A4400C, LHS-A4400WA/WD/WX)



**Before connecting, operating or adjusting this product,  
please read this instruction booklet carefully and completely.**



## Safety Precautions



**CAUTION**  
RISK OF ELECTRIC SHOCK  
DO NOT OPEN



**WARNING:** TO REDUCE THE RISK OF ELECTRIC SHOCK DO NOT REMOVE COVER (OR BACK) NO USER-SERVICEABLE PARTS INSIDE REFER SERVICING TO QUALIFIED SERVICE PERSONNEL.



This lightning flash with arrowhead symbol within an equilateral triangle is intended to alert the user to the presence of uninsulated dangerous voltage within the product's enclosure that may be of sufficient magnitude to constitute a risk of electric shock to persons.



The exclamation mark within an equilateral triangle is intended to alert the user to the presence of important operating and maintenance (servicing) instructions in the literature accompanying the appliance.

**WARNING:** TO REDUCE THE RISK OF FIRE OR ELECTRIC SHOCK, DO NOT EXPOSE THIS PRODUCT TO RAIN OR MOISTURE.

**WARNING:** Do not install this equipment in a confined space such as a book case or similar unit.

CLASS 1 LASER PRODUCT  
KLASSE 1 LASER PRODUKT  
LUOKAN 1 LASER LAITE  
KLASS 1 LASER APPARAT  
CLASSE 1 PRODUIT LASER

### CAUTION:

This DVD Recorder employs a Laser System.

To ensure proper use of this product, please read this owner's manual carefully and retain for future reference should the unit require maintenance, contact an authorized service location (see service procedure).

Use of controls, adjustments, or the performance of procedures other than those specified herein may result in hazardous radiation exposure.

To prevent direct exposure to laser beam, do not try to open the enclosure. Visible laser radiation when open. DO NOT STARE INTO BEAM.

**CAUTION:** The apparatus must not be exposed to water (dripping or splashing) and no objects filled with liquids, such as vases, should be placed on the apparatus.



This product is manufactured to comply with the radio interference requirements of EEC DIRECTIVE 89/336/EEC, 93/68/EEC and 73/23/EEC.

**SERIAL NUMBER:** The serial number is found on the back of this unit. This number is unique to this unit and not available to others. You should record requested information here and retain this guide as a permanent record of your purchase.

Model No. \_\_\_\_\_

Serial No. \_\_\_\_\_

## Table of Contents

Safety Precautions .....	2
Table of Contents .....	3
Before Use .....	3
Precautions .....	3
Guide to symbols .....	3
Diagrams of equipment .....	4-5
Front View .....	4
Rear View .....	4
Display Window .....	4
Remote Control .....	5
Speaker Positioning .....	6
Connections .....	7-8
Speaker System Connection .....	7
Antenna (Aerial) Connections .....	7
Connecting to Optional Equipment .....	8
Display Information about External Digital Input Signal .....	8
Presetting the radio stations .....	9
Listening to the radio .....	9
RDS Function - OPTIONAL .....	10
About RDS .....	10
Programme Search (PTY) .....	10
Speaker Setup .....	11
Delay Time Setting .....	11
Mini Glossary for Sound Mode .....	12
Sound Adjustment .....	13
Sound Mode .....	13
Sound Level .....	13
Mute .....	13
Test Tone .....	13
Sleep Timer Setting .....	13
Selecting input source .....	13
Before Requesting Service .....	14
Specifications .....	15

## Before Use

### Precautions

#### Handling the unit

##### **When shipping the unit**

The original shipping carton and packing materials come in handy. For maximum protection, re-pack the unit as it was originally packed at the factory.

##### **To keep the surface clean**

Do not use volatile liquids, such as insecticide spray, near the unit. Do not leave rubber or plastic products in contact with the unit for a long period of time. They will leave marks on the surface.

##### **Installing**

- Do not install the unit in a confined space, such as a bookcase or built-in cabinet.
- Allow adequate air circulation to prevent internal heat buildup.
- Do not place the unit on surfaces (rugs, blankets, etc.) or near materials (curtains, draperies) that may block the ventilation slots.
- Do not install the unit near heat sources such as radiators or air ducts, or in a place subject to direct sunlight, excessive dust, mechanical vibration or shock.
- Do not place heavy objects on the unit.

#### Cleaning the unit

##### **To clean the cabinet**

Use a soft, dry cloth. If the surfaces are extremely dirty, use a soft cloth lightly moistened with a mild detergent solution. Do not use strong solvents, such as alcohol, benzene, or thinner, as these might damage the surface of the unit.

#### Guide to symbols

 Indicates hazards likely to cause harm to the unit itself or other material damage.

 Indicates special operating features of this unit.

 Indicates tips and hints for making the task easier.

*Manufactured under license from Dolby Laboratories. "Dolby", "Pro Logic", and the double-D symbol are trademarks of Dolby Laboratories. Confidential Unpublished works. Copyright 1992-1997 Dolby Laboratories. All rights reserved.*

*Manufactured under license from Digital Theater Systems, Inc. US Pat. No. 5,451,942 5,956,674, 5,974,380, 5,978,762 and other world-wide patents issued and pending. "DTS" and "DTS Digital Surround" are registered trademarks of Digital Theater Systems, Inc. Copyright 1996, 2000 Digital Theater Systems, Inc. All rights reserved.*

# Diagrams of equipment

## Front View

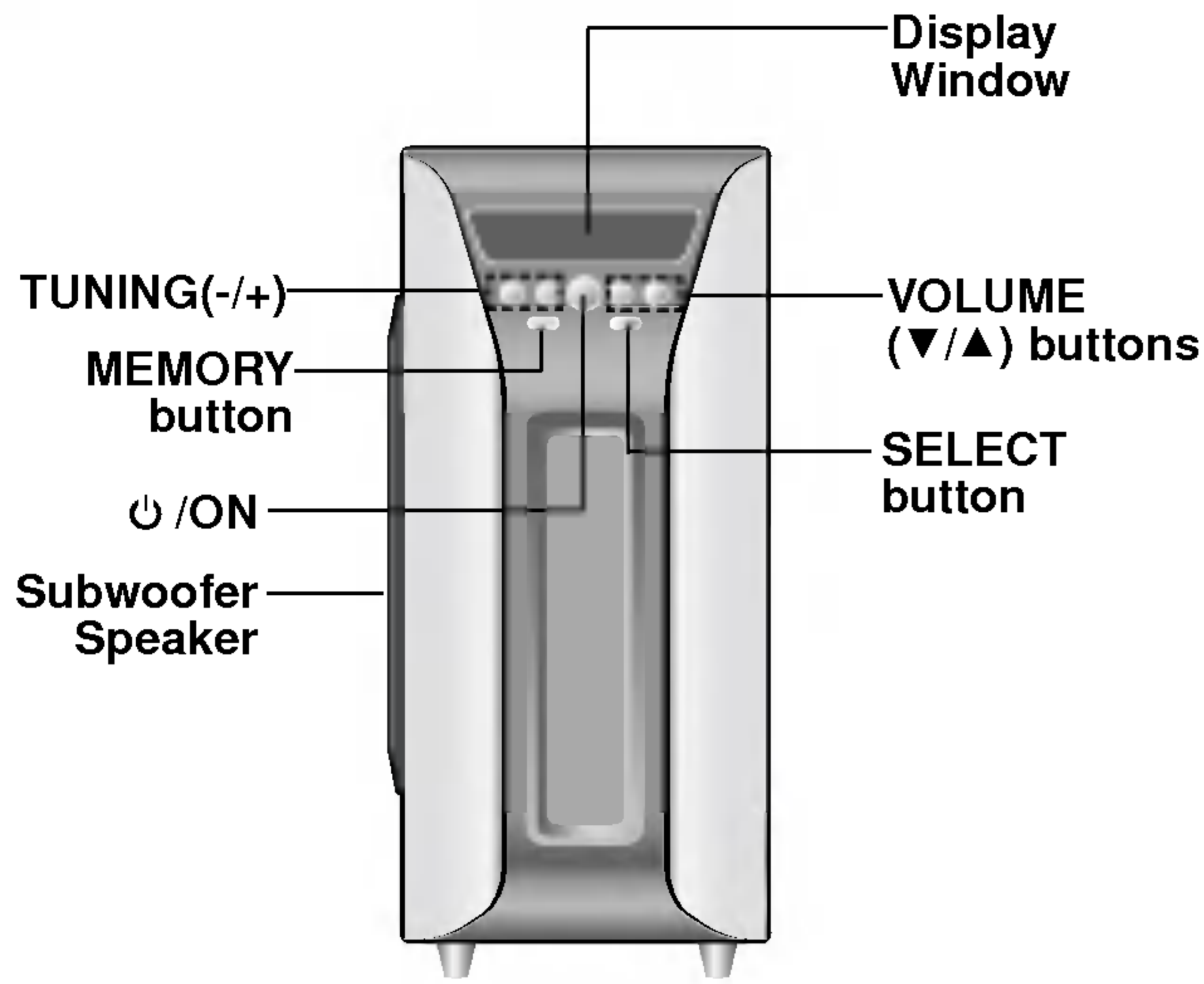

## Rear View

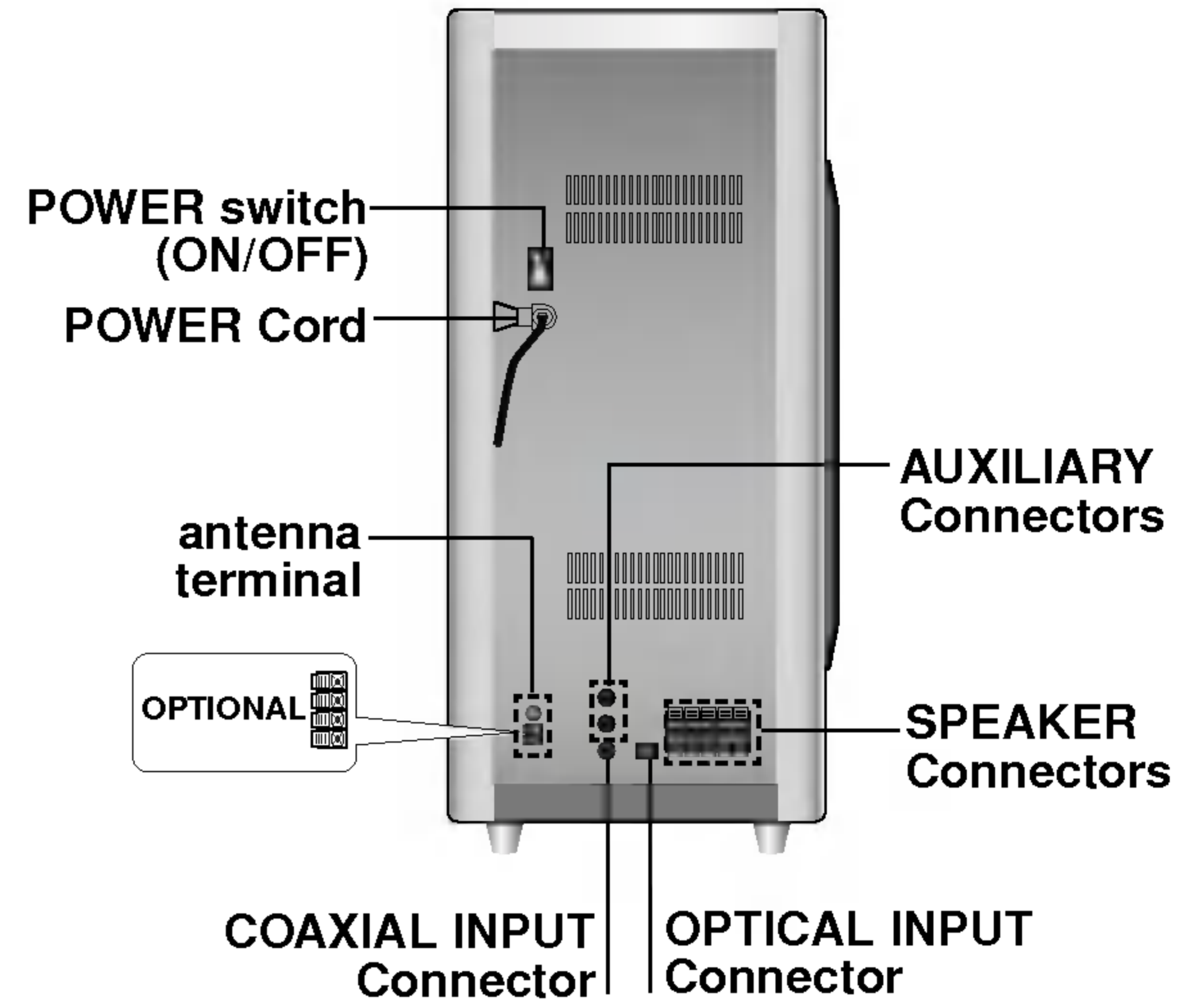

## Display Window

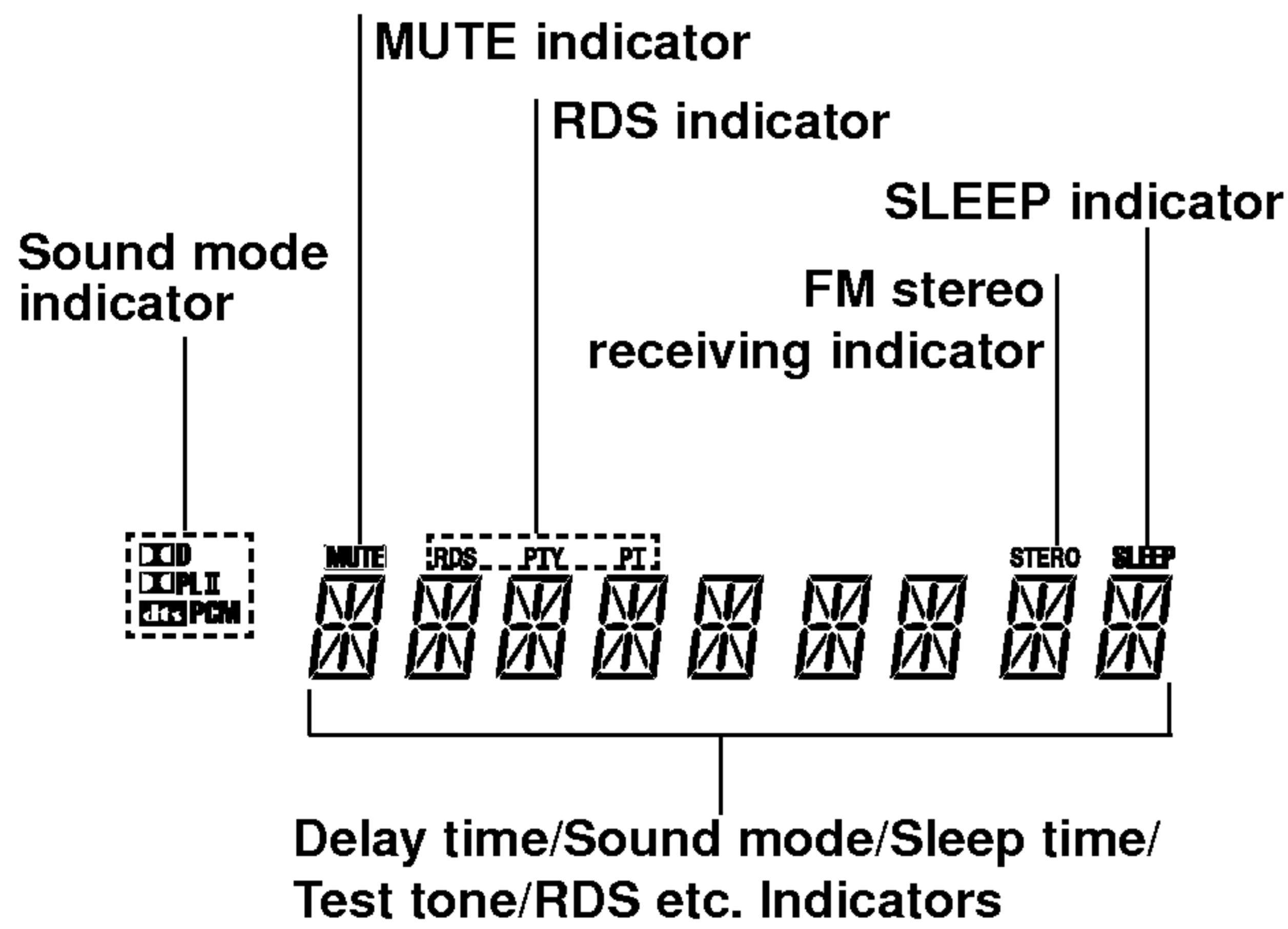

## Diagrams of equipment

### Remote control

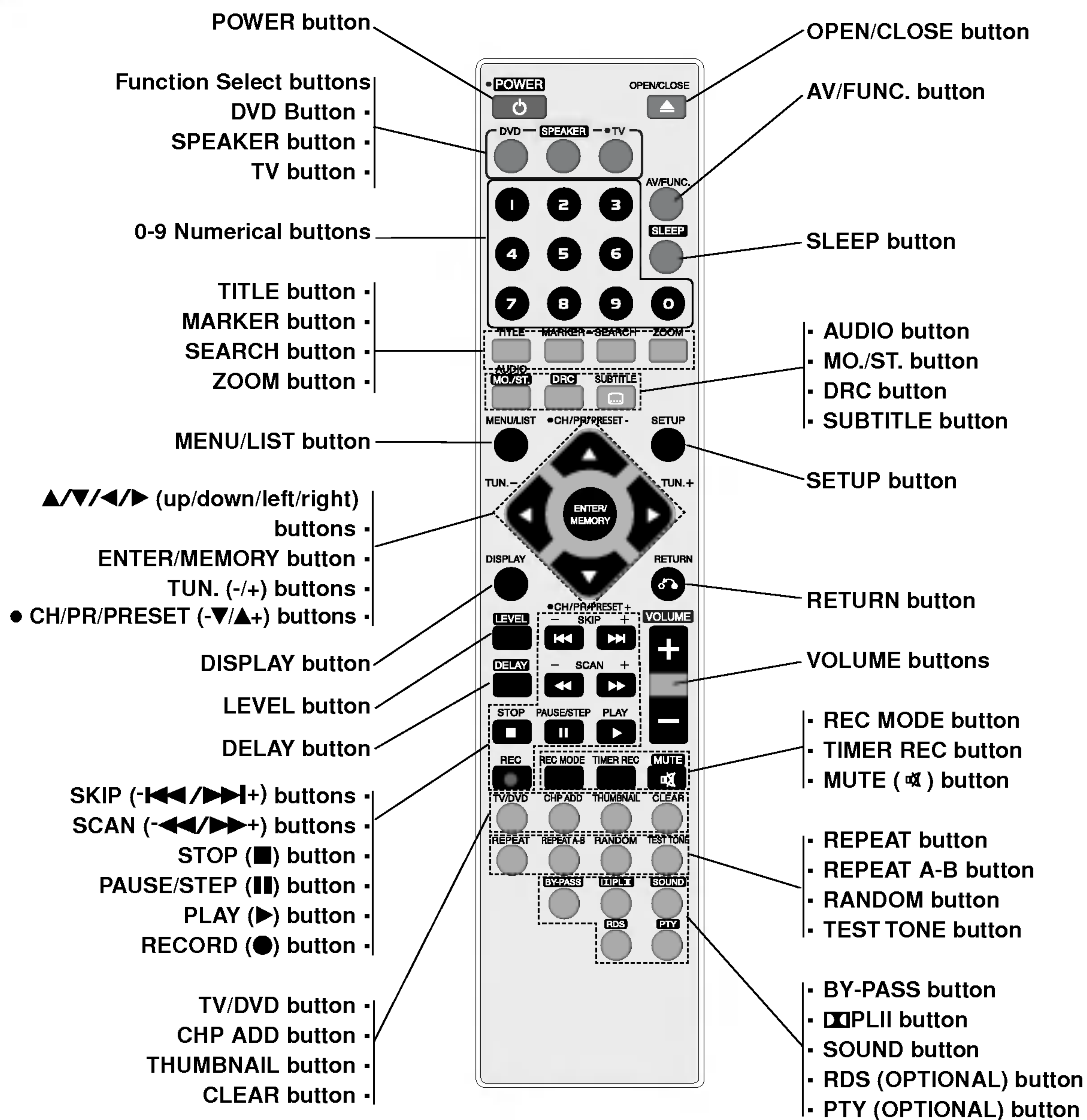

### Controlling TV with the remote control

The remote control can operate your TV's functions. (LG brand only)

- Hold TV and press CH ▼ or CH ▲ button repeatedly until turn the TV on or off.

### Remote Control Operation Range

Point the remote control at the remote sensor and press the buttons.

- **Distance:** About 23 ft (7 m) from the front of the remote sensor
- **Angle:** About 30° in each direction of the front of the remote sensor

### Remote control battery installation

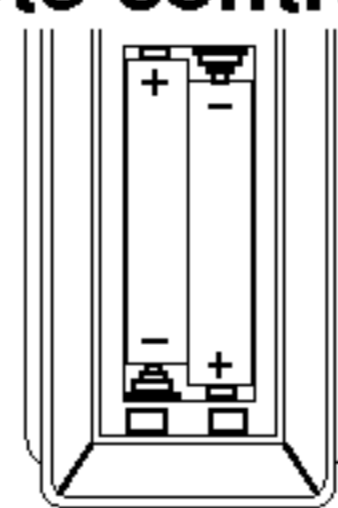

Detach the battery cover on the rear of the remote control, and insert two R03 (size AAA) batteries with ⊕ and ⊖ aligned correctly.

### Caution

Do not mix old and new batteries. Never mix different types of batteries (standard, alkaline, etc.).

## Speaker Positioning

In the case of normal use of the 5 speakers (2 front speakers, center speaker and 2 rear speakers).

- **Front speakers**

According to your listening position set up the speakers equal distance, apart and set up the interval between speakers to 45 degrees.

- **Center speaker**

It is ideal that the center speakers and front speakers are same height. But you can place it above or below the television.

- **Rear speakers**

Place the left and right behind the listening area. These speakers recreate sound motion and atmosphere required for surround playback. For best results, do not install the rear speakers too far behind the listening position and install them at or above the level of the listener's ears. It is also effective to direct the rear speakers towards a wall or ceiling to further disperse the sound.

In the case of a smaller room size, if the audience is near to the rear wall set the rear speakers opposite each other, and set the rear speakers above 60 - 90 cm than the listener's ears.

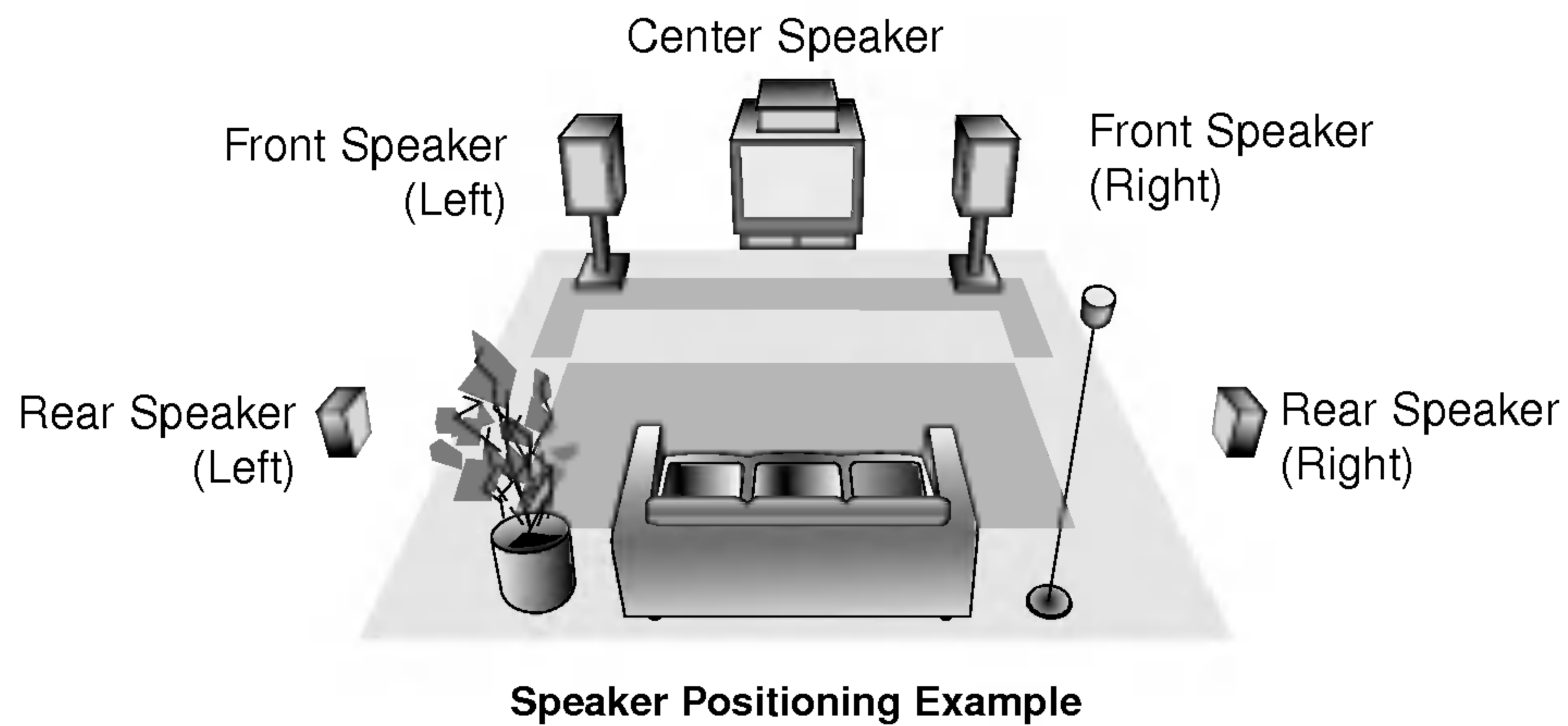

## Connections

### Speaker System Connection

Connect the speakers using the supplied speaker cords by matching the colors of the terminals and those of the cords. To obtain the best possible surround sound, adjust the speaker parameters (distance, level, etc.).

#### Notes

- Be sure to match the speaker cord to the appropriate terminal on the components: + to + and – to –. If the cords are reversed, the sound will be distorted and will lack base.
- If you use front speakers with low maximum input rating, adjust the volume carefully to avoid excessive output on the speakers.
- Do not disassemble the front cover of supplied speaker.

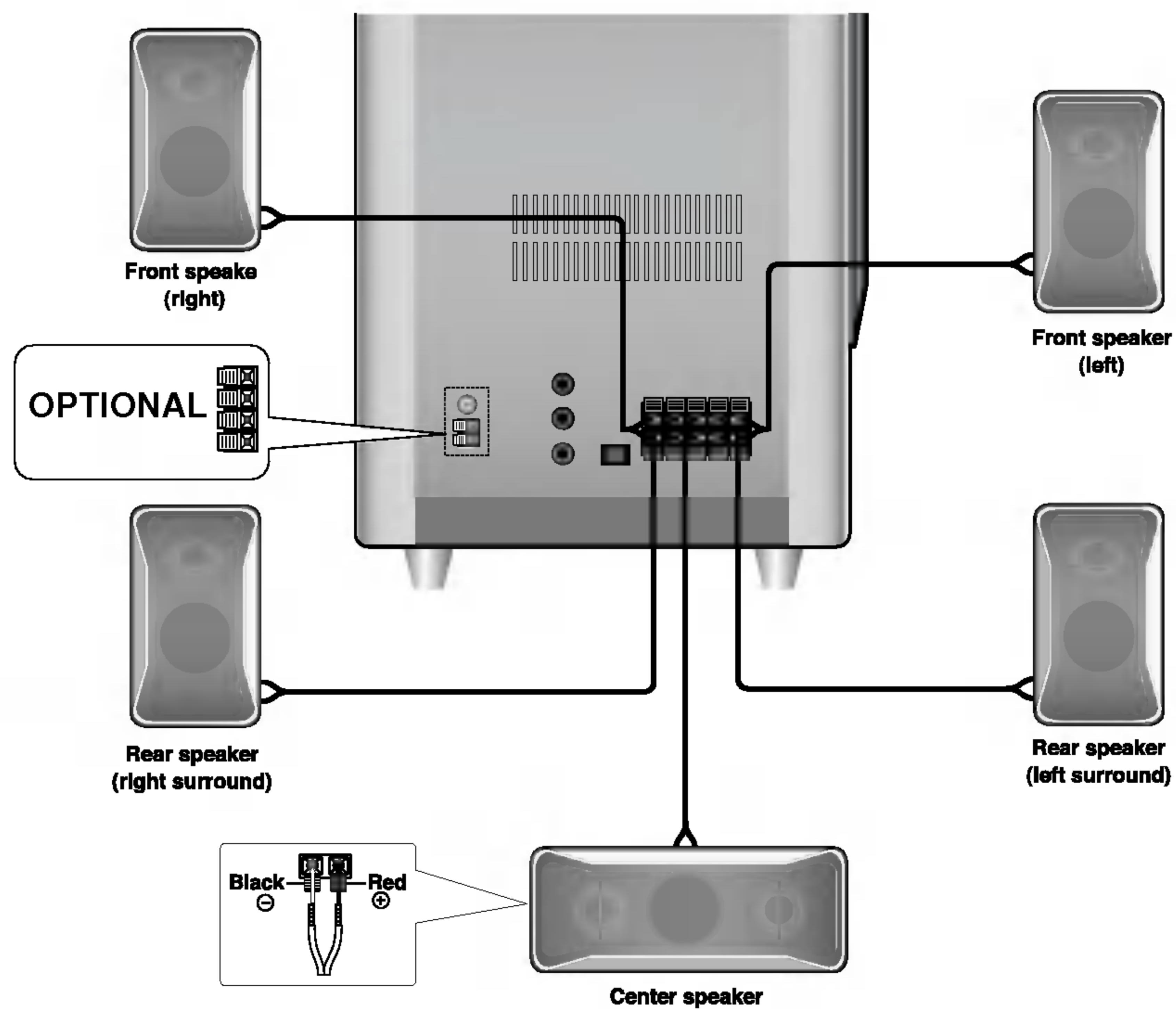

### Antenna (Aerial) Connections

Connect the supplied FM/AM antennas for listening to the radio.

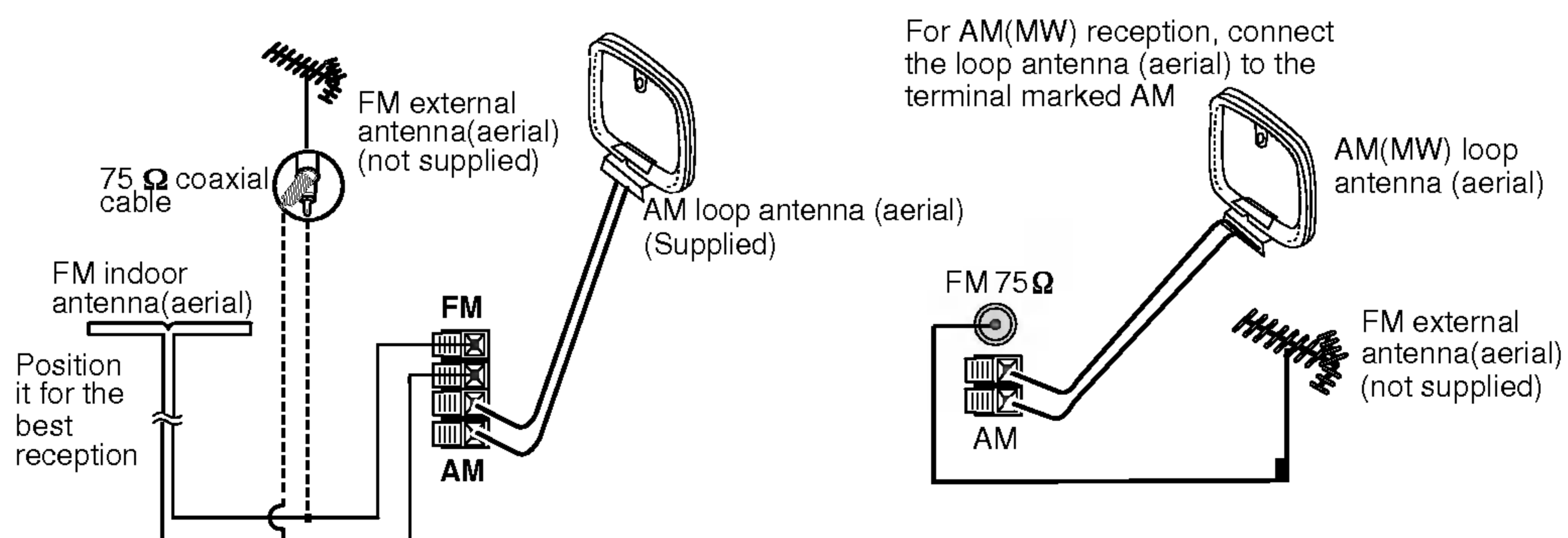

#### Notes

- To prevent noise pickup, keep the AM loop antenna away from the unit and other components.
- Be sure to fully extend the FM wire antenna.
- After connecting the FM wire antenna, keep it as horizontal as possible.

## Connections (Cont'd)

### Connecting to Optional Equipment

#### Connecting to amplifier with two-channel analog stereo or Dolby Surround

Connect Left and Right AUX INPUT jacks on the Dolby Digital Speaker System into the Audio Left and Right OUT jacks on your DVD player, Digital Device or stereo system by the supplied audio cables (**A**).

Connect one of the Dolby Digital Speaker System DIGITAL AUDIO OUT jacks (OPTICAL **O** or COAXIAL **C**) to the corresponding out jack on your DVD player, Digital Device or Stereo system. Use an optional digital (optical **O** or coaxial **C**) audio cable.

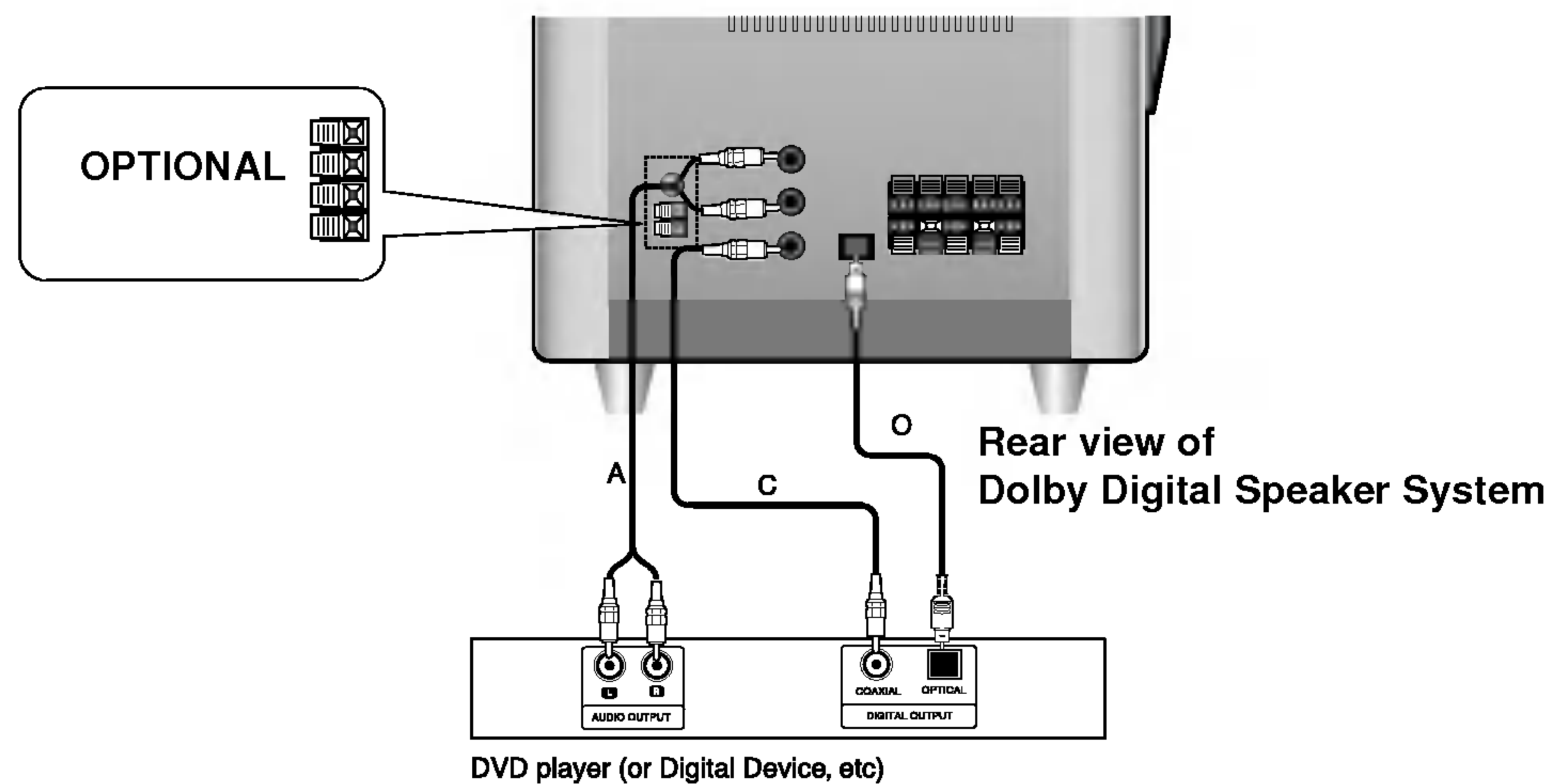

## Display Information about External Digital Input Signal

This display appears depending on the change of the external digital input signal.

<b>UNLOCK DISPLAY</b>	appears when the problem gets in external digital input while normally operating in optical or coaxial function. It could be displayed instantaneously according to the external system quality while operating in switching audio or in skip, open and channel up/down.
<b>CHANNEL DISPLAY</b>	appears when the Audio coding mode is changed or when the stream information is changed or the function mode is switched.
1+1	ch1, ch2
1/0	C
2/0	L, R
3/0	L, R, C
2/1	L, R, S(Mono Surround)
2/2	L, R, Ls, Rs
3/1	L, R, C, S(Mono Surround)
3/2	L, R, C, Ls, Rs
.1	LFE signal, no LFE signal

## Presetting the radio stations

### Note

Adjust POWER switch on the backpanel to select ON before operation

You can preset 50 stations for FM and AM. Before tuning, make sure that you have turned down the volume to the minimum.

### 1 Press SELECT (or AV/FUNC. on the remote control) to select the frequency (AM or FM) you want.

Every time you press this button, AM and FM changes alternately.

### 2 Press TUNING (-/+) (or TUN.(-/+) on the remote control) until the frequency indication starts to change.

### Notes

#### • Automatic Tuning

Press TUNING (-/+) (or TUN.(-/+) on the remote control) for more than 0.5 seconds.

- Scanning stops when the unit tunes in a station.

#### • Manual Tuning

Press TUNING (-/+) (or TUN.(-/+) on the remote control) briefly and repeatedly.

### 3 Press MEMORY.

A preset number will flash in the display window.

### 4 Press PRESET (-/+) to select the preset number you want.

### 5 Press MEMORY.

- The station is stored.

### 6 Repeat steps 2 to 5 to store other stations.

#### To clear all the memorized stations

Press and hold MEMORY for about two seconds, "MEM CLEAR" appears on the display window and then press MEMORY, the stations are cleared.

#### For your reference

If all stations have already been entered, FULL message will appear in the display window for a moment and then a preset number will blink. To change the preset number, follow the steps 4-5.

#### To recall presets

Press and hold PRESET (-/+) until the desired preset number appears or press it repeatedly.

## Listening to the radio

### 1 Press SELECT (or AV/FUNC. on the remote control) to select the frequency (AM or FM) you want.

Every time you press this button, AM and FM changes alternately.

The last received station is tuned in.

### 2 Press PRESET (-/+) repeatedly to select the preset station you want.

- Each time you press the button, the unit tunes in one preset station at a time.

### 3 Adjust the volume by pressing VOLUME (-/+) repeatedly.

#### To listen to non-preset radio stations

- Use manual or automatic tuning in step 2.
- For automatic tuning, press and hold TUNING (-/+) (or TUN.(-/+) on the remote control).

#### To turn off the radio

Press POWER to turn the unit off or select another function mode.

#### For your reference

##### • If an FM program is noisy

Press MO./ST. so that "STEREO" disappears on the display window. There will be no stereo effect, but the reception will be improved. Press MO./ST again to restore the stereo effect.

##### • To improve reception

Repose the supplied antennas.

## RDS Function - OPTIONAL

### About RDS

This unit is equipped with RDS (Radio Data System), which brings a wide range of information from FM radio. RDS is a system for transmitting station call signs or network information, a description of station programme type text message about the station or specifics of musical selection and the correct time.

### RDS Tuning

When a FM station containing RDS data is tuned in, the unit will automatically display the station's call sign and the RDS indicator will light in the Display Window as well as indicators for the programme type recognition (PTY), Radio Text (RT), Clock Time (CT) and RDS service programme (PS) if transmitted by the station.

### RDS Display Options

The RDS system is capable of transmitting a wide variety of information in addition to the initial call sign that appears when a station is first tuned. In normal RDS operation the display will indicate the station name, broadcast network or call letters. Pressing **RDS** on the front panel enables you to cycle through the various data types in the sequence:

(PS → FREQUENCY → PTY → RT → CT)

- **PTY (Programme type recognition)**- The programme type is shown on the display window.
- **RT (Radio text recognition)**- The radio station's name is displayed on the display window.
- **CT (Time controlled by the channel)**- Enable the unit to receive the actual time and show it on the display window.
- **PS (Programme Service name)**- The programme title is displayed on the display window.

#### Note

Some RDS stations may not choose to include some of these additional features. If the data required for the selected mode is not being transmitted, the Display Window will show a **PTY NONE, RT NONE, CT NONE, PS NONE** message.

### Programme Search (PTY)

A major benefit of RDS is its ability to encode broadcasts with Programme Type (PTY) codes that indicate the type of material being broadcast. The following list shows the abbreviations used to indicate each PTY along with an explanation of the PTY.

NEWS	News
AFFAIRS	Current Affairs
INFO	Information
SPORT	Sports
EDUCATE	Educational
DRAMA	Drama
CULTURE	Culture
SCIENCE	Science
VARIED	Varied Speech Programme
POP M	Popular Music
ROCK M	Rock Music
EASY M	Easy Listening Music
LIGHT M	Classical Music
CLASSICS	Serious Classical Music
OTHER M	Other Music
WEATHER	Weather Information
FINANCE	Financial Programmes
CHILDREN	Children's Programmes
SOCIAL	Social Affairs Programmes
RELIGION	Religious Broadcasts
PHONE IN	Phone-In Programmes
TRAVEL	Travel and Touring
LEISURE	Leisure and Hobby
JAZZ	Jazz Music
COUNTRY	Country Music
NATION M	National Music
OLDIES	Oldies Music
FOLK M	Folk Music
DOCUMENT	Documentary Programmes
TEST	Station Alarm Test Message
ALARM 1	Emergency Broadcast Information

You may search for a specific Programme Type (PTY) by following these steps:

- 1** Press **SELECT** (or **AV/FUNC.** on the remote control) to select FM mode.
- 2** Select a desired station by pressing **TUNING (-/+)** (or **TUN.(-/+)** on the remote control). When the RDS transmission is received, the display shows the program service name (PS) after RDS indicator appears.
- 3** Press the **RDS** to select PTY mode.
- 4** To search for a different PTY, press the **PRESET (-/+)** while the last PTY in use is still displayed to scroll through the list of available PTY types.
- 5** When the PTY is selected, press the **TUNING (-/+)** (or **TUN.(-/+)** on the remote control) within 5 seconds. The unit will go into an automatic search mode and attempt to find the next station with acceptable signal strength that matches the desired PTY type.

## Speaker Setup

### Delay Time Setting

In Dolby Digital or Dolby Pro Logic mode it is assumed that the distance from the listener to each of the speakers is equal. If not then setting the delay times of the center or rear speakers the sound will be heard simultaneously by the listener.

The interval from the speakers to the listener. If the distance from the listener to each speakers is same, in the Dolby Digital and Dolby Pro Logic mode the delay time of each speakers is as following.

#### In Dolby Digital mode

Center delay time : 0 ~ 5ms

Rear delay time: 0 ~ 15ms

#### In Dolby Pro Logic mode

Center delay time : cannot change

If the rear delay time is set in Dolby Digital mode, in the Dolby Pro Logic mode the delay time will be automatically set.

The delay time is 1 msec per 30 cm.

If the center and rear speakers are further than the front speakers from the listener, the delay time will be at minimum.

### Surround delay time setting

If the distance of Ds is equal to or longer than the DF in the left figure, set the Surround Delay Time as 0ms.

Otherwise, change the setting according to the below.

Eg) If the distance from front speakers to the listener is 3 m and from rear speakers from the listener is 1.5 m, in the Dolby Digital mode the rear delay time is 5 msec.

$3\text{m (DF)} - 1.5\text{m (Ds)} = 1.5\text{m (B)}$

$1.5\text{m (B)} = 150\text{cm} / 30\text{cm} = 5\text{msec}$

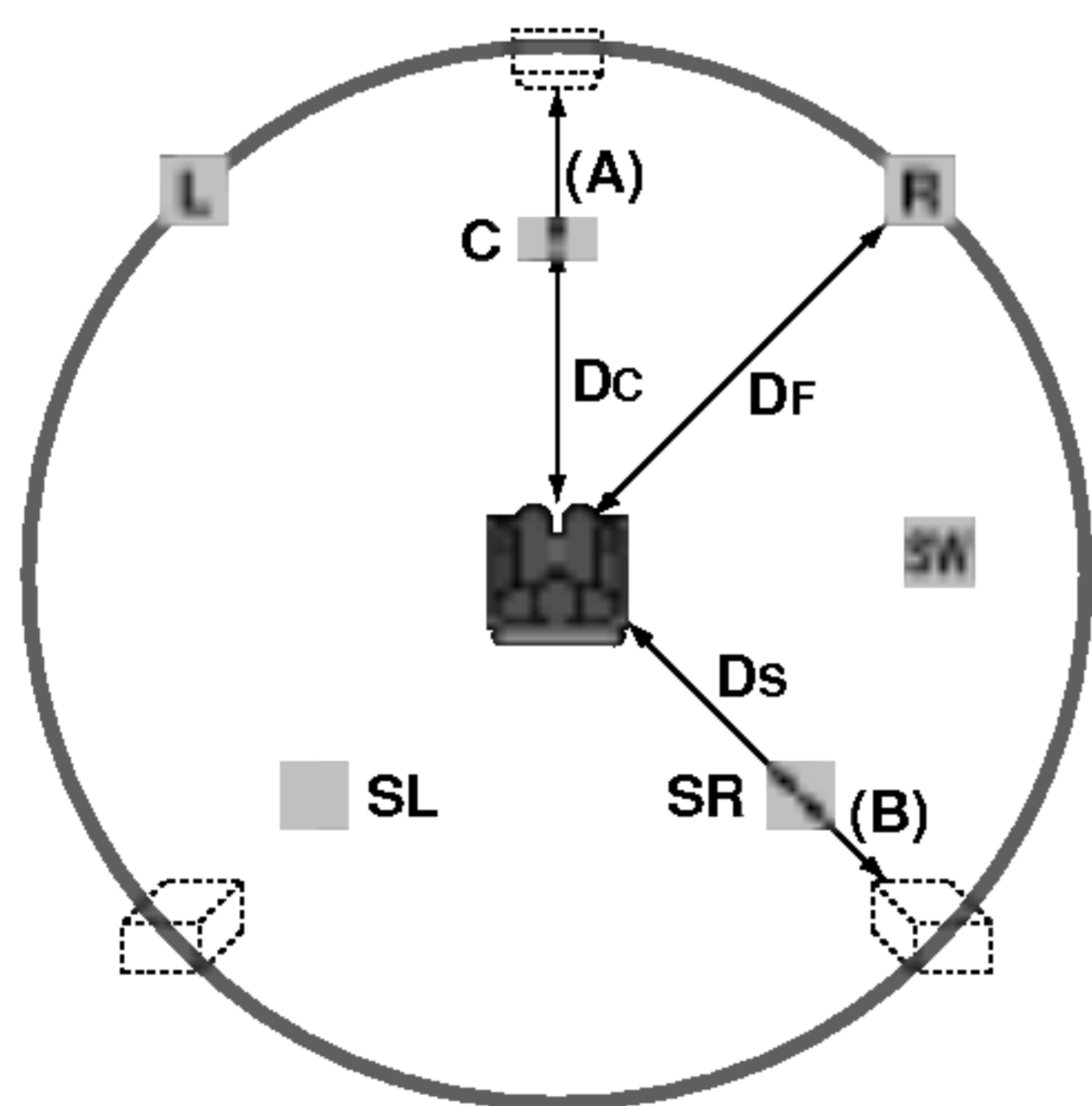

In Dolby Pro Logic II (Surround delay time):

- Prologic: 15 ~ 30msec
- Movie: 10 ~ 25msec
- Music: 0 ~ 15msec
- Matrix: 0 ~ 15msec

### Center delay time setting (Dolby Digital mode only)

If the distance of DF is equal to the distance of DC in the left figure, set the Center Delay Time as 0ms. Otherwise, change the setting according to the information below.

Eg) If the distance from the front speakers to the listener is 3m and from the center speaker to the listener is 2.4m, the center delay time is 2msec.

$3\text{m (DF)} - 2.4\text{m (DC)} = 60\text{cm (A)}$

$60\text{cm (A)} / 30\text{cm} = 2\text{msec}$

### Setting the delay time in the Dolby Digital and Dolby Pro Logic (II) mode

#### 1 Press DELAY.

The current surround delay time appears in the display window.

You can select center delay time by pressing ◀/▶ in the Dolby Digital mode only.

#### 2 Press ▲/▼ to change the delay time.

#### 3 If setting is complete, press DELAY.

#### Note

You can adjust the center delay time only in the Dolby Digital mode and its delay time appears.

### Center Width (MUSIC mode of Dolby Pro Logic II only)

This control allows center-channel sounds to be positioned between the center speaker and the left/right speakers over a range of eight steps. Step "3" uses a combination of all three front speakers to give the best vocal imaging and most seamless soundstage presentation, and is recommended for most recordings. Step "0" places all center sound in the center speaker. Step "7" places all center sound equally in the left/right speakers, just as in conventional stereo.

### DIMENSE (MUSIC mode of Dolby Pro Logic II only)

This control allows the user to gradually adjust the soundfield either towards the front or the rear. This can be useful to help achieve the desired balance from all the speakers with certain recordings that may contain either too much or too little spatial effect. Step "0" is the recommended setting, which has no effect on the sound. Steps 1, 2, and 3 gradually move the sound forward, and steps -1, -2, and -3 move the sound towards the surrounds.

### PANORAMA (MUSIC mode of Dolby Pro Logic II only)

This control extends the front stereo image to include the surround speakers for an exciting "wraparound" effect with side-wall imaging. It is particularly effective for recordings which have strong left- or right-channel elements in the mix, as these are detected and accentuated by the Panorama process.

## Mini Glossary for Sound Mode

### **dtS**

Allows you to enjoy 5.1(or 6) discrete channels of high quality digital audio from DTS program sources bearing the trademark such as discs, DVD and compact discs, etc. DTS Digital Surround delivers up to 6 channels of transparent audio(which means identical to the original masters) and results in exceptional clarity throughout a true 360 degree sound field. The term DTS is a trademark of DTS Technology, LLC. Manufactured under license from DTS Technology, LLC.

### **DOLBY DIGITAL**

The Dolby Digital surround format lets you enjoy up to 5.1 channels of digital surround sound from a Dolby Digital program source. If you play DVDs with "DOLBY DIGITAL" mark, you can enjoy even better sound quality, greater spatial accuracy, and improved dynamic range.

### **HALL 1**

When playing recordings of live music and classic, this mode provides a feeling similar to actually being in a small concert hall.

### **HALL 2**

When playing recordings of live music and classic, this mode provides a feeling similar to actually being in a large concert hall.

### **THEATER**

This mode provides a three dimensional effect similar to that of movie theater.

### **DOLBY PRO LOGIC (II)**

Dolby Pro Logic II creates five full-bandwidth output channels from two-channel sources. This is done using an advanced, high-purity matrix surround decoder that extracts the spatial properties of the original recording without adding any new sounds or tonal colorations.

#### **PROLOGIC mode:**

The Pro Logic Emulation mode offers users the same robust surround processing as original Pro Logic, in case the source content is not of optimum quality, or if there is a desire to hear the program more "as it used to be." When this mode is used, it is called Pro Logic, as before. There is no "Pro Logic I" mode. The Pro Logic emulation mode is optional. Dolby does not require PLII products to use the original Pro Logic decoding algorithm. However, if the DSP contains the original Pro Logic code, and if the product maker would like to use it, this is quite acceptable and even encouraged. A product must not offer both original Pro Logic and the Pro Logic emulation mode.

#### **MOVIE mode:**

The Movie mode is for use with stereo television shows and all programs encoded in Dolby Surround. The result is enhanced soundfield directionality that approaches the quality of discrete 5.1-channel sound.

#### **MUSIC mode:**

The Music mode is for use with any stereo music recordings, and provides a wide and deep sound space. The Music mode includes controls that allow the sound to be tailored to individual listening tastes.

#### **MATRIX mode:**

The Matrix mode is the same as the Music mode except that the directional enhancement logic is turned off. It may be used to enhance mono signals by making them seem "larger." The Matrix mode may also find use in auto systems, where the fluctuations from poor FM stereo reception can otherwise cause disturbing surround signals from a logic decoder. The ultimate "cure" for poor FM stereo reception may be simply to force the audio to mono.

### **SURROUND OFF (2CH STEREO)**

Outputs the sound from the front left and right speakers and subwoofer. Standard two channel (stereo) sources completely bypass the sound field processing. This allows you to play any source using only the front left and right speakers and subwoofer. **You can select SURROUND OFF by pressing BY-PASS on the remote control.**

### **Dynamic Range Control (DRC)**

With the DVD\*1 format, you can hear a program's soundtrack in the most accurate and realistic presentation possible, thanks to digital audio technology. However, you may wish to compress the dynamic range of the audio output (the difference between the loudest sounds and the quietest ones). Then, you may listen to a movie at a lower volume without losing clarity of sound. **You can select DRC ON or OFF by pressing DRC on the remote control.**

\*1: Dolby Digital only

## Sound Adjustment

### Sound Mode

**When PCM indicator only is displayed in the display window:**

Each time you press **SOUND** button, the sound mode is changed as the following order;

PRO LOGIC → HALL1 → HALL2 → THEATER



Each time you press **PL II** button, the sound mode of Pro Logic II is changed as the following order;



PRO LOGIC → MOVIE → MUSIC → MATRIX



#### Tip

You can select SURROUND OFF (2CH STEREO) mode by pressing BY-PASS button.

**For your reference**

- You can identify the encoding format of program software by looking at its packaging.
  - Dolby Digital discs are labeled with the  logo.
  - Dolby Surround encoded programs are labeled with the  logo.
  - DTS Digital Surround discs are marked with DTS.

### Sound Level

You can set the sound level of the desired channel.

#### 1 Press LEVEL.

The level indicator will appear in the display window.

#### 2 Press ◀/▶ to select a desired speaker to set.

Each time you press the ◀/▶ button, it is changed as the following order;

FL (Front Left) → C (Center) → FR (Front Right) →  
SR (Surround Right) → SL (Surround Left) →  
SW (Subwoofer) → FL (Front Left)

- On the 2 channel stereo mode, you can only select the SW (Subwoofer).

#### 3 Press ▲/▼ to adjust the sound level of the selected channel. (-6dB ~ +6dB)

#### 4 Repeat step 2-3 and adjust the sound level of the other channels.

#### 5 If setting is complete, press LEVEL.

### Mute

**Press MUTE to mute your unit.**

You can mute your unit in order, for example, to answer the telephone, "MUTE" indicator flashes in the Display Window.

### Test Tone

This function allows you can easily adjust the sound balance of the speakers from the listener's position.

#### 1 Select the test tone mode by pressing TEST TONE.

- A hiss noise comes out for 2 seconds from each speakers in the following order;  
FL (Front Left) → C (Center) → FR (Front Right) →  
SR (Surround Right) → SL (Surround Left) →  
SW (Subwoofer) → FL (Front Left)

#### 2 You can adjust the sound level during operating the test tone, first press LEVEL then press ▲/▼ buttons, so that all speaker's sound level is same from the listener's position.

- During operating the test tone, if you adjust the sound level, it will be paused in the current speaker channel.

#### 3 If setting is complete, press TEST TONE.

### Sleep Timer Setting

You can set the Surround Sound System to turn off automatically at a specified time.

#### 1 Press SLEEP to set the desired sleep time.

The SLEEP indicator and sleep time appears in the display window.

#### 2 Each time you press SLEEP the setting changes in the following order.

SLEEP 180 → 150 → 120 → 90 → 80 → 70 → 60 → 50 → 40 →  
30 → 20 → 10 → OFF

#### Note

**You can check the time remaining before the Surround Sound System turns off.**

Press SLEEP. The remaining time appears in the display window.

### Selecting input source

You can use DVDs or other units connected to the AUX INPUT(R/L), COAXIAL INPUT or OPTICAL INPUT connector. Refer to the owners manual supplied with the unit for further information on the operation.

**Press SELECT repeatedly on the front panel or press AV/FUNC. repeatedly on the remote control to select the desired input source.**

Each time you press this button, the mode of the function changes in the following sequence:

- **ANALOG:** for selecting the analog signal from AUX INPUT (R/L) Connectors.
- **OPTICAL:** for selecting the digital signal from OPTICAL IN Connector.
- **COAXIAL:** for selecting the digital signal from COAXIAL IN Connector.

#### Note

The Optical input function is available only when the other unit's Sampling Frequency is 32 ~ 48kHz.

## Before Requesting Service

Symptom	Cause	Correction
No sound.	• Speaker cords are not connected securely.	• Connect them securely.
	• Speaker cords are not connected correctly.	• Connect them correctly, that is L (left) to L, R (right) to R.
Power is not supplied even though the POWER button is pressed in.	• The power cord is not plugged in.	• Plug the power cord into an AC outlet.
The remote control does not work properly.	• The remote control is not pointed at the remote sensor of this unit.	• Point the remote control at the remote sensor of this unit.
	• The remote control is too far from this unit.	• Operate the remote control within about 23 ft (7 m).
	• There is an obstacle in the path of the remote control and this unit.	• Remove the obstacle.
	• The batteries in the remote control are exhausted.	• Replace the batteries with new ones.

## Specification

Power supply		Refer to the main label		
Power consumption		60 W		
Mass		10 kg		
External dimensions (W x H x D)		246 x 430 x 420 mm		
Operating conditions		Temperature: 5°C to 35°C, Operation status: Horizontal		
Frequency response (audio)		120 Hz to 20 kHz		
Signal-to-noise ratio (audio)		More than 75 dB (1 kHz, NOP, W/IHF-A & 20 kHz Filter)		
Harmonic distortion (audio)		1.0 % (1 kHz, at 12W position) (20 kHz LPF/A Filter)		
Surround mode		Front: 60W + 60W (THD 10 %) Center*: 60W Surround*: 60W + 60W (8Ω at 1 kHz, THD 10 %) Subwoofer*: 120W (4Ω at 250 Hz, THD 10 %)		
<b>FM</b>	Tuning Range	87.5 - 108.0 MHz or 65 - 74 MHz, 87.5 - 108.0 MHz		
	Intermediate Frequency	10.7 MHz		
	Signal to Noise Ratio	60/55 dB		
	Frequency Response	140 - 10,000 Hz		
<b>AM</b>	Tuning Range	522 - 1611 kHz or 530 - 1610 kHz or 530 - 1720 kHz		
	Intermediate Frequency	450 kHz		
	Signal to Noise Ratio	37 dB		
	Frequency Response	140 - 25,000 Hz		
Inputs		AUX, COAXIAL, OPTICAL AUDIO		
Model	Satellite Speaker (LHS-A4400T)	Center Speaker (LHS-A4400C)	Active Subwoofer (LHS-A4400WA/WD/WX)	
Type	2 Way 2 Speaker	2 Way 2 Speaker	1 Way 1 Speaker	
Impedance	8 Ω	8 Ω	4 Ω	
Frequency Response	120 - 20,000 Hz	120 - 20,000 Hz	40 - 180 Hz	
Sound Pressure Level	84 dB/W (1m)	84 dB/W (1m)	82 dB/W (1m)	
Rated Input Power	60 W	60 W	120 W	
Max. Input Power	120 W	120 W	240 W	
Net Dimensions (W x H x D)	100 x 162 x 120 mm	225 x 102 x 120 mm	246 x 430 x 420 mm	
Net Weight	0.8 kg	0.9 kg	10 kg	

\* Designs and specifications are subject to change without notice.



# DVD RECORDER OWNER'S MANUAL



Before connecting, operating or adjusting this product,  
please read this instruction booklet carefully and completely.

# Table of Contents

## INTRODUCTION

Table of Contents	2-3
DVD Recorder Overview	4-9
Recordable Discs	4
Playable Discs	4
Disc-related terms	5
• Types of video CDs	5
About Symbols	5
• About the  symbol display	5
• About the disc symbols for instructions	5
About recordable discs	6
• What are 'recording modes'?	6
• Is editing a DVD like editing a video tape?	6
• About word 'Original' and 'Playlist'	6
About DVD recording	7-8
• Disc types and recording formats, modes, and settings	7
• Recording TV audio channels	7
• Notes for recording	7
• Restrictions on video recording	8
• What is 'CPRM'?	8
• Copyright	8
Resetting the DVD Recorder	8
Precautions	9
• Handling the unit	9
• Cleaning the unit	9
Notes on Discs	9
• Handling discs	9
• Storing discs	9
• Cleaning discs	9
Front Panel	10
Function Display Window	11
Rear Panel Connections	12

## DVR HOOKUP

Connections	13-17
Connecting to the Aerial	13
Connections to Your TV	14
Connecting to a cable box or satellite receiver	15
Connecting an external decoder box	15
Connecting to an Amplifier	16
Accessory Audio/Video (A/V) Connections to DVD Recorder	17
Connecting a Digital Camcorder	17

## DVR SETUP

Pre-operation Setup	18-29
Initial Settings	18
General Operation	18
General	18-23
• Auto Programming	18
• Program Edit	19-20
• Auto Clock Set	21
• Manual Clock Set	21
• TV Aspect Ratio	21
• Display Mode	22
• AV1 Decoder	22
• Progressive Scan	22
• PBC (On/Off)	23
• Factory Set	23
Language	23
• Display Language	23
• Disc Language	23
Audio	24
• Dolby Digital	24
• DTS	24
• MPEG	24
• Sampling Frequency	24
• DRC (Dynamic Range Control)	24
• Vocal	24
Lock (Parental Control)	25-26
• Set Password	25
• Rating	25
• Country Code	26
Recording	26-27
• Record Mode Set	26
• Record Aspect	26
• DV Record Audio	26
• Auto Chapter	27
Disc	27-28
• Disc Format	27
• Disc Protect	27
• Finalize	28
• Disc Label	28
Overview for the On-Screen Display	29
• Displaying Information While Watching TV	29
• Disc Information On-screen Display	29

# Table of Contents

## PLAYBACK









<b>DVD and Video CD Operation</b> . . . . .	<b>30-33</b>
DVD or Video CD Playback . . . . .	30
General Features . . . . .	30
• TITLE Selection . . . . .	30
• CHAPTER/TRACK Selection . . . . .	30
• Search . . . . .	30
• Still Picture and Frame-by-Frame Playback . . . . .	30
• Slow Motion . . . . .	31
• Random . . . . .	31
• Repeat . . . . .	31
• Repeat A-B . . . . .	31
• Time Search . . . . .	31
• Zoom . . . . .	32
• Marker Search . . . . .	32
• Reviewing the Contents of DVD Video	
Discs: Menus . . . . .	32
Title Menu . . . . .	32
Disc Menu . . . . .	32
Camera Angle . . . . .	32
Changing the Audio Soundtrack . . . . .	32
Audio Channel Selection . . . . .	33
3D Surround . . . . .	33
Subtitles . . . . .	33
Last Condition Memory . . . . .	33
<b>Audio CD and MP3/WMA Operation</b> . . . . .	<b>34-36</b>
Playing an Audio CD or MP3/WMA file . . . . .	34
Notes on MP3/WMA Recordings . . . . .	34
• Pause . . . . .	35
• Track Selection . . . . .	35
• Repeat Track/All/Off . . . . .	35
• Random . . . . .	35
• Search . . . . .	35
• Repeat A-B . . . . .	35
Programmed Playback . . . . .	36
<b>JPEG File Operation</b> . . . . .	<b>37</b>
Viewing JPEG Disc . . . . .	37
• Slide Show . . . . .	37
• Still Picture . . . . .	37
• Moving to another File . . . . .	37
• To rotate picture . . . . .	37

## RECORDING

<b>Basic Recording</b> . . . . .	<b>38</b>
Basic Recording from TV channels . . . . .	38
Instant Timer Recording . . . . .	38
<b>Timer Recording</b> . . . . .	<b>39-40</b>
Reviewing Timer Recording Details . . . . .	40
Canceling a Timer Recording . . . . .	40
Stopping a Timer Recording in Progress . . . . .	40
Timer Recording Troubleshooting . . . . .	40

<b>Recording from External Input source</b> . . . . .	<b>41-42</b>
Recording from External Components . . . . .	41
Recording from a Digital Camcorder . . . . .	41
What is DV? . . . . .	42
• DV-Related Messages . . . . .	42
• Troubleshooting . . . . .	42

## EDITING

<b>Title List and Chapter List Menu</b> . . . . .	<b>43-47</b>
Using the Title List-Original menu  . . . . .	43
Using the Chapter List-Original menu  . . . . .	43
Using the Title List-Playlist menu  . . . . .	44
Using the Chapter List-Playlist menu  . . . . .	44
Using the Title List menu  . . . . .	45
• Deleting a Title . . . . .	45
Using the Title List menu  . . . . .	46
Using the Chapter List menu  . . . . .	46
Using the Title List menu  . . . . .	47
Using the Chapter List menu  . . . . .	47
<b>Title and Chapter Editing</b> . . . . .	<b>48-53</b>
Titles, Chapters and Parts . . . . .	48
Adding Chapter Markers . . . . .	48
Changing Title Thumbnails . . . . .	48
Making a New Playlist . . . . .	49
Adding Additional Title/Chapters to the Playlist . . . . .	49
Deleting a Title/Chapter . . . . .	50
Deleting a Part . . . . .	50
Naming a Title . . . . .	51
Combining Two Chapters Into One . . . . .	51
Moving a Playlist Chapter . . . . .	52
Protect a Title . . . . .	52
Hide a Chapter . . . . .	53
Divide One Title Into Two . . . . .	53
<b>Additional Information</b> . . . . .	<b>54</b>
Overwrite Recording . . . . .	54
Viewing Title List menu displayed on other DVD Recorders or Players . . . . .	54
Playing Your Recordings on Other DVD Players (Finalizing a Disc) . . . . .	54

## REFERENCE

<b>Language Code and Country Code List</b> . . . . .	<b>55</b>
<b>Troubleshooting</b> . . . . .	<b>56-57</b>
<b>Specifications</b> . . . . .	<b>58</b>

### About the symbols for instructions

 Indicates hazards likely to cause harm to the unit itself or other material damage.

**Note** Indicates special operating features of this unit.

**Tip** Indicates tips and hints for making the task easier.

## DVD Recorder Overview

### Recordable Discs



**DVD-RW (Digital Video Disc - ReWritable):**  
These Discs can be recorded on repeatedly. Recordings can be erased, then you can record again on the same Disc.



**DVD-R (Digital Video Disc - Recordable):**  
These Discs can be recorded only once. After you finalize a DVD-R, you cannot record on it or edit it.



**DVD+RW (Digital Video Disc + ReWritable):**  
These Discs can be recorded on repeatedly. Recordings can be erased, then you can record again on the same Disc.



**DVD+R (Digital Video Disc + Recordable):**  
These Discs can be recorded only once. After you finalize a DVD+R, you cannot record on it or edit it any more.

#### Notes :

- This Recorder cannot record CD-R or CD-RW discs.
- DVD-R/RW, DVD+R/RW and CD-R/RW discs recorded using a personal computer or a DVD or CD Recorder may not play if the disc is damaged or dirty, or if there is dirt or condensation on the Recorder's lens.
- If you record a disc using a personal computer, even if it is recorded in a compatible format, there are cases in which it may not play because of the settings of the application software used to create the disc. (Check with the software publisher for more detailed information.)
- The Recommendable DVD discs :

DVD-R	DVD+R	DVD-RW	DVD+RW
SONY	SONY	SONY	SONY
TDK	TDK	TDK	TDK
Imation	Imation	Imation	Imation
Verbatim	MAXELL	Verbatim	Verbatim
RiDATA	RiDATA	Memorex	RiDATA
Panasonic	Fujifilm	Fujifilm	Fujifilm
LG	Ricoh	LG	Ricoh
Mitsubishi	HP	Mitsubishi	HP
That's	That's	Samsung	Ritek
Pioneer	Philips	Pioneer	Radus

### Playable Discs



DVD  
(8 cm / 12 cm disc)



Video CD (VCD)  
(8 cm / 12 cm disc)



Audio CD  
(8 cm / 12 cm disc)

In addition, this unit can play DVD-R/DVD-RW discs; DVD+R/DVD+RW discs; CD-R/CD-RW/DVD-R/DVD-RW/DVD+R/DVD+RW discs that contain audio titles, MP3 files, WMA Files, or JPEG files and SVCD.

#### Notes :

- Depending on the conditions of the recording equipment or the CD-R/RW (or DVD±R/±RW) disc itself, some CD-R/RW (or DVD±R/±RW) discs cannot be played on the unit.
- Do not attach any seal or label to either side (the labeled side or the recorded side) of a disc.
- Do not use irregularly shaped CDs (e.g., heart-shaped or octagonal). Doing so may result in malfunctions.
- Depending on the recording software & the finalization, some recorded discs (CD-R/RW or DVD±R/RW) may not be playable.

#### Regional code of the DVD Recorder and DVDs

This DVD Recorder is designed and manufactured for playback of Region 2 encoded DVD software. The region code on the labels of some DVD discs indicates which type of DVD Recorder can play those discs. This unit can play only DVD discs labeled 2 or ALL. If you try to play any other discs, the message "Incorrect region code. Can't play back" will appear on the TV screen. Some DVD discs may not have a region code label even though their playback is prohibited by area limits.



#### Notes on DVDs and Video CDs

Some playback operations of DVDs and Video CDs may be intentionally fixed by software manufacturers. As this unit plays DVDs and Video CDs according to disc content designed by the software manufacturer, some playback features of the unit may not be available or other functions may be added.

Refer also to the instructions supplied with the DVDs and Video CDs. Some DVDs made for business purposes may not be played on the unit.

## DVD Recorder Overview (Continued)

### Disc-related terms

#### **Title (DVD only)**

The main film content, accompanying feature content, or music album.

Each title is assigned a title reference number enabling you to locate it easily.

#### **Chapter (DVD only)**

Sections of a picture or a musical piece that are smaller than titles. A title is composed of one or several chapters. Each chapter is assigned a chapter number to enable you to locate the chapter you want. Depending on the disc, chapters may not be labeled.

#### **Track (Video CD and Audio CD only)**

Sections of a picture or a musical piece on a Video CD or an Audio CD. Each track is assigned a track number, enabling you to locate the track you want.

#### **Scene**

On a Video CD with PBC (Playback control) functions, moving pictures and still pictures are divided into sections called "Scenes". Each scene available is displayed on the Scene menu and assigned a scene number, enabling you to locate the scene you want.

A scene may be composed of one or several tracks.

### Types of Video CDs

There are two types of Video CDs:

#### **Video CDs equipped with PBC (Version 2.0)**

PBC (Playback control) functions allow you to interact with the system via menus, search functions, or other typical computer-like operations. Moreover, high resolution still pictures can be played if they are included on the disc.

#### **Video CDs not equipped with PBC (Version 1.1)**

Operated in the same way as audio CDs, these discs allow playback of video pictures as well as sound, but they are not equipped with PBC.





### About Symbols











#### About the symbol display

" " may appear on the TV screen during operation. This icon means the function explained in this owner's manual is not available on that specific disc, or at that time.

#### About the disc symbols for instructions

A section whose title has one of the following symbols are applicable only to those discs represented by the symbol.

Many functions provided on this Recorder are dependent on the recording mode. One or more of the symbols (, , , ) appear by each function (explained in this manual) so that you can see at a glance whether it's applicable to the disc loaded.

	DVD-R/RW with Video recording mode
	DVD-RW with VR recording mode
	DVD+R disc
	DVD+RW disc
	DVD-Video disc
	Video CDs
	Audio CDs
	MP3 CDs
	WMA CDs
	JPEG CDs

The finalized DVD disc is a DVD-Video disc.

## DVD Recorder Overview (Continued)

### About recordable discs

#### How are recordable discs different?

The essential difference among DVD-R, DVD-RW, DVD+R and DVD+RW is that DVD-R and DVD+R are record-once medium, while DVD-RW and DVD+RW are re-recordable/erasable medium. You can re-record/erase a DVD-RW and DVD+RW disc approximately 1,000 times.

#### Can I play my recordable discs in a regular DVD player?

Generally, DVD-R, DVD+R and DVD-RW discs recorded in Video mode are playable in a regular DVD player, but they must be 'finalized' first. This process fixes the contents of the disc to make them readable to other DVD players as DVD-Video discs.

DVD-RW discs recorded in VR (Video Recording) mode are playable in some players.

Unfinalized DVD+RW discs are playable in a regular DVD player.



This indicates a product feature that is capable of playing DVD-RW discs recorded with Video Recording format.

#### What are 'recording modes'?

There are various recording modes available using this Recorder. When recording to a DVD-R, DVD+R or DVD+RW disc, recordings are always in Video mode. DVD-RW discs can be formatted for VR mode recording or Video mode recording.

#### VR mode recording **VR**

- 4 different picture quality/recording time settings available (HQ, SQ, LQ, EQ)
- Not playable on regular DVD players
- Recordings can be extensively edited

#### Video mode recording **Video**

- 4 different picture quality/recording time settings available (HQ, SQ, LQ, EQ)
- Playable on regular DVD players (after finalization)
- Limited editing features

#### DVD+RW mode recording **+RW**

- 4 different picture quality/recording time settings available (HQ, SQ, LQ, EQ)
- Playable on regular DVD players
- The edited contents is playable on regular DVD players only after finalizing
- Recordings can be edited the title/chapter

#### DVD+R mode recording **+R**

- 4 different picture quality/recording time settings available (HQ, SQ, LQ, EQ)
- Playable on regular DVD players (after finalization)
- Any edited contents are not be compatible on regular DVD players. (Hide, chapter combine, added chapter mark, etc.)
- Limited title/chapter editing features.

#### Note :

DVD-Video Format (Video mode) is a new format for recording on DVD-R/RW and DVD+R/RW discs that was approved by the DVD Forum in 2000. You may therefore experience problems playing recordable DVD discs in some players. Symptoms include video artifacts, audio and/or video dropouts and playback suddenly stopping.

Our company cannot take responsibility for problems playing discs recorded on this Recorder in other players.

#### Is editing a DVD like editing a video tape?

No. When you edit a video tape you need one video deck to play the original tape and another to record the edits. With DVD, you edit by making a 'Playlist' of what to play and when to play it. On playback, the Recorder plays the disc according to the Playlist.

#### About word 'Original' and 'Playlist'

Throughout this manual, you will often see the words Original and Playlist to refer to the actual content and the edited version.

- **Original:** content refers to what's actually recorded on the disc.
- **Playlist:** content refers to the edited version of the disc — how the Original content is to be played.

Disc type	Disc format	Recording mode	Functions
DVD-Video	Video format	n/a	Playback only
DVD-RW	Video Recording format (default)	VR mode	Playback, Recording, Original/Playlist Editing
	Video format	Video mode	Playback, limited Recording, limited Editing
DVD-R	Video format	Video mode	Playback, limited Recording, limited Editing
DVD+RW	+RW Video format	DVD+RW	Playback, limited Recording, Title/Chapter Editing
DVD+R	+R Video format	DVD+R	Playback, limited Recording, limited Title/Chapter Editing

## DVD Recorder Overview (Continued)

### About DVD recording

#### **Notes :**

- This recorder cannot make recordings on CD-R or CD-RW discs.
- Our company takes no responsibility for recording failure due to power outages, defective discs, or damage to the Recorder.
- Fingerprints and small scratches on a disc can affect playback and/or recording performance. Please take proper care of your discs.

### Disc types and recording formats, modes, and settings

This recorder can play five different kinds of DVD discs: pre-recorded DVD-Video discs, DVD-RW, DVD-R, DVD+RW and DVD+R discs. The disc format for DVD-R discs is always "Video format"—the same as pre-recorded DVD-Video discs. This means that once finalized, you can play a DVD-R in a regular DVD player.

By default, the DVD-RW disc format is Video Recording (VR) format, though you can change this to Video format, if required. (Reinitializing the disc will erase the contents of the disc.)

The recording mode is closely related to the disc format. If the disc format is Video Recording format, then the recording mode is VR mode; if the disc format is Video mode, then the recording mode is Video mode (except for DVD-Video, which is not recordable, and so does not have a recording mode).

Within the recording modes (which are fixed for them whole disc) are the record settings. These can be changed as required for each recording and determine the picture quality and how much space the recording will take up on the disc.

### Recording TV audio channels

This recorder can record either NICAM or regular audio. If the NICAM setting (page 20) is set to Auto, then if the broadcast is NICAM, you can record the NICAM audio. If the broadcast is non-NICAM, the regular audio is always recorded.

### Notes for recording

- The recording times shown are not exact because the recorder uses variable bit-rate video compression. This means that the exact recording time will depend on the material being recorded.
- When recording a TV broadcast, if the reception is poor or the picture contains interference, the recording times may be shorter.
- If you record still pictures or audio only, the recording time may be longer.
- The displayed times for recording and time remaining may not always add up to exactly the length of the disc.
- The recording time available may decrease if you heavily edit a disc.
- If using a DVD-RW disc, make sure you change the recording format (Video mode or VR mode) before you record anything on the disc. See page 27 (Disc Format) for how to do this.
- When using a DVD-R disc, you can keep recording until the disc is full, or until you finalize the disc. Before you start a recording session, check the amount of recording time left on the disc.
- When using a DVD-RW disc in Video mode, recording time available will only increase if you erase the last title recorded on the disc.
- The Erase Title option in the Title List-Original menu only hides the title, it does not actually erase the title from the disc and increase the recording time available (except for the last recorded title on a DVD-RW disc in Video mode).
- Overwrite recording is available using DVD+RW discs.

## DVD Recorder Overview (Continued)

### Restrictions on video recording

- You cannot record copy-protected video using this recorder. Copy-protected video includes DVD-Video discs and some satellite broadcasts. If copy-protected material is encountered during a recording, recording will pause or stop automatically and an error message will be displayed on-screen.
- Video that is 'copy-once only' can only be recorded using a DVD-RW disc in VR mode with CPRM (see below).
- NTSC format signals from the analog or the DV inputs is not recorded correctly with this recorder.
- Video signals in SECAM format (from the built-in TV tuner or from the analog inputs) are recorded in PAL format.

### What is 'CPRM'?

CPRM is a copy protection system (with scramble system) only allowing the recording of 'copy once' broadcast programs. CPRM stands for Content Protection for Recordable Media.

This Recorder is CPRM compatible, which means that you can record copy-once broadcast programs, but you cannot then make a copy of those recordings. CPRM recordings can only be made on DVD-RW discs formatted in VR mode, and CPRM recordings can only be played on players that are specifically compatible with CPRM.

### Copyright

- Recording equipment should be used only for lawful copying and you are advised to check carefully what is lawful copying in the area in which you are making a copy. Copying of copyright material such as films or music is unlawful unless permitted by a legal exception or consented to by the rights owner.
- This product incorporates copyright protection technology that is protected by method claims of certain U.S. patents and other intellectual property rights owned by Macrovision Corporation and other rights owners. Use of this copyright protection technology must be authorized by Macrovision Corporation, and is intended for home and other limited viewing uses only, unless otherwise authorized by Macrovision corporation. Reverse engineering or disassembly is prohibited.
- CONSUMERS SHOULD NOTE THAT NOT ALL HIGH DEFINITION TELEVISION SETS ARE FULLY COMPATIBLE WITH THIS PRODUCT AND MAY CAUSE ARTIFACTS TO BE DISPLAYED IN THE PICTURE. IN CASE OF 625 PROGRESSIVE SCAN PICTURE PROBLEMS, IT IS RECOMMENDED THAT THE USER SWITCH THE CONNECTION TO THE 'STANDARD DEFINITION' OUTPUT. IF THERE ARE QUESTIONS REGARDING OUR TV SET COMPATIBILITY WITH THIS MODEL 625p DVD RECORDER, PLEASE CONTACT OUR CUSTOMER SERVICE CENTER.

### Resetting the DVD Recorder

If you observe any of the following symptoms...

- The unit is plugged in, but the power will not turn on or off.
- The front panel display is not working.
- The DVD Recorder is not operating normally.

...you can reset the DVD Recorder as follows:

- Press and hold the POWER button for at least five seconds. This will force the unit to power off. Press the POWER button again to turn the unit back on.
- Unplug the power cord, wait at least five seconds, and then plug it in again.

## DVD Recorder Overview (Continued)

### Precautions

#### Handling the unit

##### **When shipping the unit**

The original shipping carton and packing materials come in handy. For maximum protection, re-pack the unit as it was originally packaged at the factory.

##### **When setting up the unit**

The picture and sound of a nearby TV, VCR, or radio may be distorted during playback. In this case, position the unit away from the TV, VCR, or radio, or turn off the unit after removing the disc.

##### **To keep the surface clean**

Do not use volatile liquids, such as insecticide spray, near the unit. Do not leave rubber or plastic products in contact with the unit for a long period of time. They will leave marks on the surface.

#### Cleaning the unit

##### **To clean the cabinet**

Use a soft, dry cloth. If the surfaces are extremely dirty, use a soft cloth lightly moistened with a mild detergent solution. Do not use strong solvents such as alcohol, benzene, or thinner, as these might damage the surface of the unit.

##### **To obtain a clear picture**

The DVD Recorder is a high-tech, precision device. If the optical pick-up lens and disc drive parts are dirty or worn, the picture quality will be poor. Regular inspection and maintenance are recommended after every 1,000 hours of use. (This depends on the operating environment.)  
For details, please contact your nearest dealer.

### Notes on Discs

#### Handling discs

Do not touch the playback side of the disc. Hold the disc by the edges so that fingerprints will not get on the surface. Do not stick paper or tape on the disc.



#### Storing discs

After playing, store the disc in its case.

Do not expose the disc to direct sunlight or sources of heat, or leave it in a parked car exposed to direct sunlight, as there may be a considerable temperature increase inside the car.

#### Cleaning discs

Fingerprints and dust on the disc can cause poor picture quality and sound distortion. Before playing, clean the disc with a clean cloth. Wipe the disc from the center outward.



Do not use strong solvents such as alcohol, benzene, thinner, commercially available cleaners, or anti-static spray intended for older vinyl records.

## Front Panel

### POWER

Switches the DVD Recorder ON or OFF.

### REC (●)

Starts recording. Press repeatedly to set the recording time.

### INPUT4 (VIDEO IN/AUDIO IN (Left/Right))

Connect the audio/video output of an external source (Audio system, TV/ Monitor, VCR, Camcorder, etc.).

### STOP (■)

Stops playback or recording.

### Display window

Shows the current status of the DVD Recorder.

Pause playback or recording temporarily, press again to exit pause mode.

### PAUSE (||)

### PLAY (▶)

To play back a disc.

### INPUT 4 (S-VIDEO IN)

Connect the S-Video output of an external source (TV/ Monitor, VCR, Camcorder, etc.).

### OPEN/CLOSE (▲)

Opens or closes the disc tray.

### DV INPUT

Connect the DV output of a digital camcorder.

### Power indicator

Lights up red when the recorder is in standby mode.

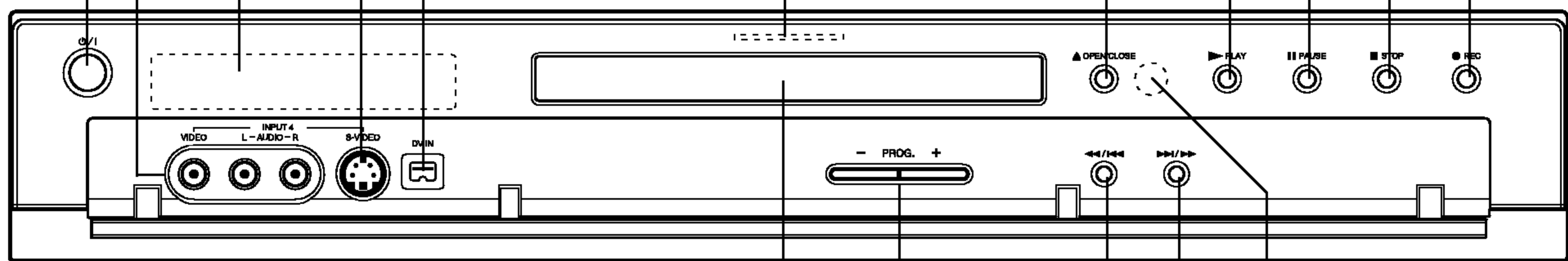

### Disc Tray

Insert a disc here.

### PROG. (+/-)

Scans up or down through memorized channels.



Go to beginning of current chapter/ track or to previous chapter/track. Press and hold for two seconds for a fast reverse search during playback.



Go to NEXT chapter/track. Press and hold for two seconds for a fast forward search during playback.

### Remote Sensor

Point the DVD Recorder remote control here.

## Function Display Window

### Disc type indicators

Indicates the type of disc loaded.

**REC** The Recorder is recording.

 Indicates that the recorder is timer recording or that a timer recording is programmed.

**HQ, SQ, LQ, EQ**  
Indicates recording mode.

**ST** Indicates a stereo broadcast is being received.

**BIL** Indicates when a BILINGUAL broadcast is being received.

**CHP** Indicates current chapter number.

**TRK** Indicates current track number.

**TV** Indicates when the recorder is in TV tuner mode.

**TITLE** Indicates current title number

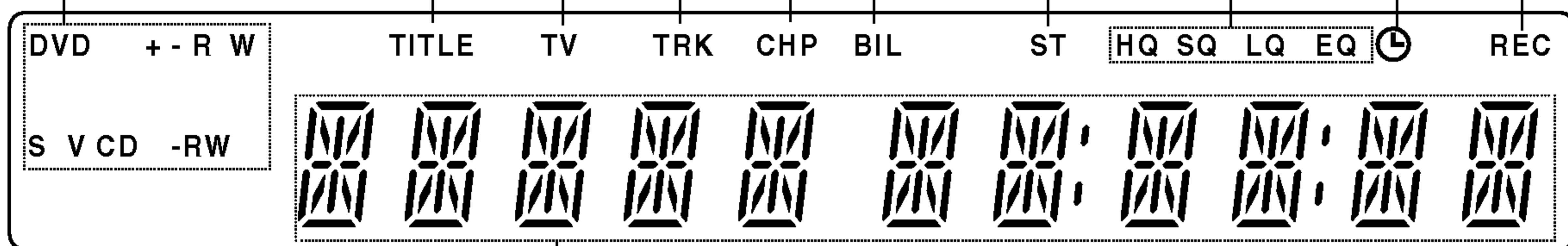

### Character indicators

Indicates clock, total playing time, elapsed time, title number, chapter/track number, channel, etc.

## Rear Panel Connections

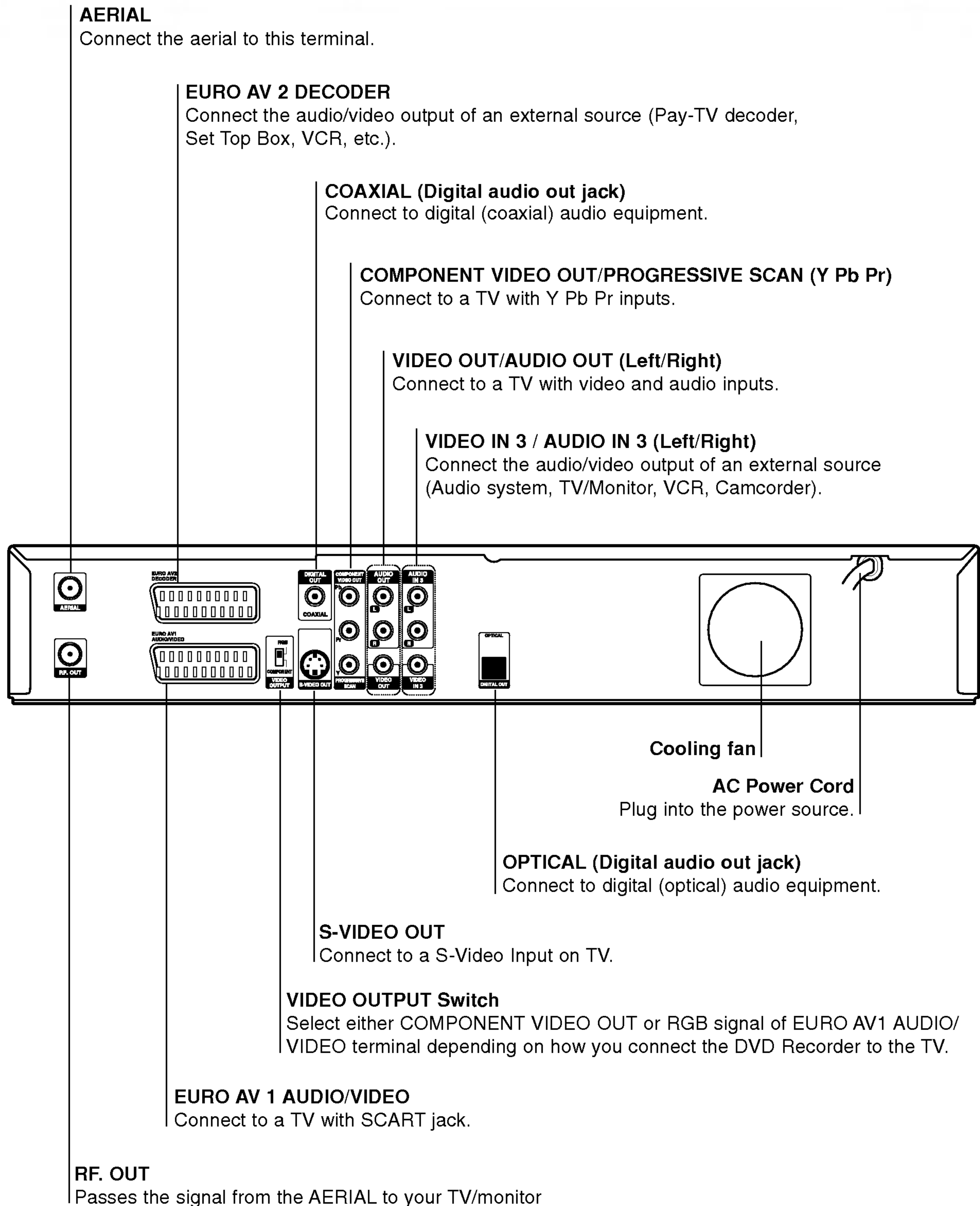

### Caution

Do not touch the inner pins of the jacks on the rear panel. Electrostatic discharge may cause permanent damage to the unit.

## Connections

### Connecting to the Aerial

Remove the aerial cable plug from your TV set and insert it into the aerial socket at the back of the recorder. Plug one end of the aerial cable into the TV socket on the DVD recorder and the other end into the aerial input socket on your TV set.

#### RF coaxial connection

Connect the RF. OUT jack on the DVD Recorder to the aerial input jack on the TV using the 75-ohm Coaxial Cable supplied (R). The RF. OUT jack passes the signal through from the AERIAL jack.

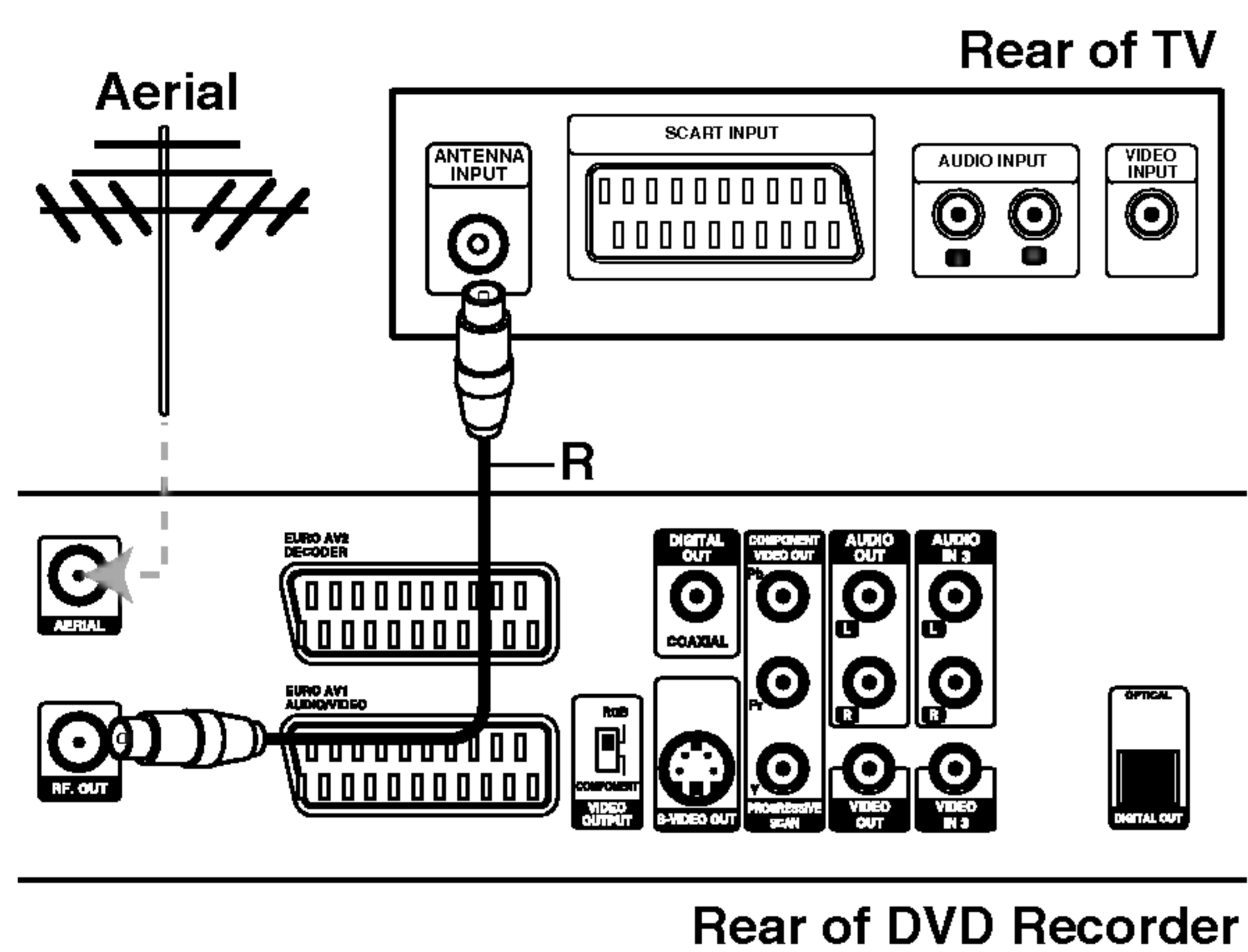

## Connections (Continued)

### Tips

- Depending on your TV and other equipment you wish to connect, there are various ways you could connect the recorder. Use only one of the connections described below.
- Please refer to the manuals of your TV, VCR, Stereo System or other devices as necessary to make the best connections.

### ⚠ Caution

- Make sure the DVD Recorder is connected directly to the TV. Tune the TV to the correct video input channel.
- Do not connect the DVD Recorder's AUDIO OUT jack to the phono in jack (record deck) of your audio system.
- Do not connect your DVD Recorder via your VCR. The DVD image could be distorted by the copy protection system.

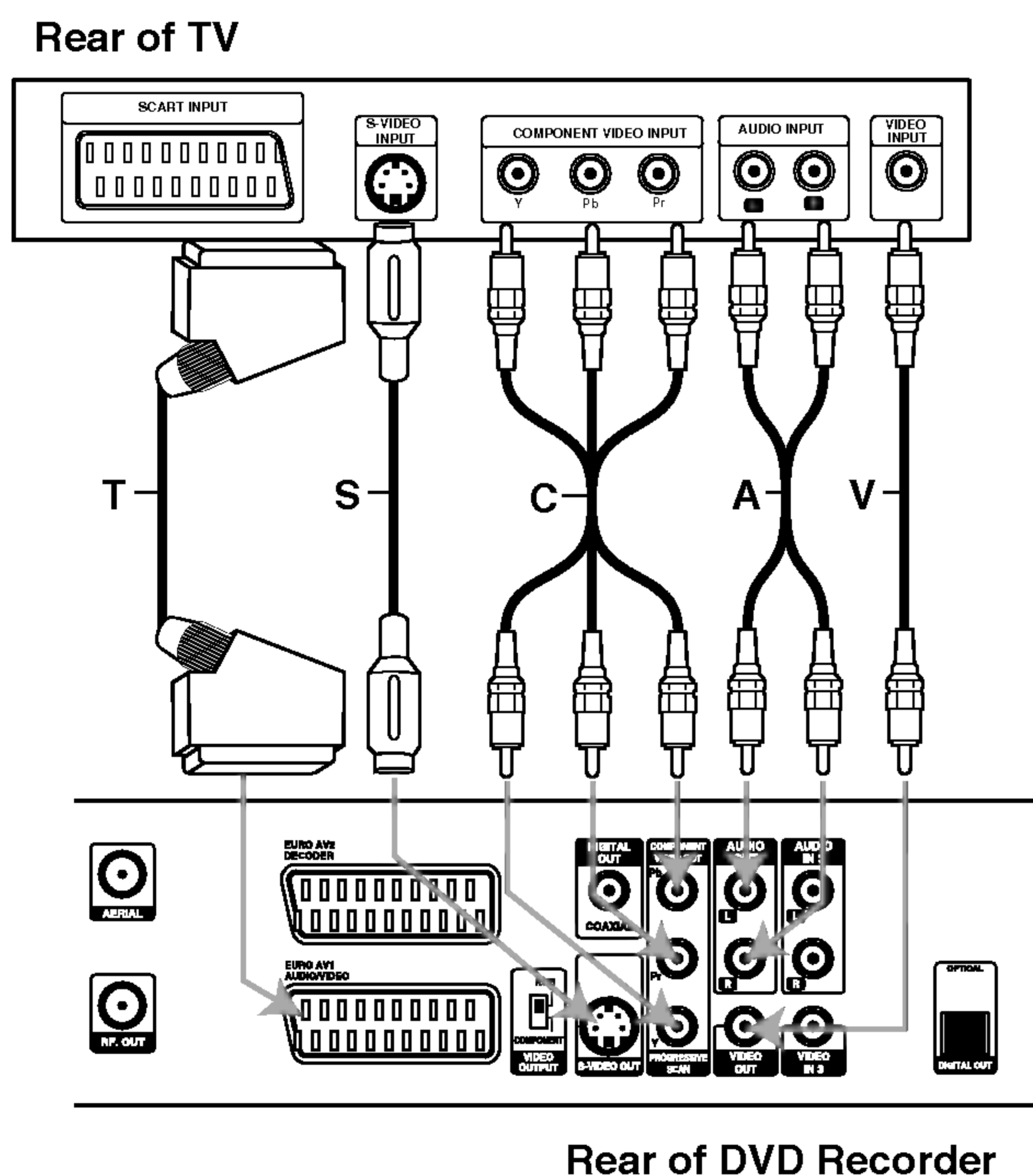

## Connections to Your TV

- Make one of the following connections, depending on the capabilities of your existing equipment.
- When using the COMPONENT VIDEO OUT jacks, set the VIDEO OUTPUT switch to COMPONENT. When using the SCART jack, set the VIDEO OUTPUT switch to RGB.

### SCART connection

Connect the EURO AV1 AUDIO/VIDEO scart jack on the DVD Recorder to the corresponding in jacks on the TV using the scart cable (**T**).

### Video connection

Connect the VIDEO OUT jack on the DVD Recorder to the video in jack on the TV using the video cable (**V**).

### S-Video connection

Connect the S-VIDEO OUT jack on the DVD Recorder to the S-Video in jack on the TV using the S-Video cable (**S**).

### Component Video connection

Connect the COMPONENT VIDEO OUT jacks on the DVD Recorder to the corresponding input jacks on the TV using an Y Pb Pr cable (**C**).

### Progressive Scan (ColorStream®Pro) connection

If your television is a high-definition or "digital ready" television, you may take advantage of the recorder's progressive scan output for the highest video resolution possible. If your TV does not accept the Progressive Scan format, the picture will appear scrambled if you try Progressive Scan on the recorder.

Connect the COMPONENT VIDEO OUT / PROGRESSIVE SCAN jacks on the recorder to the corresponding in jacks on the TV using the Y Pb Pr cable (**C**).

### Notes :

- Set the Progressive to "On" on the setup menu for progressive signal, see page 22.
- Set the progressive to "Off" by removing any disc from the unit and close the disc tray. See that "NO DISC" is displayed on the display window. Then press STOP and hold it for five seconds before releasing it.
- Progressive scan does not work with the analog video connections (yellow VIDEO OUT jack) or S-VIDEO connection.

### Audio (Left/Right) Connection

Connect the left and right AUDIO OUT jacks of the DVD Recorder to the audio left and right IN jacks on the TV using the audio cables (**A**). Do not connect the DVD Recorder's AUDIO OUT jack to the phono in jack (record deck) of your audio system.

## Connections (Continued)

### Connecting to a cable box or satellite receiver

If you have a cable or satellite receiver with a built-in decoder, connect it to this recorder and your TV as shown on this page. If you are using a separate decoder box for your cable/satellite TV, set up following the instructions on the right.

Using the setup on this page you can:

- Record any channel by selecting it on the cable box/satellite tuner.

- 1 Connect RF cables as shown. This enables you to watch and record TV channels.
- 2 Use the SCART cable to connect the EURO AV1 AUDIO/VIDEO connector to a SCART AV connector on your TV. This enables you to watch discs.
- 3 Use a SCART cable to connect the EURO AV2 DECODER connector to a SCART AV connector on your satellite/cable box. This enables you to record scrambled TV channels.

#### Tip

This recorder has a 'loop through' function. This feature allows you to record a TV program from the built-in TV tuner in this recorder, while watching a satellite or cable channel. Press TV/DVD to select the TV mode during recording. The TV indicator appears

#### ⚠ Caution:

Do not connect this recorder 'through' your VCR, satellite receiver or cable box. Always connect each component directly to your TV or AV receiver.

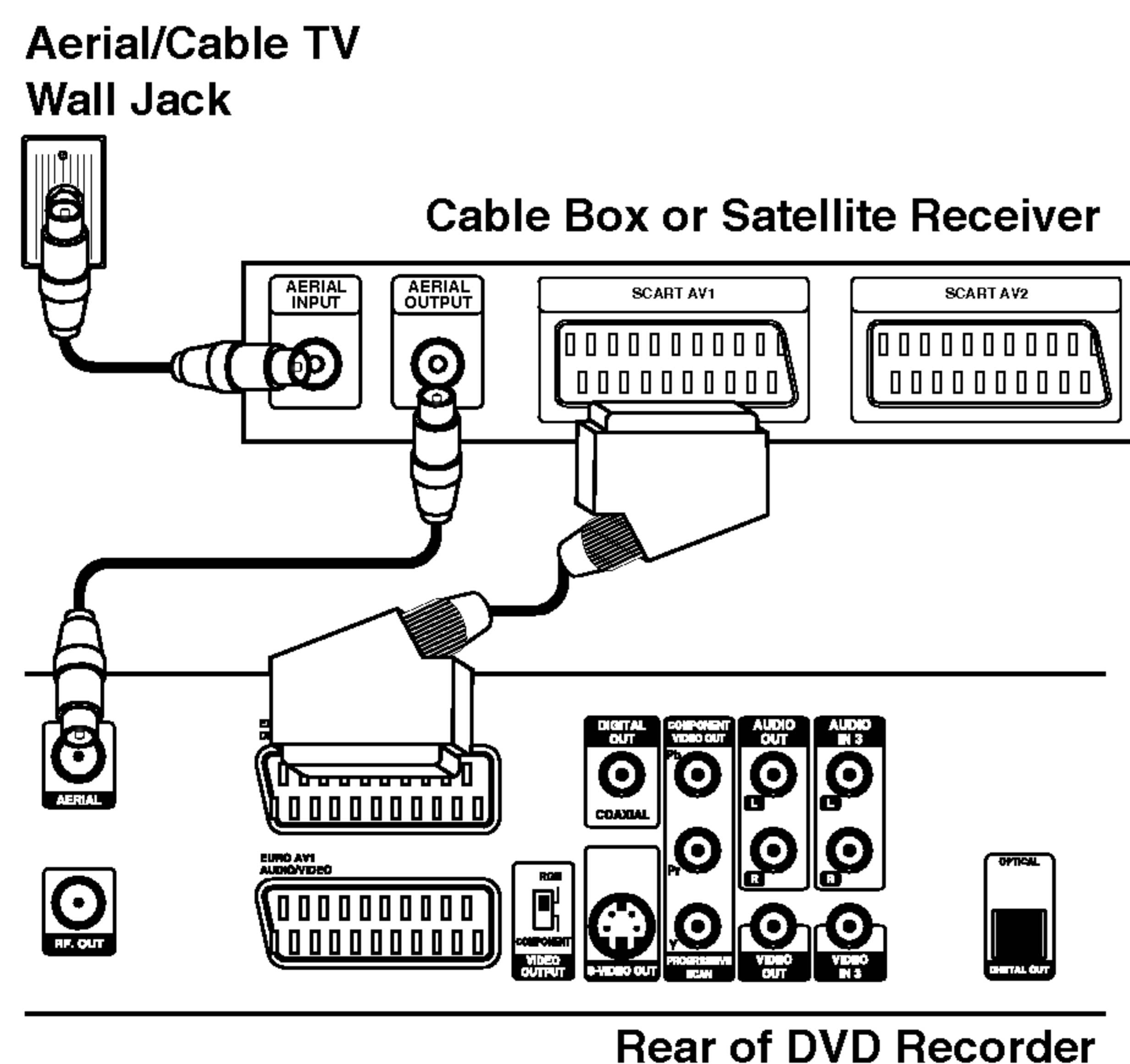

### Connecting an external decoder box

If you have an external, dedicated decoder box for your satellite or cable TV system, use the setup described on this page.

- 1 Connect the cable from the aerial/cable TV outlet to the aerial input on your cable/satellite tuner.
- 2 Use a SCART cable to connect your decoder to your cable/satellite tuner. See the manual for your decoder box for more detailed instructions.
- 3 Use a SCART cable to connect the EURO AV2 DECODER connector to a SCART AV connector on your satellite/cable box.
- 4 Use the SCART cable to connect the EURO AV1 AUDIO/VIDEO connector to a SCART AV connector on your TV.

#### ⚠ Caution:

- Do not connect your decoder box directly to this recorder.
- Information from the decoder (for example, relating to pay TV services), is only viewable when this recorder is off (in standby).
- For timer recording to work properly on this recorder, the satellite/cable box must also be switched on during recording.

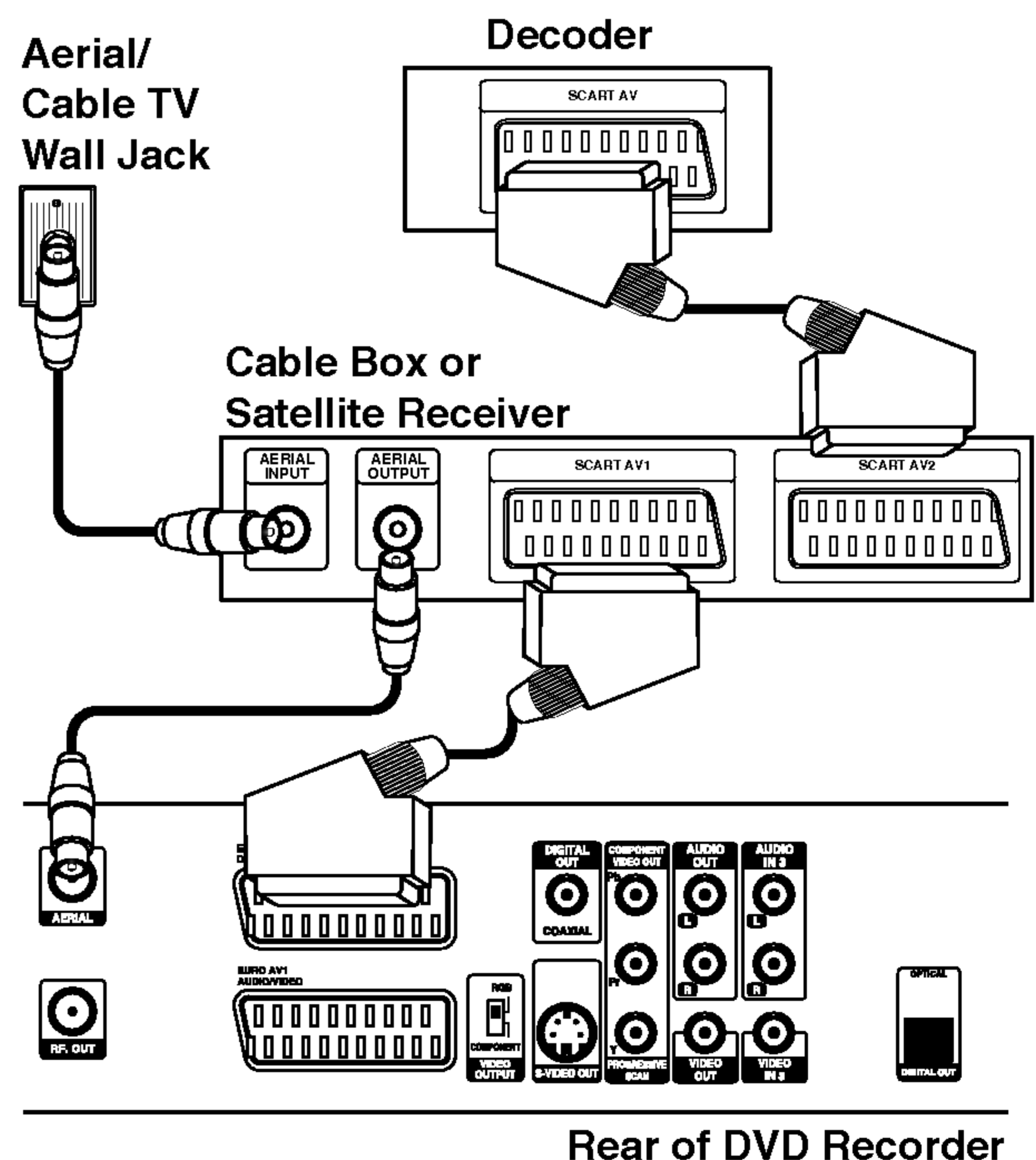

## Connections (Continued)

### Connecting to an Amplifier

#### Connecting to an amplifier equipped with two channel analog stereo or Dolby Pro Logic II/ Pro Logic

Connect the Left and Right AUDIO OUT jacks on the DVD Recorder to the audio left and right in jacks on your amplifier, receiver, or stereo system, using the audio cables (A).

#### Connecting to an amplifier equipped with two channel digital stereo (PCM) or to an Audio/ Video receiver equipped with a multi-channel decoder (Dolby Digital™, MPEG 2, or DTS)

**1** Connect one of the DVD Recorder's DIGITAL AUDIO OUT jacks (OPTICAL O or COAXIAL X) to the corresponding in jack on your amplifier. Use an optional digital (optical O or coaxial X) audio cable.

**2** You will need to activate the recorder's digital output. (See "Audio" on page 23).

#### Digital Multi-channel sound

A digital multi-channel connection provides the best sound quality. For this you need a multi-channel Audio/Video receiver that supports one or more of the audio formats supported by your DVD Recorder (MPEG 2, Dolby Digital and DTS). Check the receiver manual and the logos on the front of the receiver.



#### Caution:

Due to the DTS Licensing agreement, the digital output will be in DTS digital out when DTS audio stream is selected.

#### Notes :

- If the audio format of the digital output does not match the capabilities of your receiver, the receiver will produce a strong, distorted sound or no sound at all.
- Six Channel Digital Surround Sound via digital connection can only be obtained if your receiver is equipped with a Digital Multi-channel decoder.
- To see the audio format of the current DVD in the on-screen display, press AUDIO.
- This recorder does not perform internal (2 channel) decoding of a DTS sound track. To enjoy DTS multi channel surround, you must connect this recorder to a DTS compatible receiver via one of this recorder's digital audio outputs.

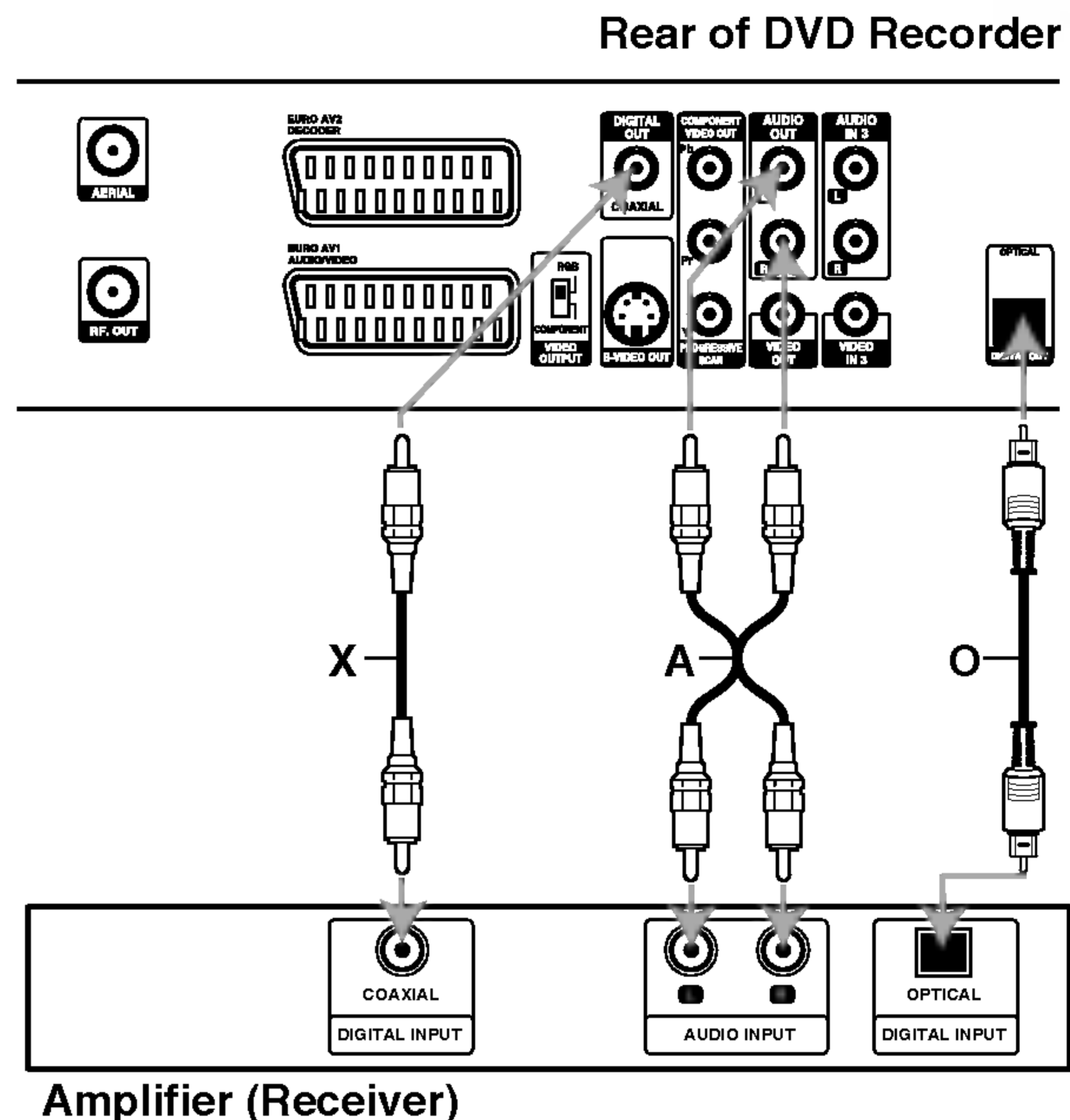

## Connections (Continued)

### Accessory Audio/Video (A/V) Connections to DVD Recorder

Connect the input jacks (AV3, AV4) on the DVD Recorder to the audio/video out jacks on your accessory component, using audio/video cables.

**Note :**

If you use the S-VIDEO IN jack on the front panel, the VIDEO IN jack on the front panel is not available.

Jack panel of Accessory Component  
(VCR, Camcorder, etc.)

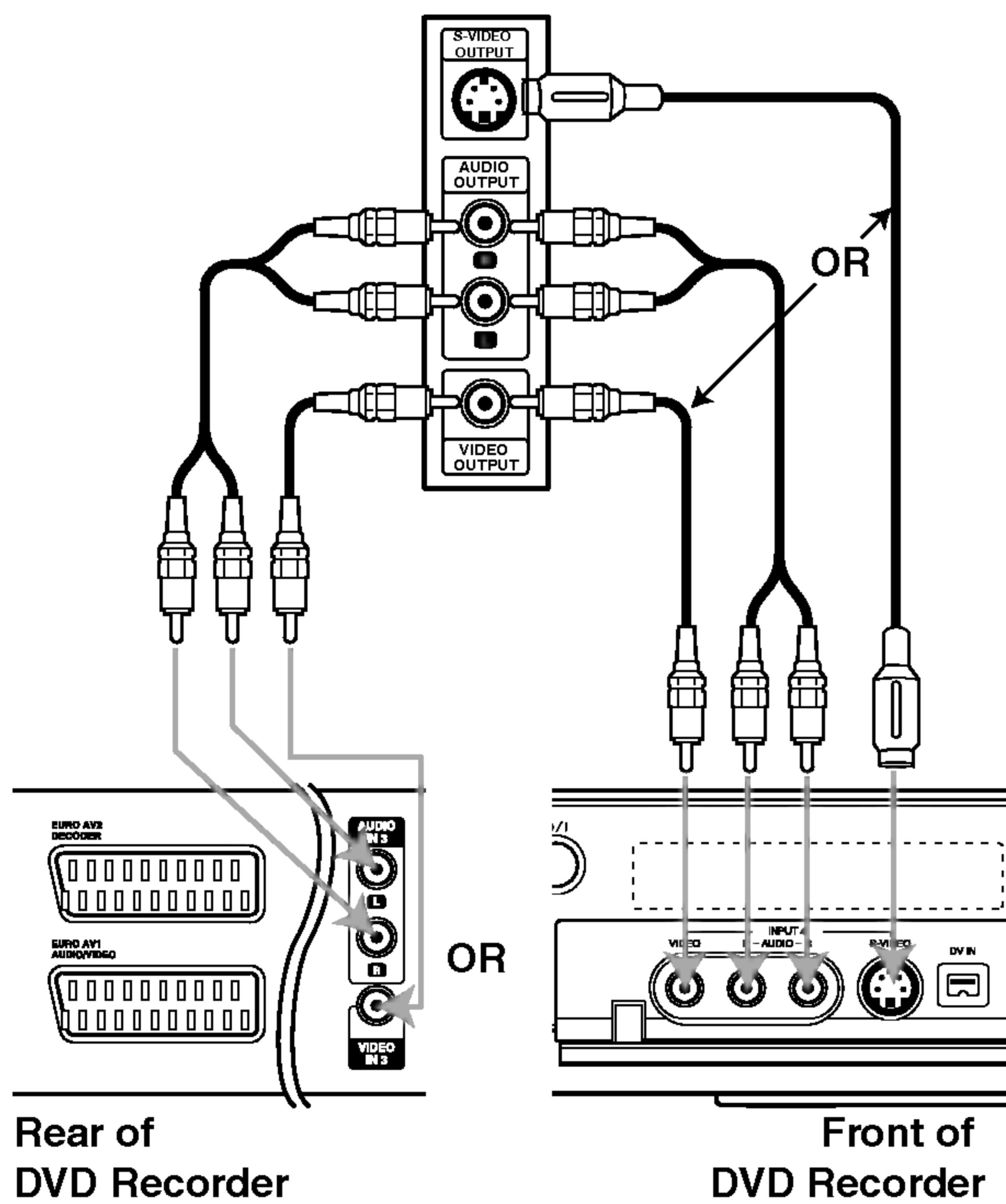

### Connecting a Digital Camcorder

Using the front panel DV IN jack, it is possible to connect a DV digital camcorder or DVD-R/RW recorder and digitally transfer DV tapes or DVD-R/RW discs to DVD-R/RW.

Use a DV cable (not supplied) to connect the DV in/out jack of your DV camcorder/video deck to the front panel DV IN jack of this recorder.

**Note :**

This jack is for connection to DV digital camcorder only. It is not compatible with digital satellite tuners or D-VHS video decks.

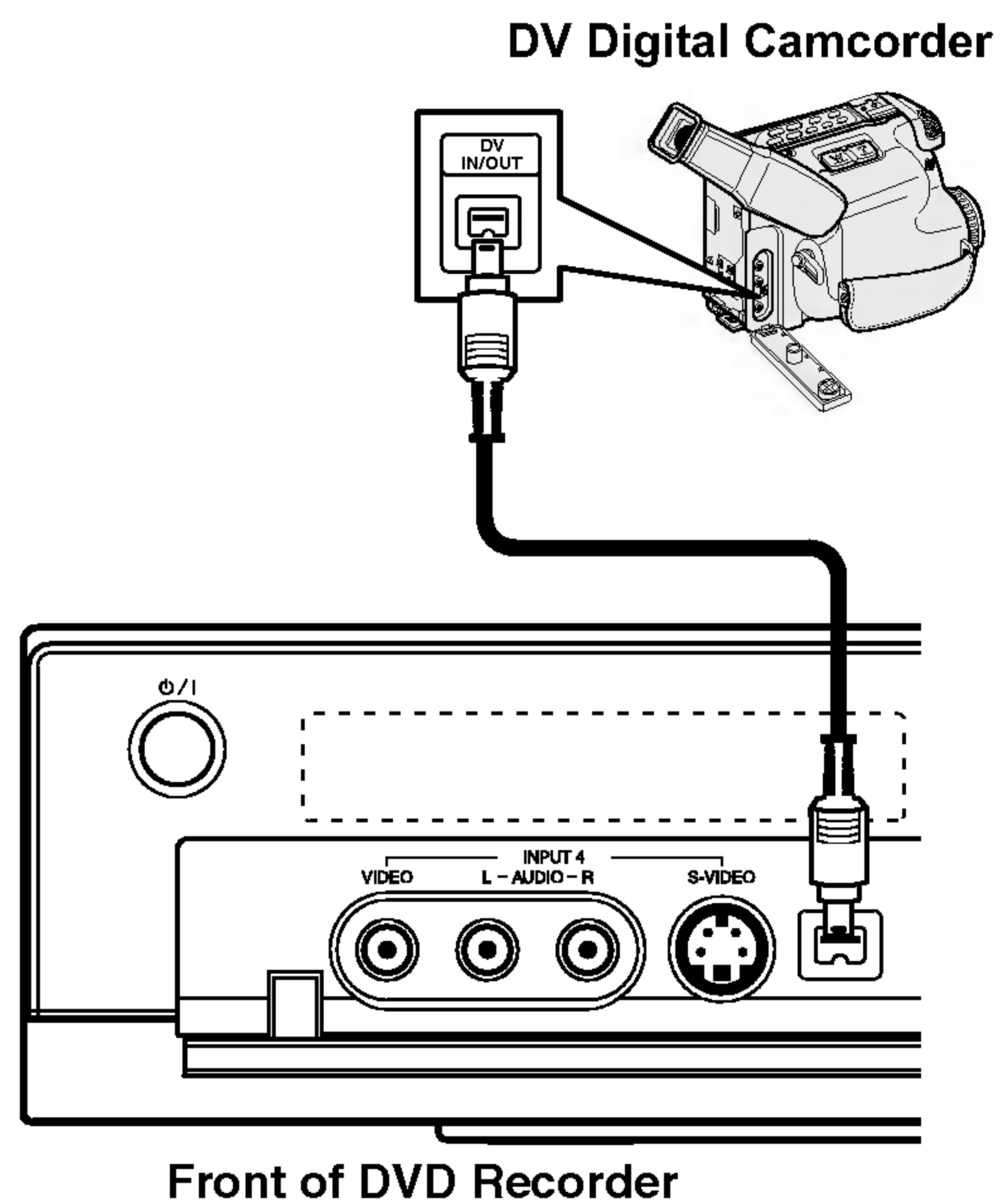

DVR HOOKUP

## Pre-operation Setup

### Initial Settings

In this menu system, there are several ways to customize the settings provided. Most menus consist of three levels to set up the options, but some require greater depth for the variety of settings. If you press SETUP, only the first and second level of the menu system will appear on the TV screen. The third level can be displayed by pressing ►. For navigating the menu levels, you will see “►” on the right side of the menu label to help you go to the next level.

#### To bring up and exit the Menu:

Press SETUP to bring up the menu. A second press of SETUP will take you back to initial screen.

#### To go to the next level:

Press ► on the remote control.

#### To go back to the previous level:

Press ◀ on the remote control.

### General Operation

- 1** Press SETUP.  
The Setup menu appears.
- 2** Use ▲ / ▼ to select the desired option.
- 3** While the desired item is selected, press ► to move to the second level.
- 4** Use ▲ / ▼ to select the second desired option.
- 5** Press ► to move to the third level.
- 6** Use ▲ / ▼ to select the desired setting then press ENTER/MEMORY to confirm your selection.  
Some items require additional steps.
- 7** Press SETUP to exit the Setup menu.

### General

#### Auto Programming

This DVD Recorder is equipped with a frequency synthesized tuner capable of receiving up to 88 TV channels.

#### Preparation:

- Connect the DVD Recorder to the desired type of aerial, as shown in Connecting to the Aerial on page 13.

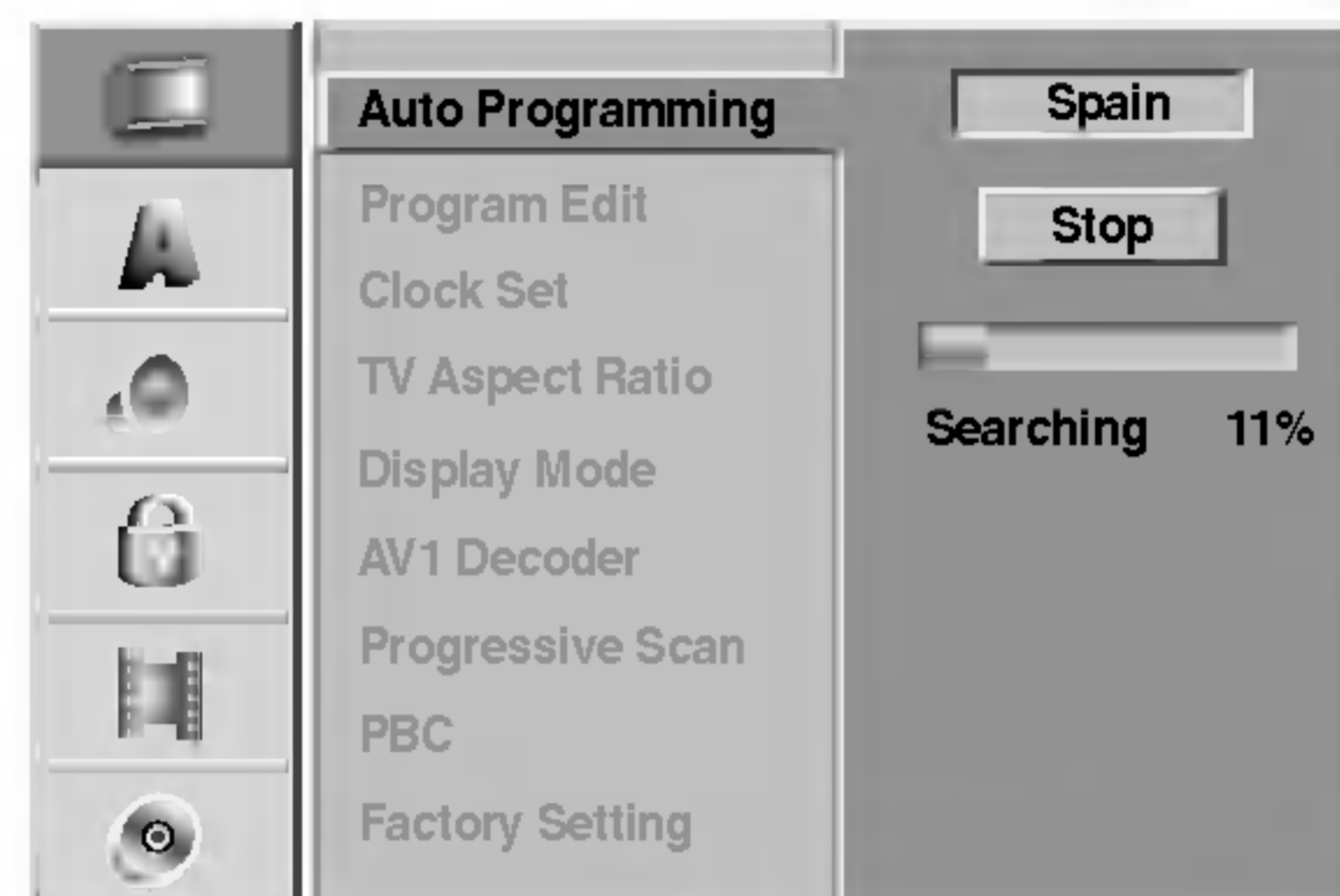

- 1** Press SETUP.  
The Setup menu appears.
- 2** Use ▲ / ▼ to select the General option.
- 3** While the General option is selected, press ► to move to the second level.
- 4** Use ▲ / ▼ to select the Auto Programming option.
- 5** Press ► to move to the third level.  
Country option is highlighted.
- 6** Use ▲ / ▼ to select a country then press ►.  
“Start” icon is highlighted.
- 7** Press ENTER/MEMORY to begin the channel search.  
The tuner will automatically cycle through all available channels in the area and place them in the tuner’s memory.

#### Note :

After you have connected your DVD recorder for the very first time. If you press SETUP for initial setting, you can only set the “Auto Programming” option. Then you can set the other options.

## Pre-operation Setup (Continued)

### Program Edit

You can edit a channel manually (add, delete, name, move, etc.).

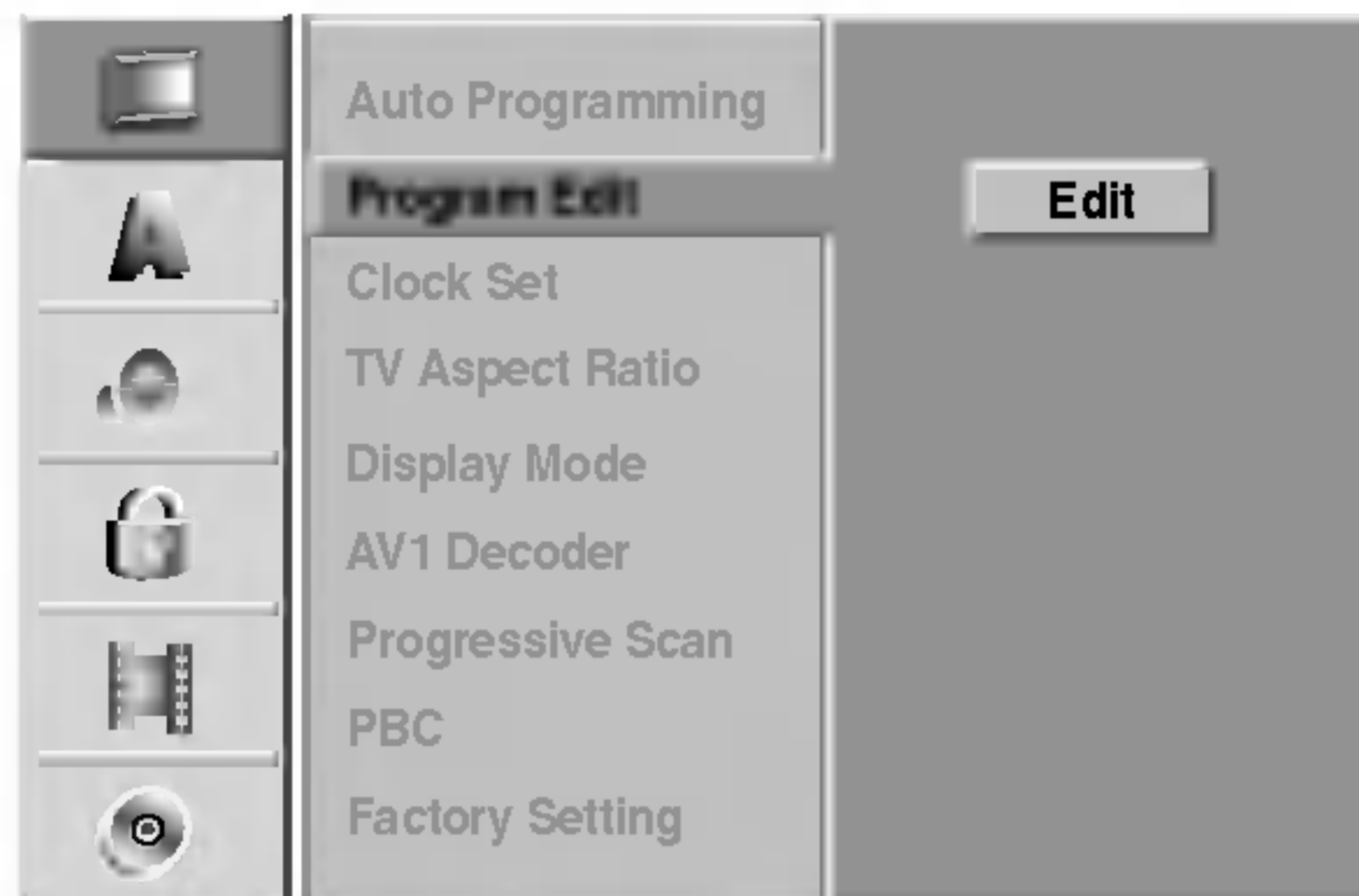

- 1** Press **SETUP**.  
The Setup menu appears.
- 2** Use **▲ / ▼** to select the **General** option.
- 3** While the **General** option is selected, press **▶** to move to the second level.
- 4** Use **▲ / ▼** to select the **Program Edit** option then press **▶** to move to the third level.  
"Edit" icon is highlighted.
- 5** Press **ENTER/MEMORY**.  
Program List menu appears.

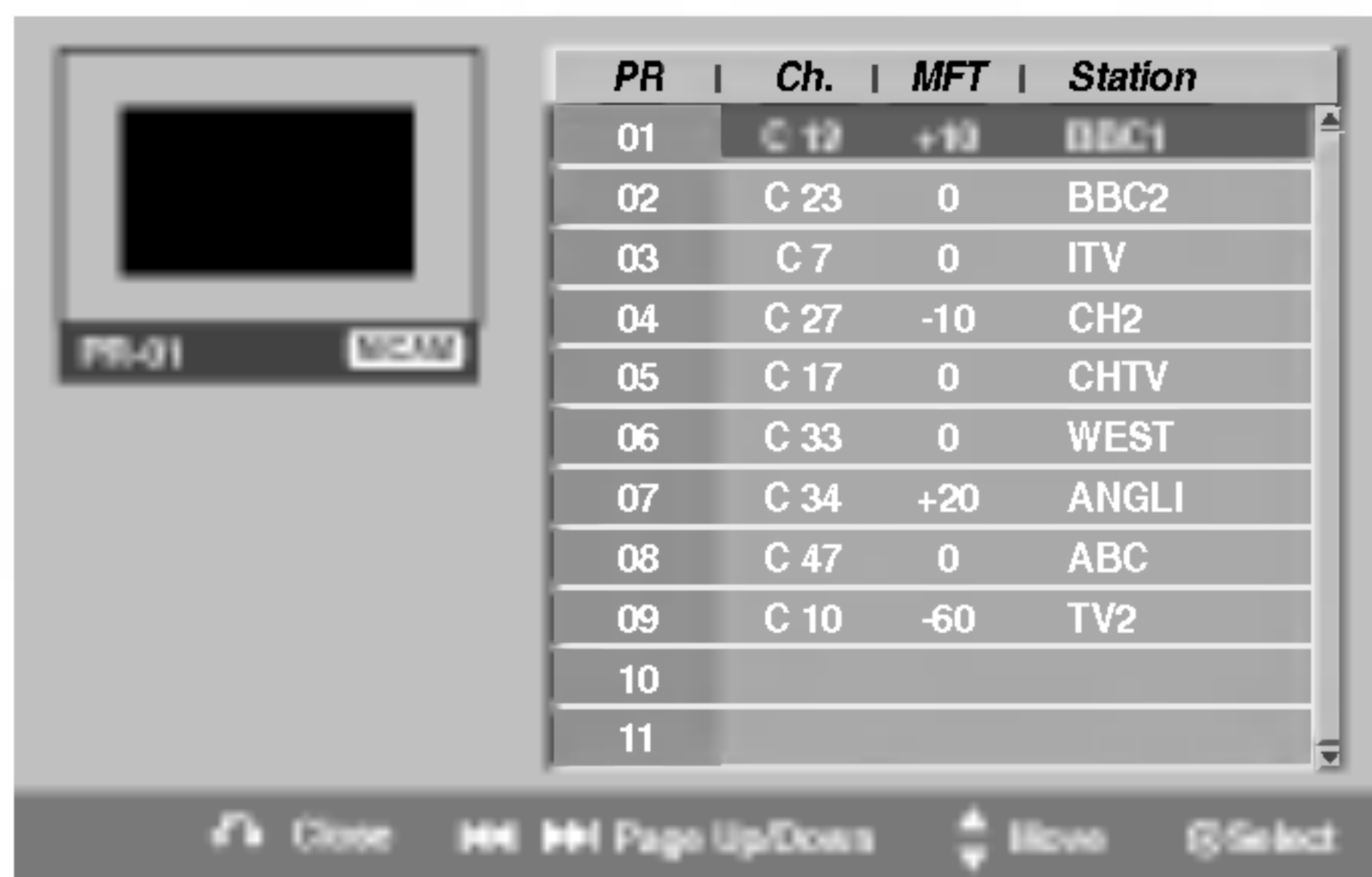

- 6** Use **▲ / ▼** to select a **PR** number then press **ENTER/MEMORY**.  
Program List options appears on the left side of the menu display.
- 7** Use **▲ / ▼** to select an option then press **ENTER/MEMORY** to confirm.

Program Edit
Station Rename
Move
Delete
Decoder On/Off
Nicam Auto/Off

**Program Edit:** Edits the selected program.

**Station Rename:** Edits the station name.

**Move:** Moves the program's location on the program list.

**Delete:** Deletes the program from program list.

**Decoder On/Off:** Set the decoder for the program to On or Off.

**Nicam Auto/Off:** Set the NICAM function for the program Auto or Off.

- 8** Press **RETURN** (↵) repeatedly to exit Program List menu.

### Program Edit

You can perform a search to select and store TV channels manually.

1. Use **▲ / ▼** to select a program on the Program List menu then press **ENTER/MEMORY**.  
Program List options appears on the left side of the Program List menu.
2. Use **▲ / ▼** to select 'Program Edit' option from the options then press **ENTER/MEMORY**.  
Program Edit menu appears.



3. See the descriptions on below to use Program Edit menu.
  - ◀ / ▶ (left/right): Moves the cursor to the previous or next column.
  - ▲ / ▼ (up/down): Changes the setting at the current cursor position.
  - PR:** Indicates program number (display only)
  - Seek:** Searches a station automatically. Use ◀ / ▶ to select Seek option then press ▲ / ▼. Searching stops when the DVD recorder tunes in a station.
  - Ch.:** Changes the channel number to edit. Use ◀ / ▶ to select Ch. option then press ▲ / ▼.
  - MFT:** Changes the frequency for fine tuning. Use ◀ / ▶ to select MFT option then press ▲ / ▼.
4. Choose **OK** then press **ENTER/MEMORY** to confirm the setting and returns to the Program List menu.

## Pre-operation Setup (Continued)

### Program Edit (Continued)

#### Station Rename

You can name stations independently. Names can be up to 5 characters long.

1. Use ▲ / ▼ to select a program on the Program List menu then press ENTER/MEMORY. Program List options appears on the left side of the Program List menu.
2. Use ▲ / ▼ to select 'Station Rename' option from Program List options then press ENTER/MEMORY. Keyboard menu appears.

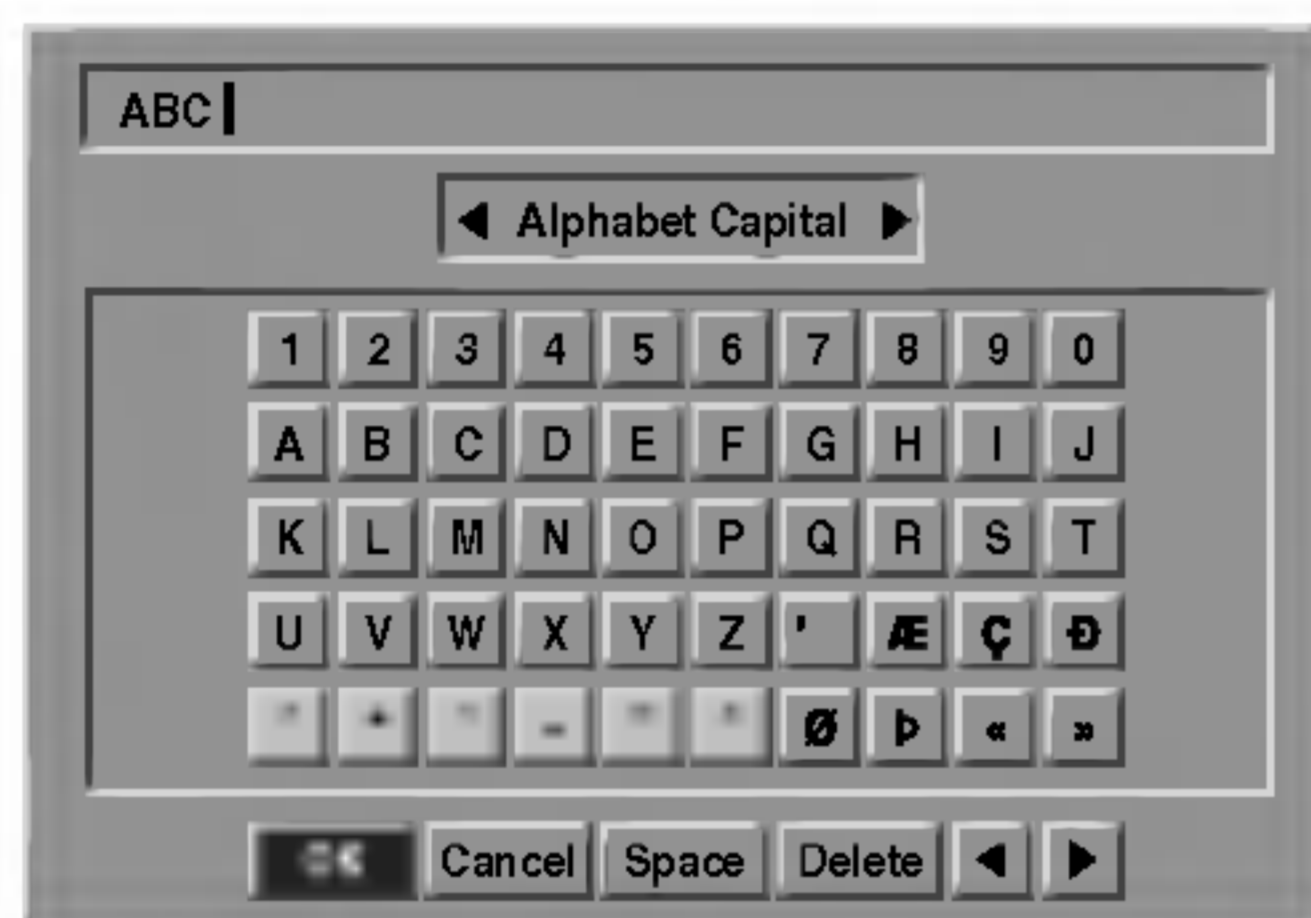

3. Enter/memory a name for the station. Use ▲ ▼ ◀ ▶ to select a character then press ENTER/MEMORY to confirm your selection.
  - **Alphabet Capital:** Switches the keyboard upper case characters.
  - **Alphabet Small:** Switches the keyboard to lower case characters.
  - **Symbol:** Switches the keyboard to symbol characters.
  - **OK:** Select to finish.
  - **Cancel:** Select to exit the menu.
  - **Space:** Inserts a space at the cursor position.
  - **Delete:** Deletes the previous character at the cursor position.
  - **◀ / ▶:** Moves cursor to left or right.

#### Tip

##### Remote control buttons for entering a name

**Numbers (0~9):** Enters the character of corresponding location on the selected column.

4. Choose 'OK' icon then press ENTER/MEMORY to fix the name and returns to the Program List menu.

#### Sorting TV channels manually

You can sort the program's position on the Program List menu.

1. Use ▲ / ▼ to select a program on the Program List menu then press ENTER/MEMORY. Program List options appears on the left side of the Program List menu.
2. Use ▲ / ▼ to select 'Move' option from Program List options then press ENTER/MEMORY.
3. Use ▲ / ▼ to select a desired position then press ENTER/MEMORY to store.

#### Deleting a program

You can delete a program on the Program List menu.

1. Use ▲ / ▼ to select a program on the Program List menu then press ENTER/MEMORY. Program List options appears on the left side of the Program List menu.
2. Use ▲ / ▼ to select 'Delete' option from Program List options then press ENTER/MEMORY. The Program is deleted.

#### Setting the Decoder On/Off

1. Use ▲ / ▼ to select the program you wish to link with the decoder function on the Program List menu then press ENTER/MEMORY. Program List options appears on the left side of the Program List menu.
2. Use ▲ / ▼ to select 'Decoder On/Off' option from Program List options then press ENTER/MEMORY. If you select On, 'Decoder' appears on the menu screen.

#### Setting the NICAM Auto/Off

This DVD recorder can receive Hi-Fi sound transmissions in NICAM Stereo. However, if sound distortion occurs, due to poor reception, you can switch Off

1. Use ▲ / ▼ to select a program on the Program List menu then press ENTER/MEMORY. Program List options appears on the left side of the Program List menu.
2. Use ▲ / ▼ to select 'Nicom Auto/Off' option from Program List options then press ENTER/MEMORY. If you select Auto, 'NICAM' appears on the menu screen.

## Pre-operation Setup (Continued)

### Auto Clock Set

When Channel auto search is completed the actual Time and Date are also set automatically. If the time in the DVD recorder display is not correct, the clock must be set manually.

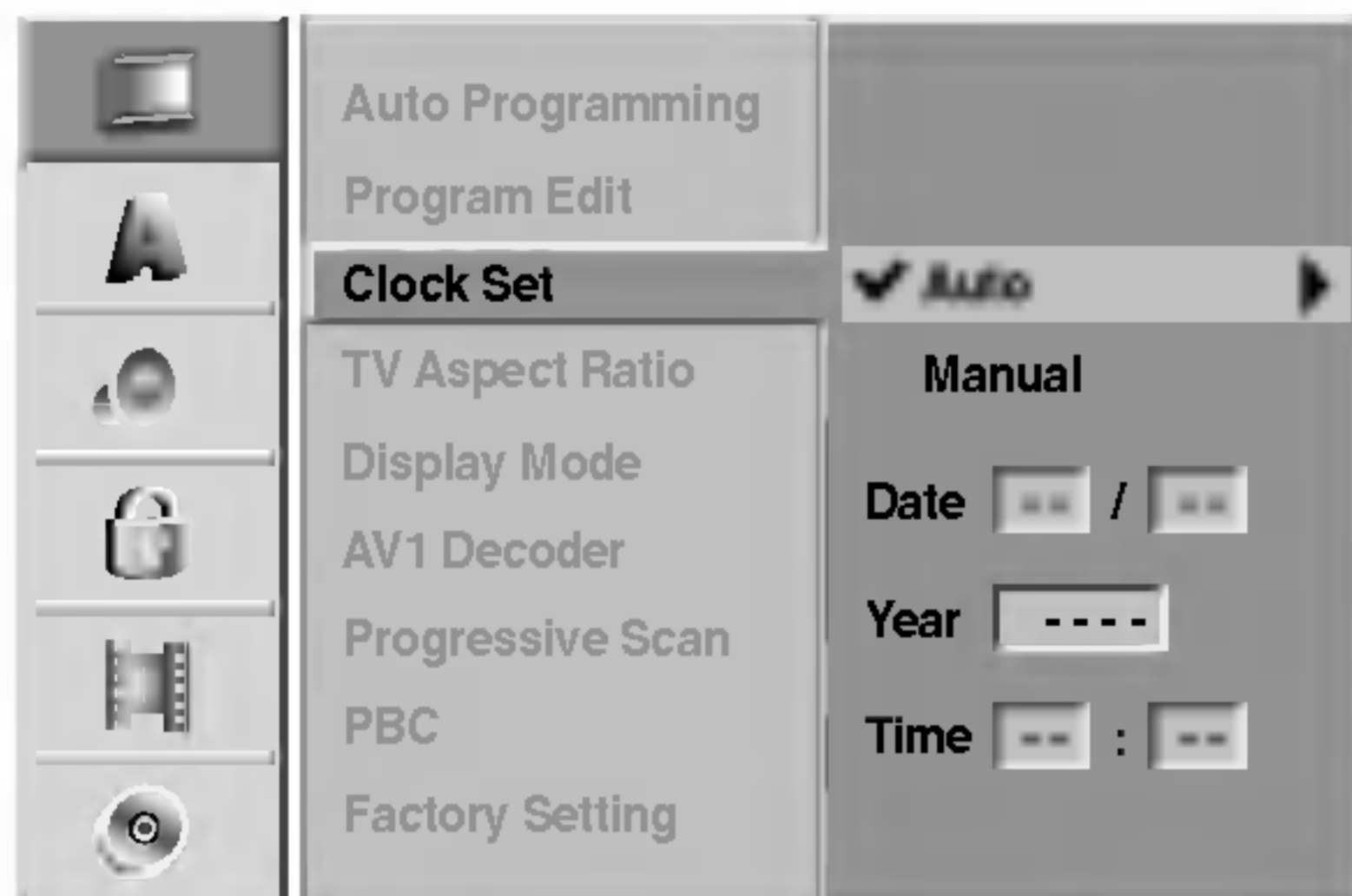

- 1** Press **SETUP**.  
The Setup menu appears.
- 2** Use **▲ / ▼** to select the **General** menu.
- 3** While the **General** option is selected, press **▶** to move to the second level.
- 4** Use **▲ / ▼** to select the **Clock Set** option.
- 5** Press **▶** to move to the third level.
- 6** Use **▲ / ▼** to select the **Auto** option then press **ENTER/MEMORY**.
- 7** Press **SETUP** to exit the Setup menu.

#### Note :

There are cases where the TV station does not send, or sends wrong date and/or time information and the DVD Recorder sets the incorrect time.

If this happens, we recommend that you set the clock manually.

### Manual Clock Set

- 1** Follow steps 1-5 as shown left. (**Auto Clock Set**).
- 2** Use **▲ / ▼** to select the **Manual** option then press **ENTER/MEMORY**.

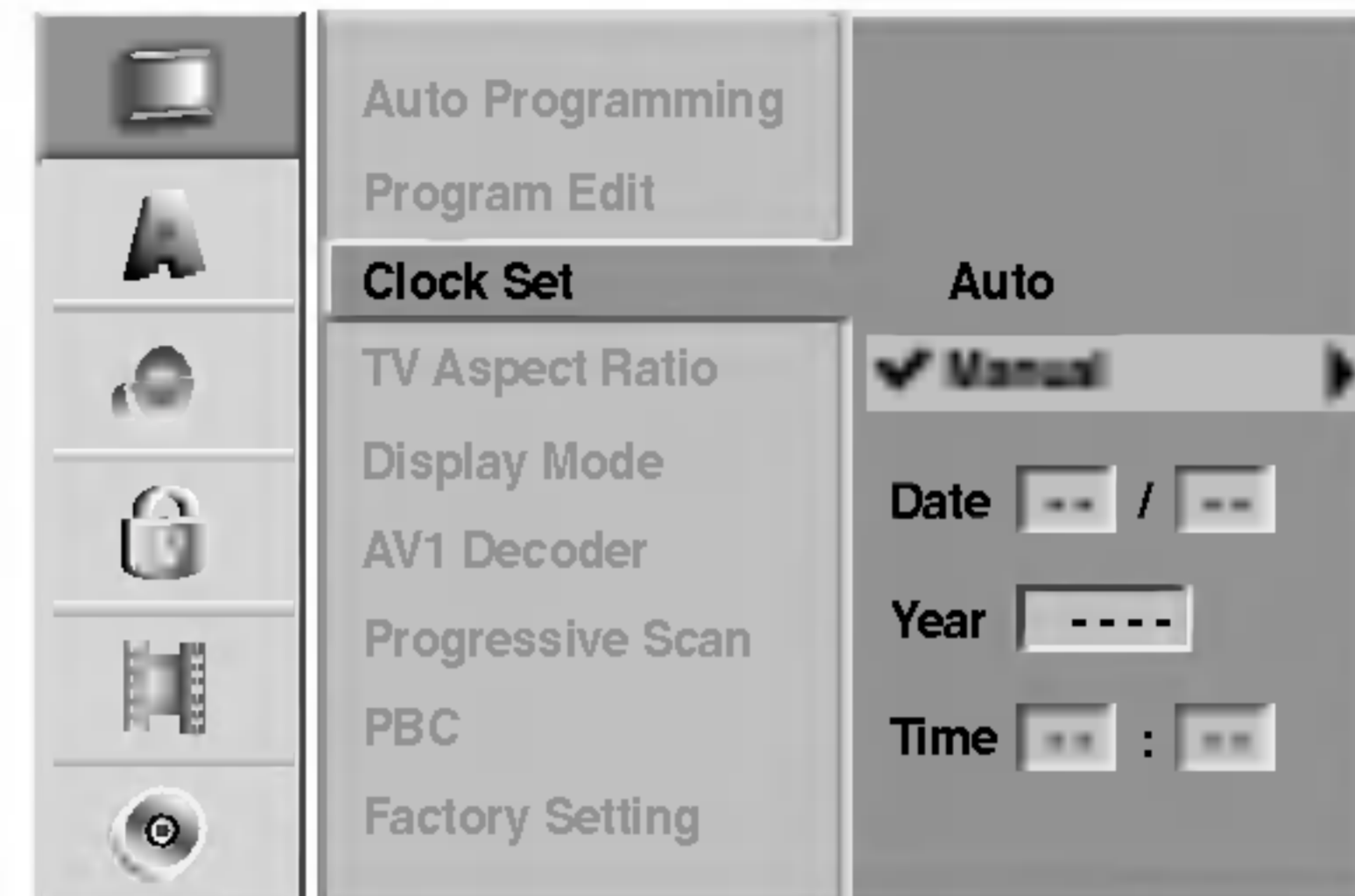

- 3** Enter/memory the necessary information for **date and time**.  
◀ / ▶ (left/right): Moves the cursor to the previous or next column.  
▲ / ▼ (up/down): Changes the setting at the current cursor position.
- 4** Press **ENTER/MEMORY** to confirm your setting, then press **SETUP** to exit the Setup menu.

## Pre-operation Setup (Continued)

### TV Aspect Ratio

You can choose:

- 4:3: Select when a standard 4:3 TV is connected.
- 16:9: Select when a 16:9 wide TV is connected.

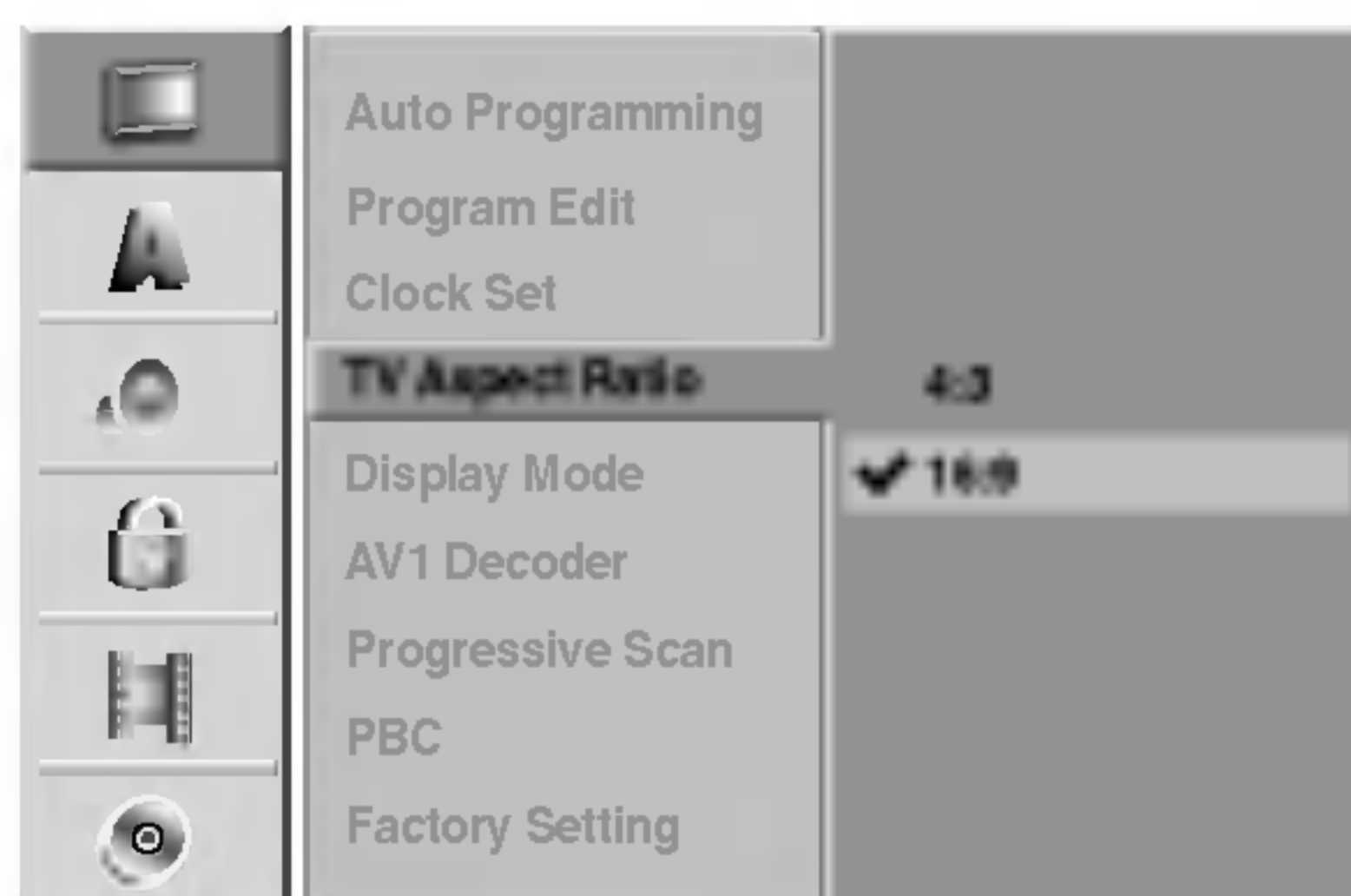

### Display Mode

Display Mode setting works only when the TV Aspect Ratio is set to "4:3".

You can choose:

- Letter Box: Displays a wide picture with bands on the upper and lower portions of the screen.
- Pan Scan: Automatically displays the wide picture on the entire screen and cuts off the portions that do not fit.

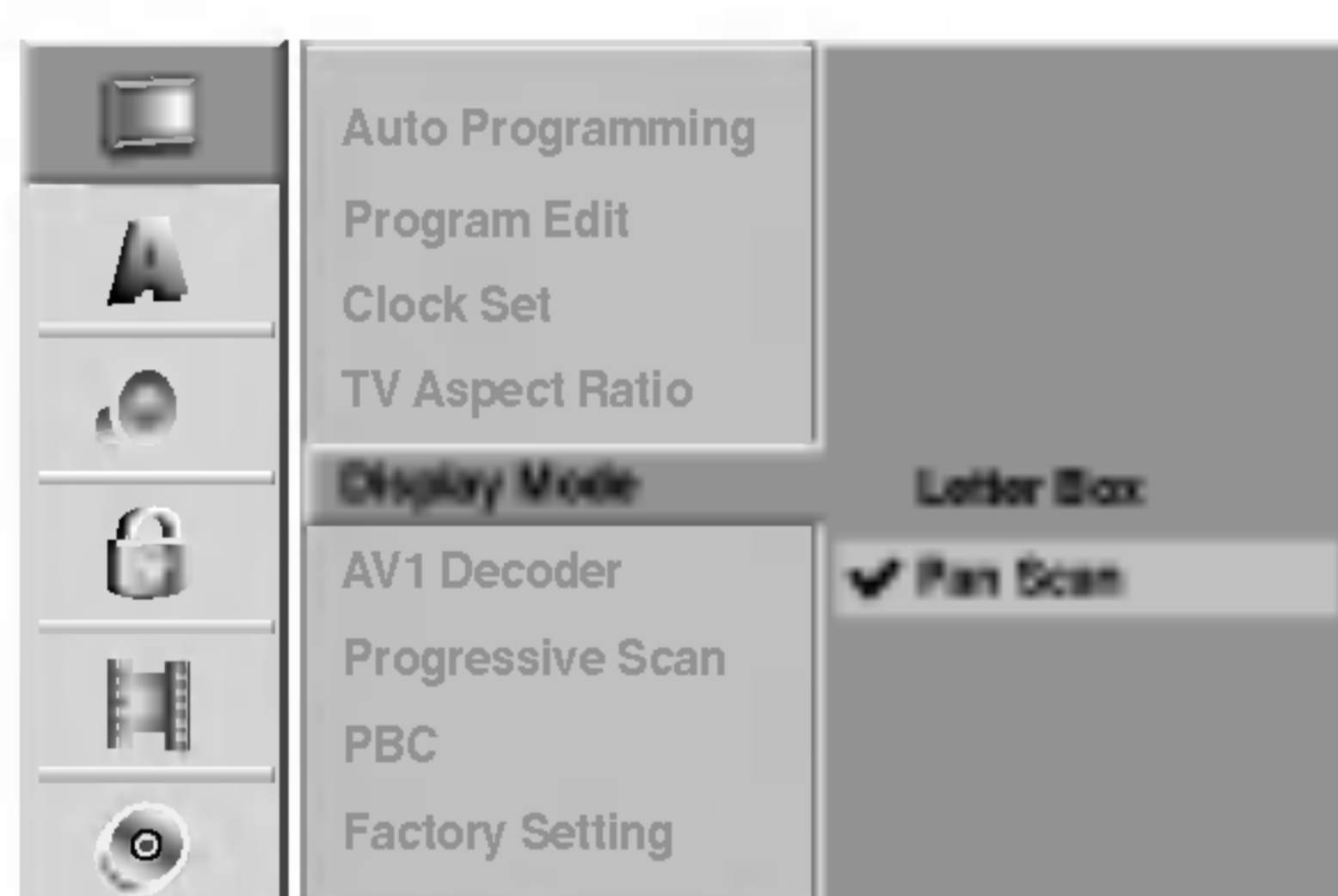

### AV1 Decoder

We have already described, how to connect a decoder for pay-TV station on page 15. For viewing or recording of an encoded program from EURO AV1 AUDIO/VIDEO connector, you do not have to control anything. You just select AV1 source by pressing AV/FUNC. button and wait shortly until the decoding will start.

Choose 'On' if your recorder is connected with a decoder, otherwise leave it set to 'OFF'.

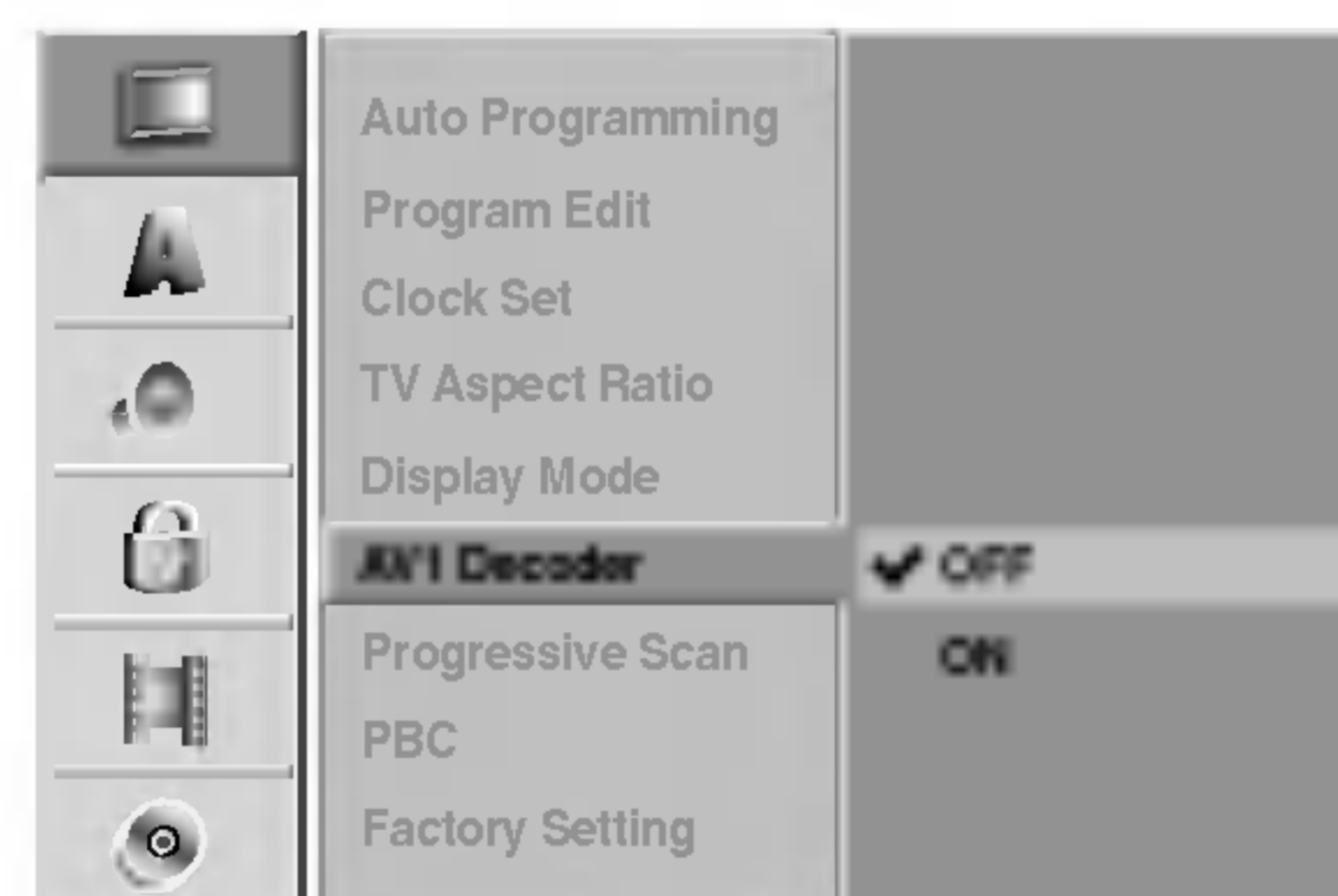

### Progressive Scan

Progressive Scan Video provides the highest quality pictures with less flickering.

- If you are using the COMPONENT VIDEO OUT / PROGRESSIVE SCAN jacks, but are connecting the DVD Recorder to a standard (analog) television, set Progressive Scan to OFF.
- If you are using the COMPONENT VIDEO OUT jacks for connection to a TV or monitor that is compatible with a progressive scan signal, set Progressive Scan to ON.

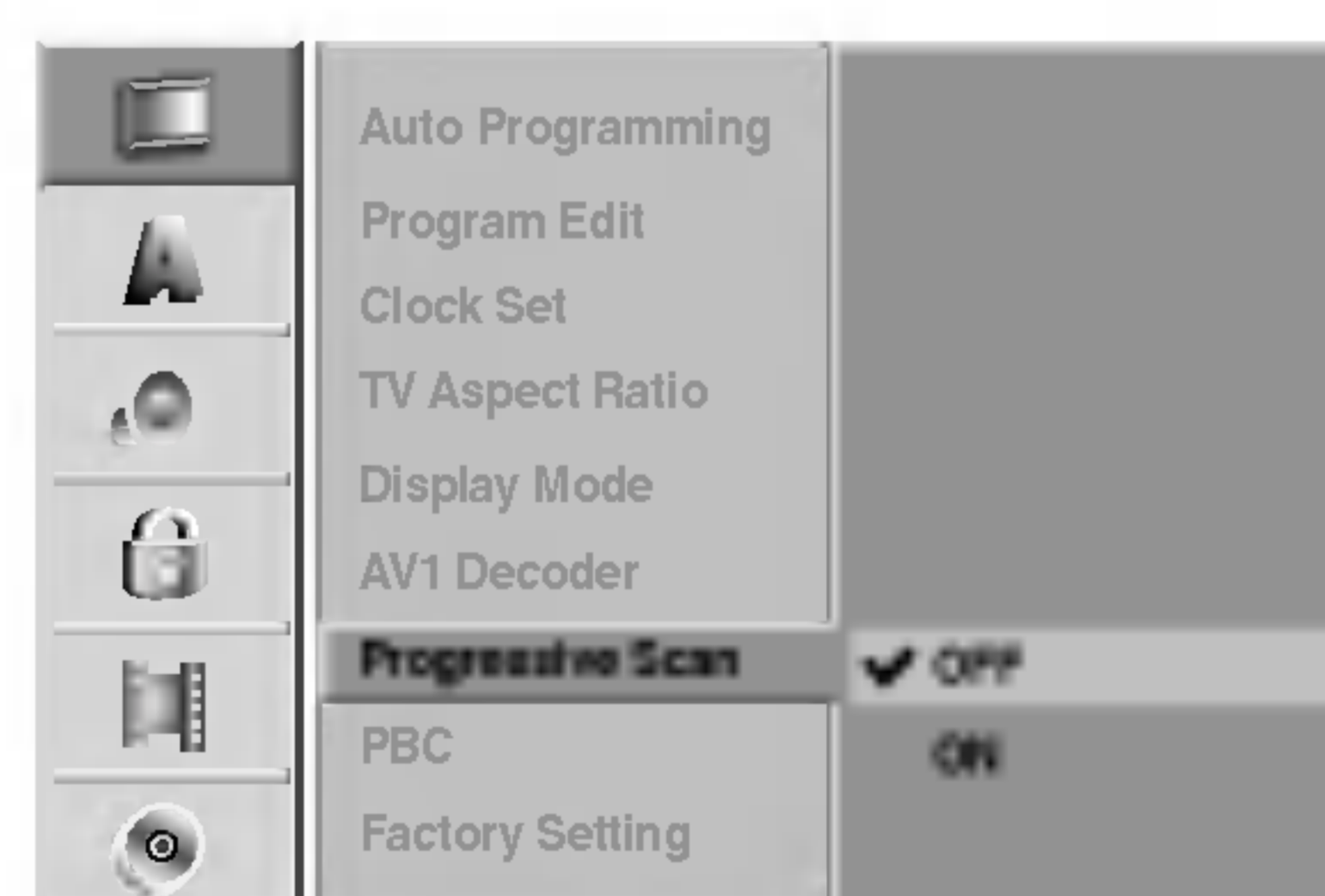

### ⚠ Caution

Once the setting for progressive scan output is entered, an image will only be visible on a progressive scan compatible TV or monitor. If you set Progressive Scan to ON in error, you must reset the unit.

- 1) Remove any disc from the unit and close the disc tray. See that "NO DISC" is displayed on the display window.
- 2) Press STOP and hold it for five seconds before releasing it. The video output will be restored to the standard setting and a picture will once again be visible on a conventional analog TV or monitor.

## Pre-operation Setup (Continued)

### PBC

The PBC setting can be changed. Set Playback Control (PBC) to ON or OFF.

- ON: Video CDs with PBC are played according to the PBC.
- OFF: Video CDs with PBC are played the same way as Audio CDs.

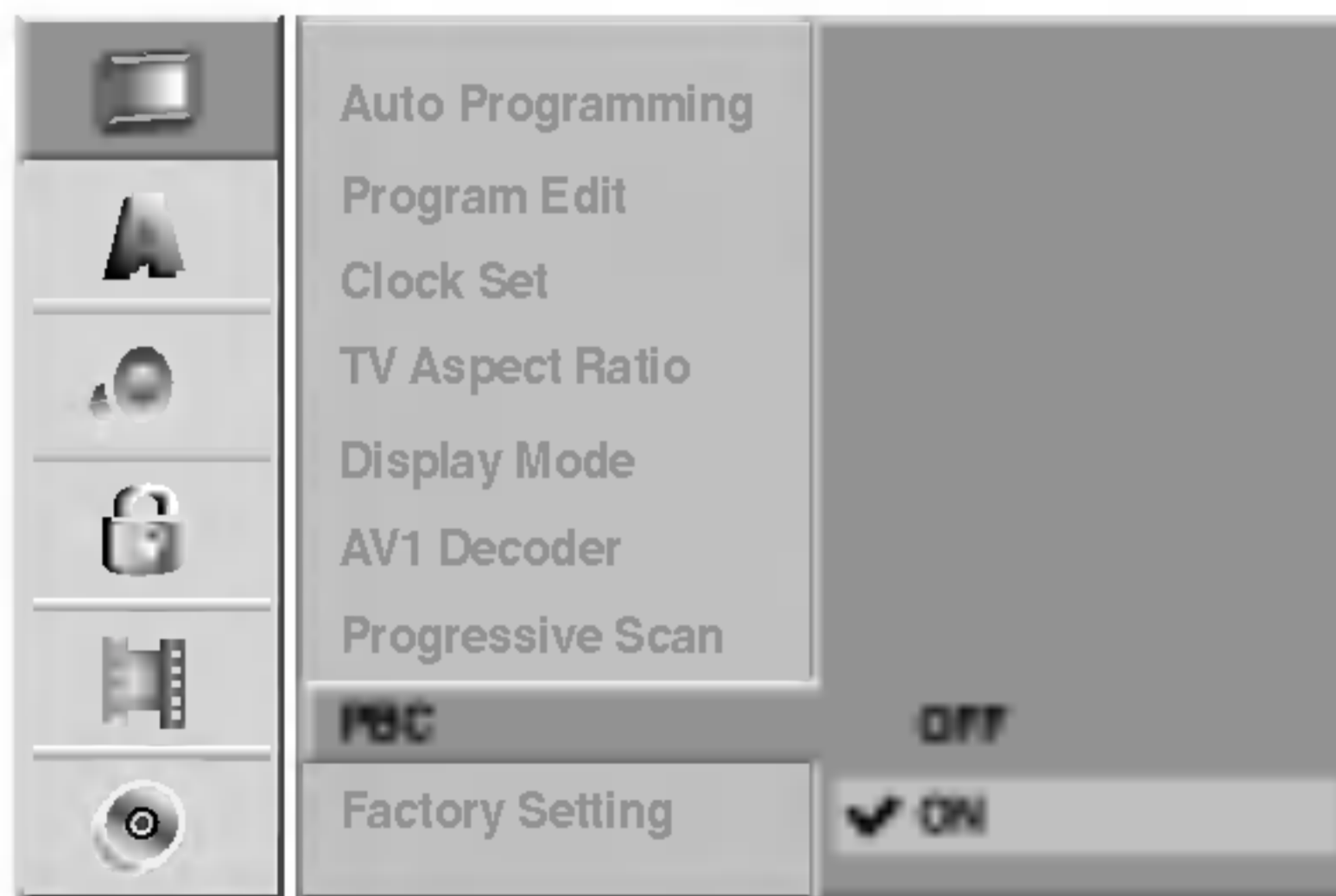

### Factory Set

If you need to, you can reset the Recorder to all its factory settings. Select "Set" icon then press ENTER/MEMORY.

#### **Note :**

Some options can not be reset. (Rating, Password, and Country Code)

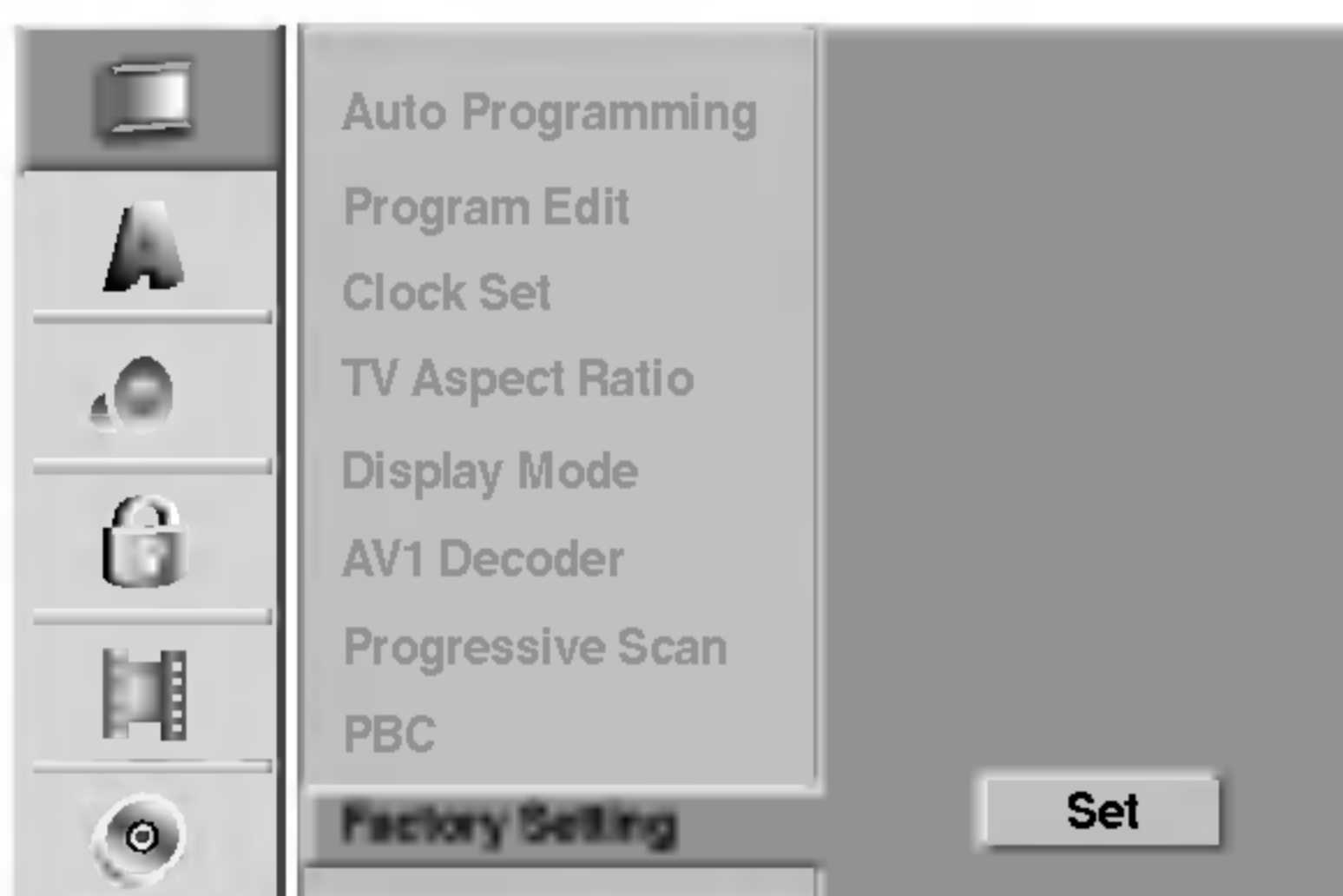

### Language

#### Display Language

Select a language for the Setup menu and on-screen display.



#### Disc Language

Select a language for the disc's Menu, Audio, and Subtitle.

- Original: The original language set for the disc is selected.
- Other: To select another language, select Other option then press ENTER/MEMORY. Use the numbered and ENTER/MEMORY buttons to key-in the corresponding 4-digit number according to the language code list on page 55. If you a mistake before pressing ENTER/MEMORY, press ◀ repeatedly to delete one by one and correct it.



## Pre-operation Setup (Continued)

### Audio

Each DVD disc has a variety of audio output options. Set the Recorder's Audio Output according to the type of audio system you use.

### Dolby Digital

**PCM:** Select when connected to a 2-channel digital stereo amplifier. The DVD Recorder's digital audio outputs sound in the PCM 2ch format when you play a DVD video disc recorded on the Dolby Digital recording system.

**Bitstream:** Select "Bitstream" if you connected the DVD Recorder's DIGITAL OUT jack to a Dolby Digital decoder (or an Amplifier or other equipment with a Dolby Digital decoder).



### DTS

**OFF:** If you select "OFF", the DTS signal is not output through the DIGITAL OUT jack.

**Bitstream:** Select "Bitstream" if you connected the DVD Recorder's DIGITAL OUT jack to a DTS decoder (or an Amplifier or other equipment with a DTS decoder).



### MPEG

**PCM:** Select when connected to a 2-channel digital stereo amplifier. The DVD Recorder's digital audio outputs sound in the PCM 2ch format if you play a DVD video disc recorded on the MPEG2 recording system.

**Bitstream:** Select "Bitstream" if you connected the DVD Recorder's DIGITAL OUT jack to an MPEG decoder (or an Amplifier or other equipment with a MPEG decoder).



### Sampling Frequency

If your Receiver or Amplifier is NOT capable of handling 96 kHz signals, select 48 kHz. If this choice is made, this unit will automatically convert any 96 kHz signals to 48 kHz so your system can decode them.

If your Receiver or Amplifier is capable of handling 96 kHz signals, select 96 kHz. If this choice is made, this unit will pass each type of signal through without any further processing.



### DRC (Dynamic Range Control)

With the DVD format, you can hear a program's soundtrack in the most accurate and realistic presentation possible, thanks to digital audio technology. However, you may wish to compress the dynamic range of the audio output (the difference between the loudest sounds and the quietest ones). Then, you may listen to a movie at a lower volume without losing clarity of sound. Set DRC to ON for this effect.

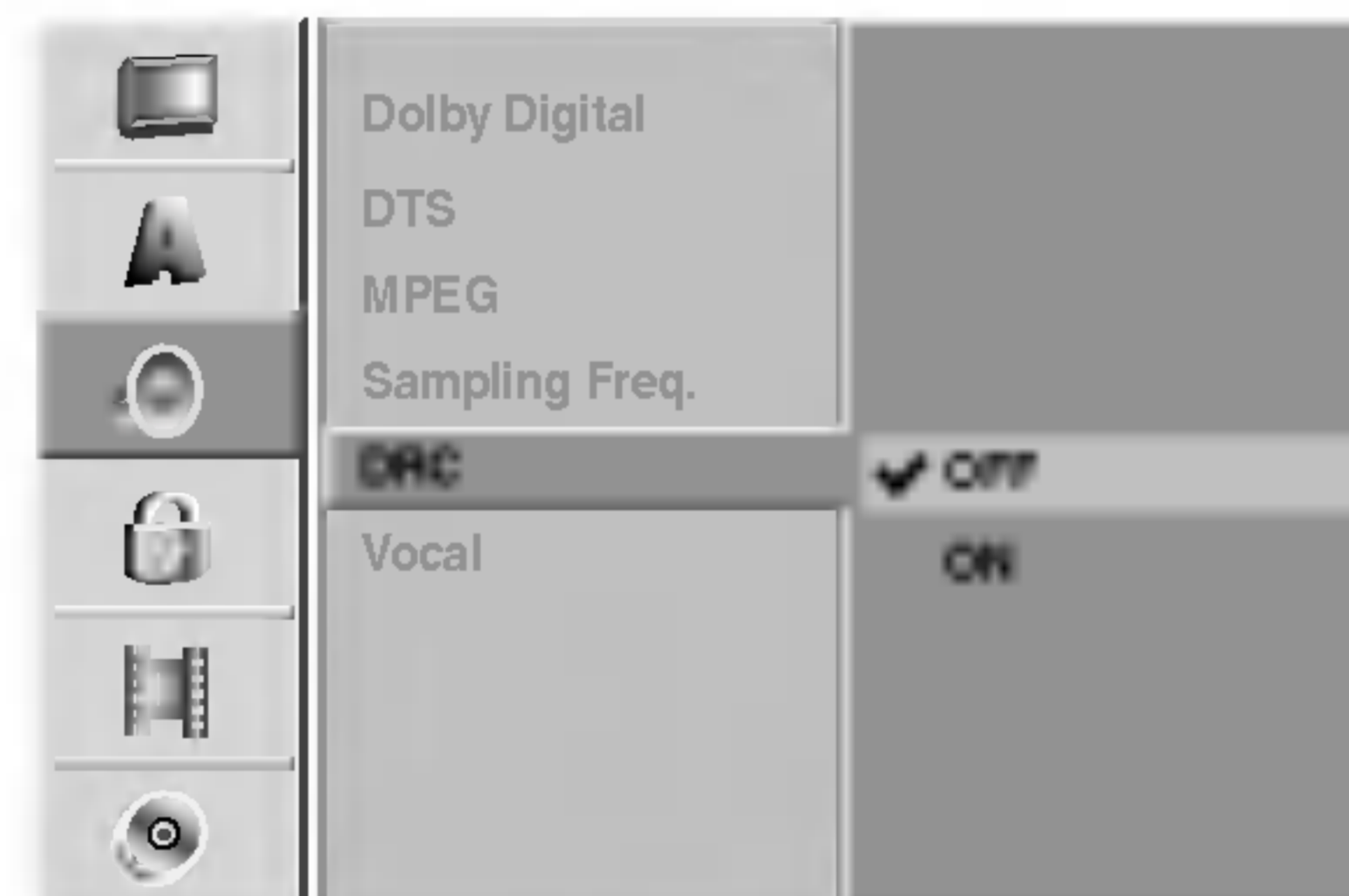

### Vocal

Set Vocal to ON only when a multi-channel karaoke DVD is playing. The karaoke channels on the disc will mix into normal stereo sound.



## Pre-operation Setup (Continued)

### Lock (Parental Control)

#### Set Password

##### Changing the 4-digit code



- 1 Press SETUP.**  
The Setup menu appears.
- 2 Use ▲ / ▼ to select the Lock option.**
- 3 While the Lock option is selected, press ► to move to the second level.**
- 4 Use ▲ / ▼ to select the Set Password option.**
- 5 Press ► to move to the third level.**
- 6 If you have not entered a password yet;**  
Enter/memory a 4-digit password using the numbered buttons to create a personal 4-digit security password, then press ENTER/MEMORY.  
Enter/memory the 4-digit password again and press ENTER/MEMORY to verify when "OK" is highlighted.  
**If you have already entered a password;**  
Enter/memory a 4-digit password using the numbered buttons to confirm the personal 4-digit security password, then press ENTER/MEMORY when "OK" is highlighted.

#### Tip

If you make a mistake before pressing ENTER/MEMORY, press ◀ repeatedly to delete password numbers one by one then correct it.

- 7 While "Change" is selected, press ENTER/MEMORY.**  
If you select "Delete" then press ENTER/MEMORY.  
The password is deleted.
- 8 Enter/memory a 4-digit password using the numbered buttons to create a personal 4-digit security password then press ENTER/MEMORY when "OK" is highlighted.**
- 9 Enter/memory the 4-digit password again and press ENTER/MEMORY to verify when "OK" is highlighted.**

#### Tip

If you a mistake before pressing ENTER/MEMORY, press ◀ repeatedly to delete password numbers one by one then correct it.

#### If you forget your 4-digit code

If you forget your password, to clear the current password, follow the procedure below.

1. Press SETUP to display the Setup menu.
2. Use the Number buttons to enter/memory the 6-digit number "210499".
3. Select "Yes" then press ENTER/MEMORY.  
The 4-digit password is cleared. Enter/memory a new code as shown left.

#### Rating

Movies on DVDs may contain scenes not suitable for children. Therefore, discs may contain Parental Control information that applies to the complete disc or to certain scenes on the disc. These scenes are rated from Level 1 to 8, and alternatively, more suitable scenes are available for selection on some discs. Ratings are country-dependent. The Parental Control feature allows you to prevent discs from being played by your children or to have certain discs played with alternate scenes.

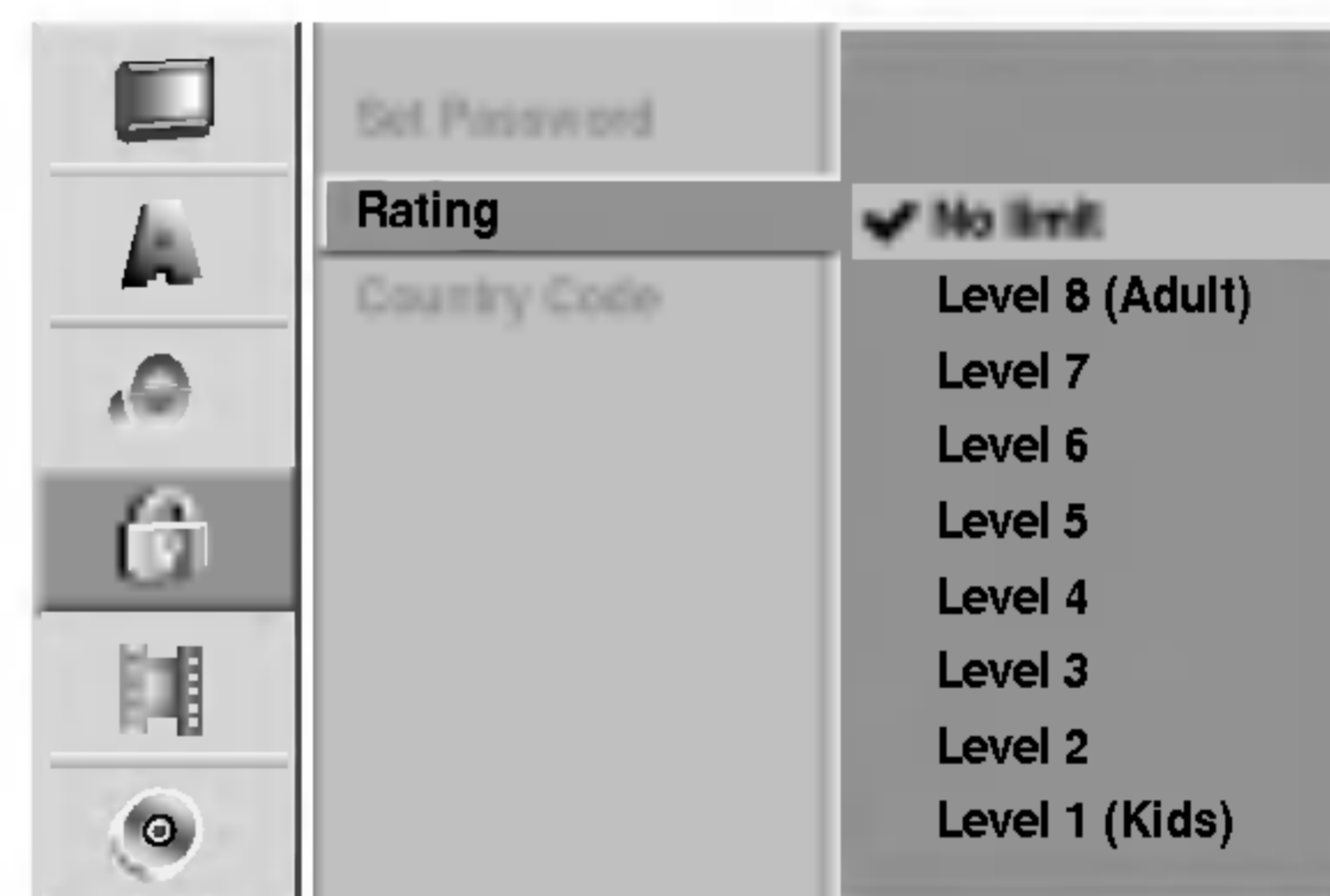

- 1 Follow steps 1-3 as shown above to the left (Set Password).**
- 2 Use ▲ / ▼ to select the Rating option.**
- 3 Press ► to move to the third level.**
- 4 Follow step 6 as shown above to the left (Set Password).**
- 5 Select a rating from 1 to 8 using the ▲ / ▼ buttons. One (1) has the least playback restrictions. Eight (8) has the most playback restrictions.**  
**No limit:** If you select No limit, Parental Control is not active. The disc will play in full.  
**Level 1 to 8:** Some discs contain scenes not suitable for children. If you set a rating for the Recorder, all disc scenes with the same rating or lower will be played. Higher rated scenes will not be played unless an alternate scene is available on the disc. The alternate scene must have the same rating or a lower one. If no suitable alternate scene is found, playback will stop. You must enter/memory the 4-digit password or change the rating level in order to play the disc.
- 6 Press ENTER/MEMORY to confirm your rating selection, then press SETUP to exit the menu.**

## Pre-operation Setup (Continued)

### Country Code

Enter/memory the code of a country/area whose standards were used to rate the DVD video disc, referring to the list (See "Country Codes", page 55.).

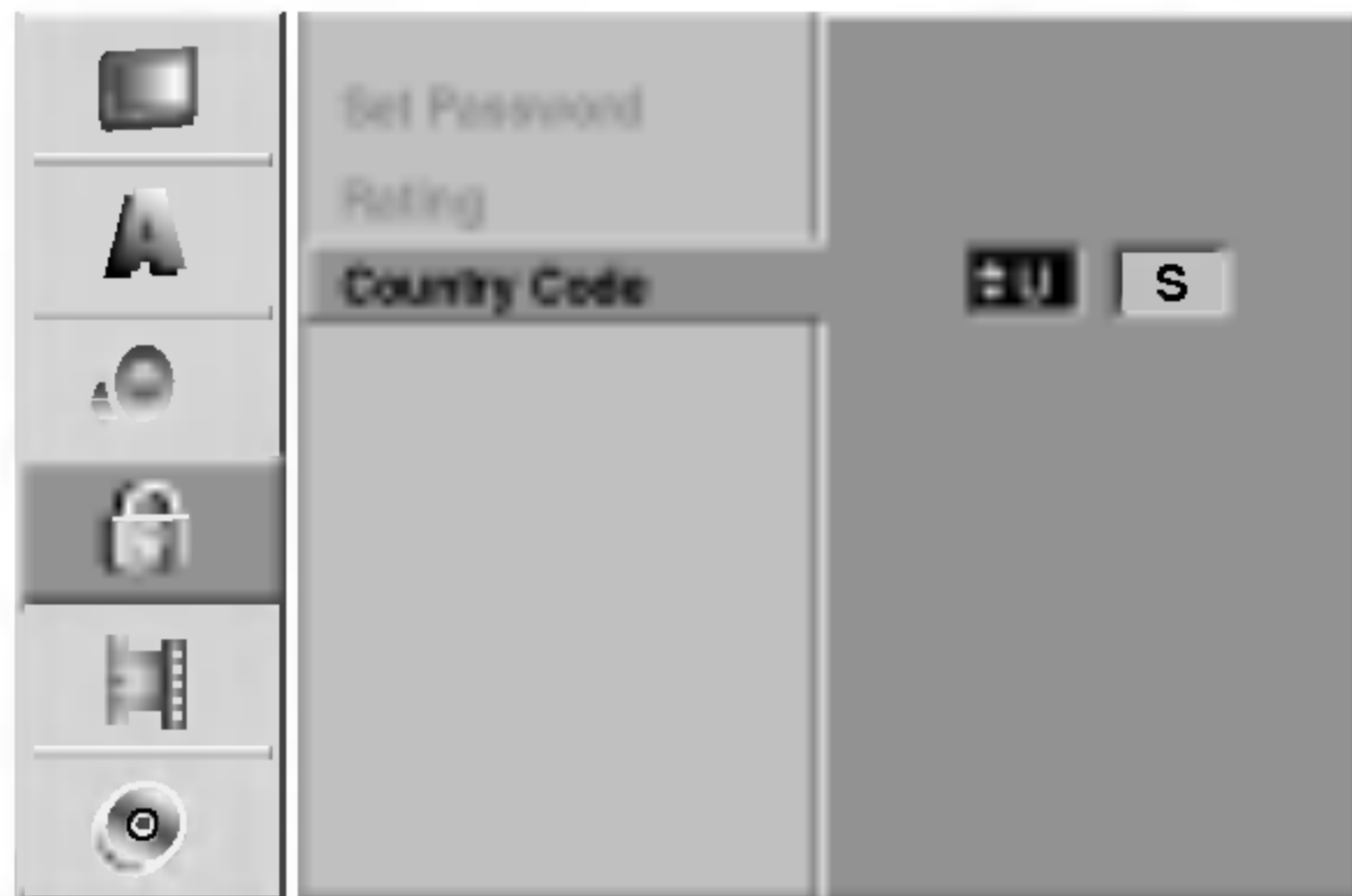

- 1 Press SETUP.**  
The Setup menu appears.
- 2 Use ▲ / ▼ to select the Lock option.**
- 3 While the Lock option is selected, press ► to move to the second level.**
- 4 Use ▲ / ▼ to select the Country Code option.**
- 5 Press ► to move to the third level.**
- 6 If you have not entered a password yet;**  
Enter/memory a 4-digit password using the numbered buttons to create a personal 4-digit security password, then press ENTER/MEMORY.  
Enter/memory the 4-digit password again and press ENTER/MEMORY to verify when "OK" is highlighted.  
**If you have already entered a password;**  
Enter/memory a 4-digit password using the numbered buttons to confirm the personal 4-digit security password, then press ENTER/MEMORY when "OK" is highlighted.

#### Tip

If you a mistake before pressing ENTER/MEMORY, press ◀ repeatedly to delete password numbers one by one then correct it.

- 7 Select the first character using the ▲ / ▼ buttons.**
- 8 Shift the cursor using ► buttons and select the second character using ▲ / ▼ buttons.**
- 9 Press ENTER/MEMORY to confirm your country code selection, then press SETUP to exit the menu.**

### Recording

#### Record Mode Set

You can set the picture quality for recording; HQ (High Quality), SQ (Standard Quality), LQ (Low Quality), EQ (Extend Quality).



#### Record Aspect Ratio

When recording in VR mode formatted DVD-RW disc, you can set the recording aspect ratio to suit the material you're recording (16:9 widescreen, or 4:3 standard).

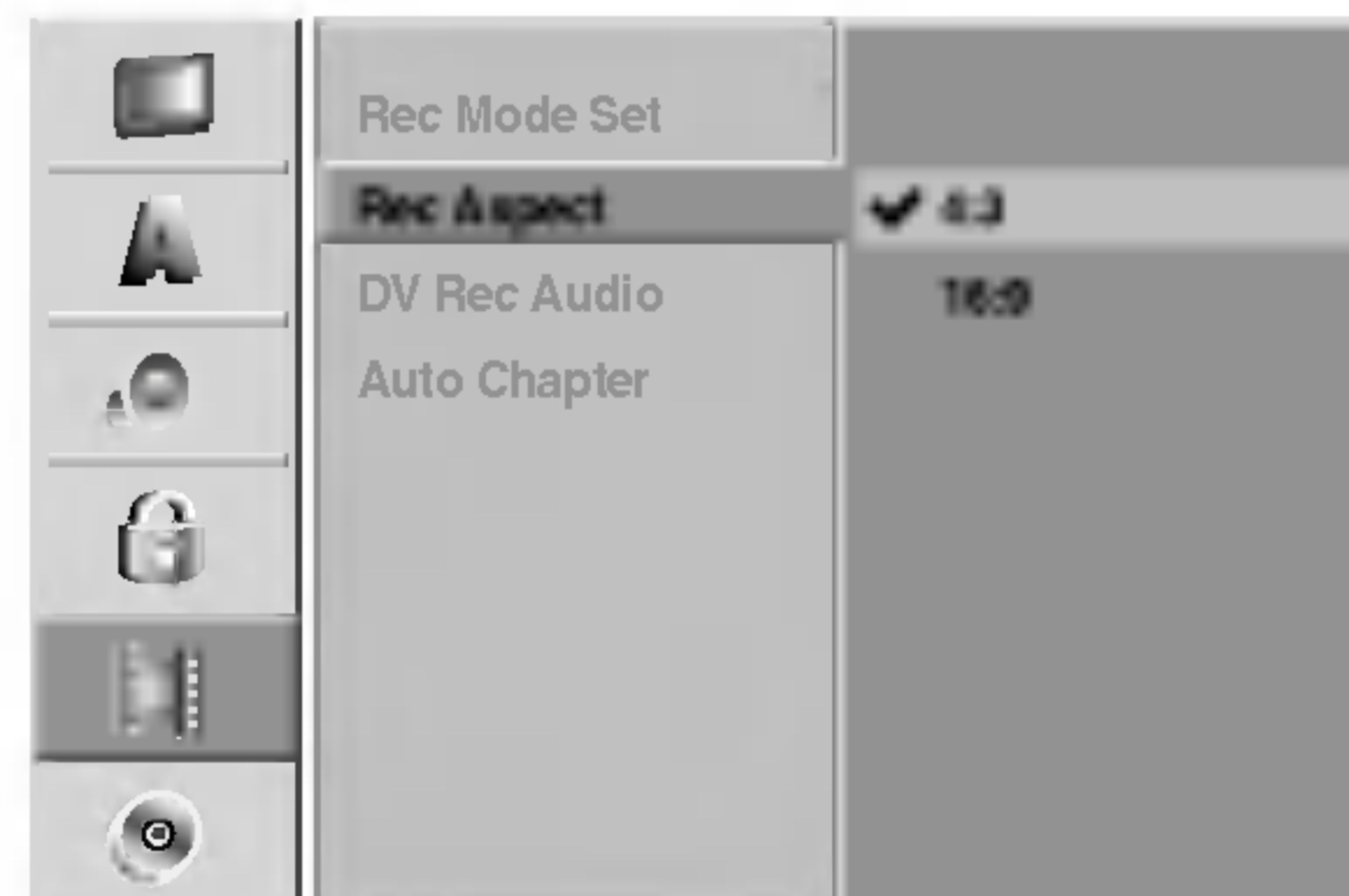

#### DV Record Audio

You need to set this if you have a camcorder using 32kHz/12-bit sound connected to the front panel DV IN port.

Some digital camcorders have two stereo tracks for audio. One is recorded at the time of shooting; the other is for over-dubbing after shooting.

On the Audio 1 setting, the sound that was recorded while shooting is used.

On the Audio 2 setting, the over-dubbed sound is used.

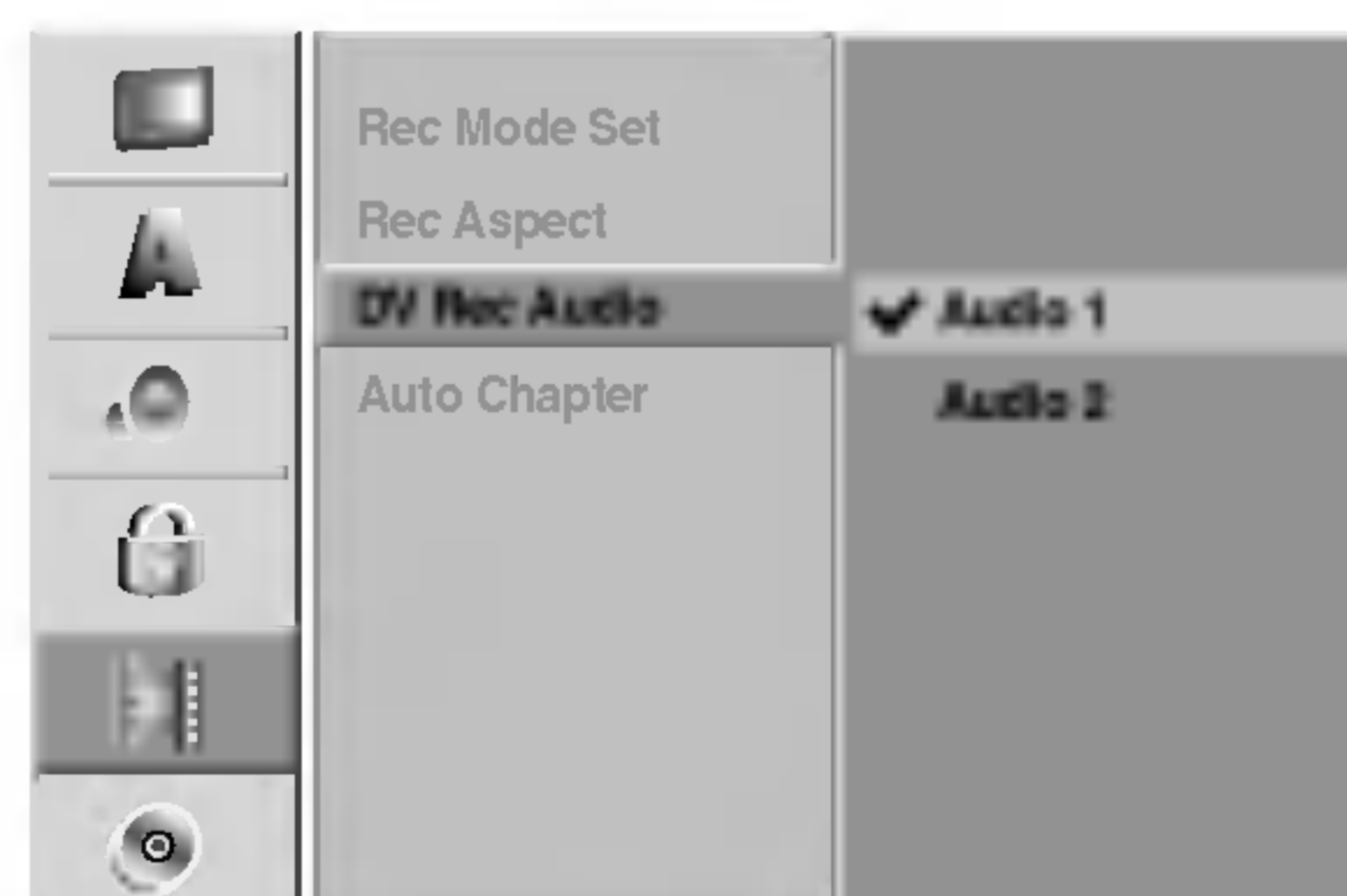

## Pre-operation Setup (Continued)

### Auto Chapter

When recording, chapter markers are put in at the specified interval. You can set this interval to 5 minutes, 10 minutes, or 15 minutes. If you select None, it switches automatic chapter marking off, no separations.

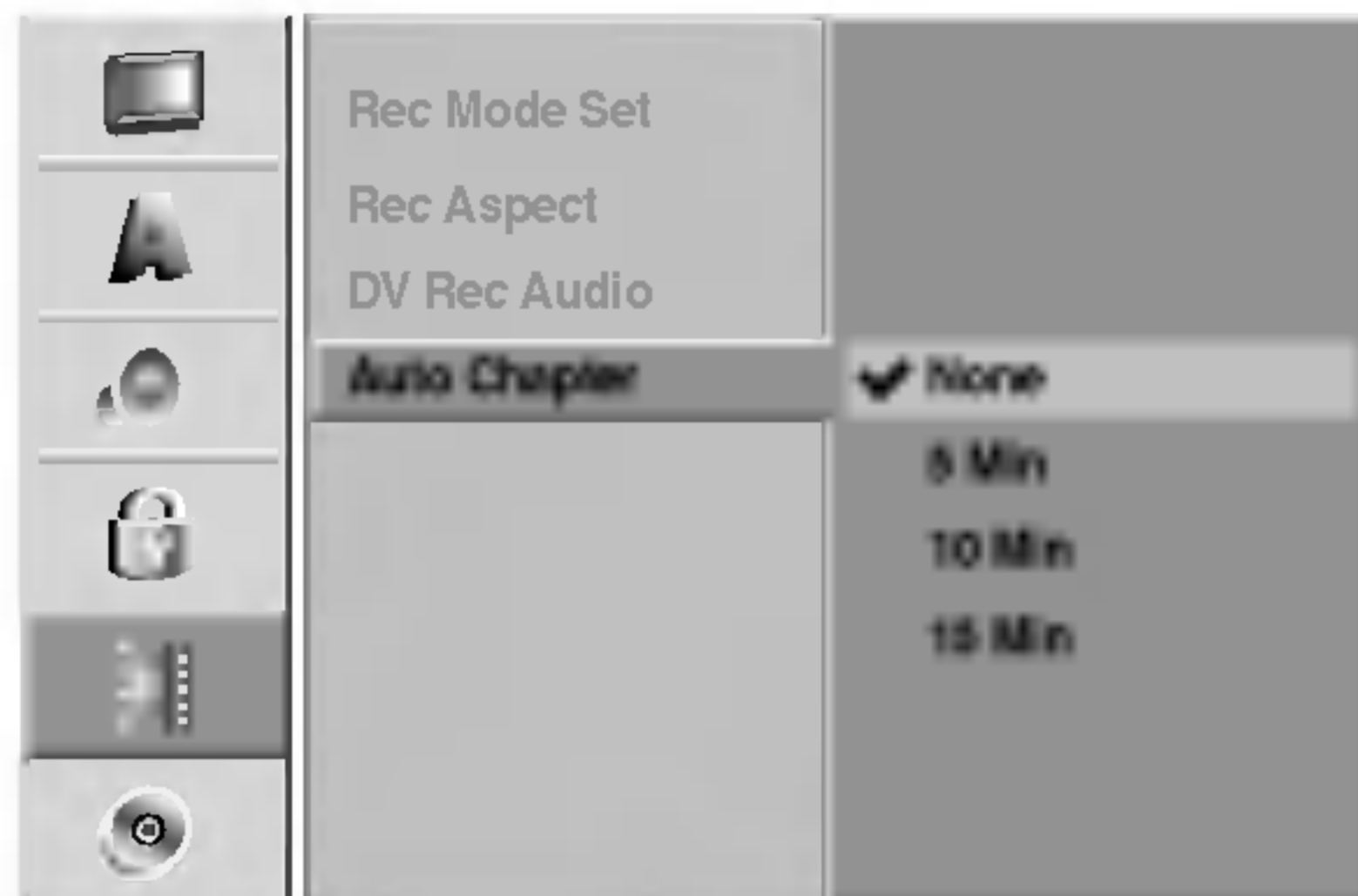

### Disc

#### Disc Format

If you load a completely blank disc, the "Disc Format" menu will appear. Select "Yes" then press ENTER/MEMORY. The Recorder will initialize the disc.

**DVD-R:** The Recorder initializes the disc for Video mode. The recording mode will always be Video mode.

**DVD-RW:** The Recorder initializes the disc for VR mode.

**DVD+R / DVD+RW:** The Recorder initializes the disc. Also, you can format the disc from the Setup menu as below.



- 1 Press SETUP.**  
The Setup menu appears.
- 2 Use ▲ / ▼ to select the Disc option.**
- 3 While the Disc option is selected, press ► to move to the second level.**
- 4 Use ▲ / ▼ to select the Disc Format option.**
- 5 Press ► to move to the third level.**  
"Start" icon is highlighted.
- 6 Press ENTER/MEMORY.**  
Disc Format menu appears.

- 7 For DVD-RWs, use ◀ / ▶ to select a Disc Format Mode (Vr Mode or Video Mode) then press ENTER/MEMORY.**  
For DVD+RWs, go to step 8.

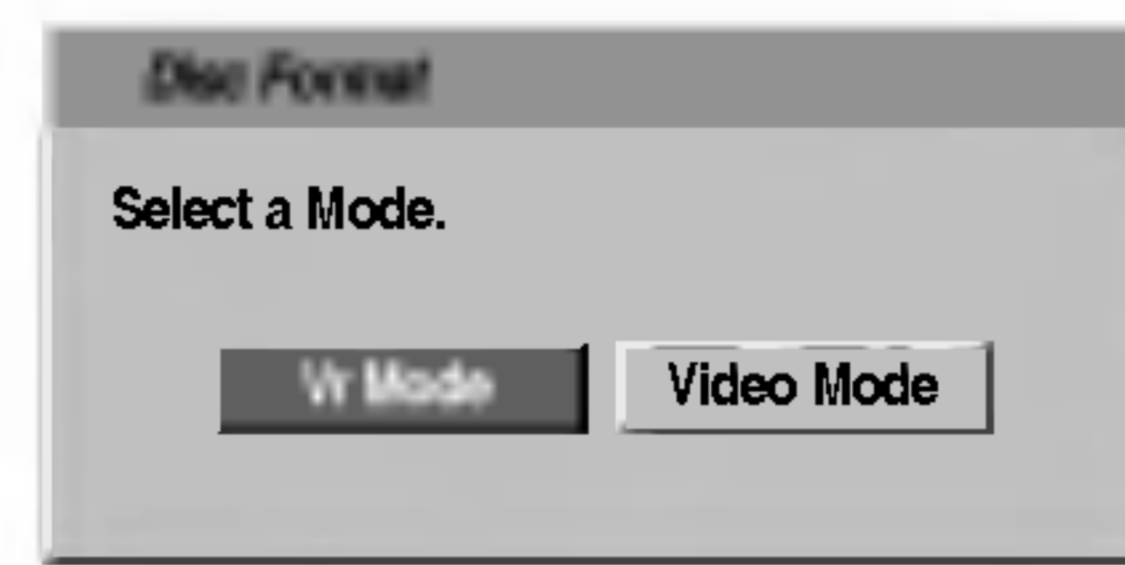

- 8 Use ◀ / ▶ to select "Yes" then press ENTER/MEMORY.**  
It takes a few moments to format the disc.

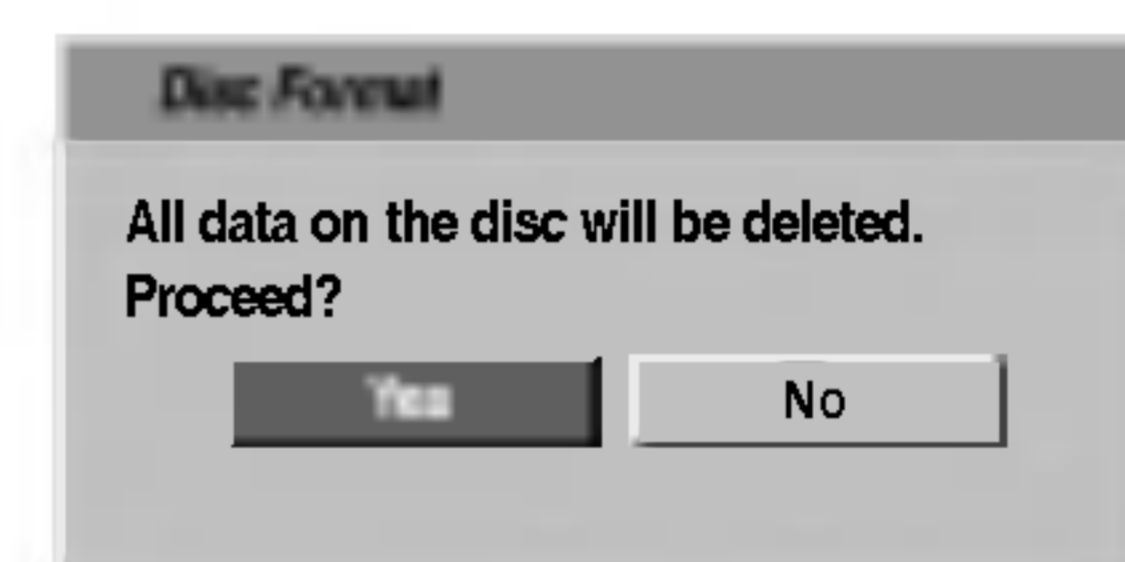

#### ⚠ Caution

**If you want to change the disc format, everything recorded on the disc will be erased.**

#### Disc Protect

When recording in DVD+RW / +R disc or VR mode formatted DVD-RW disc, set to ON to prevent accidental recording, editing or deleting of the disc loaded. If you need to unlock the disc to make edits, select OFF.

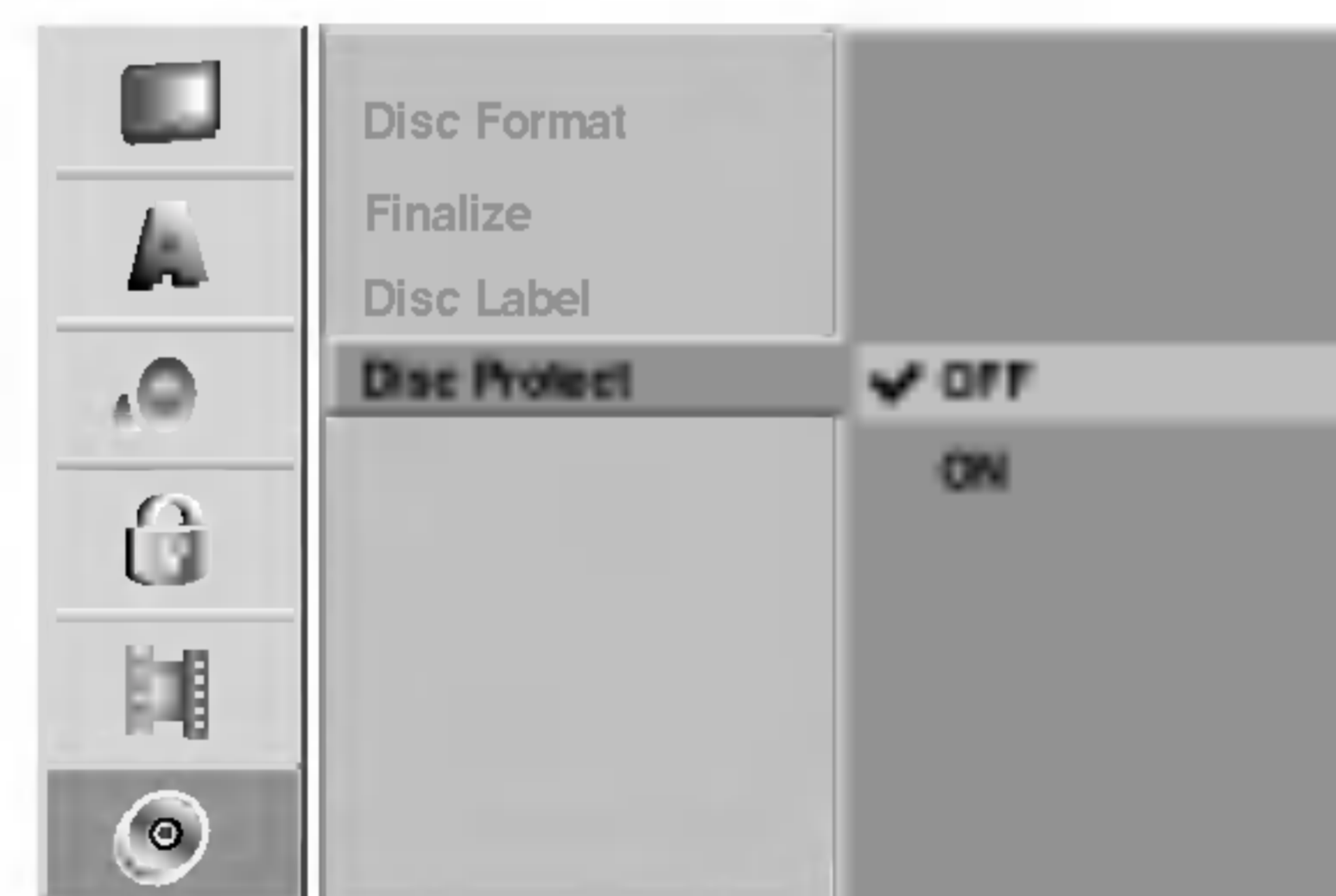

## Pre-operation Setup (Continued)

### Finalize

Finalizing 'fixes' the recordings in place so that the disc can be played on a regular DVD player or computer equipped with a suitable DVD-ROM drive.

Finalizing a Video mode disc creates a menu for navigating the disc. This is accessed by pressing MENU/LIST or TITLE.

#### Caution

After you've finalized a disc recording on a DVD-R, DVD-RW, or a DVD+R disc, you can't edit or record anything else on that disc except on a DVD+RW disc.



- 1 Follow steps 1-3 as shown on page 27 (Disc Format).
- 2 Use ▲ / ▼ to select the Finalize option.
- 3 Press ► to move to the third level. Finalize is highlighted.
- 4 Press ENTER/MEMORY. Finalize menu appears.

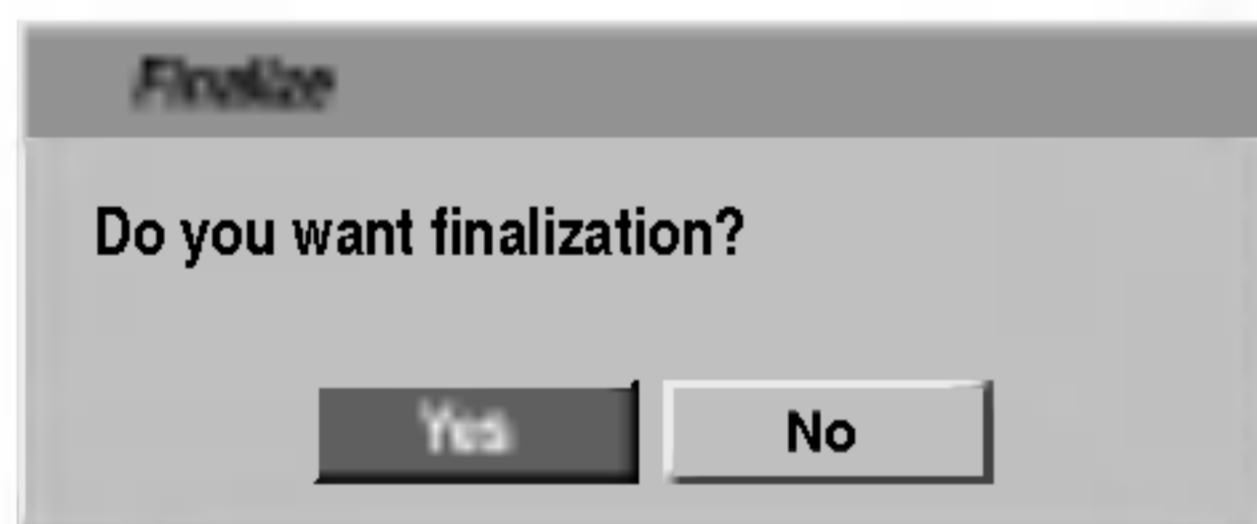

- 5 Select "Yes" then press ENTER/MEMORY. The recorder starts finalizing the disc.

#### Note :

How long finalization takes depends on the type of disc, how much is recorded on the disc, and the number of titles on the disc. A heavily recorded disc can take up to 8 minutes or more to finalize.

#### Tip

If you load a DVD-RW that has already been finalized, you can 'unfinalize' it by choosing Unfinalize from the Finalize menu. After doing this, you can edit and re-record onto the disc.

### Disc Label

Use this to enter/memory a name for the disc. This name appears when you load the disc and when you display disc information on-screen.

- The disc name can be up to 21 characters long.
- For discs formatted on a different DVD Recorder, you will see only a limited number of characters.

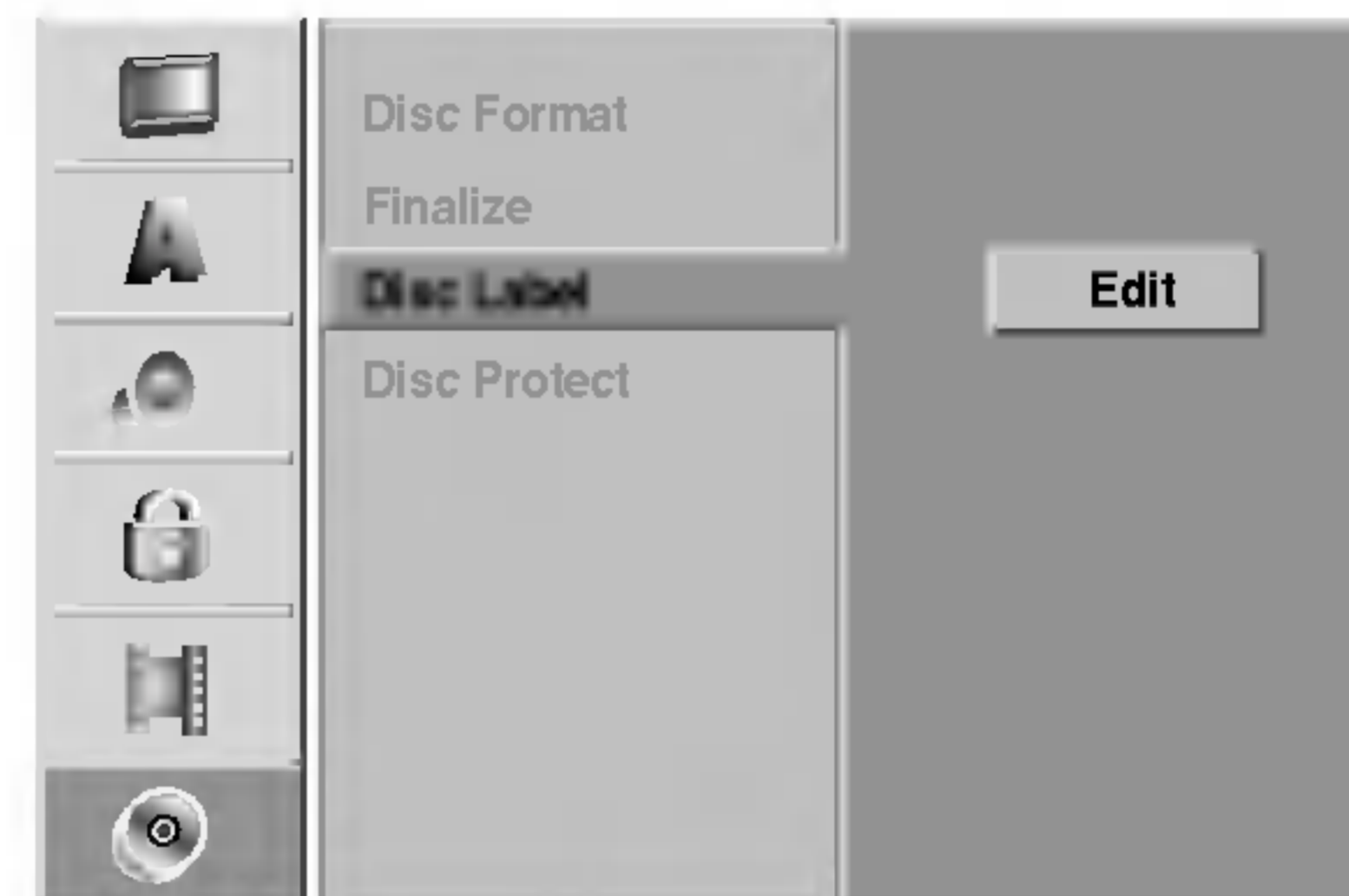

- 1 Follow steps 1-3 as shown Disc Format on page 27.
- 2 Use ▲ / ▼ to select the Disc Label option.
- 3 Press ► to move to the third level. "Edit" icon is highlighted.
- 4 Press ENTER/MEMORY. Keyboard menu appears.

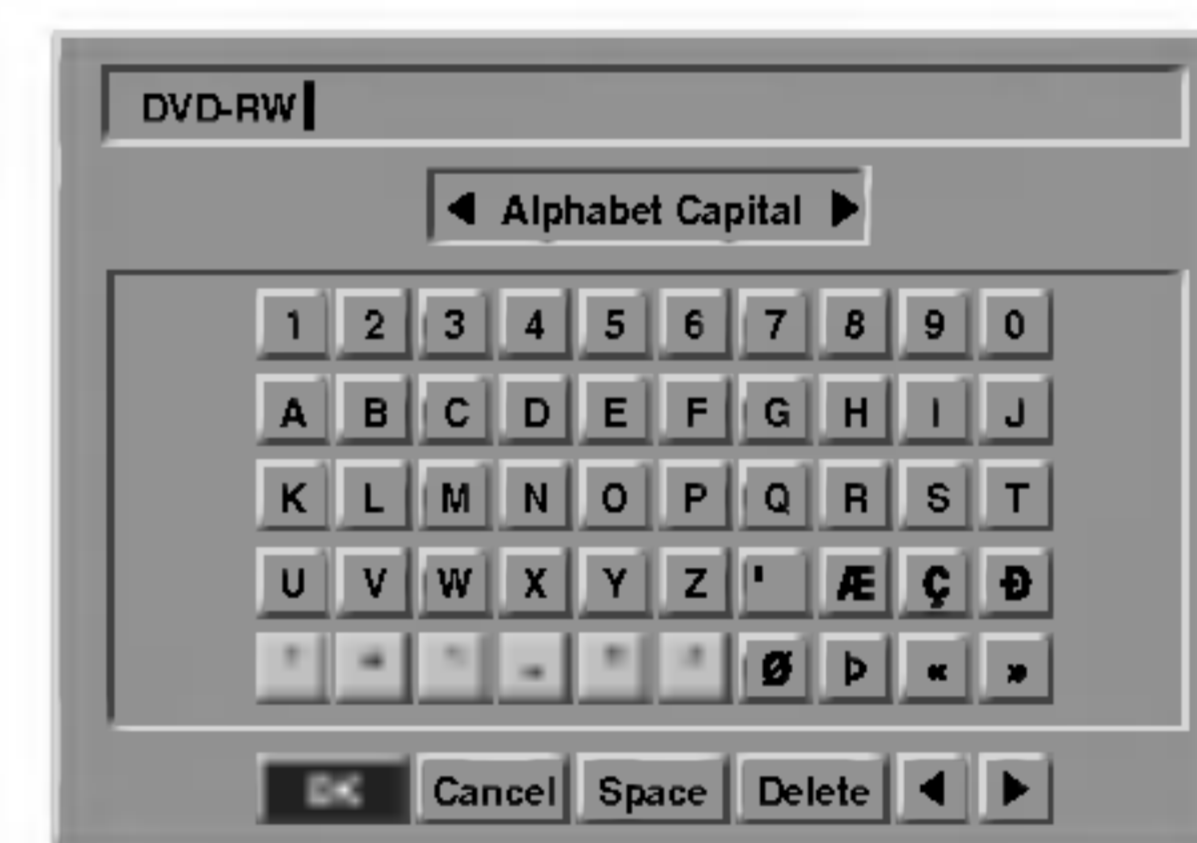

- 5 Enter/memory a name for the disc. Use ▲ ▼ ◀ ▶ to select a character then press ENTER/MEMORY to confirm your selection.

- **Alphabet Capital:** Switches the keyboard to upper case characters.
- **Alphabet Small:** Switches the keyboard to lower case characters.
- **Symbols:** Switches the keyboard to symbol characters.
- **OK:** Select to finish.
- **Cancel:** Select to exit the menu.
- **Space:** Inserts a space at the cursor position.
- **Delete:** Deletes the previous character at the cursor position.
- ◀ / ▶: Moves cursor to left or right.

- 6 Choose OK then press ENTER/MEMORY to save the name and return to the Setup menu.

- 7 Press SETUP to exit the menu.

## Pre-operation Setup (Continued)

### Overview for the On-Screen Display

This manual gives basic instructions for operating the DVD Recorder. Some DVDs require specific operation or allow only limited operation during playback. When this occurs, the symbol  appears on the TV screen, indicating that the operation is not permitted by the DVD Recorder or is not available on the disc.

### Displaying Information While Watching TV







While viewing the TV channels, press ENTER/MEMORY to display the information displayed on-screen.

Indicates channel number, station name, and audio signal (STEREO, MONO) received by the tuner.







Indicates current date and time.

**DVD** **VR** **Video** **+RW** **+R**

Menu Options	Function (Use ▲ / ▼ to select desired option)	Selection Method
Title Number  1/6	Shows the current title number and total number of titles, and skips to the desired title number.	◀ / ▶, or Numbers, ENTER/MEMORY
Chapter Number  4/26	Shows the current chapter number and total number of chapters, and skips to the desired chapter number.	◀ / ▶, or Numbers, ENTER/MEMORY
Time Search  00:10:30	Shows the elapsed playing time, and searches the point by the elapsed time directly.	Numbers, ENTER/MEMORY
Audio Language (DVD only) and Digital Audio Output Mode  D 2CH	Shows the current audio soundtrack language, encoding method, and channel number, and changes the setting.	◀ / ▶
Subtitle Language  OFF	Shows the current subtitles language, and changes the setting.	◀ / ▶
Angle  1/2	Shows the current angle number, total number of angles, and changes the angle number.	◀ / ▶
Sound  NORM	Shows the current sound mode, and changes the setting.	◀ / ▶

**VCD**



Menu Options	Function (Use ▲ / ▼ to select desired option)	Selection Method
Track Number  1/6	Shows the current track number and total number of tracks or PBC On mode, and skip to the desired track number.	◀ / ▶, or Numbers, ENTER/MEMORY
Time  00:10:30	Shows the elapsed playing time, and searches the point by the elapsed time directly.	Numbers, ENTER/MEMORY
Audio Channel  Stereo	Shows the audio channel, and changes the audio channel.	◀ / ▶
Sound  NORM	Shows the current sound mode, and changes the setting.	◀ / ▶

### Disc Information On-screen Display

You can display various information about the disc loaded on-screen.

- 1 Press DISPLAY repeatedly to display/change the information displayed on-screen.
- 2 To remove the On-Screen Display, press DISPLAY repeatedly until it disappears. See the descriptions on the following pages for detailed explanations of displays as a disc is playing.

### Recorder Status Icon Displays

-  Resume play from this point
-  Action prohibited or not available

### Notes :

- Some discs may not provide all of the features on the On-Screen Display, examples shown the below.
- If no button is pressed for 5 seconds, the On-Screen Display will disappear.

## DVD and Video CD Operation

### DVD or Video CD Playback

#### Playback Setup

- Turn the TV on and select the video input source connected to the DVD Recorder.
- Audio System: Turn the Audio System on and select the input source connected to the DVD Recorder.

**1** Press OPEN/CLOSE (▲) to open the disc tray.

**2** Load your chosen disc in the tray, with the playback side down.

**3** Press OPEN/CLOSE (▲) to close the tray. READING appears on the display window, and playback starts automatically. If playback does not start, press PLAY (▶).  
In some cases, the disc menu might appear instead.

#### Tip

##### If a menu is displayed

A menu may be displayed first after loading a DVD or Video CD that contains a menu.

#### DVD

Use the ◀ ▶ ▲ ▼ buttons to select the title/chapter you want to view, then press ENTER/MEMORY to start playback.

Press TITLE or MENU/LIST to return to the menu display.

#### VCD

- Use the number buttons to select the track you want to view.  
Press RETURN (↵) to return to the menu display.
- Menu setting and the exact operating procedures for using the menu may differ depending on the disc. Follow the instructions on each menu screen. You may also set PBC to OFF in the Setup menu. See page 23.

#### Notes :

- If Parental Control is set and the disc is not within the Rating settings (not authorized), the 4-digit code must be entered and/or the disc must be authorized (see "Rating", on page 25).
- DVDs may have a Region Code. Your recorder will not play discs that have a region code different from your recorder. The region code for this Recorder is 2 (two).

### General Features

#### Note :

Unless stated otherwise, all operations described use the Remote Control. Some features may also be available on the Setup menu.

#### TITLE Selection



If a disc has more than one title, you can move to another title as follows:

- Press DISPLAY then use ▲ / ▼ to select the title icon. Then, press the appropriate numbered button (0-9) or ◀ / ▶ to select a title number.

#### CHAPTER/TRACK Selection



If a title on a disc has more than one chapter/track, you can move to another chapter/track as follows:

- Press SKIP (◀◀ or ▶▶) briefly during playback to select the next chapter/track or to return to the beginning of the current chapter/track.
- Press SKIP (◀◀) twice briefly to step back to the previous chapter/track.
- To go directly to any chapter/track during playback, press DISPLAY. Then, use ▲ / ▼ to select chapter icon (or for a Video CD, select track icon). Then, enter/memory the chapter/track number using the numbered buttons (0-9) or press ◀ / ▶.

#### Search



1. Press SCAN (◀◀ or ▶▶) during playback. The Recorder will enter/memory SEARCH mode.
2. Press SCAN (◀◀ or ▶▶) to select the required speed: ◀◀X2, ◀◀X4, ◀◀X16, ◀◀X100 (backward) or ▶▶X2, ▶▶X4, ▶▶X16, ▶▶X100 (forward).  
With a Video CD, the Search speed changes: ◀◀X2, ◀◀X4, ◀◀X8 (backward) or ▶▶X2, ▶▶X4, ▶▶X8 (forward).
3. To exit SEARCH mode, press PLAY (▶).

#### Still Picture and Frame-by-Frame Playback



1. Press PAUSE/STEP (⏸) on the remote control during playback. Advance the picture frame-by-frame by pressing PAUSE/STEP (⏸) repeatedly.
2. To exit PAUSE mode, press PLAY (▶).

## DVD and Video CD Operation (Continued)

### General Features (Continued)

#### Slow Motion

DVD Video VR +RW +R VCD

1. Press PAUSE/STEP (II) during playback.  
The Recorder will enter/memory PAUSE mode.
2. Press SCAN (◀◀ or ▶▶) during PAUSE mode.  
The DVD Recorder will enter/memory SLOW mode.
3. Use the SCAN (◀◀ or ▶▶) to select the required speed: ◀◀ 1/16, ◀◀ 1/8, ◀◀ 1/4, or ◀◀ 1/2 (backward), or ▶▶ 1/16, ▶▶ 1/8, ▶▶ 1/4, or ▶▶ 1/2 (forward).  
With a Video CD, the Slow speed changes: ▶▶ 1/8, ▶▶ 1/4 or ▶▶ 1/2 (forward).
4. To exit Slow Motion mode, press PLAY (▶).

#### Note :

Slow motion playback in reverse is not possible with Video CDs.

#### Random Karaoke DVD VCD

1. Press RANDOM during playback.  
The unit automatically begins Random Playback and "RANDOM" appears on the TV screen.
2. To return to normal playback, press RANDOM until "NORMAL" appears on the TV screen.

#### Tip

By pressing SKIP ▶▶ during Random playback, the unit selects another title (track) and resumes Random playback.

#### Note :

- This function only works with DVD Karaoke discs or Video CDs without PBC.
- On a Video CD with PBC, you must set PBC to OFF in the Setup menu to use the Random function. See page 23.

#### Repeat Chapter

DVD Video VR +RW +R VCD

#### DVD Discs - Repeat Chapter/Title/Off

Press REPEAT to select a desired repeat mode.

- Chapter: repeats the current chapter.
- Title: repeats the current title .
- Off: does not play repeatedly.

#### Video CDs - Repeat Track/All/Off

Press REPEAT to select a desired repeat mode.

- Track: repeats the current track.
- All: repeats the all tracks on the disc.
- Off: does not play repeatedly.

#### Note :

On a Video CD with PBC, you must set PBC to OFF in the Setup menu to use the Repeat function. See page 23.

#### Repeat A-B A-B

DVD Video VR +RW +R VCD

To repeat a sequence in a title:

1. Press REPEAT A-B at your chosen starting point.  
Repeat icon and 'A-' appears on the TV screen.
2. Press REPEAT A-B again at your chosen ending point.  
Repeat icon and 'A-B' appears on the TV screen, and the repeat sequence begins.
3. To cancel the sequence, press REPEAT A-B repeatedly to select Off.

#### Time Search 00:10:33

DVD Video VR +RW +R

The Time Search function allows you to start playback at any chosen time on the disc.

1. Press DISPLAY during playback. The On-Screen Display appears on the TV screen.  
The Time Search box shows the elapsed playing time of the current disc.
2. Within 10 seconds, use ▲ / ▼ to select the Time Search icon in the On-Screen Display.  
The "0:00:00" display appears in the Time Search box.
3. Within 10 seconds, use the number buttons to enter/memory the required start time. Enter/memory hours, minutes, and seconds from left to right in the box.  
You can not enter/memory an invalid time.  
If you enter/memory the wrong numbers, press CLEAR.  
Then enter/memory the correct numbers.
4. Within 3 seconds, press ENTER/MEMORY to confirm the start time.  
Playback starts from the selected time on the disc.

## DVD and Video CD Operation (Continued)

### General Features (Continued)

#### Zoom



The Zoom function allows you to enlarge the video image and to move through the enlarged image.

1. Press ZOOM during playback or still playback to activate the Zoom function.  
Each press of the ZOOM button changes the TV display in the sequence shown below.  
x2 size → x4 size → normal size
2. Use the ◀ ▶ ▲ ▼ buttons to move through the zoomed picture.
3. To resume normal playback, press CLEAR or press ZOOM repeatedly until the normal picture appears.

#### Note :

The Zoom function may not work for some DVDs.

#### Marker Search



You can start playback from a memorized point. Up to nine points can be memorized.

To enter/memory a mark, follow these steps.

1. During disc playback, press MARKER when playback reaches the spot that you want to memorize.  
The Marker icon will appear on the TV screen briefly.
2. Repeat step 1 to enter/memory up to nine Marker points on a disc.

#### To Recall or Clear a Marked Scene

1. During disc playback, press SEARCH.  
The Marker Search menu will appear on the TV screen.
2. Within 10 seconds, use ◀ / ▶ to select the marker number that you want to recall or clear.
3. Press ENTER/MEMORY and playback starts from the marked scene. Or, Press CLEAR and the marker number is erased from the list.
4. You can play any marker by inputting its number on the marker search menu.

### Reviewing the Contents of DVD Video Discs: Menus

DVDs may contain menus that allow you to access special features. To open the disc menu, press MENU/LIST. Then, press the appropriate number button to select an option. Or, use the ◀ ▶ ▲ ▼ buttons to highlight your selection, then press ENTER/MEMORY.

#### Title Menu

1. Press TITLE.  
If the current title has a menu, the menu will appear on the TV screen. Otherwise, the disc menu may appear.
2. The menu may contain camera angles, spoken language and subtitle options, and chapters for the title.

#### Disc Menu

1. Press MENU/LIST.  
The disc menu is displayed.
2. To remove the disc menu, press MENU/LIST again.

#### Camera Angle

If the disc contains sequences recorded from different camera angles, the angle icon appears briefly on the TV screen. You can then change the camera angle if you wish.

1. Press DISPLAY during playback. The On-Screen Display appears on the TV screen.
2. Use ▲ / ▼ to select the Angle icon in the On-Screen Display.
3. Use ◀ / ▶ to select the desired angle.  
The number of the current angle appears on the TV screen.

### Changing the Audio Soundtrack



Press AUDIO then press ◀ / ▶ repeatedly during playback to hear a different audio language (DVD only) or audio soundtrack if available.

#### Note :

Some discs feature both Dolby Digital and DTS soundtracks. There is no analog audio output when DTS is selected. To listen to the DTS soundtrack, connect this Recorder to a DTS decoder via one of the digital outputs. See page 16 for connection details.

## DVD and Video CD Operation (Continued)

### Audio Channel Selection



Press AUDIO then press ◀ / ▶ repeatedly during playback to hear a different audio channel (Stereo, Left or Right).

### 3D Surround



This unit can produce a 3D Surround effect, which simulates multi-channel audio playback from two conventional stereo speakers, instead of the five or more speakers normally required to listen to multi-channel audio from a Home Theater System.

1. Press DISPLAY during playback. The On-Screen Display appears on the TV screen.
2. Use ▲ / ▼ to select the Sound icon in the On-Screen Display.
3. Press ◀ / ▶ repeatedly during playback to select "3D SUR".
4. To turn off the 3D Surround effect, select "NORM".

### Subtitles



Press SUBTITLE then press ◀ / ▶ repeatedly during playback to see the different subtitle languages.

### Last Condition Memory



This Recorder memorizes the user settings for the last disc that you have viewed. Settings remain in memory even if you remove the disc from the Recorder or switch off the Recorder. If you load a disc that had its settings memorized, the latest stop position is automatically recalled.

#### Notes :

- Settings are stored in memory for use any time.
- This Recorder does not memorize settings for a disc if you switch off the Recorder before commencing to play the disc.

## Audio CD and MP3/WMA Operation

### Playing an Audio CD or MP3/WMA

file **CD** **MP3** **WMA**

The DVD Recorder can play MP3/WMA formatted recordings on CD-ROM, CD-R, CD-RW, DVD-R, DVD-RW, DVD+R or DVD+RW discs.

#### Audio CD

Once you insert an audio CD a menu appears on TV screen. Press ▲ / ▼ to select a track then press PLAY (▶) or ENTER/MEMORY and playback starts.



#### MP3 / WMA

1. Press ▲ / ▼ to select a folder, and press ENTER/MEMORY to see the folder contents.
2. Press ▲ / ▼ to select a track then press PLAY (▶) or ENTER/MEMORY. Playback starts.

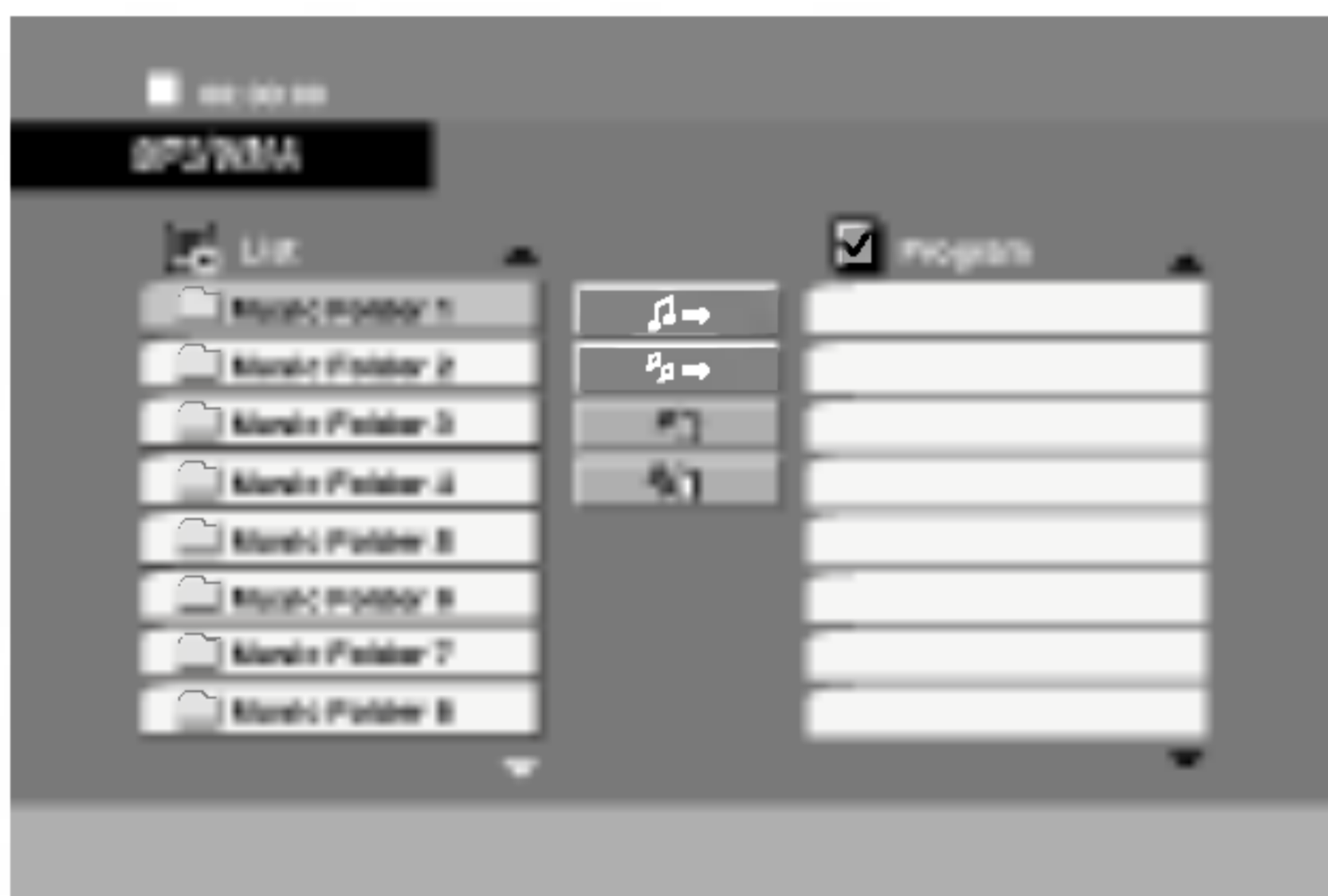

#### Tips

- If you are in a file list and want to return to the Folder list, use the ▲/▼ to highlight the folder icon and press ENTER/MEMORY to return to the previous menu screen.
- Press and hold ▲ / ▼ to go to the next / previous page.
- On CDs (or DVDs) with mixed content (MP3/WMA files and JPEG files), you can select between the MP3/WMA menu and JPEG menu. Press TITLE and MP3/WMA or JPEG word on top on the menu is highlighted. Use ◀/▶ to select MP3/WMA or JPEG then press ENTER/MEMORY.
- You can view TV channel or video input source by pressing RETURN (↵). If you want to return to the AUDIO CD or MP3/WMA menu, press MENU/LIST.

### Notes on MP3/WMA Recordings

**MP3 / WMA disc compatibility with this player is limited as follows:**

- Sampling frequency: within 32 - 48 kHz (MP3), within 32 - 48kHz (WMA)
- Bit rate: within 32 - 320kbps (MP3), 32 - 192kbps (WMA)
- The recorder cannot read an MP3/WMA file that has a file extension other than “.mp3” / “.wma”.
- CD-R physical format should be ISO 9660
- If you record MP3 / WMA files using software that cannot create a file system (eg. Direct-CD) it is impossible to playback MP3 / WMA files. We recommend that you use Easy-CD Creator, which creates an ISO 9660 file system.
- File names should have a maximum of 8 letters and must incorporate an .mp3 or .wma extension.
- They should not contain special letters such as / ? \* : “ < > | etc.
- The total number of files on the disc should be less than 999.

This DVD recorder requires discs and recordings to meet certain technical standards in order to achieve optimal playback quality. Pre-recorded DVDs are automatically set to these standards. There are many different types of recordable disc formats (including CD-R containing MP3 or WMA files) and these require compatible playback.

**Customers should note that permission is required in order to download MP3 / WMA files and music from the Internet. Our company has no right to grant such permission. Permission should always be sought from the copyright owner.**

## Audio CD and MP3/WMA Operation (Continued)

### Pause **CD** **MP3** **WMA**

1. Press PAUSE/STEP (||) during playback.
2. To return to playback, press PLAY (▶) or press PAUSE/STEP (||) again.

### Track Selection **CD** **MP3** **WMA**

- Press SKIP ◀◀ or ▶▶ briefly during playback to go to the next track or to return to the beginning of the current track.
- Press SKIP ◀◀ twice briefly to step back to the previous track.
- On an Audio CD, to go directly to any track, enter/memory the track number using the numbered buttons (0-9) during playback on the Track List.

### Repeat Track/All/Off

**CD** **MP3** **WMA**

Press REPEAT to select a desired repeat mode.

- TRACK: repeats the current track.
- ALL : repeats the all tracks on the disc.
- OFF (No display): does not play repeatedly.

### Random **CD** **MP3** **WMA**

1. Press RANDOM during playback or in Stop mode. The unit automatically begins Random Playback and "Random" appears on the menu display.
2. To return to normal playback, press RANDOM repeatedly until "Random" disappears from the menu display.

#### Tip

By pressing SKIP ▶▶ during Random playback, the unit selects another track and resumes Random playback.

### Search **CD**

1. Press SCAN (◀◀ or ▶▶) during playback. The Recorder will enter/memory SEARCH mode.
2. Press SCAN (◀◀ or ▶▶) to select the required speed: ◀◀X2, ◀◀X4, ◀◀X8 (backward) or ▶▶X2, ▶▶X4, ▶▶X8 (forward). Search speed and direction are indicated on the menu display.
3. To exit SEARCH mode, press PLAY (▶).

### Repeat A-B **CD** **MP3** **WMA**

To repeat a sequence in a track:

1. Press REPEAT A-B at your chosen starting point. Repeat icon and 'A' appears on the menu screen.
2. Press REPEAT A-B again at your chosen ending point. The Repeat icon and 'A - B' appears on the menu screen, and the repeat sequence begins.
3. To exit the sequence and return to normal play, press REPEAT A-B again. The Repeat icon disappears from the menu screen.

## Audio CD and MP3/WMA Operation (Continued)

### Programmed Playback

The program function enables you to store your favorite tracks from any disc in the player memory. A program can contain 99 tracks (Audio CD) or 256 tracks (MP3/WMA).

1. Insert a disc.

#### Audio CD and MP3/WMA Discs:

Audio CD or MP3/WMA menu appears.

2. Select a track on the List.
3. Select “” icon then press ENTER/MEMORY to place the selected track on the Program list. Repeat to place additional tracks on the list.

You can add all tracks in the disc. Select “” icon then press ENTER/MEMORY.

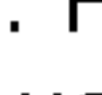
4. Select the track you want to start playing on the Program list. Press and hold  /  to move to the next / previous page.



Audio CD Menu

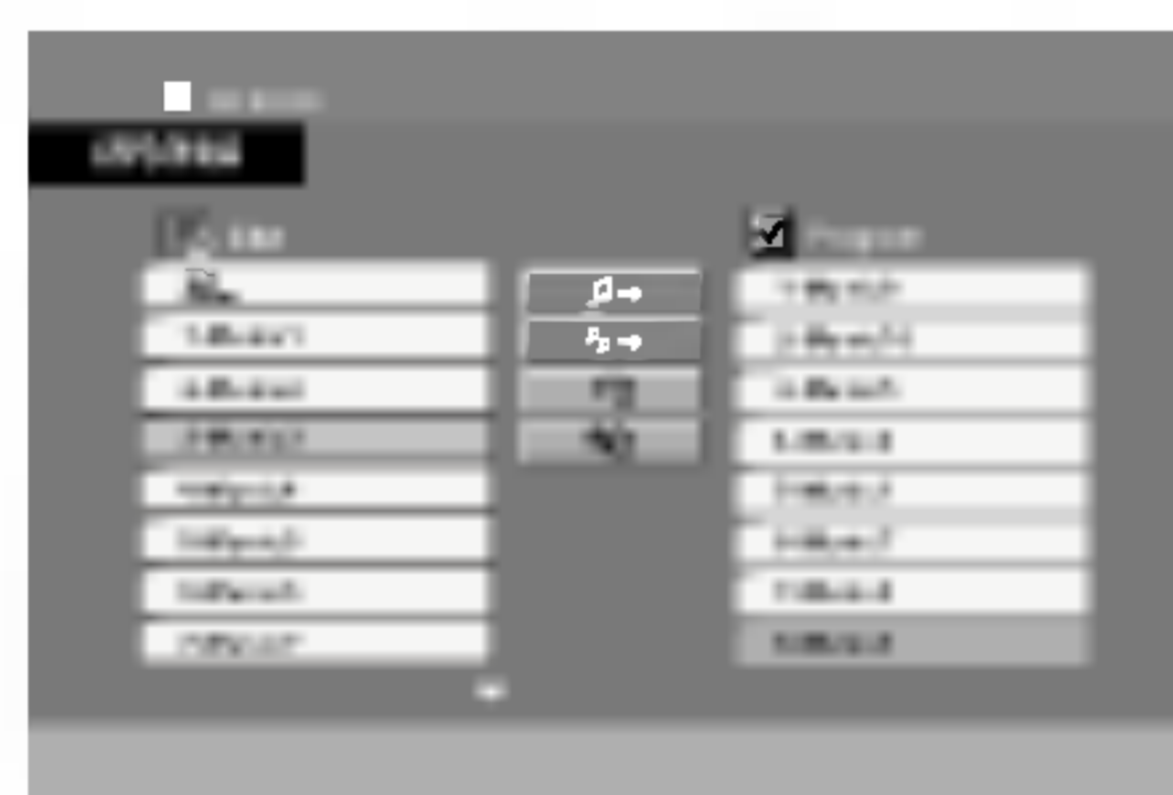

MP3/WMA Menu

5. Press PLAY () or ENTER/MEMORY to start. Playback begins in the order in which you programmed the tracks. Playback stops after all of the tracks on the Program list have played once.

### Repeat Programmed Tracks





You can play a track/all on a disc.

1. Press REPEAT when playing a disc. The repeat icon appears.
2. Press REPEAT to select a desired repeat mode.
  - TRACK: repeats the current track
  - ALL: repeats all the tracks on programmed list.
  - Off(No display): does not play repeatedly.

#### Note :

If you press SKIP () once during Repeat Track playback, the repeat playback cancels.

### Erasing a Track from Program List

1. Use     to select the track that you wish to erase from the Program list.
2. Press CLEAR. Or, select “” icon then press ENTER/MEMORY to erase the selected track on the Program list. Repeat to erase additional tracks on the list.

### Erasing the Complete Program List

Select “”, then press ENTER/MEMORY. The complete Program for the disc is erased.

#### Note:

The programs are also cleared when the disc is removed.

## JPEG File Operation

### Viewing a JPEG Disc

Using this DVD Recorder you can view CD-R/RW, DVD+R/RW or DVD-R/RW with JPEG files.

1. Insert a disc and close the tray. The JPEG menu appears on the TV screen.

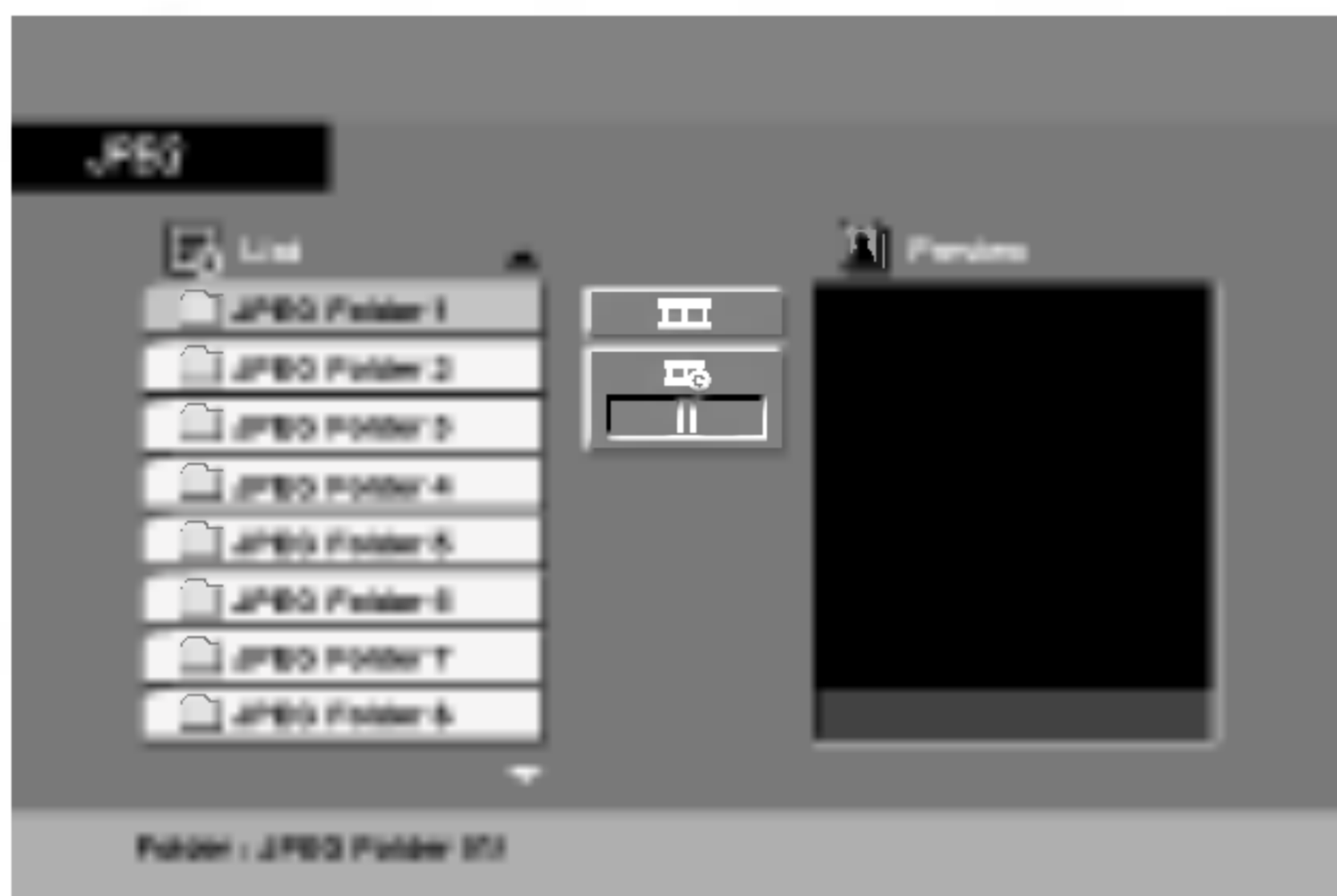

2. Press ▲ / ▼ to select a folder, then press ENTER/MEMORY. A list of files in the folder appears. If you are in a file list and want to return to the previous Folder list, use the ▲ / ▼ buttons on the remote to highlight [Back] then press ENTER/MEMORY.
3. If you want to view a particular file, press ▲ / ▼ to highlight a file then press ENTER/MEMORY or PLAY (▶). Slide Show starts from the selected file if Speed option is not II (Off). While viewing a file, you can press STOP to move to the previous menu (JPEG menu).

#### Tip:

- There are four Slide Speed options ( [Speed] ) : >>>> (Fast), >> (Normal), > (Slow) and II (Off). Use ▲ ▼ ◀ ▶ to highlight the Speed options ( [Speed] ). Then, use ◀ / ▶ to select the option you want to use then press ENTER/MEMORY.
- If you are in a file list and want to return to the Folder list, use the ▲/▼ to highlight [Back] and press ENTER/MEMORY to return to the previous menu screen.
- Press and hold ▲ / ▼ to go to the next / previous page.
- On CDs (or DVDs) with mixed content (MP3/WMA files and JPEG files), you can select between the MP3/WMA menu and JPEG menu. Press TITLE and MP3/WMA or JPEG word on top on the menu is highlighted. Use ◀/▶ to select MP3/WMA or JPEG then press ENTER/MEMORY.
- You can view TV channel or video input source by pressing RETURN (↺). If you want to return to the JPEG menu, press MENU/LIST.

### Slide Show [JPEG]

Use ▲ ▼ ◀ ▶ to highlight the [Slide Show] on the JPEG menu then press ENTER/MEMORY.

### Still Picture [JPEG]

1. Press PAUSE/STEP during slide show. The recorder will now go into PAUSE mode.
2. To return to the slide show, press PLAY (▶) or press PAUSE/STEP again.

### Moving to another File [JPEG]

Press SKIP (◀◀ or ▶▶) or cursor (◀ or ▶) once while viewing a picture to advance to the next or previous file.

### To rotate picture [JPEG]

Press ▲ / ▼ during showing a picture to rotate the picture clockwise or counter clockwise.

### JPEG disc compatibility with this recorder is limited as follows:

- Depending upon the size and number of JPEG files, it could take a long time for the DVD Recorder to read the disc's contents. If you don't see an on-screen display after several minutes, some of the files may be too large — reduce the resolution of the JPEG files to less than 5M pixels as 2760 x 2048 pixels and burn another disc.
- The total number of files and folders on the disc should be less than 999.
- Some discs may be incompatible due to a different recording format or the condition of disc.
- Ensure that all the selected files have the ".jpg" extensions when copying into the CD layout.
- If the files have ".jpe" or ".jpeg" extensions, please rename them as ".jpg" file.
- File names without ".jpg" extension will not be able to be read by this DVD Recorder. Even though the files are shown as JPEG image files in Windows Explorer.

## Basic Recording

### Basic Recording from TV channels

Follow the instructions below to record a TV program. Recording starts immediately and continues until the disc is full or you stop the recording.

- 1 Switch on the recorder and load a recordable disc.**  
Also make sure that the TV's input source is set to this recorder. If you load a completely blank disc, the recorder takes a short while to initialize the disc.
- 2 Set a recording mode as necessary by pressing REC MODE repeatedly. (HQ, SQ, LQ, EQ)**  
HQ; High Quality, SQ; Standard Quality, LQ: Low Quality, EQ: Extended Quality
- 3 Use CH/PR (▲ / ▼) buttons to select the TV channel to record.**

#### Changing TV Audio Channel

You can select the audio channel (language) to listen by pressing AUDIO during viewing TV program. The current audio channel is displayed on-screen.

Stereo or mono broadcast: Stereo → Left → Right

Bilingual broadcast: Main+Sub → Main → Sub

- If the sound is of poor quality when set to Stereo, you can often improve it by changing to Mono (Left or Right).
- This recorder can record either NICAM or regular audio. If the NICAM setting (page 20) is set to Auto, then if the broadcast is NICAM, the audio automatically changes to NICAM and you can record the NICAM audio. If the broadcast is non-NICAM, the regular audio is always recorded.  
If NICAM sound distortion occurs, due to poor reception, you can switch off NICAM setting of the program.

- 4 Press REC (●) once.**  
Recording will start. (The REC indicator lights in the display window.)
  - Recording continues until you press STOP (■) or the disc is full.
  - To record for a fixed length of time, see Instant Timer Recording on right.

- 5 Press STOP (■) to stop recording.**

### To Pause the Recording

1. Press PAUSE/STEP (||) to pause the disc during recording.
2. When you want to continue recording, press PAUSE/STEP (||).

### To record one TV program while watching another

- 1 Press TV/DVD to select the TV mode during recording. The TV indicator appears in the display window.
- 2 Using the TV, select the channel to be viewed.

### Instant Timer Recording

Instant Timer Recording allows you to make a recording easily of a preset length without using the program timer.

- 1 Follow steps 1-4 as shown left (Basic Recording from a TV channels).**
- 2 Press REC (●) repeatedly to select the recording time length.**

Recording starts after the first press. Each additional press increases the recording time by 10 minutes within the available free space (maximum 120 minutes).

The recording time is displayed on the TV screen. At the end of the recording, the DVD Recorder will stop recording and shut off.

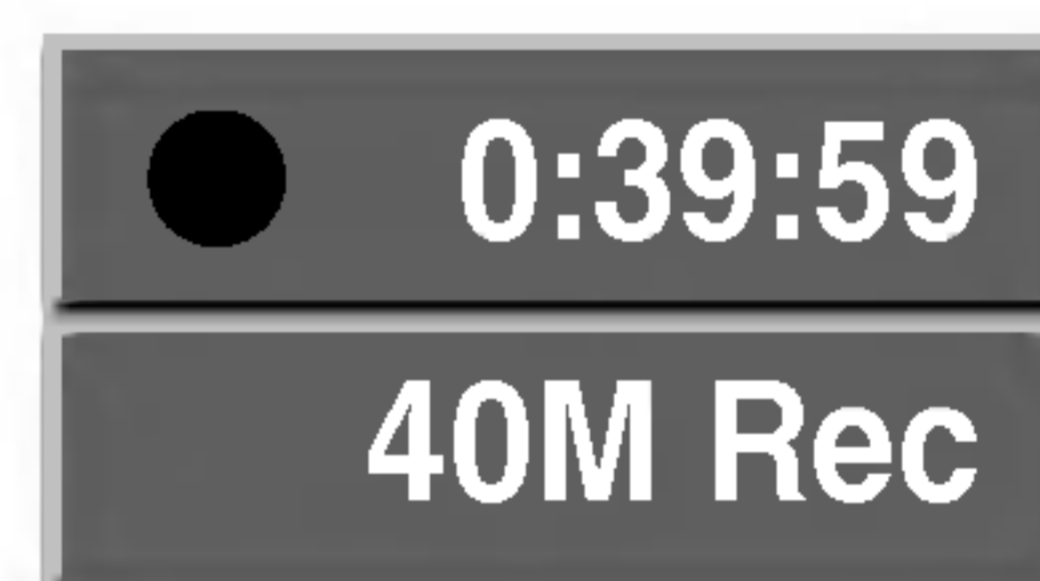

Instant Timer Recording Menu

### Checking the Recording Time

Press REC (●) once to check the recording time. The remaining time will be displayed on the TV screen for a moment.

### To Extend the Recording Time

The recording time can be extended anytime by pressing REC (●).

Each additional press increases the recording time by 10 minutes within the available free space (maximum 120 minutes).

#### ⚠ Caution

If the Recorder is unplugged (or there is a power failure) while the Recorder is recording, the recording will be lost.

## Timer Recording

This DVD Recorder can be programmed to record up to 7 programs over a period of 1 month. For unattended recording, the timer needs to be set with the channels to be recorded, the starting time and length.

### 1 Press **TIMER REC.**

The Timer Record menu will appear.



- **PR** – Choose a memorized program number, or one of the external inputs from which to record.
- **Date** – Choose a date up to 1 month in advance.
- **Start Time** – Set the recording starting time.
- **End Time** – Set the recording ending time.
- **Mode** – Choose a record mode (HQ, SQ, LQ, EQ, or AT).  
AT (Auto) mode determines how much disc time is available and switches record mode, if necessary, to complete recording the program.

#### **Note :**

- When you set the VPS/PDC option to On, AT mode is not available.
- **Repeat** – Choose a desired repeat (Once, Daily (Monday - Friday), or Weekly).
- **VPS/PDC** – The VPS/PDC system automatically adjusts the recording time so that even if a program is not running to schedule, you won't miss it. For VPS/PDC to work properly, you must input the correct announced time and date of the program you want to record.  
Note that VPS/PDC may not work with every station.

#### **Notes :**

- Stations that use VPS/PDC typically include VPS/PDC information in the teletext TV guide pages. Please refer to these pages when setting a timer recording.
- This recorder takes approximately 20 seconds to switch on and start recording. This means that when using VPS/PDC, there may be instances where the beginning of the program is not recorded.

### 2 Enter/memory the necessary information for your timer recording(s).

- ◀ / ▶ (left/right) – moves the cursor left/right
- ▲ / ▼ (up/down) – changes the setting at the current cursor position
- Press RETURN (↵) to exit the Timer Record menu.
- Press ENTER/MEMORY after filling in all the program information.
- Press **TIMER REC** to display Timer Record List.

### 3 Press **ENTER/MEMORY**, the program will be memorized by the DVD Recorder.

To check the programming, the Timer Record List will appear.

Check field's "Rec. OK" on the Timer Record List indicates that the timer recording is programmed correctly and a recordable disc is inserted.

### 4 Press RETURN (↵) to exit the Program List.

### 5 Make sure that you load a recordable disc and press **POWER** to switch your unit to Standby.

#### **Notes :**

- The timer indicator lights in the display window if the Recorder is in standby with the timer active.
- You must press **POWER** to stop the timer recording.
- There is a short delay when a timer recording finishes to confirm the recorded program. If two timer recordings are set to record sequentially (one right after the other), the very beginning of the later program may not be recorded.

## Timer Recording (Continued)

### Reviewing Timer Recording Details

Programming can be checked whenever the DVD Recorder is turned on. Press TIMER REC twice.

- Use ▲ / ▼ to select a timer recording.
- Press **ENTER/MEMORY** to edit the selected program. Timer Record menu appears.
- Press **CLEAR** to remove the selected program from the Timer Record List.



### Canceling a Timer Recording

You can clear a timer setting anytime before the recording actually starts.

- Use ▲ / ▼ to select a program you want to remove on the Timer Recorder List. If you want to remove the program, press CLEAR.

The confirm message will appear. use ◀/▶ to select "Yes" then press ENTER/MEMORY.

### Stopping a Timer Recording in Progress

After a timer recording has started, you can still cancel the program.

- Press POWER.

### Timer Recording Troubleshooting

**Even though the timer is set, the Recorder will not record when:**

- There is no disc loaded.
- A non-recordable disc is loaded.
- Disc Protect is set to ON in the Setup menu (see page 27).
- Power is turned on.
- There are already 99 titles (DVD-RW, DVD-R, DVD+R), 49 titles (DVD+RW) recorded on the disc.

**You cannot enter/memory program for a timer recording if:**

- A recording is already underway.
- The time you're trying to set has already passed.
- There are already 7 timer programs set.

**If two or more timer programs overlap:**

- The earlier program takes priority.
- After the earlier program finishes, the later program starts.
- If two programs are set to start at exactly the same time, the program entered first takes priority.

If the disc is damaged, the recording may not be completed successfully. In this case even though the Check field shows "Rec. OK", it may not be.

## Recording from an External Input Source

### Recording from External Components

You can record from an external A/V device, such as a camcorder or VCR, connected to any of the Recorder's external inputs.

- 1 Make sure that the component you want to record from is connected properly to the DVD Recorder. See page 17.**
- 2 Press AV/FUNC. repeatedly to select the external input to record from.**
  - Tuner: Built-in tuner
  - AV1: EURO AV1 AUDIO VIDEO mounted on back panel
  - AV2: EURO AV2 DECODER mounted on back panel
  - AV3: AUDIO IN 3 / VIDEO IN 3 mounted on back panel
  - AV4: INPUT 4 (VIDEO, AUDIO (L/R), S-VIDEO IN) mounted on front panel
  - DV: DV IN mounted on front panel
- 3 Load a recordable disc.**
- 4 Select the recording mode as necessary by pressing REC MODE repeatedly. (HQ, SQ, LQ, EQ)**  
HQ; High Quality, SQ; Standard Quality, LQ: Low Quality, EQ: Extended Quality
- 5 Press REC (●) once.**  
Recording will start. (The REC indicator lights in the display window.)
  - Recording continues until you press STOP (■) or the disc is full.
  - To record for a fixed length of time, see Instant Timer Recording on page 38.
- 6 Press STOP (■) to stop recording.**

#### Note :

If your source is copy-protected using CopyGuard, you will not be able to record it using this Recorder. See Copyright on page 8 for more details.

### Recording from a Digital Camcorder

You can record from a digital camcorder connected to the DV IN port on the front panel of this Recorder.

Using the Recorder's remote, you can control both the Camcorder and this Recorder.

Before recording, make sure that the audio input for the DV IN port is set up (see page 26).

#### Tips

- The source signal must be DVC-SD format.
- Some camcorders cannot be controlled using this Recorder's remote.
- If you connect a second DVD Recorder using a DV cable, you cannot control the second DVD from this one.
- You can't control this unit remotely from a component connected to the DV IN port.
- You can't record date and time information from a DV cassette.

- 1 Make sure your Digital Camcorder is connected to the front panel DV IN port. See page 17.**
- 2 Check that the DV audio input is as you require.**  
You can choose between Audio 1 (original audio) and Audio 2 (over-dubbed audio).
  - DV Input is set from the DV Rec Audio in sub-menu of the Setup menu. See DV Rec Audio on page 26 for more information.
- 3 Press AV/FUNC. repeatedly to select the DV input.**  
DV appears in the display window and on the TV screen.
- 4 Find the place on the Camcorder tape that you want to the recording to start from.**  
For best results, pause playback at the point from which you want to record.
  - Depending on your Camcorder, you can use this Recorder's remote to control the Camcorder using the STOP, PLAY and PAUSE functions.
- 5 Press REC (●) once to start recording.**

- Recording is automatically stopped if the Recorder detects no signal.
- You can pause or stop the recording by pressing PAUSE/STEP (||) or STOP (■). You cannot control the Camcorder from this Remote Control during recording.
- In Video mode, the final frame of the recording may remain displayed on screen for a while after recording stops.
- For timer recording to work properly on this Recorder, the Digital Camcorder must also be switched on and be operating.

## Recording from an External Input Source (Continued)

### What is DV?

Using DV, also known as i.LINK, you can connect a DV-equipped Camcorder to this Recorder using a single DV cable for input and output of audio, video, data and control signals.

The i.LINK interface is also known as IEEE 1394-1995. "i.LINK" and the "i.LINK" logo are trademarks.

- This Recorder is only compatible with DV-format (DVC-SD) camcorders. **Digital Satellite Tuners, PCs, and D-VHS Video Recorders are not compatible.**
- You cannot connect more than one DV camcorder at a time to this Recorder.
- You cannot control this Recorder from external equipment connected via the DV IN port (including two DVD Recorders).
- It may not be possible to always control the connected Camcorder via the DV IN port.
- Digital Camcorders can usually record audio as stereo 16-bit/48kHz, or twin stereo tracks of 12-bit/32kHz. This Recorder can only record one stereo audio track. Set DV Rec Audio to Audio 1 or Audio 2 as required (see page 26).
- Audio input to the DV IN port should be 32 or 48kHz (not 44.1kHz).
- Picture disturbance on the recording may occur if the source component pauses playback or plays an unrecorded section of tape, or if the power fails in the source component, or the DV cable becomes disconnected.
- Although DV Rec Audio is set to Audio 2 and Audio 2 signal is not present, DV Rec Audio will be reset to Audio 1 automatically.

### DV-Related Messages

You may see the following messages appear on your TV screen when using the DV IN port.

#### **Not connected to Camcorder**

The Camcorder is not connected properly, or the Camcorder is switched off.

#### **Too many devices connected**

The DV IN port on this Recorder supports connection to just one Camcorder.

#### **Check the tape**

There is no cassette loaded into the connected equipment.

#### **Uncontrollable device**

This Recorder cannot control the Camcorder.

#### **Updating Information**

Camcorder is updating information for DV.

#### **Camera mode**

Camcorder is set to camera mode.

### Troubleshooting

If you can't get a picture and/or audio through the DV IN port, check the bullet points:

- Make sure the DV cable is properly connected.
- Try switching off the connected equipment then switching back on.
- Try switching the audio input.

#### **Note :**

Depending on the connected Camcorder, you may not be able to control it using the Remote Control supplied with this Recorder.

## Title List and Chapter List Menu

### Using the Title List-Original menu **VR**

The Title List-Original is where you build and edit your Playlist, and where you can delete titles and make other changes to the Original content of the disc. You can also play individual titles directly from the Title List-Original menu.

The Recorder must be in Stop mode in order to edit using the Title List-Original.

#### 1 Press MENU/LIST to display the Title List-Original menu.

- Use the ▲ / ▼ buttons to display the previous/next page if there are more than 6 titles.
- To exit the Title List-Original menu, press RETURN (↵).



#### 2 To view Title List-Original options, select the title you want then press ENTER/MEMORY.

Title List-Original options appears on the left side of the menu.

#### 3 Use ▲ / ▼ to select an option then press ENTER/MEMORY to confirm.

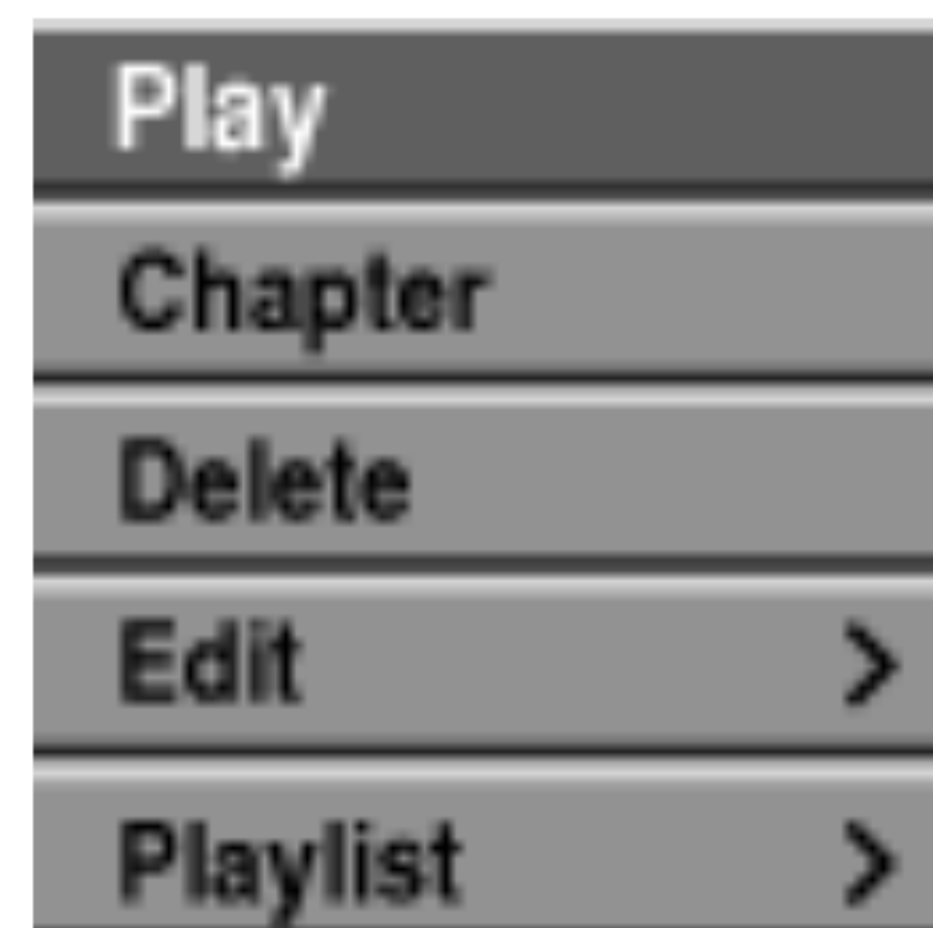

**Play:** Starts playback for the selected title.

**Chapter:** Moves to Chapter List-Original menu of the title. (refer to right on this page)

**Delete:** Deletes the title. (page 50)

**Edit:** Selects Edit options.

- **Title Name:** Edits the title name. (page 51)
- **Delete Parts:** Deletes a part of the Title. (page 50)

**Playlist:** Adds the title to the Playlist. (page 49)

#### 4 Press RETURN (↵) repeatedly to exit the Title List-Original menu.

#### Tip

Press DISPLAY to show more detailed title information for selected title.

### Using the Chapter List-Original menu **VR**

#### 1 Press MENU/LIST to display Title List-Original menu.

#### 2 Use ▲ ▼ ◀ ▶ to choose the title you want to view the Chapter List-Original menu then press ENTER/MEMORY.

Title List-Original options appears on the left side of the menu.

#### 3 Use ▲ / ▼ to select 'Chapter' from Title List-Original options then press ENTER/MEMORY.

Chapter List-Original menu appears on the TV screen.

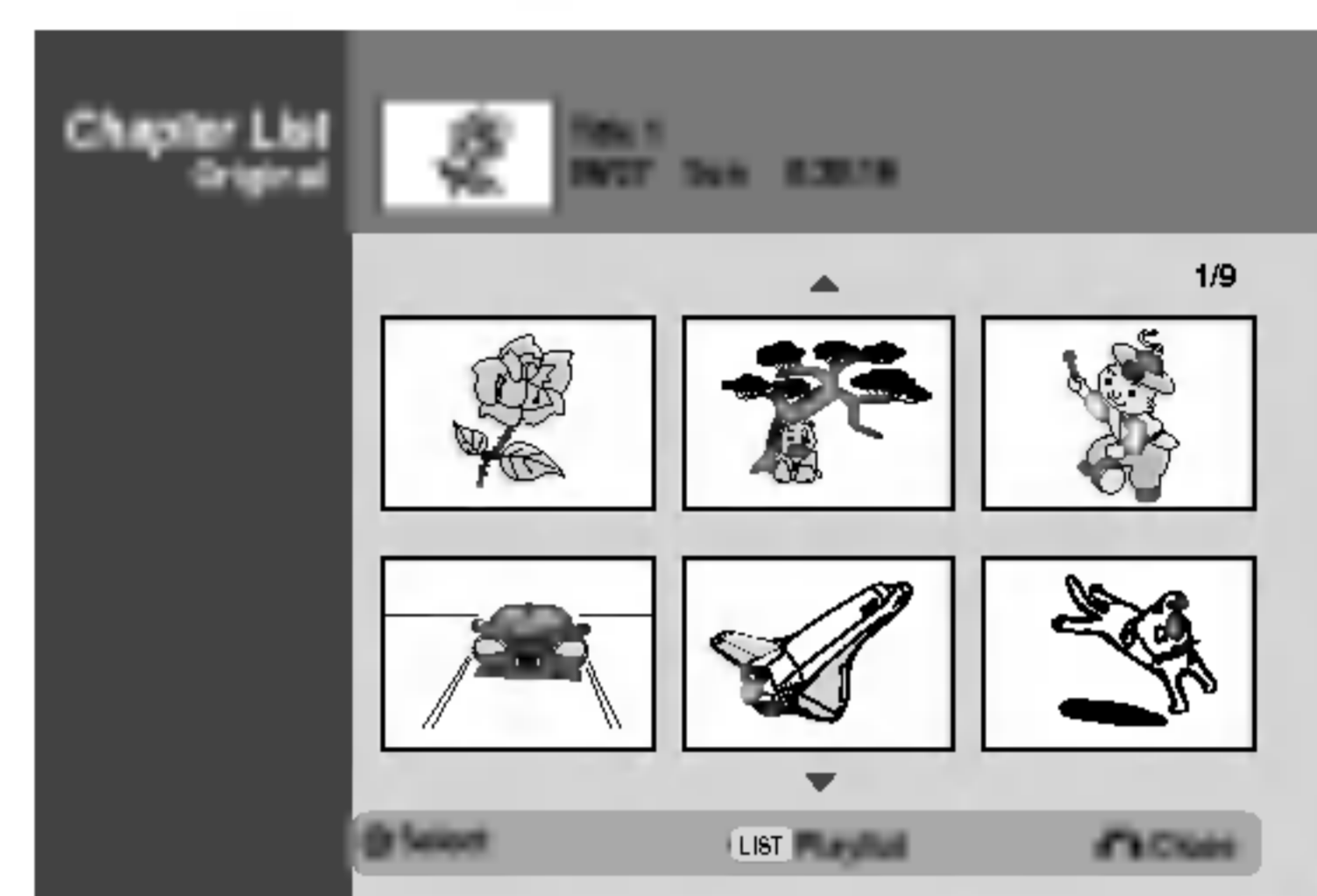

#### 4 To view Chapter List-Original options, select the chapter you want then press ENTER/MEMORY.

Chapter List-Original options appears on the left side of the menu.

#### 5 Use ▲ / ▼ to select an option then press ENTER/MEMORY to confirm.

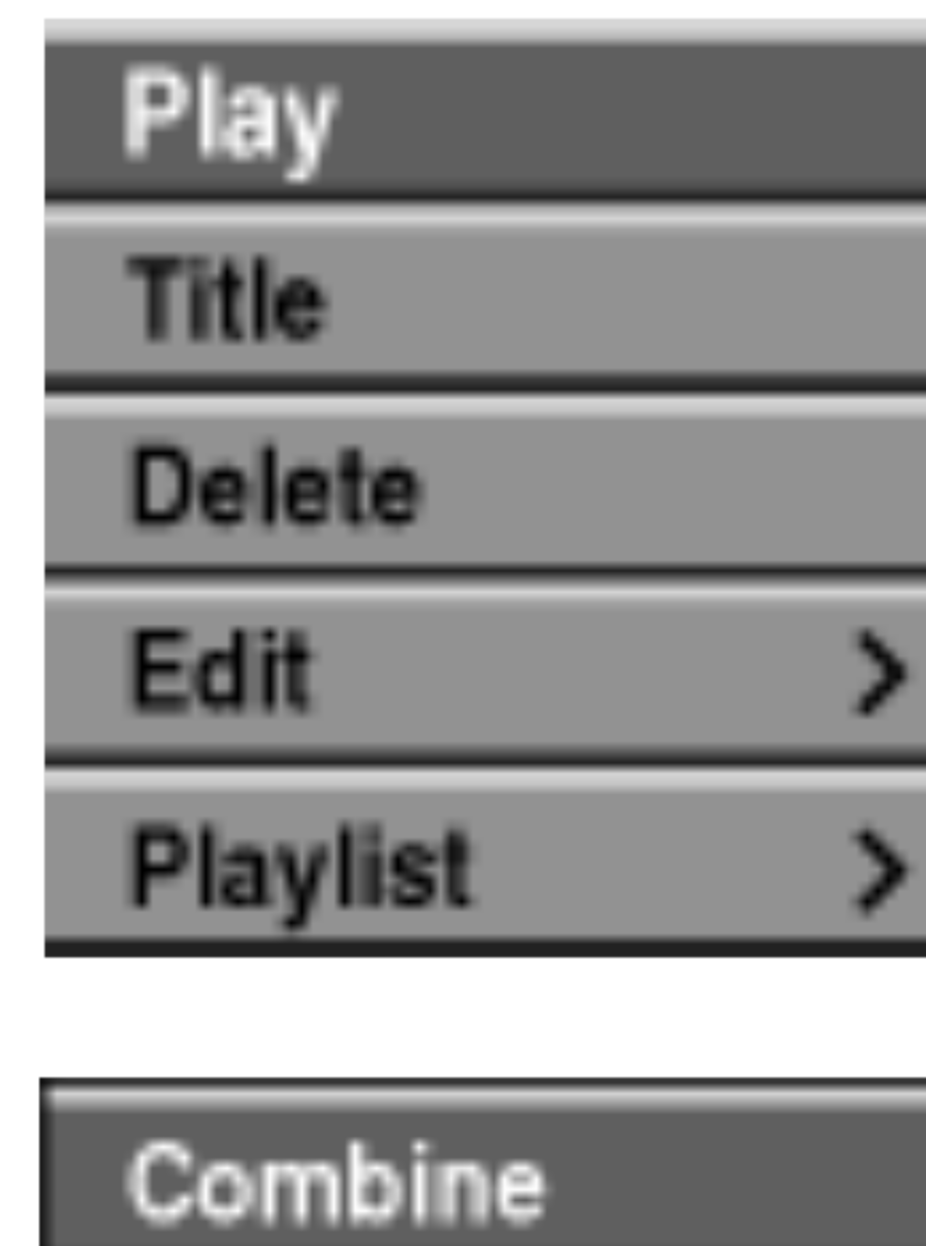

**Play:** Starts playback of the selected chapter.

**Title:** Moves to Title List-Original menu of the chapter. (refer to left on this page)

**Delete:** Deletes the chapter. (page 50)

**Edit:** Selects Edit options.

- **Combine:** Combines two chapters into one. (page 51)

**Playlist:** Adds the chapter to the Playlist. (page 49)

#### 6 Press RETURN (↵) repeatedly to exit Chapter List-Original menu.

## Title List and Chapter List Menu (Continued)

### Using the Title List-Playlist Menu **VR**

**1** Press MENU/LIST repeatedly to display the Title List-Playlist menu.

- Use the ▲ / ▼ buttons to display the previous/next page if there are more than 6 titles.
- To exit the Title List-Playlist, press RETURN (↵).

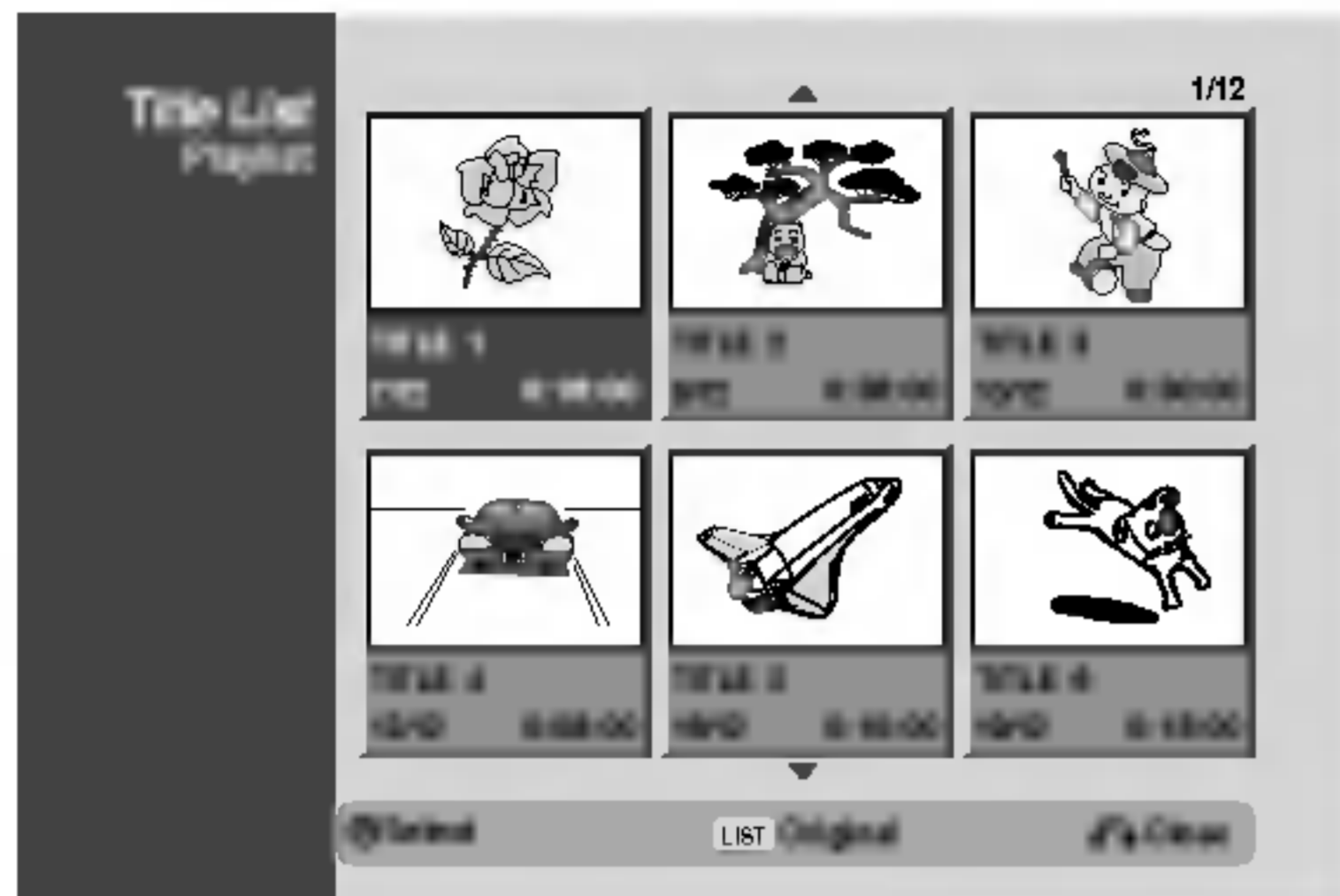

**2** To view Title List-Playlist options, select the title you want then press ENTER/MEMORY.

Title List-Playlist options appears on the left side of the menu.

**3** Use ▲ / ▼ to select an option then press ENTER/MEMORY to confirm.

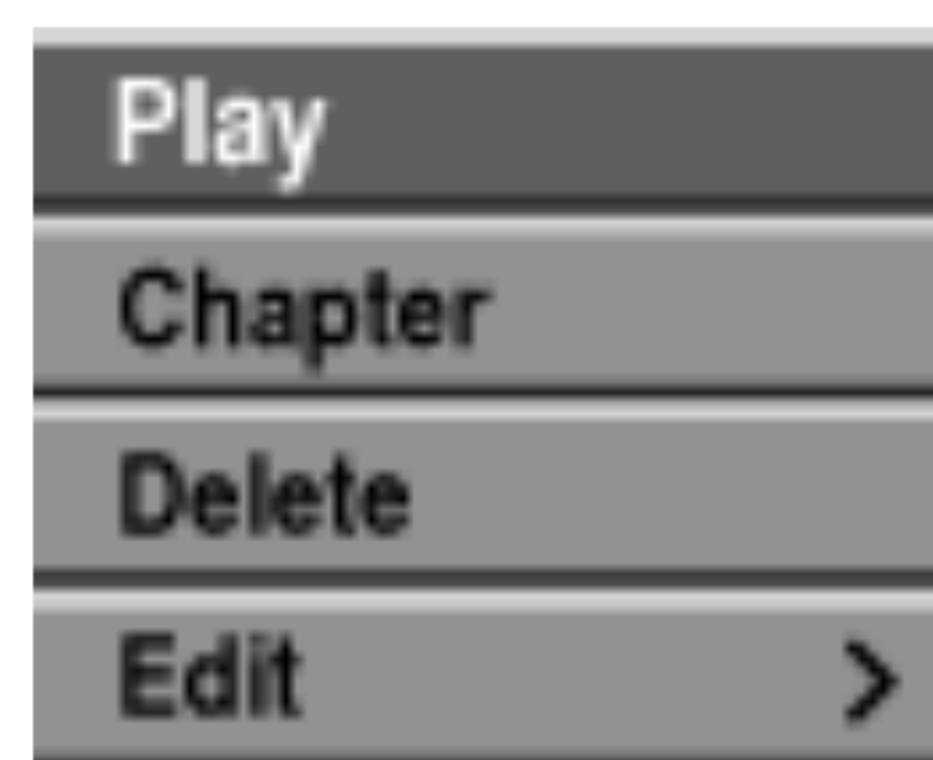

**Play:** Starts playback the selected title.

**Chapter:** Moves to Chapter List-Playlist menu of the title. (refer to right on this page)

**Delete:** Deletes the title from the Title List-Playlist menu. (page 50)

**Edit:** Selects Edit options.

- **Title Name:** Edits the title name. (page 51)
- **Delete Part:** Deletes a part of the Title. (page 50)

**4** Press RETURN (↵) repeatedly to exit Title List-Playlist menu.

#### Tip

Press DISPLAY to display more detailed title information for selected title.

### Using the Chapter List-Playlist Menu **VR**

**1** Press MENU/LIST repeatedly to display the Title List-Playlist menu.

**2** Use ▲ ▼ ◀ ▶ to choose the title you want to view Chapter List-Playlist menu then press ENTER/MEMORY.

Title List-Playlist options appears on the left side of the menu.

**3** Use ▲ / ▼ to select 'Chapter' from Title List-Playlist options then press ENTER/MEMORY.

Chapter List-Playlist menu appears on the TV screen.

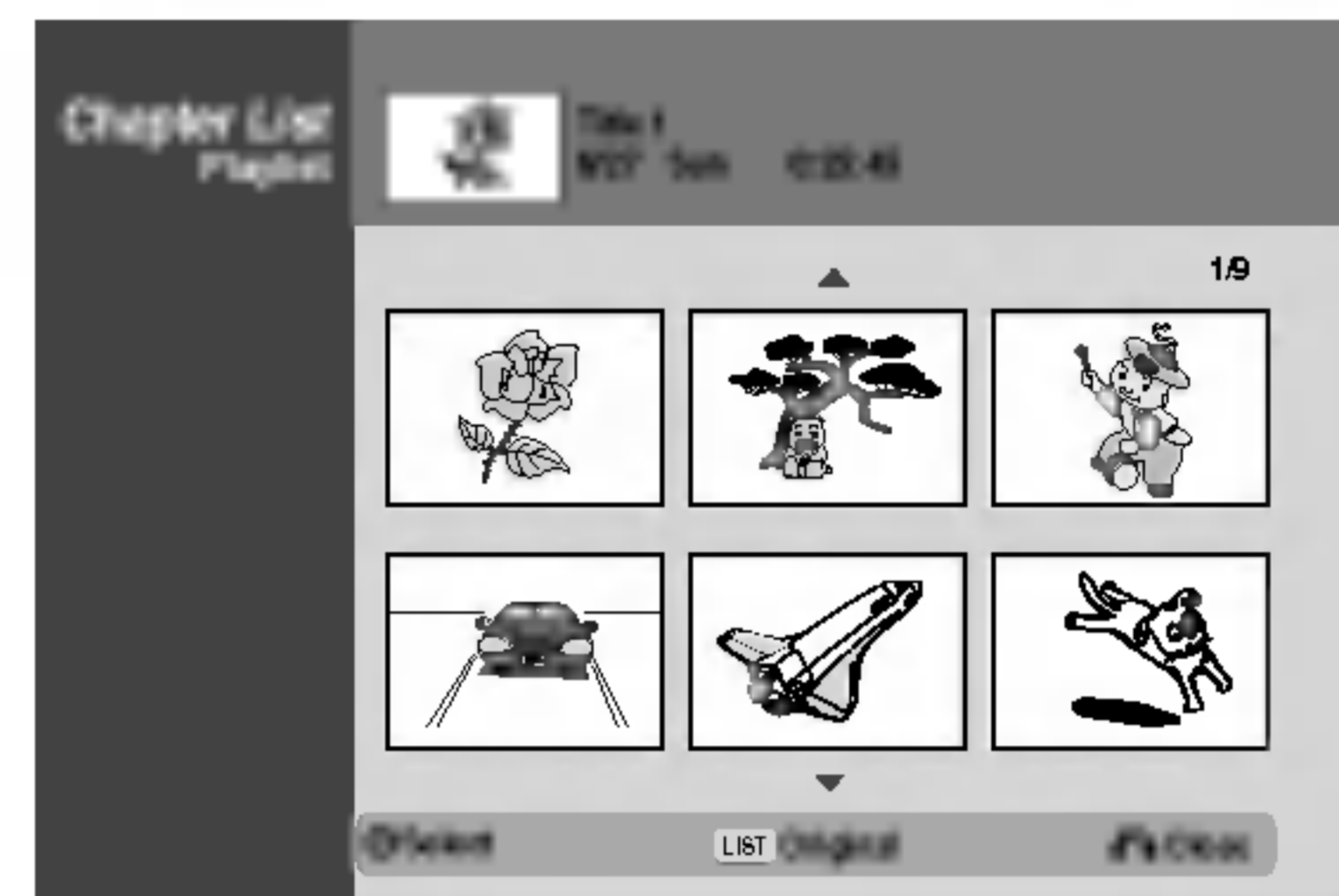

**4** To view Chapter List-Playlist options, select the chapter you want then press ENTER/MEMORY.

Chapter List-Playlist options appears on the left side of the menu.

**5** Use ▲ / ▼ to select an option then press ENTER/MEMORY to confirm.

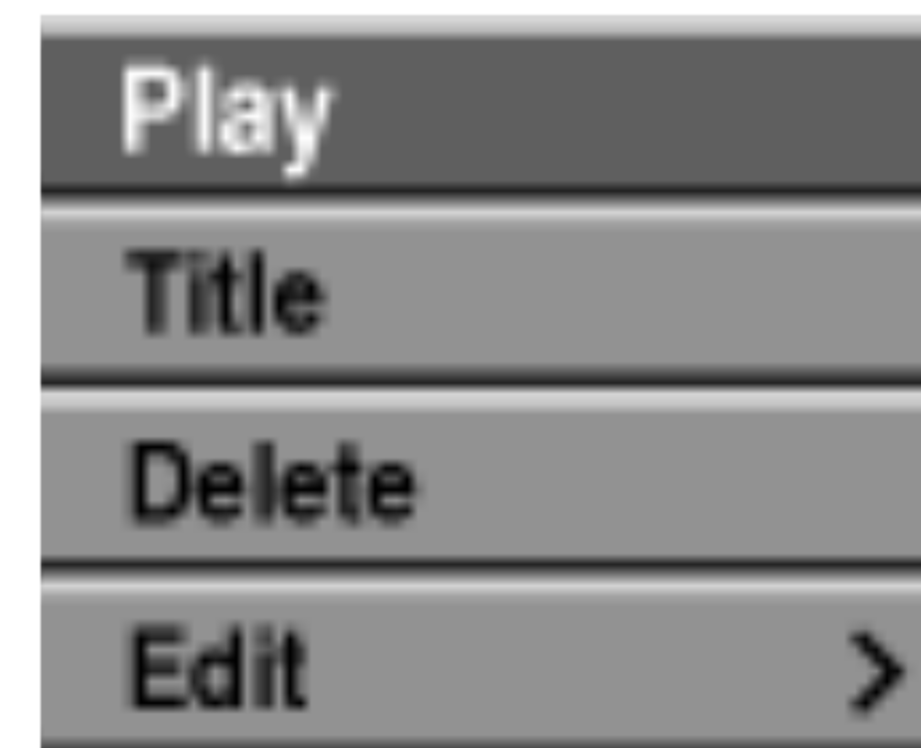

**Play:** Starts playback of the selected chapter.

**Title:** Moves to Title List-Playlist menu of the chapter. (refer to left on this page)

**Delete:** Deletes the chapter from the Chapter List-Playlist menu. (page 50)

**Edit:** Selects Edit options.

- **Combine:** Combines two chapters into one. (page 51)

- **Move:** Moves a chapter of Chapter List-Playlist menu to a position on the menu. (page 52)

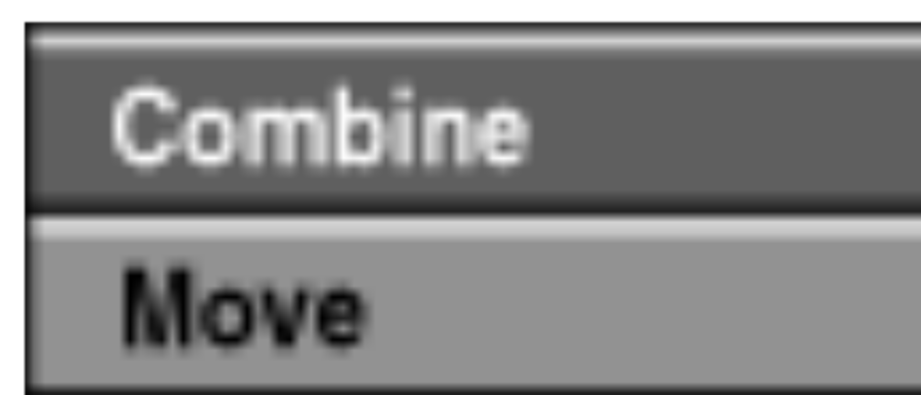

**6** Press RETURN (↵) repeatedly to exit Chapter List-Playlist menu.

## Title List and Chapter List Menu (Continued)

### Using the Title List menu **Video**

From the Title List display you can play, name, and delete titles.

After a Video mode disc is finalized, the Title List screen changes its appearance and all you can do is select titles to play.

#### 1 Press MENU/LIST to display the Title List.

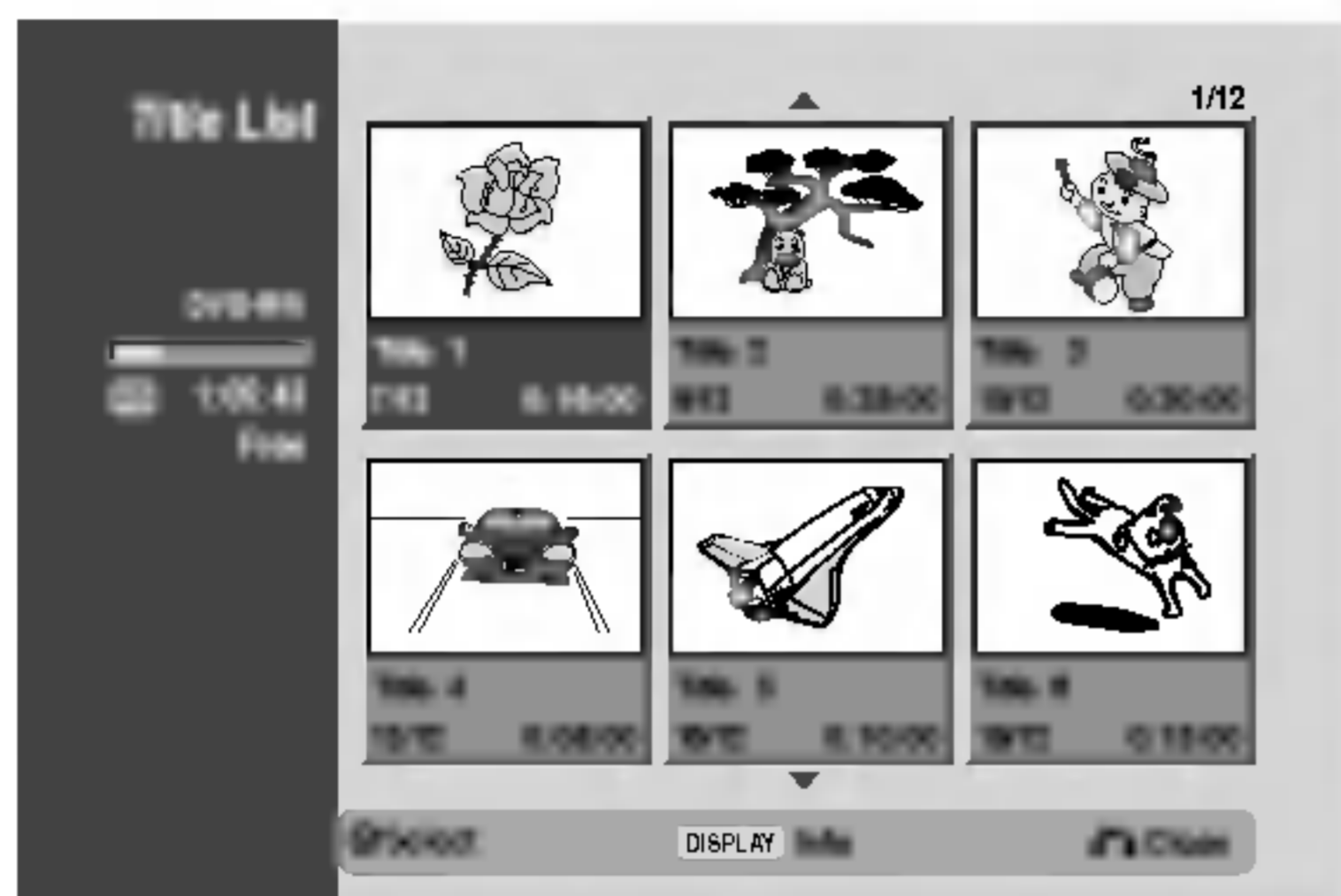

#### 2 Use ▲ / ▼ to choose a title then press ENTER/MEMORY.

Title List options appears on the left side of the Title List display.

#### 3 Use ▲ / ▼ to select an option then press ENTER/MEMORY to confirm.

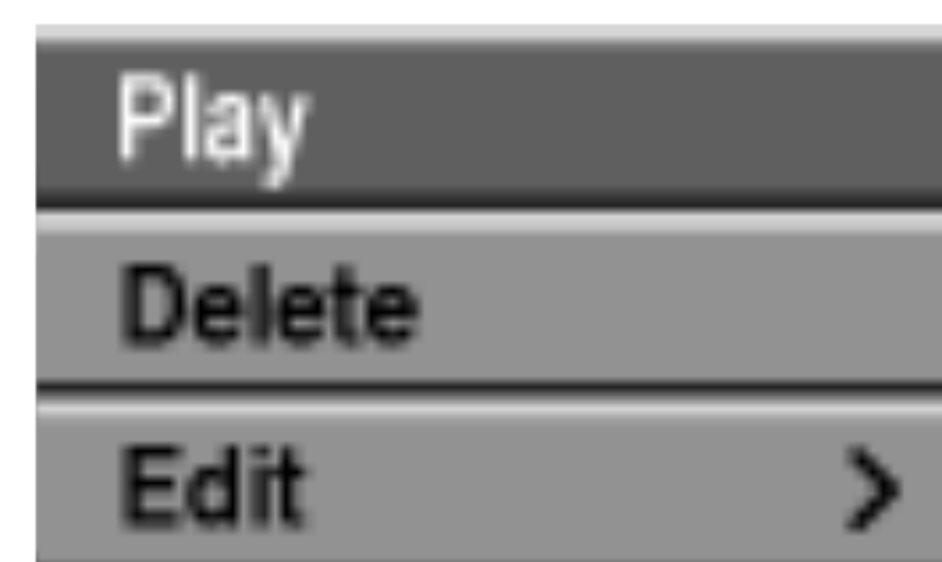

**Play:** Starts playback of the selected title.

**Delete:** Deletes the title from the Title List.

**Edit:** Selects Edit options.

- **Title Name:** Edits the title name. (page 51)

#### 4 Press RETURN (↵) repeatedly to exit Title List.

#### Tip

Press DISPLAY to display more detailed title information for selected title.

### Deleting a Title **Video**

Before a disc is finalized, you can delete titles recorded on the disc.

#### ⚠ Caution

- If you delete a title from a DVD-R disc, the title will disappear from the Title List, but the available recording time will not increase.
- When deleting a title from a DVD-RW disc, the remaining time available for recording will only increase if it is the last title on the disc.

#### 1 Press MENU/LIST to display Title List

#### 2 Use ▲ ▼ ◀ ▶ to choose a title you want to delete then press ENTER/MEMORY.

Title List options appears on the left side of the Title List menu.

#### 3 Use ▲ / ▼ to select 'Delete' then press ENTER/MEMORY to confirm.

The confirm message for deleting will appear.

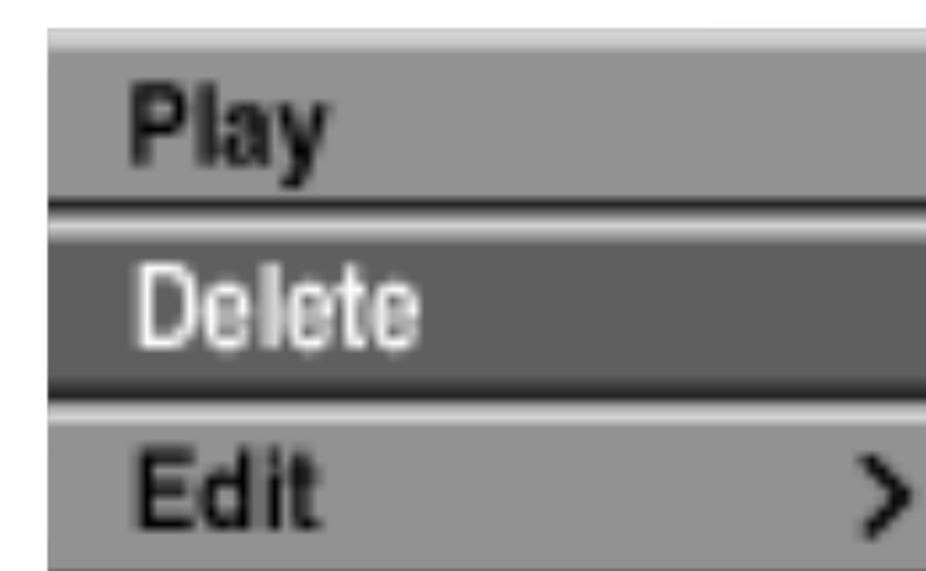

#### 4 Use ◀ / ▶ to select 'Yes' then press ENTER/MEMORY.

The selected chapter or title is deleted.

After pressing ENTER/MEMORY, the new, updated menu is displayed.

#### 5 Repeat steps 2-3 to delete additional titles from the Title List.

#### 6 Press RETURN (↵) repeatedly to remove the Title List display.

## Title List and Chapter List Menu (Continued)

### Using the Title List menu **+RW**

The Title List is where you can see the all recorded titles, and where you can delete titles and make other changes to the Original content of the disc. You can also play titles directly from the Title List menu. The Recorder must be in Stop mode in order to edit using the Title List menu.

#### 1 Press MENU/LIST to display the Title List menu.

- Use the ▲ / ▼ buttons to display the previous/ next page if there are more than 6 titles.
- To exit the Title List menu, press RETURN (↵).

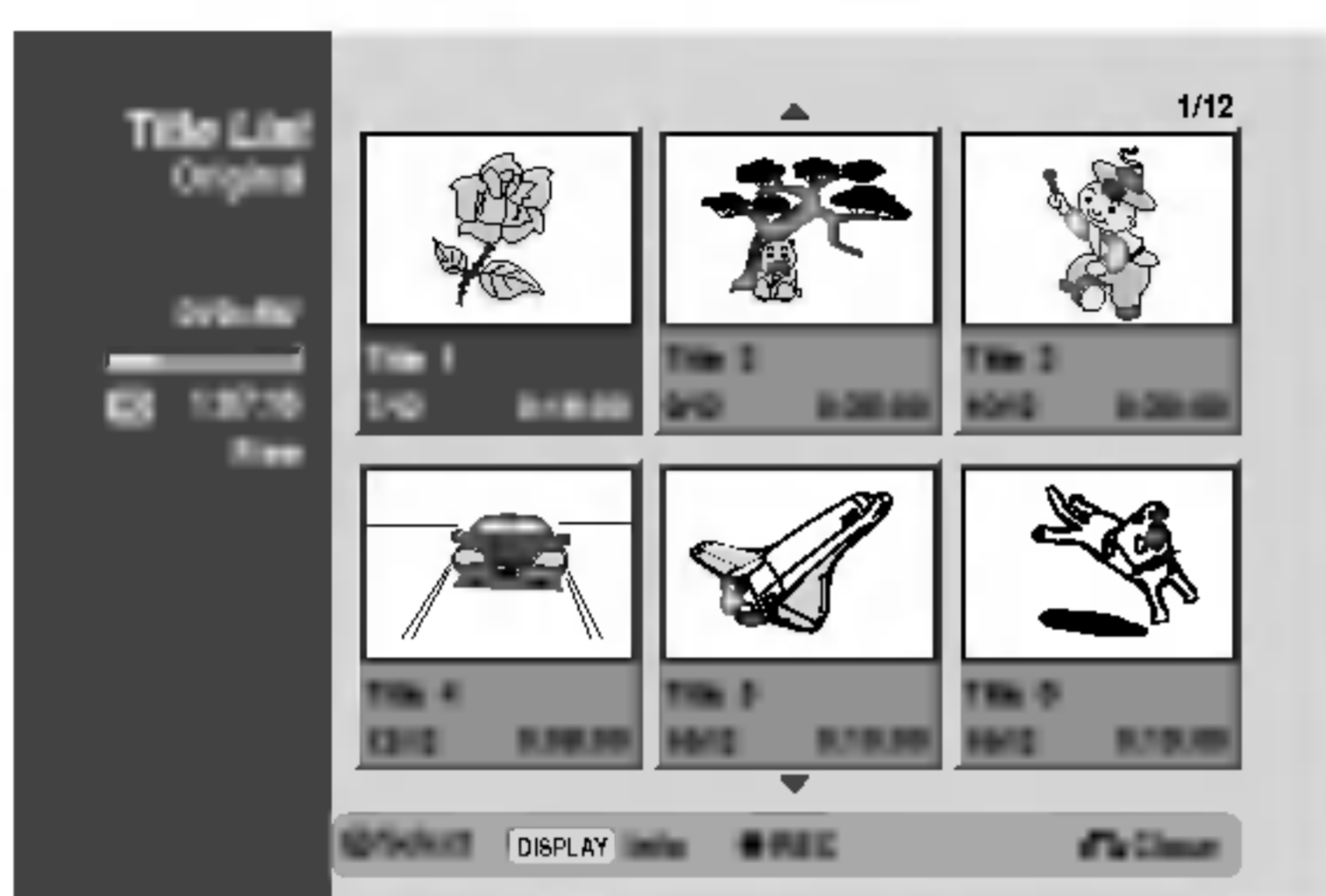

#### 2 To view Title List options, select the title you want then press ENTER/MEMORY.

Title List options appears on the left side of the menu.

#### 3 Use ▲ / ▼ to select an option then press ENTER/MEMORY to confirm.

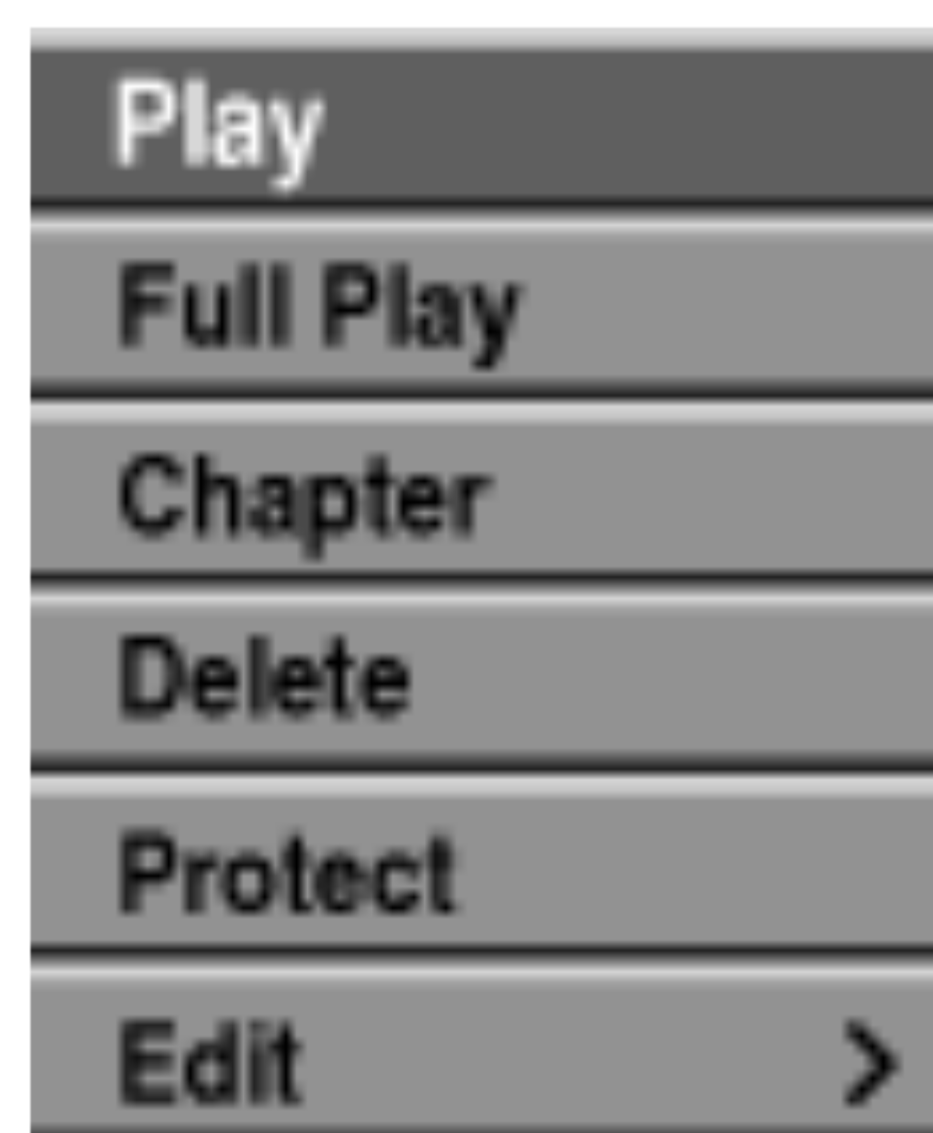

**Play:** Starts playback of the selected title except the hidden chapters.

**Full Play:** Starts playback of the selected title including the hidden chapters.

**Chapter:** Moves to Chapter List menu of the title. (refer to right on this page)

**Delete:** Deletes the title. (page 50)

**Protect:** Protects against accidental recording, editing, or deleting of the title. (page 52)

**Edit:** Selects Edit options.

- **Title Name:** Edits the title name. (page 51)
- **Divide:** Divides one title into two titles. (page 53)

#### 4 Press RETURN (↵) repeatedly to exit Title List menu.

### Tip

Press DISPLAY to display more detailed title information for selected title.

### ⚠ Caution

If you press REC (●) after the Title List menu appears, the selected title is erased then overwrite recording starts. (See page 54 for more details.)

### Using the Chapter List menu **+RW**

#### 1 Press MENU/LIST to display Title List menu.

#### 2 Use ▲ ▼ ◀ ▶ to choose the title you want to view Chapter List menu then press ENTER/MEMORY.

Title List options appears on the left side of the menu.

#### 3 Use ▲ / ▼ to select 'Chapter' from Title List options then press ENTER/MEMORY.

Chapter List menu appears on the TV screen.

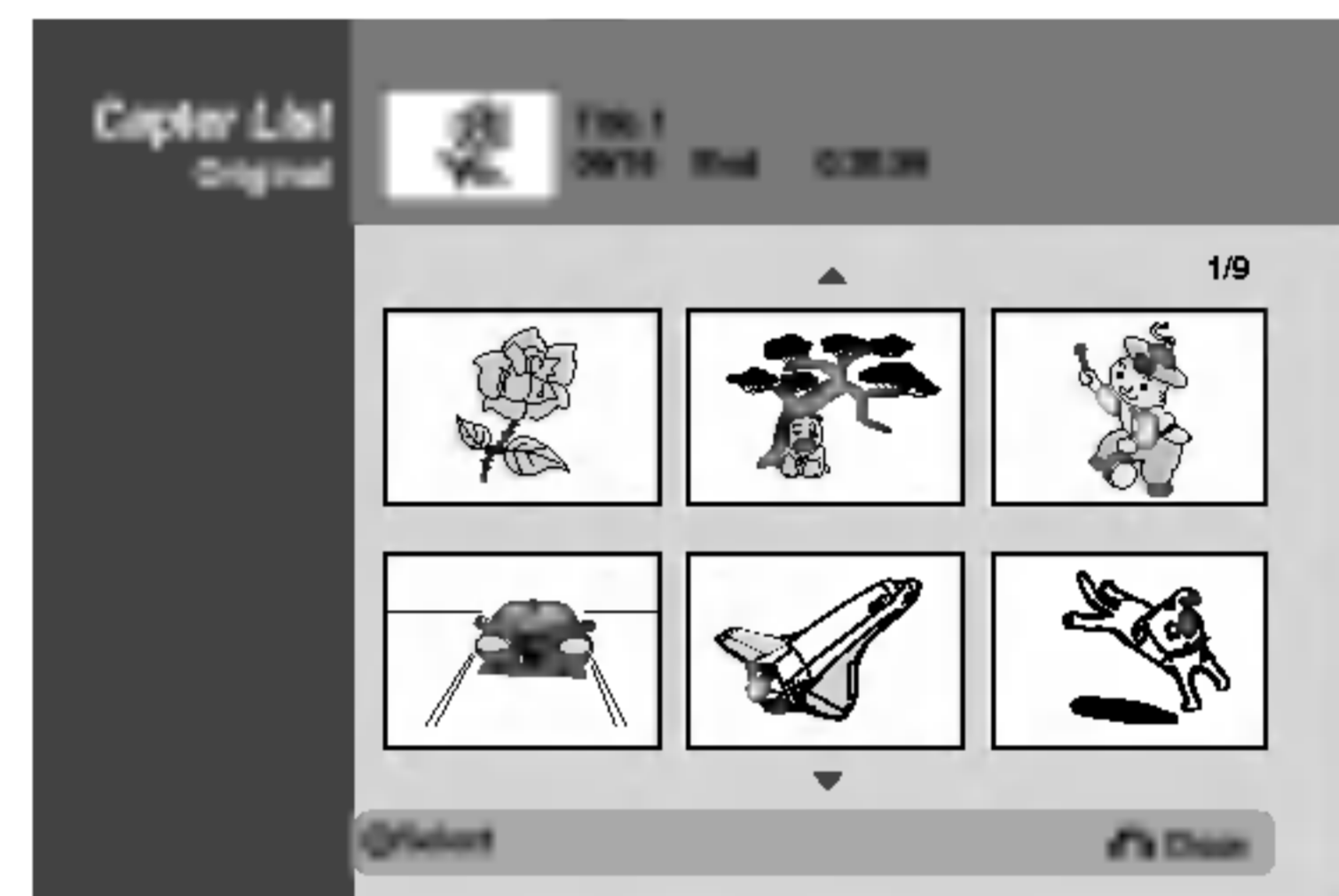

#### 4 To view Chapter List options, select the chapter you want then press ENTER/MEMORY.

Chapter List options appears on the left side of the menu.

#### 5 Use ▲ / ▼ to select an option then press ENTER/MEMORY to confirm.

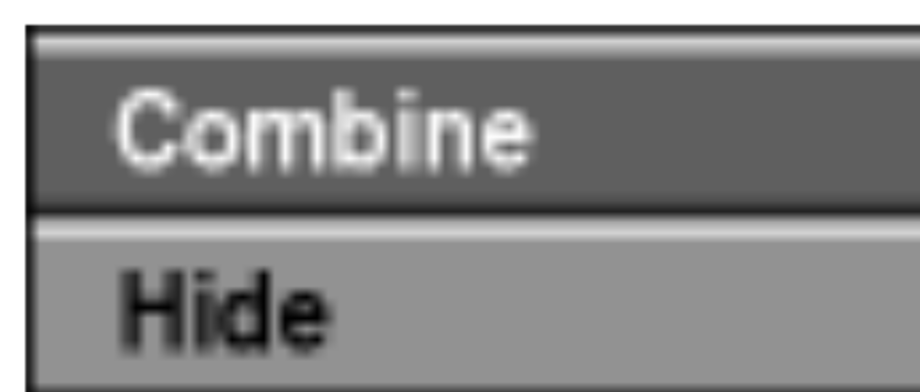

**Play:** Starts playback of the selected chapter.

**Title:** Moves to Title List menu of the chapter. (refer to left on this page)

**Edit:** Selects Edit options.

- **Combine:** Combines two chapters into one. (page 51)
- **Hide (Show):** Hides (or Shows) the selected chapter. (page 53)

#### 6 Press RETURN (↵) repeatedly to exit Chapter List menu.

## Title List and Chapter List Menu (Continued)

### Using the Title List menu **+R**

The Title List is where you can see the all recorded titles, and where you can delete titles and make other changes to the Original content of the disc. You can also play titles directly from the Title List menu. The Recorder must be in Stop mode in order to edit using the Title List menu.

#### 1 Press MENU/LIST to display the Title List menu.

- Use the ▲ / ▼ buttons to display the previous/ next page if there are more than 6 titles.
- To exit the Title List menu, press RETURN (↵).

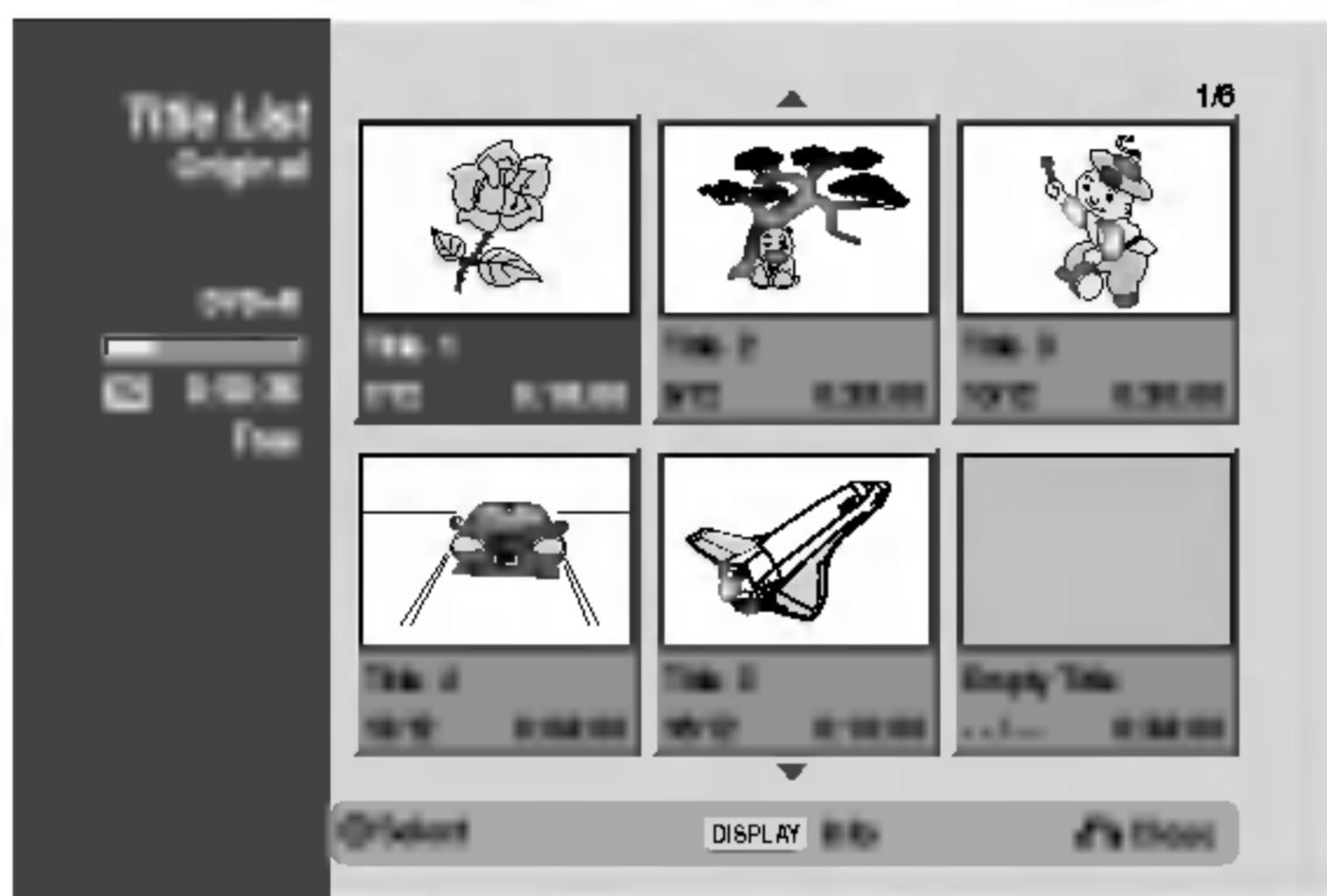

#### 2 To view Title List options, select the title you want then press ENTER/MEMORY.

Title List options appears on the left side of the Title List menu.

#### 3 Use ▲ / ▼ to select an option then press ENTER/MEMORY to confirm.

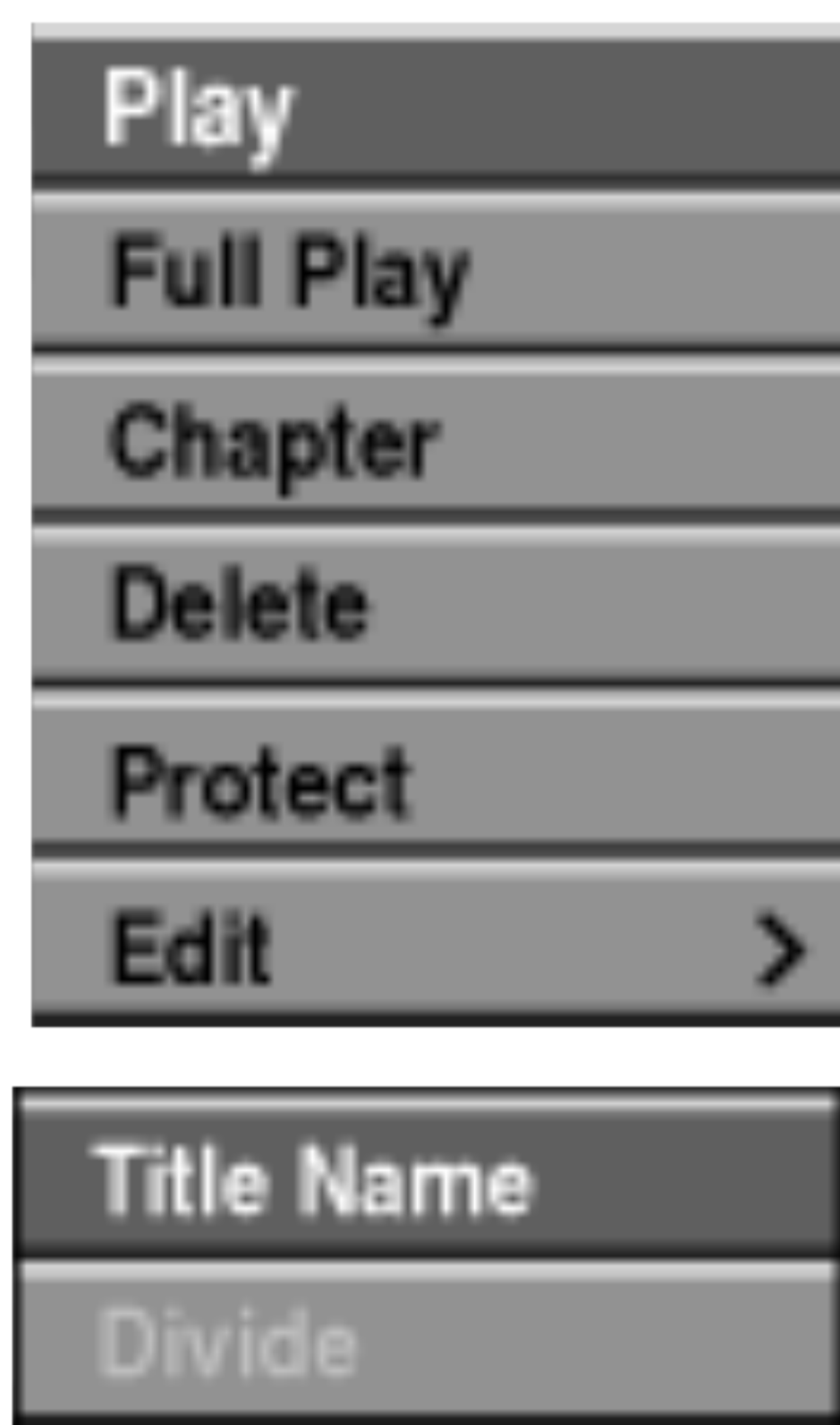

**Play:** Starts playback of the selected title except the hidden chapters.

**Full Play:** Starts playback of the selected title including the hidden chapters.

**Chapter:** Moves to Chapter List menu of the title. (refer to right on this page)

**Delete:** Deletes the title. (page 50)

**Protect:** Protects against accidental recording, editing, or deleting of the title. (page 52)

**Edit:** Selects Edit options.

- **Title Name:** Edits the title name. (page 51)
- **Divide:** Not available (DVD+RW disc only)

#### 4 Press RETURN (↵) repeatedly to exit Title List menu.

#### Tip

Press DISPLAY to display more detailed title information for selected title.

### Using the Chapter List menu **+R**

#### 1 Press MENU/LIST to display Title List menu.

#### 2 Use ▲ ▼ ◀ ▶ to choose the title you want to view the Chapter List menu then press ENTER/MEMORY.

Title List options appear on the left side of the menu.

#### 3 Use ▲ / ▼ to select 'Chapter' from the Title List options then press ENTER/MEMORY.

Chapter List menu appears on the TV screen.



#### 4 To view Chapter List options, select the chapter you want then press ENTER/MEMORY.

Chapter List options appear on the left side of the menu.

#### 5 Use ▲ / ▼ to select an option then press ENTER/MEMORY to confirm.



**Play:** Starts playback of the selected chapter.

**Title:** Moves to the Title List menu of the chapter. (refer to left on this page)

**Edit:** Selects Edit options.

- **Combine:** Combines two chapters into one. (page 51)
- **Hide (Show):** Hides (or Shows) the selected chapter. (page 53)

#### 6 Press RETURN (↵) repeatedly to exit Chapter List menu.

## Title and Chapter Editing

Edits you make to the Original content change the actual content of the disc. For example, if you delete a title or chapter from the Original content (Title or Chapter), that title or chapter is deleted from the disc, freeing up extra recording time.

When you edit the Playlist, on the other hand, you are not changing the content of the disc. For example, when you delete a title from the Playlist, you are just telling the Recorder not to play that title; nothing is actually deleted from the disc.

### Titles, Chapters, and Parts

Titles in the disc's original content contain one or more chapters. When you insert a title into the Playlist, all the chapters within that title also appear. In other words, chapters in the Playlist behave exactly as chapters on a DVD-Video disc do. Parts are sections of Original or Playlist titles. From the Original and Playlist menu, you can add or delete parts. Adding a chapter or title to the Playlist creates a new title made up of a section (ie., chapter) of an Original title. Deleting a part removes part of a title from the Original or Playlist menu.

#### **Caution**

- When editing using the Delete, Add, or Move functions, the start and end frames may not be exactly as set in the starting and ending points display.
- During Playlist playback, you may notice a momentary pause between edits. This is not a malfunction.

### Adding Chapter Markers



You can put a chapter marker anywhere in a Playlist or Original title during playback.

Once the chapter is marked, you can use the Chapter Search feature, as well as delete, combine and move chapters in the Chapter List-Original or Chapter List-Playlist menu.

#### **Note :**

Chapter markers are inserted at regular intervals automatically. You can change this interval from the Initial Setup menu (see Auto Chapter on page 27).

**1** Play the title (Original or Playlist).

**2** At the point you want to start a new chapter, press **CHP ADD**.

- A chapter marker icon appears on the TV screen.
- You can also put chapter markers in while recording.

### Changing Title Thumbnails



Each title displayed in the Title List menu is represented by a thumbnail picture taken from the start of that title or chapter.

If you prefer, select a different still picture from within a title.

**1** Play the title (Original or Playlist).

**2** Press **THUMBNAIL** to make the currently displayed picture the one that appears in the Original or Playlist menu.

- The still picture that you choose appears in both the Original or Playlist menu.

#### **Tip**

You can also change the thumbnail picture of the title on the Chapter List-Original or Chapter List-Playlist menu. Select a chapter on the Chapter List-Original or Chapter List-Playlist menu, then press **THUMBNAIL**. The thumbnail picture of the title that includes the chapter is changed.

## Title and Chapter Editing (Continued)

### Making a New Playlist **VR**

Use this function to add an Original title or chapter to the Playlist. When you do this, the whole title is put into the Playlist (you can delete bits you don't need later — see Deleting a Title/Chapter on page 50).

The title appears in the Playlist complete with the chapter markers that appeared on the Original. However, if you add more chapter markers to the Original later, these are not automatically copied over into the Playlist title.

You can add up to 999 chapters to one disc. If you only want to add a chapter of a title, use the Adding a title/chapter to the Playlist on this page.

#### 1 Press MENU/LIST repeatedly to display Title List-Original menu.

If you want to display the Chapter List-Original menu, refer to "Using the Chapter List-Original menu" on page 43.

#### 2 Choose a title or chapter on the Original menu to put into the Playlist, then press ENTER/MEMORY.

Original (Title or Chapter) options appear on the left side of the Original menu.

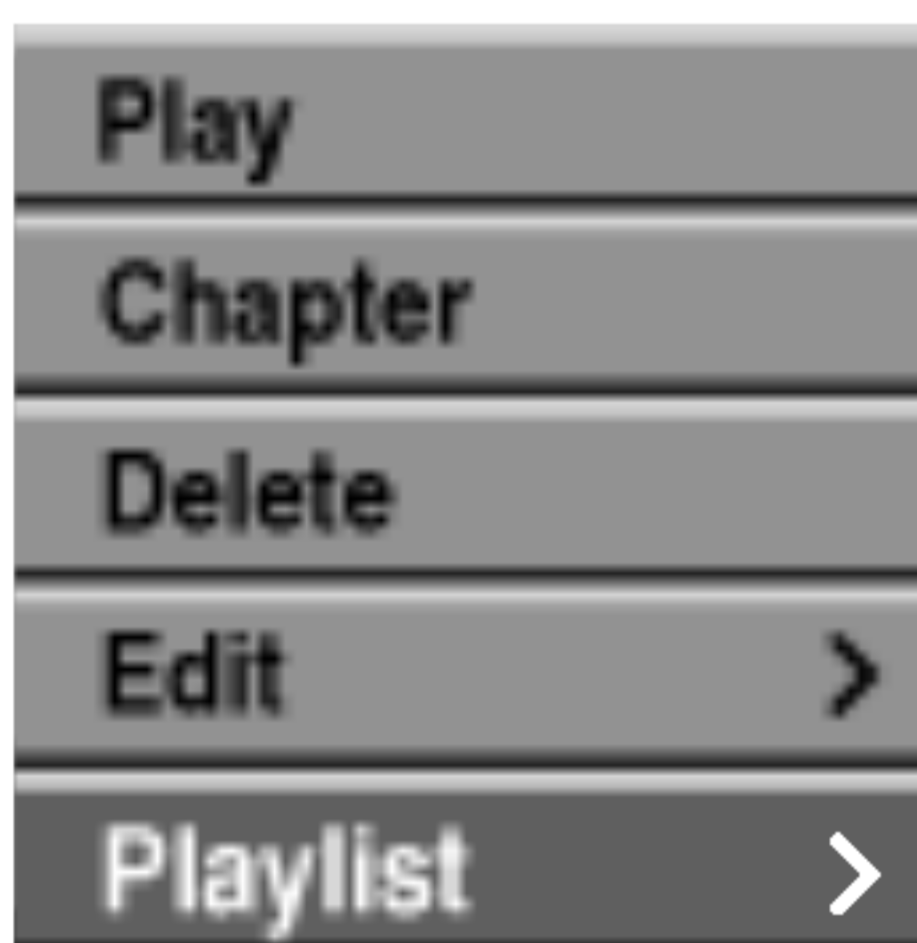

Title List-Original

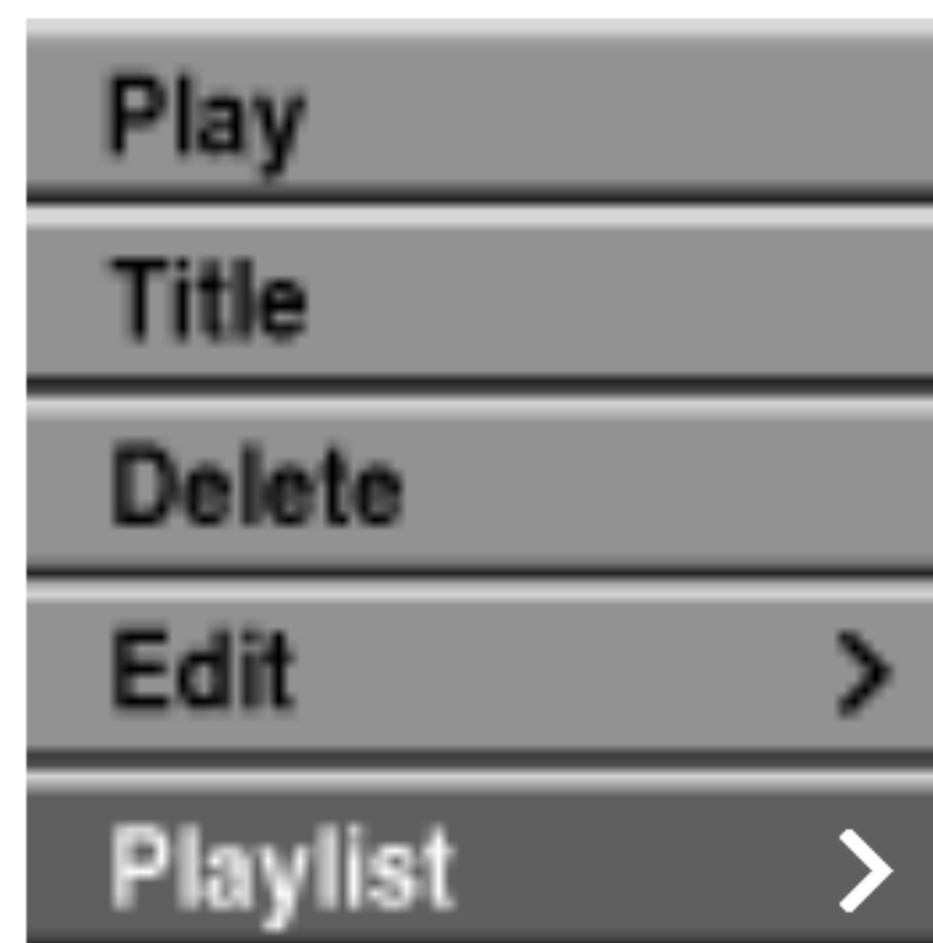

Chapter List-Original

#### 3 Use ▲ / ▼ to select 'Playlist' from Original options then press ENTER/MEMORY.



#### 4 Select 'New Playlist' then press ENTER/MEMORY.

The new title appears in the updated Playlist. All chapters of the title are added to the Playlist.

### Adding Additional Title/Chapters to the Playlist **VR**

You can add an Original title or chapter to a Playlist title even if it is already registered.

#### 1 Press MENU/LIST repeatedly to display Title List-Original menu.

If you want to show the Chapter List-Original menu, refer to "Using the Chapter List-Original" on page 43.

#### 2 Choose an Original title or chapter to put into the Playlist, then press ENTER/MEMORY.

Original menu options appear on the left side of the screen.

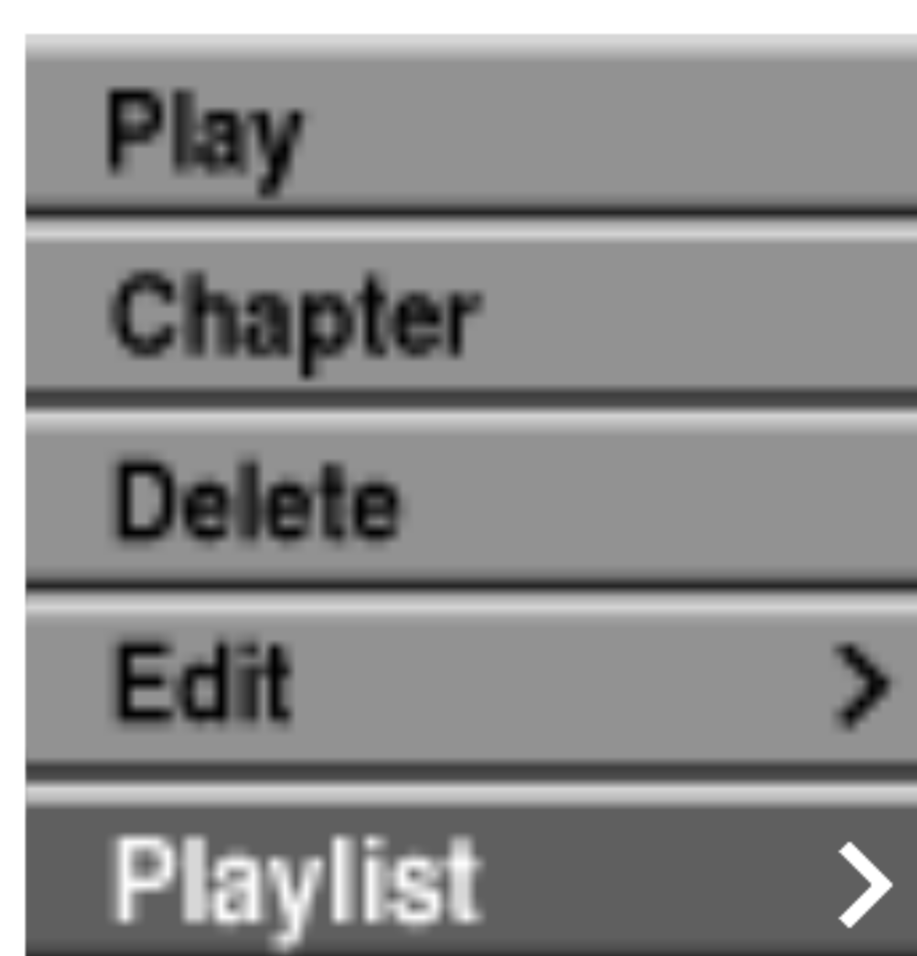

Title List-Original

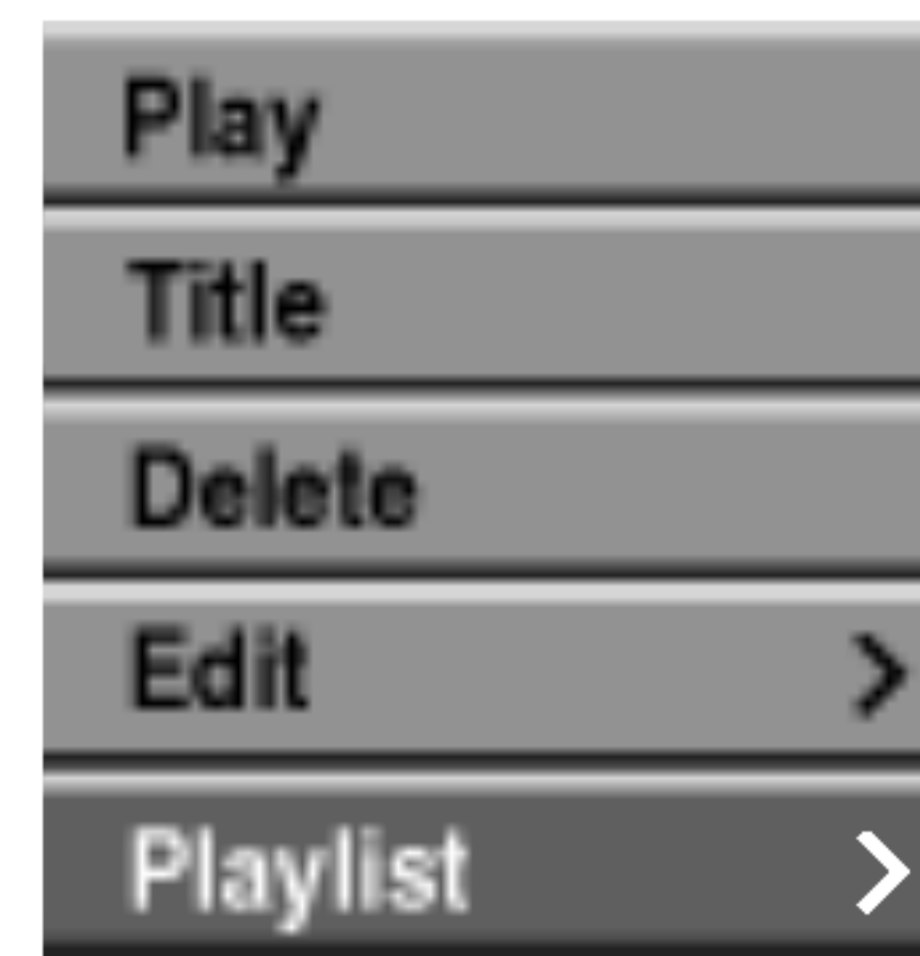

Chapter List-Original

#### 3 Use ▲ / ▼ to select 'Playlist' from Original menu options then press ENTER/MEMORY.



#### 4 Choose a Title List-Playlist that is already registered to insert a title or chapter, then press ENTER/MEMORY.

The title or chapter appears in the updated Playlist menu.

#### 5 Repeat steps 1-4 to add additional title or chapter on the Playlist.

#### 6 Press RETURN (↵) to exit, or MENU/LIST to go back to the Title List-Original menu.

## Title and Chapter Editing (Continued)

### Deleting a Title/Chapter

**VR** **+RW** **+R**

If you erase a title or chapter from the Playlist menu on DVD-RW discs formatted in VR mode, you only remove it from the Playlist; the title/chapter remains in the Original menu.

If you choose to delete a title or chapter from Title List or Chapter List menu, the title or chapter is actually deleted from the disc and the remaining time available for recording increases. Titles/chapters deleted from the Original are also removed from the Playlist.

#### Note :

It may not be possible to delete chapters that are less than 5 seconds long.

**1** On the Title List or Chapter List menu, use **▲ ▼ ◀ ▶** to choose a chapter or title you want to delete then press **ENTER/MEMORY**.  
Options appears on the left side of the screen.

**2** Select 'Delete' from the options on the menu.

e.g., If you select "Delete" on the Title List-Original menu.

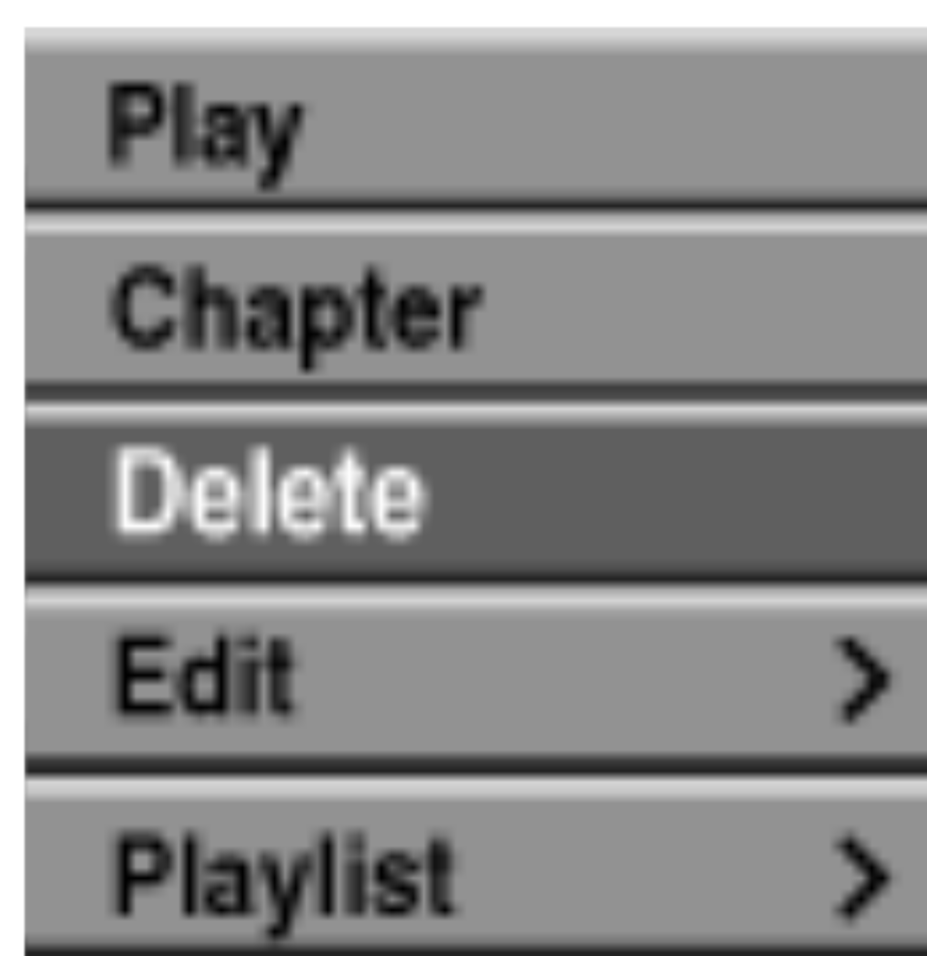

**3** Press **ENTER/MEMORY** to confirm.  
The confirm message for deleting will appear.

**4** Use **◀ / ▶** to select 'Yes' then press **ENTER/MEMORY**.  
The selected chapter or title is deleted.  
After pressing **ENTER/MEMORY**, the new, updated menu is displayed.

**5** Repeat steps 1 - 4 to continue to delete from the menu.

**6** Press **RETURN (↵)** repeatedly to exit the menu.

#### Notes :

- When DVD+RW recording, the deleted title's name is changed to 'Deleted Title'.
- If more than two titles are repeatedly deleted, the titles are combined into one.
- When you are deleting a title or chapter, only the last one on DVD+R/RW increases remaining recording time.

### Deleting a Part **VR**

You can delete a part which you do not want in the title.

**1** Press **MENU/LIST** repeatedly to display Title List-Original or Title List-Playlist menu.

**2** Use **▲ ▼ ◀ ▶** to choose a title you want to delete then press **ENTER/MEMORY**.  
The options appears on the left side of the menu.

**3** Select 'Delete Part' from the options on the menu.  
e.g., If you select "Delete Part" on the Title List-Original menu.



**4** Press **ENTER/MEMORY**.  
Title Edit (Delete Part) menu appears on the TV screen.  
'Start Point' icon is highlighted.



**5** Starts playback and use pause step, search and slow-motion to find the starting point.

**6** Press **ENTER/MEMORY** at the starting point of the section you want to delete.  
'End Point' icon is highlighted.  
The part is indicated on the Progress Bar.

**7** Use pause step, search and slow-motion to find the ending point.

**8** Press **ENTER/MEMORY** at the ending point of the section you want to delete.  
You can cancel the selected point, use **▲ / ▼** to select 'Cancel' icon then press **ENTER/MEMORY**.

**9** After you finish editing, select the 'Done' icon then press **ENTER/MEMORY**.  
The confirm message for deleting will appear.

**10** Use **◀ / ▶** to select 'Yes' then press **ENTER/MEMORY**.  
The selected part is deleted from the title and Title List-Original or Title List-Playlist menu appears.

## Title and Chapter Editing (Continued)

### Naming a Title **VR** **Video** **+RW** **+R**

You can name titles independently.

**1** On the Title List menu, use **▲▼◀▶** to choose the title you want to name then press **ENTER/MEMORY**.

Options appears on the left side of the menu.

**2** Use **▲/▼** to select the 'Title Name' option then press **ENTER/MEMORY**.

Keyboard menu appears.

e.g., If you select "Title Name" on the Title List-Original menu.



**3** Enter/memory a name for the title. Use **▲▼◀▶** to select a character then press **ENTER/MEMORY** to confirm your selection. Refer to step 5 as shown on page 28 (Disc Label).

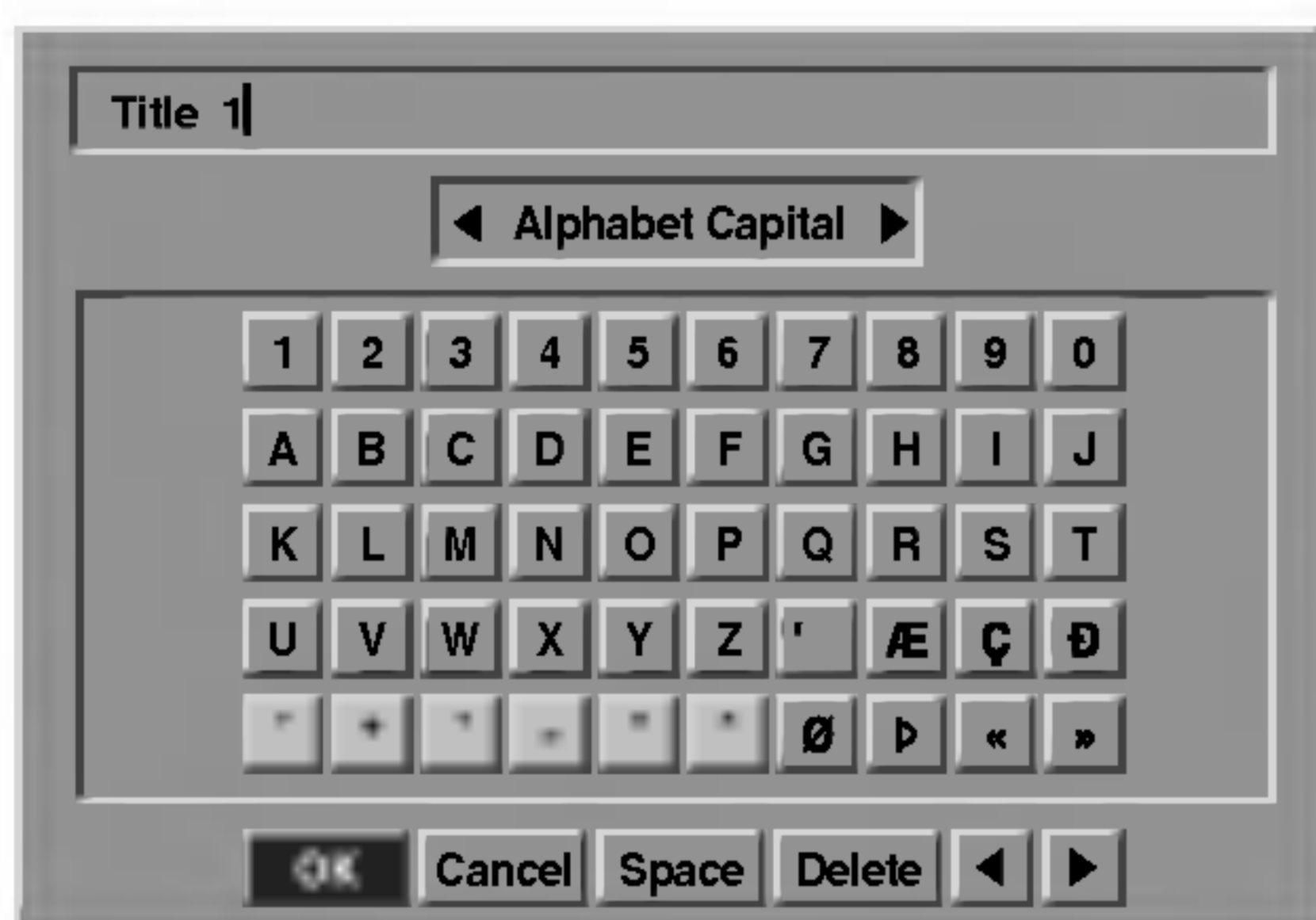

**4** Choose **OK** then press **ENTER/MEMORY** to save the name and return to the previous menu display.

**5** Press **RETURN** (↵) repeatedly to exit the menu.

#### Notes :

- Names can be up to 21 characters long.
- For discs formatted on a different DVD Recorder, you will see only a limited character set.
- When recording on DVD-R, DVD+R or DVD+RW discs, the entered name is displayed on the DVD player only after finalization.

### Combining Two Chapters Into One **VR** **+RW** **+R**

Use this function to combine two adjacent Playlist or Original chapters into one.

#### Note :

This function is not available if there is only one chapter within the title.

**1** On the Chapter List menu, select the second chapter of the two chapters you want to combine then press **ENTER/MEMORY**.

Chapter List options appear on the left side of the menu.

**2** Use **▲ / ▼** to select 'Combine'.

The combine indicator appears between the two chapters you want to combine.

e.g., If you select "Combine" on the Chapter List-Playlist menu.

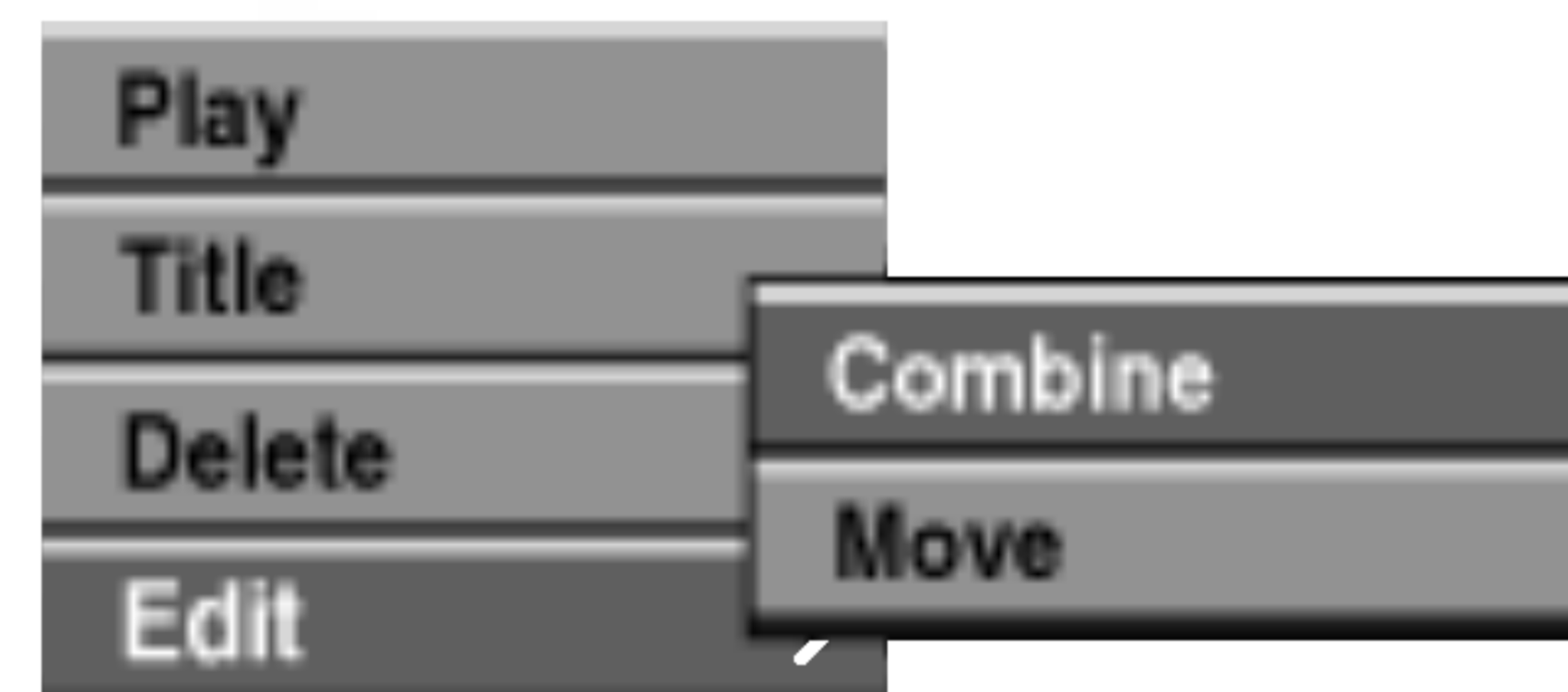

**3** Press **ENTER/MEMORY** to confirm. After pressing **ENTER/MEMORY**, the updated menu is displayed.

## Title and Chapter Editing (Continued)

### Moving a Playlist Chapter **VR**

Use this function to re-arrange the playing order of the Playlist chapters on the Title List-Playlist menu.

**1** Press MENU/LIST repeatedly to display Title List-Playlist menu.

To display the Chapter List-Playlist menu, refer to "Using the Chapter List-Playlist" on page 44.

**Note :**

This function is not available if there is only one chapter.

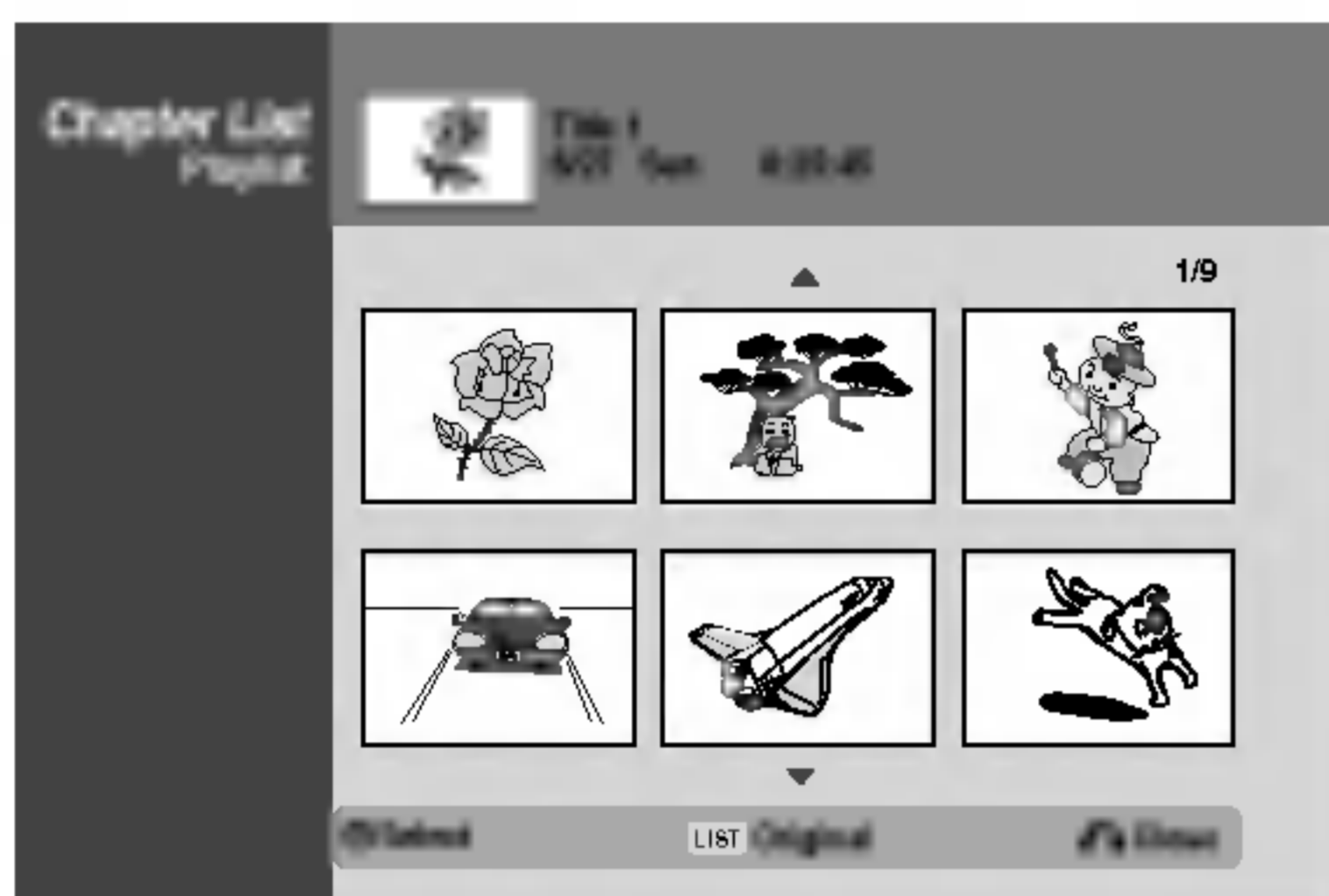

**2** Select a chapter from the Chapter List-Playlist menu.

**3** Press ENTER/MEMORY.

Chapter List-Playlist options appear on the left side of the menu.

**4** Use ▲ / ▼ to select 'Move' from Playlist options then press ENTER/MEMORY.



**5** Use ▲ ▼ ◀ ▶ to choose the place you want to move the chapter to then press ENTER/MEMORY.

After pressing ENTER/MEMORY, updated menu is displayed.

### Protect a Title **+RW** **+R**

Use this function to protect against accidental recording, editing or deleting of the title.

**1** Press MENU/LIST to display the Title List menu.

**2** Use ▲ ▼ ◀ ▶ to choose a title you want to protect then press ENTER/MEMORY.

Options appear on the left side of the screen.

**3** Select 'Protect' from the options.

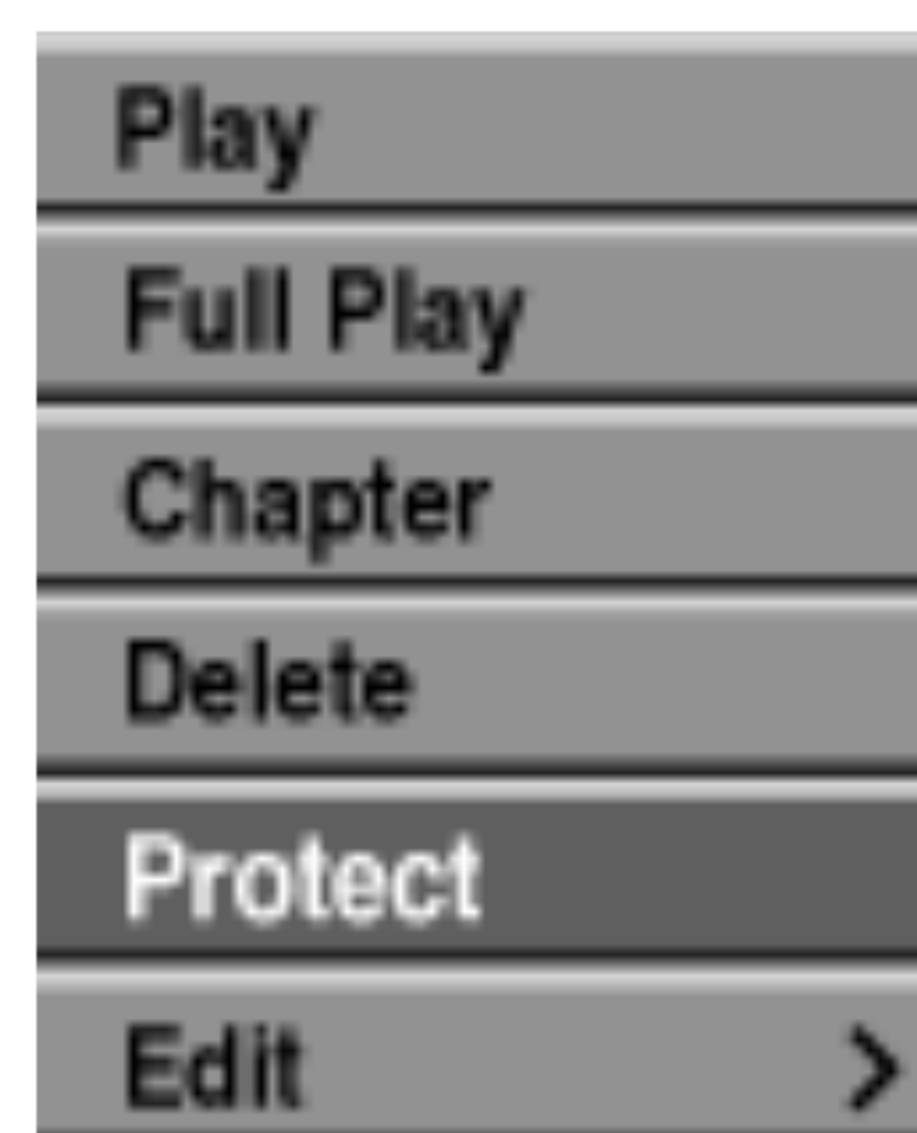

**4** Press ENTER/MEMORY to confirm.

The lock mark will appear on the title's thumbnail.

**Tip**

If you select a title that has already been protected on the Title List menu, you can 'unprotect' it by choosing "Protect" from the Title List menu options. After doing that, you can edit and delete the title.

## Title and Chapter Editing (Continued)

### Hide a Chapter **+RW** **+R**

Use this function to hide a chapter on Chapter List menu.

**1** On the Chapter List menu, use **▲ ▼ ◀ ▶** to choose a chapter you want to hide then press **ENTER/MEMORY**.

Options appear on the left side of the screen.

**2** Select "Hide" from the options.

e.g., If you select "Hide" on the Chapter List menu.



**3** Press **ENTER/MEMORY** to confirm. The chapter's thumbnail will dim.

#### Tip

If you select a chapter that is already dim on the Chapter List menu, you can 'show' it by choosing "Show" from the Chapter List menu options. After doing that, you are able to see the title.

### Dividing One Title Into Two **+RW**

Use this command to split a title up into two new titles.

**1** On the Title List menu, select a title you want to divide then press **ENTER/MEMORY**.

The menu options appears on the left side of the screen.

**2** Select 'Divide' from the Title List menu options.



**3** Press **ENTER/MEMORY** after the 'Divide' option is highlighted.

Title Edit (Divide) menu appears and goes into STOP mode.

Current picture

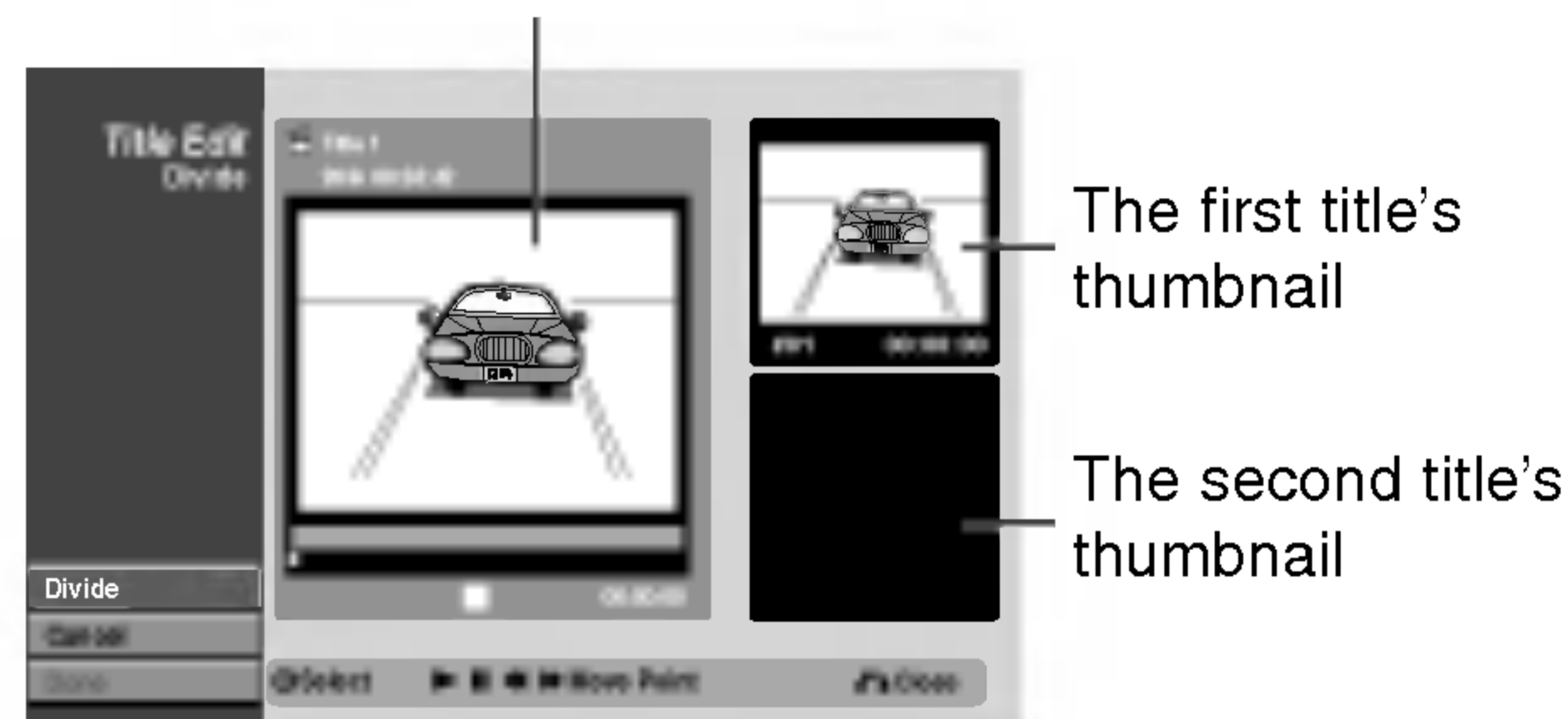

**4** Use pause step, search and slow-motion to find the point you want to divide the title.

**5** When the 'Divide' option is highlighted, press **ENTER/MEMORY** at that point.

You can remove the dividing point and exit the Title Edit (Divide) menu, use **▲ / ▼** to select 'Cancel' option then press **ENTER/MEMORY**. The division point is removed.

**6** Choose 'Done' option then press **ENTER/MEMORY** to fix the dividing point.

The title is divided into two new titles. It take up to 4 minutes to divide.

## Additional Information

### Overwriting Recording **+RW**

To overwrite a new video recording on a previously recorded title, follow these steps. This feature is not available for DVD+Rs, that always record at the end of the Disc.

- 1** Select input source you want to record (TV channel, AV1-4, DV).
- 2** Press MENU/LIST to display the Title List menu.

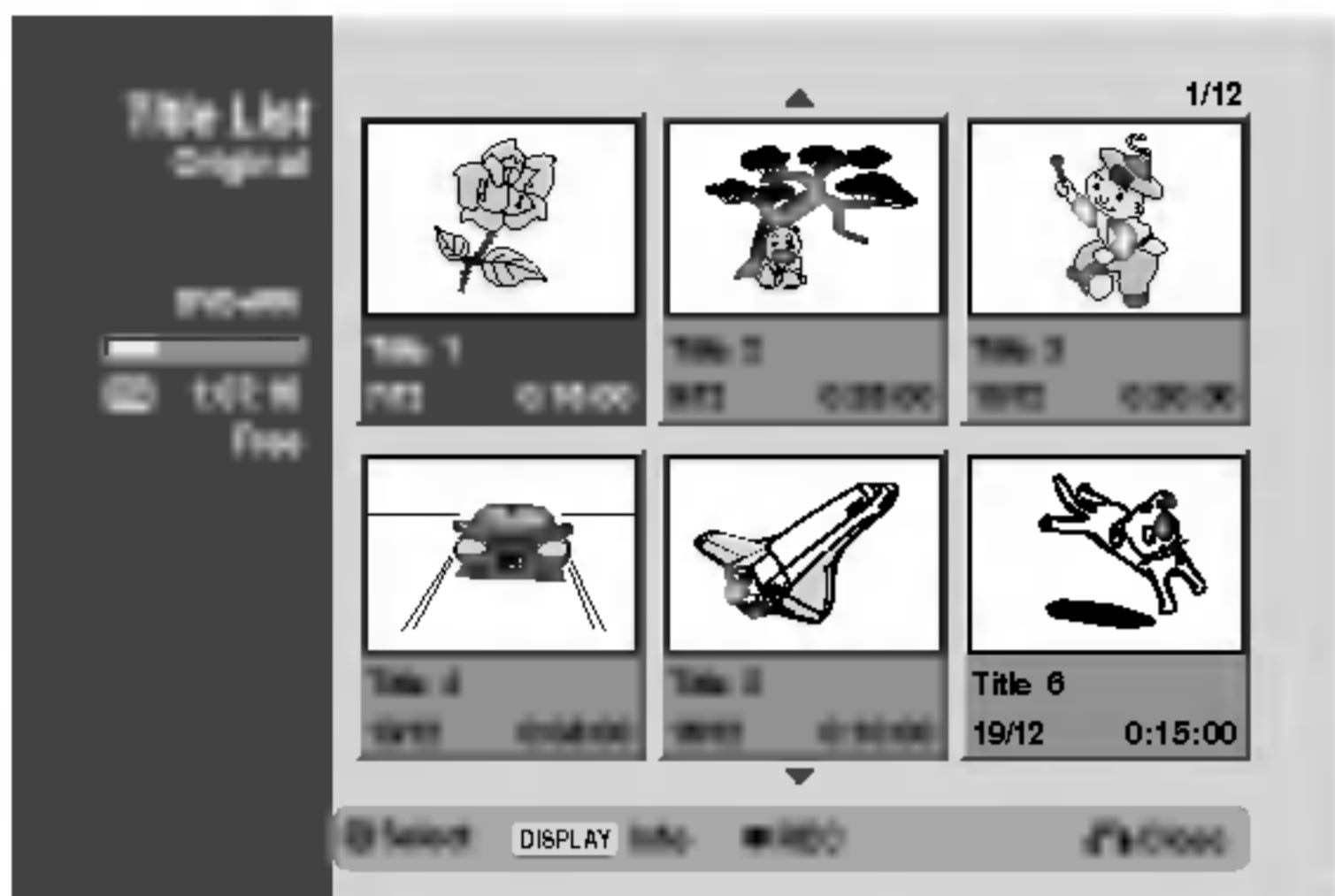

- 3** Use ▲▼◀▶ to choose a title you want to overwrite.
- 4** Press REC (●) to start overwrite recording. Overwrite recording starts from the start point of the title.
- 5** Press STOP (■) to stop the overwrite recording. The new title is created and updated menu is displayed.

#### Notes :

- This function is not available for a protected title.
- If the overwrite is longer than the recording length of the current title, the next title is overwritten. But if next title is protected, the overwriting stops at the starting point of the title.
- If the selected title's recording length is less than 10 seconds, the next title is overwritten. But if the next title is protected, overwriting stops.

### Viewing Title List menu displayed on other DVD Recorders or Players

**+RW** **+R**

You can view the Title List menu displayed on the other DVD player that is capable of playing DVD+RW or DVD+R discs.

- 1** Insert DVD+R or DVD+RW disc recorded already.
- 2** Press TITLE in Play mode. Title List menu will appear as shown below.

#### Tip

You can remove the Title List menu by pressing STOP (■).

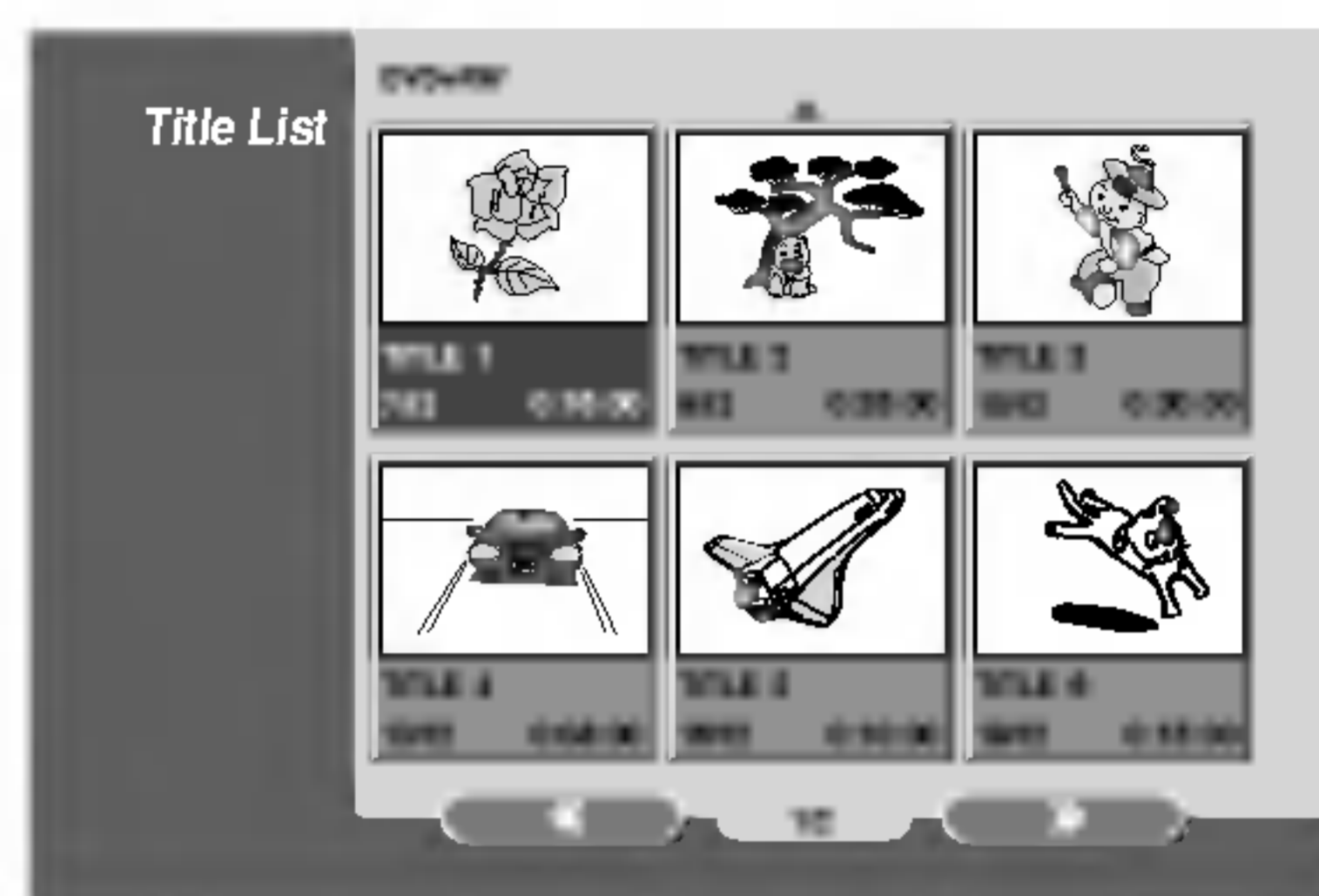

- 3** To play back a title, select the title you want then press ENTER/MEMORY or PLAY (▶).

### Playing Your Recordings on Other DVD Players (Finalizing a Disc)

Most regular DVD players can play finalized discs recorded in Video mode, finalized DVD+R or DVD+RWs. A small number of players can also play DVD-RW discs recorded in VR mode, finalized or not. Check the manual that came with the other player to check what formats of discs it will play.

Finalizing 'saves' the recordings and editings in place so that the disc can be played on a regular DVD player or computer equipped with a suitable DVD-ROM drive. Finalizing a Video mode disc creates a menu screen for navigating the disc. The menu can be accessed by pressing MENU/LIST or TITLE.

To finalize a disc, refer to "Finalize" on page 28.

#### Notes :

- Unfinalized DVD+RW is playable on regular DVD players.
- The edited contents of a DVD+RW disc is compatible on regular DVD players only after finalization.
- Any edited contents of the DVD+R disc are not compatible on regular DVD players. (Hide, chapter combine, added chapter mark, etc.)

## Language Code and Country Code List

### Language Codes

Use this list to input your desired language for the following initial settings:  
Disc Audio, Disc Subtitle, Disc Menu.

Language	Code	Language	Code	Language	Code	Language	Code
Abkhazian	6566	Fiji	7074	Lingala	7678	Singhalese	8373
Afar	6565	Finnish	7073	Lithuanian	7684	Slovak	8375
Afrikaans	6570	French	7082	Macedonian	7775	Slovenian	8376
Albanian	8381	Frisian	7089	Malagasy	7771	Somali	8379
Ameharic	6577	Galician	7176	Malay	7783	Spanish	6983
Arabic	6582	Georgian	7565	Malayalam	7776	Sudanese	8385
Armenian	7289	German	6869	Maltese	7784	Swahili	8387
Assamese	6583	Greek	6976	Maori	7773	Swedish	8386
Aymara	6588	Greenlandic	7576	Marathi	7782	Tagalog	8476
Azerbaijani	6590	Guarani	7178	Moldavian	7779	Tajik	8471
Bashkir	6665	Gujarati	7185	Mongolian	7778	Tamil	8465
Basque	6985	Hausa	7265	Nauru	7865	Tatar	8484
Bengali; Bangla	6678	Hebrew	7387	Nepali	7869	Telugu	8469
Bhutani	6890	Hindi	7273	Norwegian	7879	Thai	8472
Bihari	6672	Hungarian	7285	Oriya	7982	Tibetan	6679
Breton	6682	Icelandic	7383	Panjabi	8065	Tigrinya	8473
Bulgarian	6671	Indonesian	7378	Pashto, Pushto	8083	Tonga	8479
Burmese	7789	Interlingua	7365	Persian	7065	Turkish	8482
Byelorussian	6669	Irish	7165	Polish	8076	Turkmen	8475
Cambodian	7577	Italian	7384	Portuguese	8084	Twi	8487
Catalan	6765	Japanese	7465	Quechua	8185	Ukrainian	8575
Chinese	9072	Javanese	7487	Rhaeto-Romance	8277	Urdu	8582
Corsican	6779	Kannada	7578	Rumanian	8279	Uzbek	8590
Croatian	7282	Kashmiri	7583	Russian	8285	Vietnamese	8673
Czech	6783	Kazakh	7575	Samoan	8377	Volapük	8679
Danish	6865	Kirghiz	7589	Sanskrit	8365	Welsh	6789
Dutch	7876	Korean	7579	Scots Gaelic	7168	Wolof	8779
English	6978	Kurdish	7585	Serbian	8382	Xhosa	8872
Esperanto	6979	Laothian	7679	Serbo-Croatian	8372	Yiddish	7473
Estonian	6984	Latin	7665	Shona	8378	Yoruba	8979
Faroese	7079	Latvian, Lettish	7686	Sindhi	8368	Zulu	9085

### Country Codes

Choose a country code from this list.

Country	Code	Country	Code	Country	Code	Country	Code
Afghanistan	AF	Ethiopia	ET	Malaysia	MY	Saudi Arabia	SA
Argentina	AR	Fiji	FJ	Maldives	MV	Senegal	SN
Australia	AU	Finland	FI	Mexico	MX	Singapore	SG
Austria	AT	France	FR	Monaco	MC	Slovak Republic	SK
Belgium	BE	Germany	DE	Mongolia	MN	Slovenia	SI
Bhutan	BT	Great Britain	GB	Morocco	MA	South Africa	ZA
Bolivia	BO	Greece	GR	Nepal	NP	South Korea	KR
Brazil	BR	Greenland	GL	Netherlands	NL	Spain	ES
Cambodia	KH	Islands	HM	Netherlands Antilles	AN	Sri Lanka	LK
Canada	CA	Hong Kong	HK	New Zealand	NZ	Sweden	SE
Chile	CL	Hungary	HU	Nigeria	NG	Switzerland	CH
China	CN	India	IN	Norway	NO	Taiwan	TW
Colombia	CO	Indonesia	ID	Oman	OM	Thailand	TH
Congo	CG	Israel	IL	Pakistan	PK	Turkey	TR
Costa Rica	CR	Italy	IT	Panama	PA	Uganda	UG
Croatia	HR	Jamaica	JM	Paraguay	PY	Ukraine	UA
Czech Republic	CZ	Japan	JP	Philippines	PH	United States	US
Denmark	DK	Kenya	KE	Poland	PL	Uruguay	UY
Ecuador	EC	Kuwait	KW	Portugal	PT	Uzbekistan	UZ
Egypt	EG	Libya	LY	Romania	RO	Vietnam	VN
El Salvador	SV	Luxembourg	LU	Russian Federation	RU	Zimbabwe	ZW

## Troubleshooting

Check the following guide for the possible cause of a problem before contacting service.

Symptom	Cause	Solution
No power.	<ul style="list-style-type: none"> <li>The power cord is disconnected.</li> </ul>	<ul style="list-style-type: none"> <li>Plug the power cord into the wall outlet securely.</li> </ul>
No picture.	<ul style="list-style-type: none"> <li>TV/DVD mode for the recorder is set to TV.</li> </ul>	<ul style="list-style-type: none"> <li>Press TV/DVD on the remote control repeatedly to choose DVD mode. TV indicator disappears in the display window.</li> </ul>
	<ul style="list-style-type: none"> <li>The TV is not set to receive DVD Recorder signal output.</li> </ul>	<ul style="list-style-type: none"> <li>Select the appropriate video input mode on the TV so the picture from the DVD Recorder appears on the TV screen.</li> </ul>
	<ul style="list-style-type: none"> <li>The video cable is not connected securely.</li> </ul>	<ul style="list-style-type: none"> <li>Connect the video cable securely.</li> </ul>
	<ul style="list-style-type: none"> <li>The connected TV power is turned off.</li> </ul>	<ul style="list-style-type: none"> <li>Turn on the TV.</li> </ul>
No sound.	<ul style="list-style-type: none"> <li>The equipment connected with the audio cable(s) is not set to receive DVD Recorder signal output.</li> </ul>	<ul style="list-style-type: none"> <li>Select the correct input mode on the Audio Receiver so you can listen to the sound from the DVD Recorder.</li> </ul>
	<ul style="list-style-type: none"> <li>The audio cables are not connected securely.</li> </ul>	<ul style="list-style-type: none"> <li>Connect the audio cable securely.</li> </ul>
	<ul style="list-style-type: none"> <li>The power of the equipment connected with the audio cable is turned off.</li> </ul>	<ul style="list-style-type: none"> <li>Turn on the equipment connected with the audio cable.</li> </ul>
	<ul style="list-style-type: none"> <li>The audio connecting cord is damaged.</li> </ul>	<ul style="list-style-type: none"> <li>Replace it with new one.</li> </ul>
The playback picture is poor.	<ul style="list-style-type: none"> <li>The disc is dirty.</li> </ul>	<ul style="list-style-type: none"> <li>Clean the disc.</li> </ul>
The DVD Recorder does not start playback.	<ul style="list-style-type: none"> <li>No disc is inserted.</li> </ul>	<ul style="list-style-type: none"> <li>Insert a disc. (Check that the disc indicator in the display window is lit.)</li> </ul>
	<ul style="list-style-type: none"> <li>An unplayable disc is inserted.</li> </ul>	<ul style="list-style-type: none"> <li>Insert a playable disc. (Check the disc type, color system, and regional code.)</li> </ul>
	<ul style="list-style-type: none"> <li>The disc is placed upside down.</li> </ul>	<ul style="list-style-type: none"> <li>Place the disc with the playback side down.</li> </ul>
	<ul style="list-style-type: none"> <li>The disc is not placed within the guide.</li> </ul>	<ul style="list-style-type: none"> <li>Place the disc on the disc tray correctly inside the guide.</li> </ul>
	<ul style="list-style-type: none"> <li>The disc is dirty.</li> </ul>	<ul style="list-style-type: none"> <li>Clean the disc.</li> </ul>
	<ul style="list-style-type: none"> <li>The Rating level is set.</li> </ul>	<ul style="list-style-type: none"> <li>Cancel the Rating function or change the rating level.</li> </ul>
The picture from the external input is distorted	<ul style="list-style-type: none"> <li>The video signal from the external component is copy-protected.</li> </ul>	<ul style="list-style-type: none"> <li>You cannot connect via this Recorder. Connect the component directly to your TV.</li> </ul>
Some channels are skipped over when using ▲ / ▼.	<ul style="list-style-type: none"> <li>Those channels are not stored in the Recorder.</li> </ul>	<ul style="list-style-type: none"> <li>Restore channels. See "Program Edit" on pages 19-20.</li> </ul>
The picture or sound of broadcasting channel is weak or missing.	<ul style="list-style-type: none"> <li>Aerial or cables are loose.</li> </ul>	<ul style="list-style-type: none"> <li>Tighten connections or replace cable.</li> </ul>
Camcorder image is not shown.	<ul style="list-style-type: none"> <li>Camcorder is off.</li> </ul>	<ul style="list-style-type: none"> <li>Turn camcorder on and operate properly.</li> </ul>
Camcorder image via A/V input or DV IN to DVD Recorder is not shown on TV screen.	<ul style="list-style-type: none"> <li>DVD Recorder INPUT SELECT is incorrect.</li> </ul>	<ul style="list-style-type: none"> <li>Use AV/FUNC. to select input channel (AV1, AV2, DV, etc.)</li> </ul>

## Troubleshooting (Continued)

Symptom	Cause	Solution
Can't play a disc recorded using this Recorder on another player.	• The disc was recorded in Video mode.	• Finalize the disc. (page 28)
	• Some players will not play even a finalized disc recorded in Video mode.	• No solution.
	• The disc was recorded in VR mode,	• The other player must be RW compatible in order to play it.
	• Discs recorded with copy-once material cannot be played on other players.	• No solution.
Cannot record or did not record successfully.	• The remaining blank space on the disc is insufficient.	• Use another disc.
	• The source you are trying to record is copy protected.	• You cannot record the source.
	• When setting the recording channel, the channel is tuned on the TV's own tuner.	• Select the channel on the Recorder's built-in TV tuner.
	• When recording to a Video mode disc, programs that are copy-once protected cannot be recorded.	• Use a VR mode formatted disc for copy-once material.
Timer recording is not possible.	• Clock in DVD Recorder is not set to correct time.	• Set clock to correct time. See "Auto Clock Set" or "Manual Clock Set" on page 21.
	• Timer has been programmed incorrectly.	• Reprogram Timer. See "Timer Recording" on page 39.
	• Timer record indicator light does not appear after programming timer.	• Reprogram Timer.
Stereo Audio Record and/or Playback is not present.	• TV is not Stereo-compatible.	• No solution.
	• Broadcast program is not in stereo format.	• No solution.
	• DVD Recorder A/V Out jacks are not connected to TV A/V In jacks.	• Make A/V connections. Stereo is available only via A/V output from DVD Recorder.
	• DVD Recorder Audio/Video Out is not selected for viewing at the TV.	• Select AUX or A/V source as TV input.
	• DVD Recorder's TV audio channel is set to mono.	• Set TV audio channel mode to Stereo. See "Changing TV audio channel" on page 38.
The Remote Control does not work properly.	• The Remote Control is not pointed at the remote sensor on the DVD Recorder.	• Point the Remote Control at the remote sensor on the DVD Recorder.
	• The Remote Control is too far from the DVD Recorder.	• Operate the Remote Control within 7 m.
	• There is an obstacle in the path of the Remote Control and the DVD Recorder.	• Remove the obstacle.
	• The batteries in the Remote Control are exhausted.	• Replace the batteries with new ones.

### Moisture Condensation

Moisture condensation can occur:	In locations where moisture condensation may occur:
<ul style="list-style-type: none"> <li>• If the DVD Recorder is moved from a cold place to a warm place.</li> <li>• Under extremely humid conditions.</li> </ul>	<ul style="list-style-type: none"> <li>• Keep the DVD Recorder plugged into an AC power outlet with POWER On. This will help prevent condensation.</li> <li>• If condensation has occurred, wait a few hours for the DVD Recorder to dry before using it.</li> </ul>

## Specifications

### General

Power requirements	AC 110-240V, 50/60 Hz
Power consumption	30W
Dimensions (approx.)	430 x 69 x 280 mm (w x h x d)
Mass (approx.)	3.8Kg
Operating temperature	5°C to 35°C
Operating humidity	5 % to 90 %
Television system	PAL B/G colour system
Recording format	PAL

### Recording

Recording format	DVD Video Recording, DVD-VIDEO
Recordable discs	DVD-ReWritable, DVD-Recordable, DVD+ReWritable, DVD+Recordable
Recordable time	Approx. 1 hour (HQ mode), 2 hours (SQ mode), 4 hours (LQ mode), 6 hours (EQ mode)
<b>Video recording format</b>	
Sampling frequency	27MHz
Compression format	MPEG 2
<b>Audio recording format</b>	
Sampling frequency	48kHz
Compression format	Dolby Digital

### Playback

Frequency response	DVD (PCM 48 kHz): 8 Hz to 22 kHz, CD: 8 Hz to 20 kHz DVD (PCM 96 kHz): 8 Hz to 44 kHz
Signal-to-noise ratio	More than 100 dB (AUDIO OUT connector)
Harmonic distortion	Less than 0.008% THD (AUDIO OUT connector)
Dynamic range	More than 95 dB (AUDIO OUT connector)

### Inputs

ANTENNA IN	Antenna input, 75 ohms
VIDEO IN	1.0 Vp-p 75 ohms, sync negative, RCA jack x 2 / SCART x 2
AUDIO IN	0 dBm more than 47 kohms, RCA jack (L, R) x 2 / SCART x 2
DV IN	4 pin (i.LINK/IEEE 1394 standard)

### Outputs

VIDEO OUT	1 Vp-p 75 Ω, sync negative, RCA jack x 1 / SCART
S-VIDEO OUT	(Y) 1.0 V (p-p), 75 Ω, negative sync, Mini DIN 4-pin x 1 (C) 0.3 V (p-p) 75 Ω
COMPONENT VIDEO OUT	(Y) 1.0 V (p-p), 75 Ω, negative sync, RCA jack x 1 (Pb)/(Pr) 0.7 V (p-p), 75 Ω, RCA jack x 2
Audio output (digital audio)	0.5 V (p-p), 75 Ω, RCA jack x 1
Audio output (optical audio)	3 V (p-p), 75 Ω, Optical connector x 1
Audio output (analog audio)	2.0 Vrms (1 KHz, 0 dB), 600 Ω, RCA jack (L, R) x 1 / SCART

### Accessories:

Scart cable . . . . .	1	Digital audio cable (Coaxial) . . . . .	1
Video cable . . . . .	1	Audio cable (L, R) . . . . .	1
RF Coaxial Cable . . . . .	1		

- Design and specifications are subject to change without notice.
- Manufactured under license from Dolby Laboratories. "Dolby", "Pro Logic" and the double-D symbol are trademarks of Dolby Laboratories.
- DTS and DTS Digital Out are registered trademarks of Digital Theater Systems, Inc.



P/NO : 3835RH0065E