

Table of Contents

ENGLISH

Installation and Connection

Safety Precautions	A1
Accessories	A4
Using the Remote Control	A5
Connecting the Speakers - Optional	A8
Name and Function of the Parts	A9
Connecting the Monitor	A10
Connecting the VCR/DVD	A13
Connecting the DVD/HDTV	A15
Connecting AV Outputs	A16

Input Selection and Tracking

Selecting and Adjustment the Screen	A17
Name of the Buttons in the Screen Adjustment Unit	A17
OSD Menu	A19
How to adjust the OSD (On Screen Display) screen	A20
When Connected to your PC	A21
Adjusting Screen Color	A21
Adjusting Screen CLOCK/PHASE and Position	A21
Adjusting the audio function	A22
Selecting the Options	A23
Adjusting PIP/POP/PBP Mode(Multiple Screen) Functions	A24
When Watching VCR/DVD/HDTV	A27
Adjusting Screen Image	A27
Adjusting the audio function	A28
Selecting the Options	A29
Adjusting PIP/POP/PBP Mode(Multiple Screen) Functions	A30
Controlling the Multiple Monitors	A33

Miscellaneous



Troubleshooting	A37
Specifications	A40



is a trademark of SRS Labs, Inc.
technology is incorporated under license from SRS Labs, Inc.

Safety Precautions

Please read these safety precautions carefully before using the monitor.

-  **Warning** If you ignore the warning message, you may be seriously injured or there is a possibility of accident or death.
-  **Caution** If you ignore the caution message, you may be slightly injured or the product may be damaged

Precautions in installing the Monitor

Warning

- **Keep away from heat sources like electrical heaters.**
 - Electrical shock, fire, malfunction or deformation may occur.
- **Keep the packing anti-moisture material or vinyl packing out of the reach of children.**
 - Anti-moisture material is harmful if swallowed. If swallowed by mistake, force the patient to vomit and visit the nearest hospital. Additionally, vinyl packing can cause suffocation. Keep it out of the reach of children.
- **Do not put heavy objects on the monitor or sit upon it.**
 - If the monitor collapses or is dropped, you may be injured. Children must pay particular attention.
- **Do not leave the power or signal cable unattended on the pathway.**
 - The passerby can falter, which can cause electrical shock, fire, product breakdown or injury.
- **Install the monitor in a neat and dry place.**
 - Dust or moisture can cause electrical shock, fire or product damage.
- **If you can smell smoke or other odors or hear a strange sound unplug the power cord and contact the service center.**
 - If you continue to use without taking proper measures, electrical shock or fire can occur.
- **If you dropped the monitor or the case is broken, turn off the monitor and unplug the power cord.**
 - If you continue to use without taking proper measures, electrical shock or fire can occur. Contact the service center.
- **Do not drop metallic objects such as coins, hair pins, chopsticks or wire into the monitor, or inflammable objects such as paper and matches. Children must pay particular attention.**
 - Electrical shock, fire or injury can occur. If a foreign object is dropped into the monitor, unplug the power cord and contact the service center.

Caution

- **Make sure the monitor ventilation hole is not blocked. Install the monitor in a suitably wide place (more than 10cm from the wall)**
 - If you install the monitor too close to the wall, it may be deformed or fire can break out due to internal heat.
- **Do not block the ventilation hole of the monitor by a tablecloth or curtain.**
 - The monitor can be deformed or fire can break out due to overheating inside the monitor.
- **Install the monitor on a flat and stable place that has no risk of dropping the monitor.**
 - If the monitor is dropped, you may be injured or the monitor may be broken.
- **Install the monitor where no EMI occurs.**
- **Keep the monitor away from direct sunlight.**
 - The monitor can be damaged.

Electrical Power Related Precautions

Warning

- **Make sure to connect the power cable to the grounded current.**
 - You may be electrocuted or injured.
- **Use the rated voltage only.**
 - The monitor can be damaged, or you may be electrocuted.
- **During a thunder or lightning storm, unplug the power cable or signal cable.**
 - You may be electrocuted or a fire can break out.
- **Do not connect several extension cords, electrical appliances or electrical heaters to a single outlet. Use a power bar with a grounding terminal designed for exclusive use with the computer.**
 - A fire can break out due to overheating.
- **Do not touch the power plug with wet hands. Additionally, if the cord pin is wet or covered with dust, dry the power plug completely or wipe dust off.**
 - You may be electrocuted due to excess moisture.
- **If you don't intend to use the monitor for a long time, unplug the power cable from the monitor.**
 - Covering dust can cause a fire, or insulation deterioration can cause electric leakage, electric shock or fire.
- **Fix the power cable completely.**
 - If the power cable is not fixed completely, a fire can break out.
- **Hold the plug when pulling out the power cable. Do not bend the power cord with excessive force or put heavy objects on the power cord.**
 - The power line can be damaged, which may cause electric shock or fire.
- **Do not insert a conductor (like a metal chopstick) into one end of the power cable while the other end is connected to the input terminal on the wall. Additionally, do not touch the power cable right after plugging into the wall input terminal.**
 - You may be electrocuted.

Caution

- **Do not unplug the power cord while the monitor is in use.**
 - Electrical shock can damage the monitor.
-

Precautions in Moving the Monitor

Warning

- **Make sure to turn off the monitor.**
 - You may be electrocuted or the monitor can be damaged.
- **Make sure to remove all cables before moving the monitor.**
 - You may be electrocuted or the monitor can be damaged.

Safety Precautions

Caution

- **Do not shock the monitor when moving it.**
 - You may be electrocuted or the monitor can be damaged
 - **Do not dispose the product-packing box. Use it when you move.**
 - **Make the panel face forward and hold it with both hands to move.**
 - If you drop the monitor, the damaged monitor can cause electric shock or fire. Contact with the service center for repair.
-

Precautions in Using the Monitor

Warning

- **Do not disassemble, repair or modify the monitor at your own discretion.**
 - Fire or electric shock accident can occur.
 - Contact the service center for check, calibration or repair.
- **Do not spray water on the monitor or scrub with an inflammable substance (thinner or benzene). Fire or electric shock accident can occur**
- **Keep the monitor away from water.**
 - Fire or electric shock accident can occur.

Caution

- **Do not put or store inflammable substances near the monitor.**
 - There is a danger of explosion or fire due careless handling of the inflammable substances.
 - **When cleaning the brown tube surface, unplug the power cord and scrub with soft cloth to prevent scratching. Do not clean with a wet cloth.**
 - The water can sink into the monitor, which can cause electric shock or serious malfunction.
 - **Take a rest from time to time to protect your vision.**
 - **Keep the monitor clean at all times.**
 - **Take a comfortable and natural position when working with a monitor to relax the muscles.**
 - **Take a regular break when working with a monitor for a long time.**
 - **Do not press strongly upon the panel with a hand or sharp object such as nail, pencil or pen, or make a scratch on it.**
 - **Keep the proper distance from the monitor.**
 - Your vision may be impaired if you look at the monitor too closely.
 - **Set the appropriate resolution and clock by referring to the User's Manual.**
 - Your vision can be impaired.
 - **Use authorized detergent only when cleaning the monitor. (Do not use benzene, thinner or alcohol.)**
 - Monitor can be deformed.
-

On Disposal

- **The fluorescent lamp used in this product contains a small amount of mercury.**
- **Do not dispose of this product with general household waste.**
 - Disposal of this product must be carried out in accordance to the regulations of your local authority.

Accessories

Please check the accessories in the product package.

* The monitor and the accessories can be different from the figures shown here.

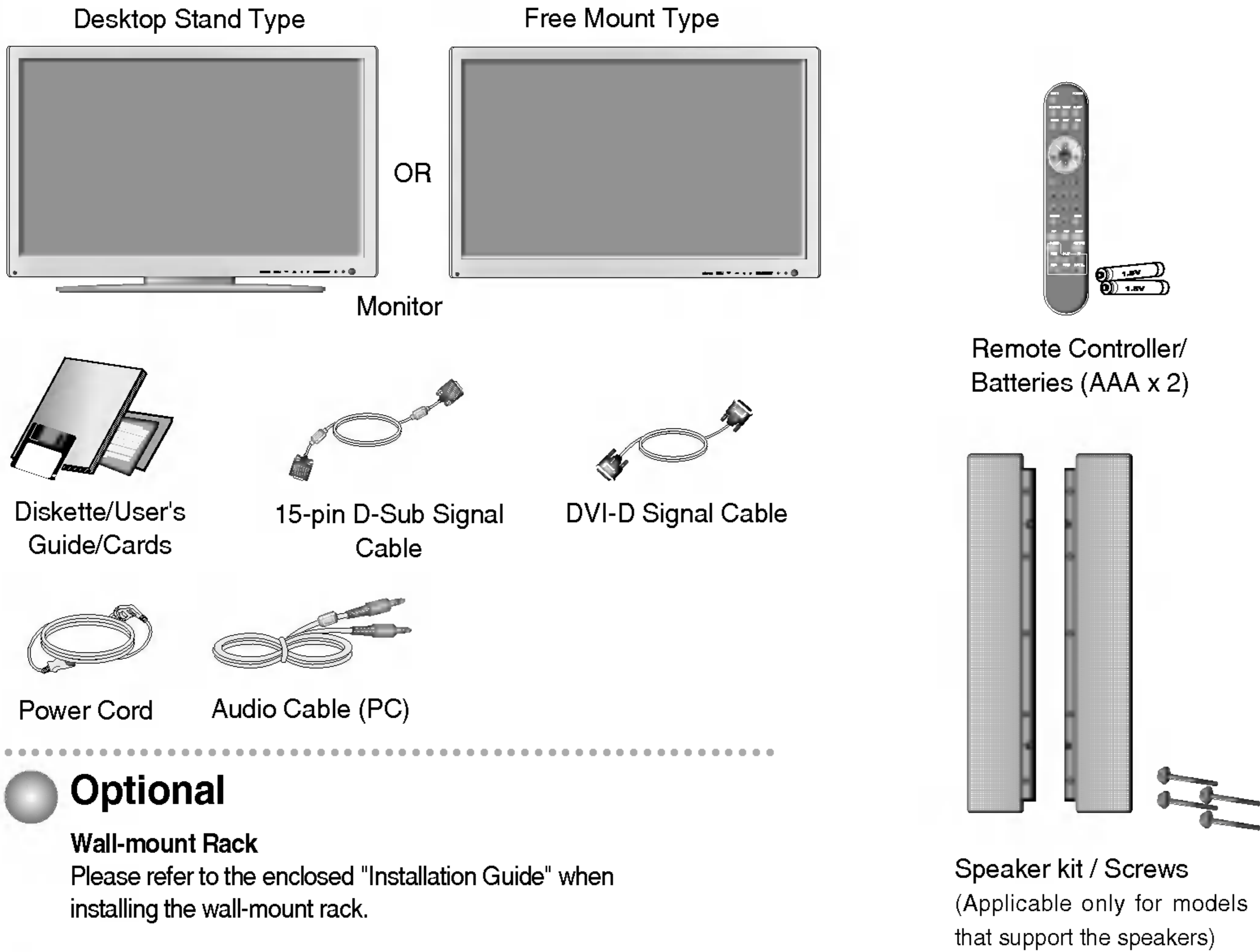

Optional

Wall-mount Rack

Please refer to the enclosed "Installation Guide" when installing the wall-mount rack.



Note

This manual provides a separate description for cases 1 and 2, depending on the type of AV option board selected (an optional product).

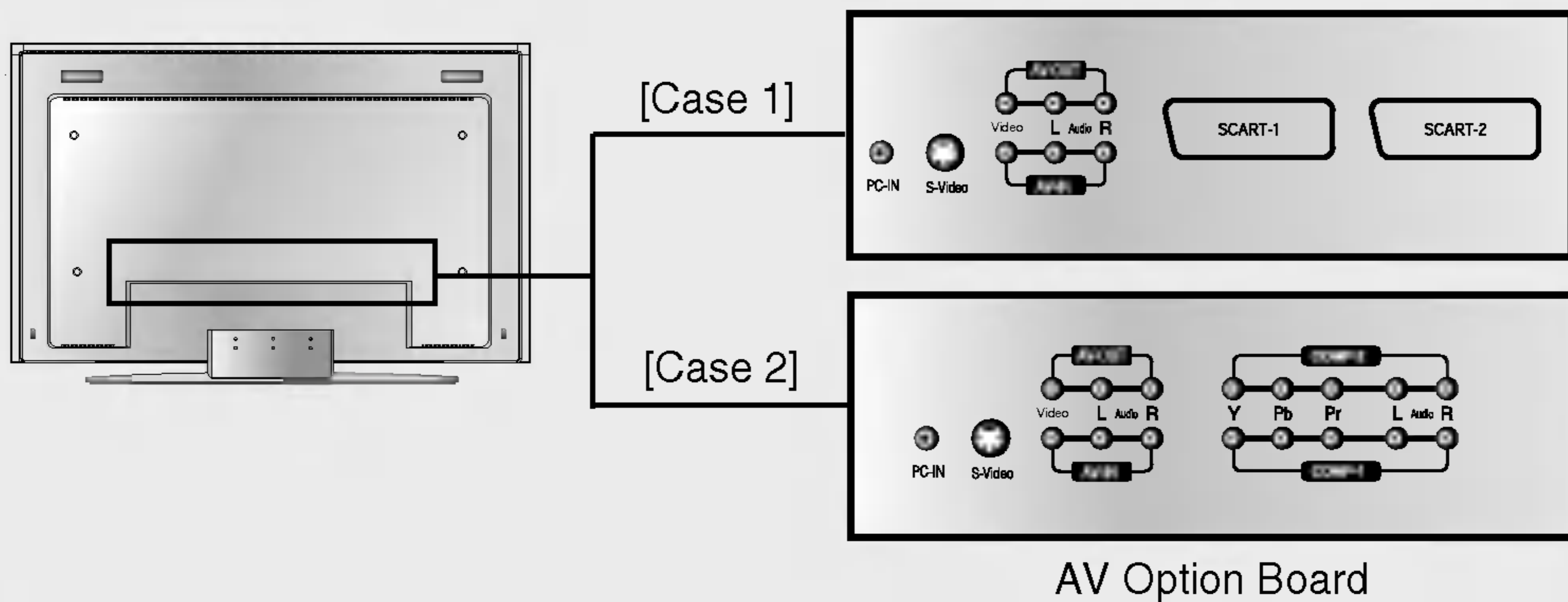

Using the Remote Control

● Name of the Remote Controller Buttons

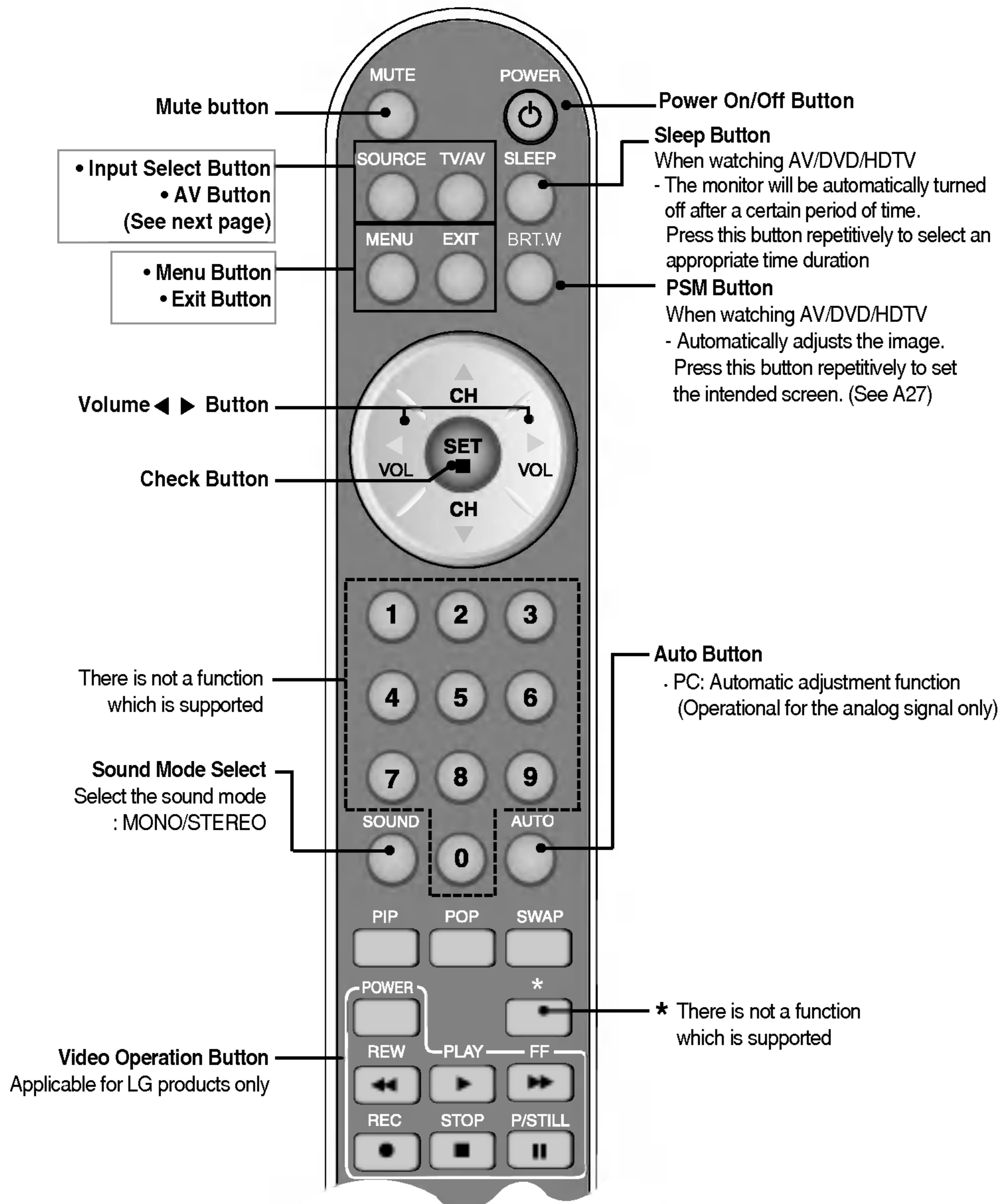

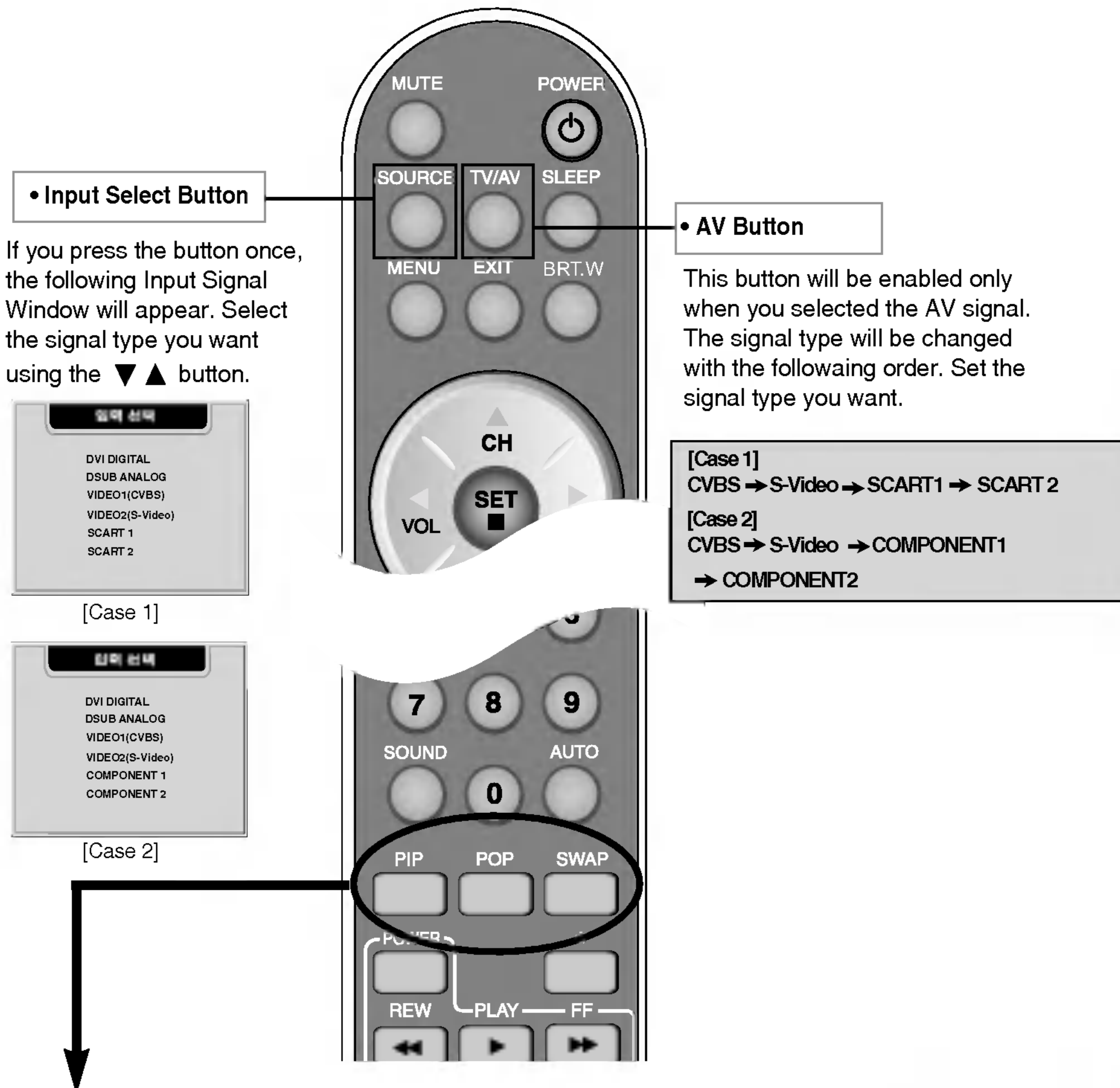

1. PIP (Picture in Picture) Button

The sub-screen moves to the next mode whenever you press this button.
: SMALL -> LARGE -> OFF

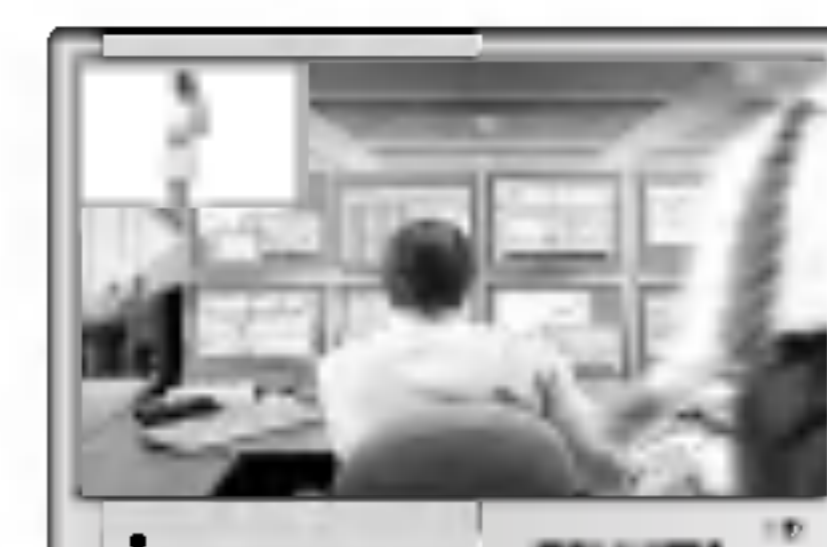

PIP

2. POP (Picture out Picture) Button

The sub-screen moves to the next mode whenever you press this button.
: POP ON -> PBP(FULL) -> PBP(4:3) -> OFF

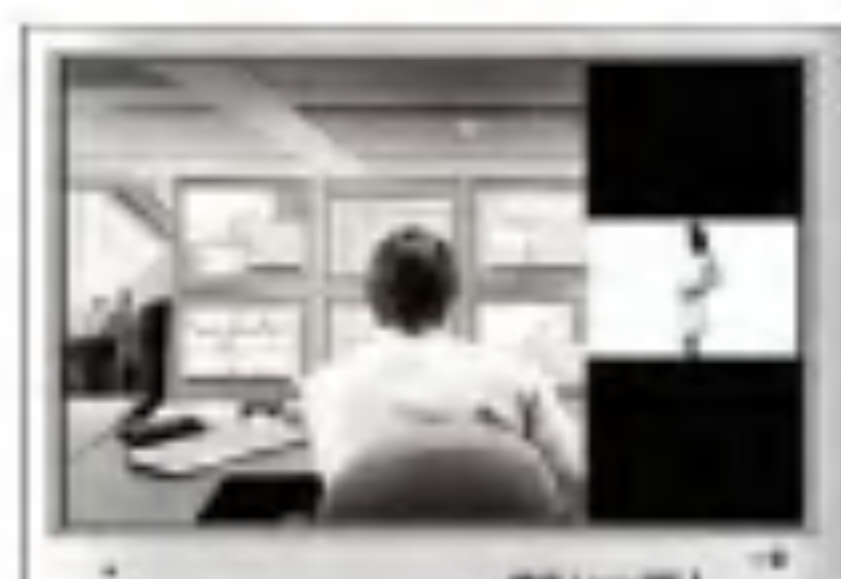

POP ON



PBP (FULL)



PBP (4:3)



Note

• Case 1 / Case 2

Different descriptions are applicable depending on the type of AV option board selected (an optional product).

Using the Remote Control

3. Swap Button

You can swap the main screen and the sub-screen when the PIP/POP/PBP function is used.

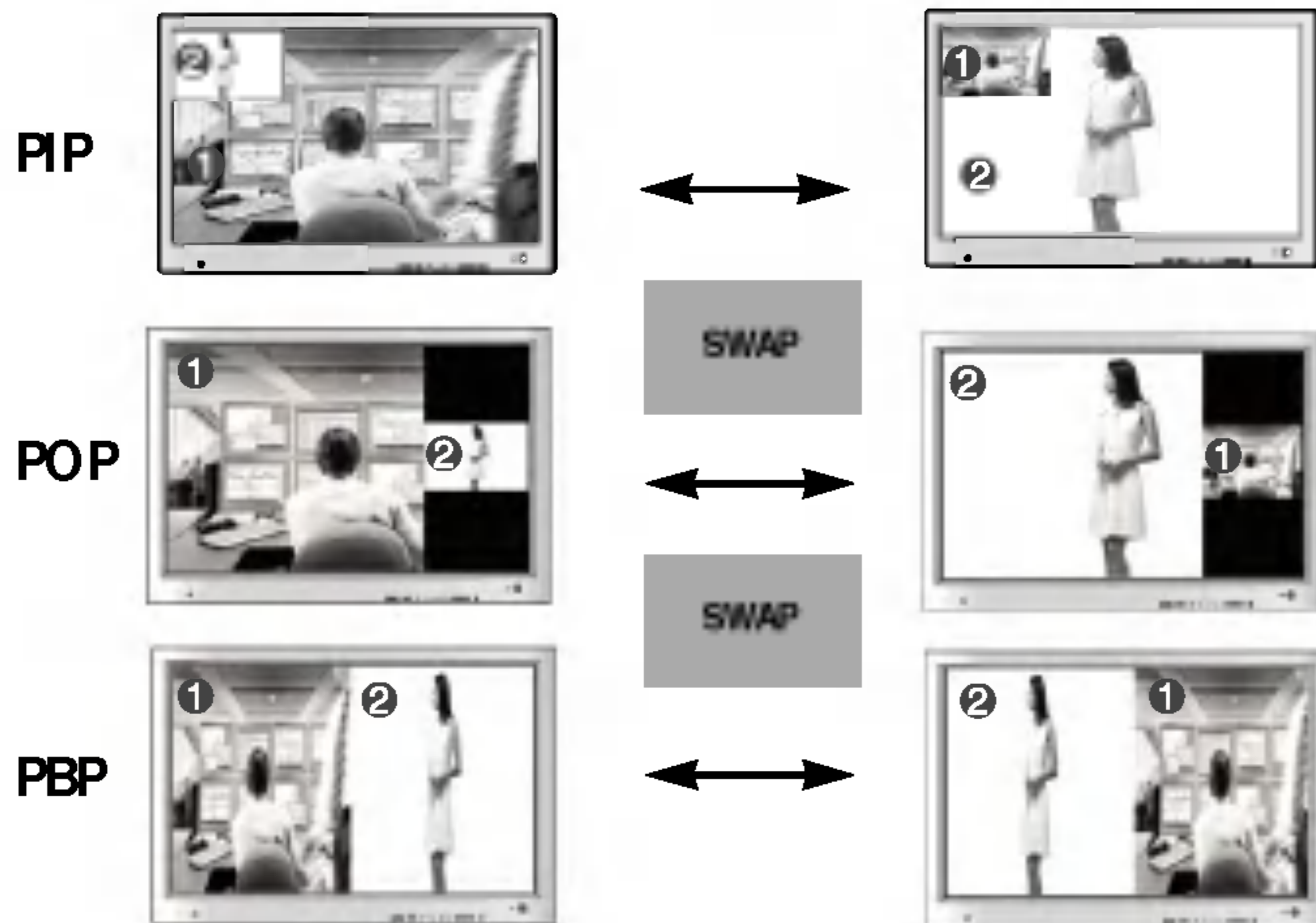

When 'Input Signal 1' comes on in the main screen, only 'Input Signal 2' can be displayed on the sub-screen. On the contrary, if the main screen displays 'Input Signal 2', the sub-screen can display 'Input Signal 1' only. You can swap 'Input Signal 1' and 'Input Signal 2' using the SWAP button.

<Table of PIP/POP/PBP Function Support>

Main Screen / Sub-Screen	D-SUB	DVI	CVBS	S-Video	SCART 1 COMPONENT 1	SCART 2 COMPONENT 2
D-SUB	X	●	●	●	●	●
DVI	●	X	●	●	●	●
CVBS	●	●	X	X	X	X
S-Video	●	●	X	X	X	X
SCART 1 COMPONENT 1	●	●	X	X	X	X
SCART 2 COMPONENT 2	●	●	X	X	X	X

Inserting batteries into remote controller.



1. Take out the battery cap.
2. Insert the battery with correct polarity (+/-).
3. Close the battery cap.
 - You can use a remote controller 7 meter distance and 30 degree (left/right) within the receiving unit scope.
 - Dispose of used batteries in the recycle bin to prevent environmental pollution.

Connecting the Speakers - Optional

* Applicable only for models that support the speakers

Use the screws to secure the speakers on the rear side of the monitor as shown in the below figure.

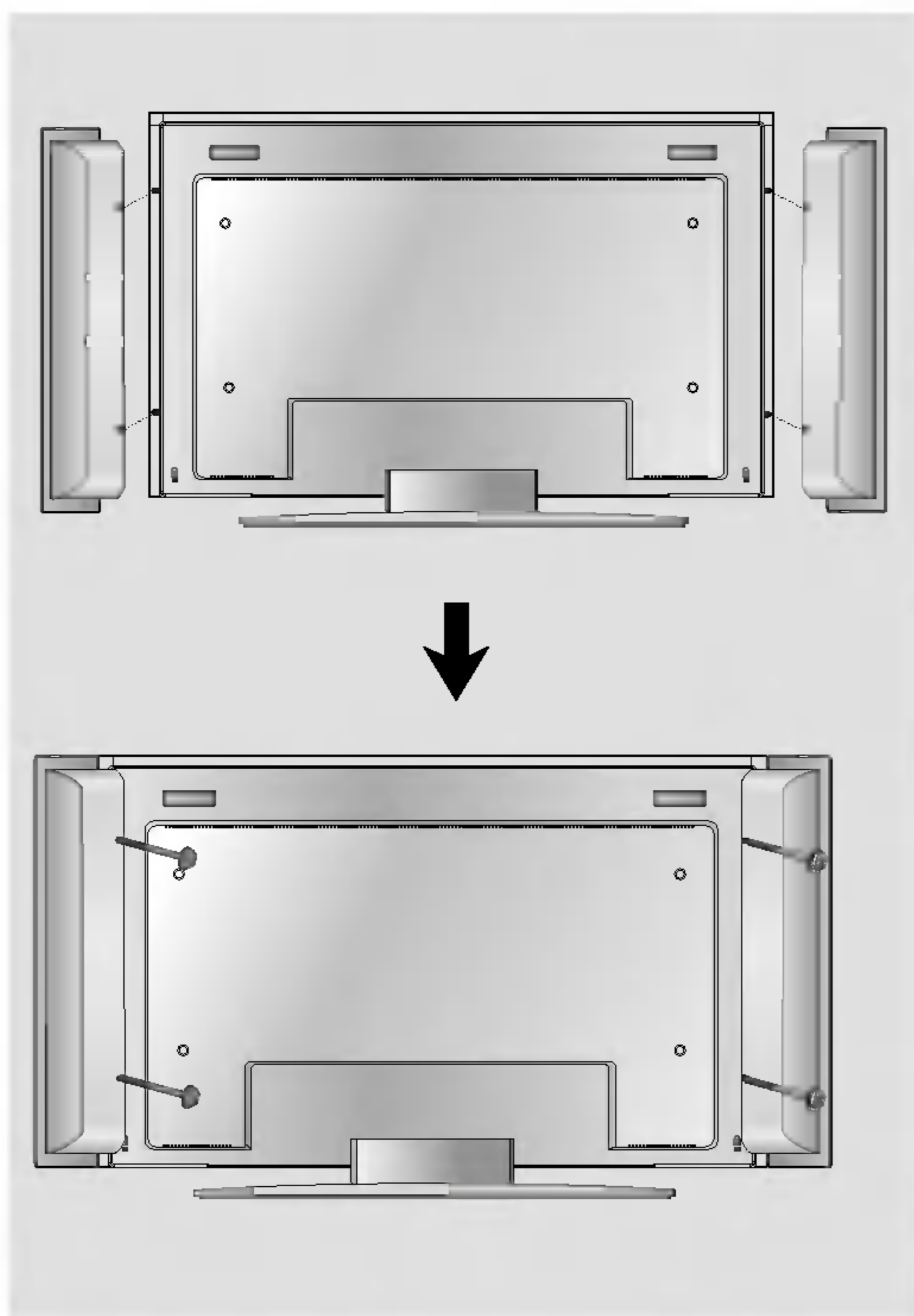

When the speaker is installed.

ENGLISH

Name and Function of the Parts

Rear View

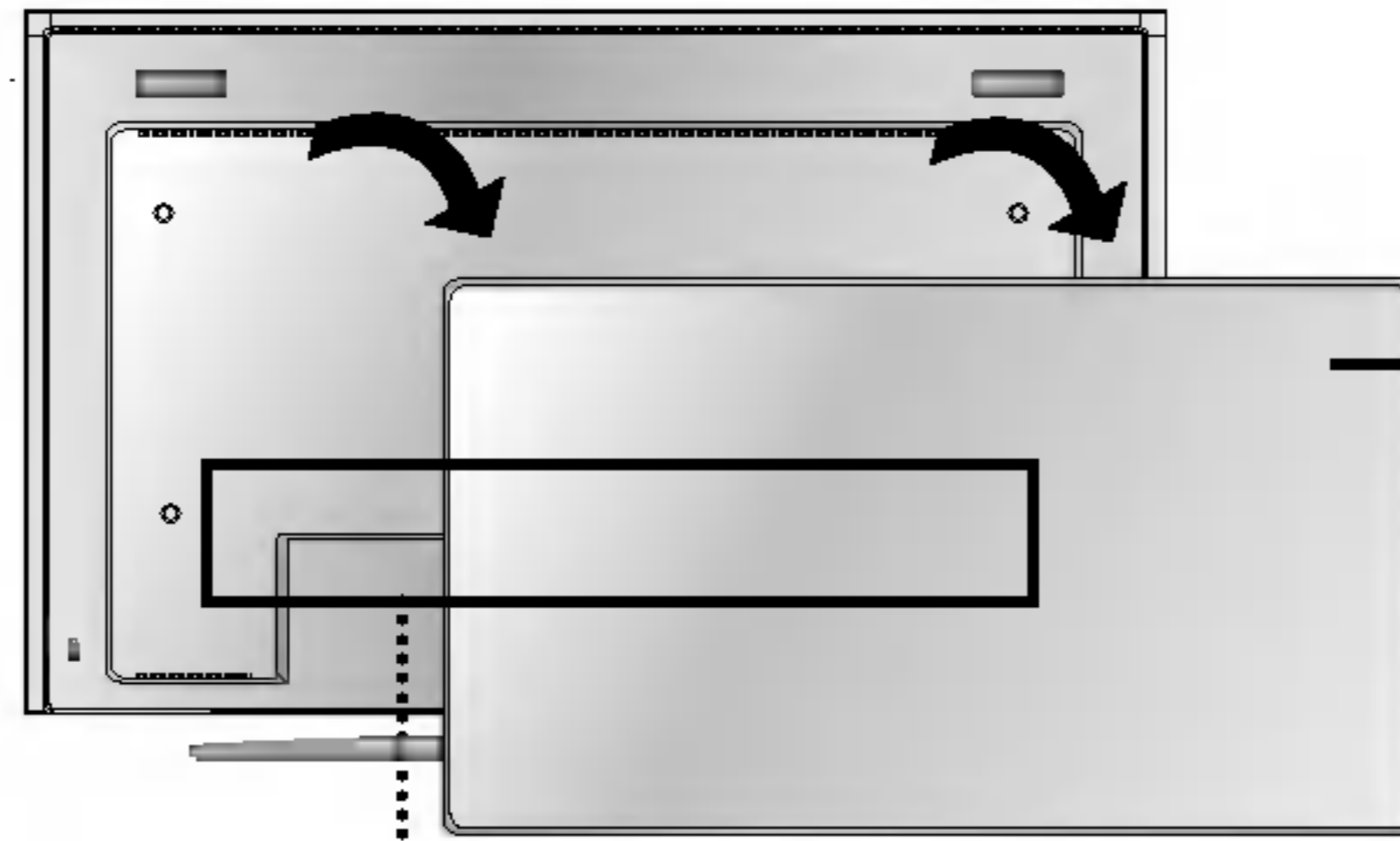

Back Cap
- Open the back cap before you install the monitor.

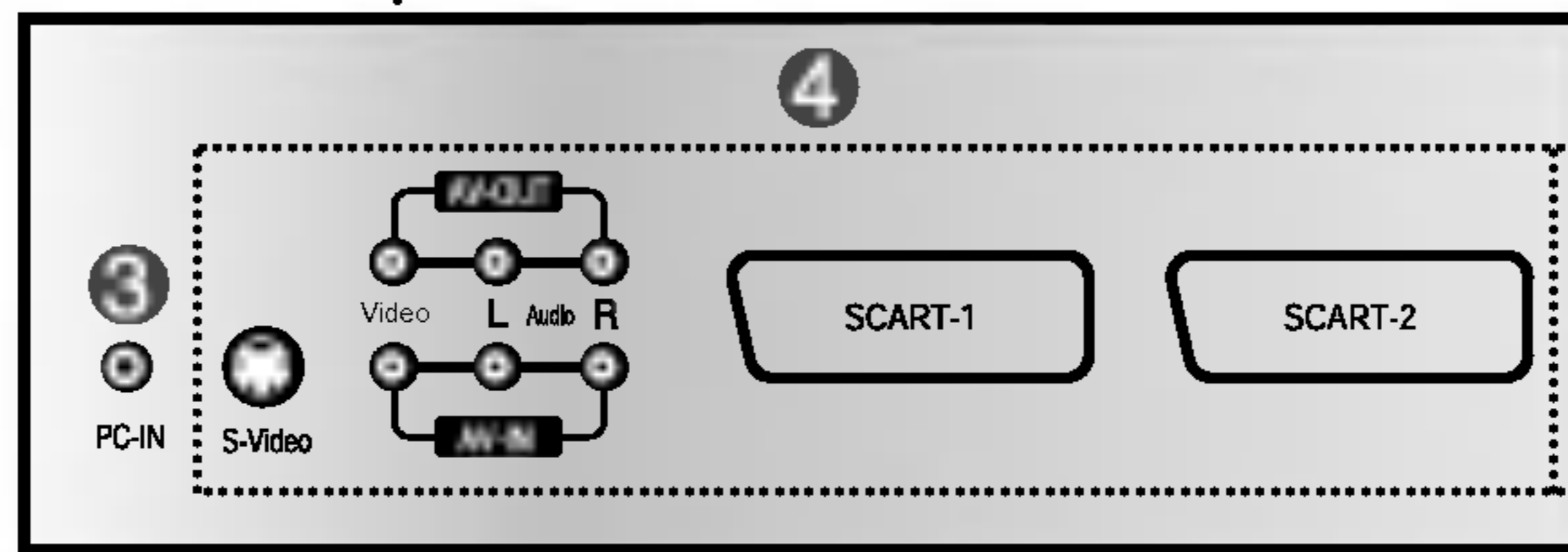

[Case 1]

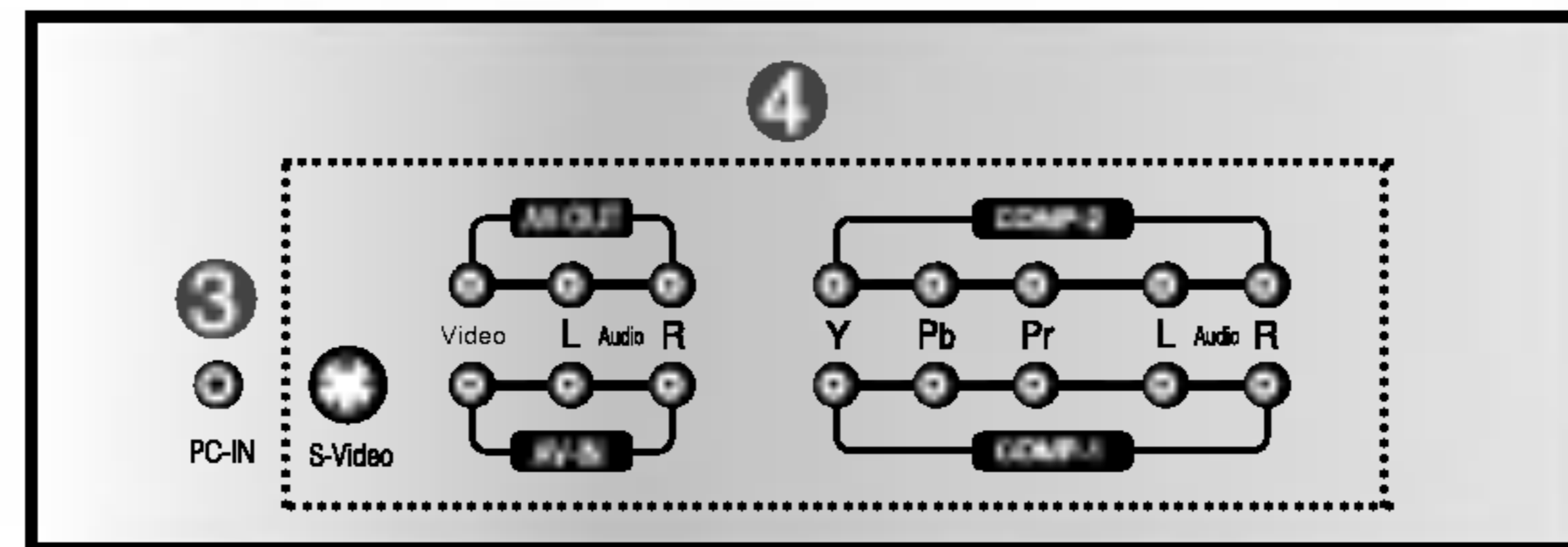
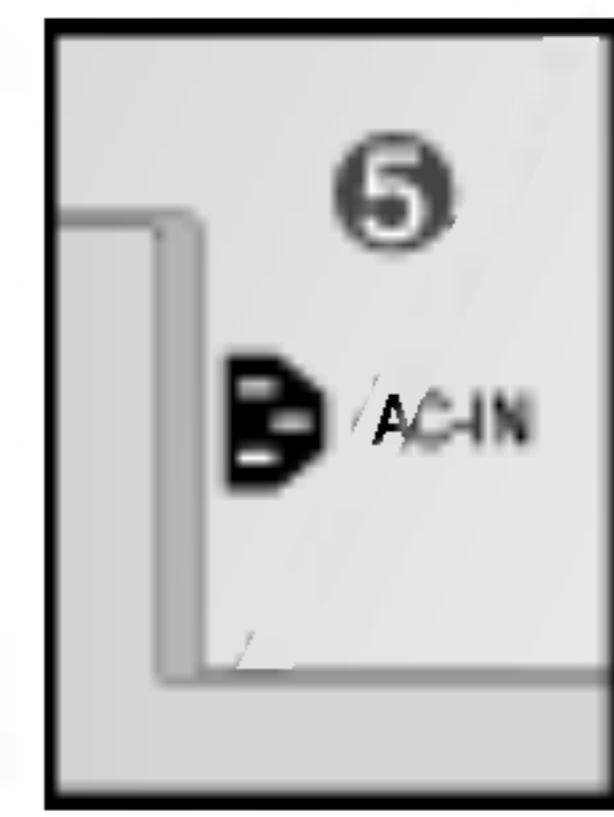

[Case 2]

- ① RS-232C Serial ports
- ② PC signal inputs
- ③ Connect the audio cable to the *LINE OUT jack of the PC sound card.
- ④ AV Input ports
- ⑤ Connect the power cord

*LINE OUT

A terminal used to connect to the speaker including a built-in amplifier (Amp). Make sure that the connecting terminal of the PC sound card is checked before connecting. If the Audio Out of PC sound card has only Speaker Out, reduce the PC volume.

If the Audio Out of the PC sound card supports both Speaker Out and Line Out, convert to Line Out using the card jumper of the program (Refer to the Sound Card Manual).

Connecting the Monitor

● To arrange cables in order

1. Disassemble the **stand cover**. The cover may be easily disassembled by pressing down on the base as shown in the figure.

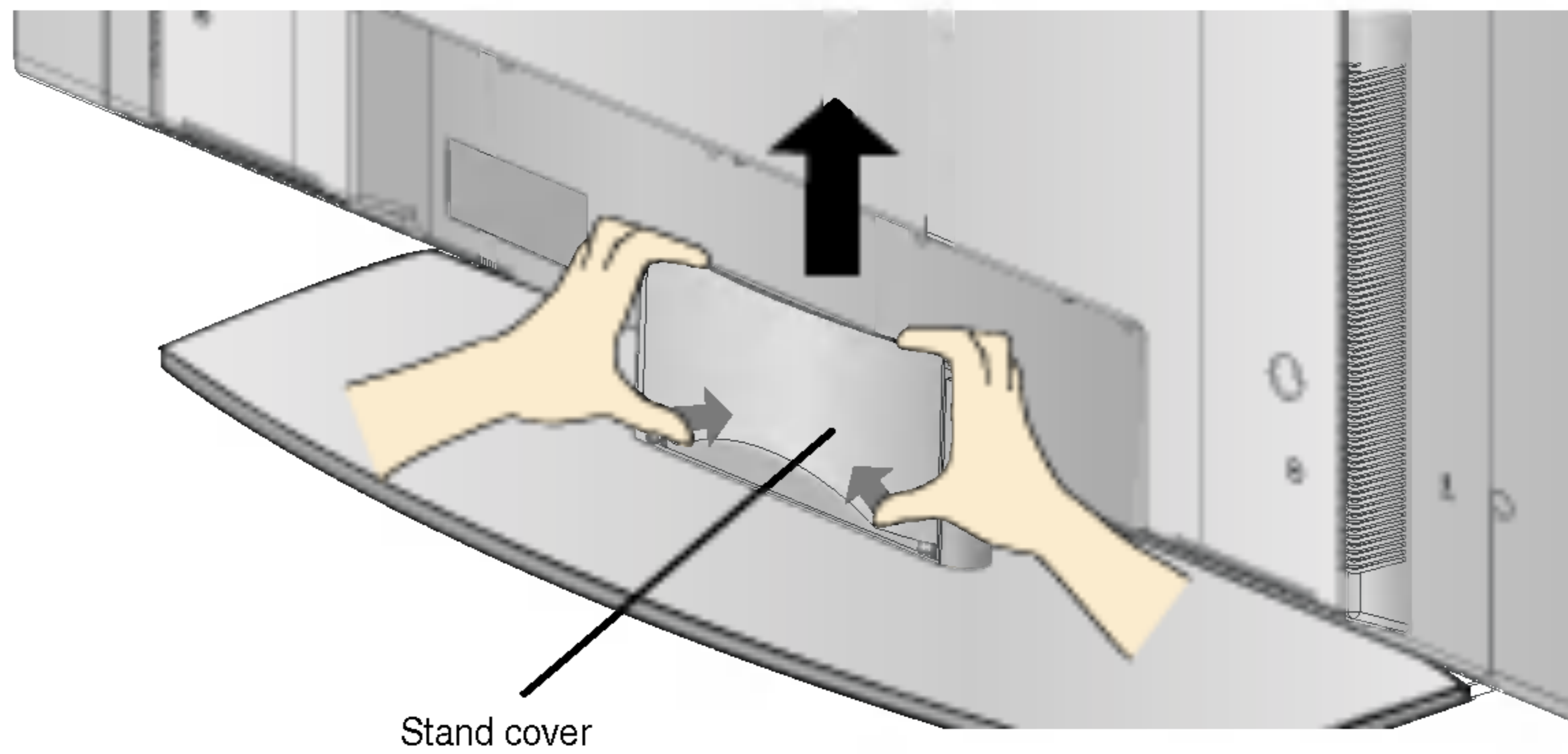

2. After connecting the cables, correctly position the stand cover into the holes on the stand. If securely connected, you will hear the latch click into place.

Connecting the Monitor

1 First of all, see if the computer, monitor and the peripherals are turned off. Then, connect the signal input cable.

- (A)** When connecting with the DVI signal input cable.
- (B)** When connecting with the DSub signal input cable. (IBM compatible PC)
- (C)** When connecting with the DSub signal input cable. (Macintosh)

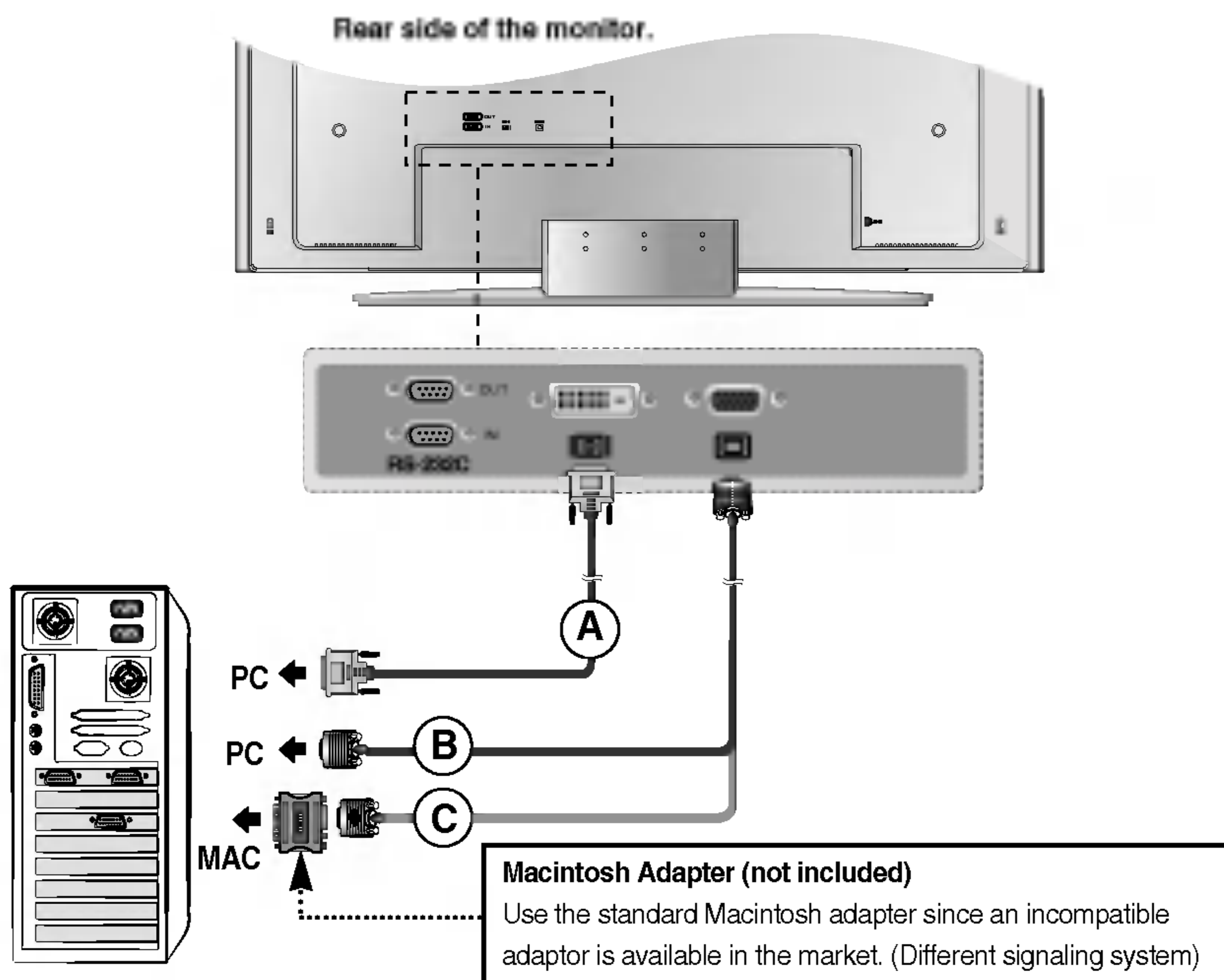

2 Connect the power cord.

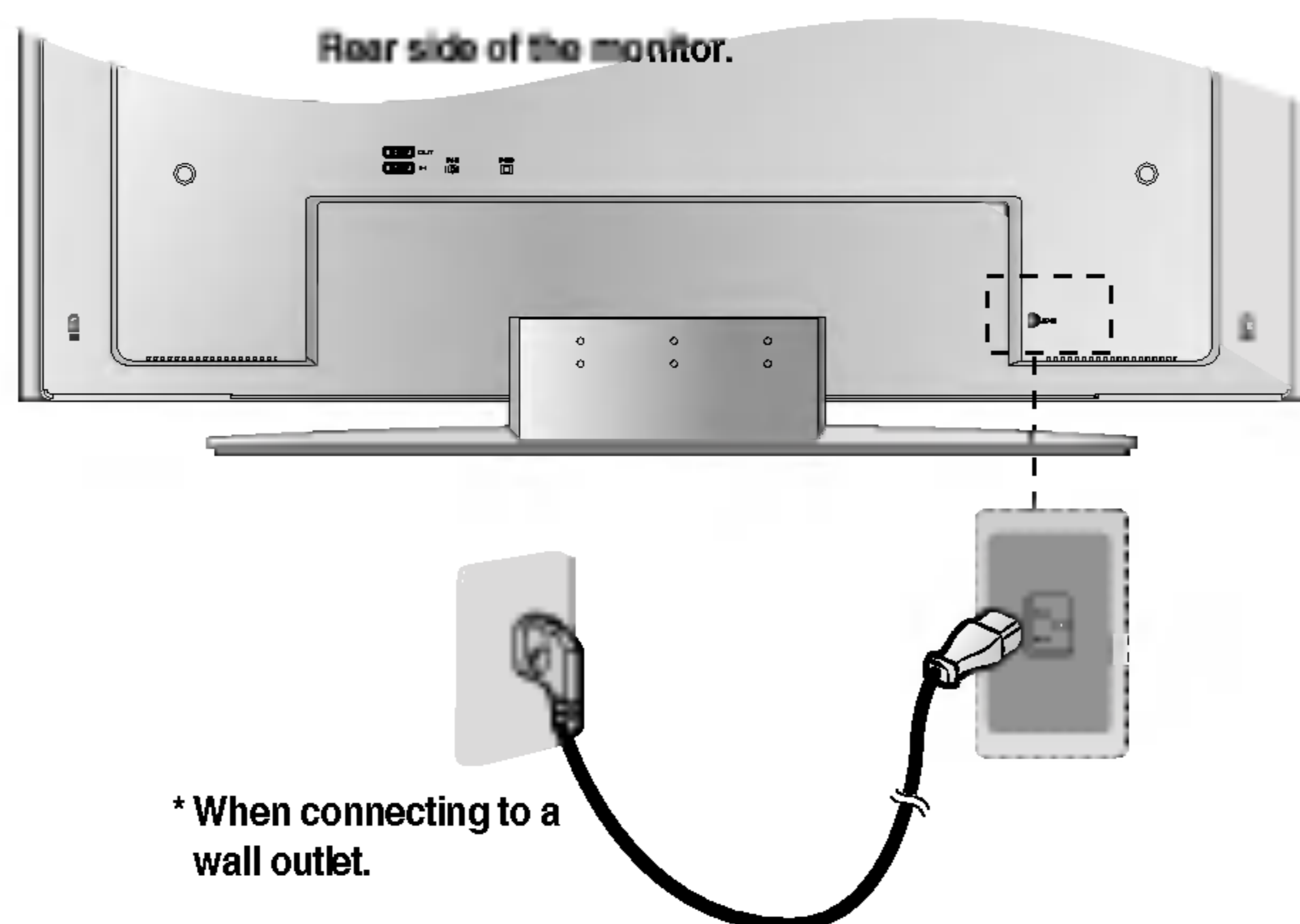

- 3 **A** Turn on power by pressing the power button on the monitor. If the system is not powered up, check if the main power switch is in the 'on' position.

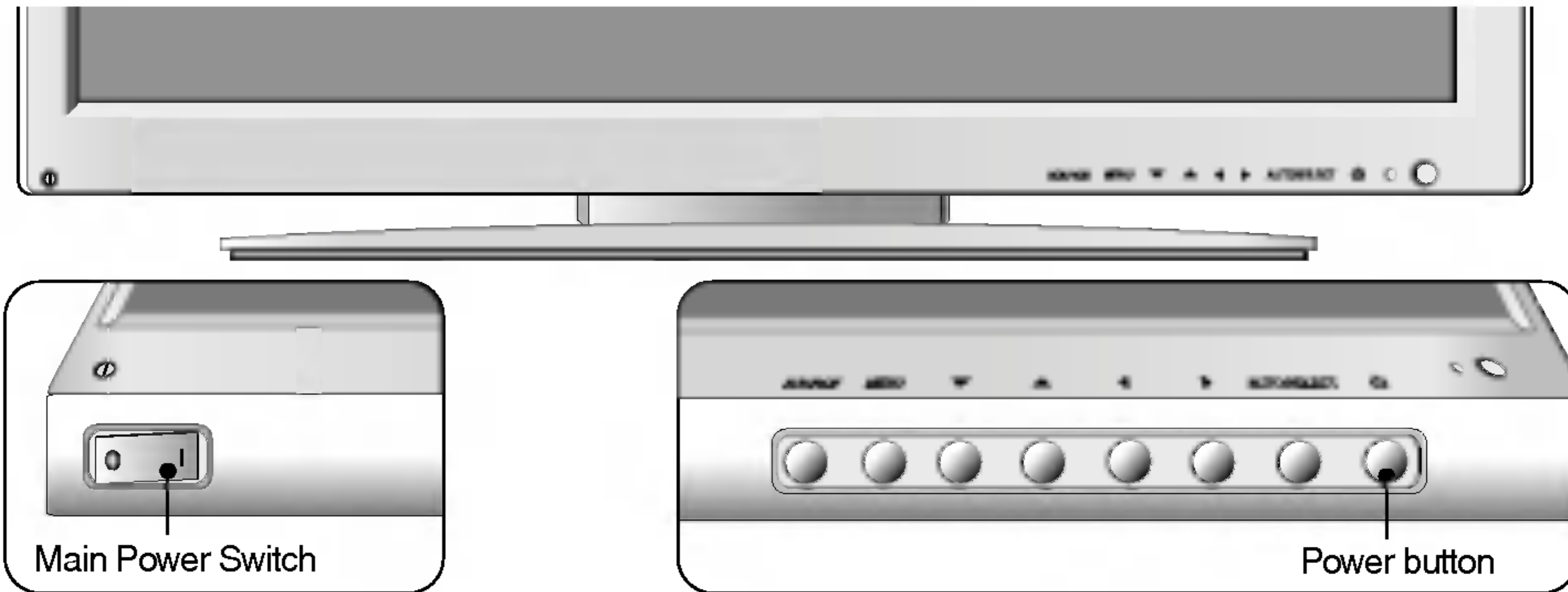

- B** Turn on the PC.

- 4 Select an input signal.
Press the Input Select button on the remote controller to select the input signal.
Or, press the SOURCE button at the front side of the monitor.

SOURCE → ▼▲ → **SET**

- A** When connecting with a DVI-D signal input cable.
• Select DVI DIGITAL: DVI-D digital signal.
- B** When connecting with a D-Sub signal input cable.
• Select DSUB ANALOG: 15-pin D-Sub analog signal

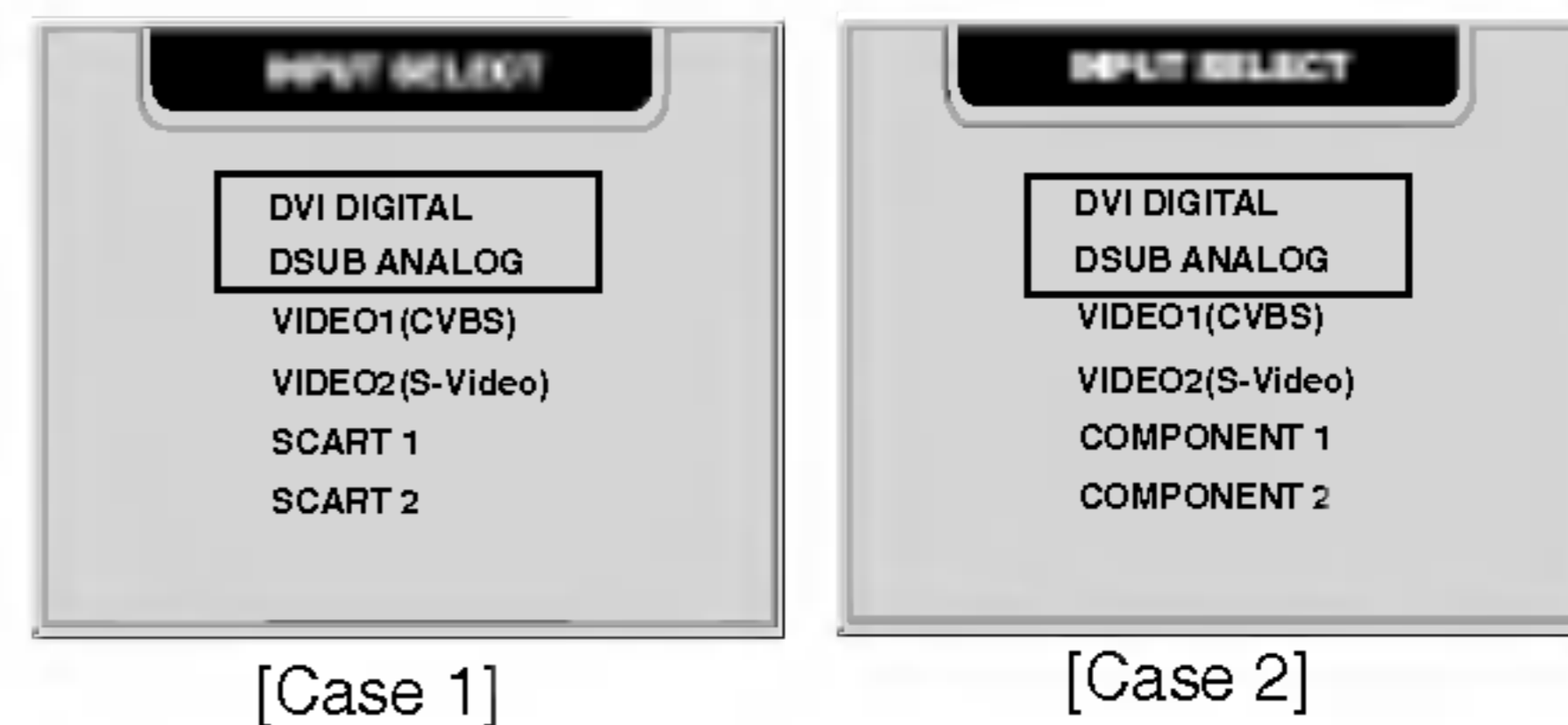

Note

- **How to connect to two computers.**
Connect the signal cables (DVI and D-Sub) to each computer.
Press the Input Select button in a remote controller to select the computer to use.
- **Directly connect to a grounded power outlet on the wall or a power bar with a ground wire.**

Connecting the VCR/DVD

- 1 Connect the video cable as shown in the below figure and then connect the power cord (See page A11).

A When connecting with an RCA cable.

- Connect the input terminal with a proper color match. (Video – Yellow, Sound (left) – White, Sound (right) – Red)

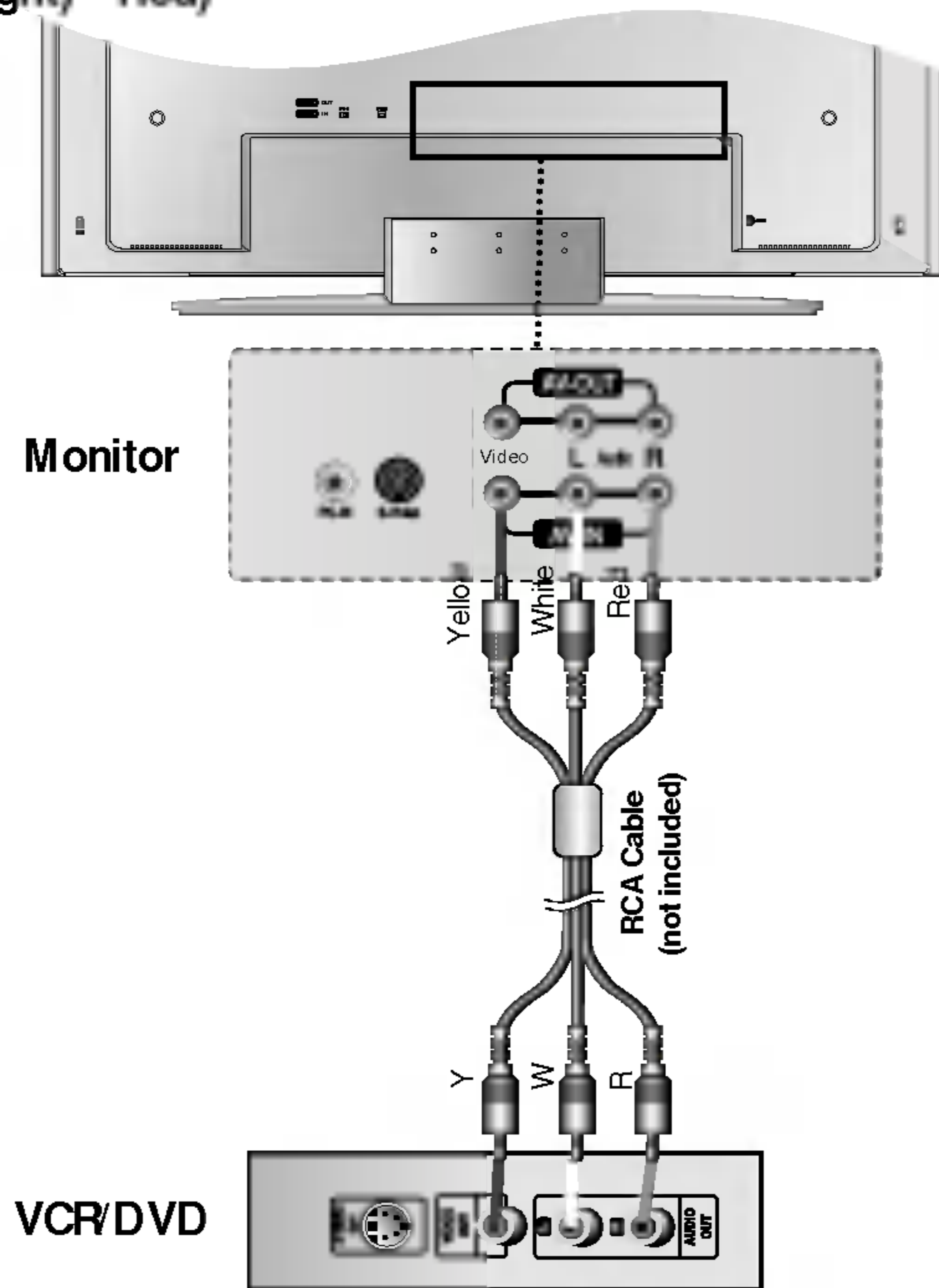

B When connecting with an S-Video cable.

- Connect to the S-Video input terminal to watch high image quality movies.

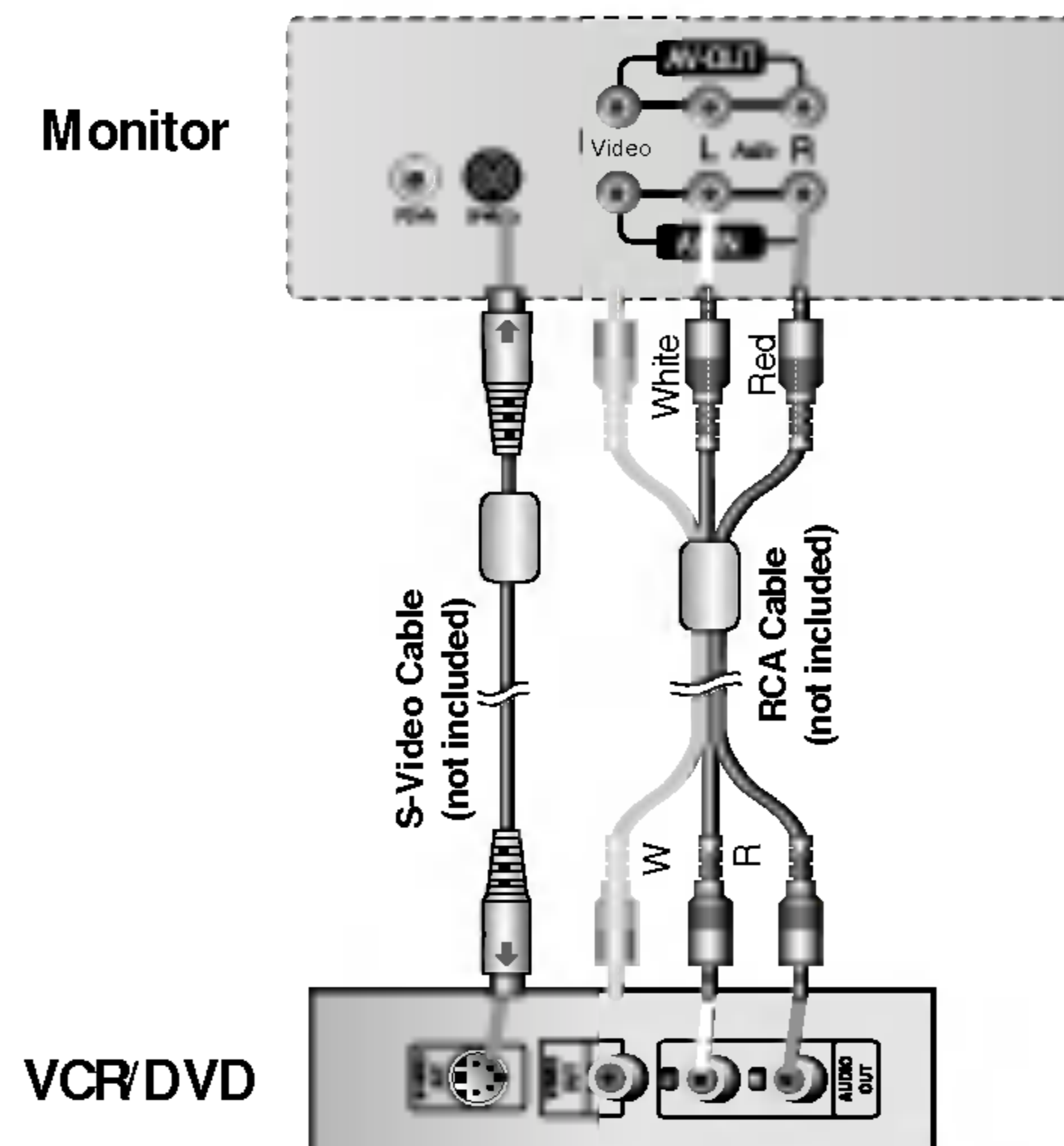

C When connecting with a SCART cable.

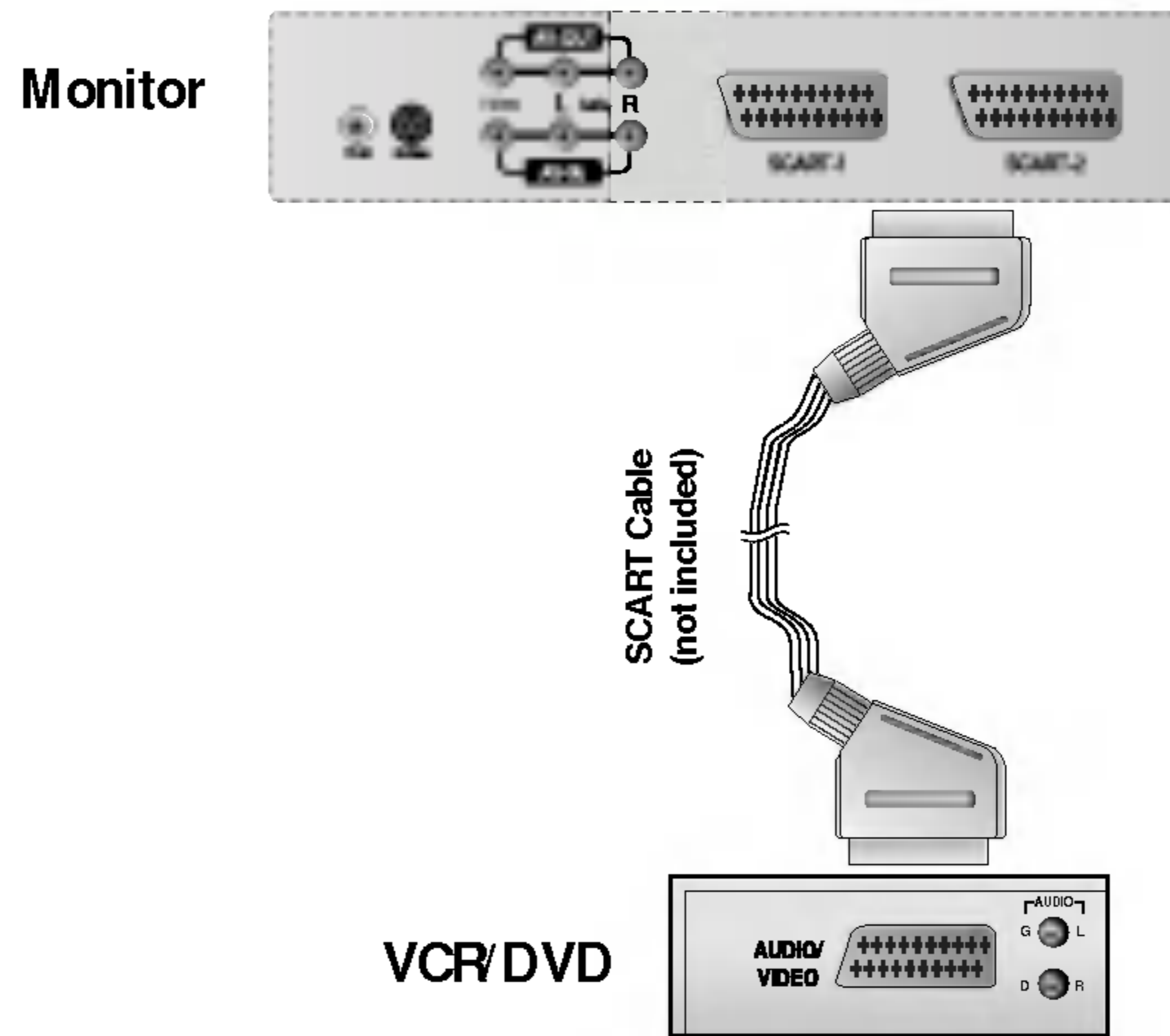

2 Select an input signal.
Press the Input Select button on the remote controller to select the input signal. Or, press the SOURCE button at the front side of the monitor.

SOURCE → ▼▲ → **SET**

- A** When connecting with an RCA cable.
 - Select VIDEO 1 (CVBS)
- B** When connecting with an S-Video cable.
 - Select VIDEO 2 (S-Video)
- C** When connecting with a SCART cable.
 - Select SCART 1 / SCART 2

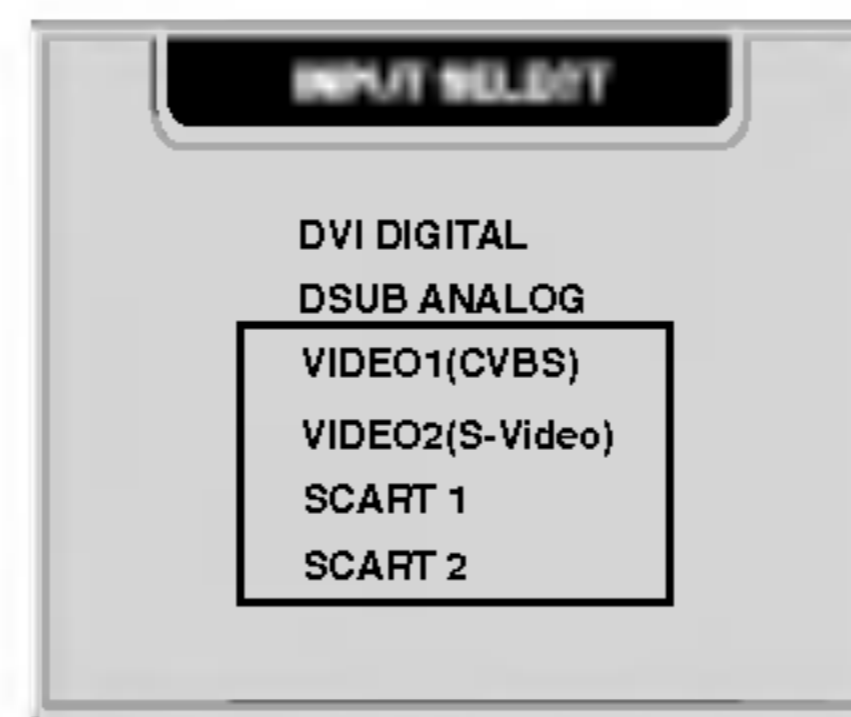

[Case 1]



Note

• Since the **SCART1** terminal supports the component (RGB), connect to the **SCART1** terminal if the component (RGB) function is supported by the DVD player.

Connecting the DVD/HDTV

- 1** Connect the video/audio cable as shown in the below figure and then, connect the power cord (See page A11).
 - Connect the input terminal with a proper color match.
 - Select the terminal that can be connected most easily among COMP-1 and COMP-2.

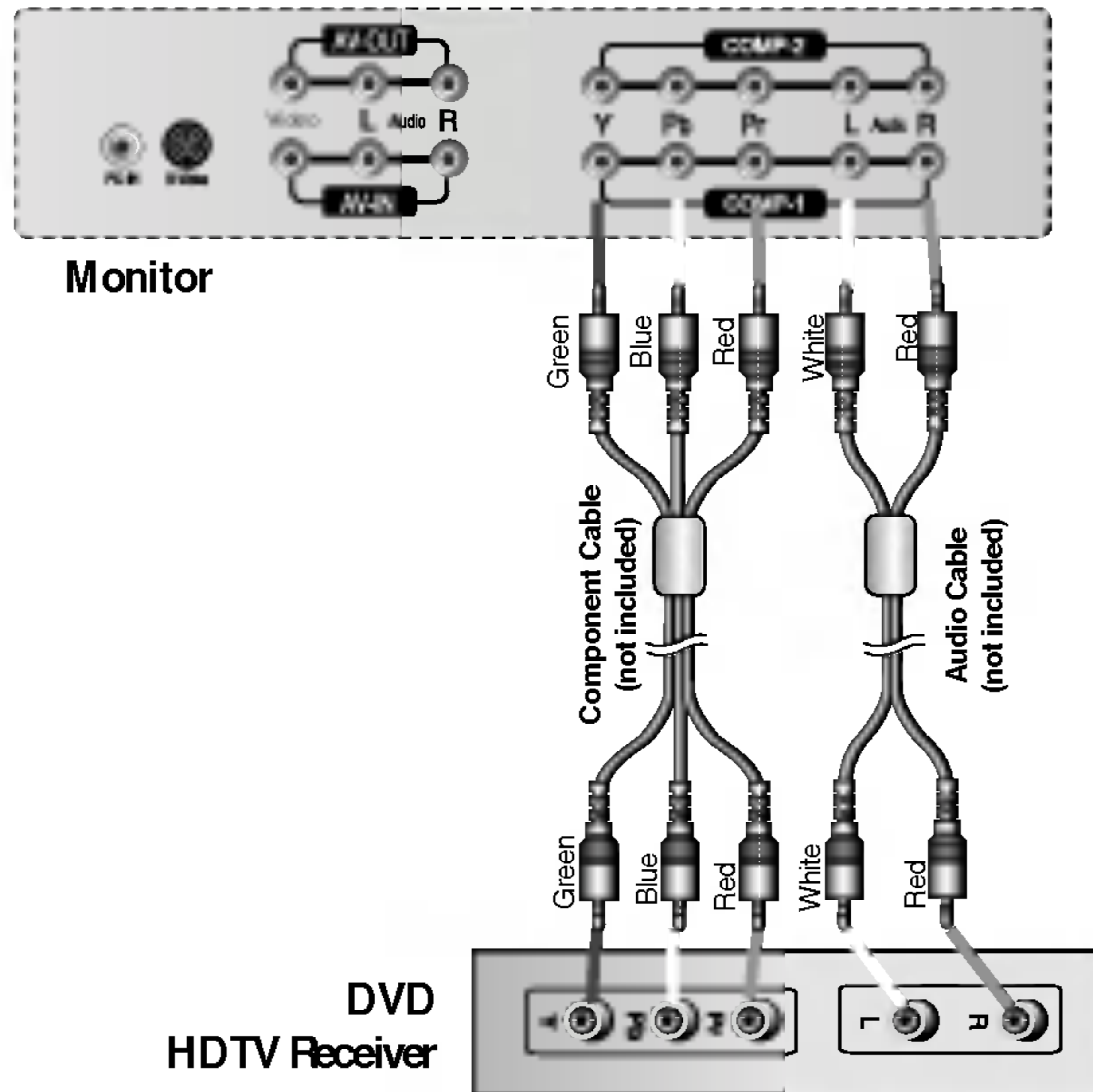

- 2** Select an input signal.
 Press the Input Select button on the remote controller to select the input signal. Or, press the SOURCE button at the front side of the monitor.

SOURCE → ▼▲ → **SET**

When connecting with a Component/audio cable.

- Select COMPONENT 1 / COMPONENT 2

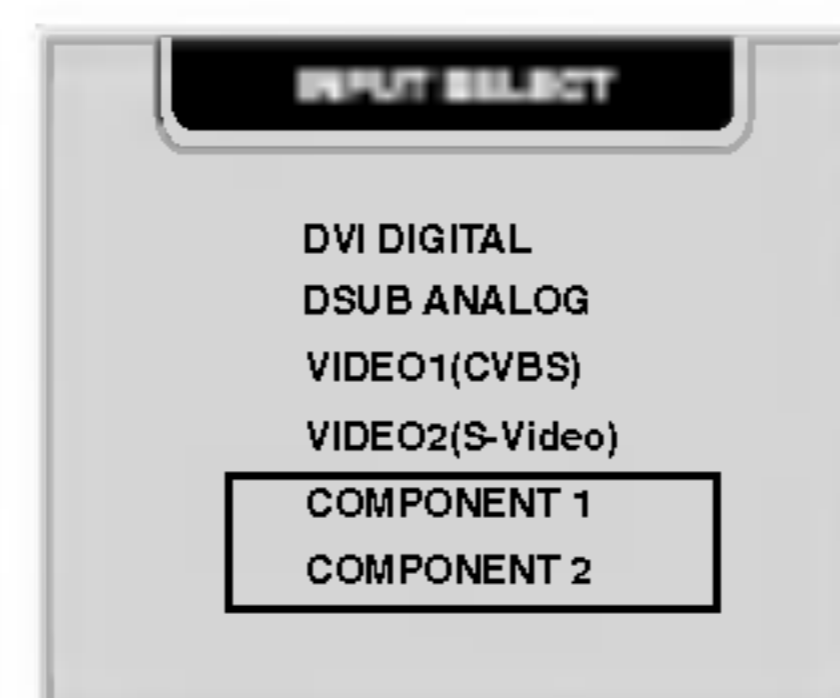

[Case 2]

Connecting AV Outputs

Connect to the external device if you record the broadcasting.

- When you set the input signal of the main screen as 'VIDEO1 (CVBS)', you can transmit the signal that you're watching to the AV output terminal.

ENGLISH

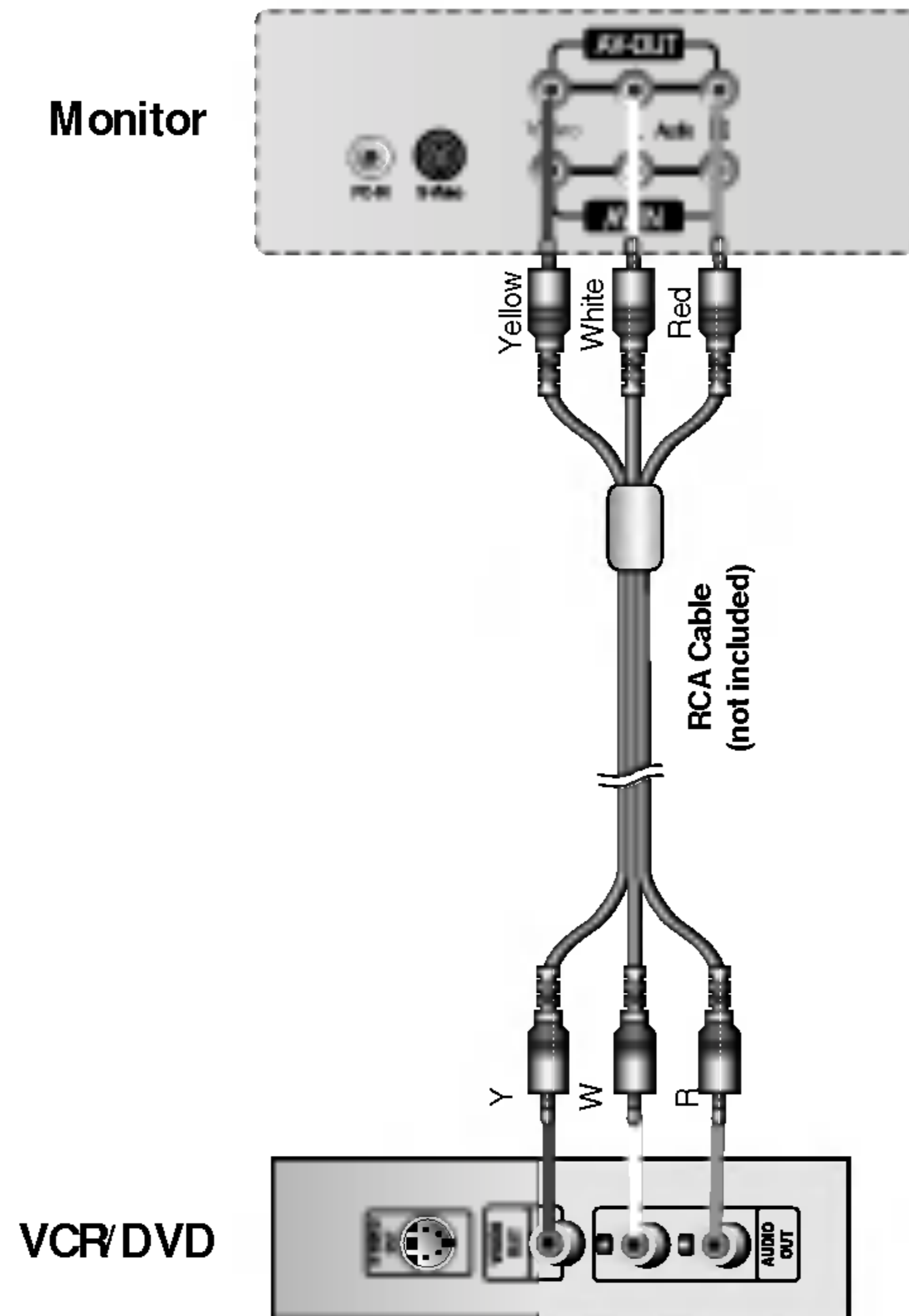

Selecting and Adjusting the Screen

Name of the Buttons in the Screen Adjustment Unit

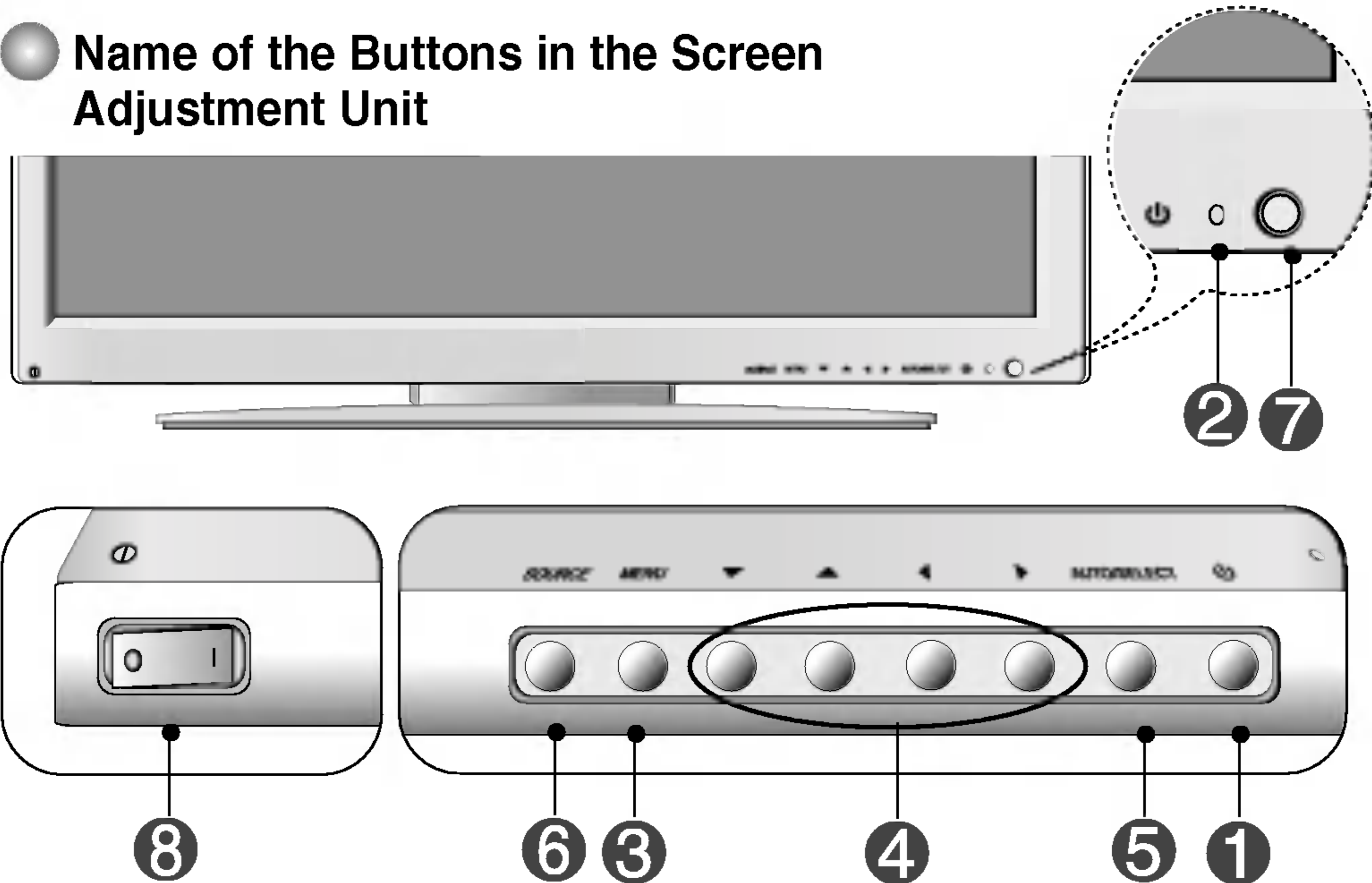

1 **Power Button** • Press the button to turn on the power. Press the button again to turn it off.

2 **Power LED** • This Indicator lights up green when the display operates normally. If the display is in DPM (Energy Saving) mode, this indicator color changes to amber.

3 **MENU Button** • Use this button to show/hide the OSD (On Screen Display) menu screen.

4 **OSD Select Adjust Button** • Use the button to select an icon or adjust the setting in the OSD screen.

▼▲ • Use this button to directly control brightness and contrast of the PC signal (DSUB/DVI).

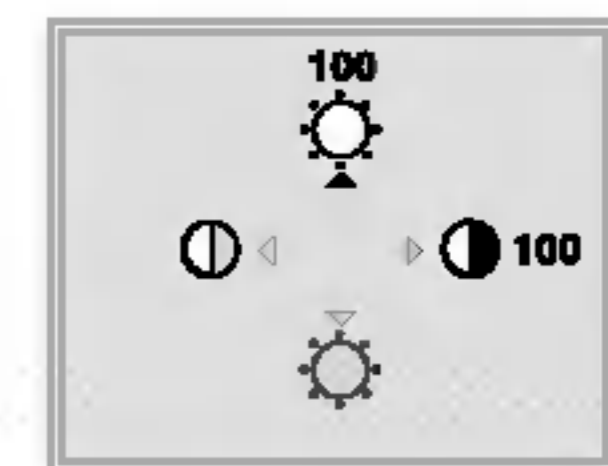

◀▶ • Adjust the volume.



● Name of the Buttons in the Screen Adjustment Unit

5

AUTO/SELECT Button

[A] For DSUB signal

- Select the icon to adjust on the OSD screen.
- If you press the [AUTO/SELECT] button, automatic screen adjustment will be started.

AUTO IN PROGRESS

[B] Other signals than DSUB

- The current signal and mode information will be displayed.

6

SOURCE Button

SOURCE → ▼▲ → AUTO/SELECT

- Select the input signal

DVI DIGITAL	DVI digital signal
DSUB ANALOG	15-pin D-Sub analog signal
VIDEO1(CVBS)	Composite video
VIDEO2(S-Video)	S-Video
SCART 1/2	Composite
COMPONENT 1/ 2	YPbPr (YCbCr)



[Case 1]

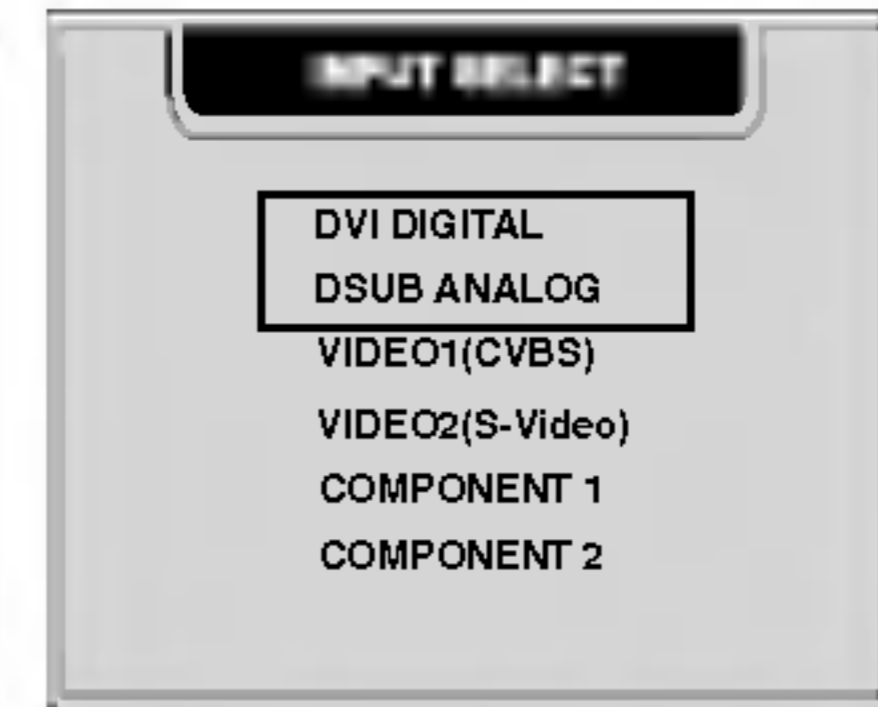

[Case 2]

7

- The unit that receives the signal from the remote controller.

8

Main Power Switch

- Use this button to turn on/off the monitor.

OSD Lock/Unlock Button

Menu button + ►

- Use this button to lock/unlock OSD screen adjustment.
(Activated when pressed together longer than 5 seconds.)

CONTROLS LOCKED





- OSD is locked

CONTROLS UNLOCKED





- OSD is unlocked.

Selecting and Adjusting the Screen

● OSD Menu – When Connected to Your PC

Icon	Function Description
 Adjustment	Adjusts screen brightness, contrast and color that you prefer.
 Tracking	Adjusts position of the screen, clock or phase.
 Audio	Adjusts the audio function.
 Setup	Adjusts the screen status according to the circumstances.
 PIP/POP/PBP	Adjusts PIP/POP/PBP mode function.

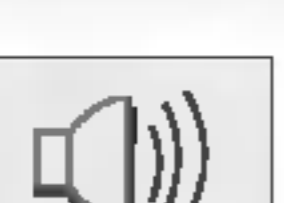
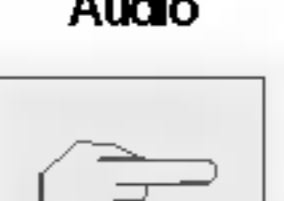
● OSD Menu – When Watching Video/DVD/HDTV

Icon	Function Description
 Channel Setup	Sets/Selects the channel. (available only when watching TV)
 Video	Adjusts the screen video.
 Audio	Adjusts the audio function.
 Setup	Adjusts the screen status according to the circumstances.
 PIP/POP/PBP	Adjusts PIP/POP/PBP mode function.



Note

OSD(On Screen Display)

The OSD function enables you to adjust the screen status conveniently since it provides graphical presentation.

● How to adjust the OSD (On Screen Display) screen

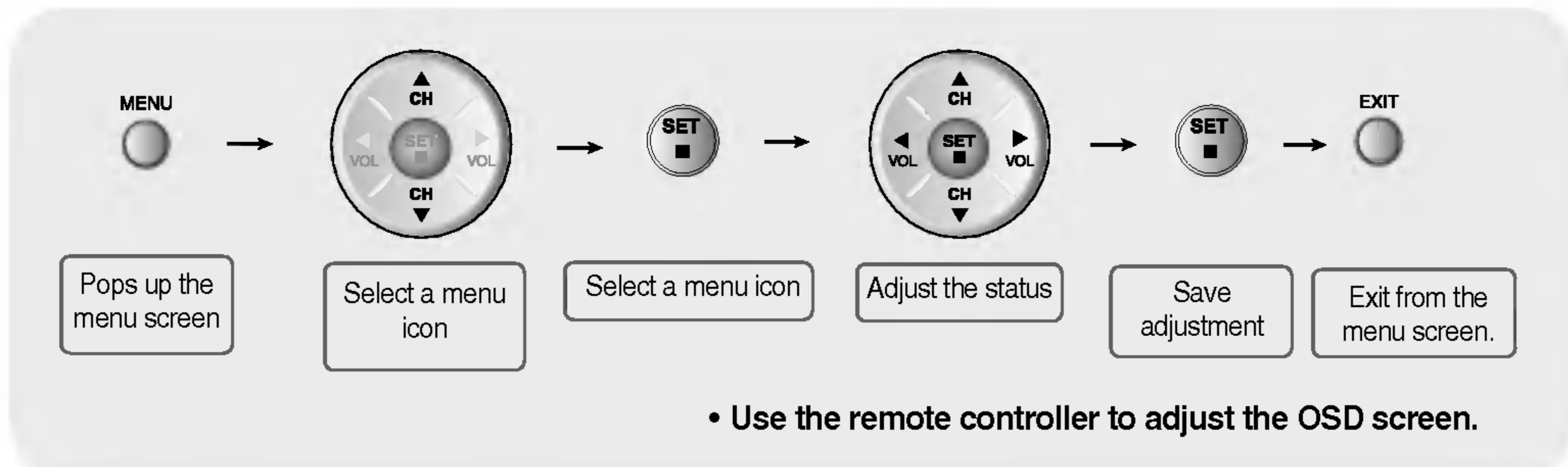

1 Press the **MENU** Button, then the main menu of the OSD appears.

2 To access a control, use the ▼ ▲ Buttons.

3 When the icon you want becomes highlighted, press the **SET** Button.

4 Use the ▼ ▲ ◀ ▶ Buttons to adjust the item to the desired level.

5 Accept the changes by pressing the **SET** Button.

6 Exit the OSD by Pressing the **EXIT** Button.

● How to adjust the screen automatically

You need to adjust the screen display when connecting the monitor to a new computer or changing the mode. Refer to the following section to set an optimal monitor screen.

AUTO IN PROGRESS

Press the **AUTO/SELECT** button (**AUTO** button in a remote controller) in the PC analog signal. Then, an optimal screen status will be selected that fits into the current mode.

If adjustment is not satisfactory, you need to adjust screen position, clock and phase in the OSD menu.

Selecting and Adjusting the Screen

OSD Menu – When Connected to Your PC

Adjusting Screen Color

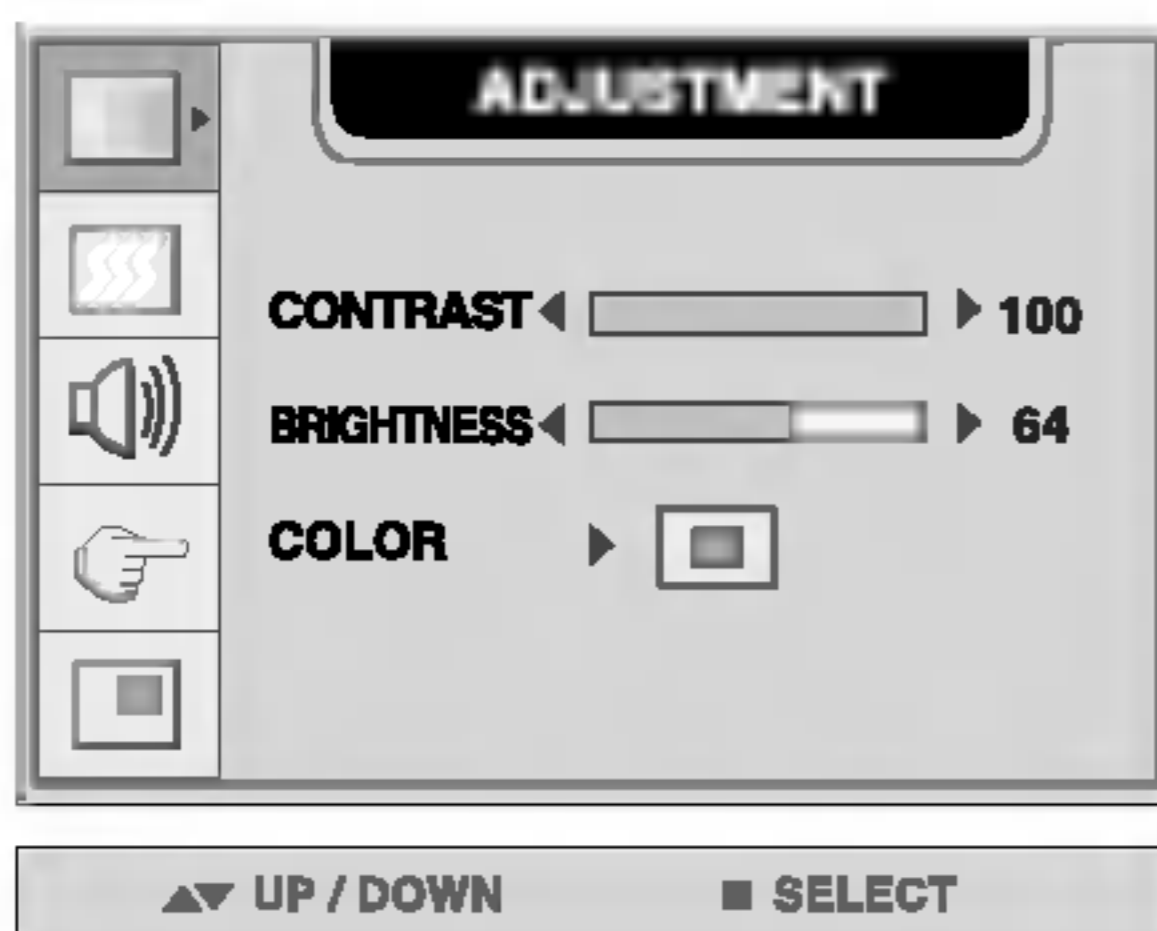

CONTRAST To adjust the contrast of the screen.

BRIGHTNESS To adjust the brightness of the screen.

COLOR Adjusting screen color. Press the ► button to display the submenu for COLOR.



USER 9300K/6500K
Selecting a factory setting color set.
• 9300K: Slightly bluish white.
• 6500K: Slightly reddish white.

RED GREEN BLUE
Set your own color levels.

Adjusting Screen CLOCK/PHASE and Position

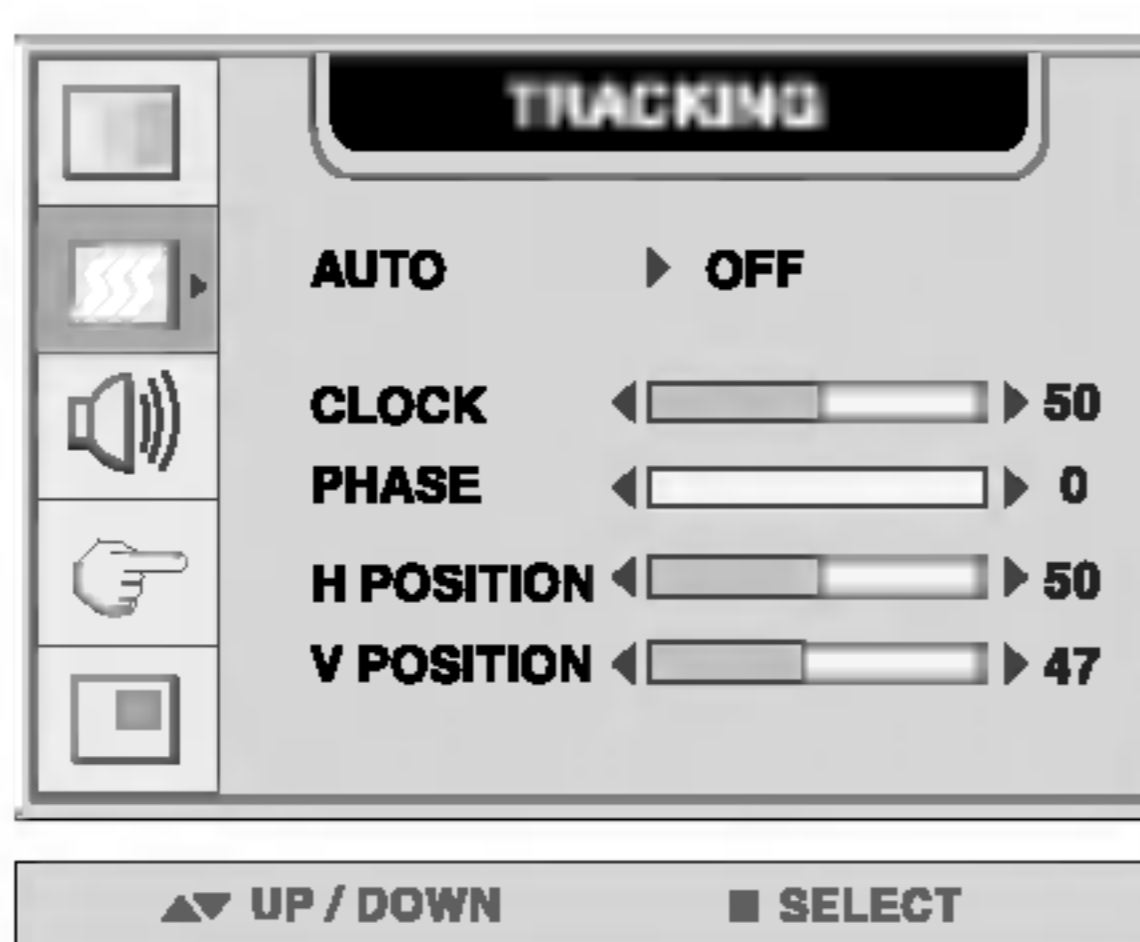

AUTO This function is suitable for analog signal input only. This button is for the automatic adjustment of the screen position, clock and phase.

CLOCK To minimize any vertical bars or stripes visible on the screen background. The horizontal screen size will also change.

PHASE To adjust the focus of the display. This item allows you to remove any horizontal noise and clear or sharpen the image of characters.

H POSITION To move image left or right.

V POSITION To move image up or down.



Note

When connected to your computer and the digital input signal (DVI-DIGITAL), only ADJUSTMENT, AUDIO, SETUP and PIP/POP/PBP menu are enabled. Other menu items will be automatically adjusted.



Adjusting the audio function



SSM

The best sound tone quality will be selected automatically depending on the video type that you're currently watching.

- **USER** : Select this option to use the user-defined audio settings.
- **FLAT** : The most commanding and natural audio.
- **MOVIE** : Select this option to enjoy sublime sound.
- **MUSIC** : Select this option to enjoy the original sound when listening to the music.
- **SPORTS** : Select this option to watch sports broadcasting.

AVL

To adjust uneven sound volumes across all channels or signals automatically to the most appropriate level. To use this feature, select ON.

MUTE

Used to select mute ON(means sound off) and mute OFF(means sound on).

SRS WOW

Set the SRS WOW menu on.
The SRS WOW function plays back the mono or stereo sound input with the dynamic surround effects. It will provide rich and profound sound tone. If you set the SRS WOW on, bass/treble will be automatically adjusted.

BALANCE Use this function to balance sound from the left and right speakers.

BASS To raises or lowers Bass level.

TREBLE To raises or lowers Treble level.



Note

When connected to your computer and the 'SSM' setting in the audio menu is one of FLAT, MOVIE, MUSIC or SPORTS, the available menus are AVL, MUTE and BALANCE.

Selecting and Adjusting the Screen



Selecting the Options

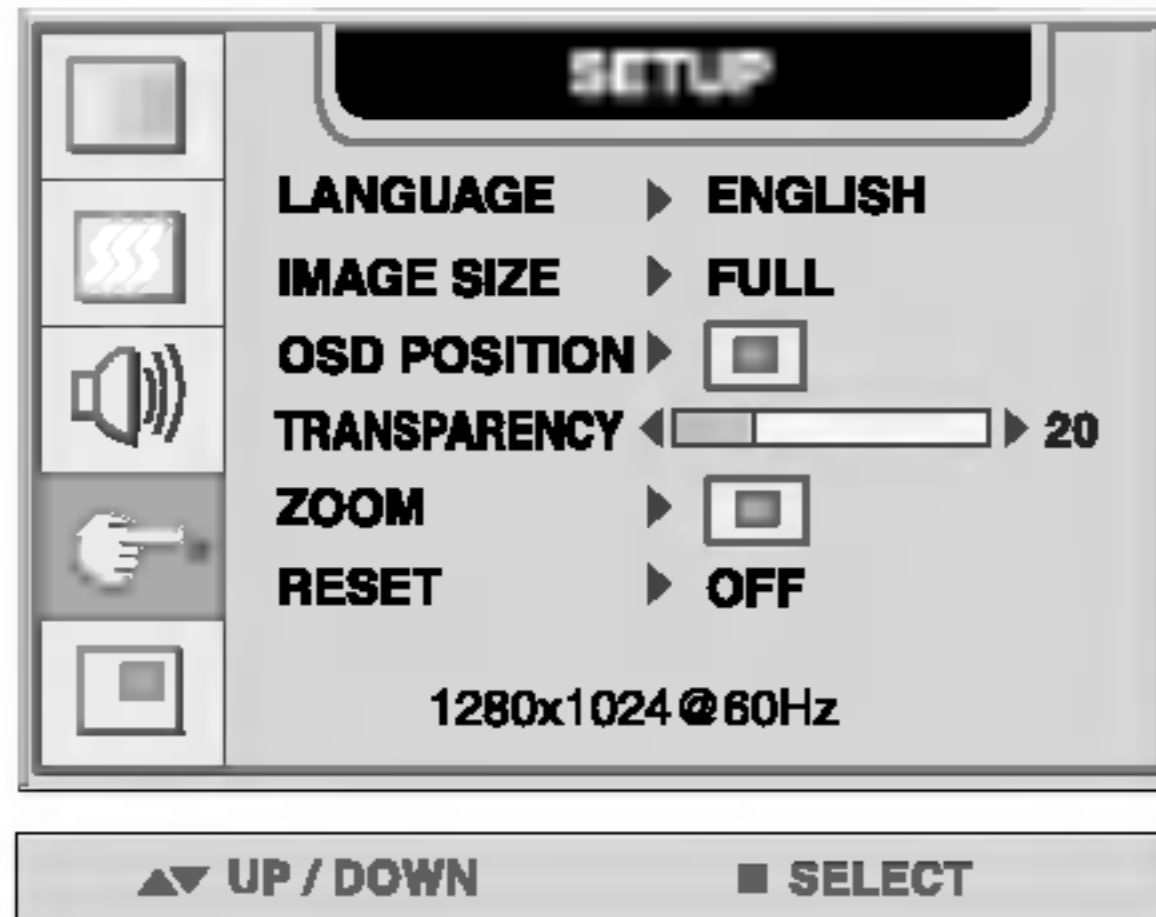

LANGUAGE To choose the language in which the control names are displayed.

IMAGE SIZE To select the image size of the screen. (FULL/1:1)

OSD POSITION To adjust position of the OSD window on the screen. Press the ► button to display the submenu for OSD POSITION.

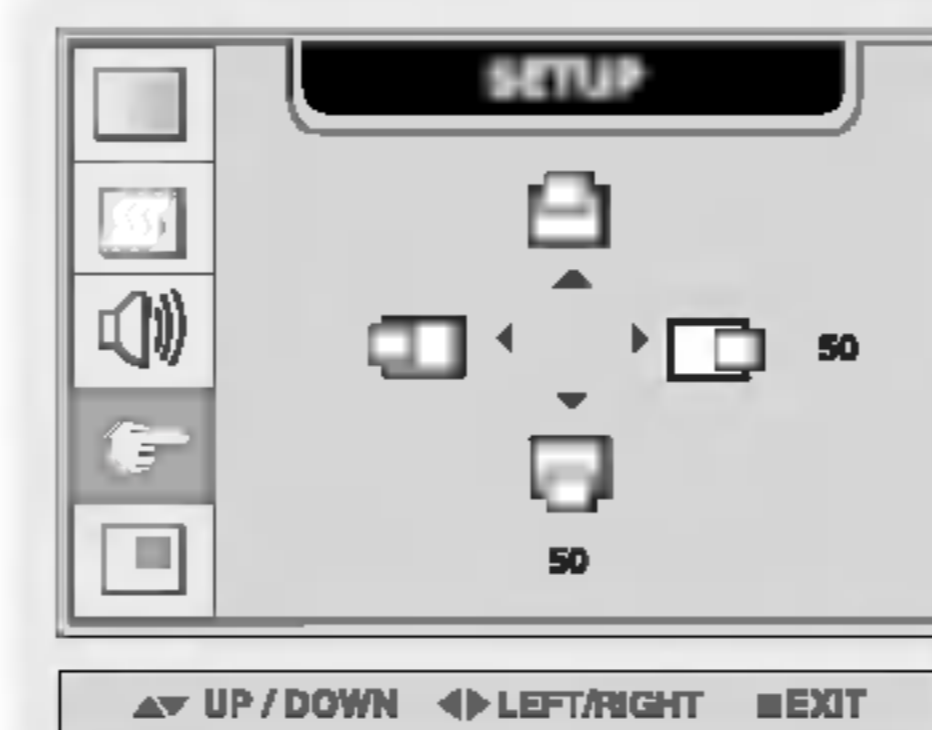

◀ Left
▶ Right Moving the OSD screen position horizontally.

▲ Up
▼ Down Moving the OSD screen position vertically.

TRANSPARENCY To adjust the transparency of the OSD menu screen.

ZOOM Use this function to zoom in the screen. When you turn the monitor off and on again, the default screen size will be restored. Press the ► button to display the submenu for OSD POSITION.

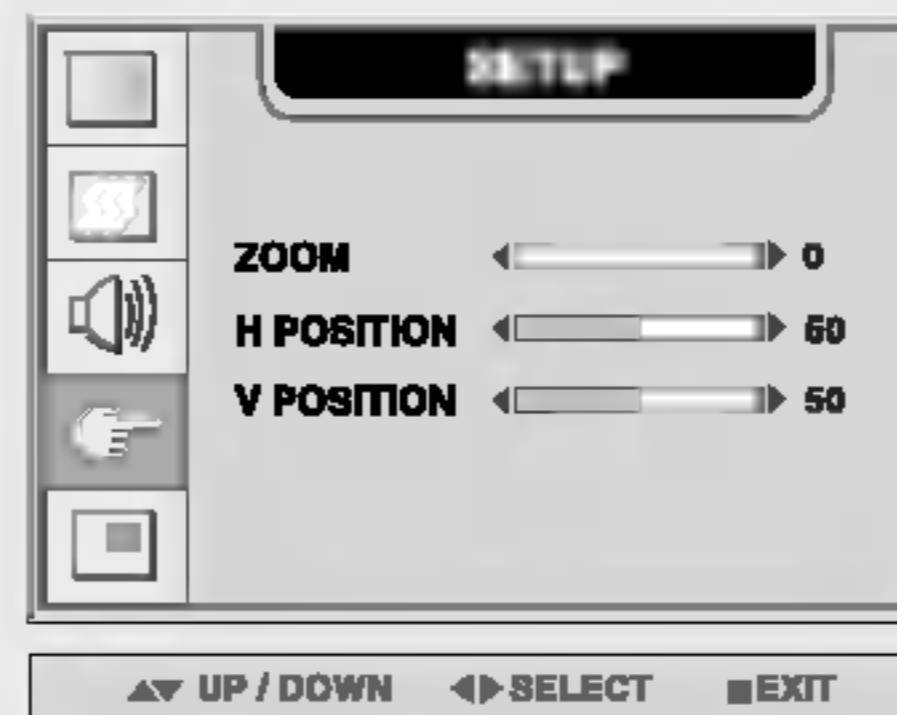

* If the zooming value is set to '0', vertical and horizontal positioning cannot be adjusted.

RESET Use this function to reset the monitor to the factory default. However, language selection will not be initialized.



Note

When connected to your computer, the **Zoom** menu will be disabled if the screen size is 1:1 or PIP/POP/PBP is in use.

Adjusting PIP/POP/PBP Mode (Multiple Screen) Functions

To adjust the PIP(PICTURE IN PICTURE) of the screen

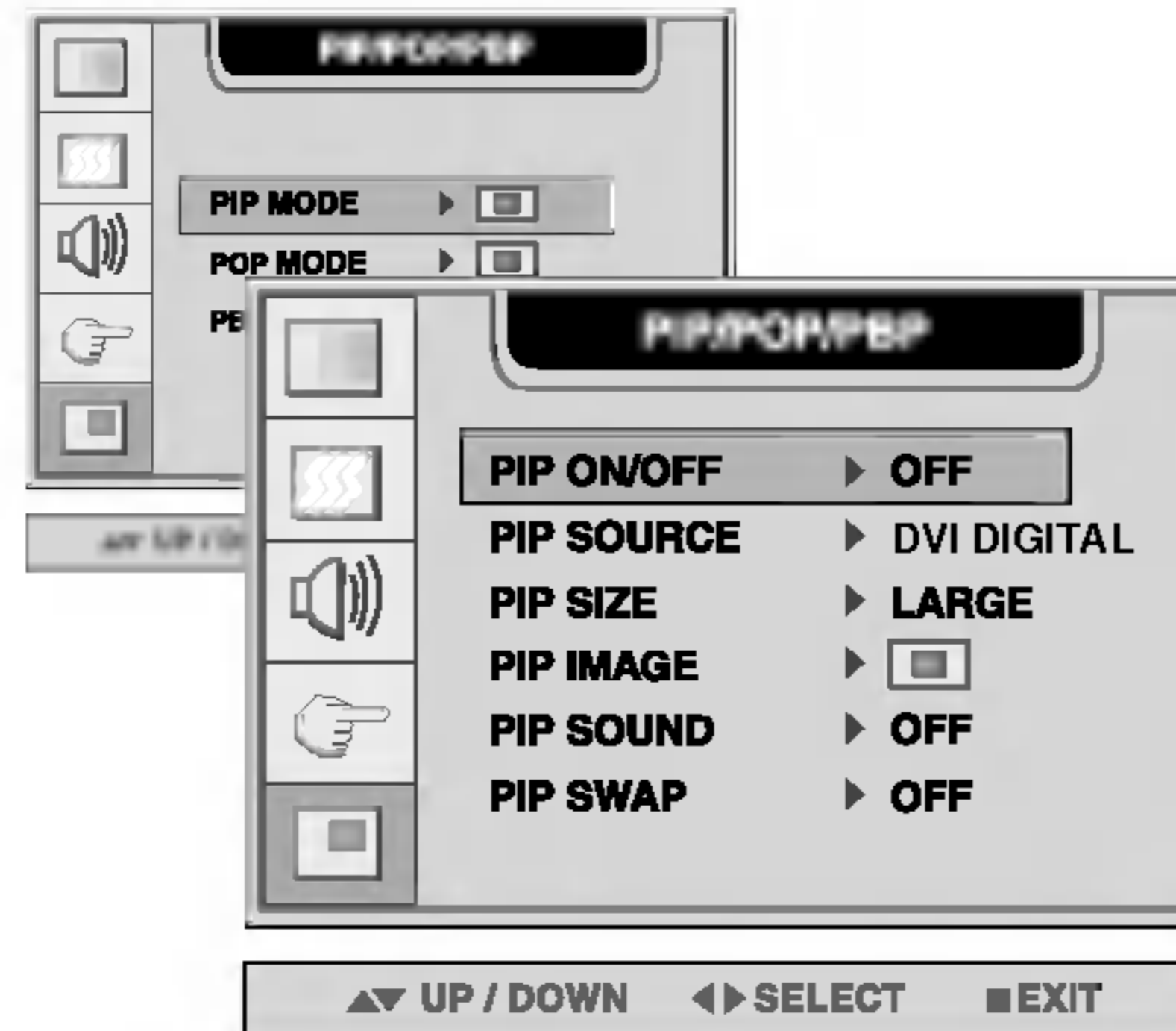

PIP ON/OFF After selecting ON in the PIP ON/OFF menu, the following menu items can be adjusted.



PIP SOURCE To select an input signal for PIP.

PIP SIZE To adjust the size of the PIP screen. (SMALL/LARGE)

PIP IMAGE To adjust the image of the PIP screen; Press the ► button to display the submenu for PIP IMAGE. Use the ◀ ▶ buttons to adjust the item to the desired level. The items of the sub-menu may vary depending on the type of the source.



- PIP POSITION Adjust the PIP screen position.
- PIP CONTRAST Adjust PIP screen contrast.
- PIP BRIGHTNESS Adjust PIP screen brightness.
- PIP COLOR Adjust the PIP screen color.
- PIP TINT To adjust the tint to desired level. This function is available only in NTSC broadcasting mode.

* The sub-menu can differ according to the type of the input signal.

PIP SOUND To turn the PIP sound on/off.

PIP SWAP To switch the main-screen and sub-screen in PIP mode.

Selecting and Adjusting the Screen



Adjusting PIP/POP/PBP Mode (Multiple Screen) Functions

To adjust the POP(PICTURE OUT PICTURE) of the screen

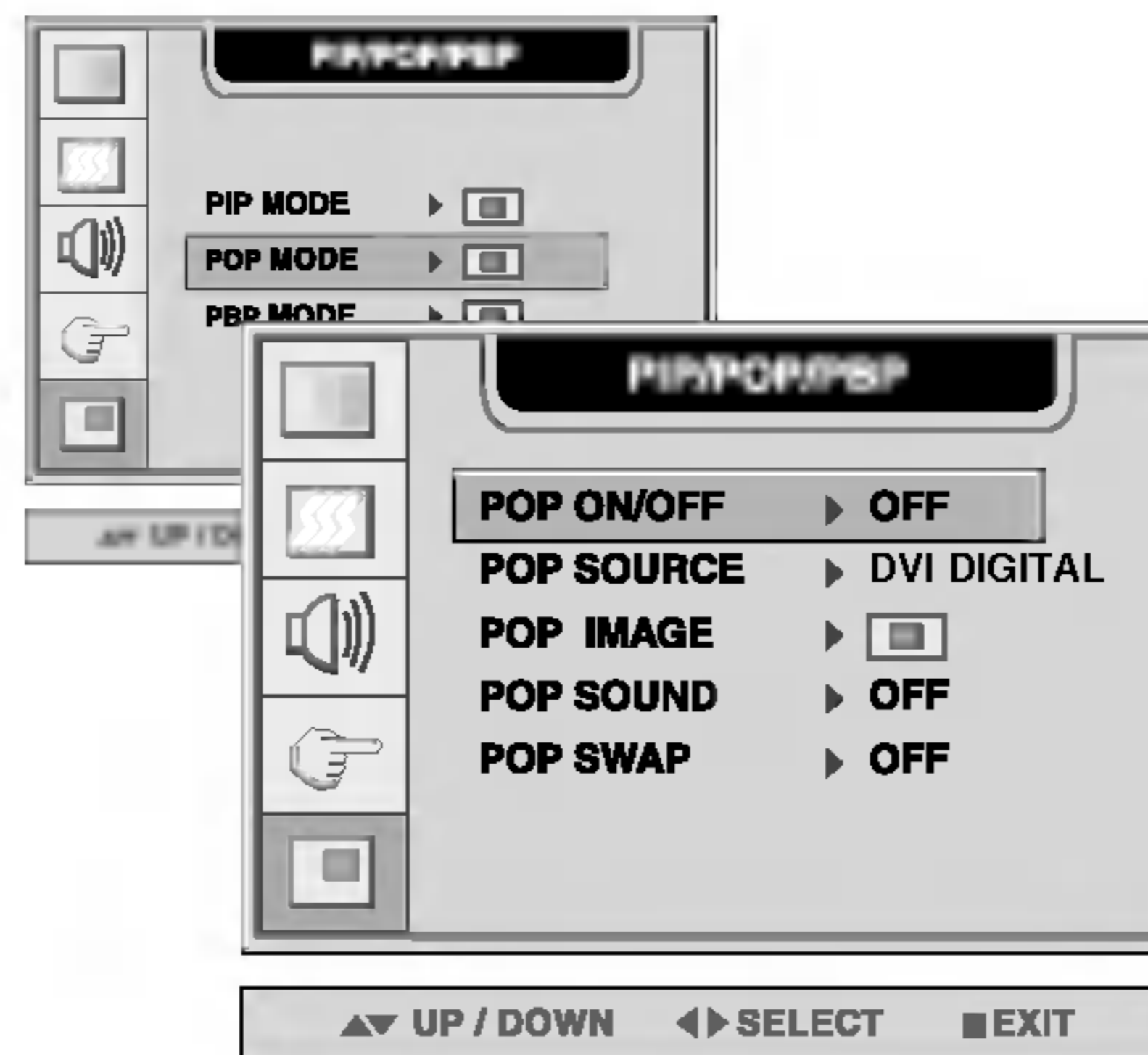

POP ON/OFF After selecting ON in the POP ON/OFF menu, the following menu items can be adjusted.

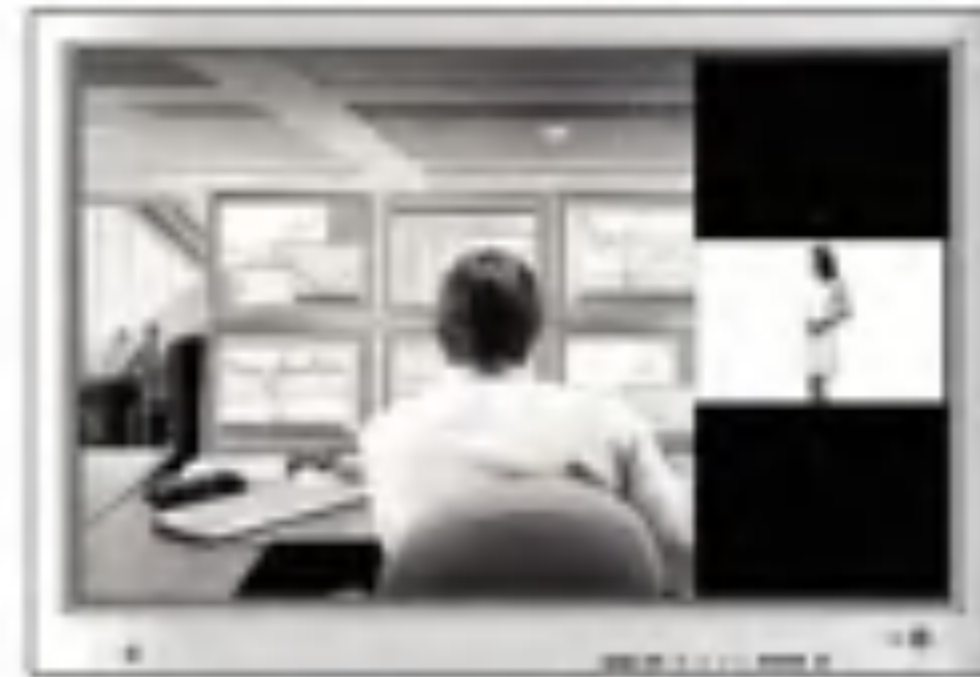

POP SOURCE To select an input signal for POP.

POP IMAGE To adjust the image of the POP screen; Press the ► button to display the submenu for POP IMAGE. Use the ◀ ► buttons to adjust the item to the desired level.

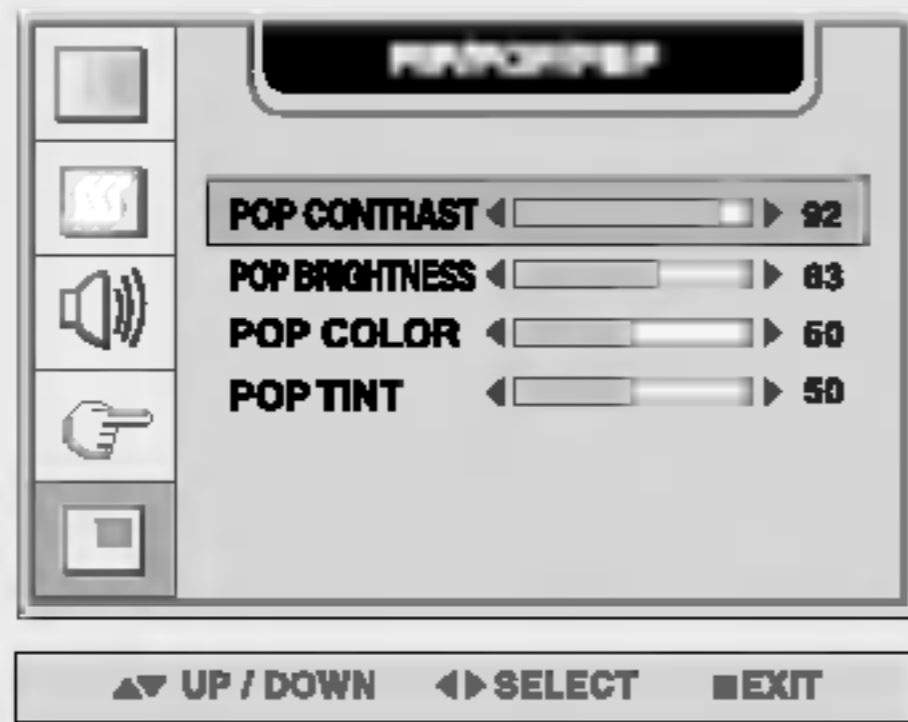

■ POP CONTRAST	Adjust POP screen contrast.
■ POP BRIGHTNESS	Adjust POP screen brightness.
■ POP COLOR	Adjust the POP screen color.
■ POP TINT	To adjust the tint to desired level. This function is available only in NTSC broadcasting mode.

* The sub-menu can differ according to the type of the input signal.

POP SOUND To turn the POP sound on/off.

POP SWAP To switch the main-screen and sub-screen in POP mode.



Note

The 'POP IMAGE' menu will be disabled if the POP screen input is a PC signal.

Adjusting PIP/POP/PBP Mode (Multiple Screen) Functions

To adjust the PBP(PICTURE BY PICTURE) of the screen

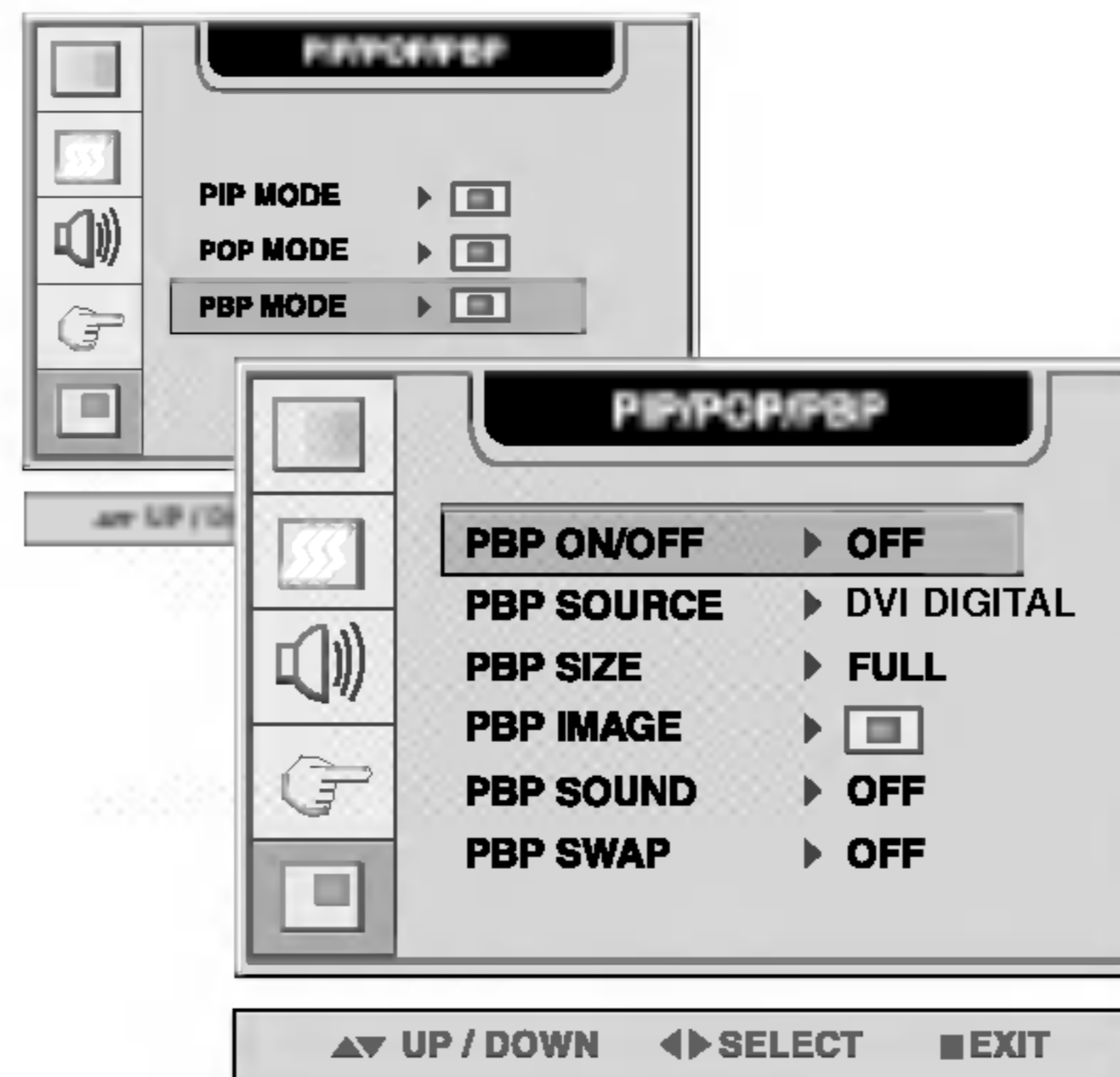

PBP ON/OFF After selecting ON in the PBP ON/OFF menu, the following menu items can be adjusted.



PBP SOURCE To select an input signal for PBP.

PBP SIZE To adjust the size of the PBP screen. (FULL/4:3)

PBP IMAGE To adjust the image of the PBP screen; Press the ► button to display the submenu for PBP IMAGE. Use the ◀ ▶ buttons to adjust the item to the desired level. The items of the sub-menu may vary depending on the type of the source.

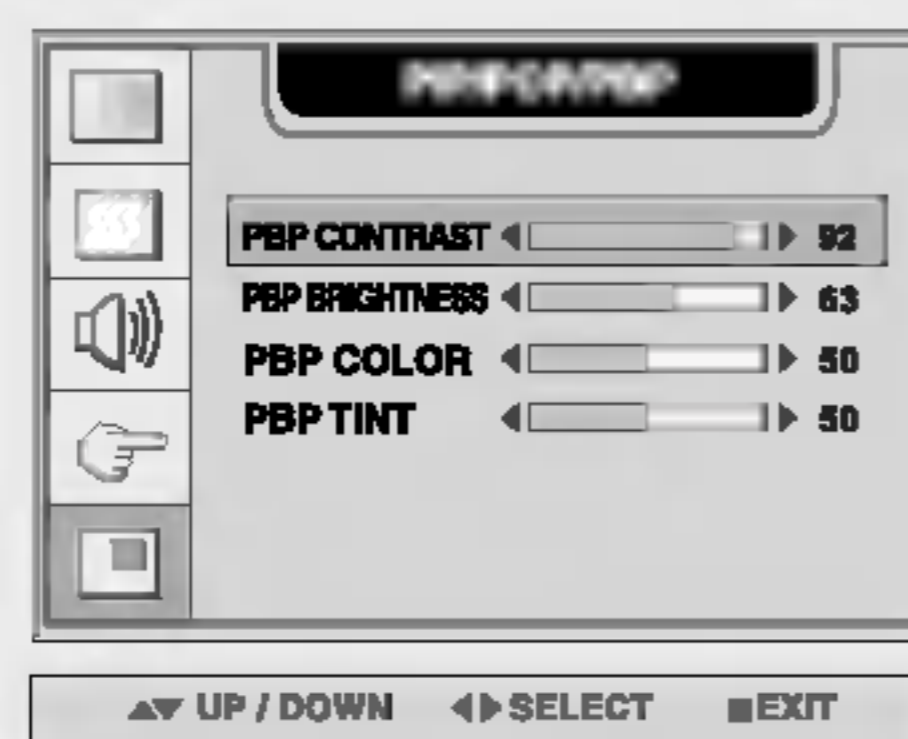

- **PBP CONTRAST** Adjust PBP screen contrast.
- **PBP BRIGHTNESS** Adjust PBP screen brightness.
- **PBP COLOR** Adjust the PBP screen color.
- **PBP TINT** To adjust the tint to desired level.
This function is available only in NTSC broadcasting mode.

* The sub-menu can differ according to the type of the input signal.

PBP SOUND To turn the PBP sound on/off.

PBP SWAP To switch the main-screen and sub-screen in PBP mode.



Note

The 'PBP IMAGE' menu will be disabled if the PBP screen input is a PC signal.

Selecting and Adjusting the Screen

OSD Menu – When Watching VCR/DVD/HDTV

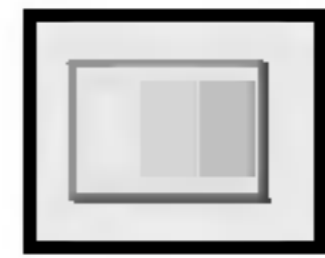

Adjusting Screen Image



PSM

The PSM function automatically adjusts the screen image quality depending on the AV usage environment.

- **USER** : Select this option to use the user-defined settings.
- **GAME** : Select this option to enjoy dynamic image when playing a game.
- **STANDARD** : The most general and natural screen display status.
- **DYNAMIC** : Select this option to display with a sharp image.
- **MILD** : Select this option to display with a mild image.

CONTRAST To adjust the contrast of the screen.

BRIGHTNESS To adjust the brightness of the screen.

SHARPNESS To adjust the clearness of the screen.

COLOR To adjust the color to desired level.

TINT To adjust the tint to desired level. This function is available only in NTSC broadcasting mode.



Note

If the 'PSM' setting in the Video menu is set to GAME, STANDARD, DYNAMIC or MILD the subsequent menus will be automatically set.



Adjusting the audio function

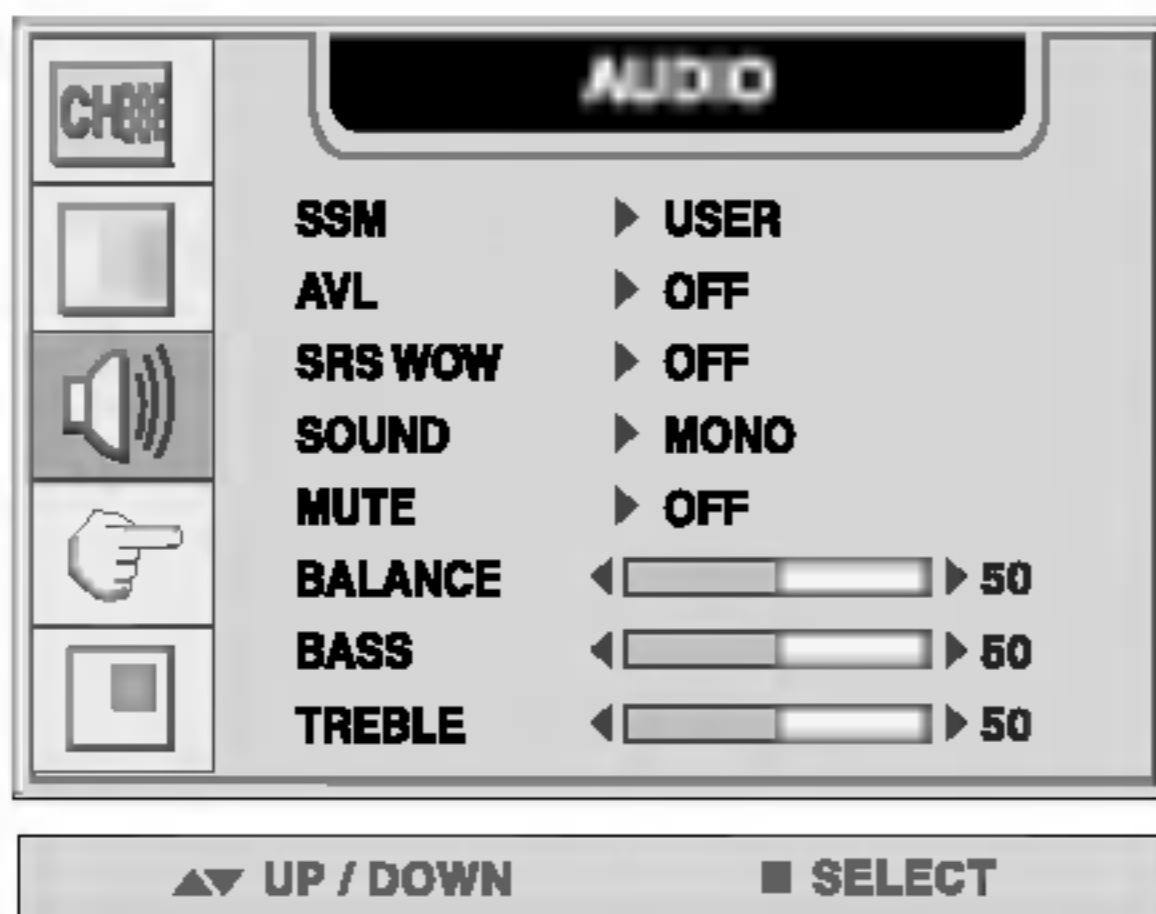

SSM

The best sound tone quality will be selected automatically depending on the video type that you're currently watching.

- **USER** : Select this option to use the user-defined audio settings.
- **FLAT** : The most commanding and natural audio.
- **MOVIE** : Select this option to enjoy sublime sound.
- **MUSIC** : Select this option to enjoy the original sound when listening to the music.
- **SPORTS** : Select this option to watch sports broadcasting.

AVL

To adjust uneven sound volumes across all channels or signals automatically to the most appropriate level. To use this feature, select ON.

SRS WOW

Set the SRS WOW menu on. The SRS WOW function plays back the mono or stereo sound input with the dynamic surround effects. It will provide rich and profound sound tone. If you set the SRS WOW on, bass/treble will be automatically adjusted.

SOUND

To select the audio mode.
: MONO/STEREO

MUTE

Used to select mute ON(means sound off) and mute OFF(means sound on).

BALANCE

Use this function to balance sound from the left and right speakers.

BASS

To raises or lowers Bass level.

TREBLE

To raises or lowers Treble level.



Note

If the 'SSM' setting in the audio menu is one of FLAT, MOVIE, MUSIC or SPORTS, the available menus are AVL, SOUND, MUTE and BALANCE. Other menu items will be automatically adjusted.

Selecting and Adjusting the Screen



Selecting the Options

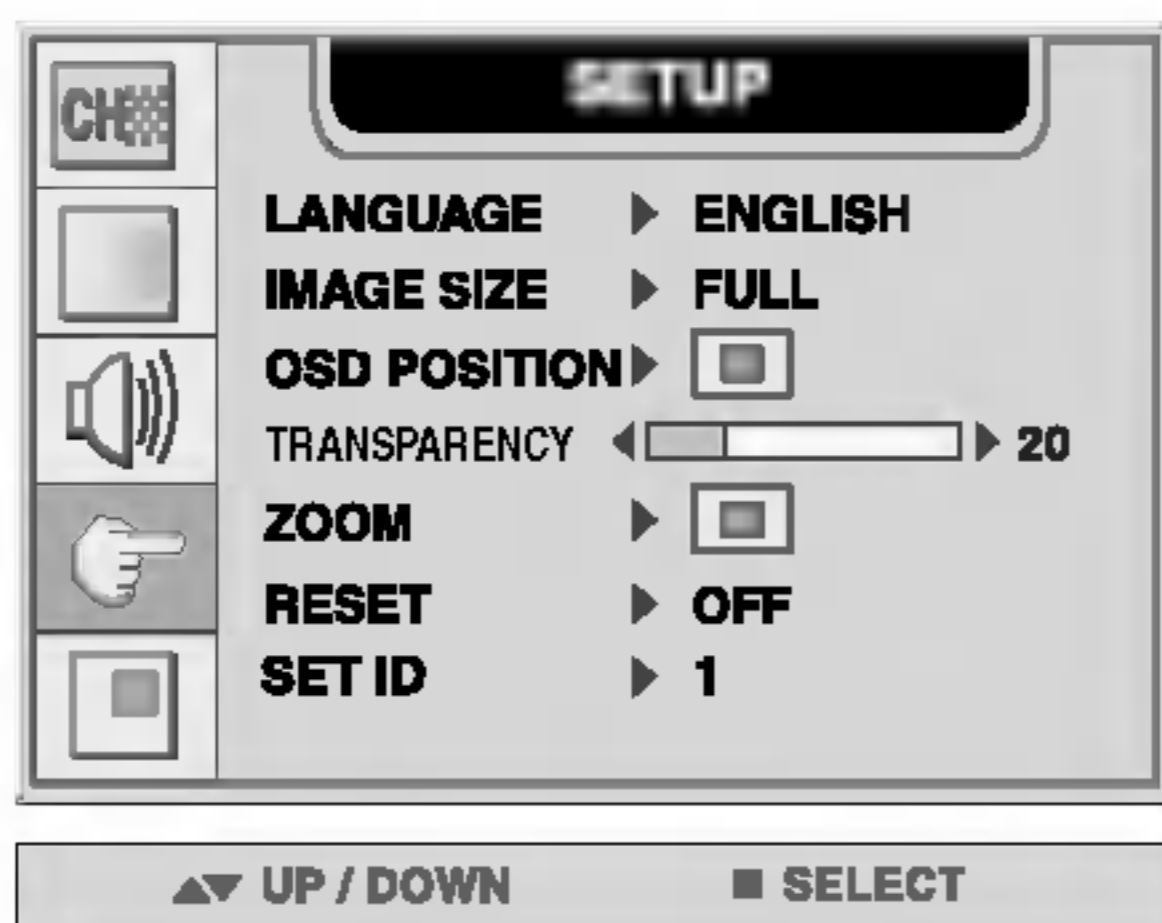

LANGUAGE To choose the language in which the control names are displayed.

IMAGE SIZE To select the image size of the screen. (FULL/4:3/SPECTACLE/1:1)

OSD POSITION To adjust position of the OSD window on the screen. Press the ► button to display the submenu for OSD POSITION.

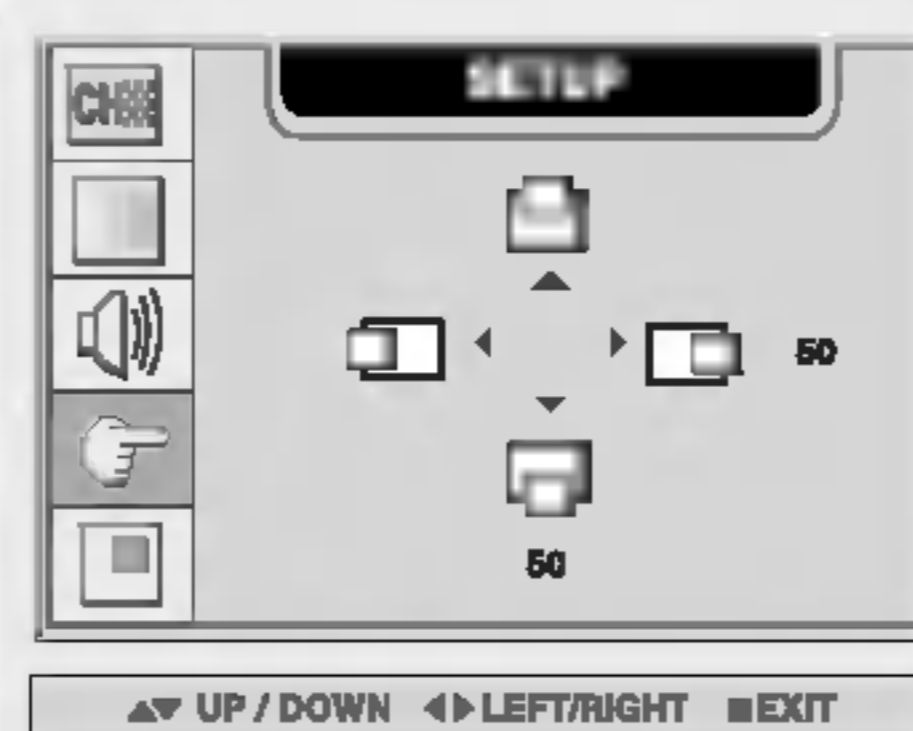

◀ Left
▶ Right Moving the OSD screen position horizontally.

▲ Up
▼ Down Moving the OSD screen position vertically.

TRANSPARENCY To adjust the transparency of the OSD menu screen.

ZOOM Use this function to zoom in the screen. When you turn the monitor off and on again, the default screen size will be restored. Press the ► button to display the submenu for OSD POSITION.

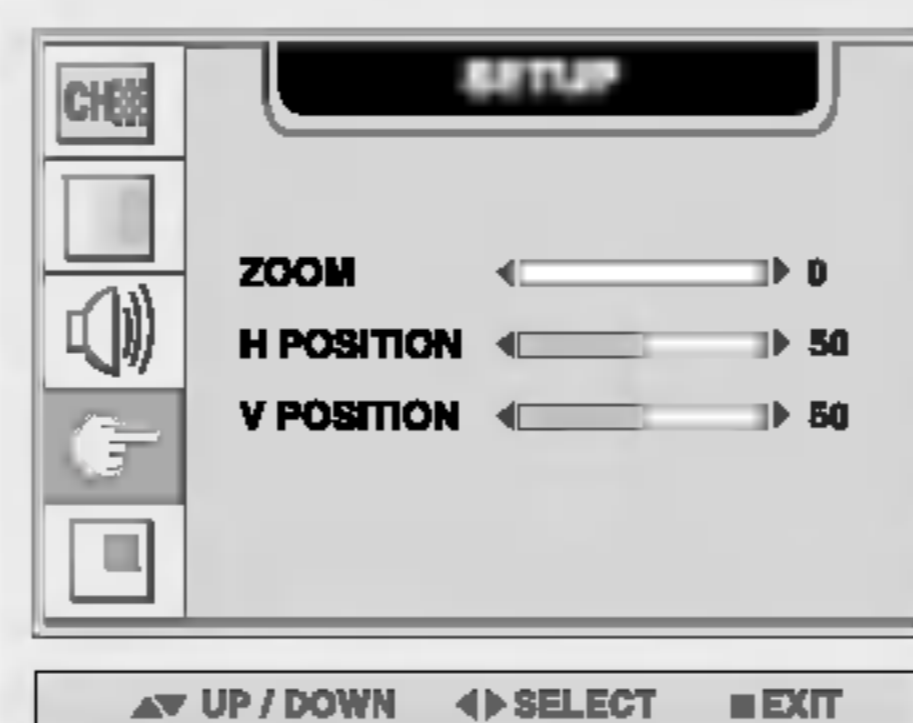

* If the zooming value is set to '0', vertical and horizontal positioning cannot be adjusted.

RESET Use this function to reset the monitor to the factory default. However, language selection will not be initialized.

SET ID You can assign a unique SET ID NO (name assignment) to each monitor when several monitors are connected for display. Specify the number (1 ~ 99) using the ◀ ▶ button and exit. Use the assigned SET ID to individually control each monitor using the Monitor Control Program.



Note

The 'ZOOM' menu will be disabled when the screen size is 4:3, spectacle or 1:1, or PIP/POP/PBP is activated.

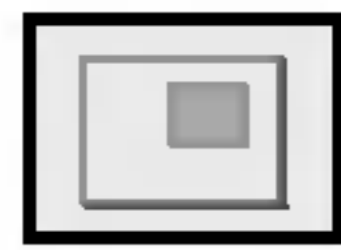

Adjusting PIP/POP/PBP Mode (Multiple Screen) Functions

To adjust the PIP(PICTURE IN PICTURE) of the screen

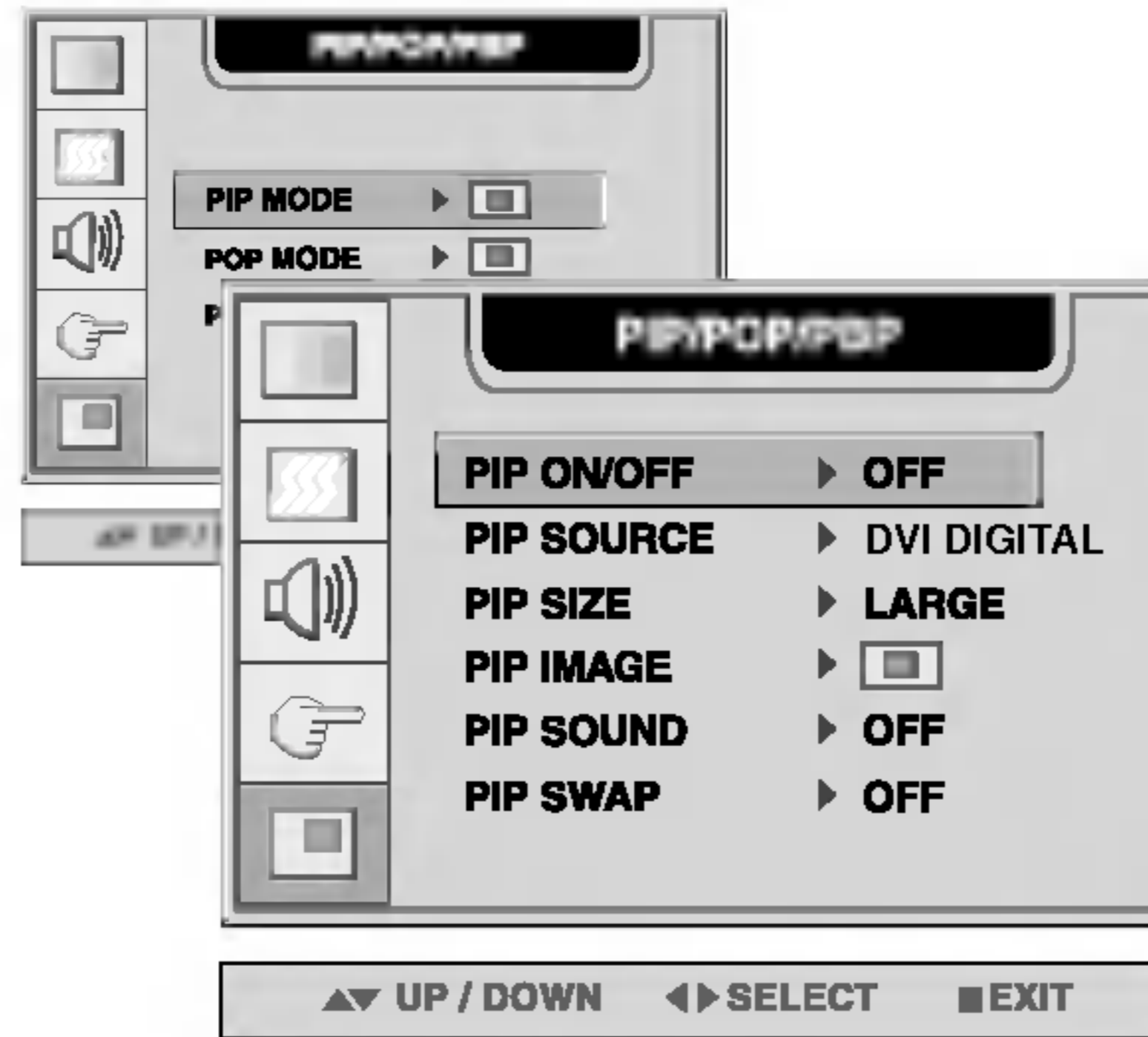

PIP ON/OFF After selecting ON in the PIP ON/OFF menu, the following menu items can be adjusted.



PIP SOURCE To select an input signal for PIP.

PIP SIZE To adjust the size of the PIP screen. (SMALL/LARGE)

PIP IMAGE To adjust the image of the PIP screen; Press the ► button to display the submenu for PIP IMAGE. Use the ◀ ▶ buttons to adjust the item to the desired level. The items of the sub-menu may vary depending on the type of the source.



- PIP POSITION Adjust the PIP screen position.
- PIP CONTRAST Adjust PIP screen contrast.
- PIP BRIGHTNESS Adjust PIP screen brightness.

* The sub-menu can differ according to the type of the input signal.

PIP SOUND To turn the PIP sound on/off.

PIP SWAP To switch the main-screen and sub-screen in PIP mode.

Selecting and Adjusting the Screen

Adjusting PIP/POP/PBP Mode (Multiple Screen) Functions

To adjust the POP(PICTURE OUT PICTURE) of the screen

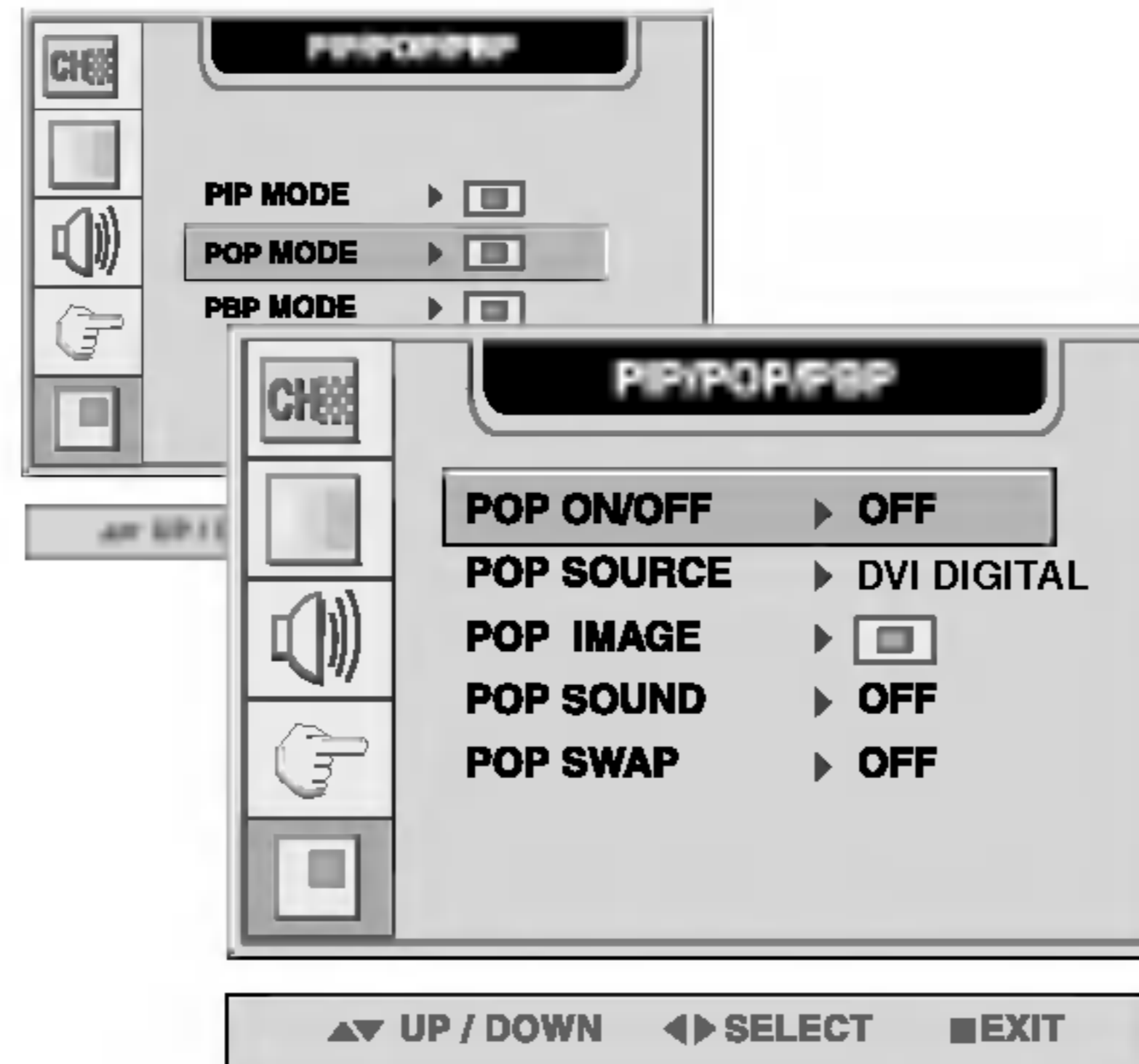

POP ON/OFF After selecting ON in the POP ON/OFF menu, the following menu items can be adjusted.



POP SOURCE To select an input signal for POP.

POP IMAGE To adjust the image of the POP screen; Press the ► button to display the submenu for POP IMAGE. Use the ◀ ▶ buttons to adjust the item to the desired level.



- **POP CONTRAST** Adjust POP screen contrast.
- **POP BRIGHTNESS** Adjust POP screen brightness.

* The sub-menu can differ according to the type of the input signal.

POP SOUND To turn the POP sound on/off.

POP SWAP To switch the main-screen and sub-screen in POP mode.



Note

The 'POP IMAGE' menu will be disabled if the POP screen input is video.

Adjusting PIP/POP/PBP Mode (Multiple Screen) Functions

To adjust the PBP(PICTURE BY PICTURE) of the screen

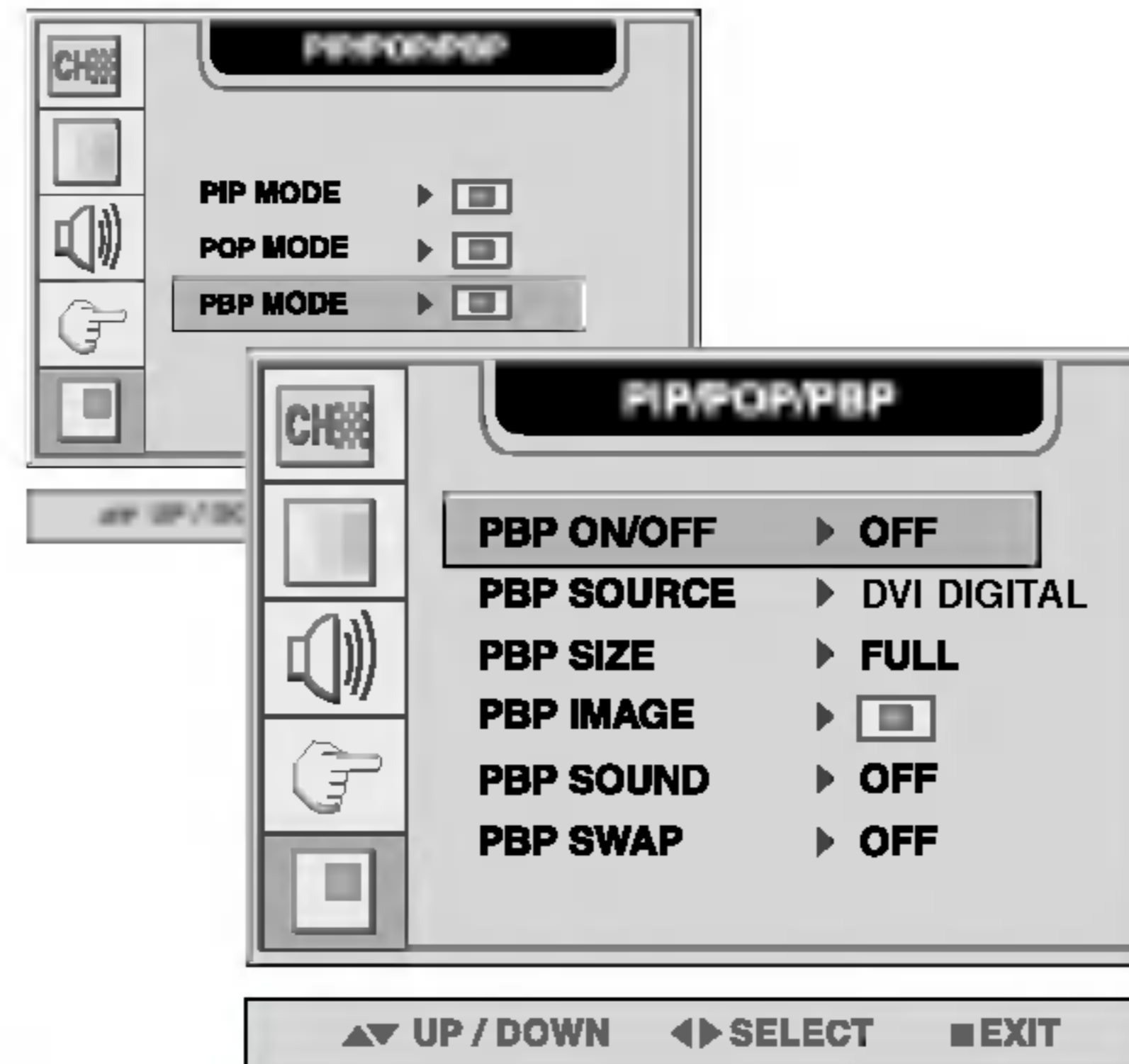

PBP ON/OFF After selecting ON in the PBP ON/OFF menu, the following menu items can be adjusted.



PBP SOURCE To select an input signal for PBP.

PBP SIZE To adjust the size of the PBP screen. (FULL/4:3)

PBP IMAGE To adjust the image of the PBP screen; Press the ► button to display the submenu for PBP IMAGE. Use the ◀ ► buttons to adjust the item to the desired level. The items of the sub-menu may vary depending on the type of the source.

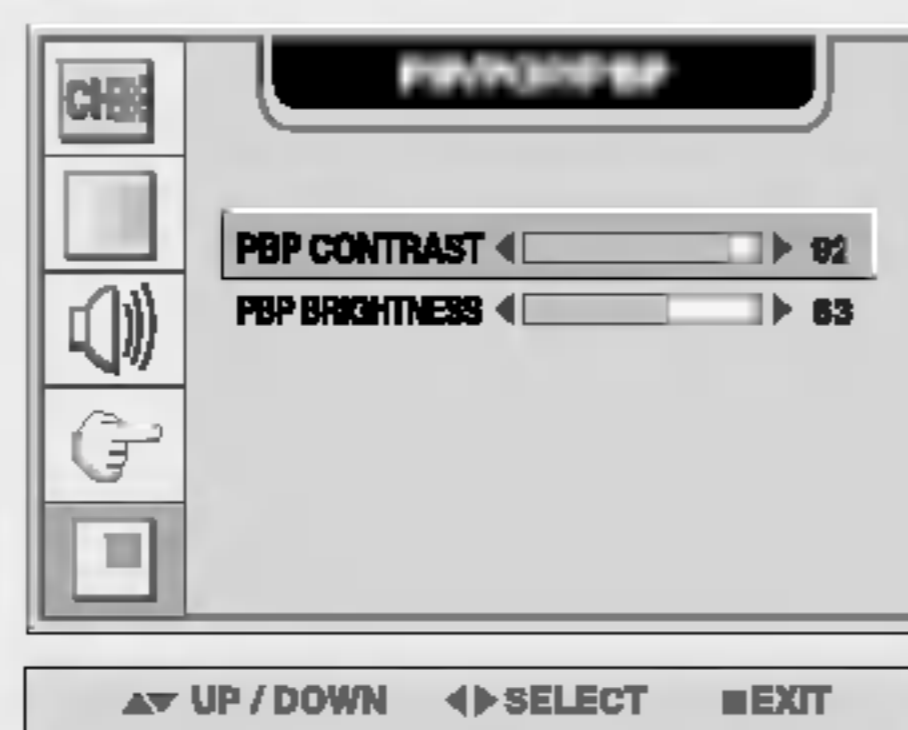

- PBP CONTRAST Adjust PBP screen contrast.
- PBP BRIGHTNESS Adjust PBP screen brightness.

* The sub-menu can differ according to the type of the input signal.

PBP SOUND To turn the PBP sound on/off.

PBP SWAP To switch the main-screen and sub-screen in PBP mode.



Note

The 'PBP IMAGE' menu will be disabled if the PBP screen input is video.

Controlling the Multiple Monitors

Use this method to connect several monitors to a single PC.

You can control several monitors at a time by connecting them to a single PC.

● Connecting the cable

Connect the RS-232C cable as shown in the picture.

* The RS-232C protocol is used for communication between the PC and monitor. You can turn the monitor on/off, select an input source or adjust the OSD menu from your PC.

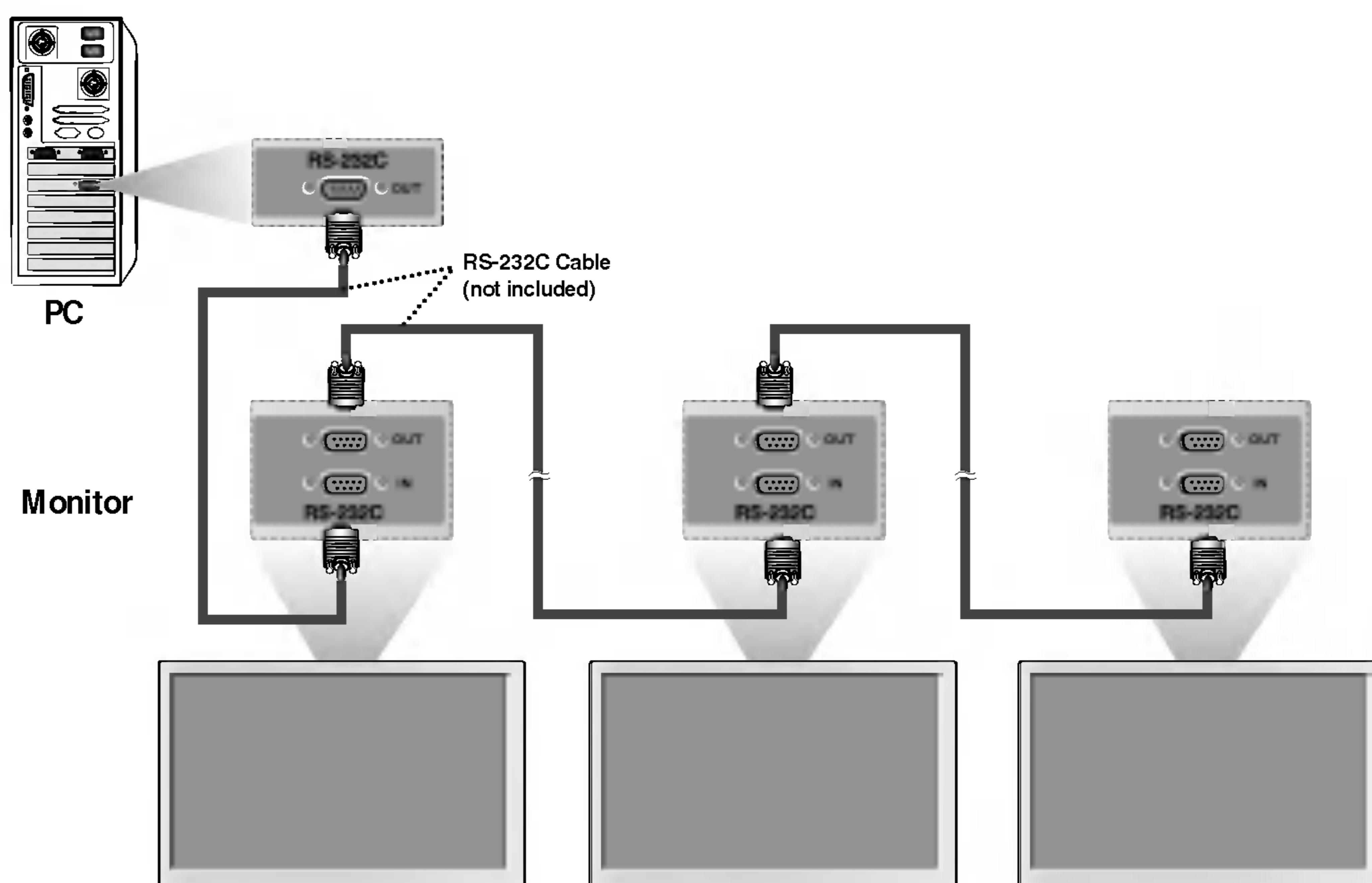

● Communication Parameter

- ▶ Baud Rate : 115200bps
- ▶ Data Length : 8bits
- ▶ Parity Bit : NONE
- ▶ Stop Bit : 1bit
- ▶ Flow Control : NONE

You can control several monitors at a time by connecting them to a single PC.

● Commands Related with User Control

■ Auto Assign Address

1. Reset

(1) Send Command

0	1	2	3	4	5
Length	Flag	Address	Command	Value	Checksum
06h	6Eh	00h	F0h	00h	

* Set the checksum value to "00h" when adding all message contents.

* Wait about 50ms for a reply after issuing a command.

(2) Reply from monitor

* No reply will be given for the "Reset" command.

2. Assign Address

(1) Send Command

0	1	2	3	4	5
Length	Flag	Address	Command	Value	Checksum
06h	6Eh	00h	F2h	xxh	

(2) Reply from Monitor

0	1	2	3	4	5
Length	Flag	Address	Command	Value	Checksum
6h	50h	xxh	F2h	00h	

* Monitors assigned with an address will only respond and reply to commands that specify its precise address.

3. Presence Check

(1) Send Command

0	1	2	3	4	5
Length	Flag	Address	Command	Value	Checksum
06h	6Eh	xxh	F7h	00h	

(2) Reply from Monitor

0	1	2	3	4	5
Length	Flag	Address	Command	Value	Checksum
06h	50h	xxh	F7h	00h	

* If no valid RS-232 command is received within three seconds, the command will be reset.

Controlling the Multiple Monitors

■ Miscellaneous Commands

(1) Send Command

0	1	2	3	4	5	6	7
Length	Flag	Address	Command	Parameter	Value#1	Value#2	Checksum
08h	6Eh	xxh	03h				

(2) Reply from Monitor

0	1	2	3	4	5
Length	Flag	Address	Command	Value	Checksum
06h	50h	xxh	03h	00h	

(3) Parameter

FUNCTION		PARAMETER(HEX)	Value# 1(HEX)	Value# 2 (HEX)
MAIN POWER ON/OFF		01h	00h	00h/OFF, 01h/ON
MAIN INPUT	DSUB ANALOG	0Fh	00h	00h
	DVI DIGITAL		00h	01h
	VIDEO1(CVBS)		00h	02h
	VIDEO2(S-Video)		00h	03h
	COMPONENT1/SCART1		00h	04h
	COMPONENT2/SCART2		00h	05h
SUB INPUT	DSUB ANALOG	10h	00h	00h
	DVI DIGITAL		00h	01h
	VIDEO1(CVBS)		00h	02h
	VIDEO2(S-Video)		00h	03h
	COMPONENT1/SCART1		00h	04h
	COMPONENT2/SCART2		00h	05h
PSM	USER	02h	00h	00h
	GAME		00h	01h
	STANDARD		00h	02h
	DYNAMIC		00h	03h
	MILD		00h	04h
CONTRAST		03h	00h	00h~64h
BRIGHTNESS		04h	00h	00h~64h
SHARPNESS		05h	00h	00h~64h
COLOR		06h	00h	00h~64h
TINT		07h	00h	00h~64h
COLOR TEMP.	9300K	08h	00h	00h
	6500K	09h	00h	00h
	USER	0Ah	00h	00h
USER (COLOR TEMP.)	RED	0Bh	00h	37h~FFh
	GREEN		01h	37h~FFh
	BLUE		02h	37h~FFh
SSM	USER	0Ch	00h	00h
	FLAT		00h	01h
	MOVIE		00h	02h
	MUSIC		00h	03h
	SPORTS		00h	04h

(3) Parameter

.....Continue

FUNCTION		PARAMETER(HEX)	Value# 1(HEX)	Value# 2 (HEX)
TREBLE		0Dh	00h	00h~14h
BASS		11h	00h	00h~14h
BALANCE		12h	00h	00h~20h
VOLUME		13h	00h	00h~64h
SRS WOW		14h	00h	00h/OFF, 01h/ON
MUTE		15h	00h	00h/OFF, 01h/ON
PIP ON/OFF		18h	00h	00h/OFF, 01h/ON
POP ON/OFF		19h	00h	00h/OFF, 01h/ON
PBP ON/OFF		1Ah	00h	00h/OFF, 01h/ON
PIP SIZE	LARGE	1Bh	00h	00h
	SMALL		00h	01h
PBP SIZE	FULL	1Ch	00h	00H
	4:3		00h	01H
PIP POSITION	RIGHT/TOP	1Dh	00h	00h
	LEFT/TOP		00h	01h
	LEFT/BOTTOM		00h	02h
	RIGHT/BOTTOM		00h	03h
PIP SWAP		1Eh	00h	00h
SCALING	FULL	21h	00h	00h
	4:3		00h	01h
	SPECTACLE		00h	02h
	1:1		00h	03h
AUTO ADJUST		22h	00h	00h
PHASE		23h	00h	0h~64h
CLOCK		24h	00h	00h~64h
OSD HOR.		25h	00h	00h~64h
OSD VER.		26h	00h	00h~64h
TRANSPARENCY		27h	00h	00h~0Fh
OSD LOCK		29h	00h	00h/OFF, 01h/ON
LANGUAGE	ENGLISH	2Ah	00h	00h
	DEUTSCH		00h	01h
	FRANÇAIS		00h	02h
	ESPAÑOL		00h	03h
	ITALIANO		00h	04h
	KOREAN		00h	05h
RESET	ALL	2Bh	00h	00h
ZOOM		35h	00h	00h~0Ah

Troubleshooting

No image is displayed

- Is the monitor power cord connected?
 - Does the power LED is turned on?
 - Power is on, power LED is green but the screen appears extremely dark.
 - Does the power LED look yellow?
 - Does the 'OUT OF RANGE' message appear?
 - Does the 'CHECK SIGNAL CABLE' message appear?
- See if the power cord is properly connected to the outlet.
 - See if the power switch is turned on.
 - Adjust brightness (☉) and contrast (◐) again.
 - If the monitor is in power saving mode, move the mouse or press any key.
 - The signal from the PC (video card) is out of the vertical or horizontal frequency range of the monitor. Adjust the frequency range by referring to the Specifications in this manual.
 - * **Maximum resolution**
 - D-Sub : 1600x1200 @60Hz
 - DVI-D : 1360x768 @60Hz
 - The signal cable between PC and monitor is not connected. Check the signal cable.
 - Press the 'SOURCE' menu in the remote controller to check the input signal.

'Unknown Monitor' message appears when the monitor is connected.

- Did you install the driver?
- Install the monitor driver, which is provided with the monitor, or download it from the web site. (<http://www.lge.com>)
 - See if the plug&play function is supported by referring to the video card user manual.

'CONTROLS LOCKED' message appears

- The 'CONTROLS LOCKED' message appears when pressing the Menu button.
- The control locking function prevents unintentional OSD setting change due to careless usage. To unlock the controls, simultaneously press the Menu button and ► button for 5 seconds. (You cannot set this function using the remote controller buttons. You can set this function in the monitor only.)



Note

* **Vertical frequency:** To enable the user to watch the monitor display, screen image should be changed tens of times every second like a fluorescent lamp. The vertical frequency or refresh rate is the times of image display per second. The unit is Hz.

* **Horizontal frequency:** The horizontal interval is the time to display one vertical line. When 1 is divided by the horizontal interval, the number of horizontal lines displayed every second can be tabulated as the horizontal frequency. The unit is kHz.

The screen image looks abnormal.

- **Is the screen position wrong?**
 - D-Sub analog signal – Press the “AUTO” button in the remote controller to automatically select the optimal screen status that fits into the current mode. If adjustment is not satisfactory, use the Position OSD menu.
 - See if the video card resolution and frequency are supported by the monitor. If the frequency is out of range, set to the recommended resolution in the Control Panel – Display – Setting menu.
- **Do thin lines appear on the background screen?**
 - D-Sub analog signal – Press the “AUTO” button in the remote controller to automatically select an optimal screen status that fits into the current mode. If adjustment is not satisfactory, use the Clock OSD menu.
- **Horizontal noise appears or the characters look blurred.**
 - D-Sub analog signal – Press the “AUTO” button in the remote controller to automatically select an optimal screen status that fits into the current mode. If adjustment is not satisfactory, use the Phase OSD menu.
- **Unable to adjust the horizontal/vertical position in the Zoom menu.**
 - See if the Zoom value is set to 0. If it is, you cannot adjust the H/V Position value.
- **Screen size is automatically adjusted when connected to the PC.**
 - If the screen size is not full when connected to the PC, execute the PIP/POP/PBP to change to full screen mode.
- **Brightness differs in the main and sub screen when connected to the PC.**
 - You cannot adjust brightness and tint in the PIP/POP/PBP Screen menu for the sub-screen among PIP/POP/PBP menus. Therefore, brightness can be different for the sub-screen.

After-image appears on the monitor.

- **After-image appears when the monitor is turned off.**
 - If you use a fixed image for a long time, the pixels may be damaged quickly. Use the screensaver function.

Troubleshooting

The audio function does not work.

- **No sound?**
 - See if the audio cable is connected properly.
 - Adjust the volume.
 - See if the sound is set properly.
- **No sound is available when the PIP/POP/PBP mode is engaged.**
 - See if the Sound is set to On in the PIP/POP/PBP menu.
- **Sound is too dull.**
 - Select the appropriate treble sound.
 - Select the appropriate bass sound.
- **Sound is too low.**
 - Adjust the volume.

The screen size function in the OSD menu does not work.

- **The screen size function in the OSD menu does not work.**
 - See if the PIP/POP/PBP function is in use. If the PIP/POP/PBP function is in use, the screen size function may not work.

Screen color is abnormal.

- **Screen has poor color resolution (16 colors).**
 - Set the number of colors to more than 24 bits (true color)
Select Control Panel – Display – Settings – Color Table menu in Windows.
- **Screen color is unstable or mono-colored.**
 - Check the connection status of the signal cable.
Or, re-insert the PC video card.
- **Do black spots appear on the screen?**
 - Several pixels (red, green, white or black color) may appear on the screen, which can be attributable to the unique characteristics of the LCD panel. It is not a malfunction of the LCD.

Specifications

ENGLISH

Display	42 inches (106.68cm) Flat Panel Active matrix-TFT LCD Anti-Glare coating 42inches viewable 0.681mm pixel pitch	
Sync Input	Horizontal Freq.	D-SUB : 30 - 83kHz (Automatic) DVI-D : 30 - 72kHz (Automatic)
	Vertical Freq.	56 - 85Hz (Automatic)
	Input Form	Separate TTL, Positive/Negative Composite TTL, Positive/Negative SOG (Sync On Green) Digital
Video Input	Signal Input	15 pin D-Sub Connector DVI - D connector (Digital) Composite video S video SCART 1/SCART 2 or COMPONENT 1/ COMPONENT 2
	Input Form	RGB Analog (0.7Vp-p/75ohm), Digital, S-video, CVBS
Resolution	Max	D-SUB : 1600 x 1200 @60Hz DVI-D : 1360 x 768 @60Hz – It may not be supported depending on the OS or video card type.
	Recommend	1360 x 768 @60Hz
Plug&Play	DDC 2B	
Power Input	AC 100-240V~ 50/60Hz 2.8A	
Power Consumption	Normal	: 300W
	Stand-by/Suspend	≤ 5W
	DPMS Off	≤ 5W
	Power switch Off	≤ 5W
	Power cut-off switch off	: 0W

* Applicable only for models that support the speakers

Audio	RMS Audio Output	10W+10W(R+L)
	Input Sensitivity	0.7Vrms
	Speaker Impedance	8Ω

NOTE

- Information in this document is subject to change without notice.

Specifications

Dimensions & Weight

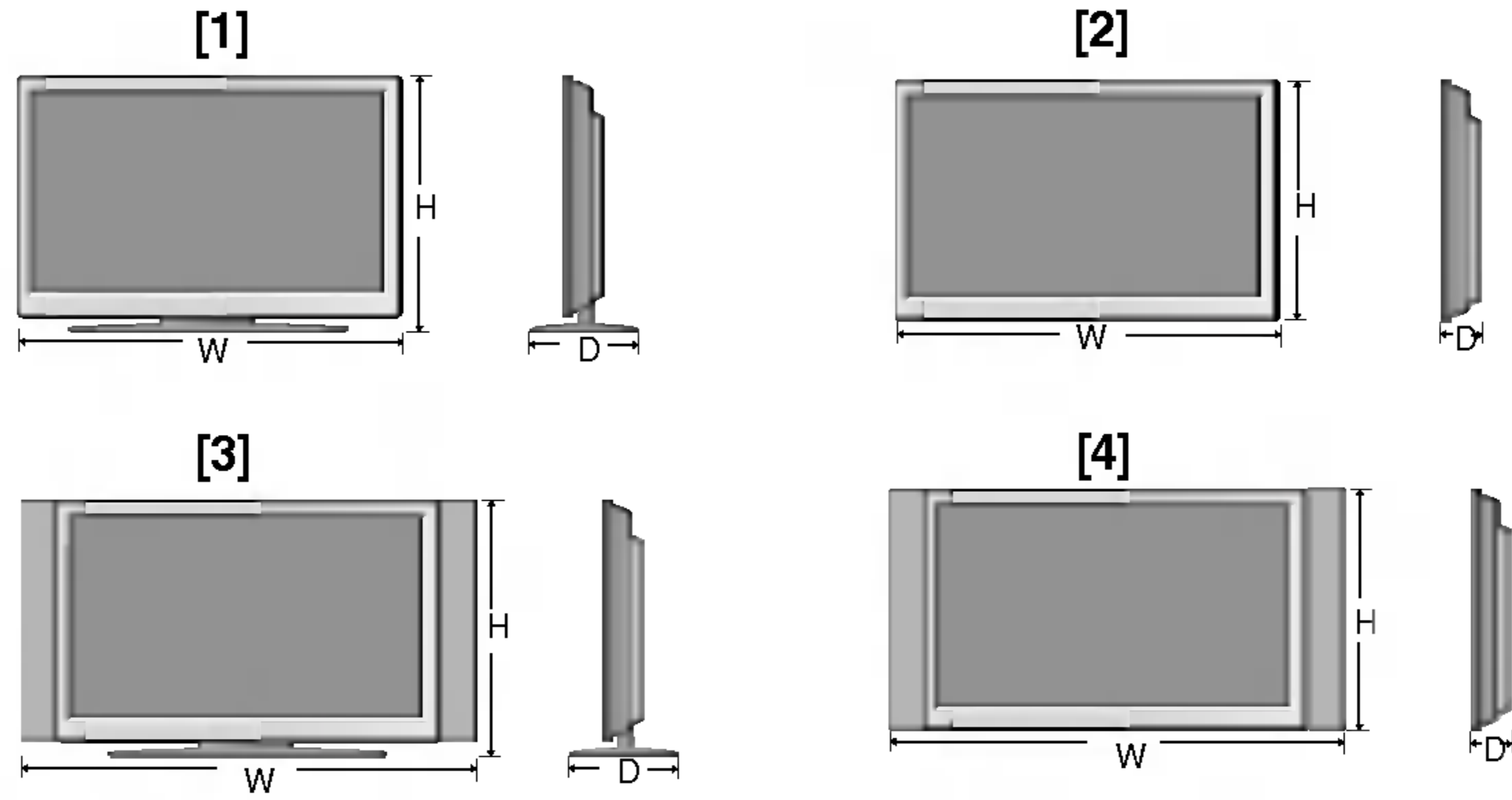

WidthxHeightxDepth

[1] 105.7 cm(41.61 inches) x 70.20 cm(27.64 inches) x 29.45 cm(11.59 inches)

[2] 105.7 cm(41.61 inches) x 65.30 cm(25.71 inches) x 11.91 cm(4.69 inches)

[3] 125.9 cm(49.57 inches) x 70.20 cm(27.64 inches) x 29.45 cm(11.59 inches)

[4] 125.9 cm(49.57 inches) x 65.30 cm(25.71 inches) x 11.91 cm(4.69 inches)

Net

[1] 34.65kg (76.39 lbs)

[2] 30.25kg (66.69 lbs)

[3] 37.25kg (82.12 lbs)

[4] 32.85kg (72.42 lbs)

Environmental Conditions

Operating Conditions

Temperature 10 °C to 35 °C

Humidity 10 % to 80 % non-Condensing

Storage Conditions

Temperature -20 °C to 60 °C

Humidity 5 % to 95 % non-Condensing

● PC Mode – Preset Mode

Preset mode		Horizontal Frequency (kHz)	Vertical Frequency (Hz)	Preset mode		Horizontal Frequency (kHz)	Vertical Frequency (Hz)
1	VGA 640 x 350	31.469	70	11	VESA 1024 x 768	60.123	75
2	VGA 720 x 400	31.468	70	12	VESA 1024 x 768	68.68	85
3	VGA 640 x 480	31.469	60	13	VESA 1280 x 720	44.772	60
4	VESA 640 x 480	37.500	75	14	VESA 1360 x 768	47.72	60
5	VESA 640 x 480	43.269	85	15	VESA 1280 x 1024	63.981	60
6	VESA 800 x 600	37.879	60	16	VESA 1280 x 1024	79.98	75
7	VESA 800 x 600	46.875	75	17	VESA 1600 x 1200	75	60
8	VESA 800 x 600	53.674	85	D-SUB : Mode 1 ~ Mode 17 DVI-D : Mode 1 ~ Mode 15			
9	MAC 832 x 624	49.725	75				
10	VESA 1024 x 768	48.363	60				

● Power LED

Mode	Monitor
Normal Operation	Green
Pre-power Saving State	Amber
Power Saving State	Amber
Power Switch Off	-
Power Cut-off Switch Off	-

VESA wall mounting

Connected to another object (stand type and wall-mounted type. This monitor accepts a VESA-compliant mounting interface pad.- **optional**)
For further information, refer to the VESA Wall Mounting Instruction Guide.

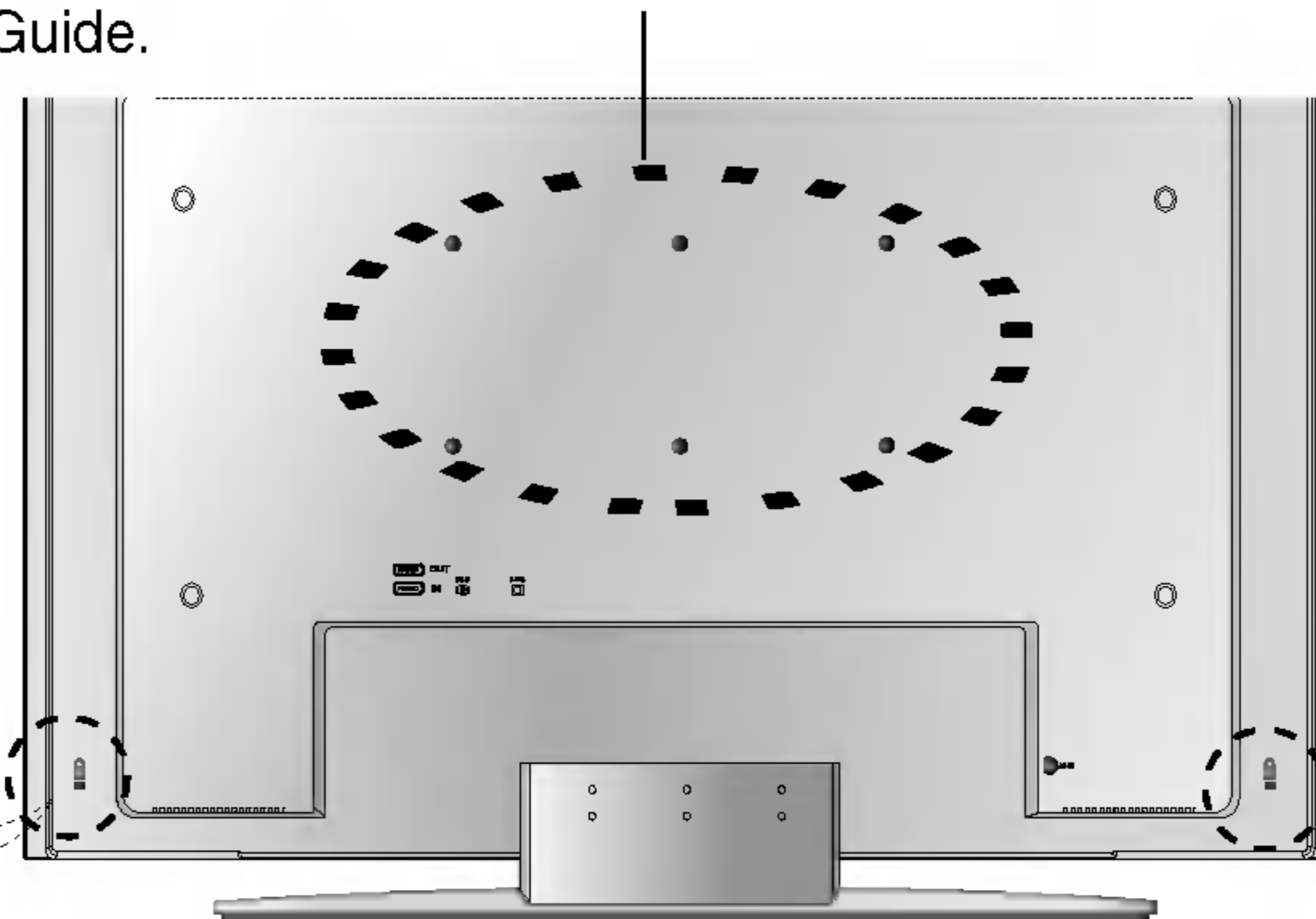

Kensington Security Slot- optional

Connected to a locking cable that can be purchased separately at most computer stores