



LG

ENGLISH

ESPAÑOL

LG

Multi Type Air Conditioner

OWNER'S MANUAL

Type: Artcool Deluxe

Models: LMNC092DZR0 / LMNC092DZW0
LMNC092DZB0 / LMNC092DZD0
LMNC092DZM0 / LMNC092DZC0
LMNH092DZR0 / LMNH092DZW0
LMNH092DZB0 / LMNH092DZD0
LMNH092DZM0 / LMNH092DZC0
LMNC122DUR0 / LMNC122DUW0
LMNC122DUB0 / LMNC122DUD0
LMNC122DUM0 / LMNC122DUC0
LMNH122DUR0 / LMNH122DUW0
LMNH122DUB0 / LMNH122DUD0
LMNH122DUM0 / LMNH122DUC0
LMNC182D3R0 / LMNC182D3W0
LMNC182D3B0 / LMNC182D3D0
LMNC182D3M0 / LMNC182D3C0
LMNH182D3R0 / LMNH182D3W0
LMNH182D3B0 / LMNH182D3D0
LMNH182D3M0 / LMNH182D3C0
LMNC242D3R0 / LMNC242D3W0
LMNC242D3B0 / LMNC242D3D0
LMNC242D3M0 / LMNC242D3C0
LMNH242D3R0 / LMNH242D3W0
LMNH242D3B0 / LMNH242D3D0
LMNH242D3M0 / LMNH242D3C0



IMPORTANT

- Please read this owner's manual carefully and thoroughly before installing and operating your room air conditioner.
- Please retain this owner's manual for future reference after reading it thoroughly.

TABLE OF CONTENTS

Safety Precautions	3
Prior to Operation	8
Operating Instructions	9
<i>Preparation before operation</i>	9
<i>About the remote controller on the system</i>	11
<i>How to use the Operation Mode Selection Button</i>	12
<i>Additional Features</i>	19
Maintenance and Service	22
<i>Before you Call for Service</i>	25



FOR YOUR RECORDS

Write the model and serial numbers here:

Model # _____

Serial # _____

You can find them on a label on the side of each unit.

Dealer's Name _____

Date Purchased _____

- Staple your receipt to this page in the event you need to prove date of purchase or to issue warranty.



READ THIS MANUAL

Inside you will find many helpful hints on how to use and maintain your air conditioner properly. Just a little preventive care on your part can save you a great deal of time and money over the life of your air conditioner.

You'll find many answers to common problems in the chart of troubleshooting tips. If you review our chart of **Troubleshooting Tips** first, you may not need to call for service at all.



PRECAUTION

- Contact the authorized service technician for repair or maintenance of this unit.
- Contact the installer for installation of this unit.
- The air conditioner is not intended for use by young children or invalids without supervision.
- Young children should be supervised to ensure that they do not play with the air conditioner.
- When the power cord is to be replaced, replacement work shall be performed by authorized personnel only using only genuine replacement parts.
- Installation work must be performed in accordance with the National Electric Code by qualified and authorized personnel only.





Safety Precautions

To prevent injury to the user or other people and property damage, the following instructions must be followed.

■ Incorrect operation due to ignoring instruction will cause harm or damage. The seriousness is classified by the following indications.

- ⚠ WARNING** This symbol indicates the possibility of death or serious injury.
- ⚠ CAUTION** This symbol indicates the possibility of injury or damage to properties only.

■ Meanings of symbols used in this manual are as shown below.

	Be sure not to do.
	Be sure to follow the instruction.

⚠ WARNING

■ Installation

Do not use a defective or underrated circuit breaker. Use this appliance on a dedicated circuit.

- There is risk of fire or electric shock.

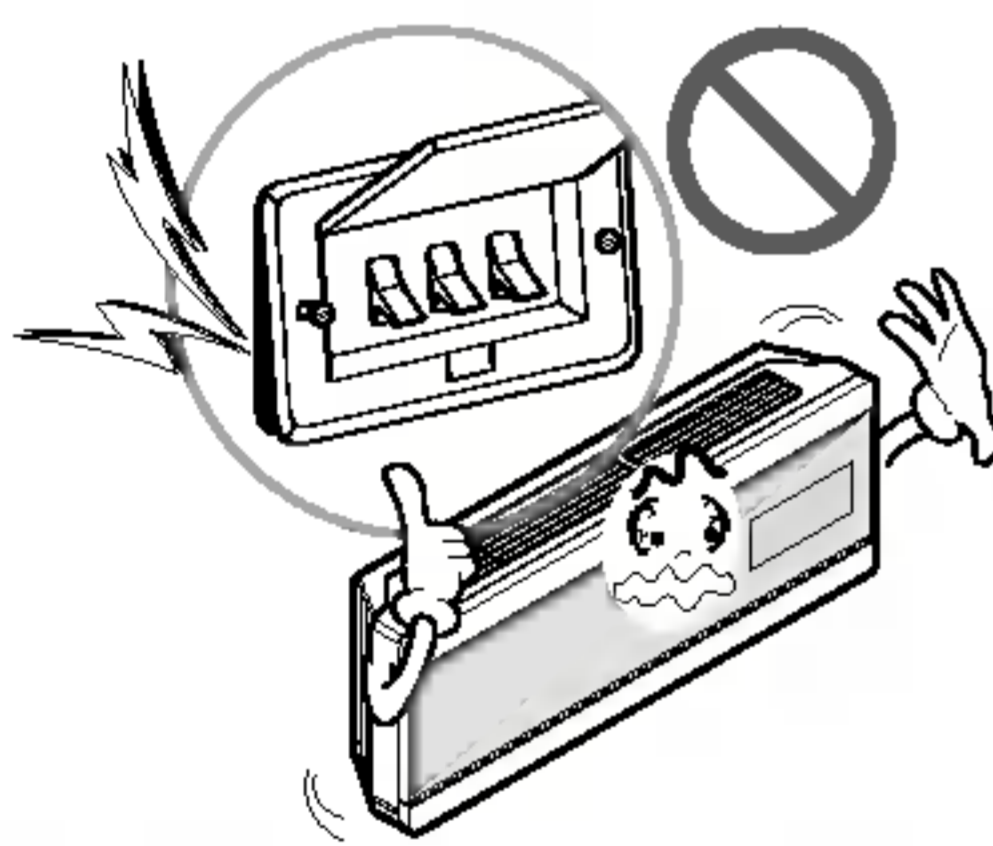

For electrical work, contact the dealer, seller, a qualified electrician, or an Authorized Service Center.

- Do not disassemble or repair the product. There is risk of fire or electric shock.

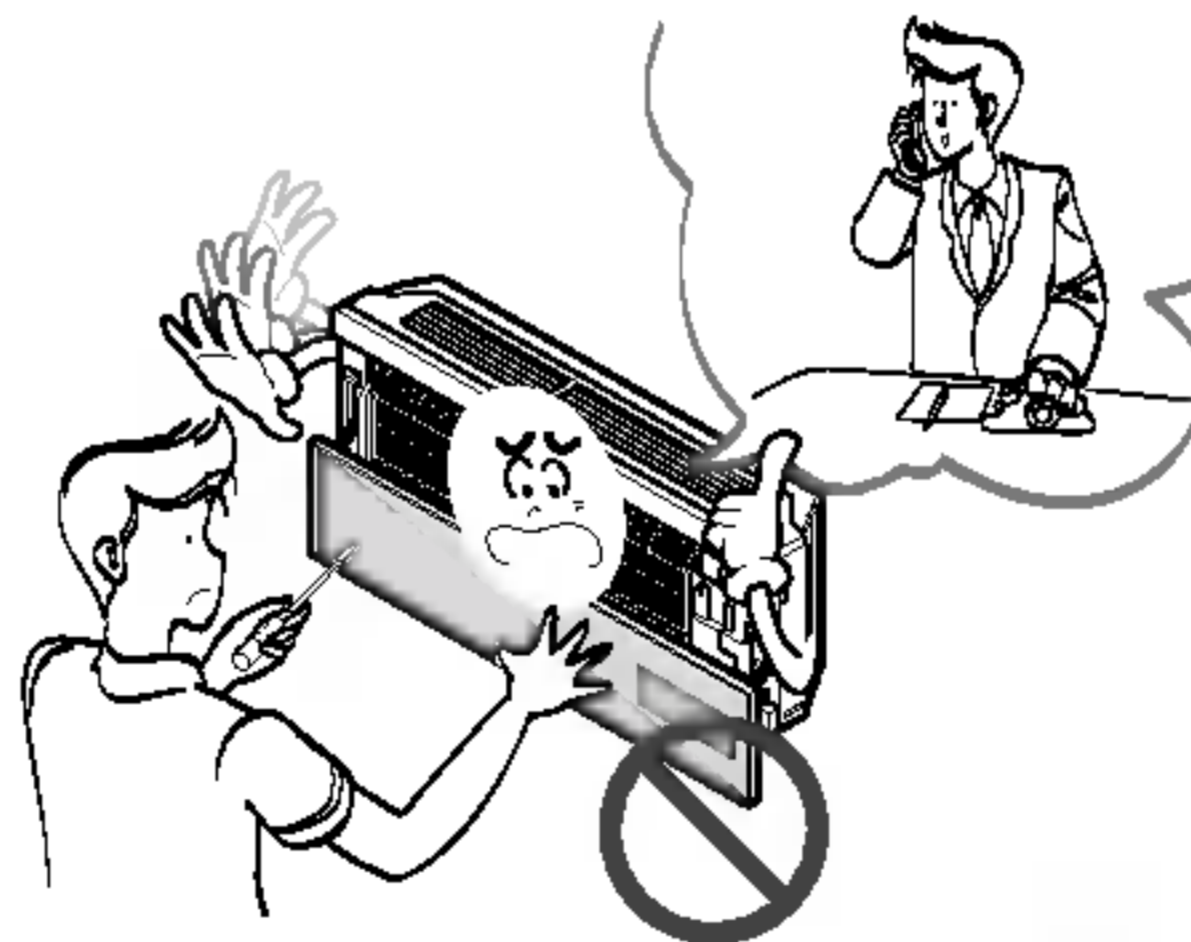

Always ground the product.

- There is risk of fire or electric shock.

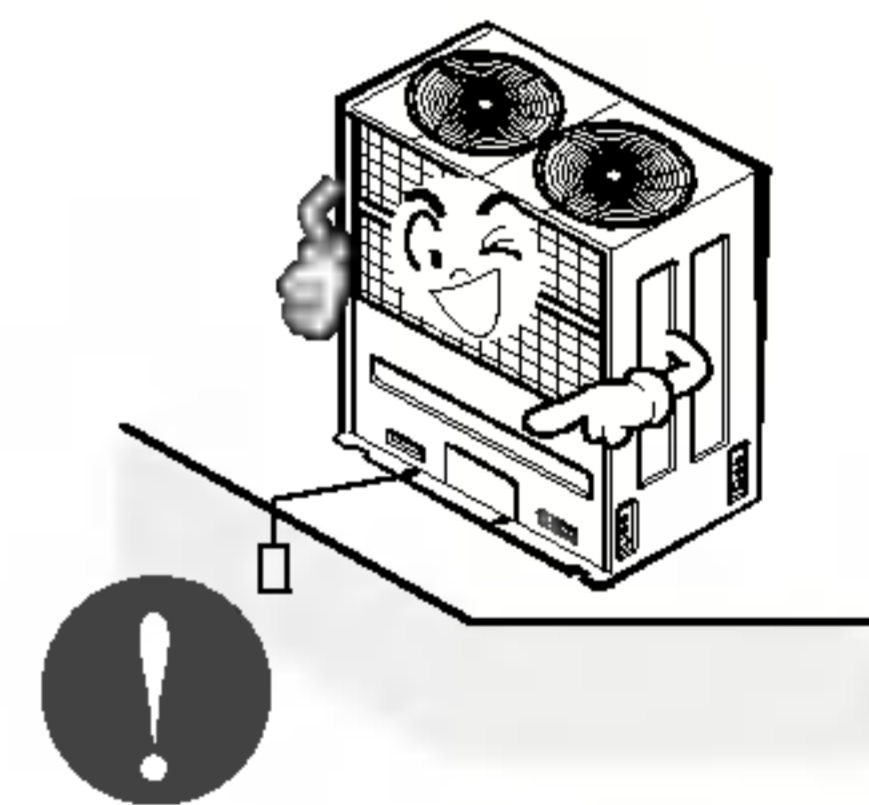

Install the panel and the cover of control box securely.

- There is risk of fire or electric shock.

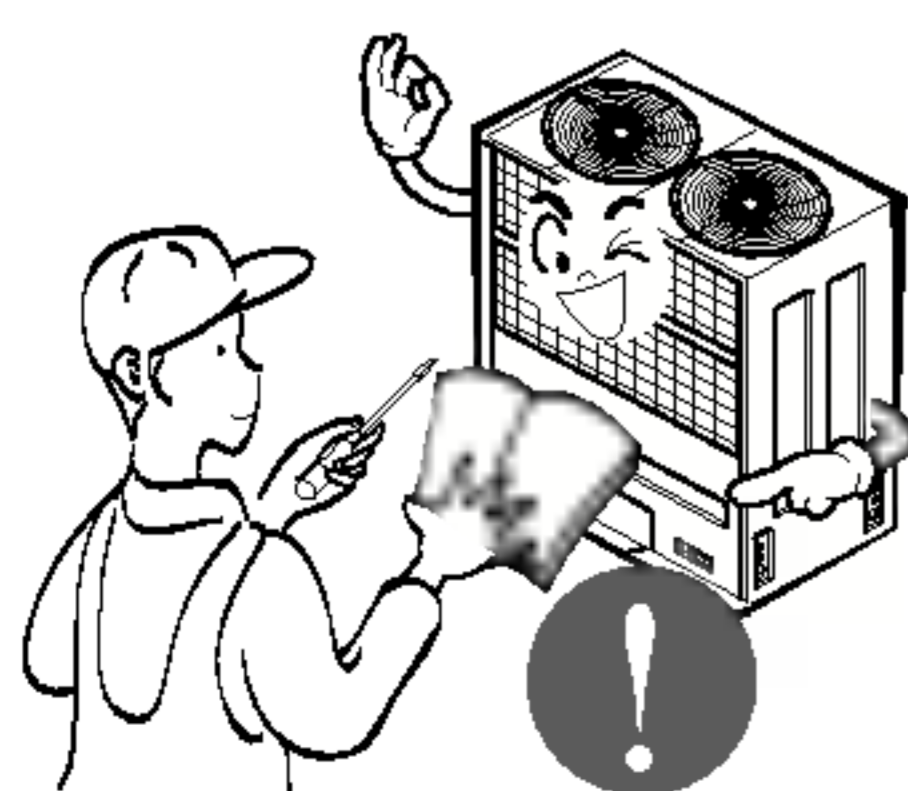

Always install a dedicated circuit and breaker.

- Improper wiring or installation may cause fire or electric shock

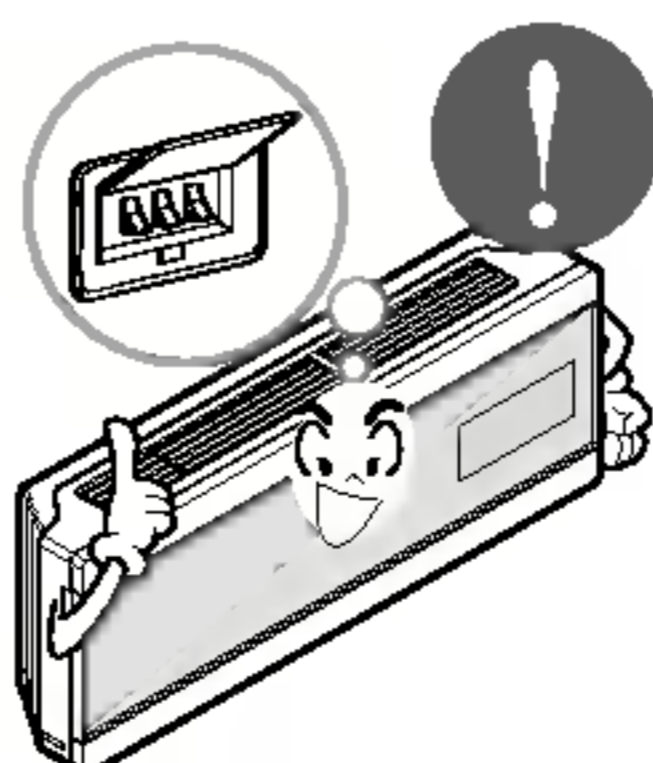

Use the correctly rated breaker or fuse.

- There is risk of fire or electric shock.

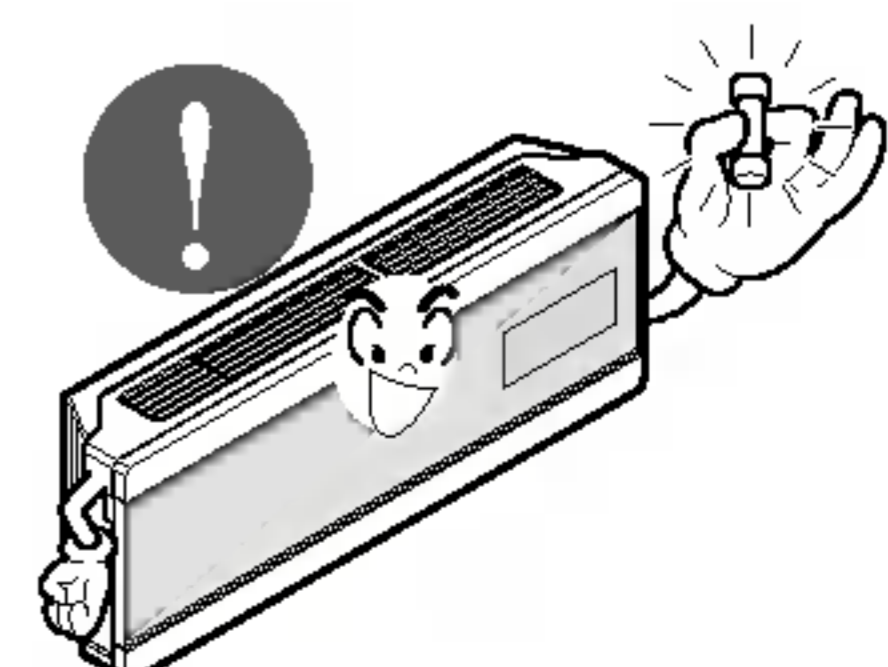

Safety Precautions

Do not modify or extend the power cable.

- There is risk of fire or electric shock.

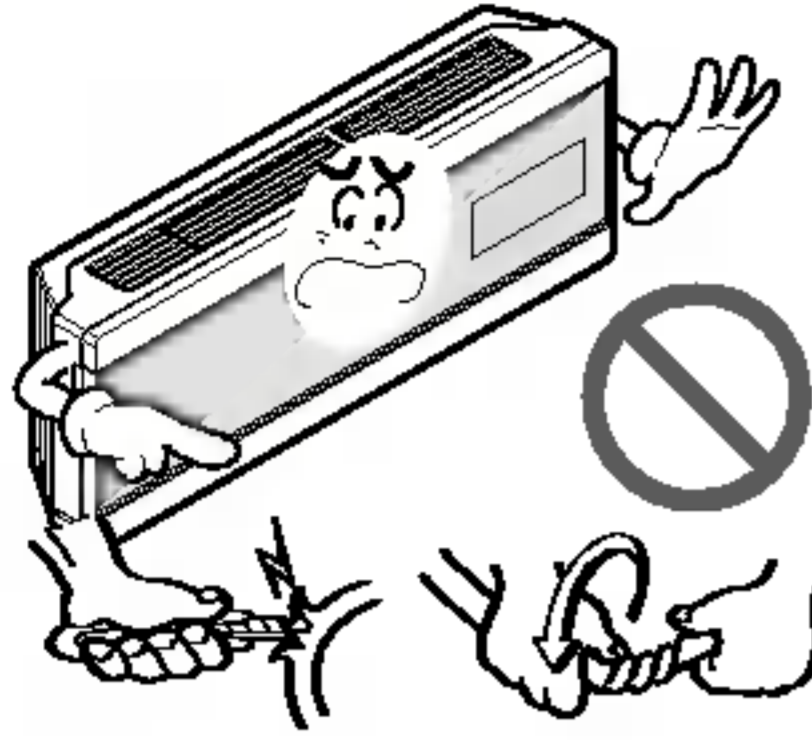

Do not install, remove, or re-install the unit by yourself (customer).

- There is risk of fire, electric shock, explosion, or injury.

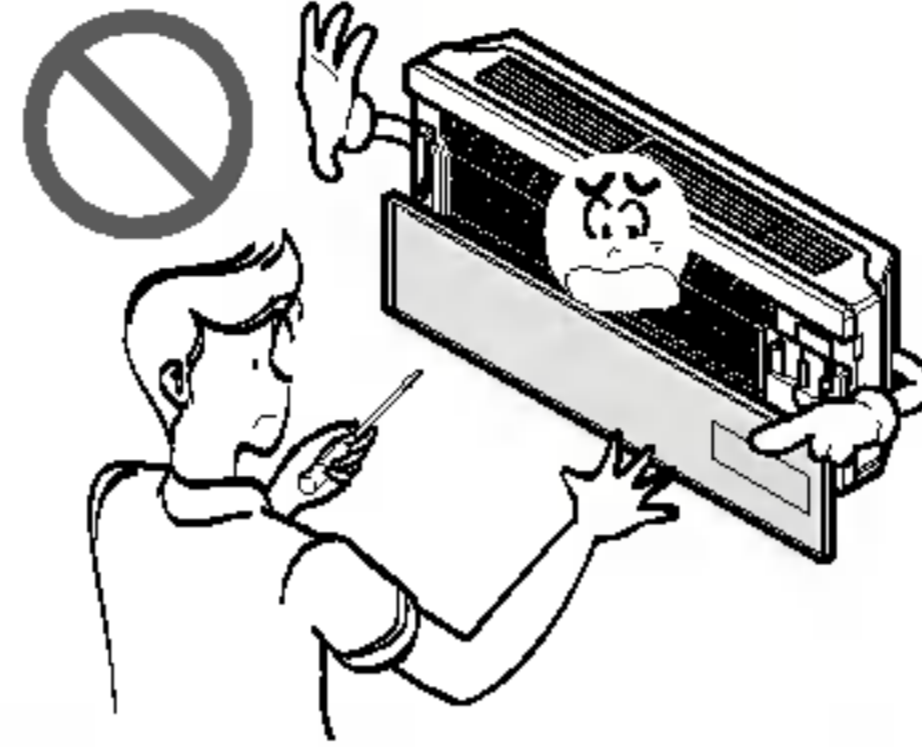

Be cautious when unpacking and installing the product.

- Sharp edges could cause injury. Be especially careful of the case edges and the fins on the condenser and evaporator.

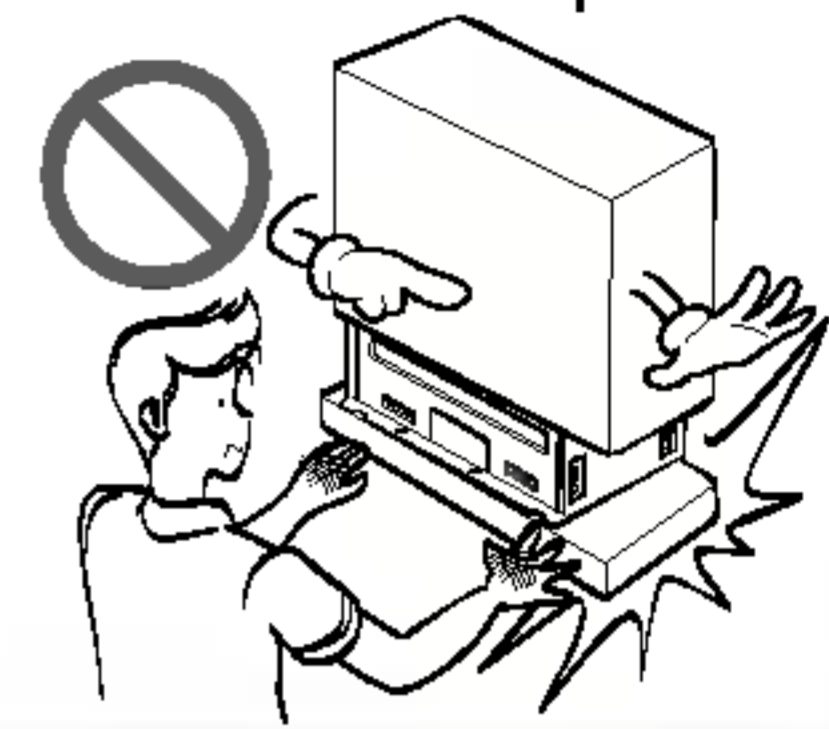

For installation, always contact the dealer or an Authorized Service Center.

- There is risk of fire, electric shock, explosion, or injury.

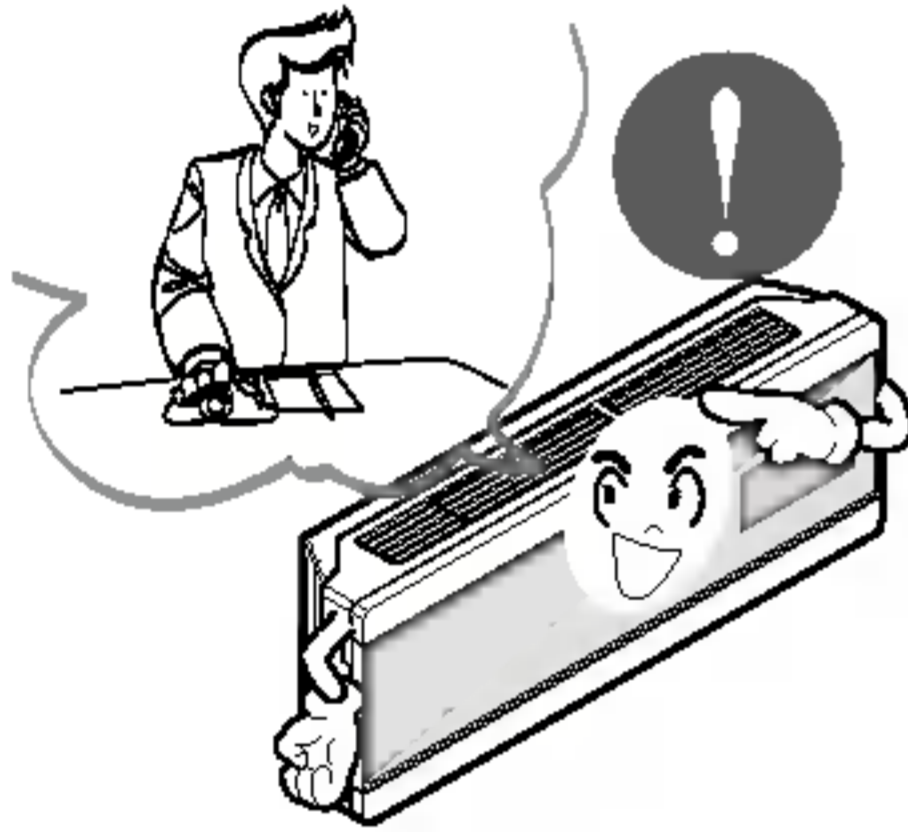

Do not install the product on a defective installation stand.

- It may cause injury, accident, or damage to the product.

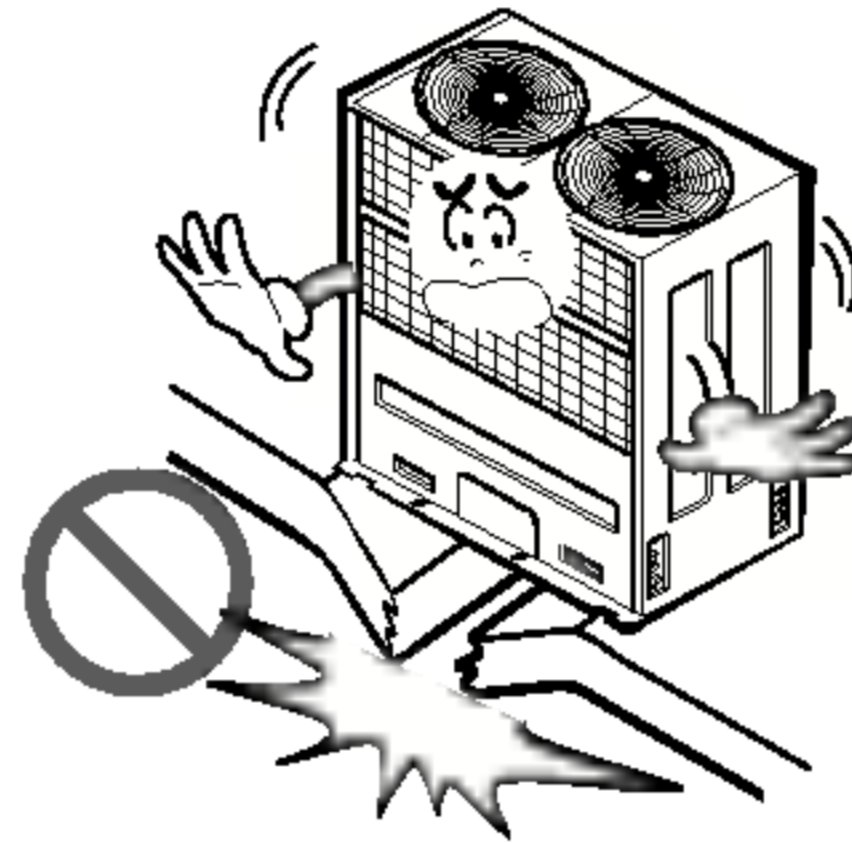

Be sure the installation area does not deteriorate with age.

- If the base collapses, the air conditioner could fall with it, causing property damage, product failure, and personal injury.

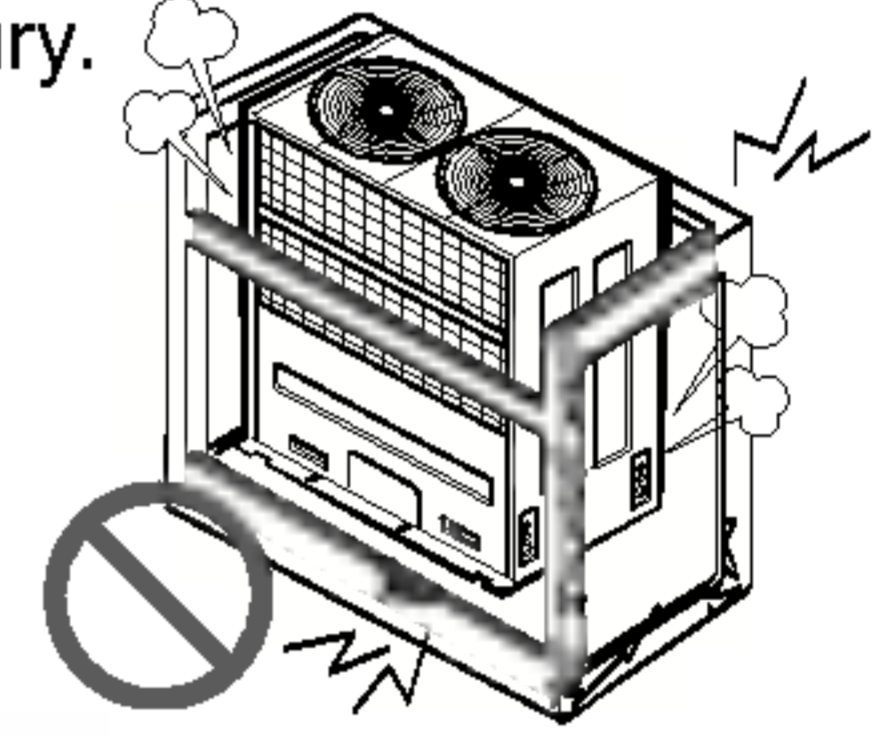

Operation

Do not let the air conditioner run for a long time when the humidity is very high and a door or a window is left open.

- Moisture may condense and wet or damage furniture.

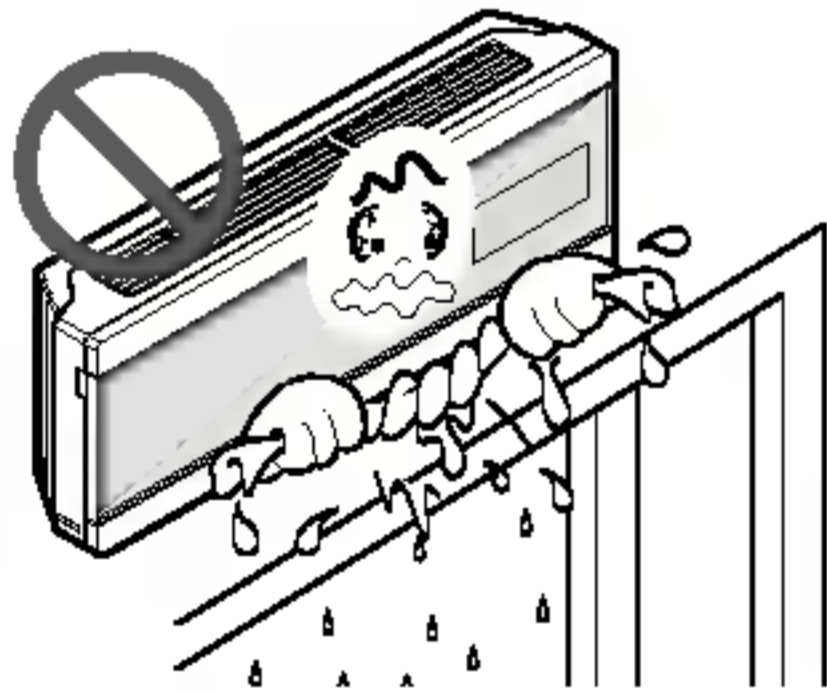

Take care to ensure that power cable could not be pulled out or damaged during operation.

- There is risk of fire or electric shock.

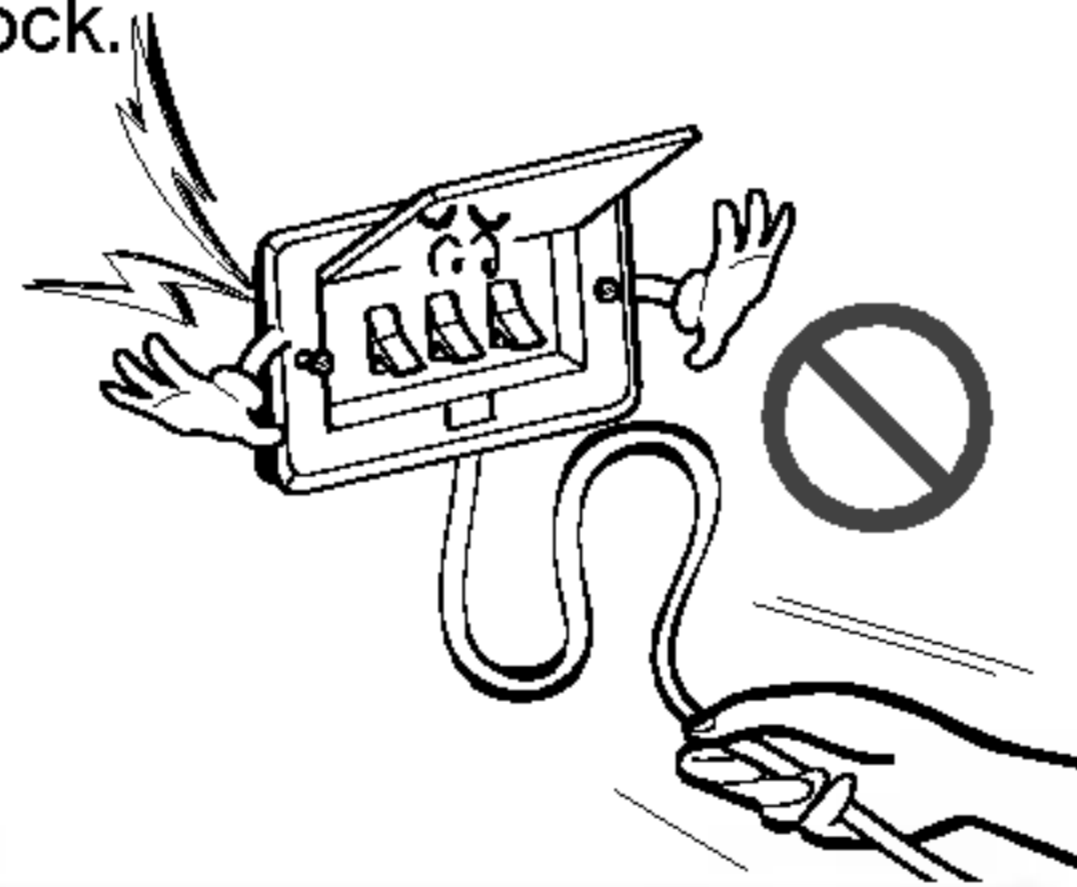

Do not place anything on the power cable.

- There is risk of fire or electric shock.

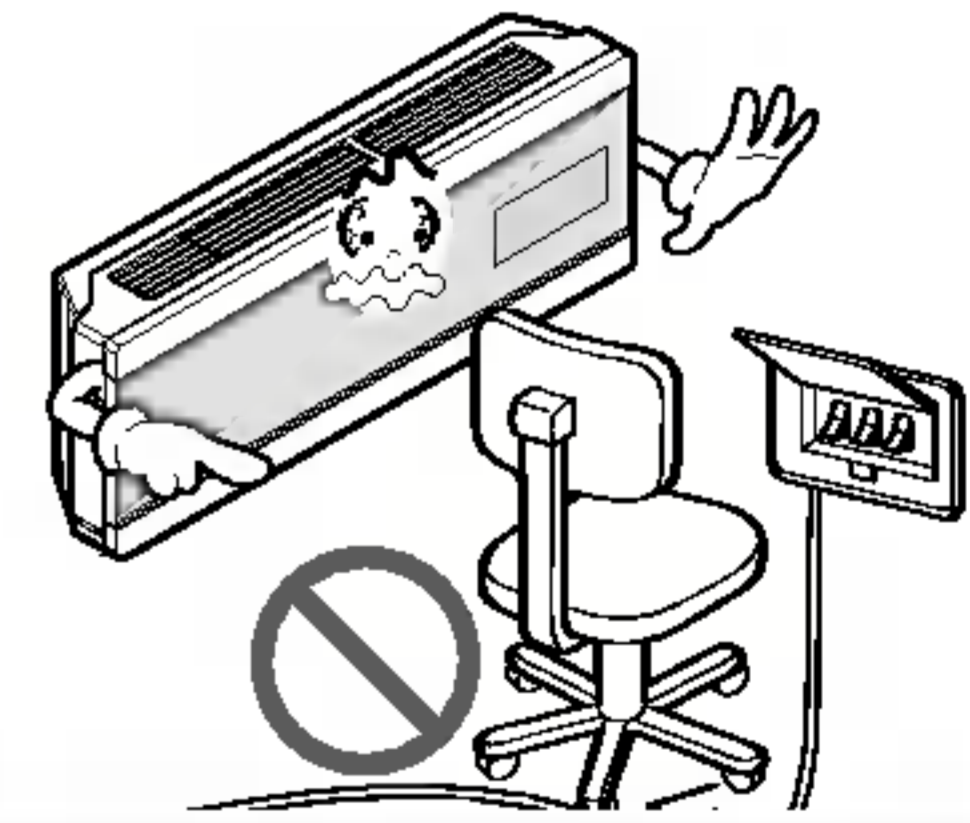

Do not plug or unplug the power supply plug during operation.

- There is risk of fire or electric shock.

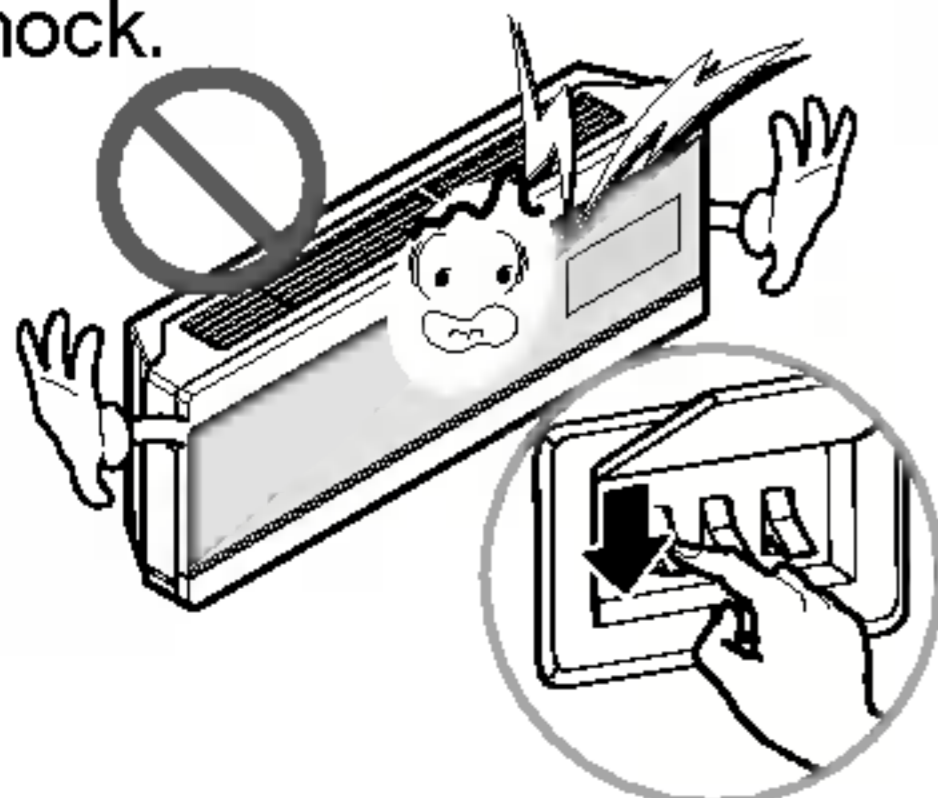

Do not touch (operate) the product with wet hands.

- There is risk of fire or electrical shock.

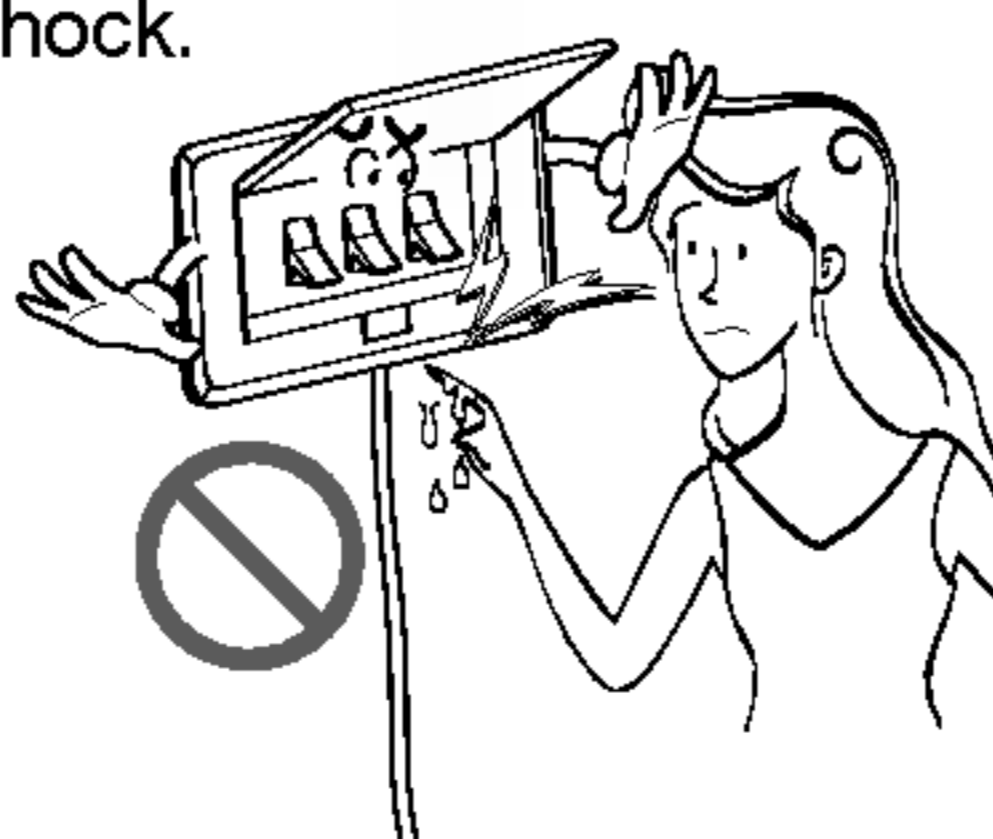

Do not place a heater or other appliances near the power cable.

- There is risk of fire and electric shock.

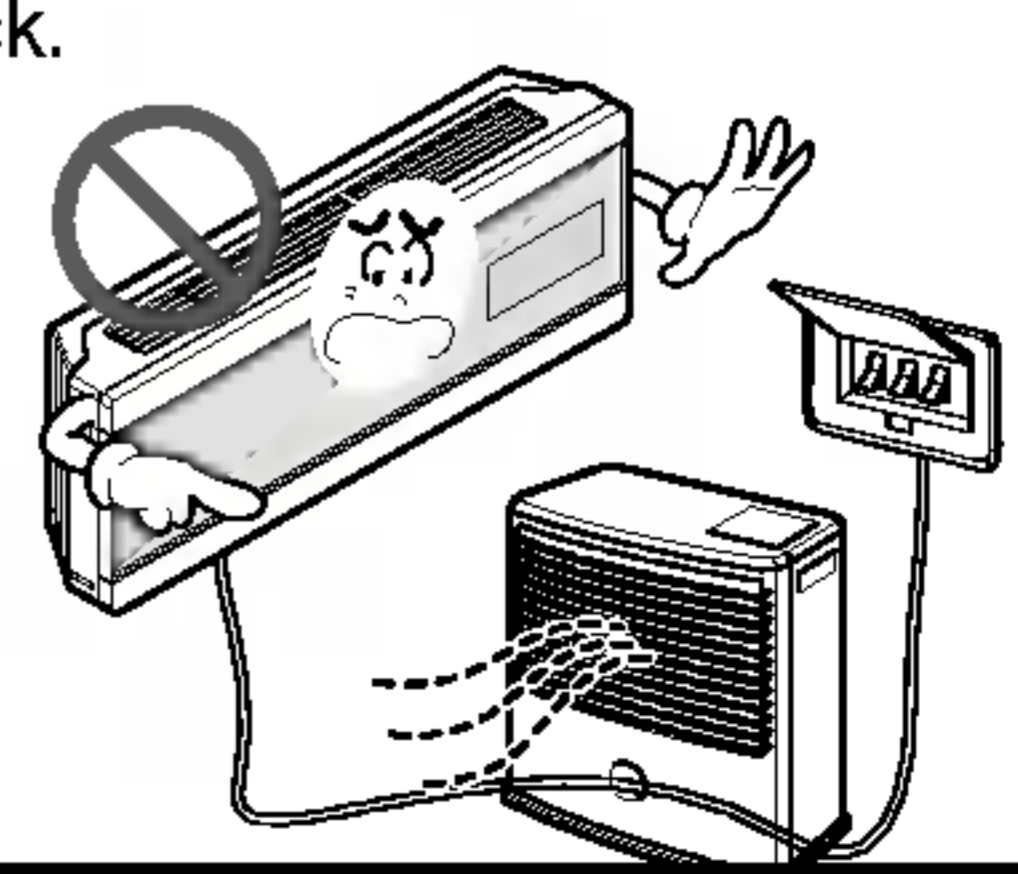

Do not allow water to run into electric parts.

- It may cause There is risk of fire, failure of the product, or electric shock.

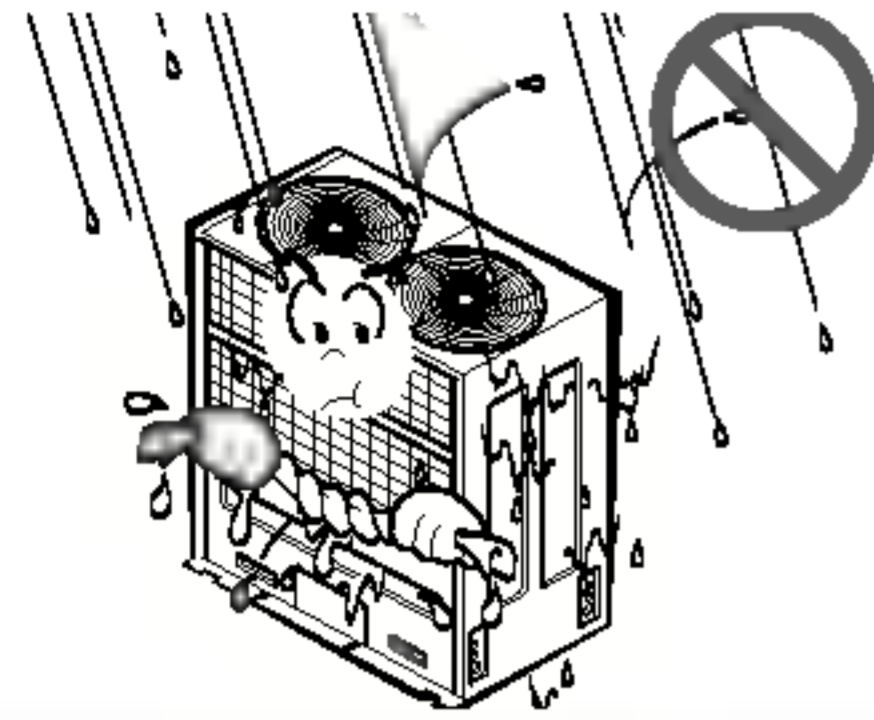

Do not store or use flammable gas or combustibles near the product.

- There is risk of fire or failure of product.

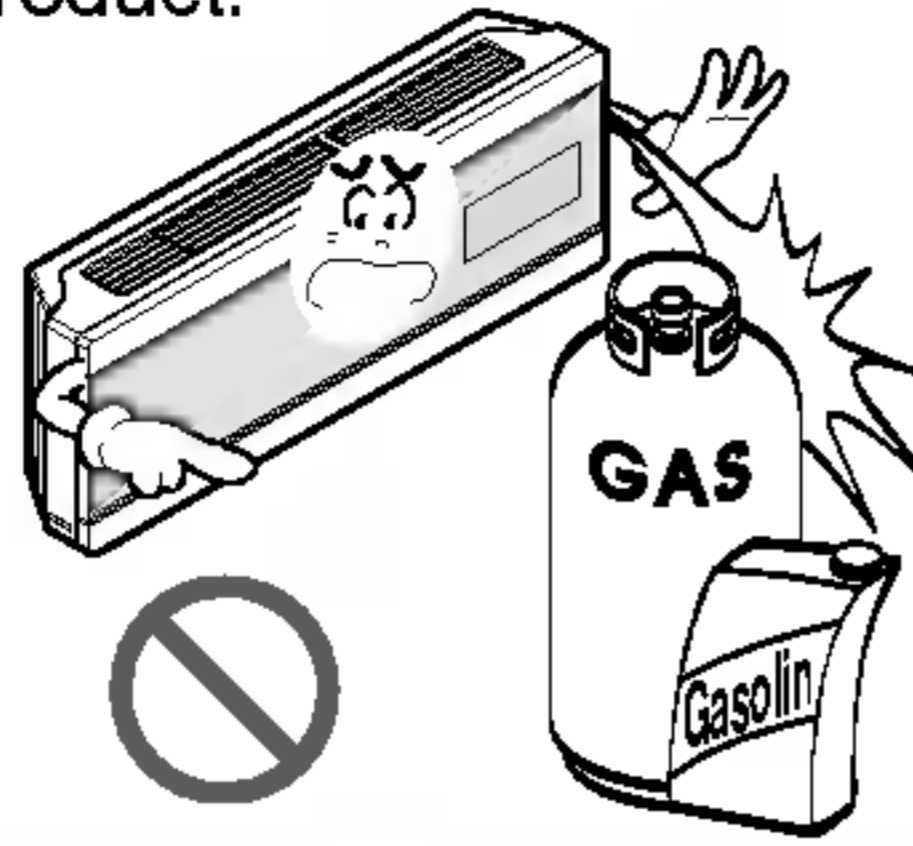

Do not use the product in a tightly closed space for a long time.

- Oxygen deficiency could occur.

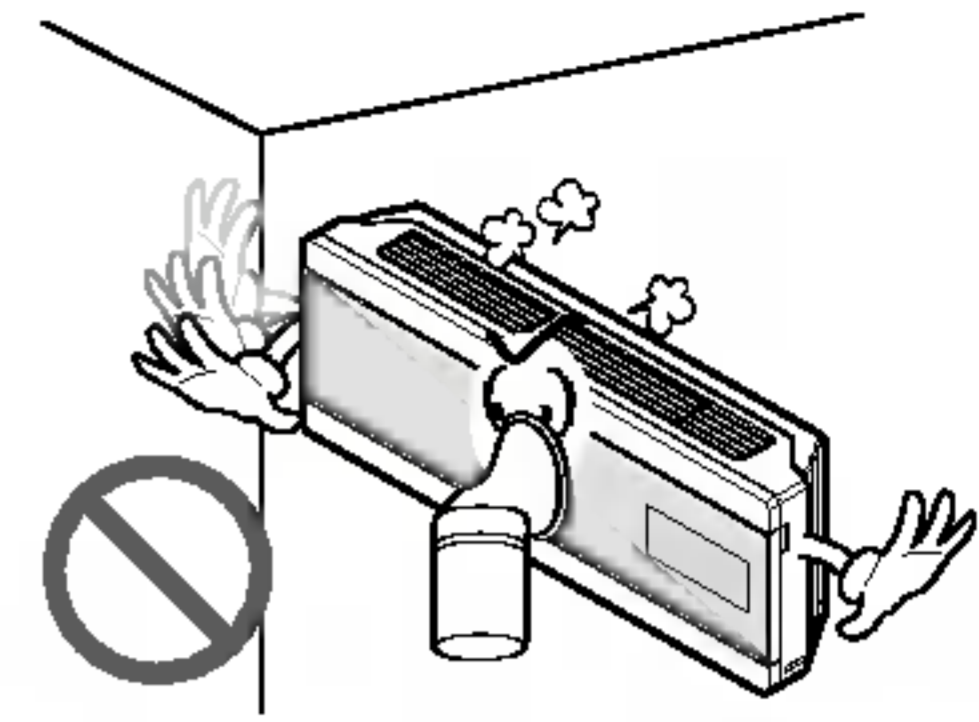

When flammable gas leaks, turn off the gas and open a window for ventilation before turn the product on.

- Do not use the telephone or turn switches on or off. There is risk of explosion or fire

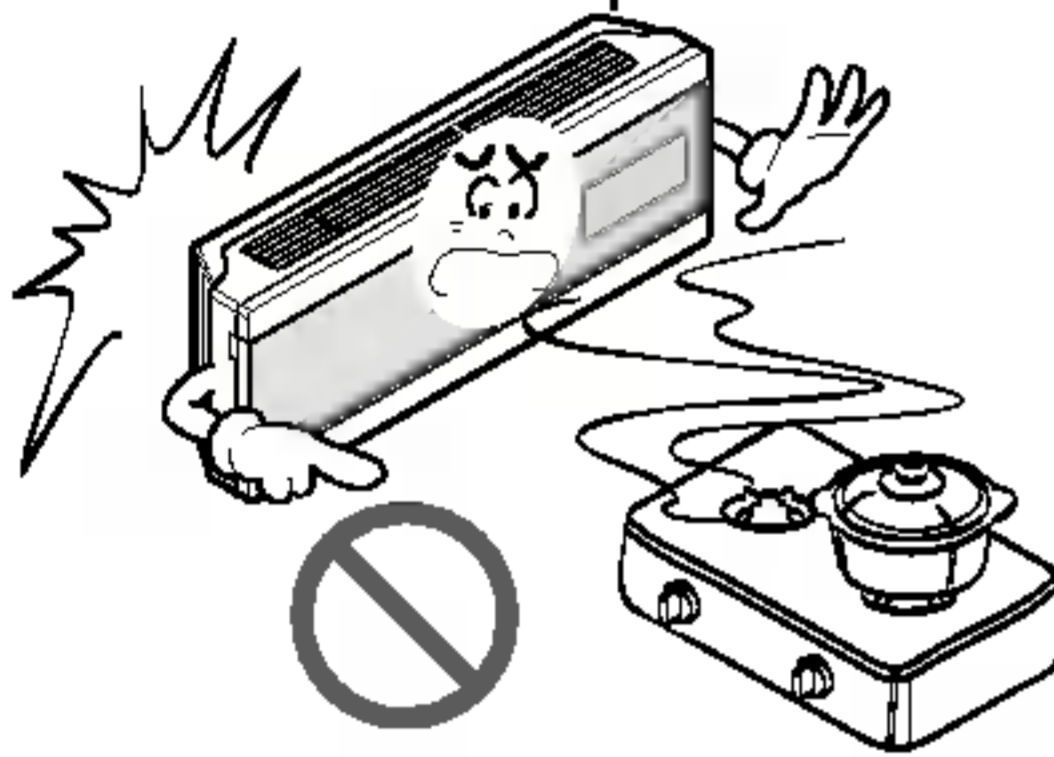

If strange sounds, or small or smoke comes from product. Turn the breaker off or disconnect the power supply cable.

- There is risk of electric shock or fire.



Stop operation and close the window in storm or hurricane. If possible, remove the product from the window before the hurricane arrives.

- There is risk of property damage, failure of product, or electric shock.

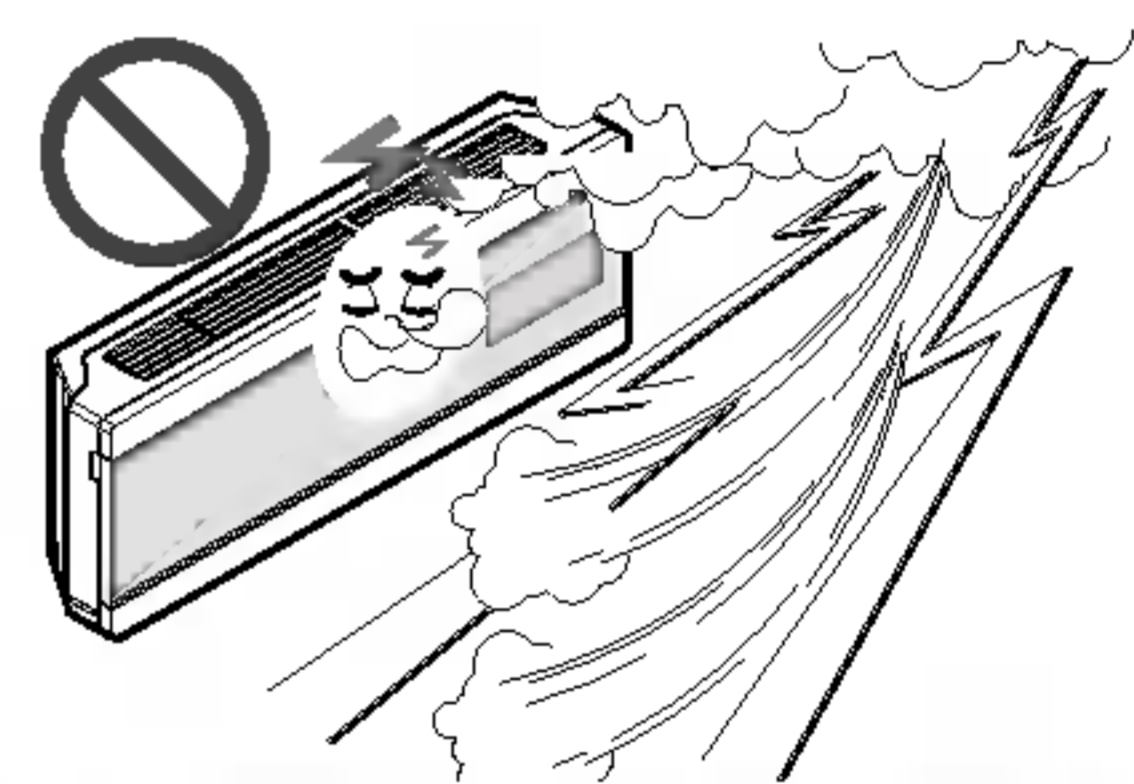

Do not open the inlet grill of the product during operation. (Do not touch the electrostatic filter, if the unit is so equipped.)

- There is risk of physical injury, electric shock, or product failure.

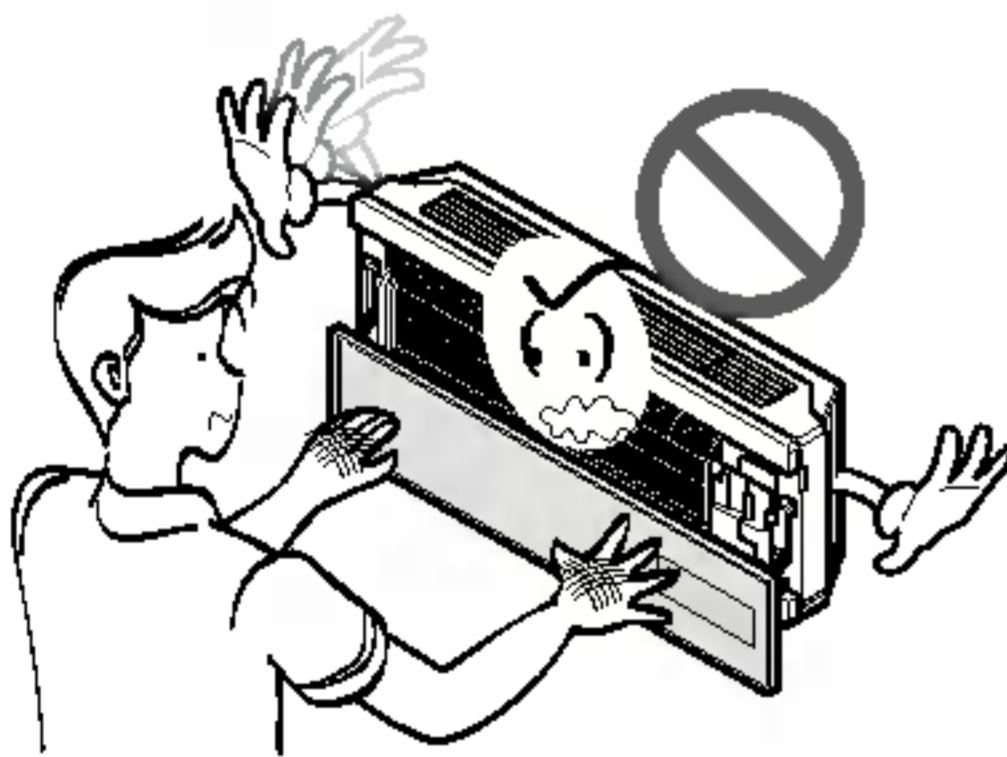

When the product is soaked (flooded or submerged), contact an Authorized Service Center.

- There is risk of fire or electric shock.



Be cautious that water could not enter the product.

- There is risk of fire, electric shock, or product damage.

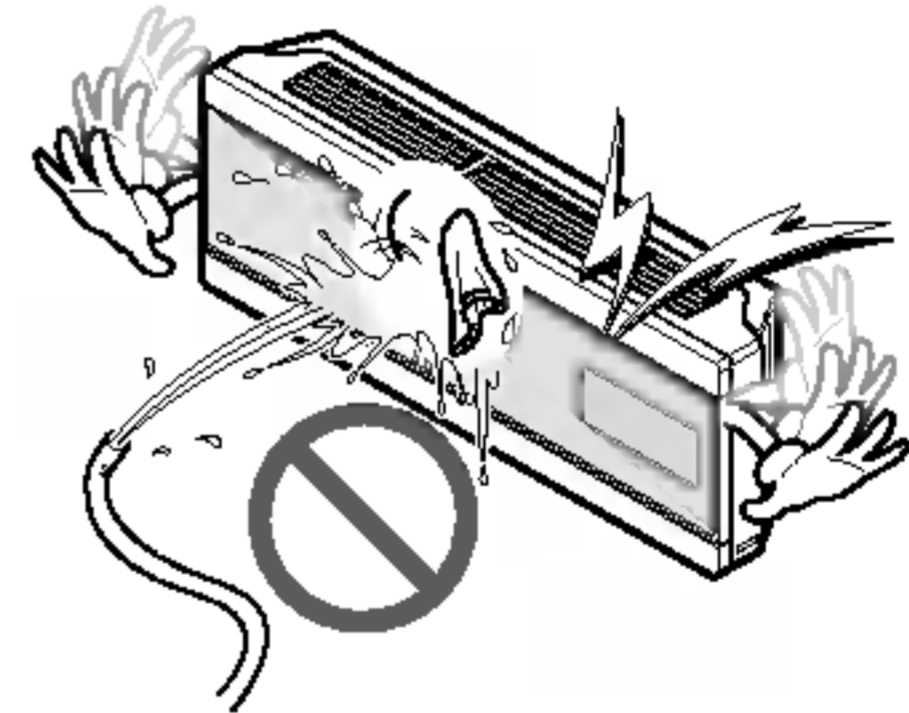

Ventilate the product from time to time when operating it together with a stove, etc.

- There is risk of fire or electric shock.

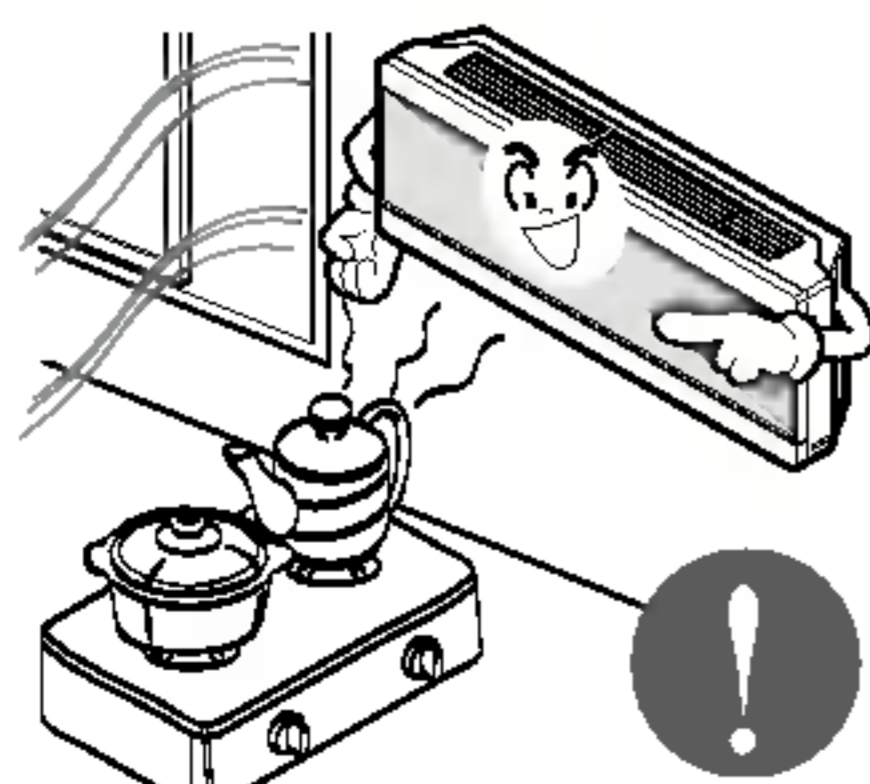

Turn the main power off when cleaning or maintaining the product.

- There is risk of electric shock.

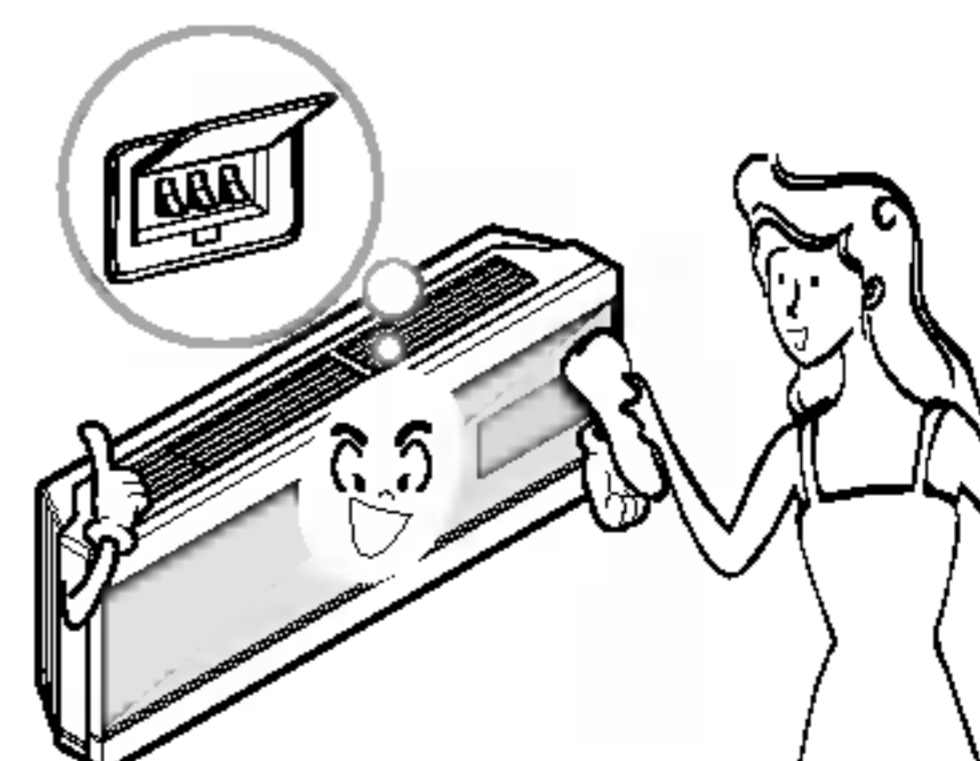

When the product is not be used for a long time, disconnect the power supply plug or turn off the breaker.

- There is risk of product damage or failure, or unintended operation.

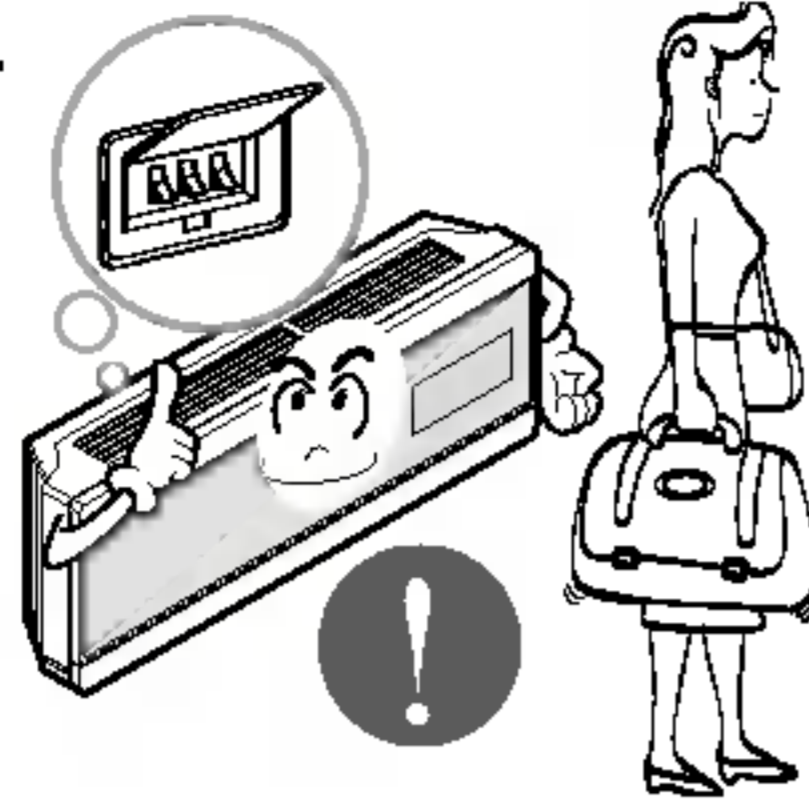

Take care to ensure that nobody could step on or fall onto the outdoor unit.

- This could result in personal injury and product damage.

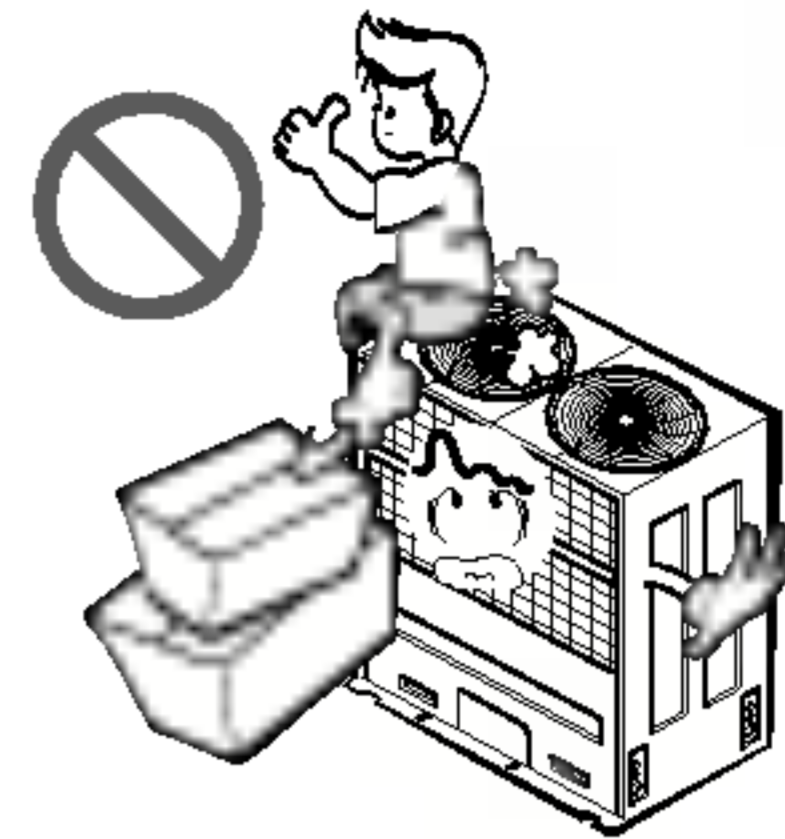

CAUTION

Installation

Always check for gas (refrigerant) leakage after installation or repair of product.

- Low refrigerant levels may cause failure of product.

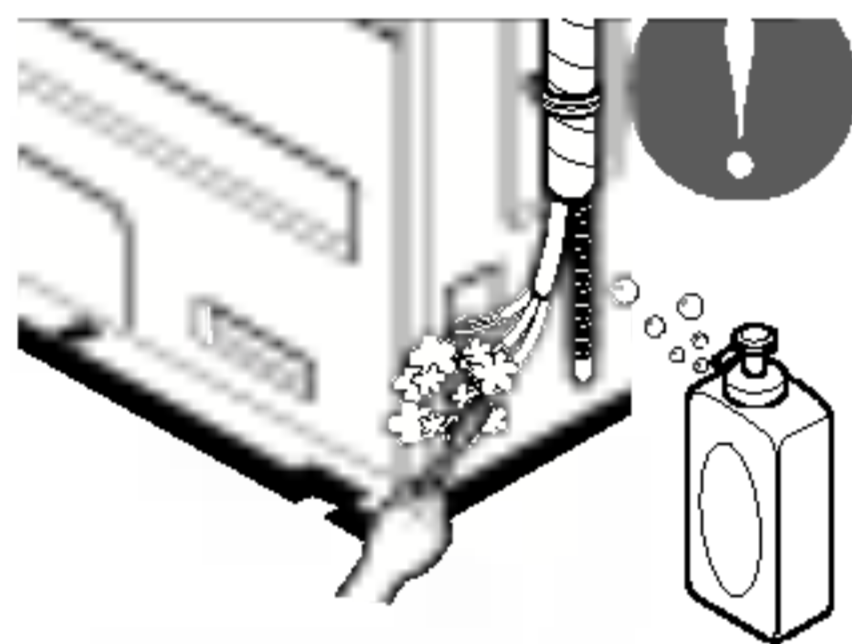

Install the drain hose to ensure that water is drained away properly.

- A bad connection may cause water leakage.

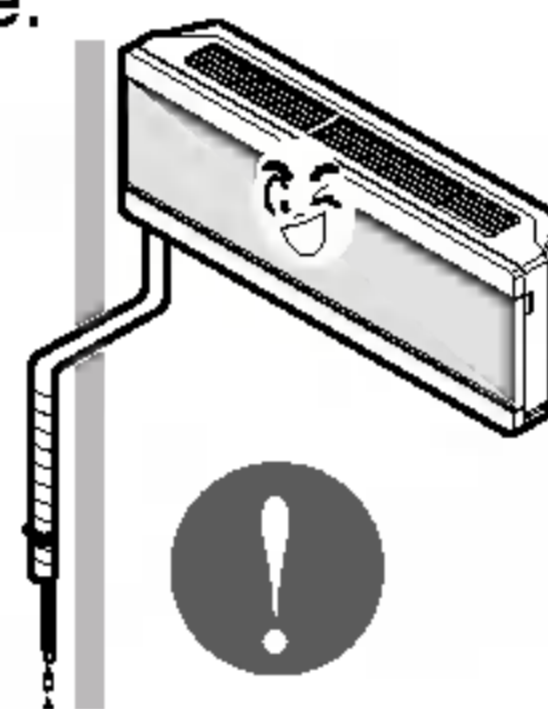

Keep level even when installing the product.

- To avoid vibration or water leakage.

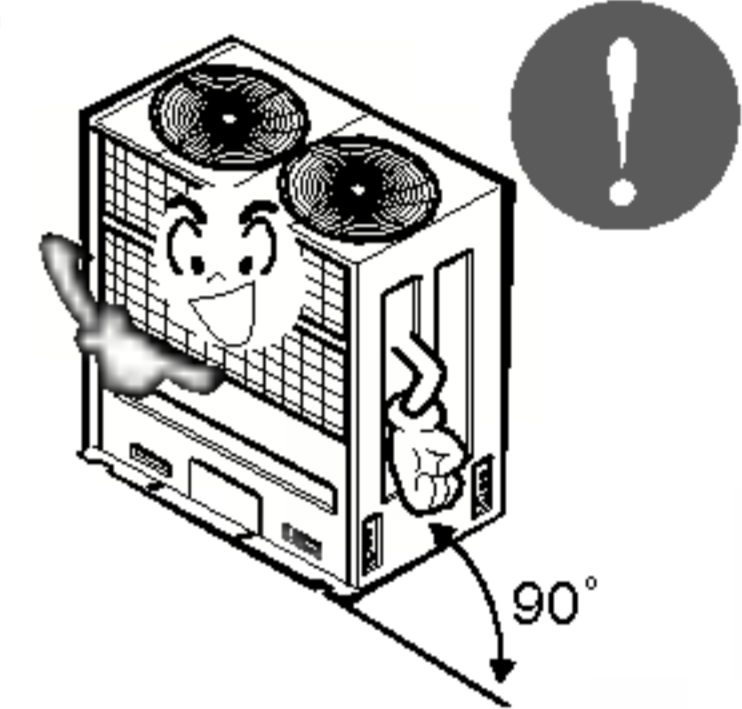

Do not install the product where the noise or hot air from the outdoor unit could damage the neighborhoods.

- It may cause a problem for your neighbors.

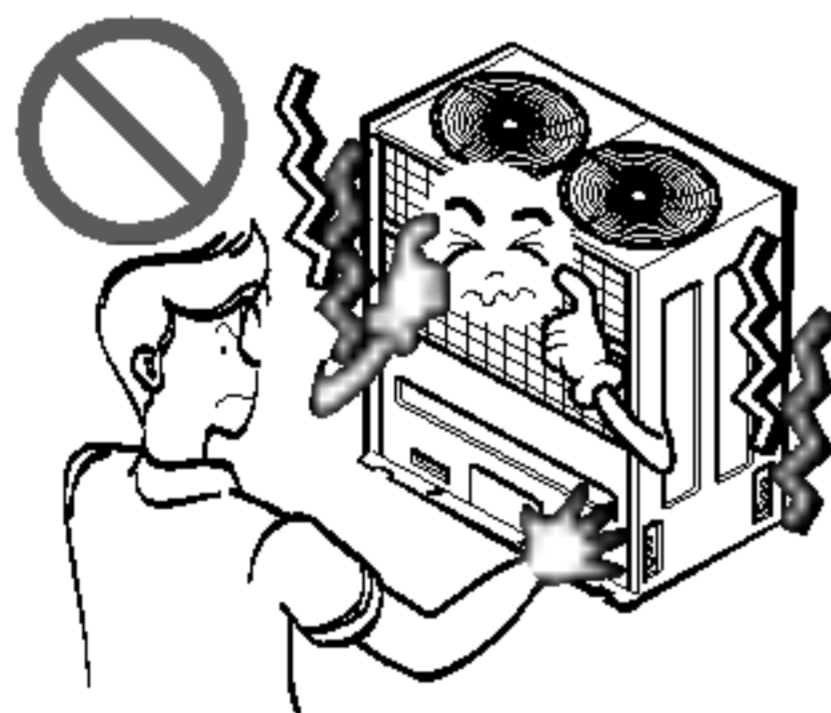

Use two or more people to lift and transport the product.

- Avoid personal injury.

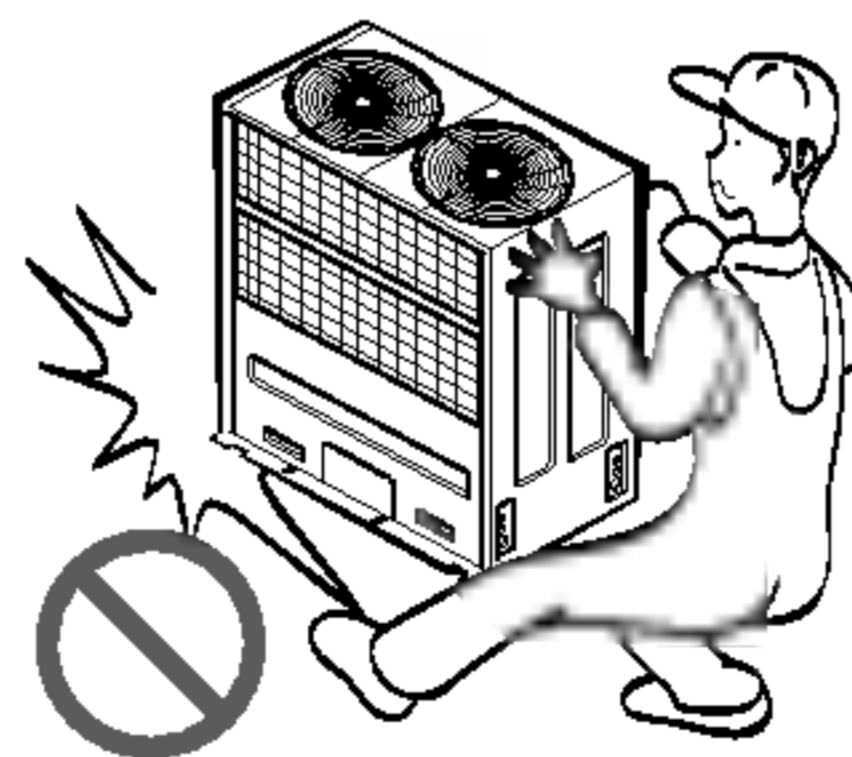

Do not install the product where it will be exposed to sea wind (salt spray) directly.

- It may cause corrosion on the product. Corrosion, particularly on the condenser and evaporator fins, could cause product malfunction or inefficient operation.

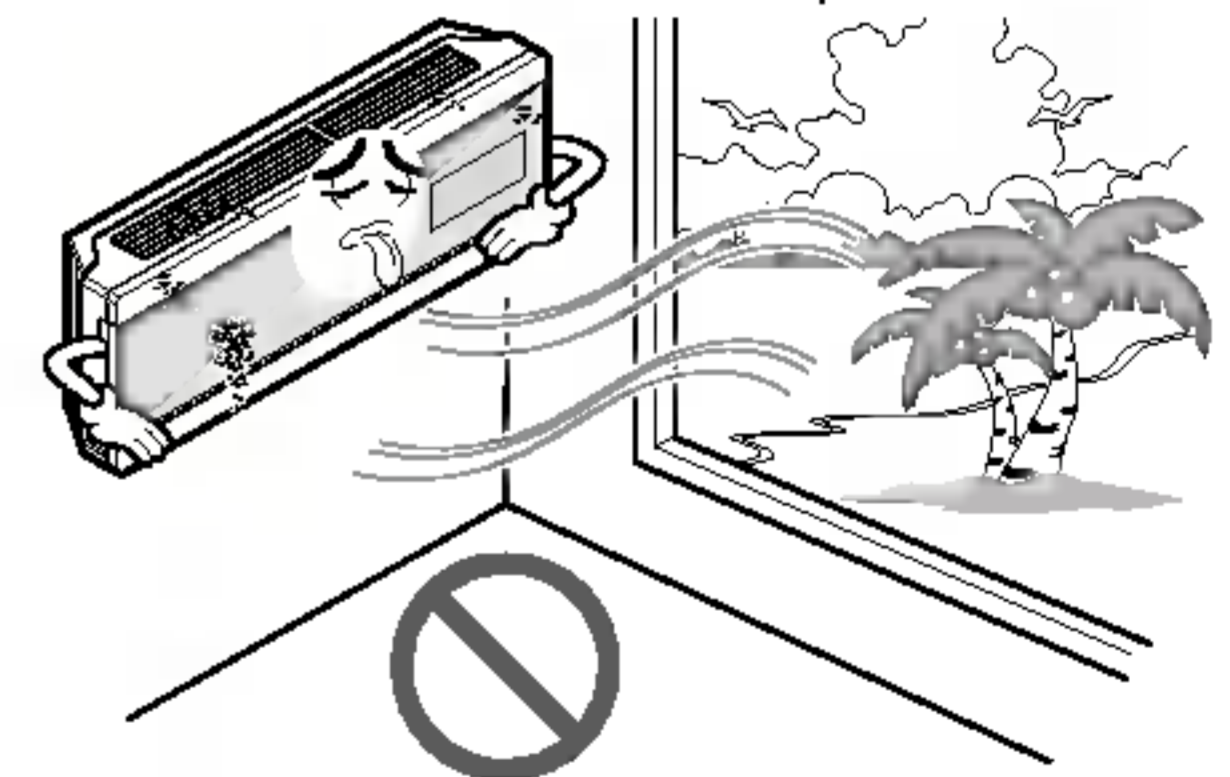

Operation

Do not expose the skin directly to cool air for long periods of time. (Don't sit in the draft.)

- This could harm to your health.

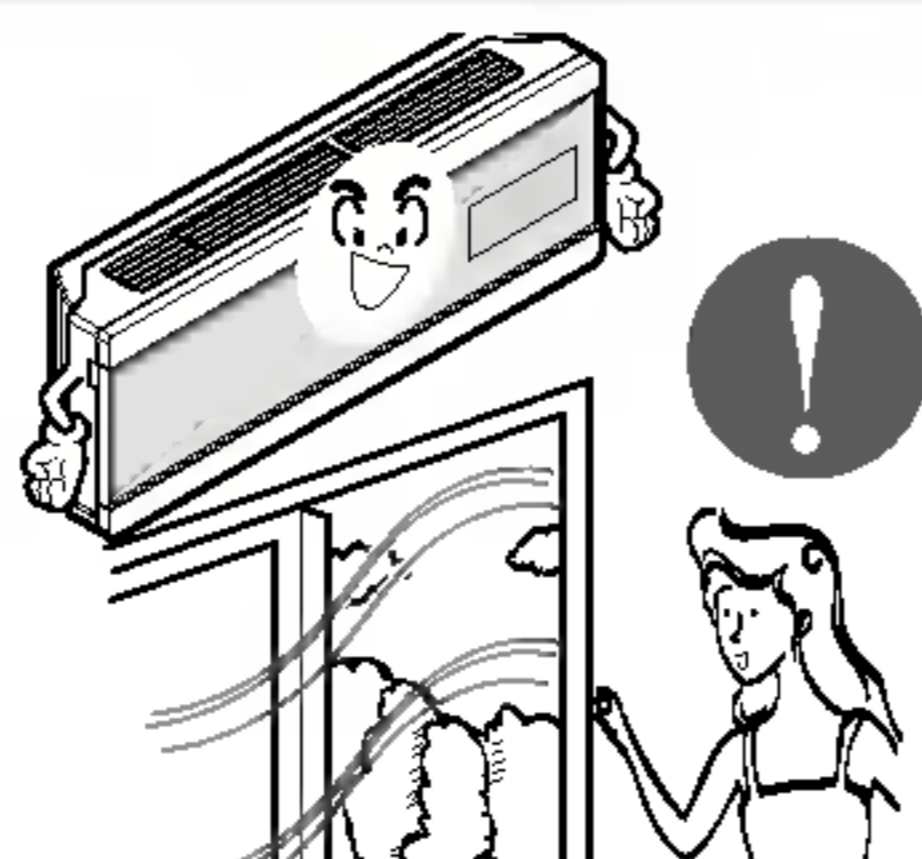

Do not use the product for special purposes, such as preserving foods, works of art, etc. It is a consumer air conditioner, not a precision refrigeration system.

- There is risk of damage or loss of property.

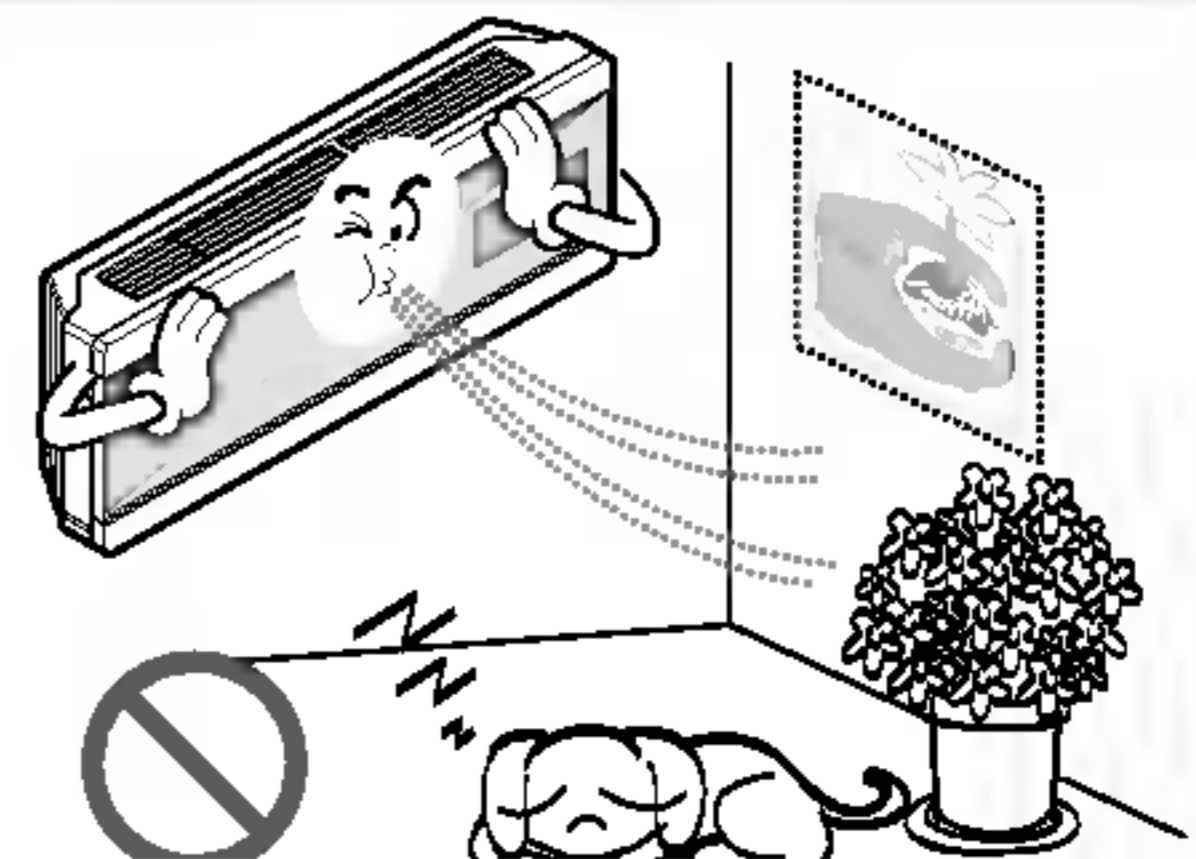

Do not block the inlet or outlet of air flow.

- It may cause product failure.

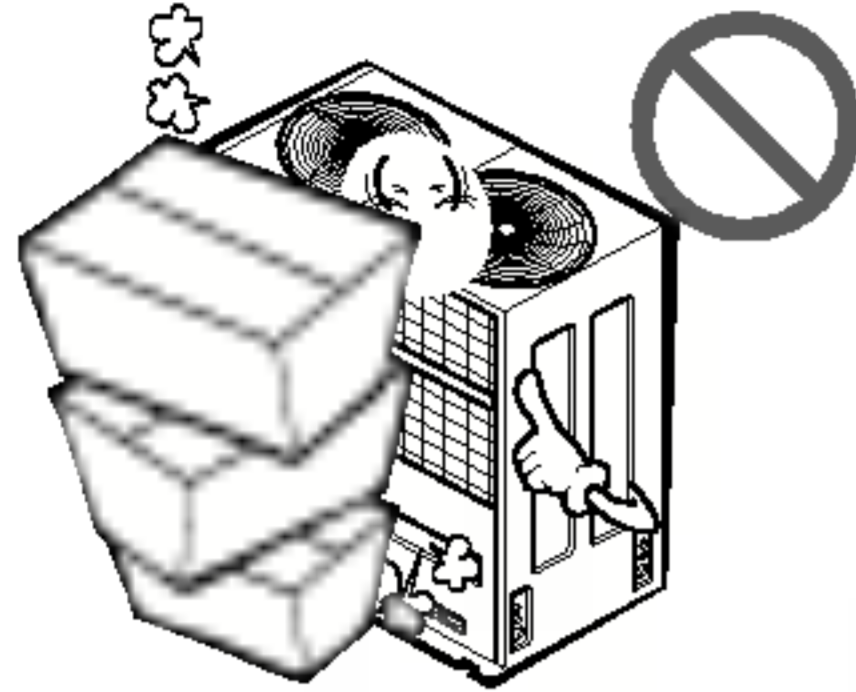

Use a soft cloth to clean. Do not use harsh detergents, solvents, etc.

- There is risk of fire, electric shock, or damage to the plastic parts of the product.

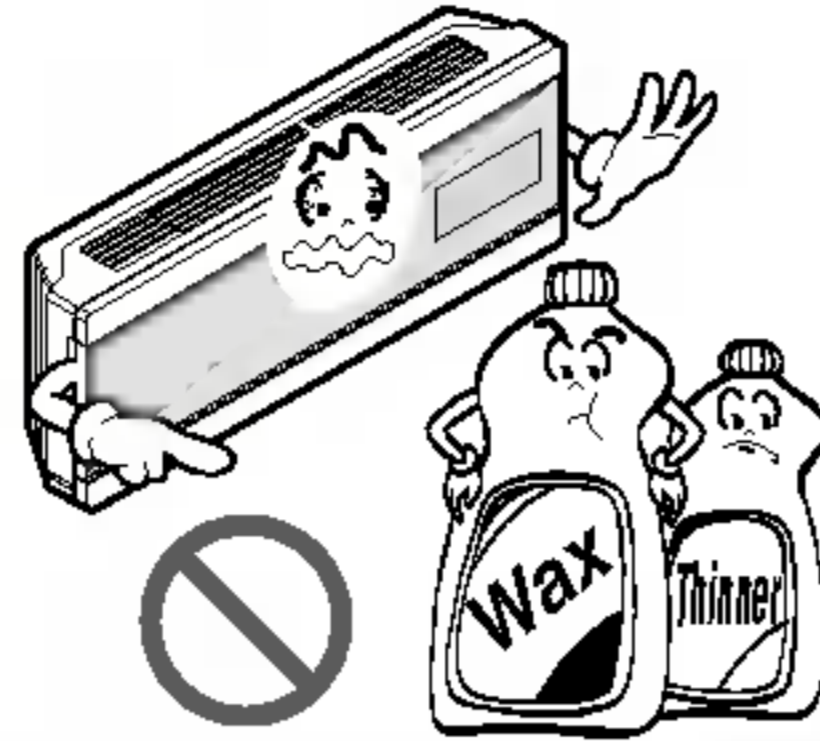

Do not touch the metal parts of the product when removing the air filter. They are very sharp!

- There is risk of personal injury.

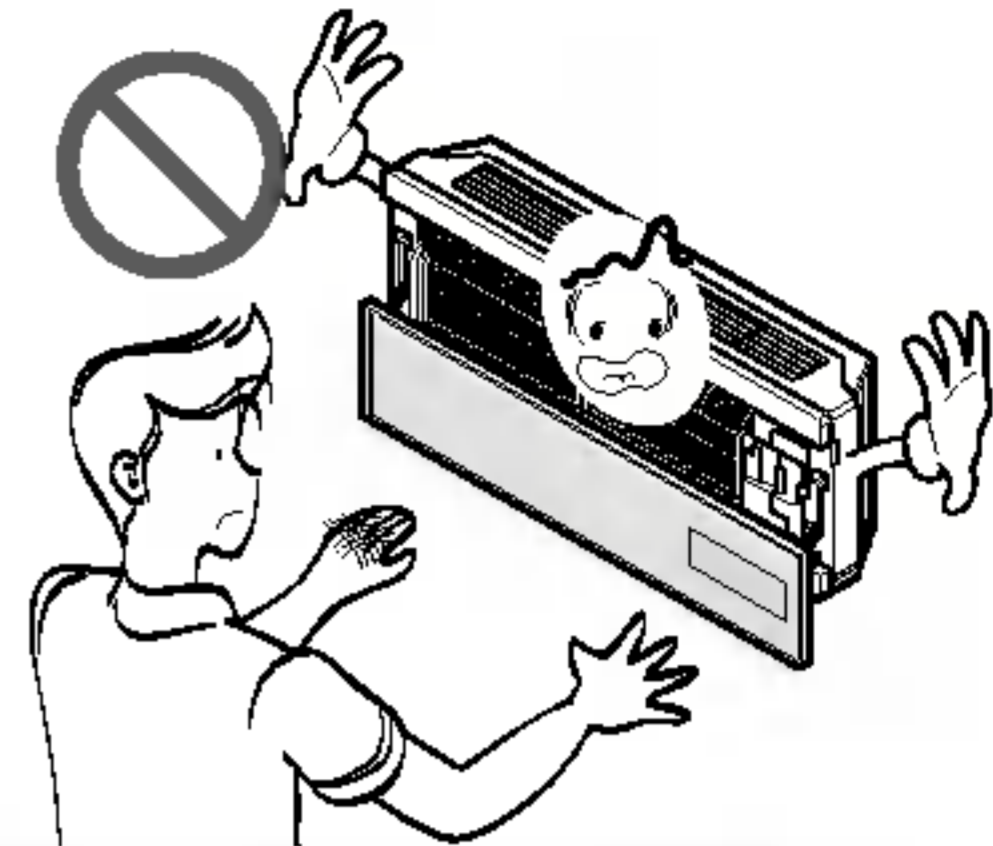

Do not step on or put anything on the product. (outdoor units)

- There is risk of personal injury and failure of product.

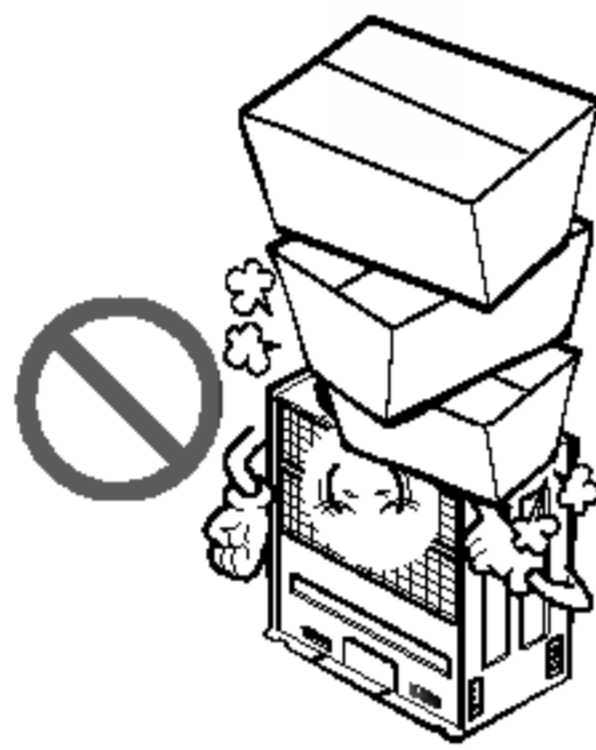

Always insert the filter securely. Clean the filter every two weeks or more often if necessary.

- A dirty filter reduces the efficiency of the air conditioner and could cause product malfunction or damage.

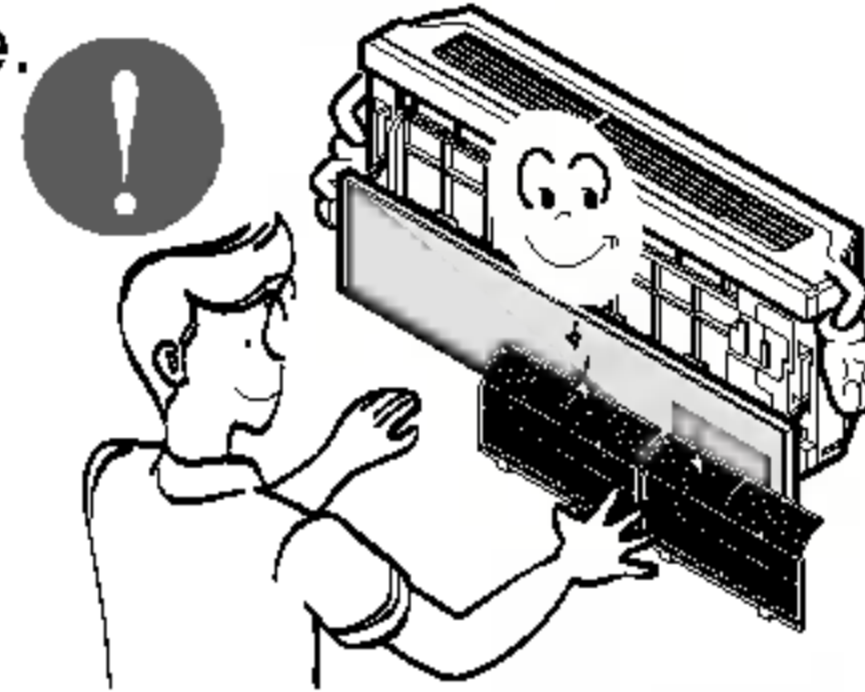

Do not insert hands or other objects through the air inlet or outlet while the product is operated.

- There are sharp and moving parts that could cause personal injury.

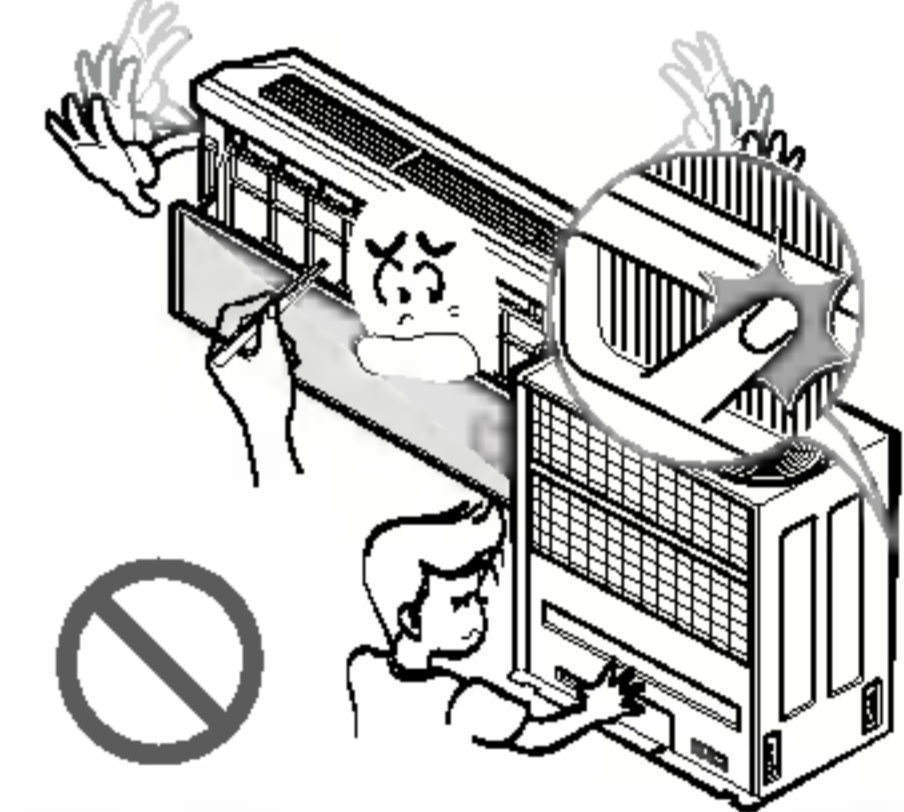

Do not drink the water drained from the product.

- It is not sanitary and could cause serious health issues.

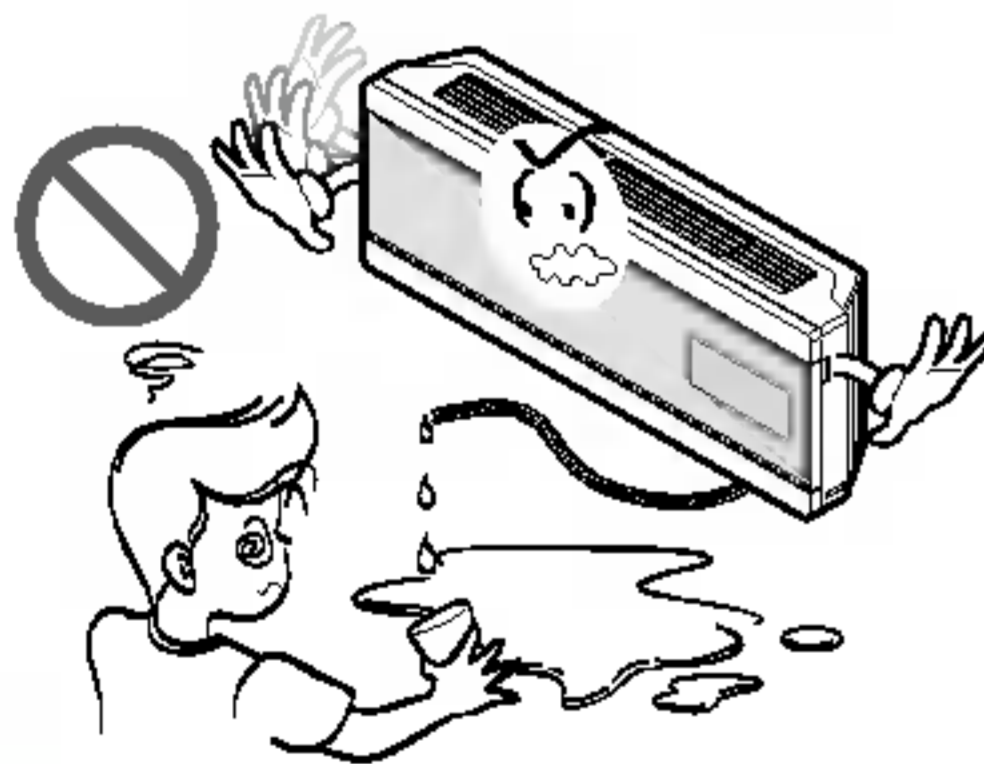

Use a firm stool or ladder when cleaning or maintaining the product.

- Be careful and avoid personal injury.

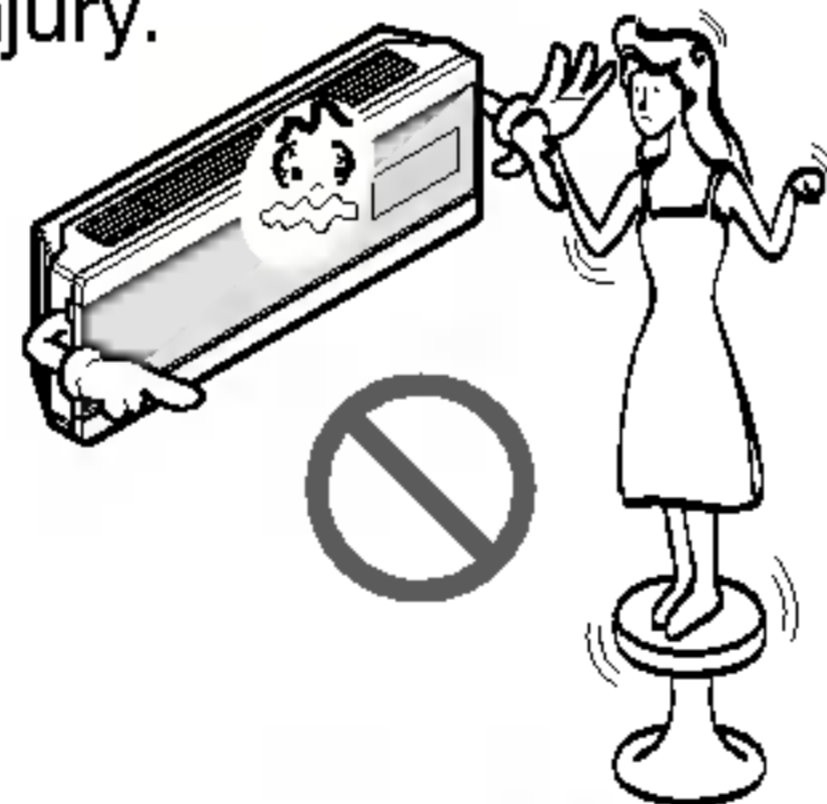

Replace the all batteries in the remote control with new ones of the same type. Do not mix old and new batteries or different types of batteries.

- There is risk of fire or explosion

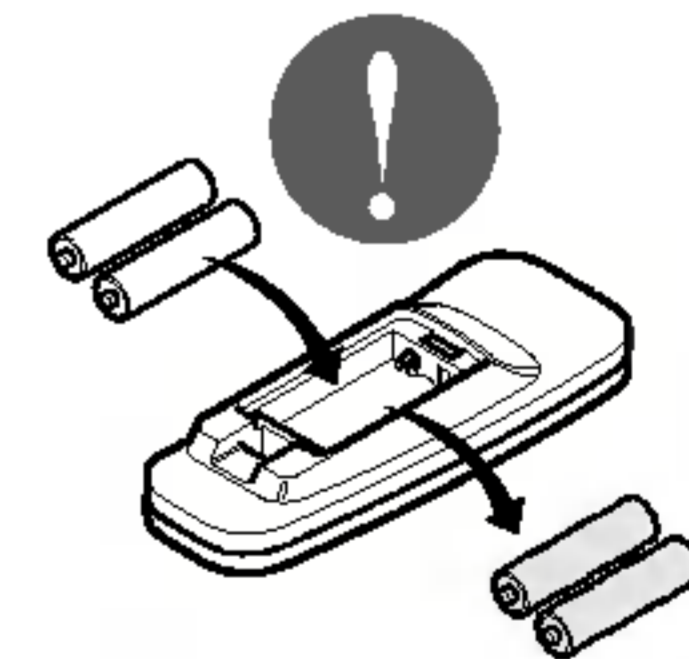

Do not recharge or disassemble the batteries. Do not dispose of batteries in a fire.

- They may burn or explode.

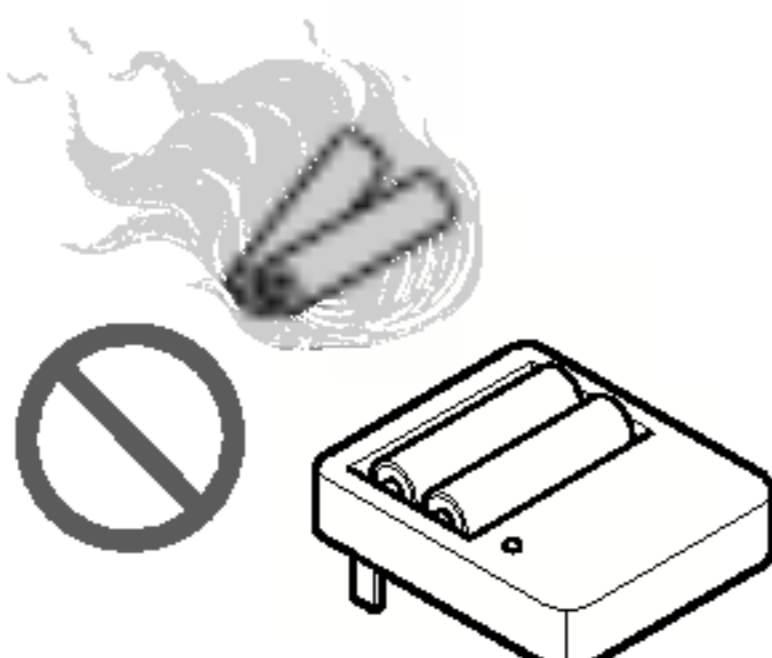

If the liquid from the batteries gets onto your skin or clothes, wash it well with clean water. Do not use the remote if the batteries have leaked.

- The chemicals in batteries could cause burns or other health hazards.

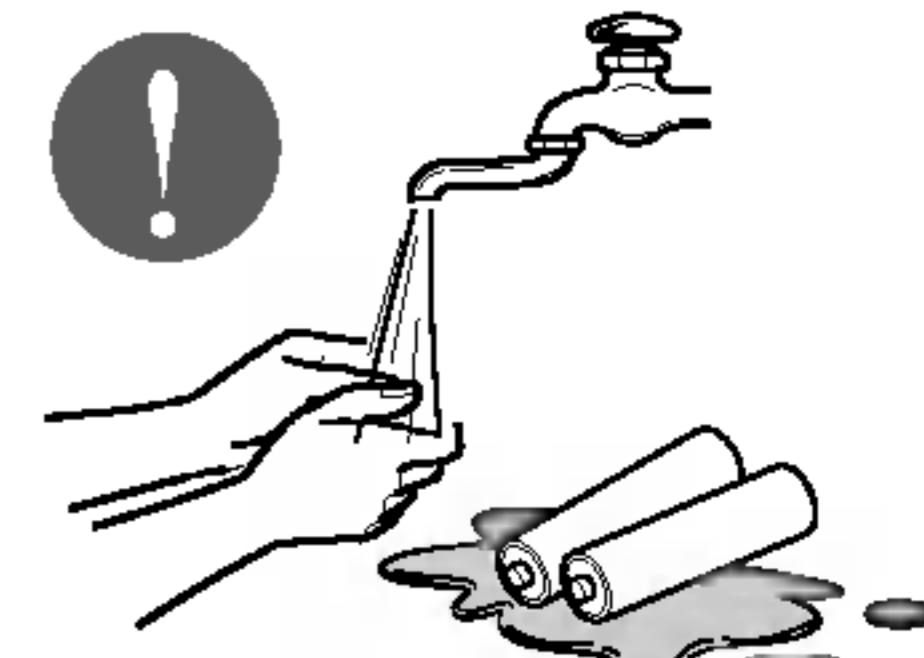

Prior to Operation

Preparing for operation

1. Contact an installation specialist for installation.
2. Use a dedicated circuit.

Usage

1. Being exposed to direct airflow for an extended period of time could be hazardous to your health. Do not expose occupants, pets, or plants to direct airflow for extended periods of time.
2. Due to the possibility of oxygen deficiency, ventilate the room when used together with stoves or other heating devices.
3. Do not use this air conditioner for non-specified special purposes (e.g. preserving precision devices, food, pets, plants, and art objects). Such usage could damage the items.

Cleaning and maintenance

1. Do not touch the metal parts of the unit when removing the filter. Injuries can occur when handling sharp metal edges.
2. Do not use water to clean inside the air conditioner. Exposure to water can destroy the insulation, leading to possible electric shock.
3. When cleaning the unit, first make sure that the power and breaker are turned off. The fan rotates at a very high speed during operation. There is a possibility of injury if the unit's power is accidentally triggered on while cleaning inner parts of the unit.

Service

For repair and maintenance, contact your authorized service dealer.

Operating Instructions

Preparation before operation

How to Insert the Batteries

1. Remove the battery cover by pulling it according to the arrow direction.
2. Insert new batteries making sure that the (+) and (-) of battery are installed correctly.
3. Reattach the cover by sliding it back into position.

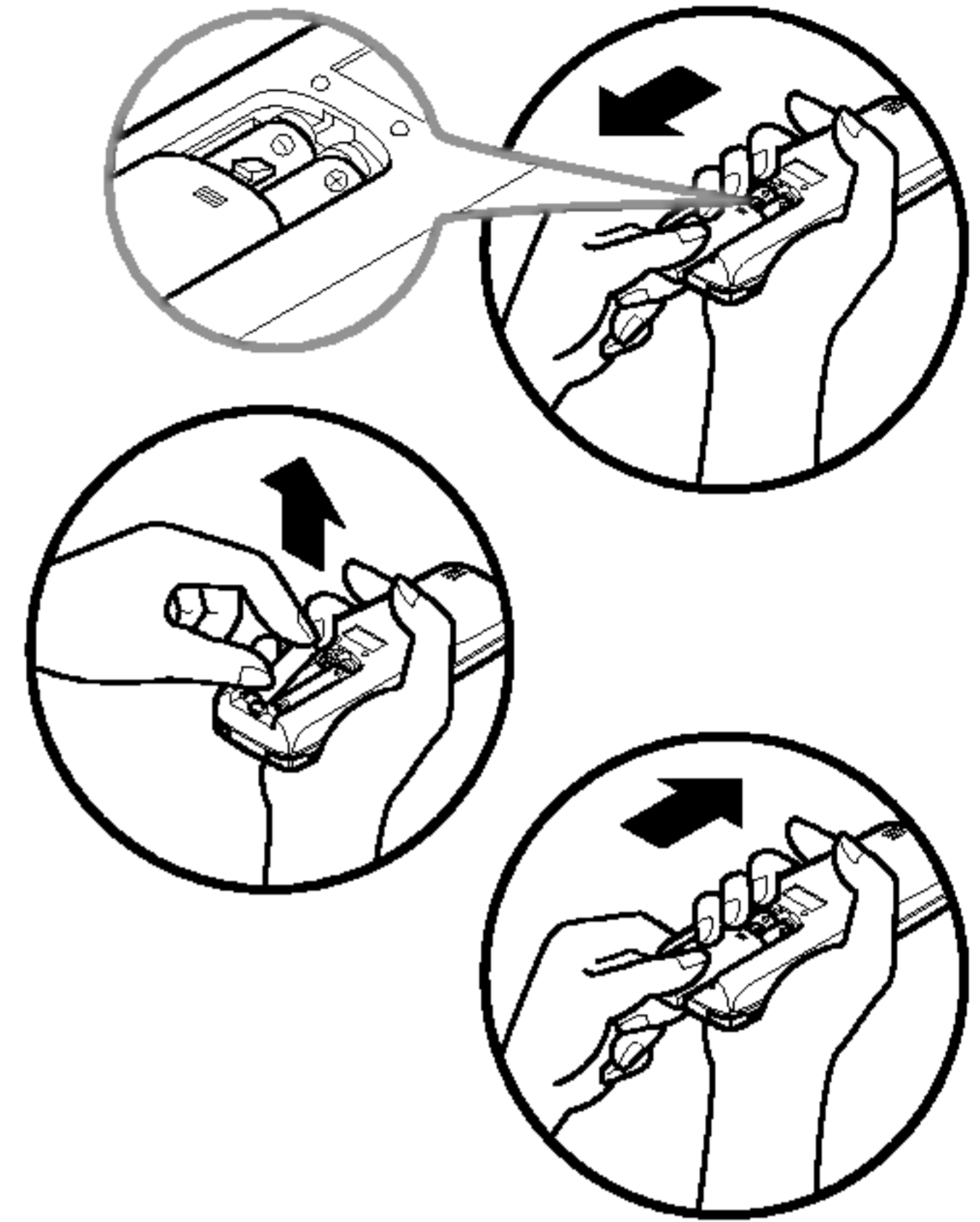

NOTICE Use 2 AAA(1.5volt) batteries.
Do not use rechargeable batteries.

Storage and Tips For Using the Remote Controller

- The remote controller may be stored by mounting it on a wall.
- To operate the room air conditioner, aim the remote controller at the signal receptor.

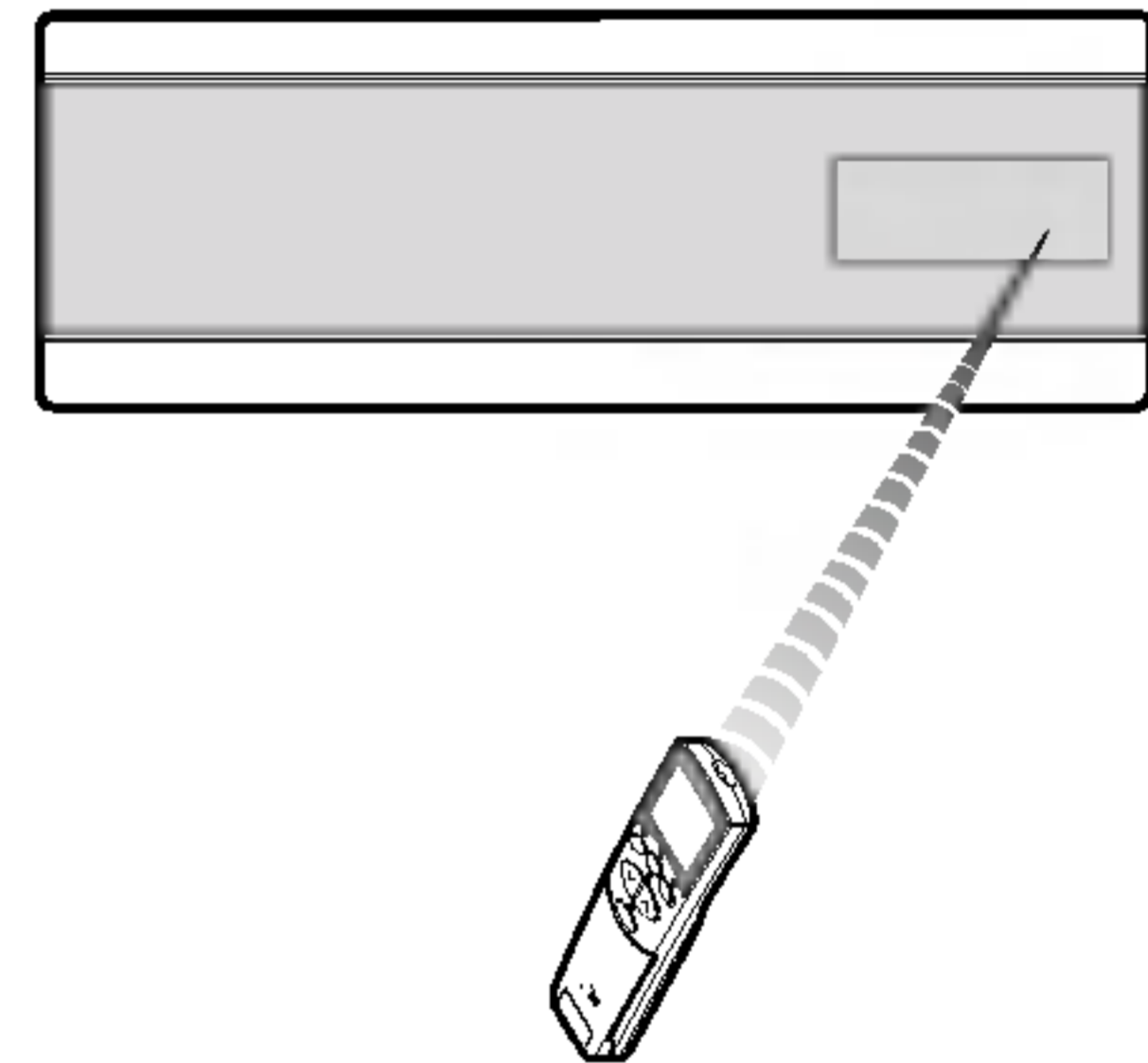
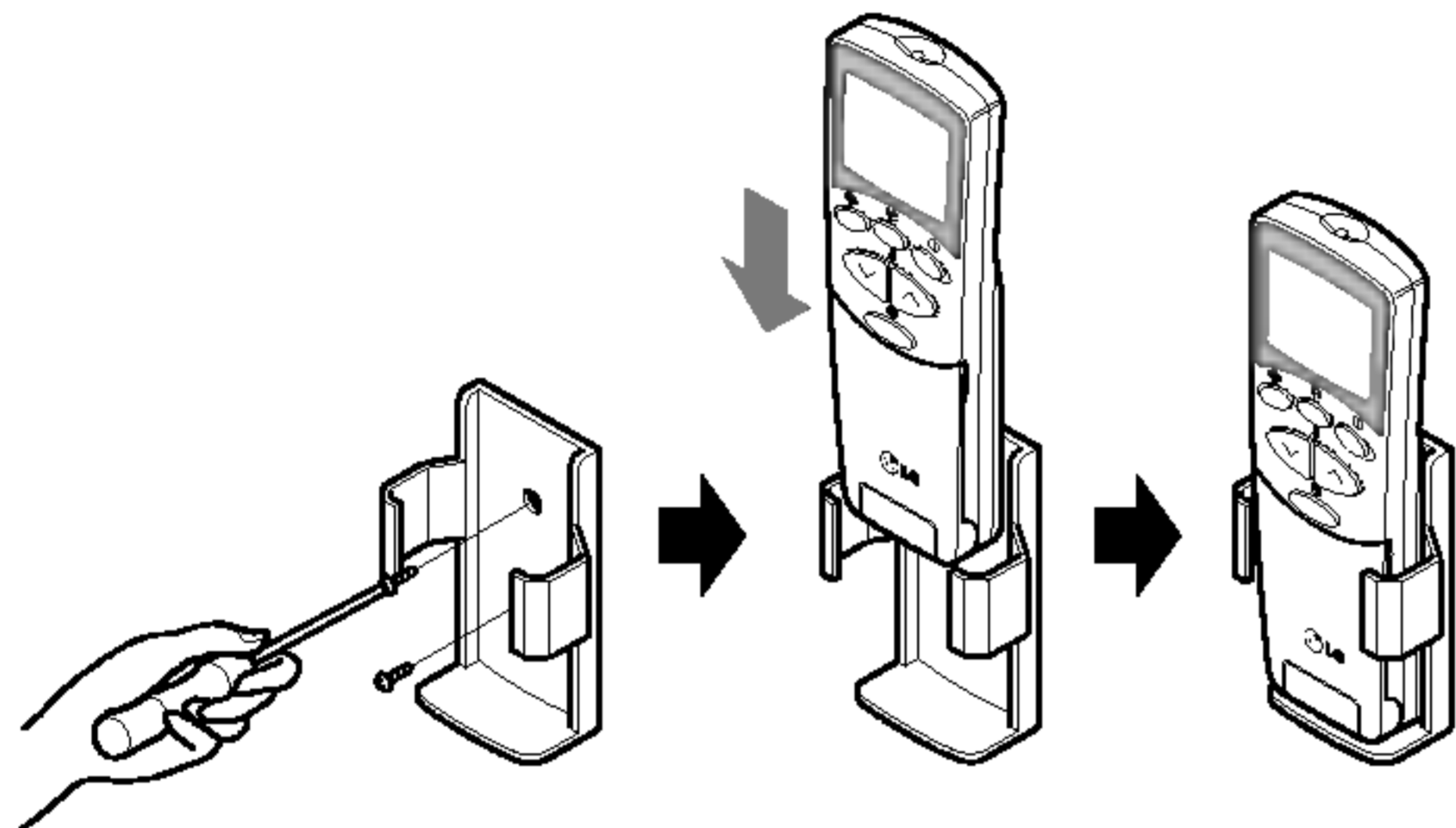

Signal Receptor

Receives the signals from the remote controller.(Signal receiving sound: two short beeps or one long beep.)

Operation Indication Lamps

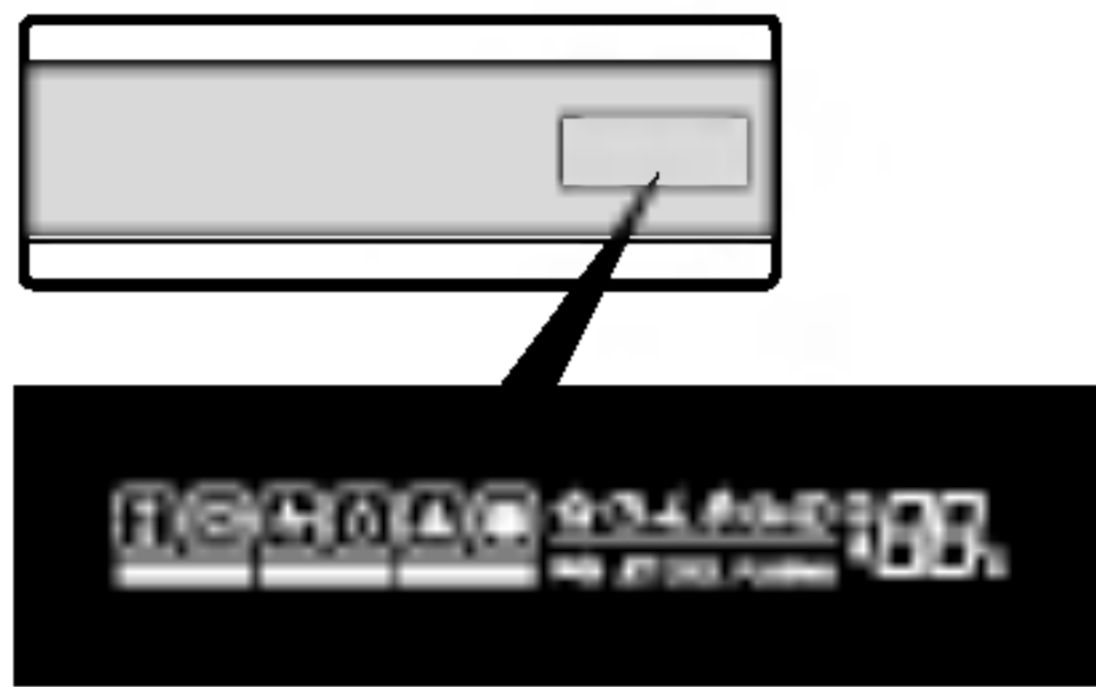

Each icon shows its own function mode.

	Cooling Mode	Lights up during Cooling operation. (Outline)
	Auto Operation Mode	Lights up during Auto operation. (Outline)
	Healthy Dehumidification Mode	Lights up during Healthy Dehumidification operation. (Outline)
	Heating Mode	Lights up during Heating operation. (Heat Pump model only) (Outline)
	Defrost Mode	Lights up during Defrost controller or Hot Start in Heating operation. (Outline)
	Air circulation Mode	Lights up during Air Circulation operation. (Outline)
	Sleep Mode	Lights up during Sleep Mode operation.
	Timer	Lights up during Timer operation.
	Auto Cleaning Mode	Lights up during Auto Cleaning reservation.
JET COOL	Jet Cool Mode	Lights up during Jet Cool Operation.
PLASMA	Plasma	Lights up during Plasma operation.
	Fan Speed (Low)	Lights up when Fan speed is low.
	Fan Speed (Medium)	Lights up when Fan speed is Medium.
	Fan Speed (High)	Lights up when Fan speed is High.
	Fan Speed (Chaos)	Lights up when Fan speed is Chaos.
	Desire temperature indicator	For cooling, dehumidification, heating modes it display Destired temperature <ul style="list-style-type: none"> • Cooling : 18~30°C • Dehumidification : 18~30°C • Heating : 16~30°C <ul style="list-style-type: none"> • Ai : Auto Operation • Po : Jet Cool • Lo : Test Mode
	Desire temperature Icon	
	Indoor temperature Icon	

About the remote controller on the system

The Remote Controller transmits the signals to the system.

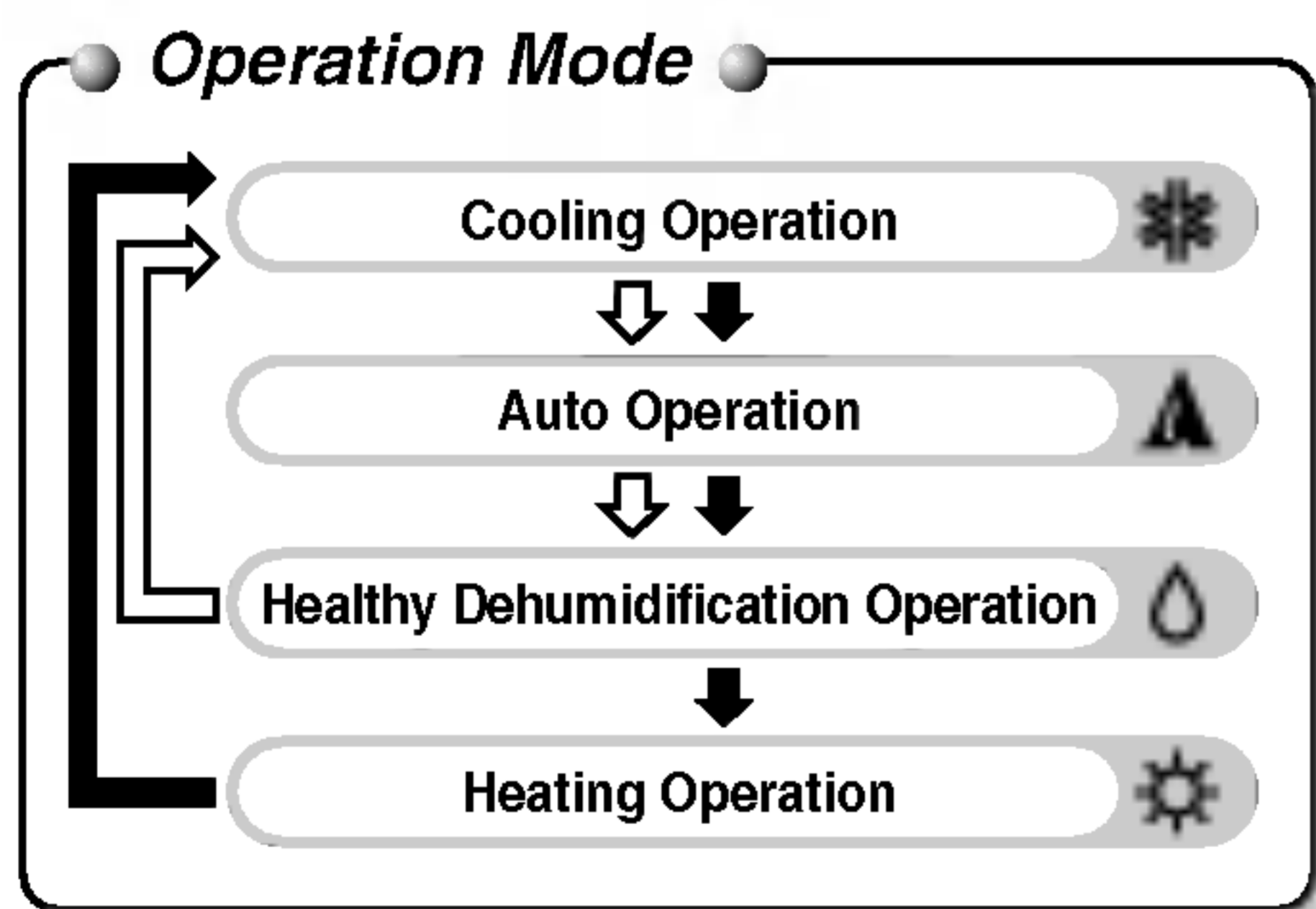
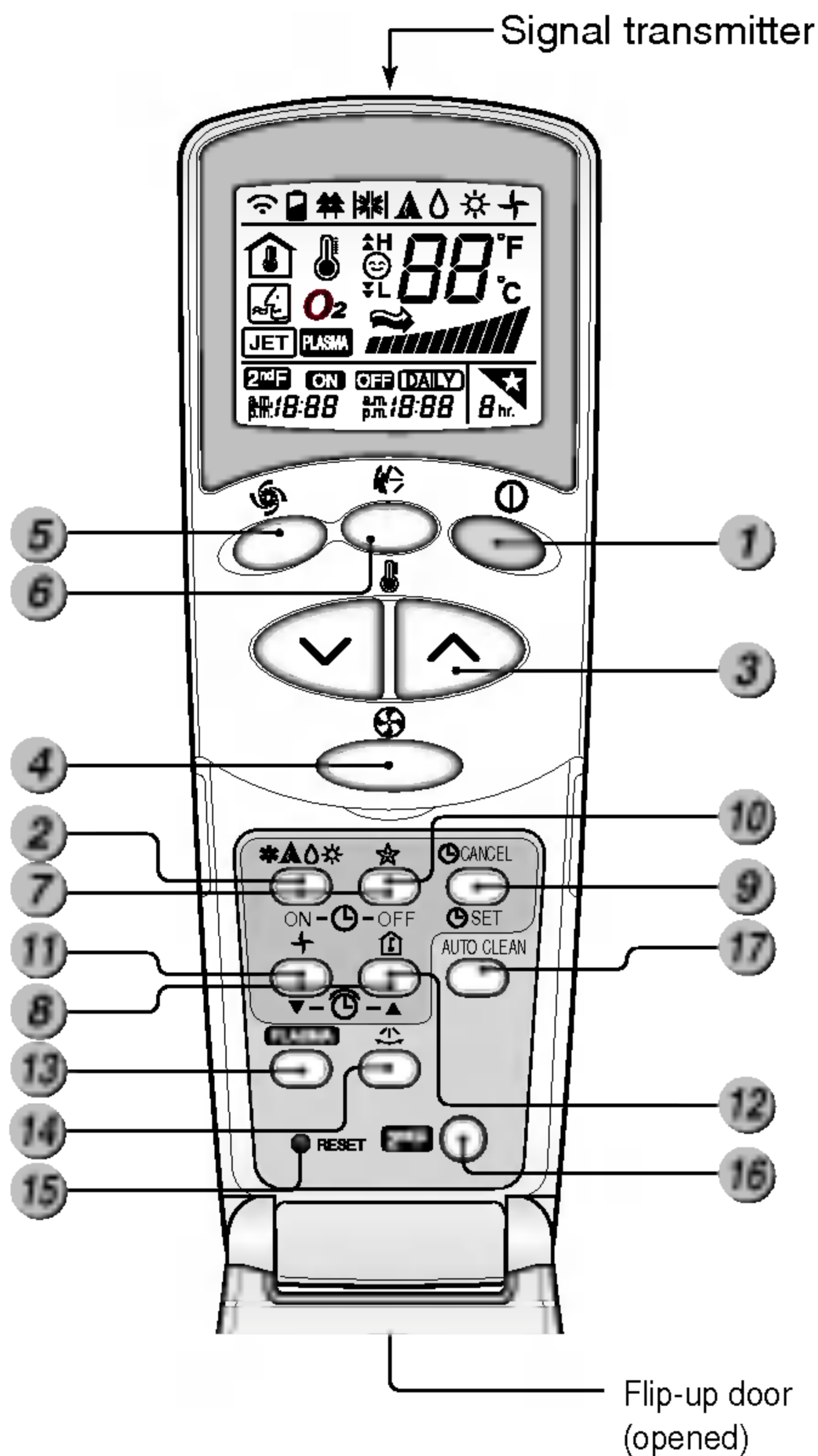

- 1 START/STOP BUTTON**
 Operation starts when this button is pressed and stops when the button is pressed again.
- 2 OPERATION MODE SELECTION BUTTON**
 Used to select the operation mode.
- 3 ROOM TEMPERATURE SETTING BUTTONS**
 Used to select the room temperature.
- 4 INDOOR FAN SPEED SELECTOR**
 Used to select fan speed in four steps low, medium, high and CHAOS.
- 5 JET COOL**
 Used to start or stop the speed cooling/heating. (Speed cooling/heating operates super high fan speed.)
- 6 CHAOS SWING BUTTON**
 Used to stop or start louver movement and set the desired up/down airflow direction.
- 7 ON/OFF TIMER BUTTONS**
 Used to set the time of starting and stopping operation.
- 8 TIME SETTING BUTTONS**
 Used to adjust the time.
- 9 TIMER SET/CANCEL BUTTON**
 Used to set the timer when the desired time is obtained and to cancel the Timer operation.
- 10 SLEEP MODE AUTO BUTTON**
 Used to set Sleep Mode Auto operation.
- 11 AIR CIRCULATION BUTTON**
 Used to circulate the room air without cooling or heating.
- 12 ROOM TEMPERATURE CHECKING BUTTON**
 Used to check the room temperature.
- 13 PLASMA**
 Used to start or stop the plasma-purification function.
- 14 HORIZONTAL AIRFLOW DIRECTION CONTROL BUTTON**
 Used to set the desired horizontal airflow direction.
- 15 RESET BUTTON**
 Initialize remote controller.
- 16 2nd F Button**
 Used prior to using modes printed in blue at the bottom of buttons.
- 17 AUTO CLEAN**
 Used to set Auto Clean mode.

ENGLISH

How to use the Operation Mode Selection Button

Cooling Operation

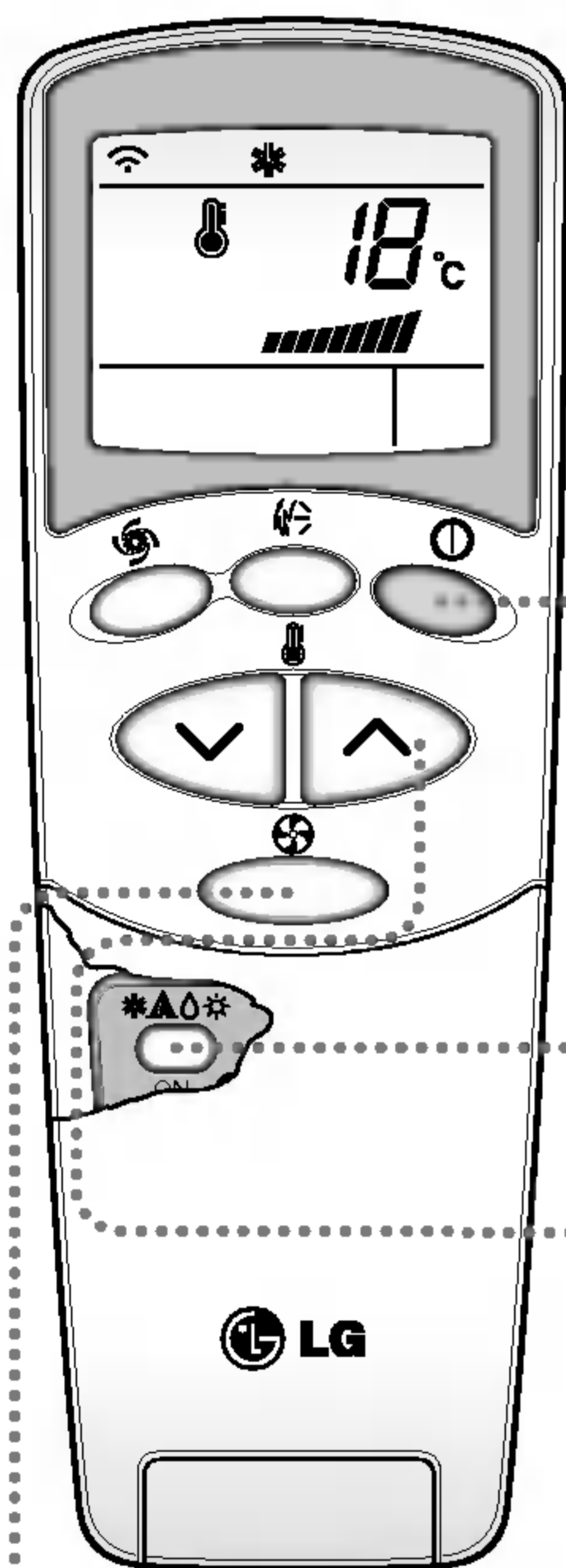

- 1** Press the Start/Stop button.
The unit will respond with beep sound.

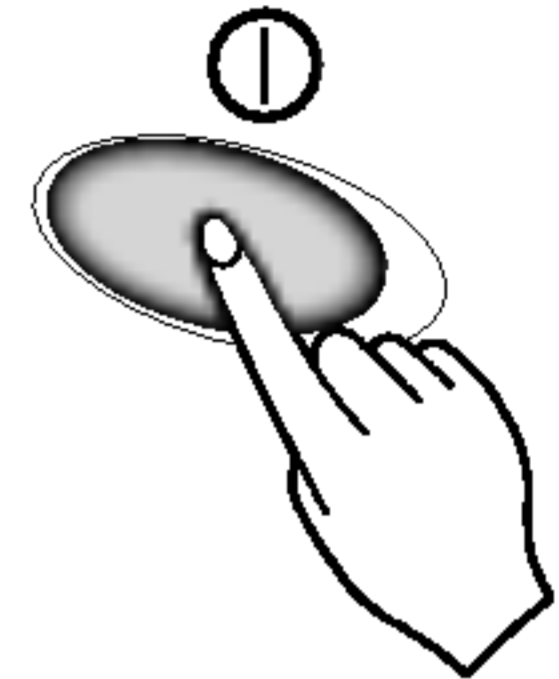

- 2** Open the door on the Remote Controller. To select **Cooling Operation**, press the Operation Mode Selection button. Each time the button is pressed, the operation mode is shifted in the direction of the arrow.

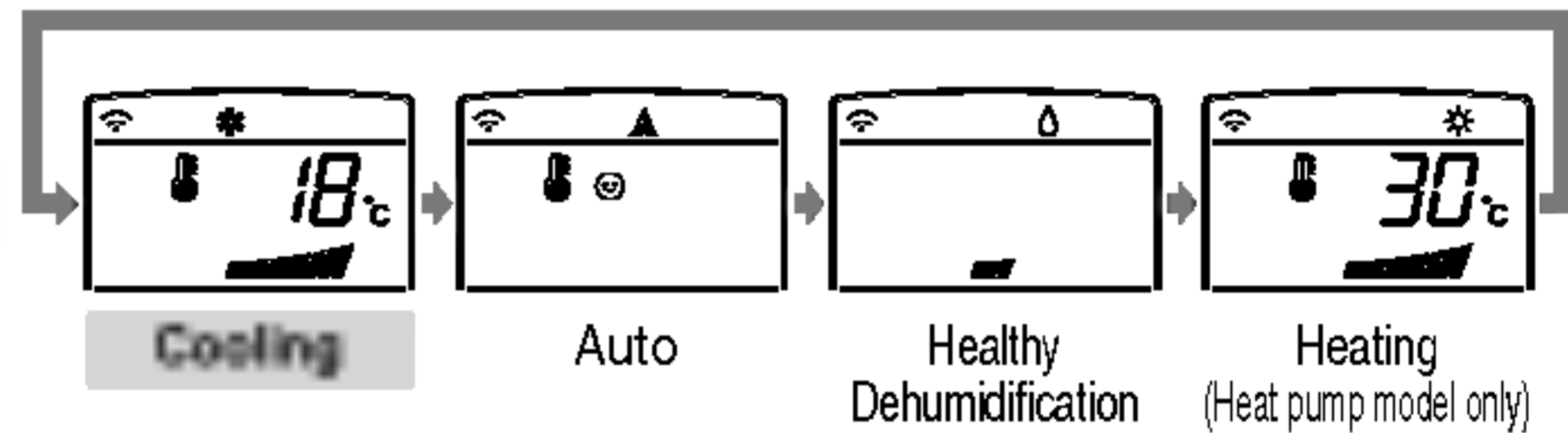

- 3** Set the temperature lower than the room temperature.
The temperature can be set within a range of 18°C~30°C in 1°C.

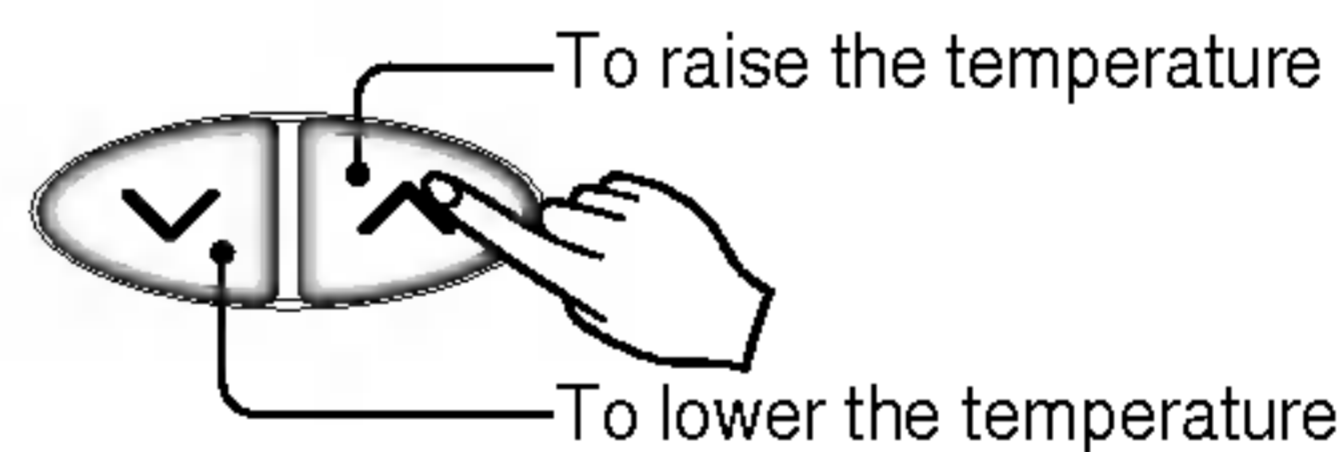

- 4** You can select the fan speed in four steps-low, medium, high, or CHAOS. Each time the button is pressed, the fan speed mode is shifted.



Natural wind by the CHAOS logic

- For more fresh feeling, press the Indoor Fan Speed Selector and set CHAOS mode. In this mode, the wind blows like natural breeze by automatically changing fan speed according to the CHAOS logic.



Auto Operation

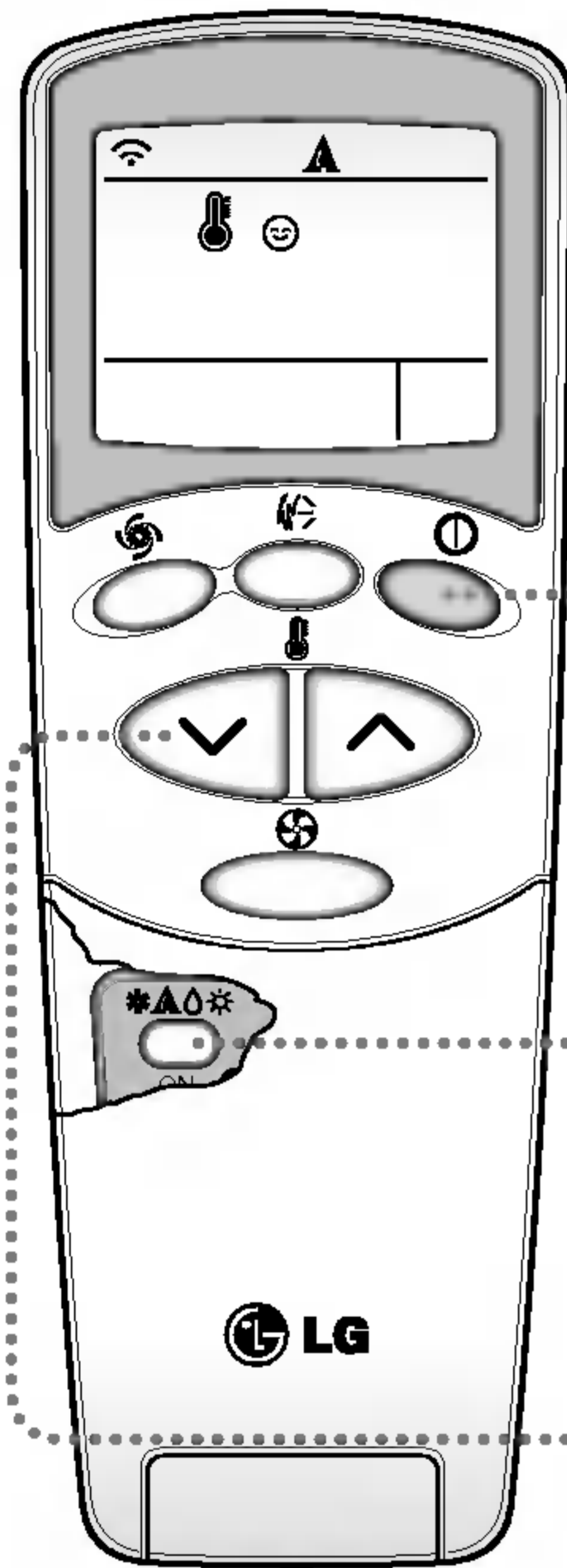

- 1** Press the Start/Stop button.
The unit will respond with beep sound.

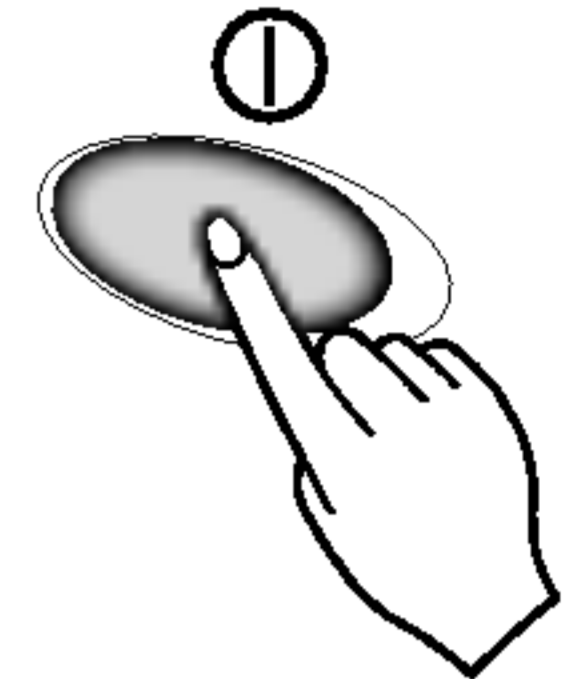

- 2** Open the door on the Remote Controller. To select **Auto Operation**, press the Operation Mode Selection button. Each time the button is pressed, the operation mode is shifted in the direction of the arrow.

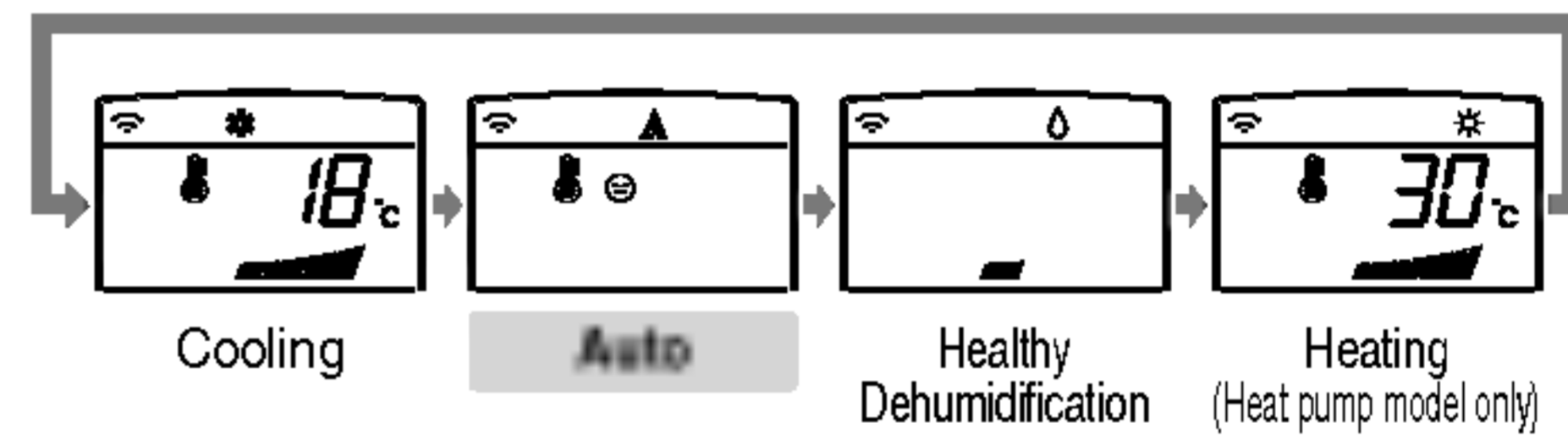

- 3** The temperature and fan speed are automatically set by the electronic controls based on the actual room temperature. If you want to change the set temperature, press the Room Temperature Setting buttons. The set temperature will be changed considering room temperature.

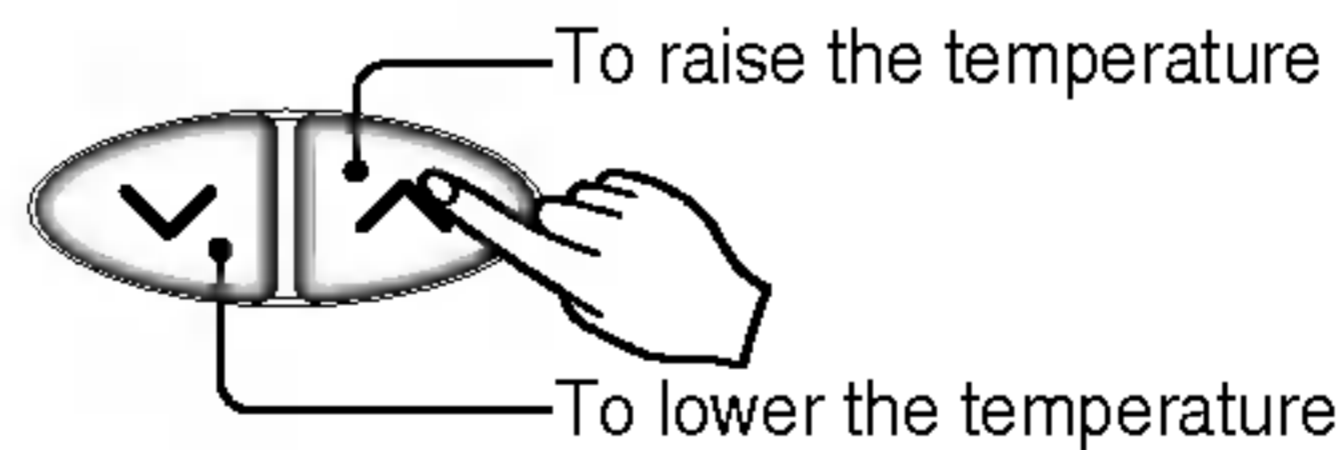

DURING AUTO OPERATION:

- You cannot switch the indoor fan speed. It has already been set by the Fuzzy rule.
- If the system is not operating as desired, manually switch to another mode. The system will not automatically switch from the cooling mode to the heating mode, or from heating to cooling, then you must set the mode and the desired temperature again.
- During Auto Operation, pressing the chaos swing button makes the horizontal louvers swing up and down automatically. If you want to stop auto-swing, press the chaos swing button again.



Healthy Dehumidification Operation

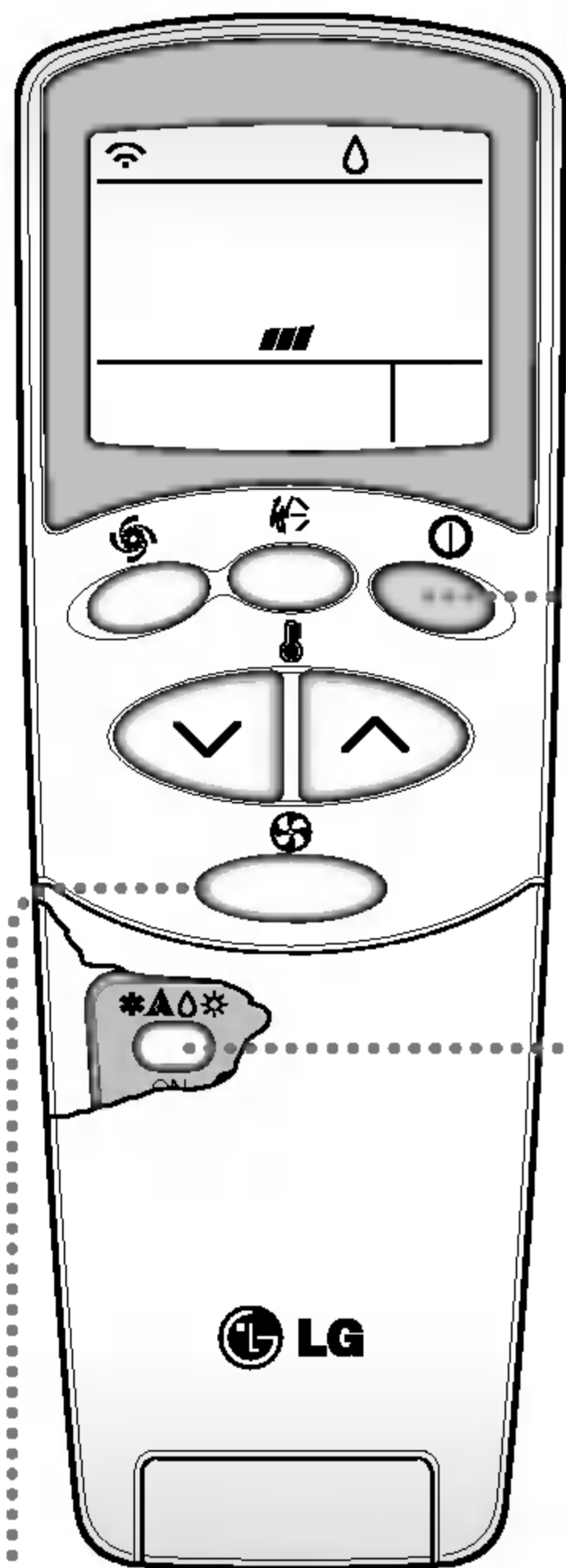

- 1** Press the Start/Stop button.
The unit will respond with beep sound.

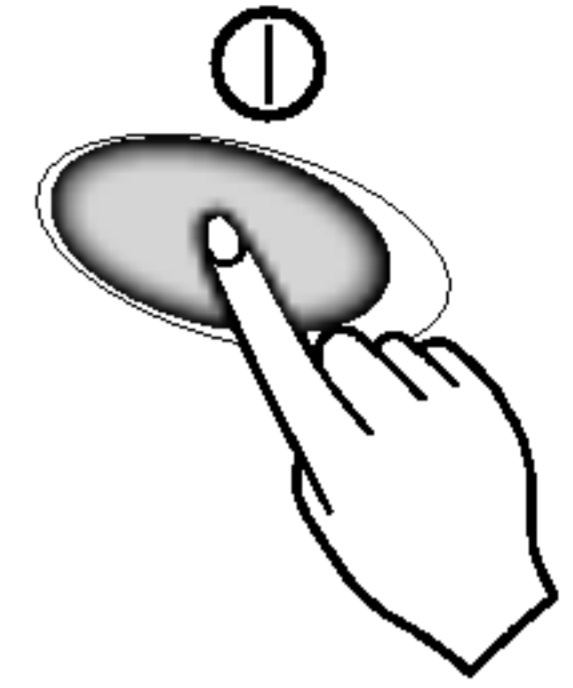

- 2** Open the door on the Remote Controller. To select **Healthy Dehumidification Operation**, press the Operation Mode Selection button.
Each time the button is pressed, the operation mode is shifted in the direction of the arrow.

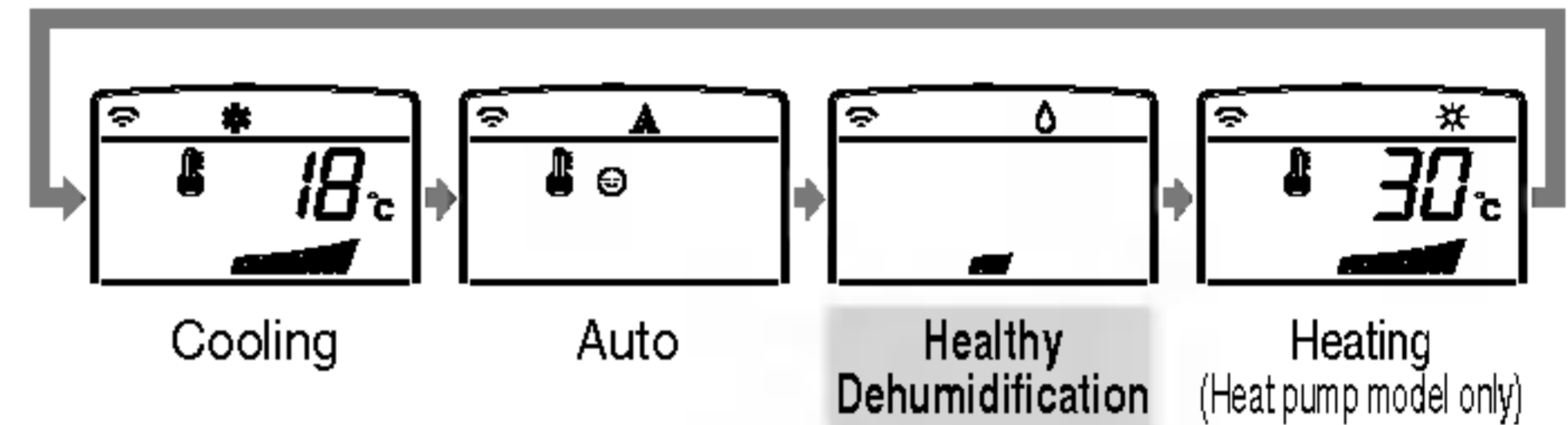

- 3** Set the fan speed. You can select the fan speed in four steps - low, medium, high, or CHAOS. Each time the button is pressed, the fan speed mode is shifted.

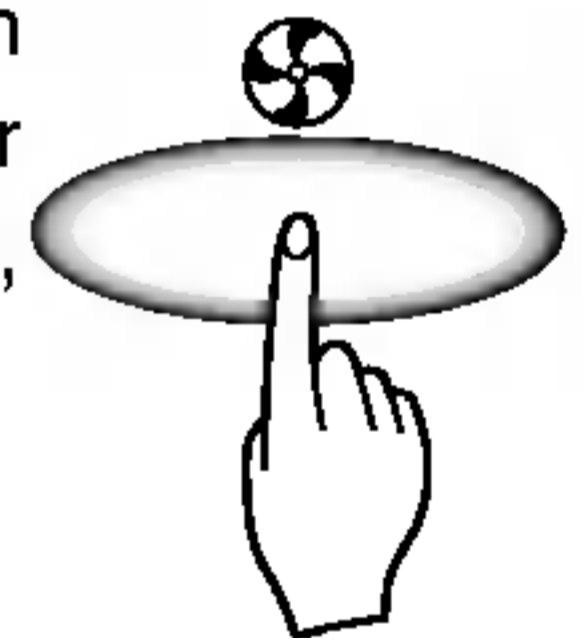

NATURAL WIND BY THE CHAOS LOGIC

- For more fresh feeling, press the Indoor Fan Speed Selector and set CHAOS mode. In this mode, the wind blows like natural breeze by automatically changing fan speed according to the CHAOS logic.

DURING HEALTHY DEHUMIDIFICATION OPERATION:

- If you select the dehumidification mode on the operation selection button, the A/C starts to run the dehumidification function, automatically setting the room temp. and air volume to the best condition for dehumidification based on the sensed room temp.
In this case, the setting temp. is not displayed in the Remote Controller and you are not able to control the room temp. either.
- During the healthy dehumidification function, the air volume is automatically set according to the algorithm responding to the current room temp. and makes the room condition healthy and comfortable even in the high humidity season.



Heating Operation(Heat pump model only)

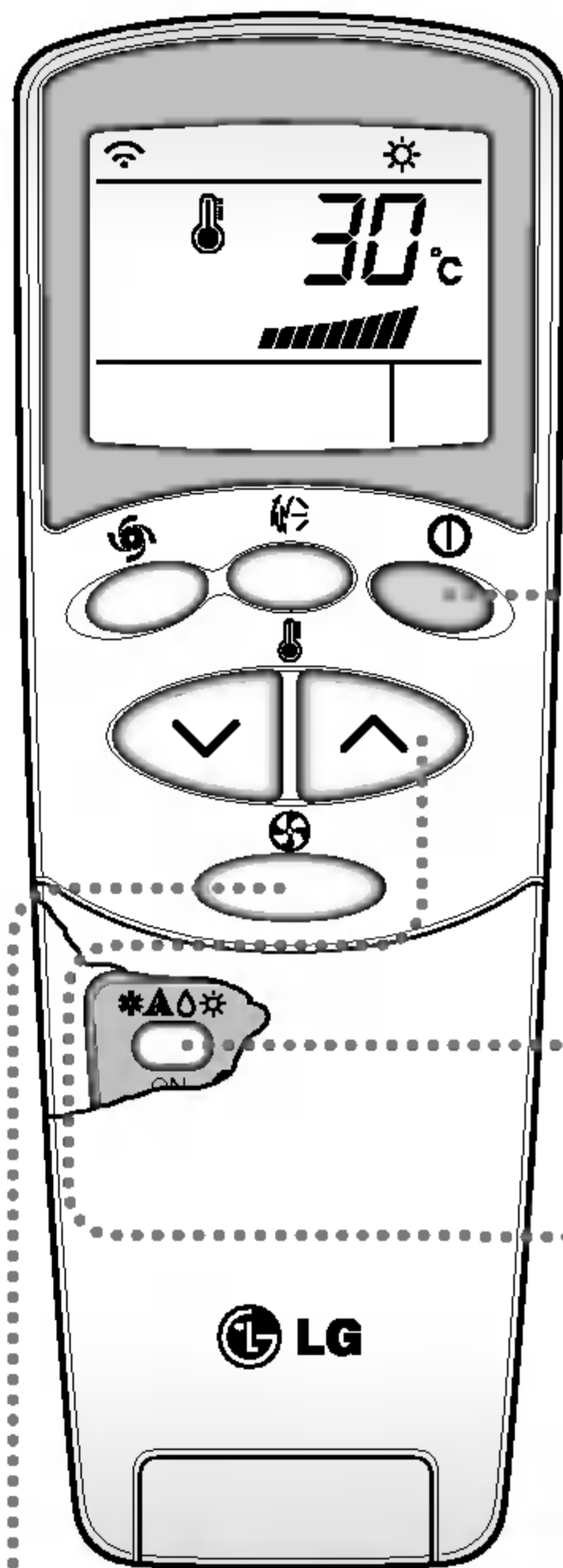

1

Press the Start/Stop button. The unit will respond with beep sound.

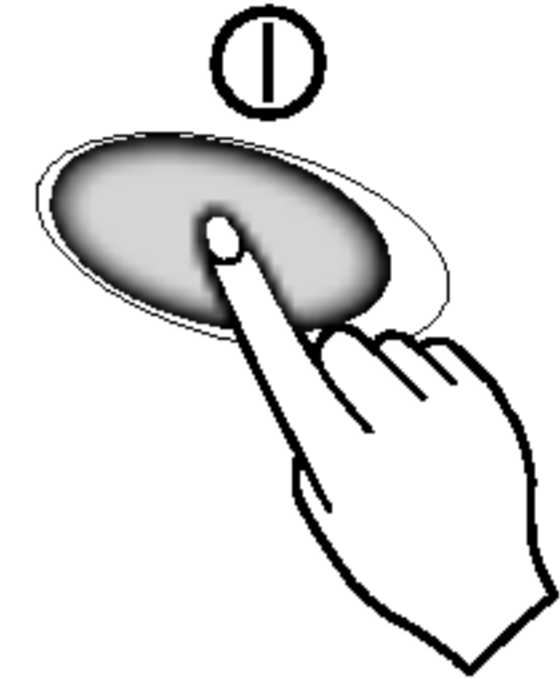

2

Open the door on the Remote Controller. To select **Heating Operation**, press the Operation Mode Selection button. Each time the button is pressed, the operation mode is shifted in the direction of the arrow.

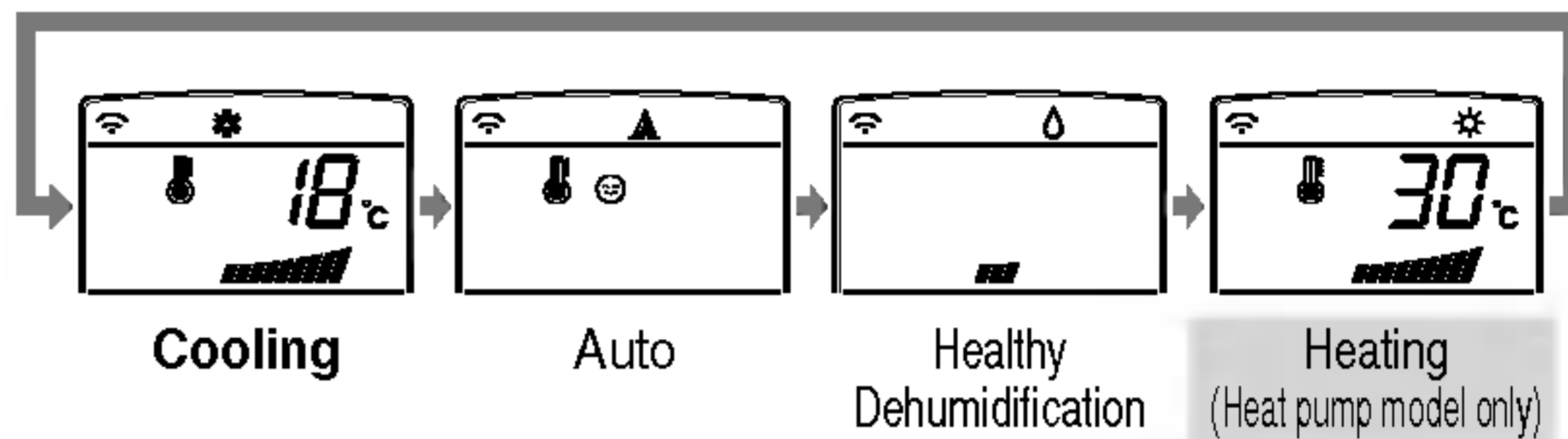

3

Set the temperature higher than the room temperature. The temperature can be set within a range of 16°C~30°C in 1°C.

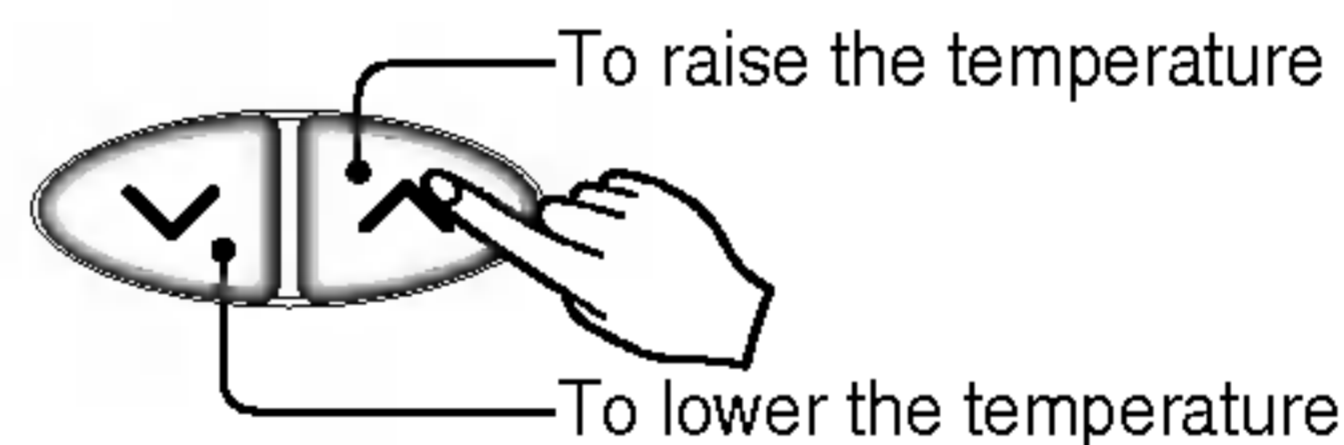

4

Set the fan speed again. You can select the fan speed in four steps—low, medium, high, or CHAOS. Each time the button is pressed, the fan speed mode is shifted.



NATURAL WIND BY THE CHAOS LOGIC

- For more fresh feeling than other fan speed, press the Indoor Fan Speed Selector and set to CHAOS mode. In this mode, the wind blows like natural breeze by automatically changing fan speed according to the CHAOS logic.



Jet Cool

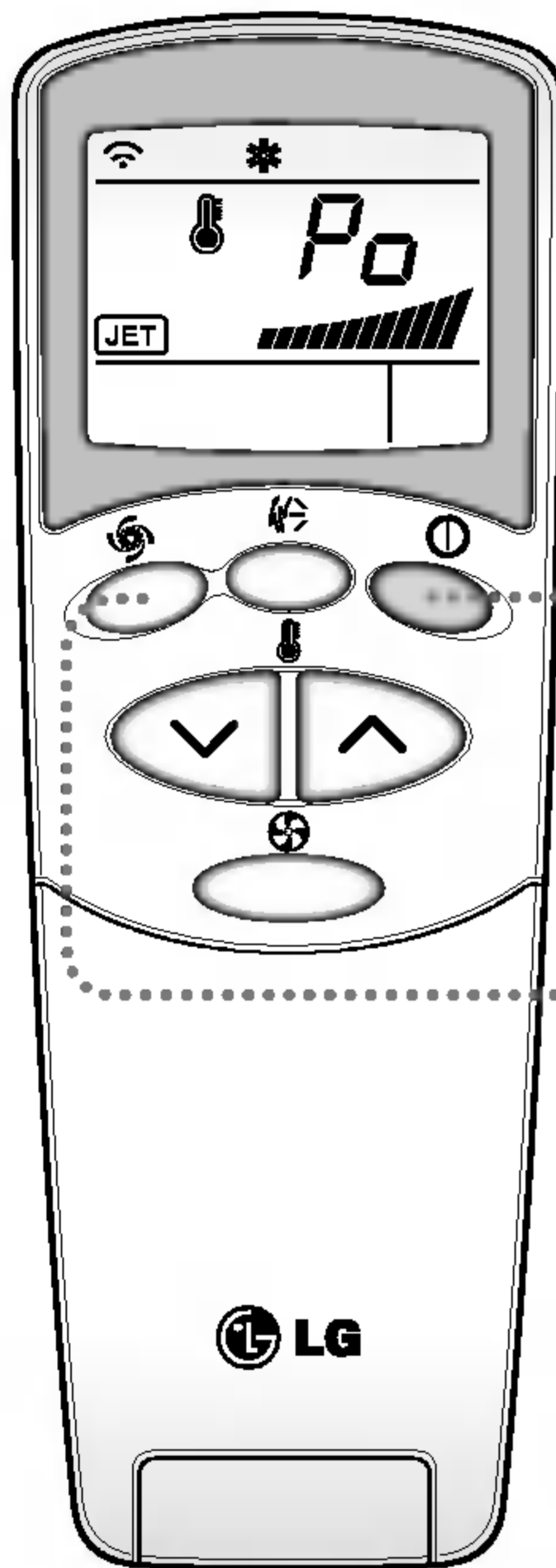

1 Press the Start/Stop button. The unit will respond with beep sound.

2 Press the Jet Cool button to operate the speed cooling mode and the unit will operate in super high fan speed on cooling mode for 30 minutes.

3 To cancel the Jet Cool mode, press the Jet Cool button or the fan button or the room temperature setting button again and the unit will operate in high fan speed in cooling mode

NOTICE

- ❑ During the JET COOL function at any moment, the A/C starts to blow the cool air at extremely high speed for 30 minutes setting the room temp. automatically to 18°C. It is especially used to cool the room temperature in the shortest time.
- ❑ In order to return to the normal cooling mode from the Jet Cool mode, you just press either the operation mode selection button, air volume selection or temp. setting button or the JET COOL button again.



NANO PLASMA Purification Operation

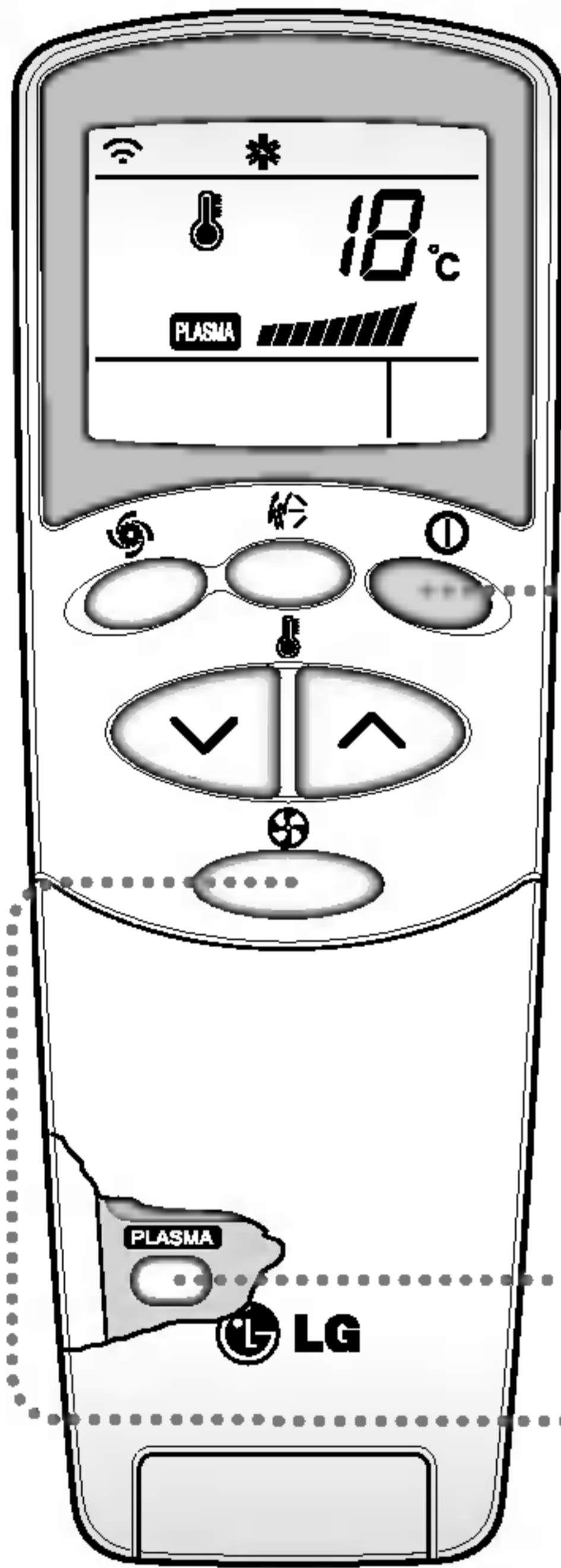

1

Press the Start/Stop button.
The unit will respond with beep sound.

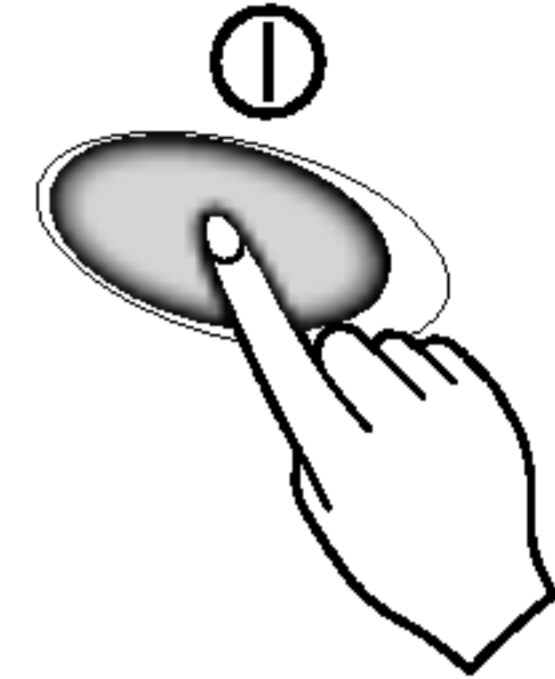

2

Open the door on the Remote Controller. Press the PLASMA air purifying operation ON/OFF button. Operation will start when the button is pressed and stop when the button is pressed again.



3

Set the fan speed. You can select the fan speed in four steps-low, medium, high or CHAOS. Each time the button is pressed, the fan speed mode is shifted.

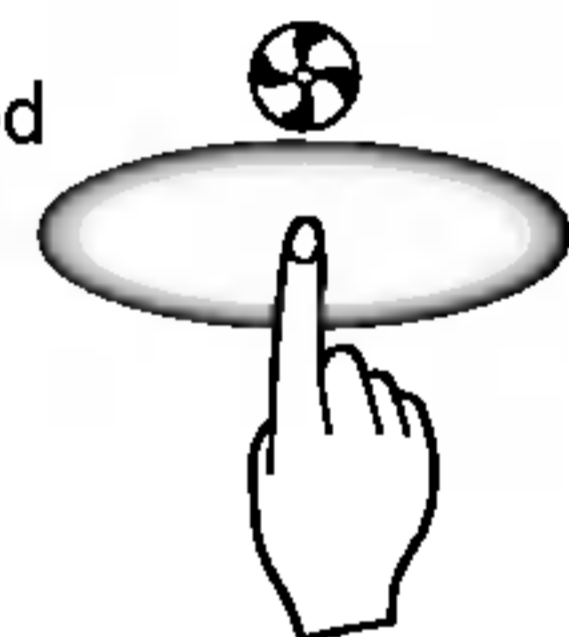

* Air purifying operation (PLASMA) is available in Heating or any other operations.

PLASMA Air Purifying Operation only

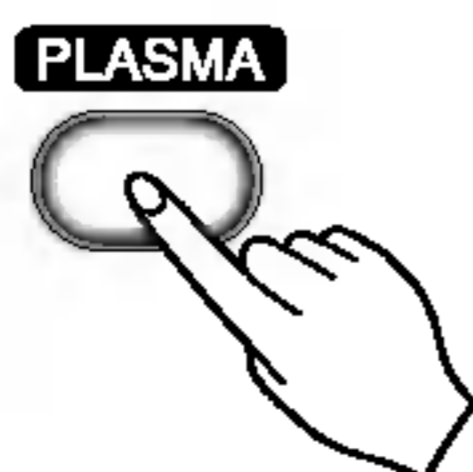
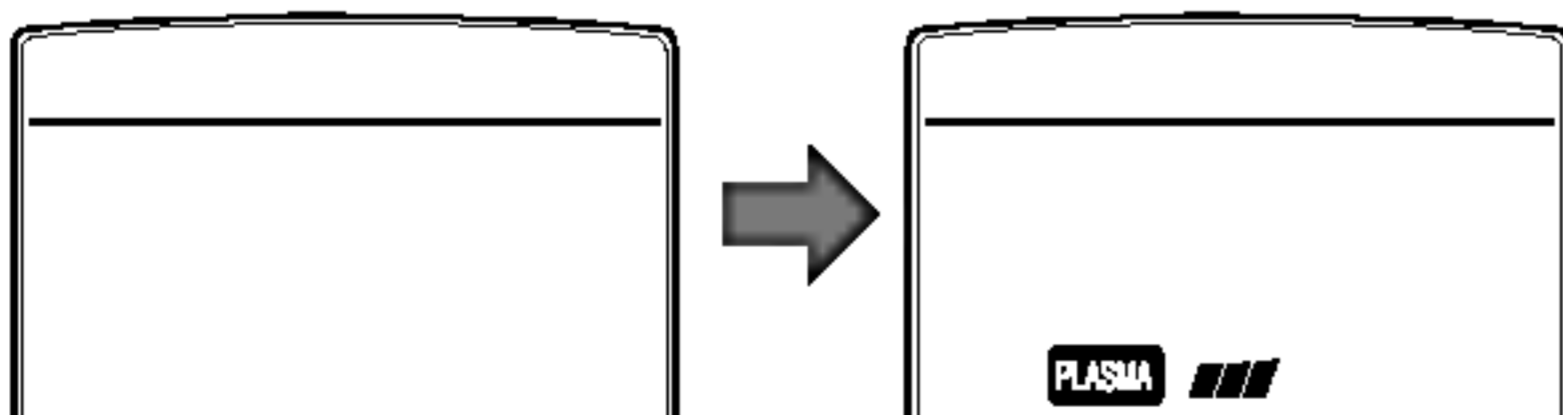

If you press the PLASMA button, NANO PLASMA air purifying operates. Each time the button () is pressed, the fan speed mode is shifted.

2ndF 2nd F Operation

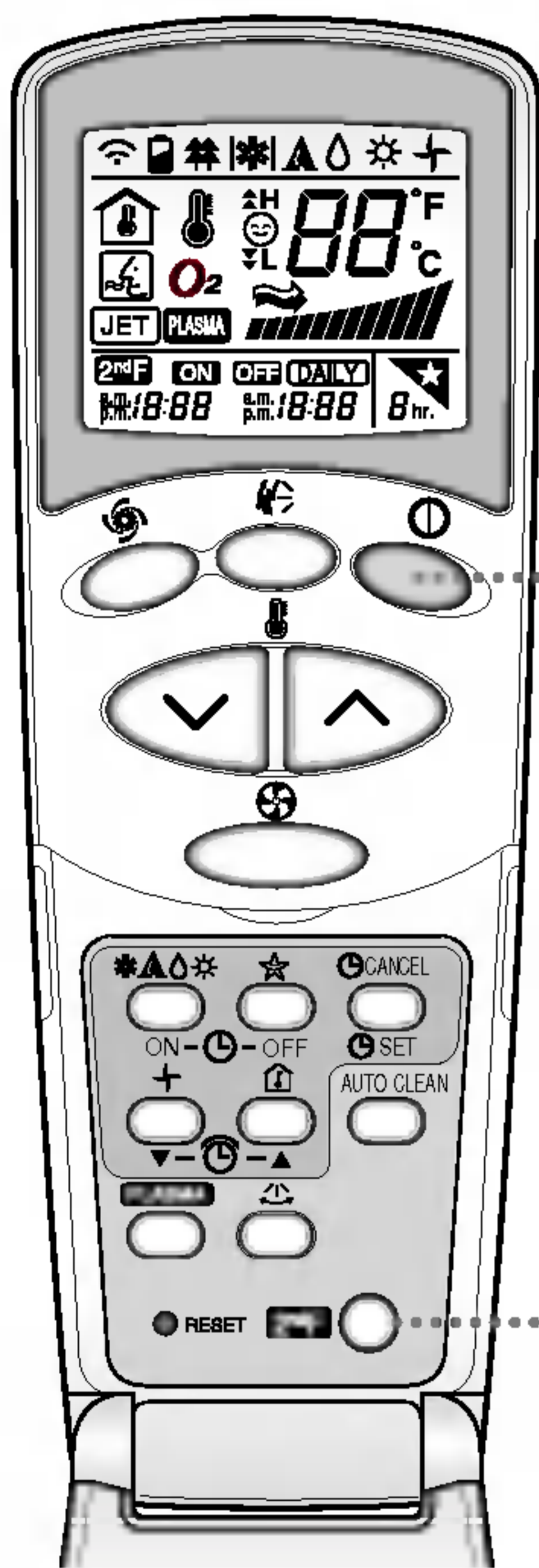

- 1 Press the Start/Stop button.
The unit will respond with beep sound.

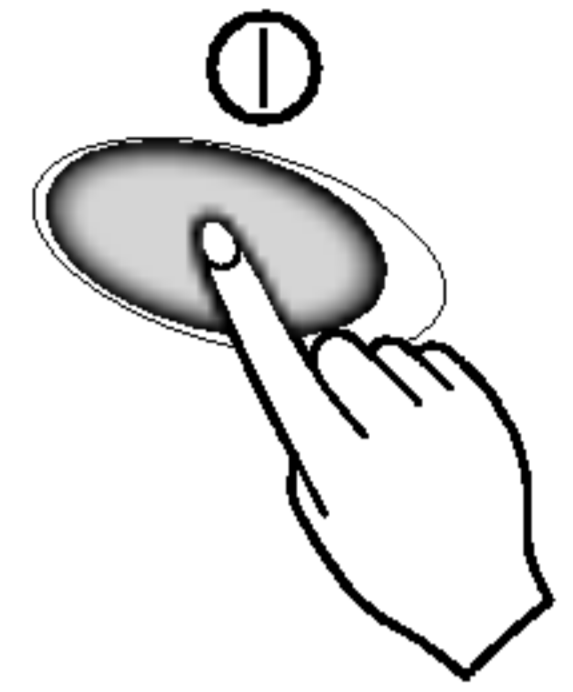

- 2 Open the door of the Remote Controller and press the 2nd F button to operate functions printed in blue at bottom of buttons.
(Check the indication of 2nd function on Remote Controller display.)
These buttons operate the timer setting as follows:

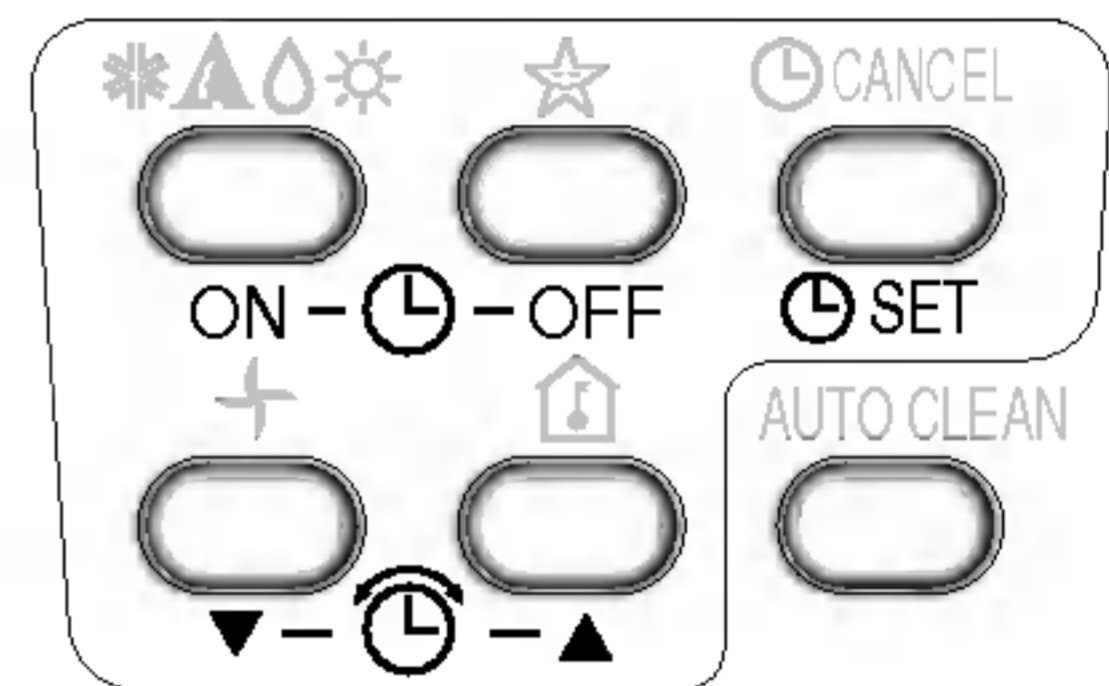

- 3 2nd function goes off in a short time automatically or when the button is pressed again.

For more details, refer to functions next page.

Additional features

Sleep Mode

1. Press the Sleep Mode Auto button to set the time you want the unit to turn off automatically.



1. The Timer is programmed in one-hour increments by pressing the Sleep Mode Auto button 1 to 7 times.

The sleep mode is available for 1 to 7 times. To alter the time period in steps of 1 hour, press the Sleep Mode Button while aiming at air conditioner.

3. Make sure the Sleep Mode Auto LED lights up.

To cancel the Sleep Mode, press the sleep Mode Auto button several times until the star (★) disappears from the operation display.

NOTICE The Sleep Mode will be operated at low fan speed (cooling) or medium fan speed (heat pump only) for quiet sleeping.

IN COOLING MODE: The temperature will automatically rise by 1°C over the next 30 minutes and by 2°C in 1 hour for comfortable sleeping.

Setting the Time

1. Time can be set only when you have pressed the Reset button. If you have just replaced the batteries, the Reset button should be pressed to reset the time.

Press the Start/Stop button.

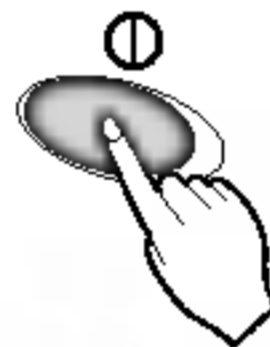

2. Press 2nd F button and check if 2nd F icon is on.



3. Press the Time Setting buttons until the desired time is set.



4. Press the Timer SET button.

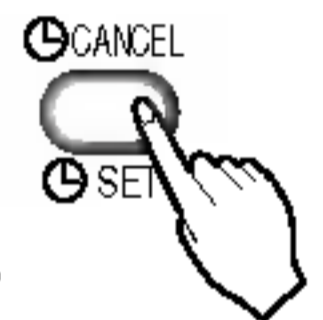

NOTICE Check the indicator for A.M. and P.M.

Delay Start/Pre-Set Stop

1. Make sure the time is set correctly on the Remote Controller display.

2. Press 2nd F button.



3. Press the ON/OFF Timer buttons to turn Timer on or off.



4. Press the Time Setting buttons until the desired time is set.



5. Press the selected on/off setting by pressing the Timer SET button while aiming the Remote Controller at the signal receptor.

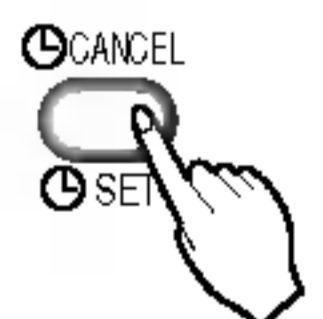

To cancel the setting the timer.



Press the Timer Cancel button while aiming Remote Controller at the signal receptor. (The timer lamp on the air conditioner and the display will go out.)

NOTICE Select one of the following four types of operation.

with the unit running



Delay OFF Timer

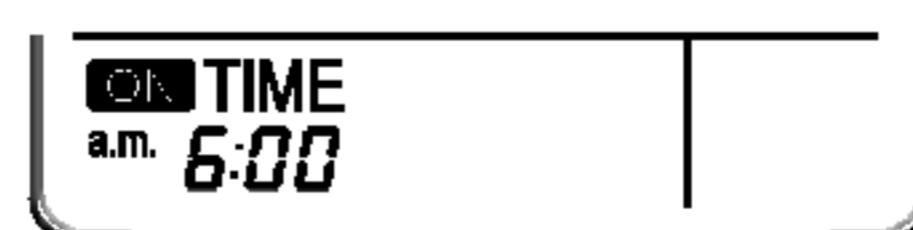

Delay ON Timer



Delay OFF and ON Timer



Delay ON and OFF Timer



Vertical Airflow Direction Control

The up/down airflow (Vertical Airflow) can be adjusted by using the remote controller.

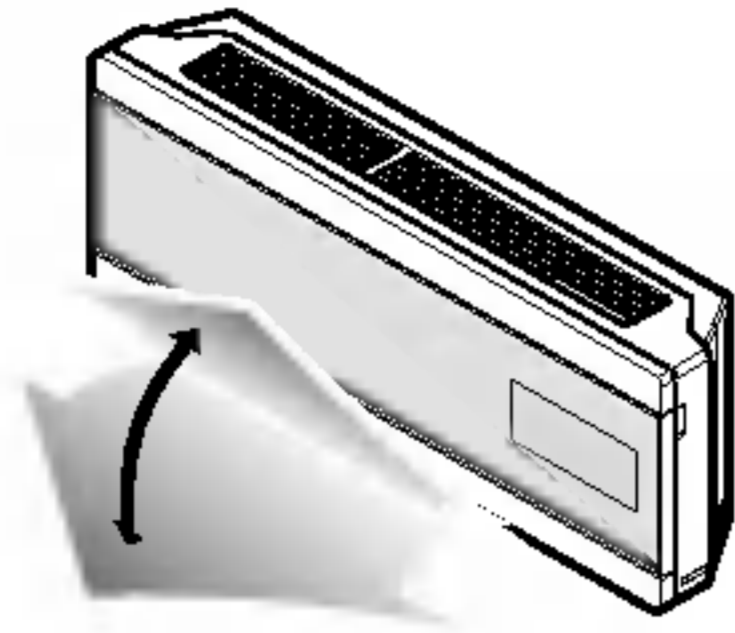

1. Press the Start/Stop button to start the unit.
2. Press Chaos Swing button and the louvers will swing up and down. Press the Chaos Swing button again to set the vertical louver at the desired airflow direction.

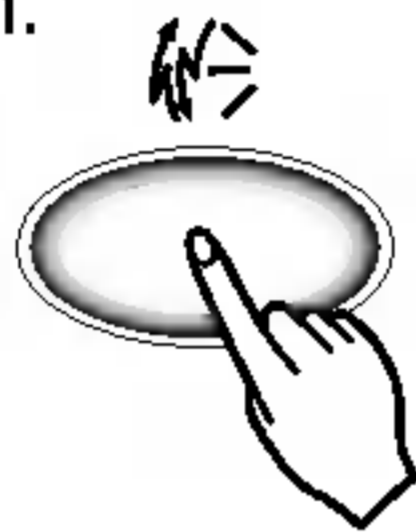

NOTICE

- ❑ If you press the CHAOS swing button, the horizontal airflow direction is changed automatically based on the CHAOS algorithm to distribute the air in the room evenly and at the same time to make the human body feel more comfortable, as if enjoying a natural breeze.
- ❑ Always use the remote controller to adjust the up/down airflow direction. Manually moving the vertical airflow direction louver by hand, could damage the air conditioner.
- ❑ When the unit is shut off, the up/down airflow direction louver will close the air outlet vent of the system.



Horizontal Airflow Direction Control

The left/right(Horizontal Airflow) can be adjusted by using the remote control. Press the Start/Stop button to start the unit.

Open the door on the remote control. Press the Airflow Direction Start/Stop button and the louvers will swing left and right. Press the Horizontal Airflow Direction Control Button again to set the horizontal louver at the desired airflow direction.

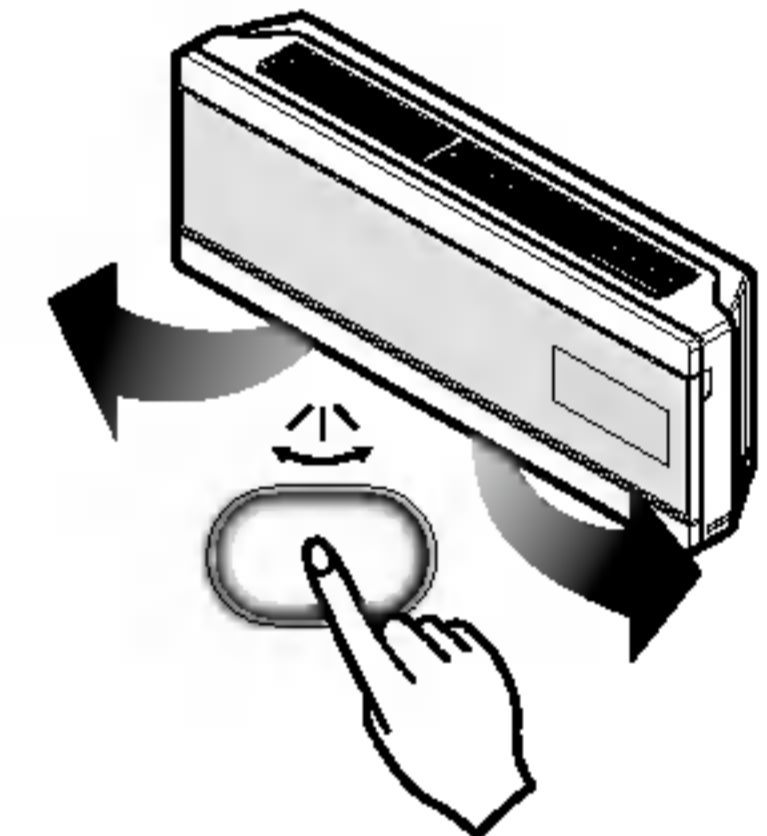

Air Circulation Mode

Circulates the room air without cooling or heating.

1. Press the Start/Stop button. The unit will respond with a beep.
2. Open the door on the remote controller. Press the Air Circulation button. Close the door on the remote controller. Now each time that you press the Indoor Fan Speed Selector, the fan speed is shifted from low to CHAOS and back to low again.

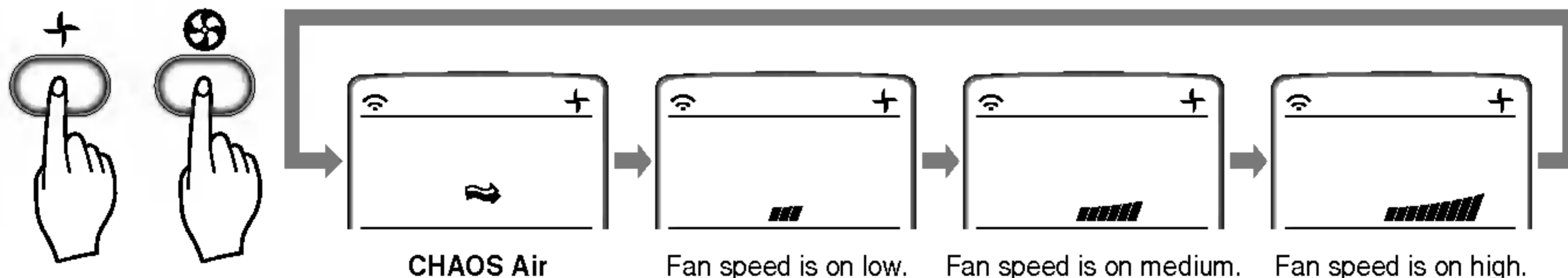

NOTICE CHAOS Air economizes power consumption and prevents overcooling. The fan speed is automatically changed from high to low or vice versa, depending on the ambient temperature.



Auto Clean

AUTO CLEAN



Open the door on the remote control.

Press the Auto Clean Button.

Close the door on the remote control.

Now each time that you press the start/stop button, the Air conditioner operates clean function automatically.

NOTICE

- ❑ During Auto Clean function, moistures left in indoor units after Cooling Operation or Healthy Dehumidification Operation can be removed.
- ❑ During Auto Clean function, only Start/Stop button, Plasma button and Auto Clean button are available.



Forced Operation

Operation procedures when the remote controller can't be used.

The operation will be started if the power button is pressed.

If you want to stop operation, re-press the button.

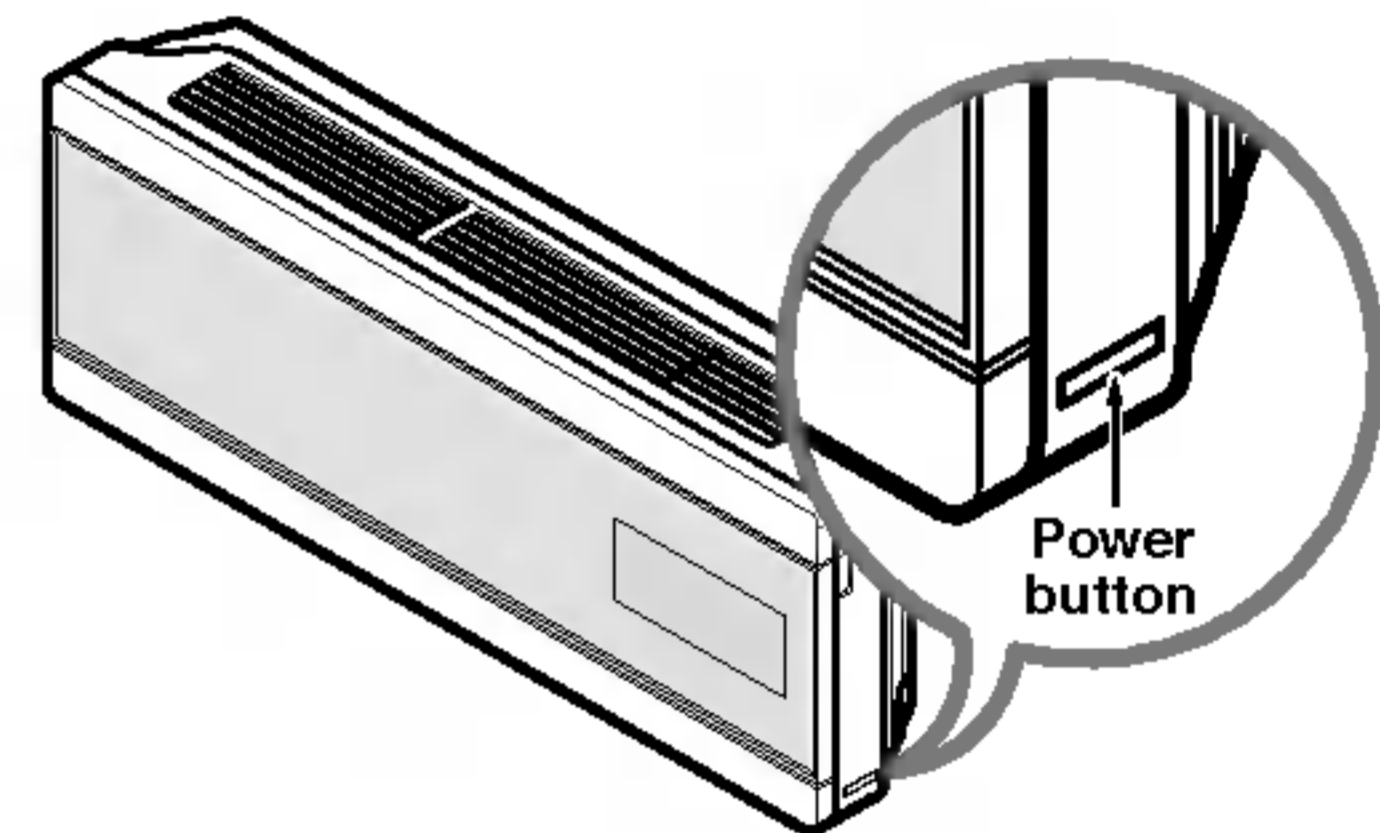

	Room Temp. $\geq 24^{\circ}\text{C}$	$21^{\circ}\text{C} \leq$ Room Temp. $< 24^{\circ}\text{C}$	Room Temp. $< 21^{\circ}\text{C}$
Operating mode	Cooling	Healthy Dehumidification	Heating
Indoor FAN Speed	High	High	High
Setting Temperature	22°C	23°C	24°C

Test operation

During the TEST OPERATION, the unit operates in cooling mode at high speed fan, regardless of room temperature and resets in 18 minutes.

During test operation, if remote controller signal is received, the unit operates as remote controller sets.

If you want to use this operation, open the front panel upward and press the power button for about 3 seconds.

If you want to stop the operation, re-press the button.



Auto restart

In case the power comes on again after power failure, Auto Restarting Operation is the function to operate procedures automatically to the previous operating conditions.

So there is no need of activating this function by pressing any key or button.

In the initial mode, the fan operates at low speed and the compressor starts 2.5~3 minutes later.

As the compressor starts, the fan speed also resumes its previous setting mode.

Helpful information

Fan speed and cooling capacity.

The cooling capacity indicated in the specification is the value when the fan speed is set to high, and the capacity will be lower at low or medium fan speed.

High fan speed is recommended when you wish to cool the room quickly.

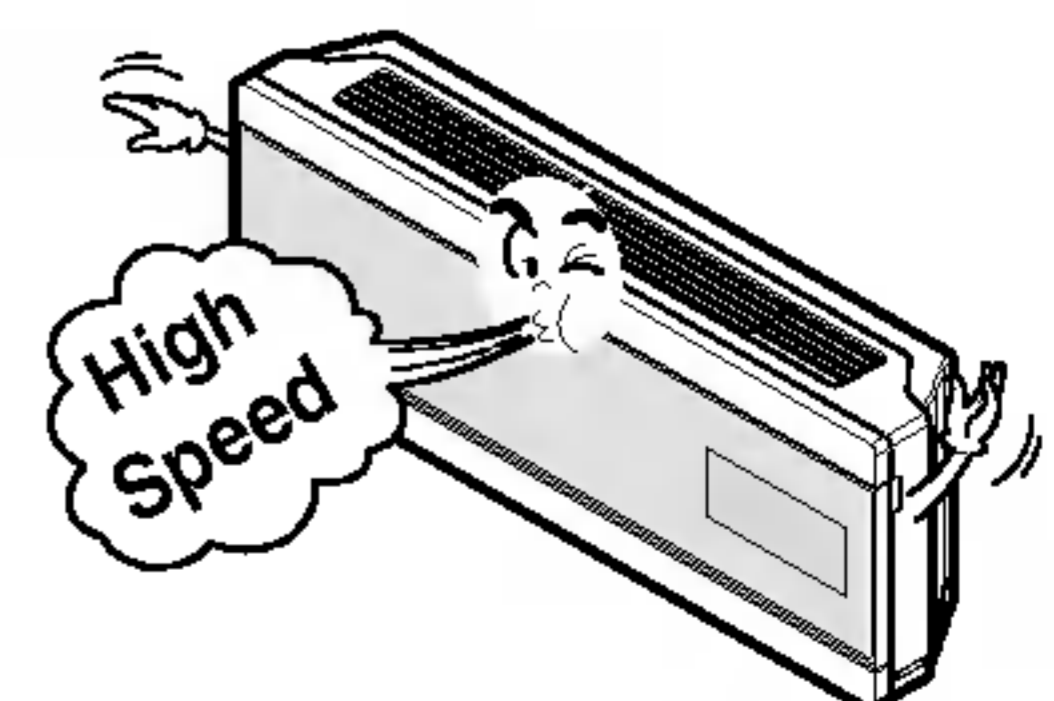

Maintenance and Service



CAUTION: Before performing any maintenance, turn off the main power to the system.

Grille, Case, and Remote Control

❑ Turn the system off before cleaning.

To clean, wipe with a soft, dry cloth. Do not use bleach or abrasives.

NOTICE

Supply power must be disconnected before cleaning the indoor unit.

Artcool Deluxe Type Indoor Unit

1. Open the upside of Front Panel

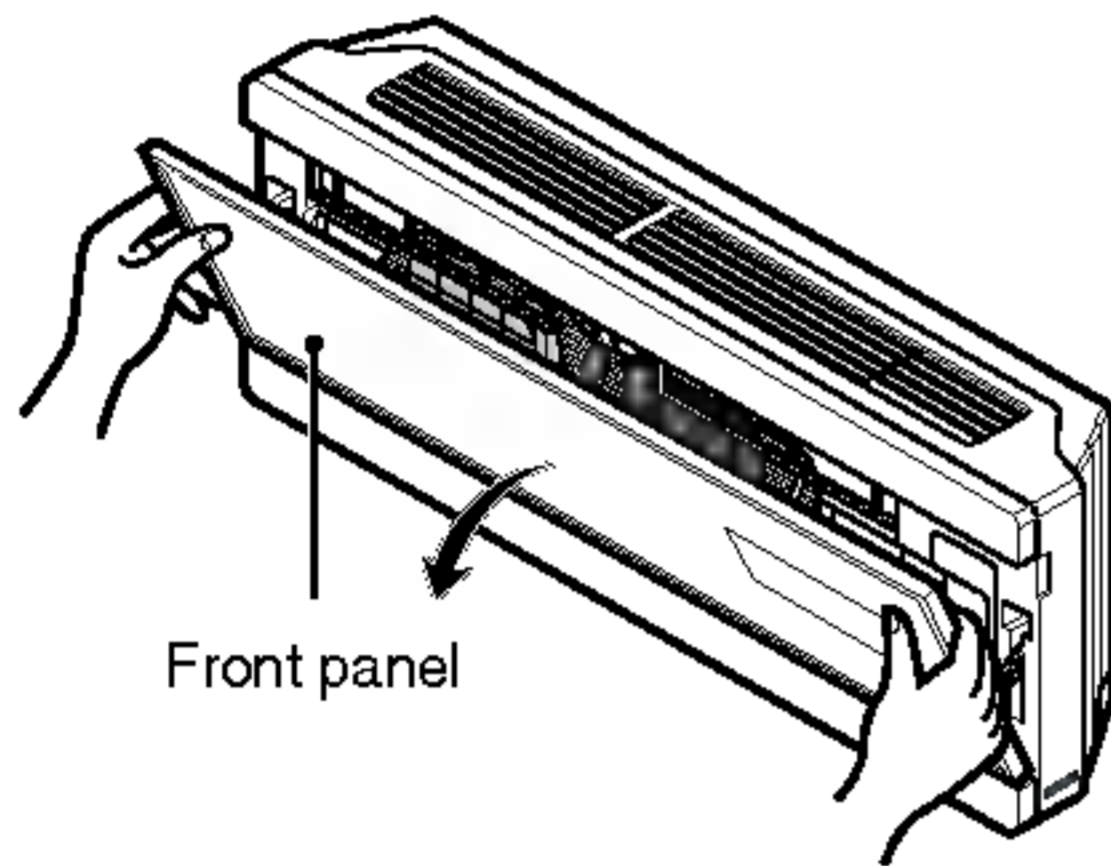

2. Lift up the Front panel.

The hook of panel comes off.

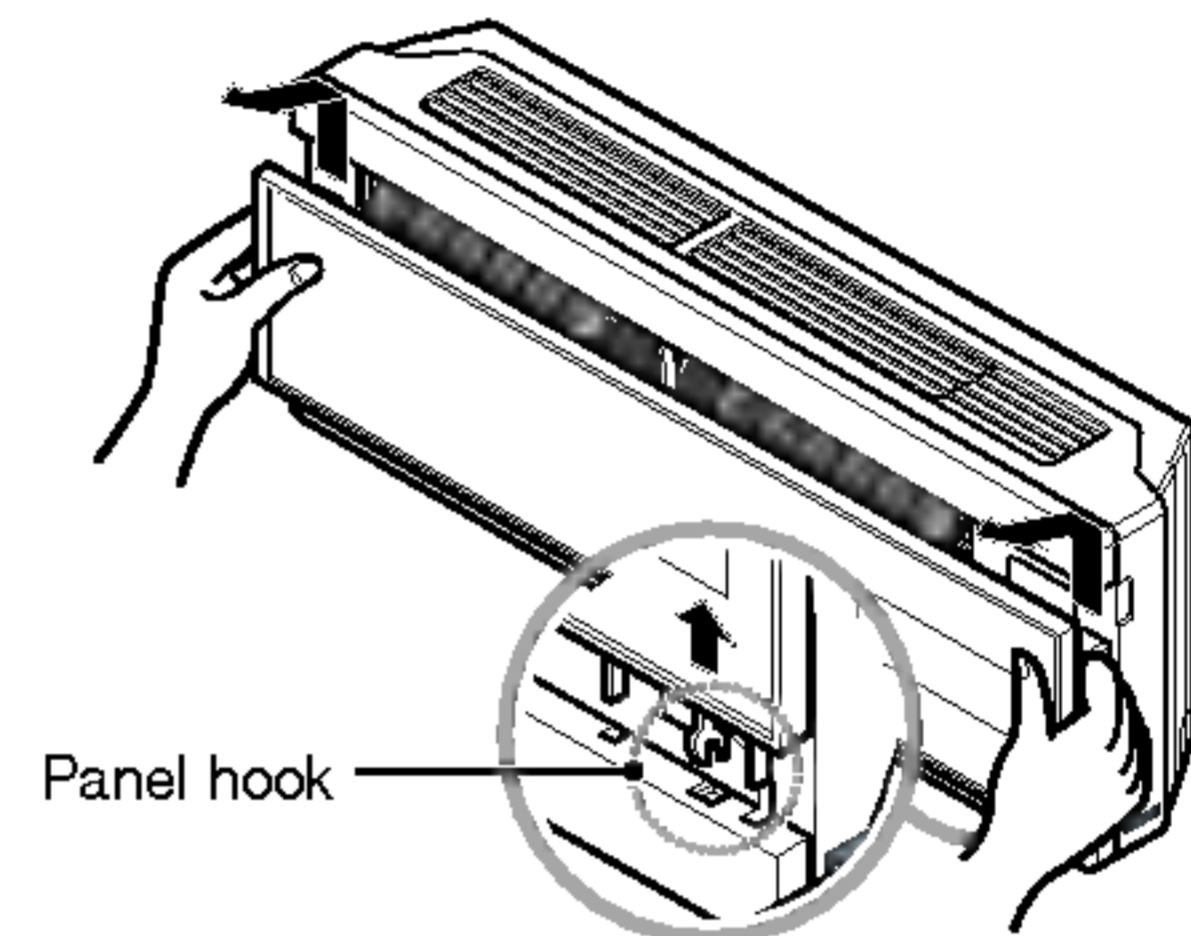

3. Come down the panel and then remove air filters.

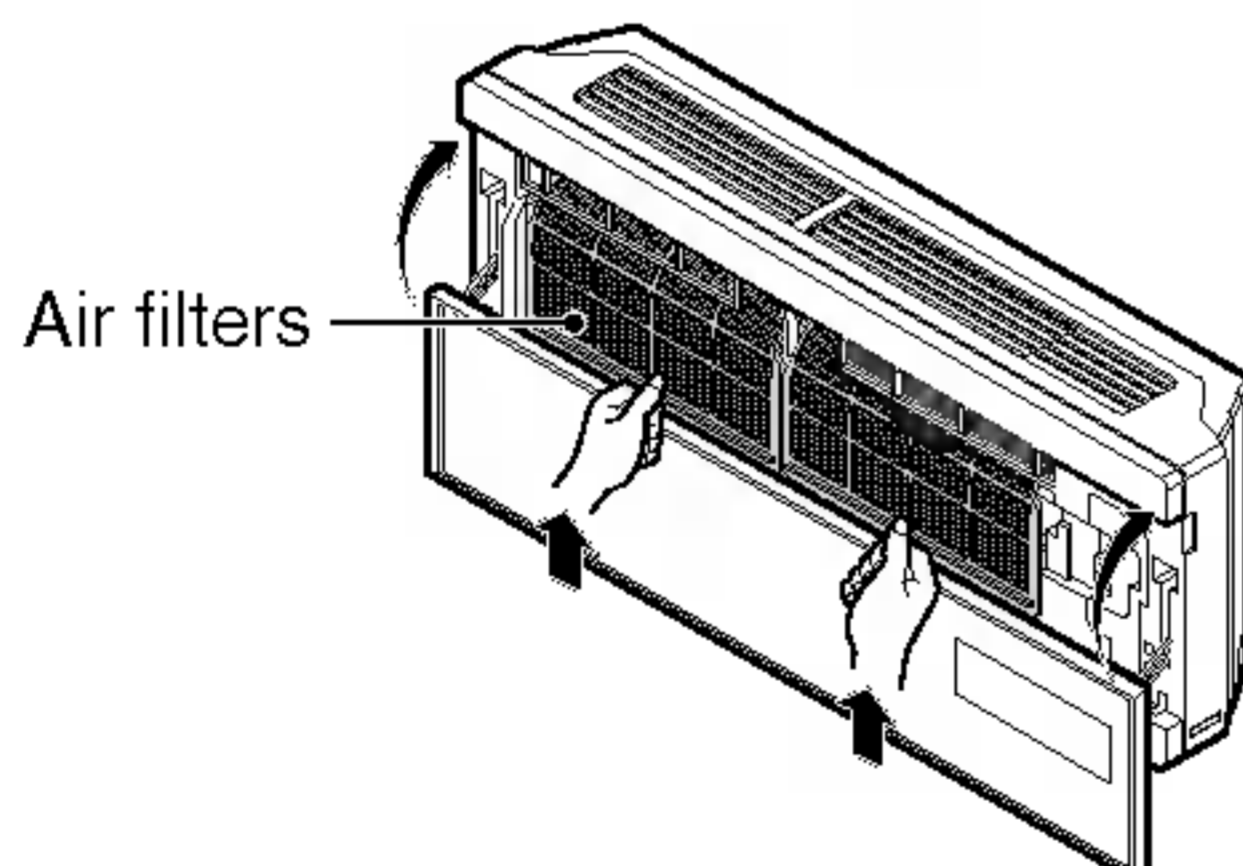

4. Do cleaning by soft brush and a vacuum cleaner. If it has hard pollution, wash by water.

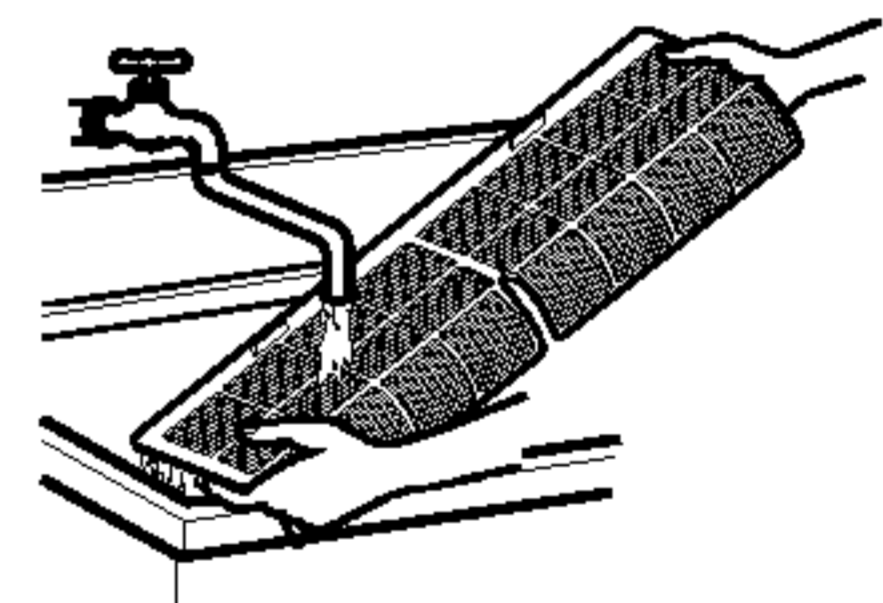

5. Relocate dried air filters at the shade and then close the panel.

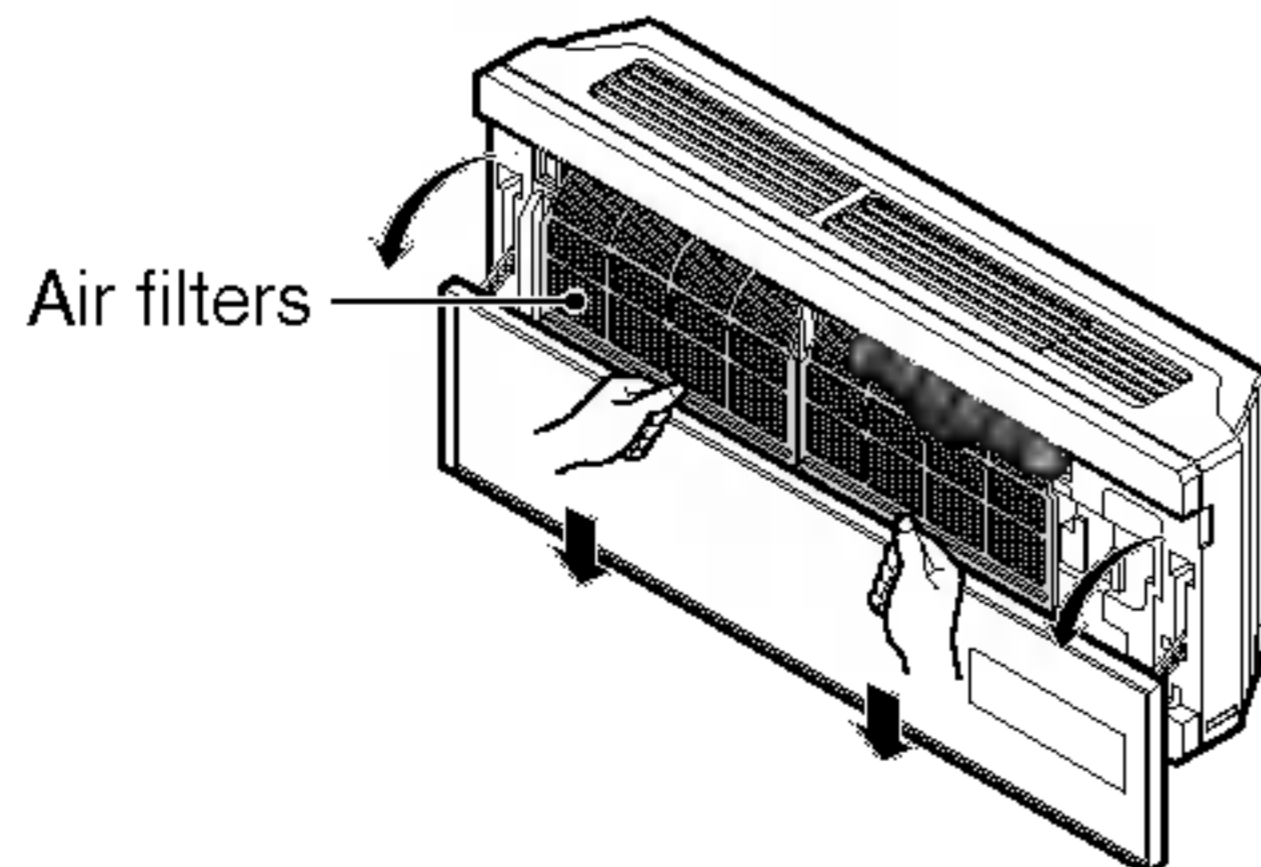

Don't touch this nano PLASMA Filter within 10 seconds after opening the inlet grille, it may cause an electric shock.

❑ Never use any of the followings:

- Water hotter than 40°C
Could cause deformation and/or discoloration.
- Volatile substances
Could damage the surfaces of the air conditioner.



Cleaning of Purifying Filter

• Recommended use period : About 3 months

1. Open the upside of Front panel.
2. Put up the front panel.
The hook of panel comes off.
3. Remove air filter and then pull out nano plasma filter.

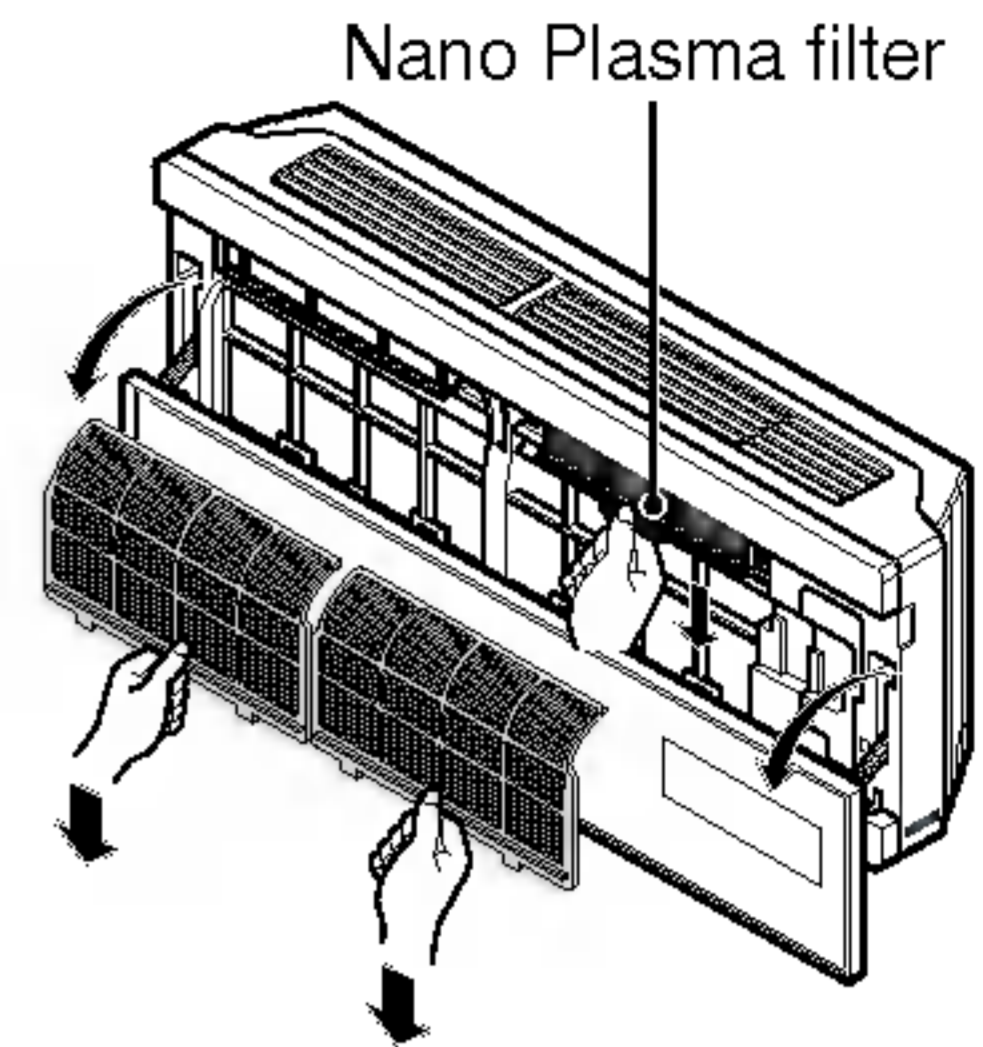
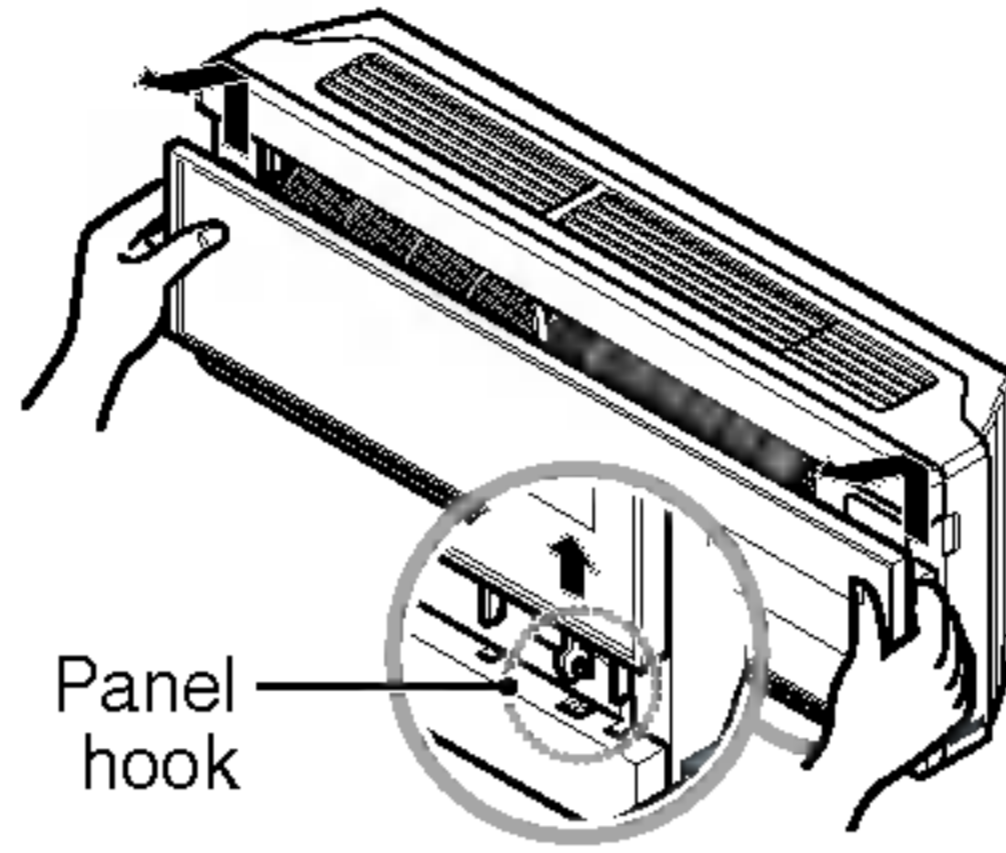
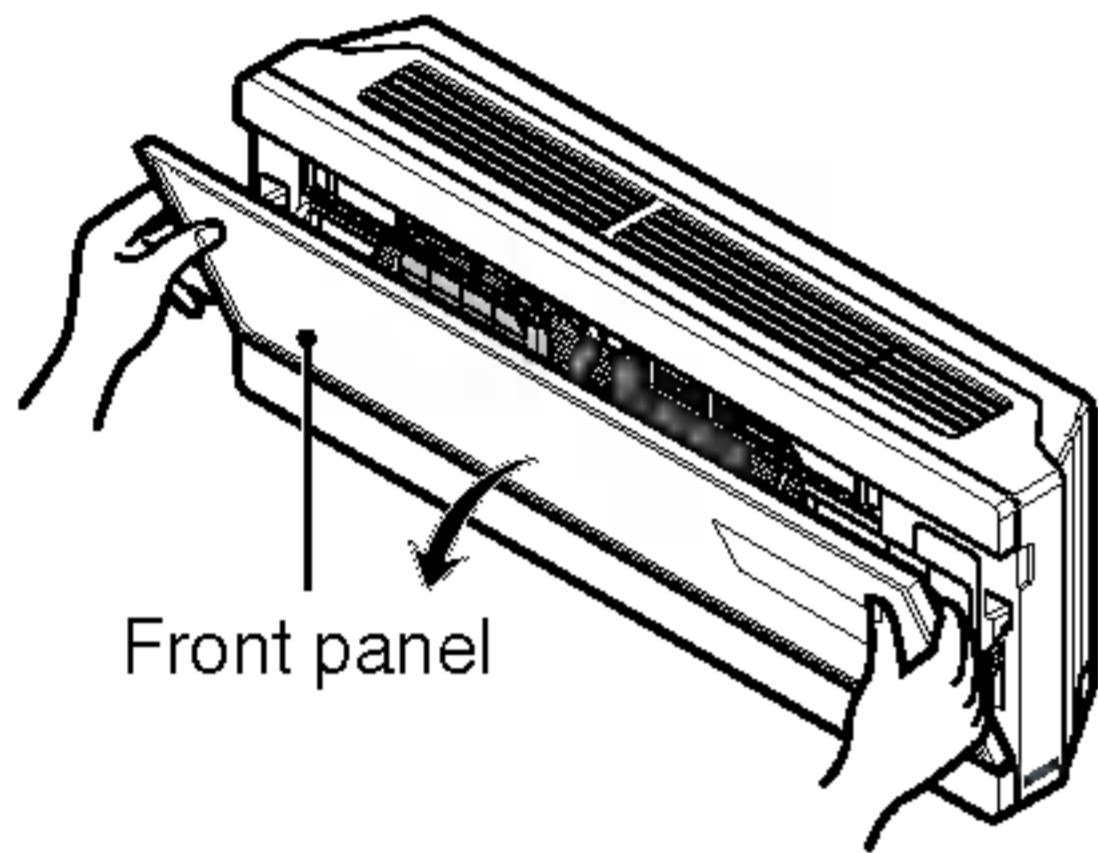

4. Clean nano plasma filter with the vacuum cleaner.
5. Insert the nano plasma filters at the shade and then put in air filter.

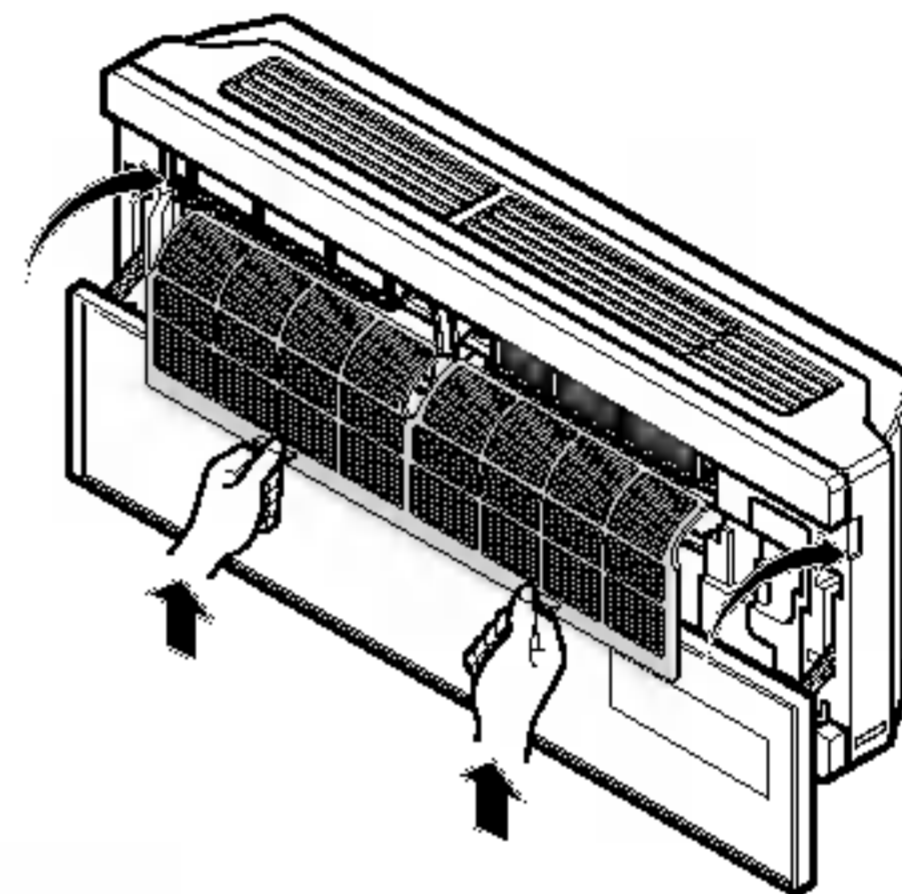
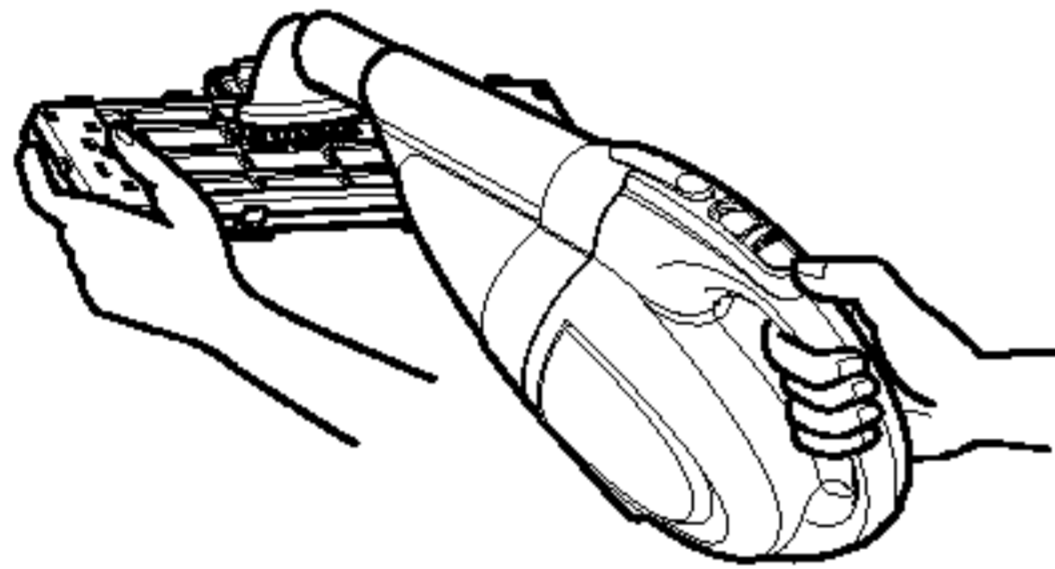

When the air conditioner is not going to be used for a long time.

When air conditioner is not going to be used for a long time.

- 1** Operate the air conditioner on Air circulation mode (Refer to page 20) for 2 to 3 hours.
 - This will dry out the internal mechanisms.
- 2** Turn off the circuit breaker.

⚠ CAUTION

Turn off the circuit breaker when the air conditioner is not going to be used for a long time.
Dirt may collect and may cause a fire.

- 3** Remove the batteries from the remote controller.

When the air conditioner is used again.

- 1** Clean the air filter and install it in the indoor unit.
(Refer to page 22 for cleaning filters.)
- 2** Check that the air inlet and outlet of the indoor/outdoor unit are not blocked.
- 3** Check that the ground wire is connected correctly. It may be connected to the indoor unit side.

Operation Tips

<p>Do not overcool the room.</p> <p>This is not good for the health and wastes electricity.</p>	<p>Keep blinds or curtains closed.</p> <p>Do not let direct sunshine enter the room when the air conditioner is in operation.</p>	<p>Keep the room temperature uniform.</p> <p>Adjust the vertical and horizontal airflow direction to ensure a uniform temperature in the room.</p>
<p>Make sure that the doors and windows are shut tight.</p> <p>Avoid opening doors and windows as much as possible to keep the cool air in the room.</p>	<p>Clean the air filter regularly.</p> <p>Blockages in the air filter reduces the airflow and lowers the cooling and dehumidifying effects. Clean at least once in every two weeks.</p>	<p>Ventilate the room occasionally.</p> <p>Since windows are kept closed, it is a good idea to open them and ventilate the room now and then.</p>

Before you call for service...



Troubleshooting Tips! Save time and money!

Check the following points before requesting repairs or service.... If the malfunction persists, please contact your dealer.

Case	Explanation	See page
The air conditioner does not operate.	<ul style="list-style-type: none"> • Have you made a mistake in timer operation? • Has the fuse blown or has the circuit breaker been tripped? 	16 -
The room has a peculiar odor.	<ul style="list-style-type: none"> • Check that this is not a damp smell exuded by the walls, carpet, furniture, or cloth items in the room. 	-
It seems that condensation is leaking from the air conditioner.	<ul style="list-style-type: none"> • Condensation occurs when the airflow from the air conditioner cools the warm room air. 	-
Air conditioner does not operate for about 3 minutes when restarted.	<ul style="list-style-type: none"> • This is the protector of the mechanism. • Wait about three minutes and operation will begin. 	-
Does not cool or heat effectively.	<ul style="list-style-type: none"> • Is the air filter dirty? See air filter cleaning instructions. • Has the temperature been set incorrectly? • Are the indoor unit's air inlet or outlet vents obstructed? 	19 11, 14 -
The air conditioner operation is noisy.	<ul style="list-style-type: none"> • For a noise that sounds like water flowing. -This is the sound of freon flowing inside the air conditioner unit. • For a noise that sounds like the compressed air releasing into atmosphere. -This is the sound of the dehumidifying water being processed inside the air conditioning unit. 	-
Remote controller display is faint, or no display at all.	<ul style="list-style-type: none"> • Are the batteries depleted? • Are the batteries inserted in the opposite (+) and (-) directions? 	9
Crack sound is heard.	<ul style="list-style-type: none"> • This sound is generated by the expansion/constriction of the front panel, etc. due to changes of temperature. 	-

NOTICE

WATER RESISTANT: The indoor unit is not water resistant and should not be exposed to excess water.

