



# PLASMA TV OWNER'S MANUAL

**MODELS: 42PX5R**  
**42PX5R-MC**  
**50PX4R**  
**50PX4R-MC**  
**50PX5R**  
**50PX5R-MC**  
**50PX5RH**  
**50PX5RH-MC**

Please read this manual carefully and completely before operating your TV.

Retain this manual for future reference.

Record model number and serial number of the TV in the spaces provided below.

See the label attached on the back cover and relate this information to your dealer if you require service.

Model Number :

Serial Number :



# Safety Instructions

\* Safety instructions have two kinds of information, and each meaning of it is as below.

 **WARNING** The violation of this instruction may cause serious injuries and even death.

 **NOTES** The violation of this instruction may cause light injuries or damage of the product.

 Take care of danger that may happen under specific condition.

## WARNING

1. **Do not place the product in direct sunlight or near heat sources such as heat registers, stove and so on.**

This may cause a fire.

2. **Do not use the product in damp place such as a bathroom or any place where it is likely to get wet.**

This may cause a fire or could give an electric shock.

3. **Bend antenna cable between inside and outside building to prevent rain from flowing in.**

This may cause water damaged inside the product and could give an electric shock.

4. **Earth wire should be connected.**

- If the earth wire is not connected, there is possible a danger of electric shock caused by the current leakage.
- If grounding methods are not possible, a separate circuit breaker should be employed and installed by a qualified electrician.
- Do not connect ground to telephone wires, lightning rods or gas pipe.

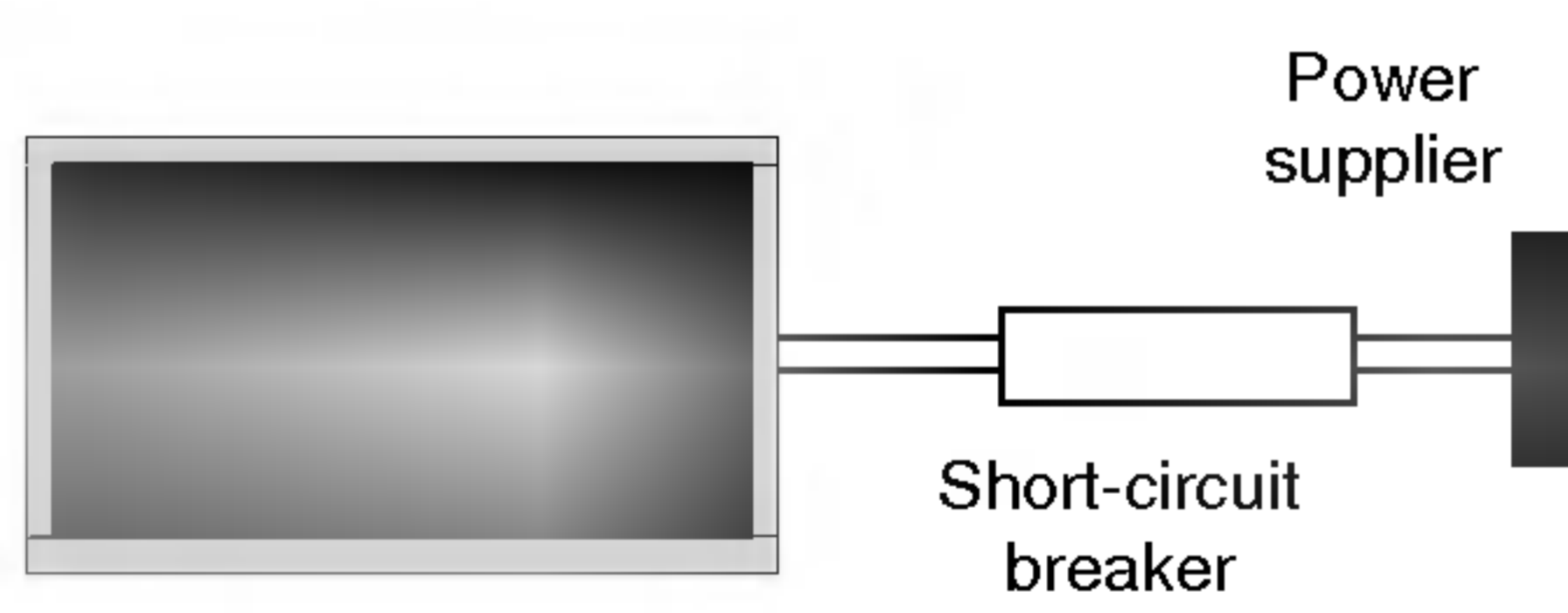

5. **Do not placing anything containing liquid on top of the product.**

This may cause a fire or could give an electric shock.

6. **Wet Location Marking :**

Apparatus shall not be exposed to dripping or splashing and no objects filled with liquids, such as vases, shall be placed on the apparatus.

7. **Do not insert any object into the exhaust vent.**

This may cause a fire or could give an electric shock.

8. **Do not place heavy objects on the product.**

This may cause serious injury to a child or adult.

9. **Do not use water the product while cleaning.**

This may cause damaged the product or could give an electric shock.

10. **In case of smoke or strange smell from the product, switch it off ,unplug it from the wall outlet and contact your dealer or service center.**

This may cause a fire or could give an electric shock.

11. **Do not attempt to service the product yourself. Contact your dealer or service center.**

This may cause damaged the product or could give an electric shock.

12. **During a lightning thunder, unplug the product from the wall outlet and don't touch an antenna cable.**

This may cause damaged the product or could give an electric shock.

## ⚠ NOTE

- 1. Never touch the power plug with a wet hand.**

This may cause an electric shock.

- 2. Disconnect from the mains and remove all connections before moving.**

- 3. Do not place the product in a built-in installation such as a bookcase or rack.**

Ventilation required.

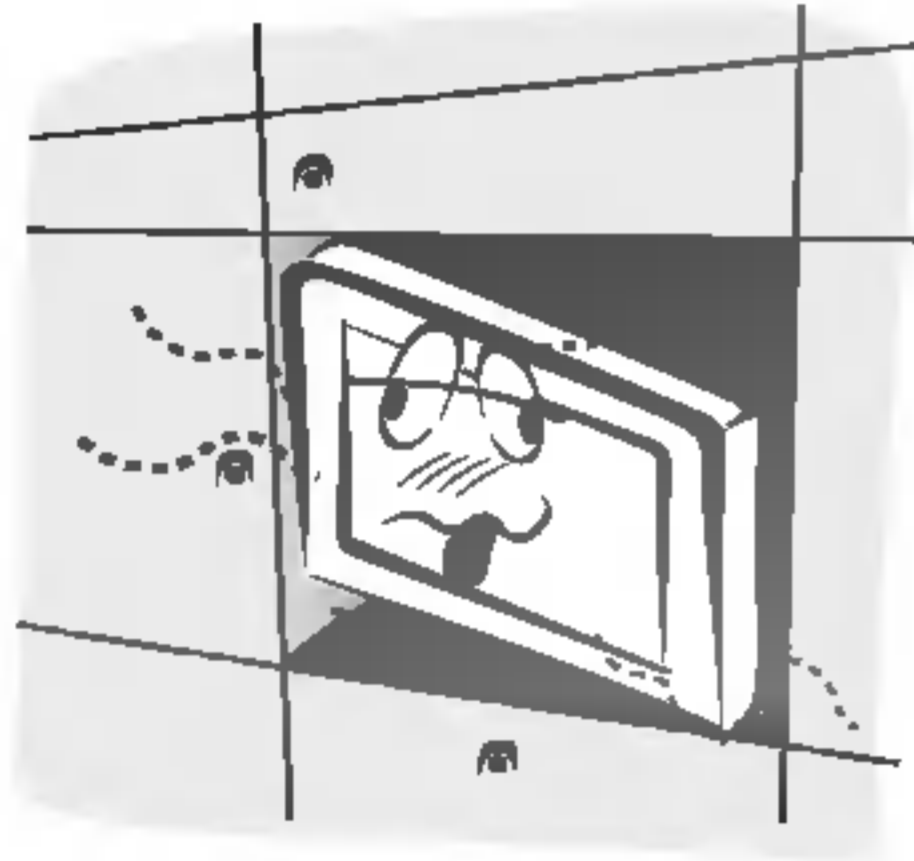

- 4. When installing the product on a table, be careful not to place the edge of its stand.**

This may cause the product to fall, causing serious injury to a child or adult, and serious damage to the product.

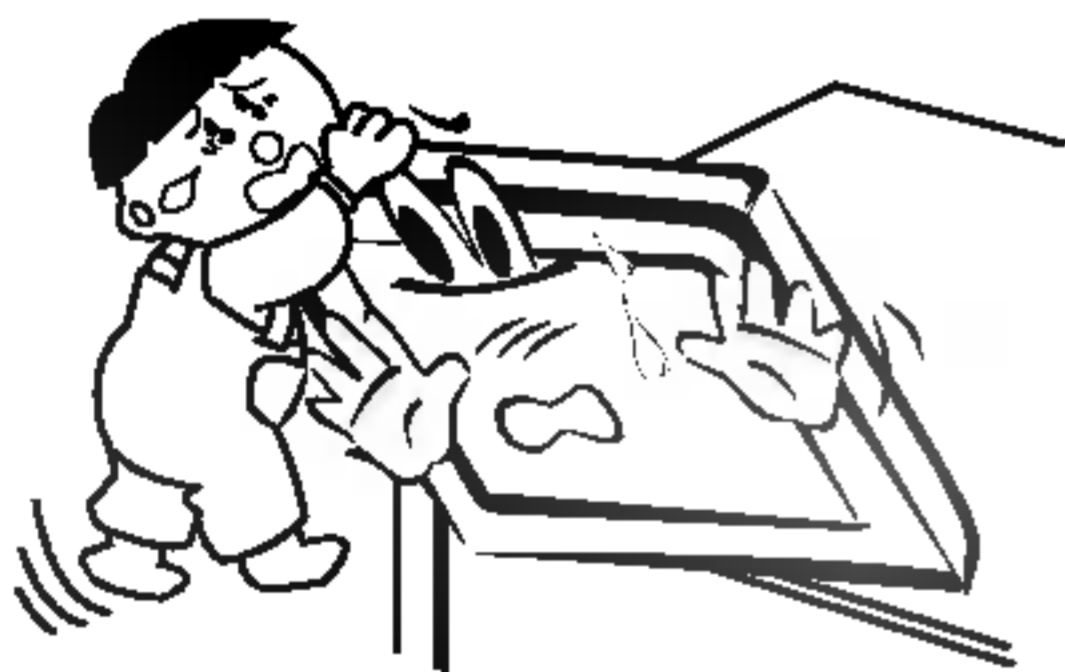

- 5. Do not place an outside antenna in the vicinity of overhead power lines or other electric light or power circuits.**

This may cause an electric shock.

- 6. There should be enough distance between an outside antenna and power lines to keep the former from touching the latter even when the antenna falls.**

This may cause an electric shock.

- 7. Do not pull the cord but the plug when unplugging.**

This may cause a fire.

- 8. Ensure the power cord doesn't trail across any hot objects like a heater.**

This may cause a fire or an electric shock.

- 9. Do not plug when the power cord or the plug is damaged or the connecting part of the power outlet is loose.**

This may cause a fire or an electric shock.

- 10. Dispose of used batteries carefully to protect a child from eating them.**

In case that it eats them, take it to see a doctor immediately.

- 11. When moving the product assembled with speakers do not carry holding the speakers.**

This may cause the product to fall, causing serious injury to a child or adult, and serious damage to the product.

- 12. Unplug this product from the wall outlet before cleaning. Do not use liquid cleaners or aerosol cleaners.**

This may cause damaged the product or could give an electric shock.

- 13. Contact the service center once a year to clean the internal part of the product.**

Accumulated dust can cause mechanical failure.

- 14. The distance between eyes and the screen should be about 5 ~ 7 times as long as diagonal length of the screen.**

If not, eyes will strain.

- 15. Unplug the product from the wall outlet when it is left unattended and unused for long periods of time.**

Accumulated dust may cause a fire or an electric shock from deterioration or electric leakage.

- 16. Only use the specified batteries.**

This may cause damaged the product or could give an electric shock.

# Contents

Safety Instructions	2~3	Special Menu Options	
<b>Introduction</b>		Key Lock	29
Controls	6	ISM (Image Sticking Minimization) Method	29
Connection Options	7	Low Power	30
Remote Control Key Functions	8~9	XD Demo	30
<b>Installation</b>		Closed Captions	31
HDMI	10~11	Caption/Text	31
Installation Instruction	12~13	Screen Menu Options	
Installation Options	14	Auto Adjustment	32
External Equipment Connections	15~20	Setting Picture Format	32
Antenna Connection	15	Manual Configure	32
VCR Setup / Cable TV Setup	16	Selecting VGA Mode	32
External A/V Source Setup	17	Picture size Zoom	33
DVD Setup	17	Screen Position	33
DTV Setup / Monitor Out Setup	18	Cinema Mode Setup	33
PC Setup	19~20	NR(Noise Reduction)	33
		Initializing (Reset to original factory value)	33
<b>Operation</b>		<b>XSTUDIO</b>	
Turning the TV On	21	Notes on Memory Card	34~37
Menu Language Selection	21	JPEG File Viewing Options	38~42
Channel Menu Options		MP3 File Playing Operation	43~46
Auto Program: Channel Search	22	PIP (Picture-In-Picture)/Double Window Feature	
Manual Program: Adding/Deleting Channels	22	Watching PIP/Double Window	47
Fine Tuning Adjustment	22	Swapping the PIP/Double Window	47
Signal Reception Booster	23	Moving the PIP(PIP Mode only)	47
Favorite Channels Setup	23	POP(Picture-out-of-picture: Channel scan)	48
Picture Menu Options		PIP Transparency (PIP Mode only)	48
APC (Auto Picture Control)	24	PIP Size	48
Color Temperature Control	24	TV Program selection for PIP	48
XD	24	Selecting an Input Signal Source for PIP/DW	48
ACM	25	<b>External Control Device Setup</b>	<b>49~55</b>
sRGB	25	<b>IR Codes</b>	<b>56~57</b>
Manual Picture Control(User option)	25	<b>Programming the Remote</b>	<b>58</b>
Sound Menu Options		<b>Programming Codes</b>	<b>58~59</b>
DASP (Digital Auto Sound Processing)	26	<b>Troubleshooting Checklist</b>	<b>60</b>
BBE	26	<b>Product Specifications</b>	<b>61</b>
AVL (Auto Volume Leveler)	26		
Manual Sound Control (User option)	27		
TV speaker Setup	27		
Stereo/SAP Broadcasts Setup	27		
Timer Menu Options			
Clock Setup	28		
On/Off Timer Setup	28		
Auto Off / Sleep Timer	28		

After reading this manual, keep it handy for future reference.

---

# Introduction

## What is a Plasma Display Panel (PDP)?

A plasma display panel is the latest display technology and the best way to achieve flat panel displays with excellent image quality and large screen sizes that are easily viewable. The PDP can be thought of as a descendant of the neon lamp and it can be also be viewed as a series of fluorescent lamps.

## How does it work?

PDP is an array of cells, known as pixels, which are comprised of 3 sub pixels, corresponding to the colors red, green, and blue. Gas in a plasma state is used to react with phosphors in each sub-pixel to produce colored light (red, green, or blue). These phosphors are the same types used in Cathode Ray Tube (CRT) devices such as televisions and common computer monitors.

You get the rich, dynamic colors that you expect. Each sub-pixel is individually controlled by advanced electronics to produce over 16 million different colors. All of this means that you get perfect images that are easily viewable in a display that is less than 5 inches thick.

## 160° - Wide angle range of vision

Your flat panel plasma screen offers an exceptionally broad viewing angle -- over 160 degrees. This means that the display is clear and visible to viewers anywhere in the room who can see the screen.

## Wide Screen

The screen of the Plasma Display is so wide that your viewing experience is as if you are in a theater.

## Multimedia

Connect your plasma display to a PC and you can use it for conferencing, games, and Internet browsing. The Picture-in-Picture feature allows you to view your PC and video images simultaneously.

## Versatile

The light weight and thin size makes it easy to install your plasma display in a variety of locations where conventional TVs will not fit.

## The PDP Manufacturing Process: a few minute colored dots may be present on the PDP screen

The PDP (Plasma Display Panel), which is the display device of this product is composed of 0.9 to 2.2 million cells. A few cell defects will normally occur in the PDP manufacturing process. Several tiny, minute colored dots visible on the screen should be acceptable. This also occurs in other PDP manufacturers' products. The tiny dots appearing does not mean that this PDP is defective. Thus a few cell defects are not sufficient cause for the PDP to be exchanged or returned. Our production technology minimizes these cell defects during the manufacture and operation of this product.

## Cooling Fan Noise

In the same way that a fan is used in a PC computer to keep the CPU (Central Processing Unit) cool, the PDP is equipped with cooling fans to cool the Monitor and improve its reliability. Therefore, a certain level of noise could occur while the fans are operating and cooling the PDP.

The fan noise doesn't have any negative effect on the PDP's efficiency or reliability. The noise from these fans is normal during the operation of this product. We hope you understand that a certain level of noise from the cooling fans is acceptable and is not sufficient cause for the PDP to be exchanged or returned.

# Controls

- This is a simplified representation of front panel.  
Here shown may be somewhat different from your TV.
- This manual explains the features available on the 42PX5R/42PX5R-MC TVs.

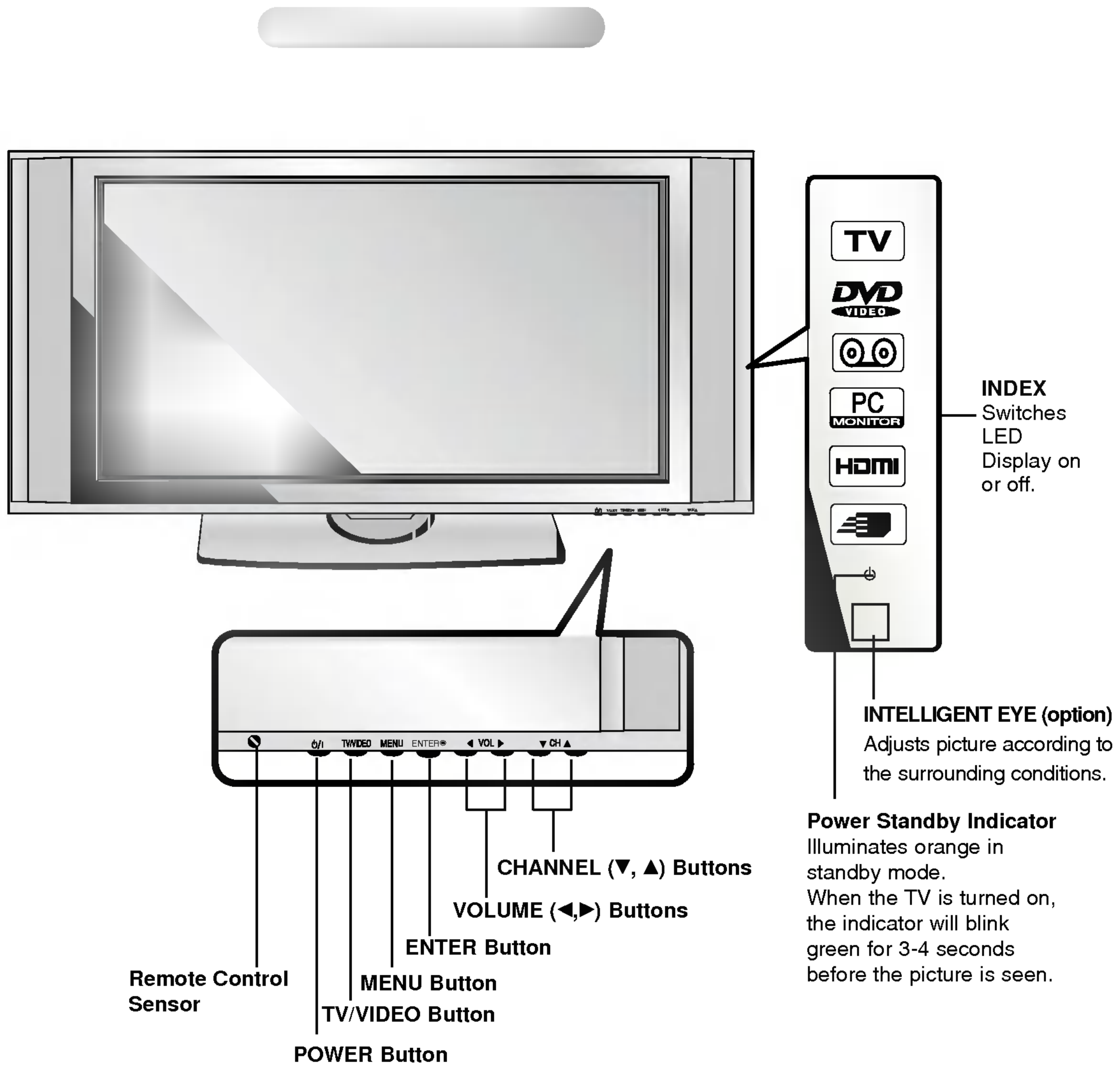

# Connection Options

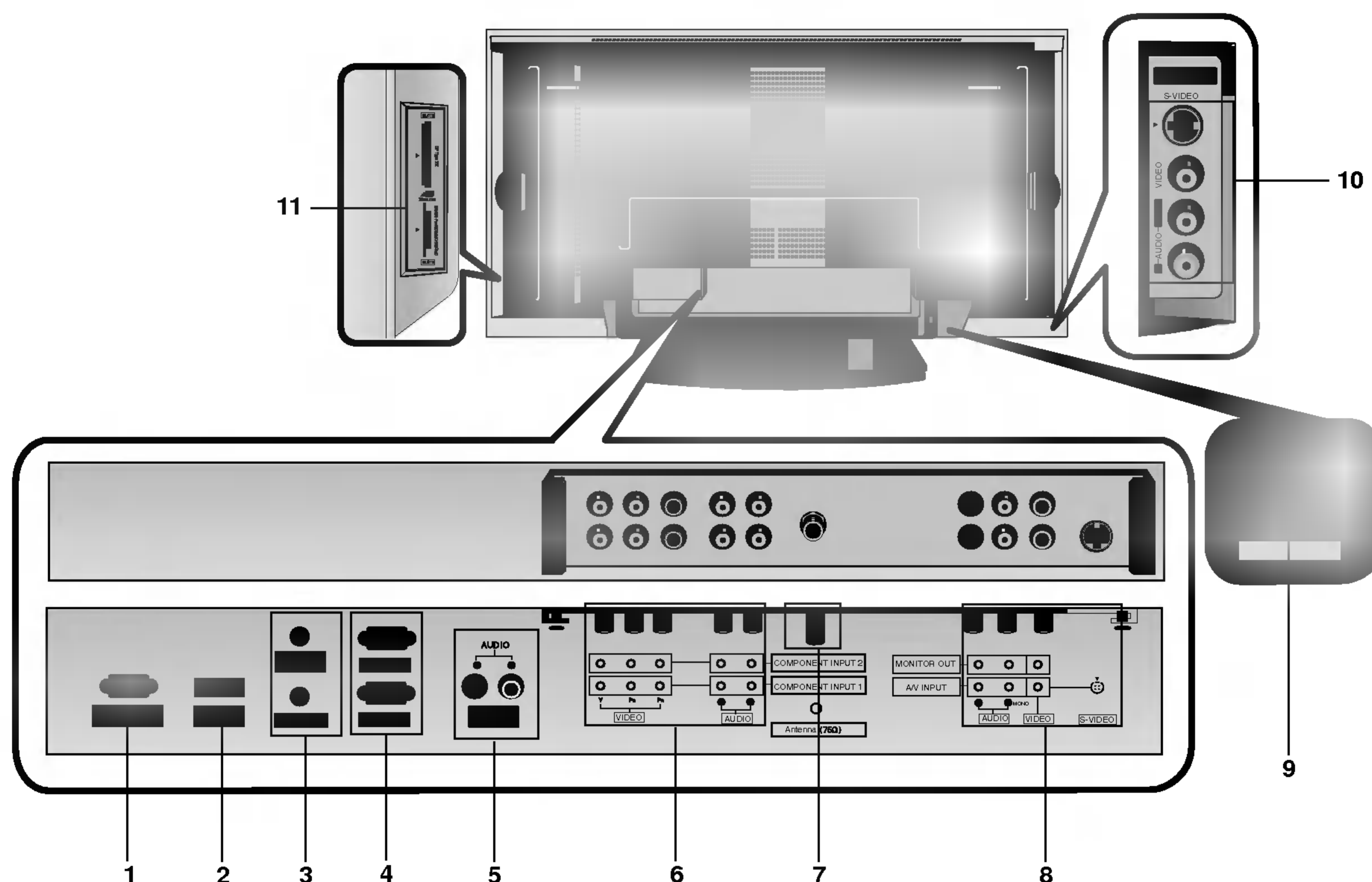

## 1. RS-232C INPUT(CONTROL/SERVICE) PORT

Connect to the RS-232C port on a PC.

## 2. HDMI/DVI (VIDEO)

Connect a HDMI signal to this jack. Or connect a DVI(Video) signal.

## 3. REMOTE CONTROL / AUDIO INPUT (for RGB, DVI)

### 4. RGB INPUT

Connect the monitor output connector from a PC to the appropriate input port.

### RGB OUTPUT

You can watch the RGB signal on another monitor, connect RGB OUTPUT to another monitor's PC input port.

## 5. VARIABLE AUDIO OUTPUT

## 6. COMPONENT INPUT

Connect a component video/audio device to these jacks.

## 7. ANTENNA INPUT

## 8. VIDEO/AUDIO IN/OUT SOCKETS (AV1)

Connect the video/audio out sockets of external equipment to these sockets.

### S-VIDEO/AUDIO IN SOCKETS

Connect the S-VIDEO out socket of an VCR to the **S-VIDEO** socket.

Connect the audio out sockets of the VCR to the audio sockets as in **AV1**.

### MONITOR OUT

Connect a second TV or Monitor.

## 9. POWER CORD SOCKET

This the set operates on an AC power. The voltage is indicated on the Specifications page. Never attempt to operate the set on DC power.

## 10. AUDIO/VIDEO INPUT (AV2) S-VIDEO/AUDIO IN SOCKETS

## 11. Memory Card Slots

# Remote Control Key Functions

- When using the remote control, aim it at the remote control sensor on the TV.

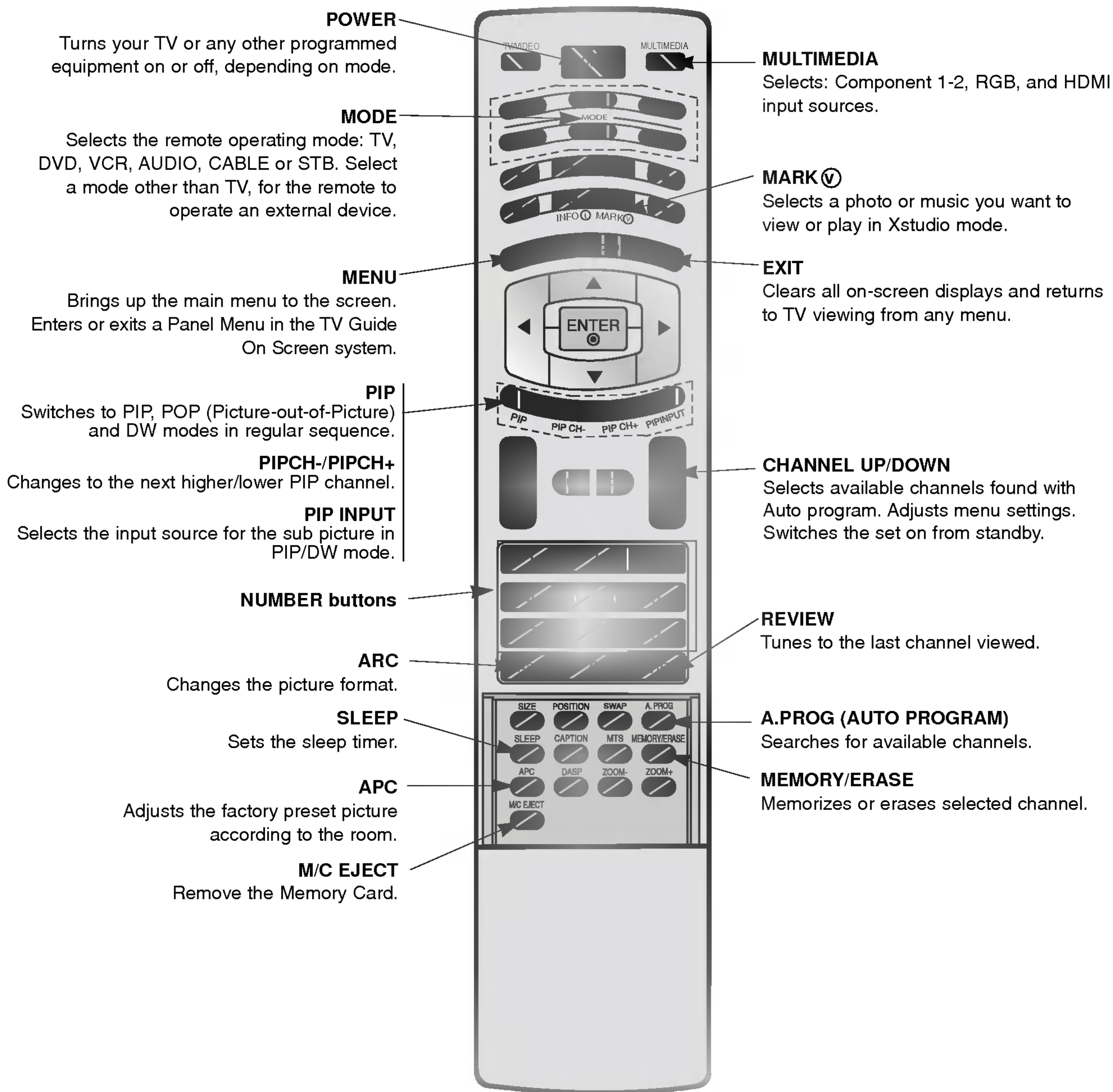

## Installing Batteries

- Open the battery compartment cover on the back side and install the batteries matching correct polarity (+ to +, - to -).
- Install two 1.5V AA batteries. Don't mix old or used batteries with new ones. Replace cover.

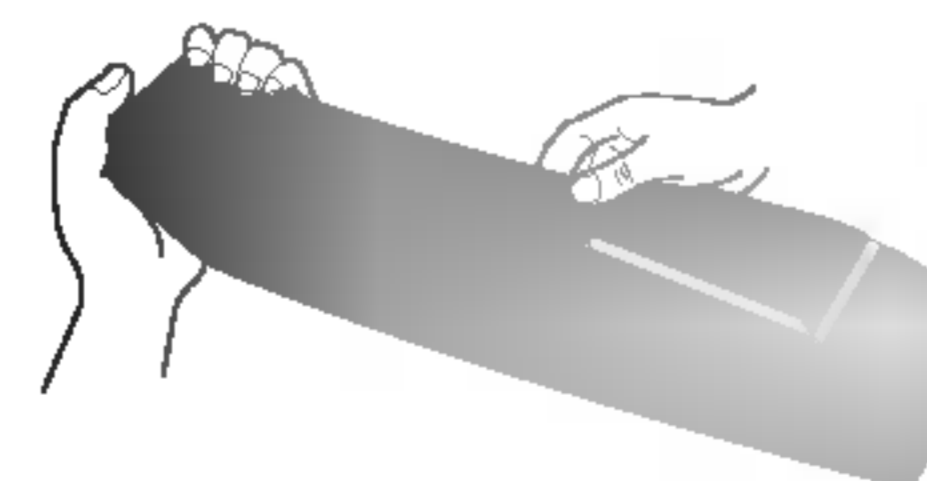

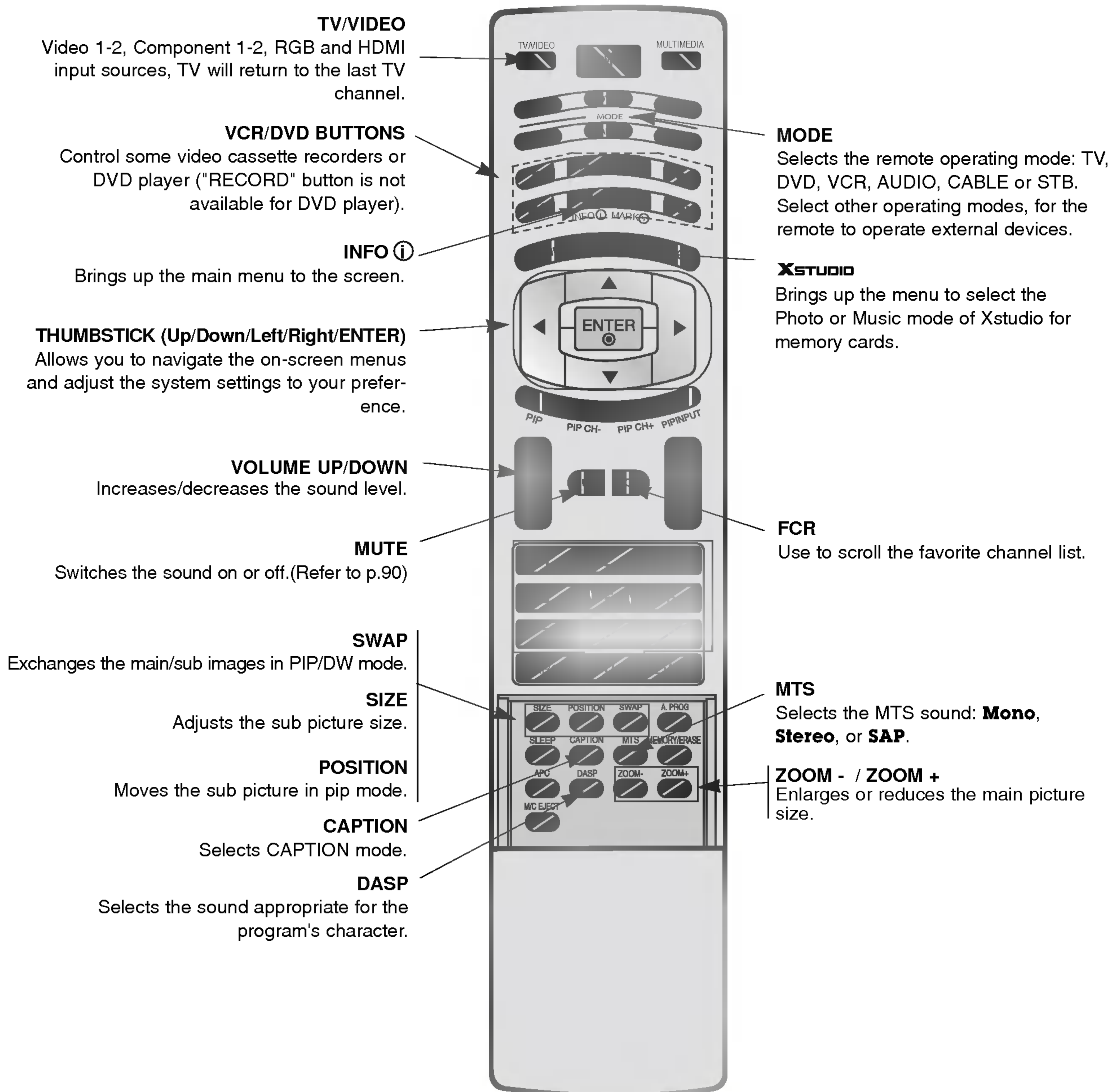



- HDMI™, the HDMI logo and High-Definition Multimedia Interface are trademarks or registered trademarks of HDMI Licensing.
- This set can receive the High-Definition Multimedia Interface (HDMI) or Input of Digital Visual Interface(DVI).
- This set supports HDCP (High-bandwidth Digital Contents Protection) Protocol for the set (480p, 720p, 1080i) modes.
- When you Connect with HDMI/DVI Source Devices (DVD Player or Set Top Box or PC) supporting Auto HDMI/DVI function, automatically, support Plug & Play and then set the HDMI/DVI Source Devices (640 x 480p). After reading in HDMI/DVI Source Devices using Display Data Channel(DDC) Protocol, EDID stored in the set is used. If HDMI/DVI Source Devices not supported Auto HDMI/DVI is been, the Resolution is set, manually.
- To get the best picture quality, adjust the DVD Player or Set Top Box output resolution to 640 x 480p.
- To get the best picture quality, adjust the PC graphics card to 640 x 480, 60Hz.
- When Source Devices have DVI Output Connector, you must connect audio with separated cable.(Refer to <How to connect>)

## How to connect

1. When Source Devices (DVD Player or Set Top Box) support HDMI.
  - If Source Devices have HDMI Output Connector, Source Devices connect to the set with HDMI Cable .(not supplied with the product).
  - If Source Devices support Auto HDMI, automatically, Source Devices divert output resolution in 640x480p. But if not, resolution divert Manually Setting for reference Manual of Source Devices.
  - To get the best picture quality, adjust the DVD Player or Set Top Box output resolution to 640x480p.
  - Because HDMI sends Digital Video and Audio with one cable, need not especial Audio Cable for using HDMI Cable.
2. When Source Devices (DVD Player or Set Top Box) supports DVI.
  - If Source Devices have DVI Output Connector, Source Devices connect to the set with HDMI to DVI Cable (not supplied with the product).
  - If Source Devices support Auto DVI, automatically, Source Devices divert output resolution in 640x480p. But if not, resolution divert Manually Setting for reference Manual of Source Devices.
  - To get the best picture quality, adjust the DVD Player or Set Top Box output resolution to 640x480p.
  - In this case, Audio use other cable. When Source Devices have Analog Audio Output Connector, RGB/DVI Audio Input of the set connect to Audio Cable (not supplied with the product). And then you can listen to normal Audio.
3. When PC supports DVI.
  - If PC have DVI Output Connector, Source Devices connect to the set with HDMI to DVI Cable (not supplied with the product).
  - To get the best picture quality, adjust the PC graphics card to 640x480, 60Hz.
  - Use the the set's HDMI/DVI (VIDEO) for video connections, depending on your PC connector.
  - If the graphics card on the PC does not output analog RGB and DVI simultaneously, connect only one of either RGB Input or HDMI Input to display the PC on the set.
  - If he graphics card on the PC does output analog RGB and DVI simultaneously, the set to either RGB Input or HDMI Input; (the other mode is set to Plug and Play automatically by the set.)
  - Then, make the corresponding audio connections. If using a sound card, adjust the PC sound as required.
  - In this case, Audio use other cable. When PC (or sound card of PC) have Analog Audio Output Connector, RGB/DVI Audio Input of the set connect to Analog Audio Cable (not supplied with the product). And then you can listen to normal Audio.

## Reference

### Cable sample

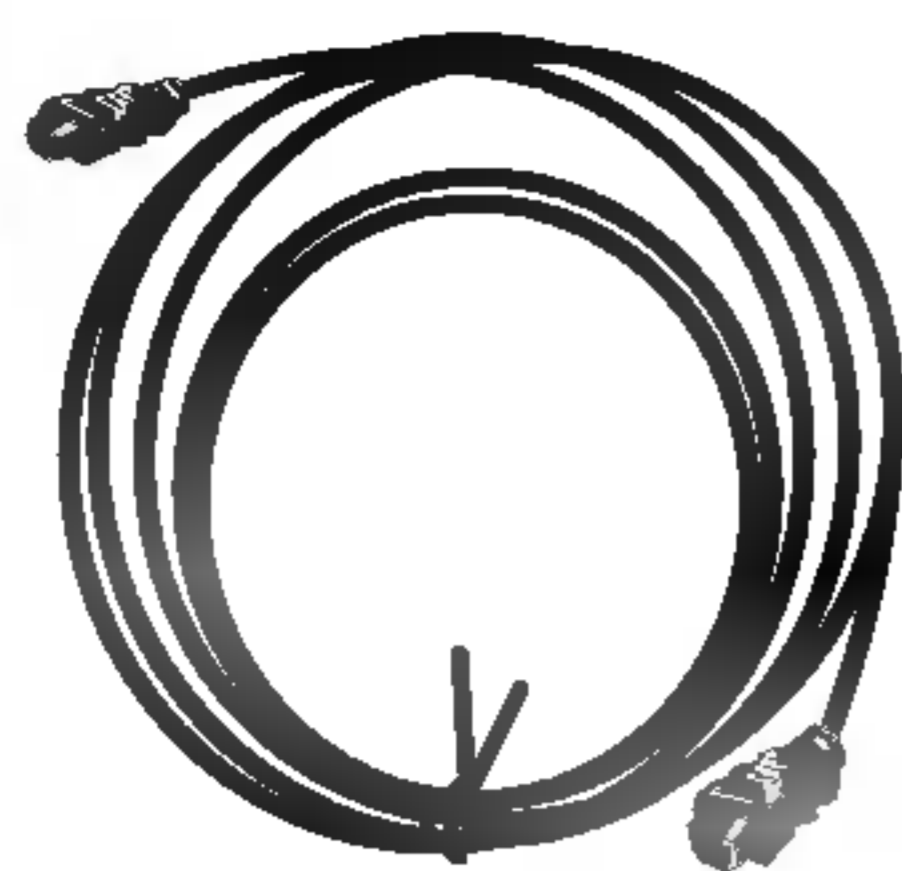

HDMI Cable  
(not supplied with the product)

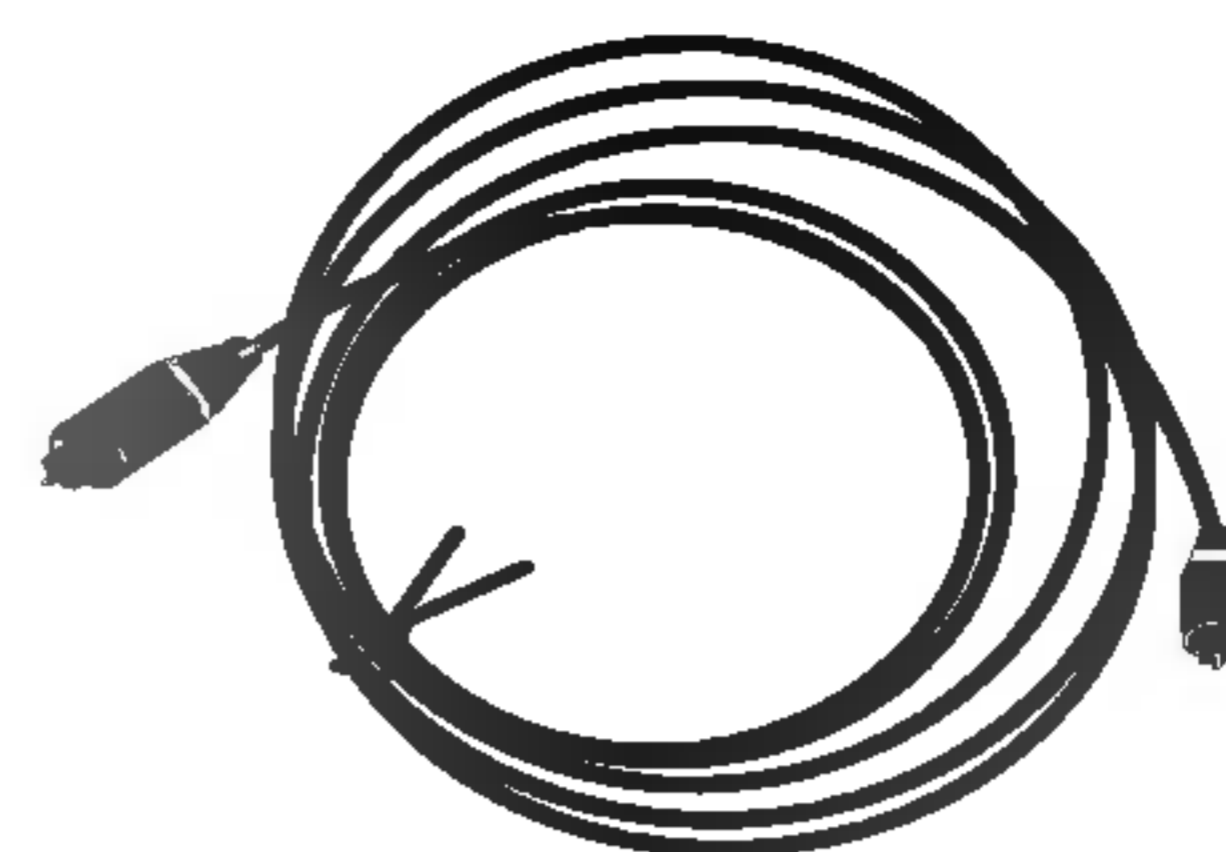

Analog Audio Cable (RCA type)  
(not supplied with the product)



HDMI to DVI Cable  
(not supplied with the product)



Analog Audio Cable (Stereo to RCA type)  
(not supplied with the product)

## How to use

1. Connect the HDMI Source Devices(DVD Player or Set Top Box or PC) and the set.
2. Turn on the display by pressing the POWER button on the set and HDMI Source Devices remote control.
3. Select HDMI Input source in Main Input option of PIP/DW menu.
4. Check the image on your set. There may be noise associated with the resolution, vertical pattern, contrast or brightness in HDMI Source Devices. If noise is present, change the HDMI Source Devices to another resolution, change the refresh rate or adjust the brightness and contrast on the menu until the picture is clear. If the refresh rate of the PC graphics card can not changed, change the PC graphics card or consult the manufacturer of the PC graphics card.

### Notes:

- Depending on the graphics card, DOS mode may not work if you use a HDMI to DVI Cable.
- Avoid keeping a fixed image on the set screen for a long period of time. The fixed image may become permanently imprinted on the screen. Use the Orbiter screen saver when possible.
- When Source Devices connected HDMI Input, output PC Resolution, Position, Size may not fit to Screen. As shown the lower picture, press the **MENU** button to adjust the screen Position of the set and contact an PC graphics card service center.
- In case HDMI Source Devices is not connected Cable or poor cable connection, "No Signal" OSD display in HDMI Input. And In case of Video Resolution not supported the set output in HDMI Source Devices, "No Signal" OSD display. Refer to the Manual of HDMI Source Devices or contact your service center.

# Installation

## Installation Instructions

- It is recommended that 42PX5R model and 50PX4R/50PX5R models only be used at an altitude of less than 3281 feet (1000m) to get the best quality picture and sound.
- It is recommended that 50PX5RH model only be used at an altitude of less than 6561 feet (2000m) to get the best quality picture and sound.
- The TV is designed to be mounted horizontally.

### GROUNDING

Ensure that you connect the grounding / earth wire to prevent possible electric shock. If grounding methods are not possible, have a qualified electrician install a separate circuit breaker. Do not try to ground the unit by connecting it to telephone wires, lightening rods, or gas pipes.

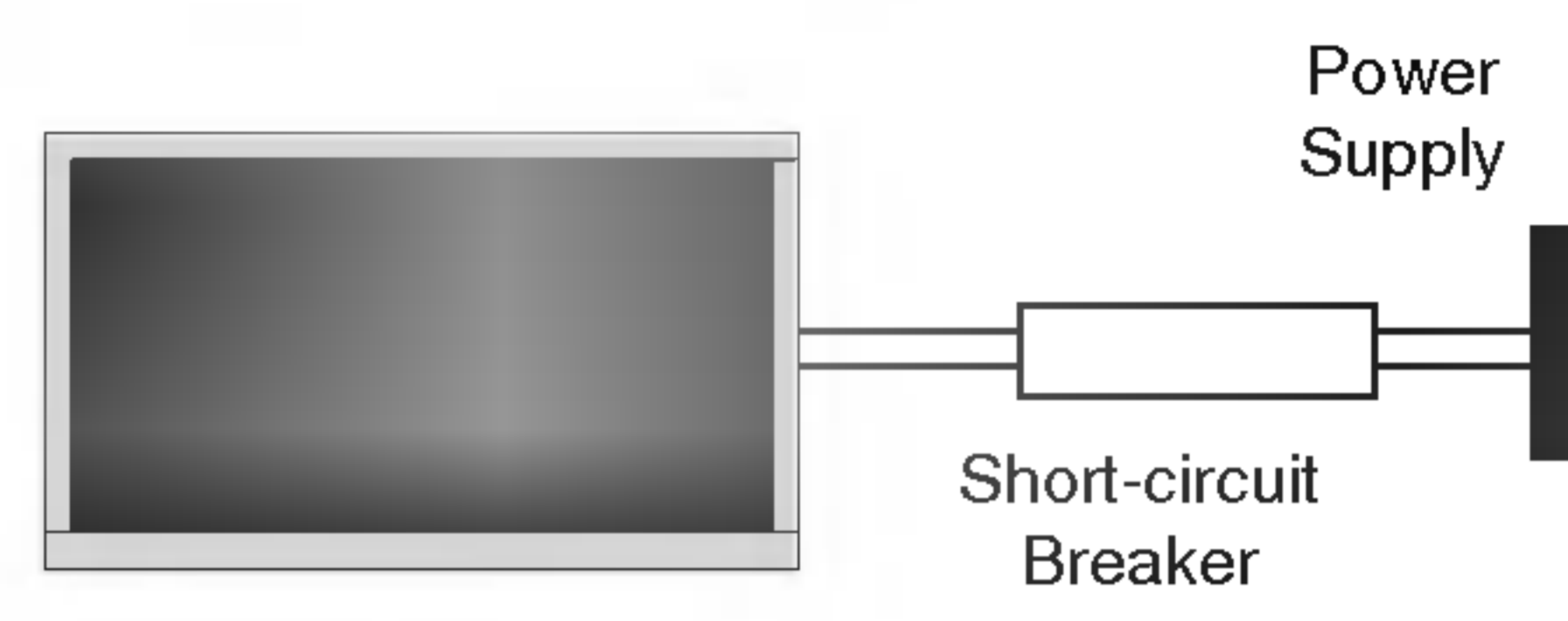

Ensure that the following accessories are included with your plasma display. If an accessory is missing, please contact the dealer where you purchased the product.

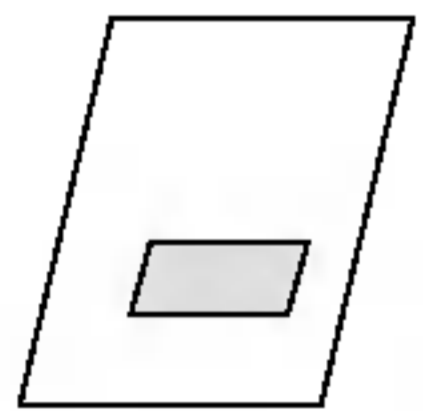

Owner's Manual



Remote Control



2-Eye Bolts

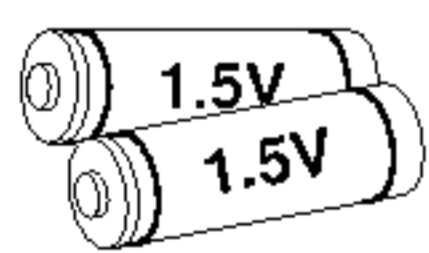

Batteries



Power Cord



2-Wall brackets

- Optional extras can be changed or modified for quality improvement without any notification new optional extras can be added.
- Contract your dealer for buying these items.

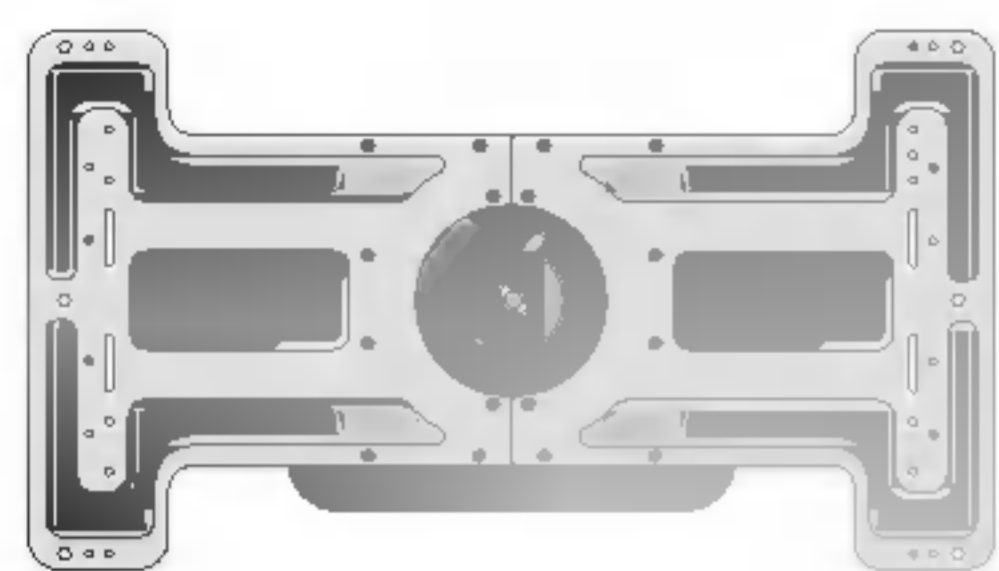

Tilt wall mounting bracket

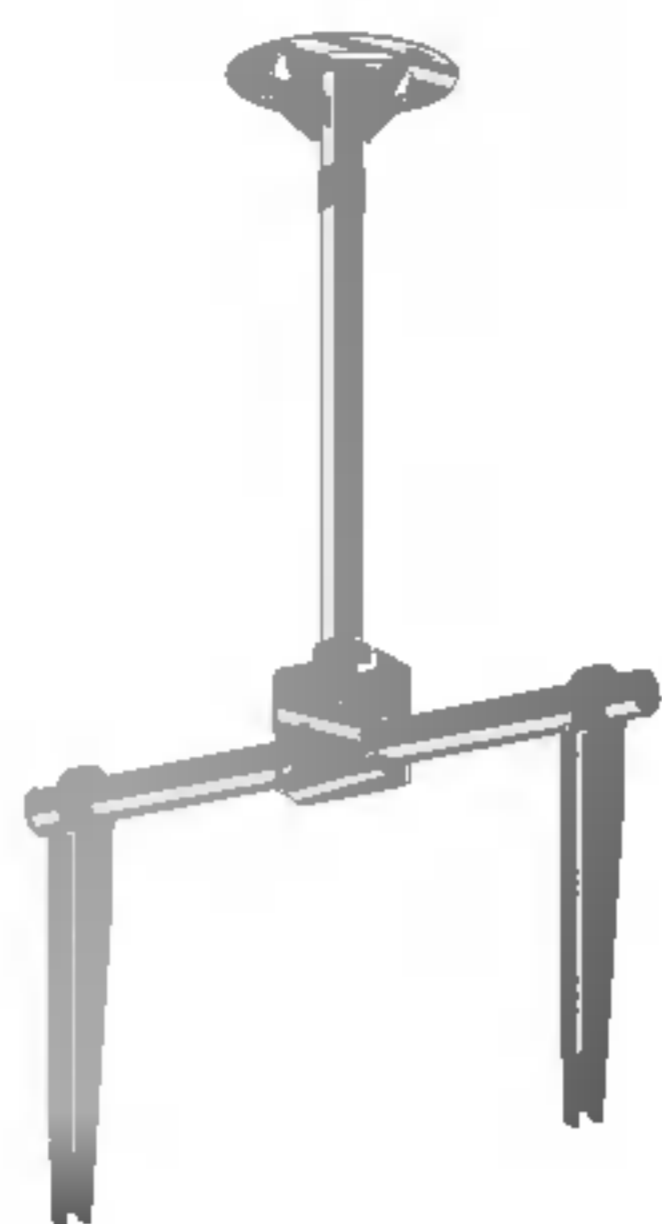

Ceiling mounting bracket



Video cables

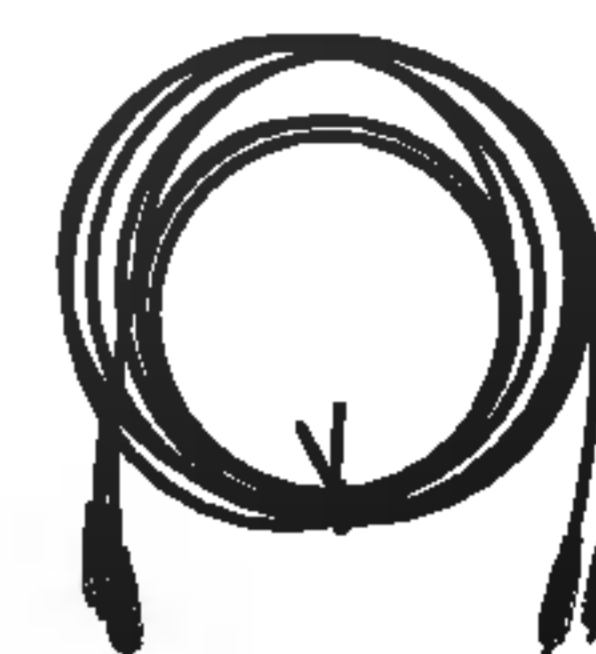

Audio cables

### Joining the TV assembly to the wall to protect the set tumbling

- Secure the TV assembly by joining it to a wall by using the Eye Bolts/Wall brackets.

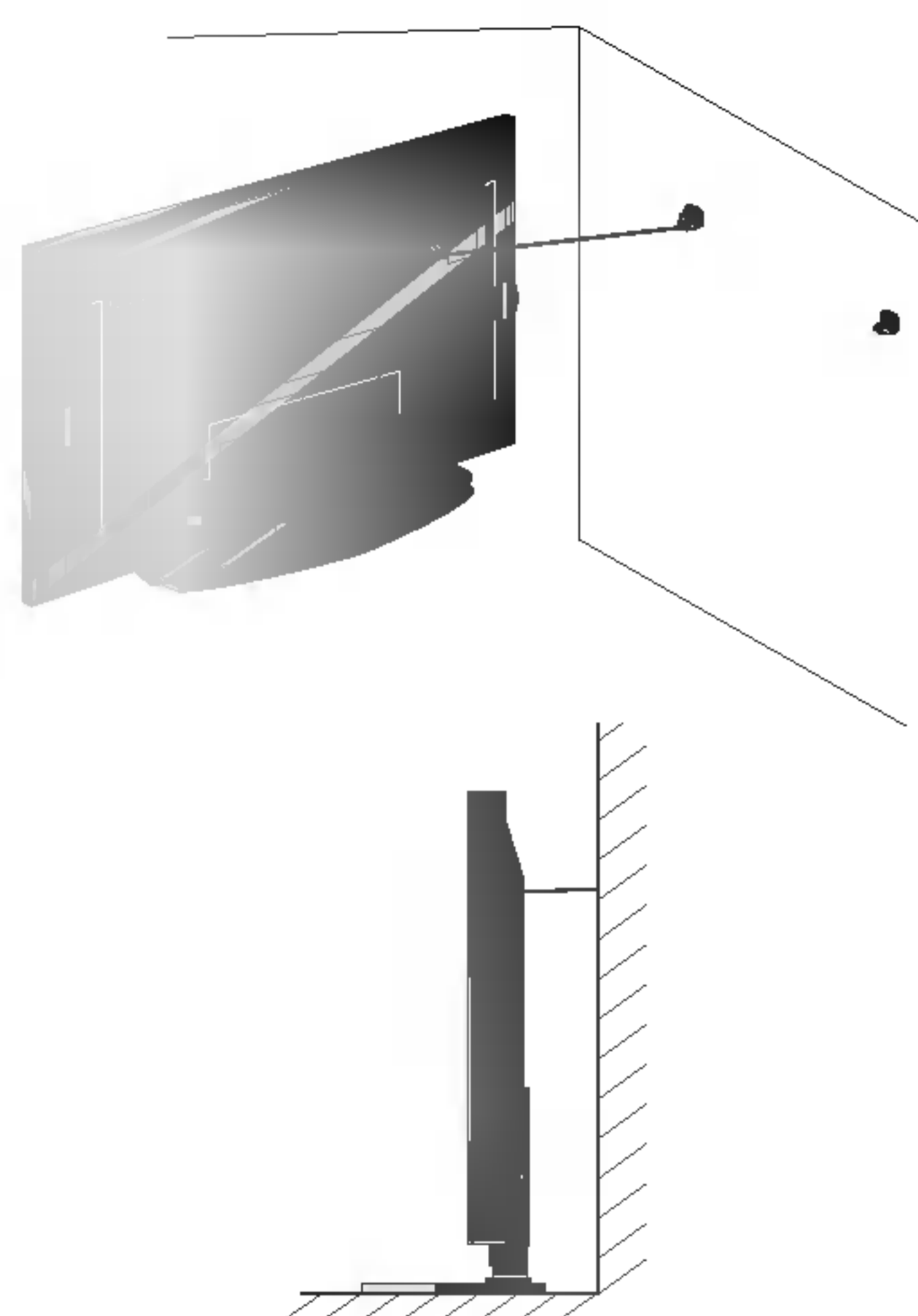

- If the set will be mounted on a desk top, insert the 2 eye-bolts and tighten them securely in the upper holes as shown.  
Install the wall brackets on the wall with 2 bolts\*, (not supplied with the product), as shown.  
Match the height of the eye-bolts and the wall brackets.  
Check to be sure the eye-bolts and the brackets are tightened securely.

- Secure the TV assembly to the wall with strong strings or wound wire cables, (not supplied with the product), as shown.

# Installation Options

- The set can be installed in different ways such as on a wall, or on a desktop etc.
- Install this set only in a location where adequate ventilation is available.

## Wall Mount: Horizontal Installation

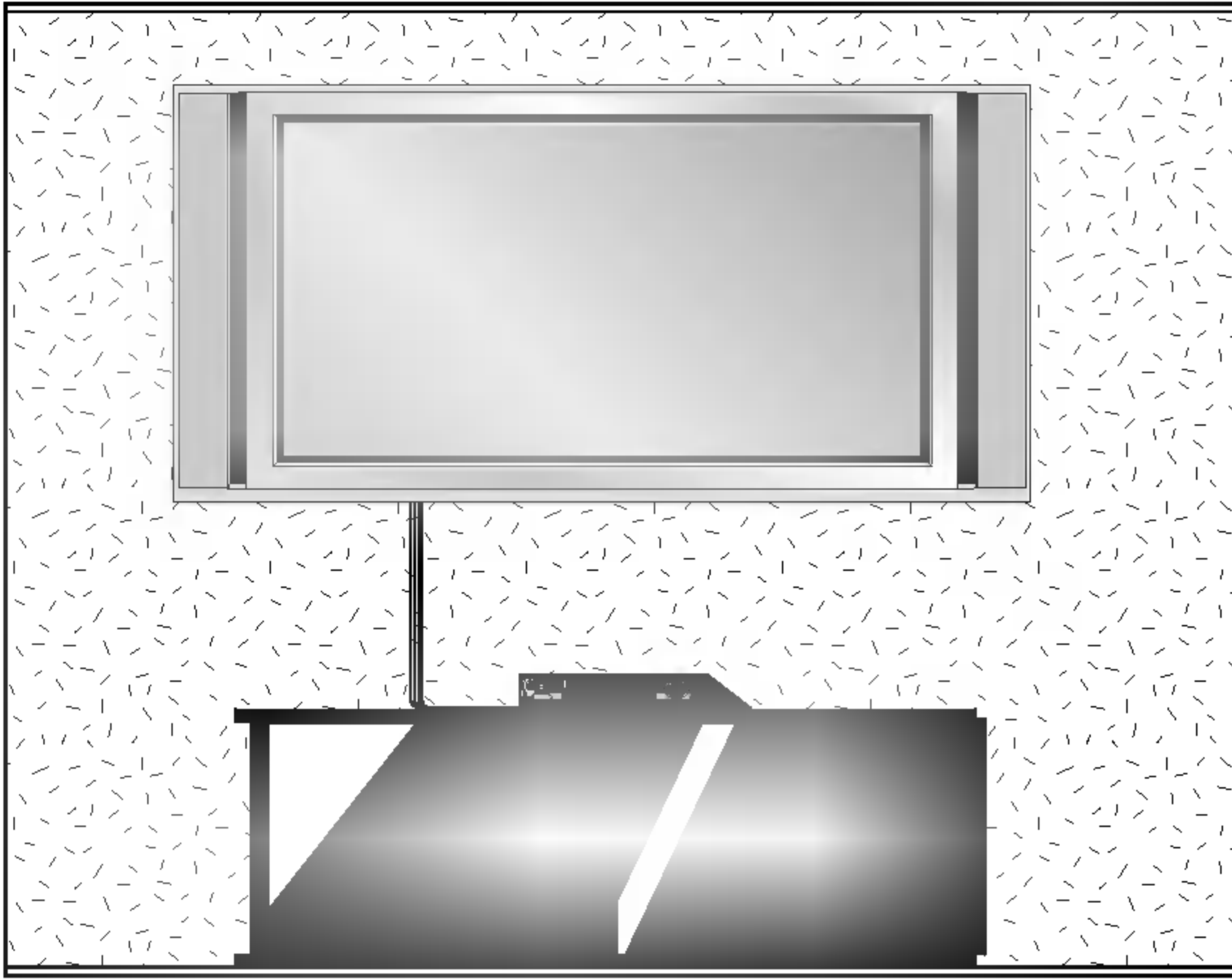

- The set can be installed on a wall as shown above. (For further information, refer to the optional 'Wall Mounting Bracket Installation and Setup Guide'.)

## Desktop Pedestal Installation

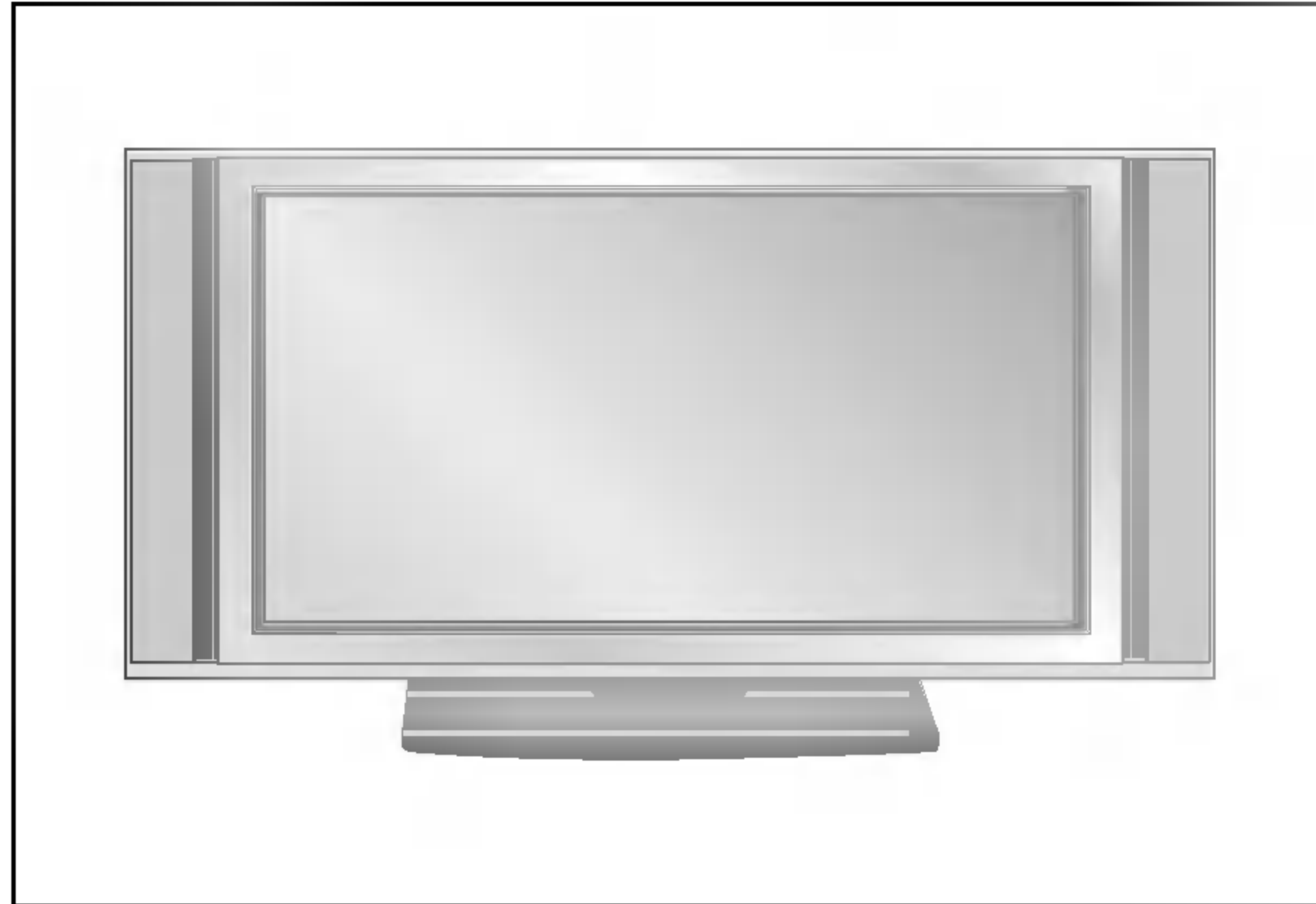

- The set can be mounted on a desk as shown above. (For further information, refer to the optional 'Desktop Stand Installation and Setup Guide'.)

### To Mount on a Wall

Wall mount minimum allowable clearances for adequate ventilation.

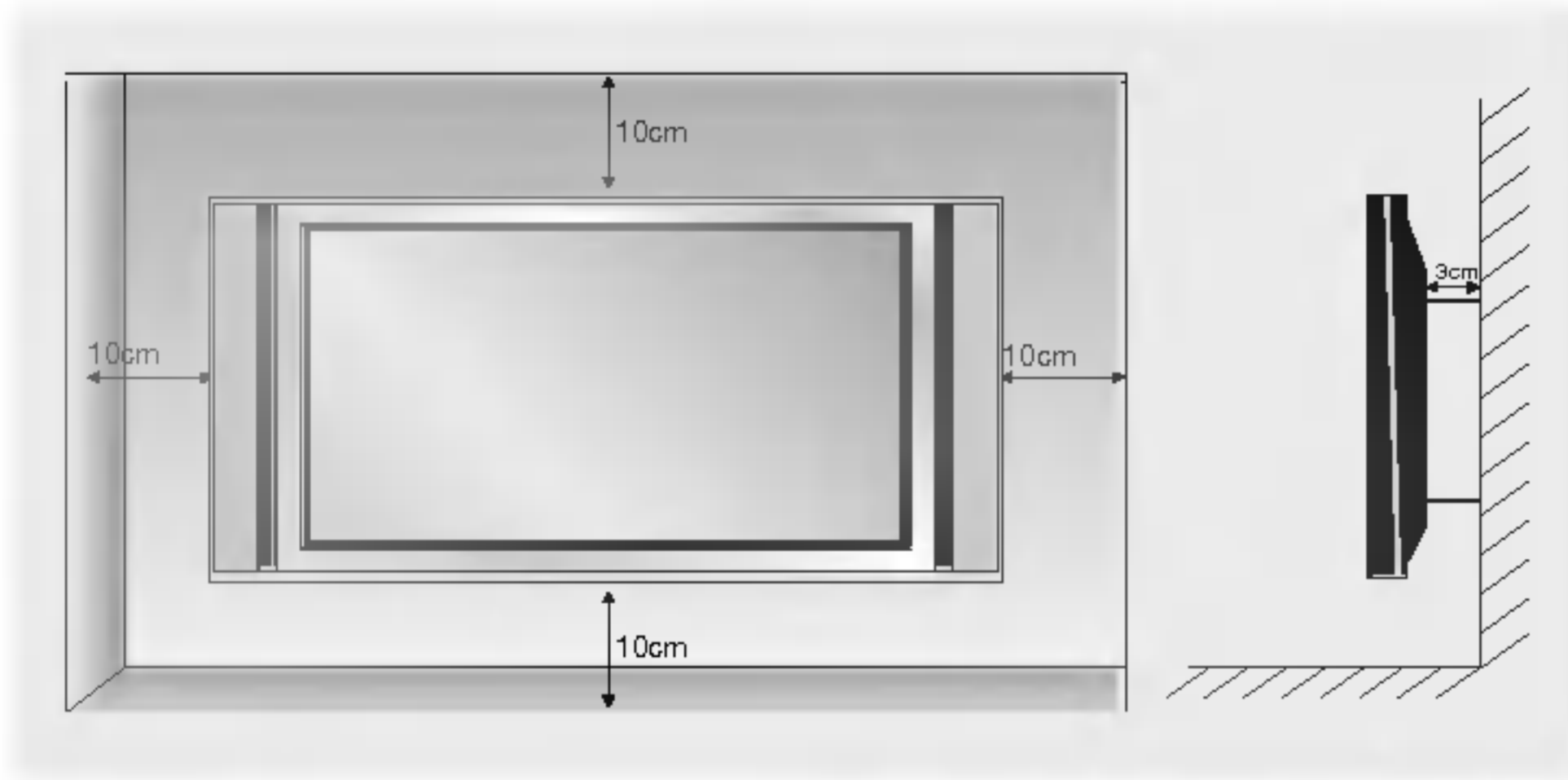

### To Install on a Desktop

Pedestal mount minimum allowable clearances for adequate ventilation.

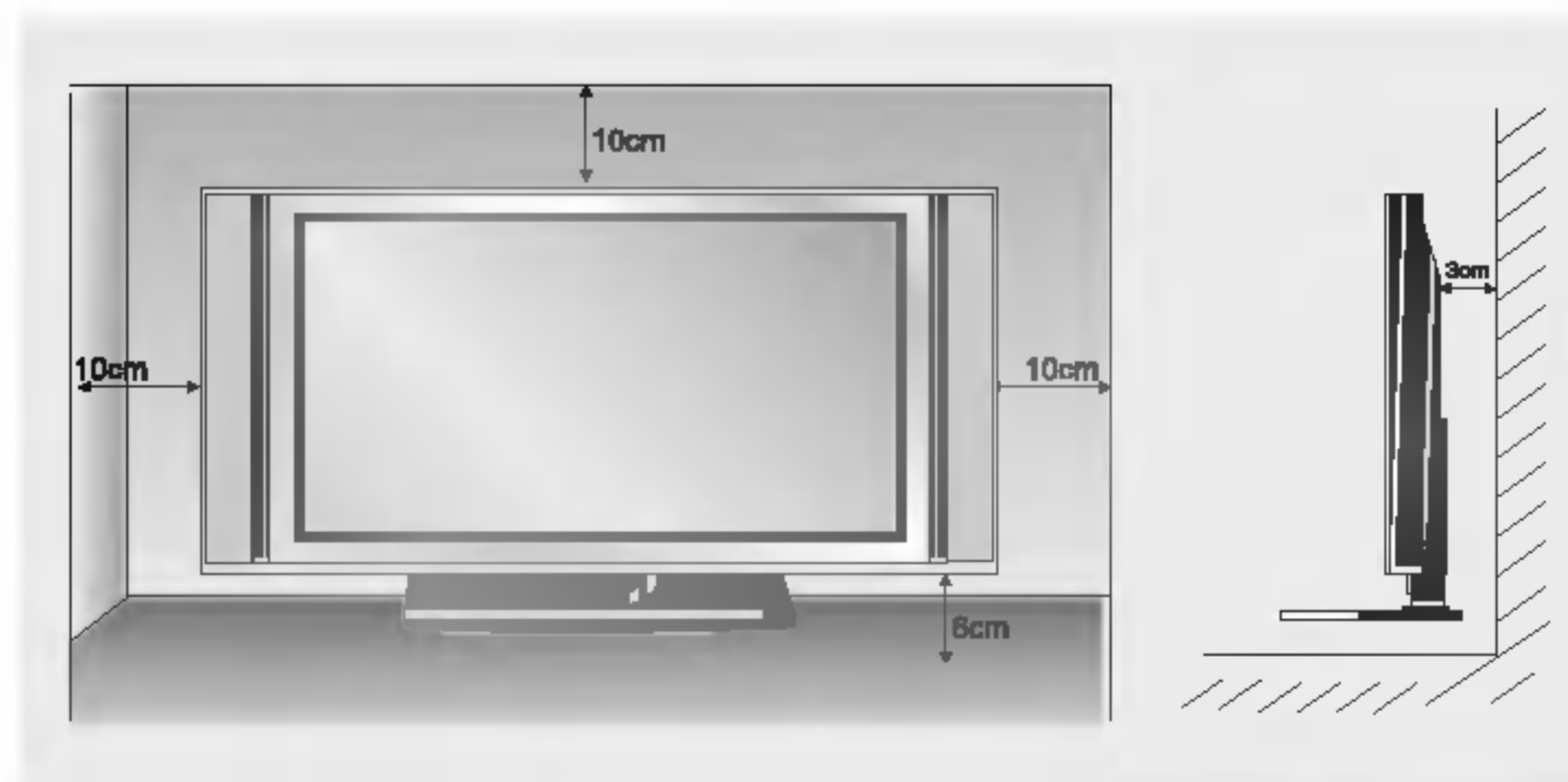

## Swivel function (option)

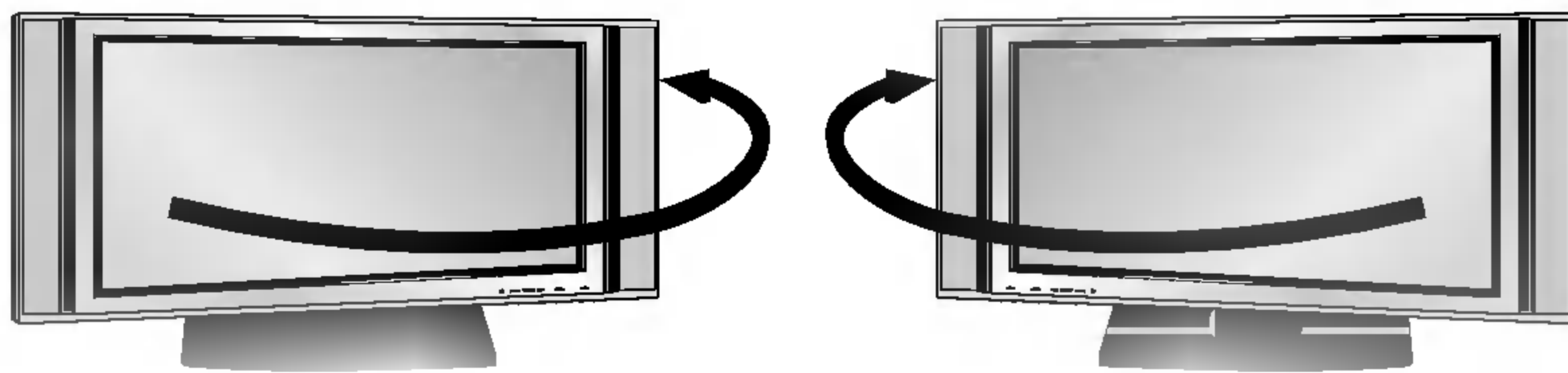

- After installing the set, you can adjust the the set manually to the left or right direction by 20 degrees to suit your viewing position.

**Note :** Before adjusting the angle, you must loosen (to the left) the shaft bolt on the middle of stand's back. And when stand be level with set, you must close (to the right) the shaft bolt to set the hole.

# External Equipment Connections

- Antenna or Cable Service without a Cable Box Connections
- For optimum picture quality, adjust antenna direction if needed.

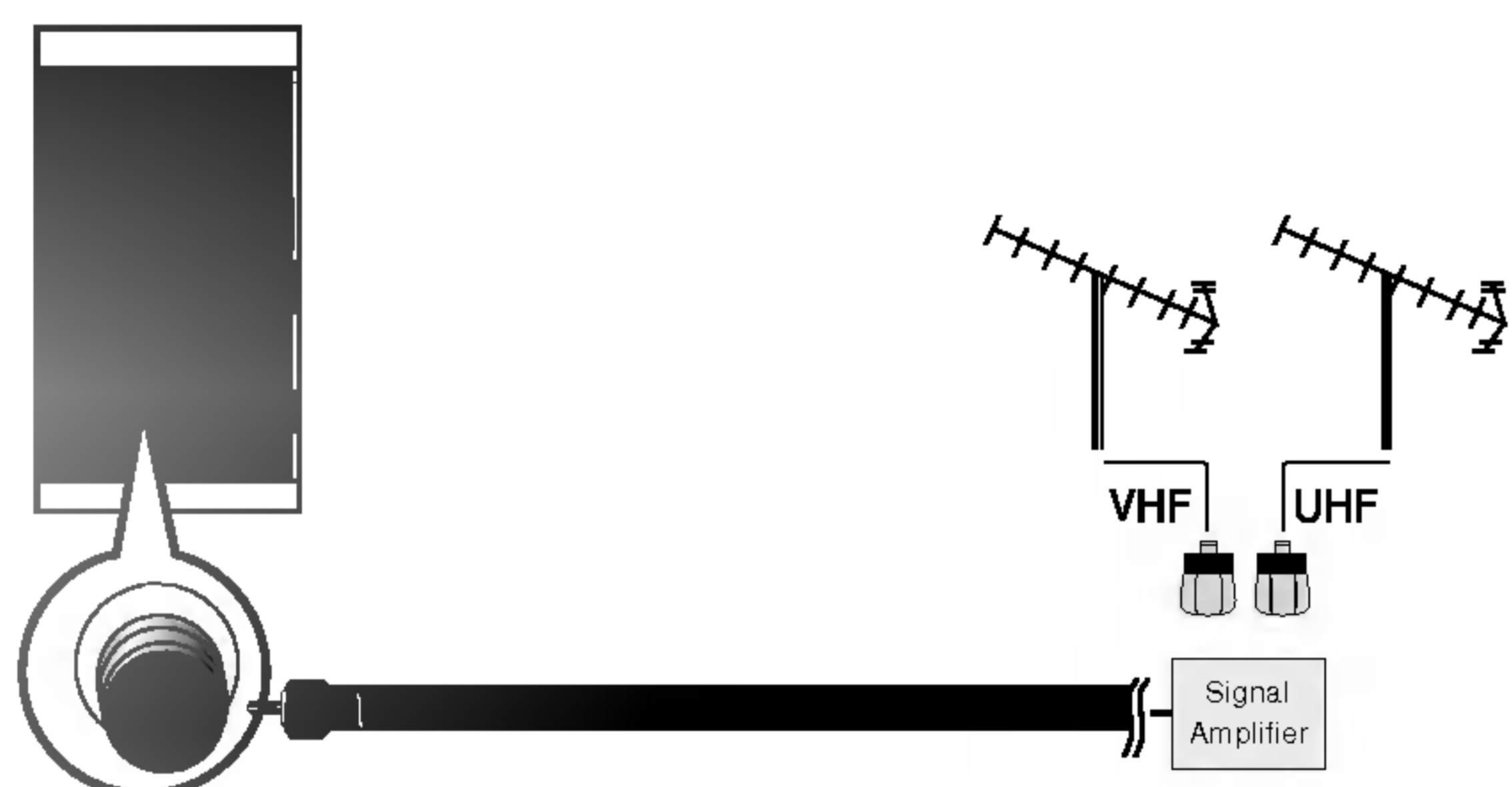
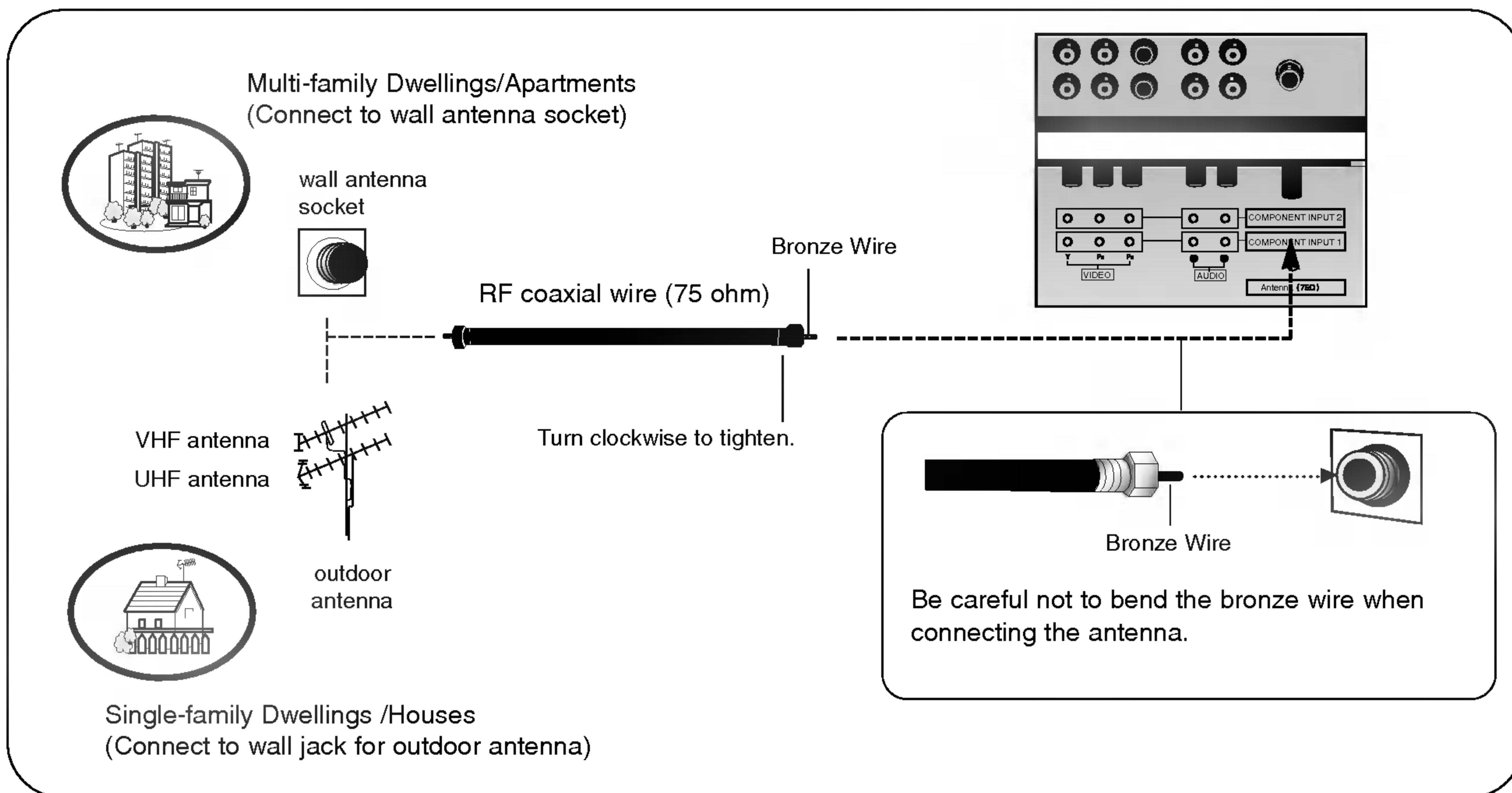

- To improve the picture quality in a poor signal area, please purchase a signal amplifier and install properly.
- If the antenna needs to be split for two TV's, install a "2-Way Signal Splitter" in the connections.
- If the antenna is not installed properly, contact your dealer for assistance.

**NOTE: All cables shown are not included with the TV.**

- To avoid picture noise (interference), leave an adequate distance between the VCR and TV.
- Use the ISM Method (on the Special menu) feature to avoid having a fixed image remain on the screen for a long period of time. Typically a frozen still picture from a VCR. If the 4:3 picture format is used; the fixed images on the sides of the screen may remain visible on the screen.

**Connection Option 1**

Set VCR output switch to 3 or 4 and then tune TV to the same channel number.

**Connection Option 2**

1. Connect the audio and video cables from the VCR's output jacks to the TV input jacks, as shown in the figure.  
When connecting the TV to VCR, match the jack colors (Video = yellow, Audio Left = white, and Audio Right = red).  
If you connect an S-VIDEO output from VCR to the S-VIDEO input, the picture quality is improved; compared to connecting a regular VCR to the Video input.
2. Insert a video tape into the VCR and press PLAY on the VCR. (Refer to the VCR owner's manual.)
3. Select the input source with using the **TV/VIDEO** button on the remote control. (If connected to A/V INPUT 2, select **Video 2** input source.)



Do not connect to both Video and S-Video at the same time. In the event that you connect both Video and the S-Video cables, only the S-Video will work.

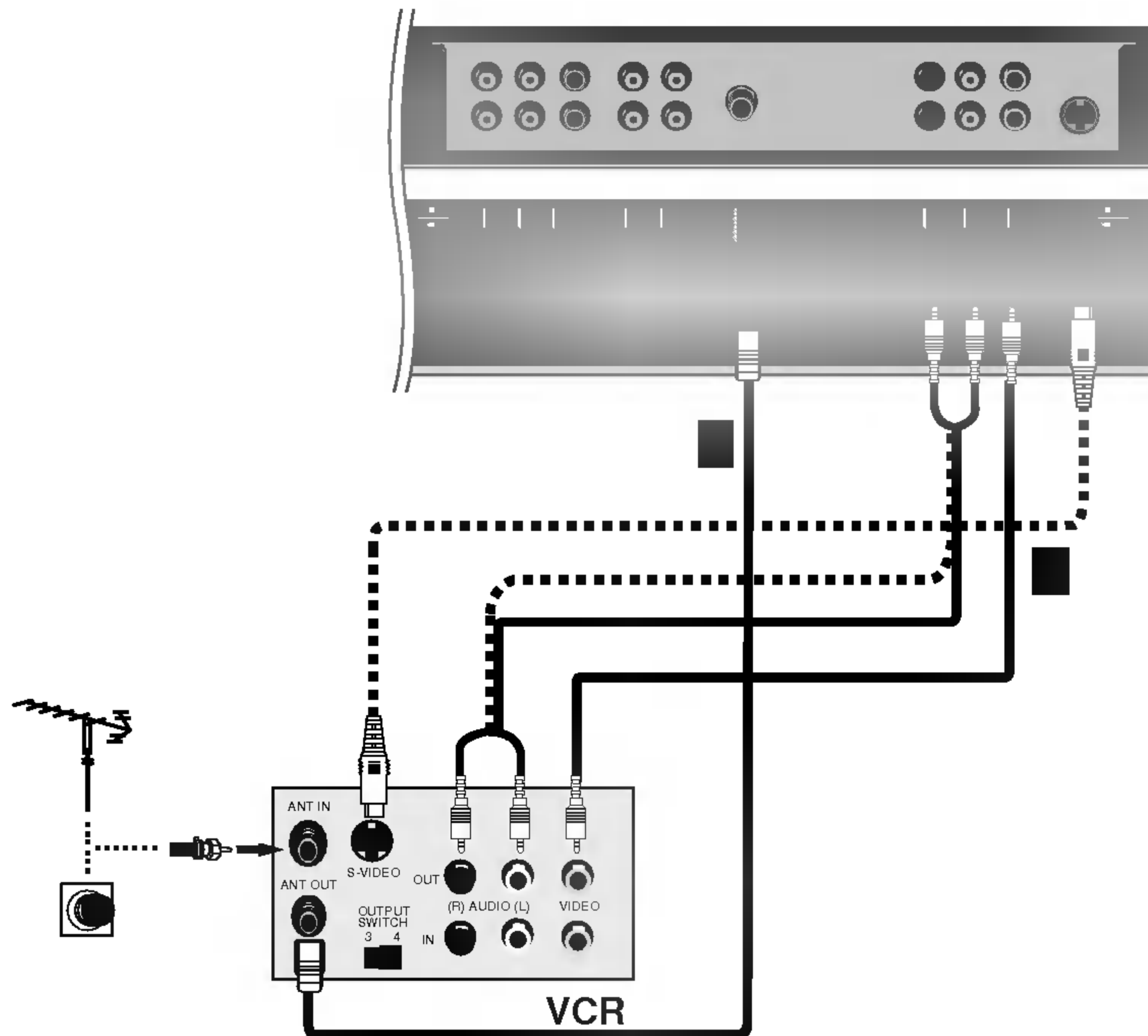

- After subscribing to a cable TV service from a local provider and installing a converter, you can watch cable TV programming. The TV cannot display TV programming unless a TV tuner device or cable TV converter box is connected to the TV.
- For further information regarding cable TV service, contact your local cable TV service provider(s).

**Connection Option 1**

1. Select 3 or 4 with channel switch on cable box.
2. Tune the TV channel to the same selected output channel on cable box.
3. Select channels at the cable box or with the cable box remote control.

**Connection Option 2**

1. Connect the audio and video cables from the Cable Box's output jacks to the TV input jacks, as shown in the figure.  
When connecting the TV to a Cable Box, match the jack colors (Video = yellow, Audio Left = white, and Audio Right = red).
2. Select the input source with using the **TV/VIDEO** button on the remote control. (If connected to A/V INPUT 1, select **Video 1** input source.)
3. Select your desired channel with the remote control for cable box.

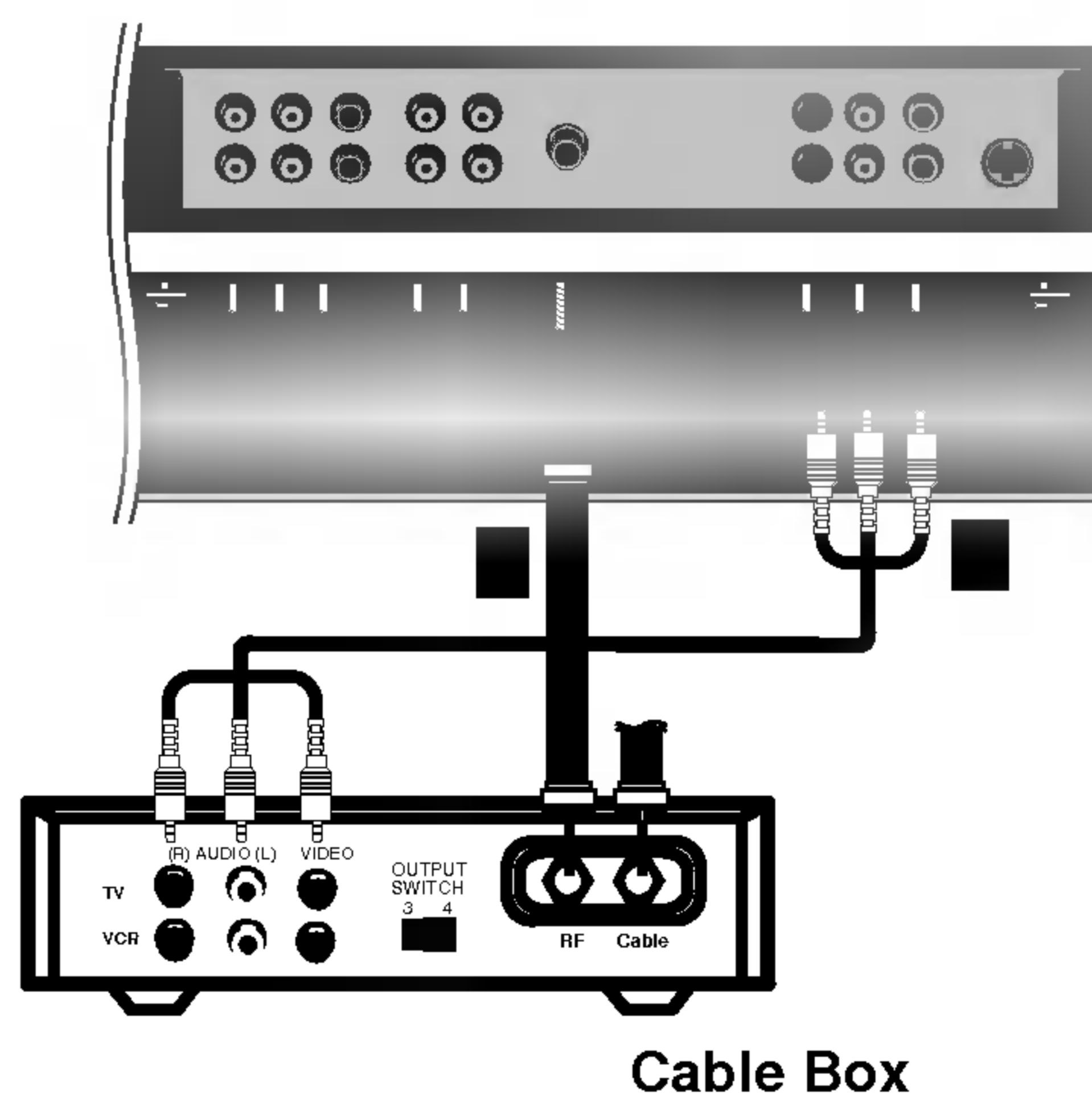

### External A/V Source Setup

#### How to connect

Connect the audio and video cables from the external equipment's output jacks to the TV input jacks, as shown in the figure.

When connecting the TV to external equipment, match the jack colors (Video = yellow, Audio Left = white, and Audio Right = red).

#### How to use

1. Select the input source with using the **TV/VIDEO** button on the remote control. (If connected to A/V INPUT 2, select **Video 2** input source).
2. Operate the corresponding external equipment. Refer to external equipment operating guide.

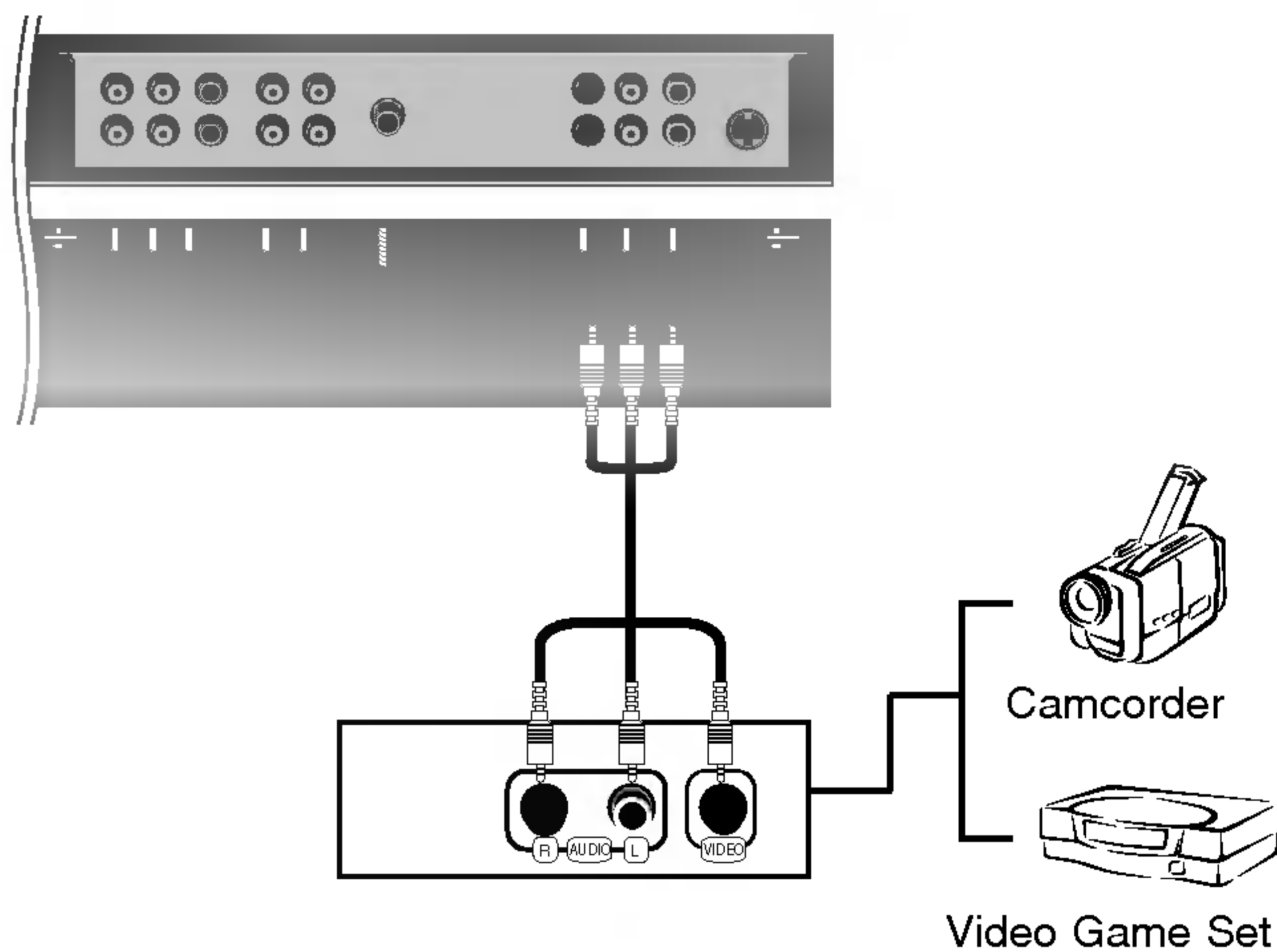

#### How to connect

1. Connect the DVD video outputs (Y, P<sub>B</sub>, P<sub>R</sub>) to the COMPONENT (Y, P<sub>B</sub>, P<sub>R</sub>) INPUT or HDMI INPUT jacks on the TV and connect the DVD audio outputs to the AUDIO INPUT jacks on the TV, as shown in the figure.
2. If your DVD only has an S-Video output jack, connect this to the S-VIDEO input on the TV and connect the DVD audio outputs to the AUDIO INPUT jacks on the TV, as shown in the figure.

**NOTE:** If your DVD player does not have component video output, use S-Video.

#### How to use

1. Turn on the DVD player, insert a DVD.
2. Use the **TV/VIDEO** or **MULTIMEDIA** button on the remote control to select **Component 1** or **Component 2**. (If connected to S-VIDEO, select the **Video 1** or **Video 2** external input source.)
3. Refer to the DVD player's manual for operating instructions.

#### • Component Input ports

To get better picture quality, connect a DVD player to the component input ports as shown below.

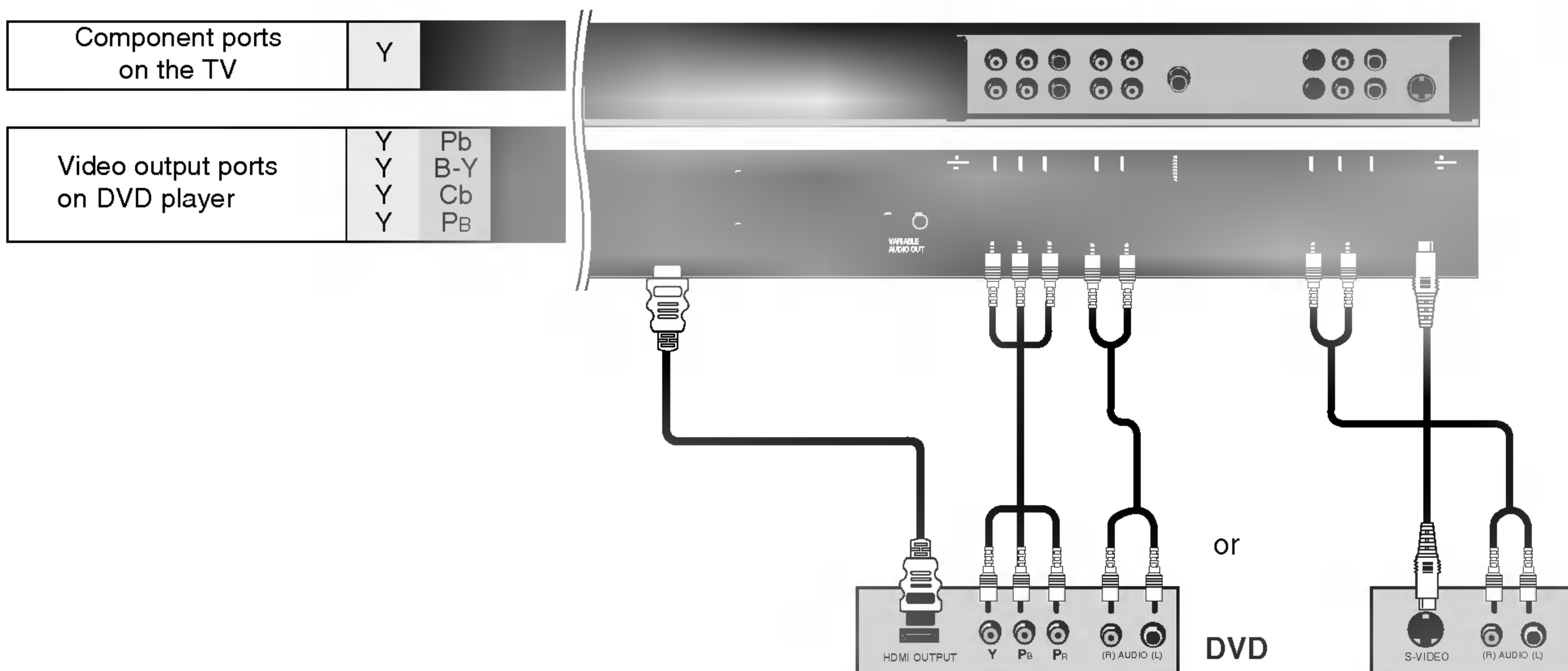

- To watch digitally broadcast programs, purchase and connect a digital set-top box.

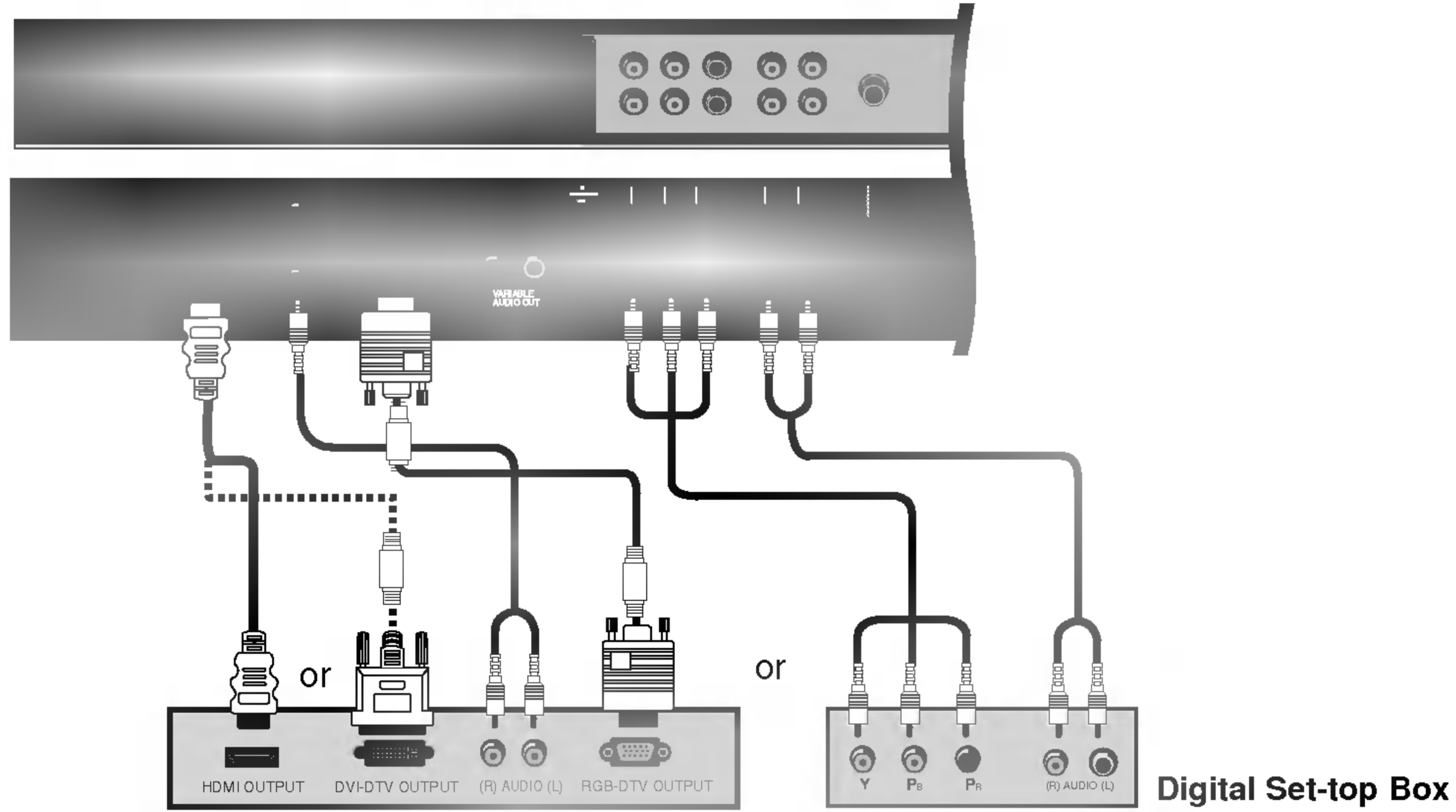

**How to connect**

Use the TV's COMPONENT (Y, Pb, Pr) INPUT, RGB or HDMI jack for video connections, depending on your set-top box connector. Then, make the corresponding audio connections.

**How to use**

1. Turn on the digital set-top box. (Refer to the owner's manual for the digital set-top box.)
2. Use **TV/VIDEO** or **MULTIMEDIA** on the remote control to select **Component 1**, **Component 2**, **RGB** or **HDMI** source.

Signal	Component 1/2	RGB, HDMI
480i	Yes	No
480p	Yes	Yes
720p	Yes	Yes
1080i	Yes	Yes

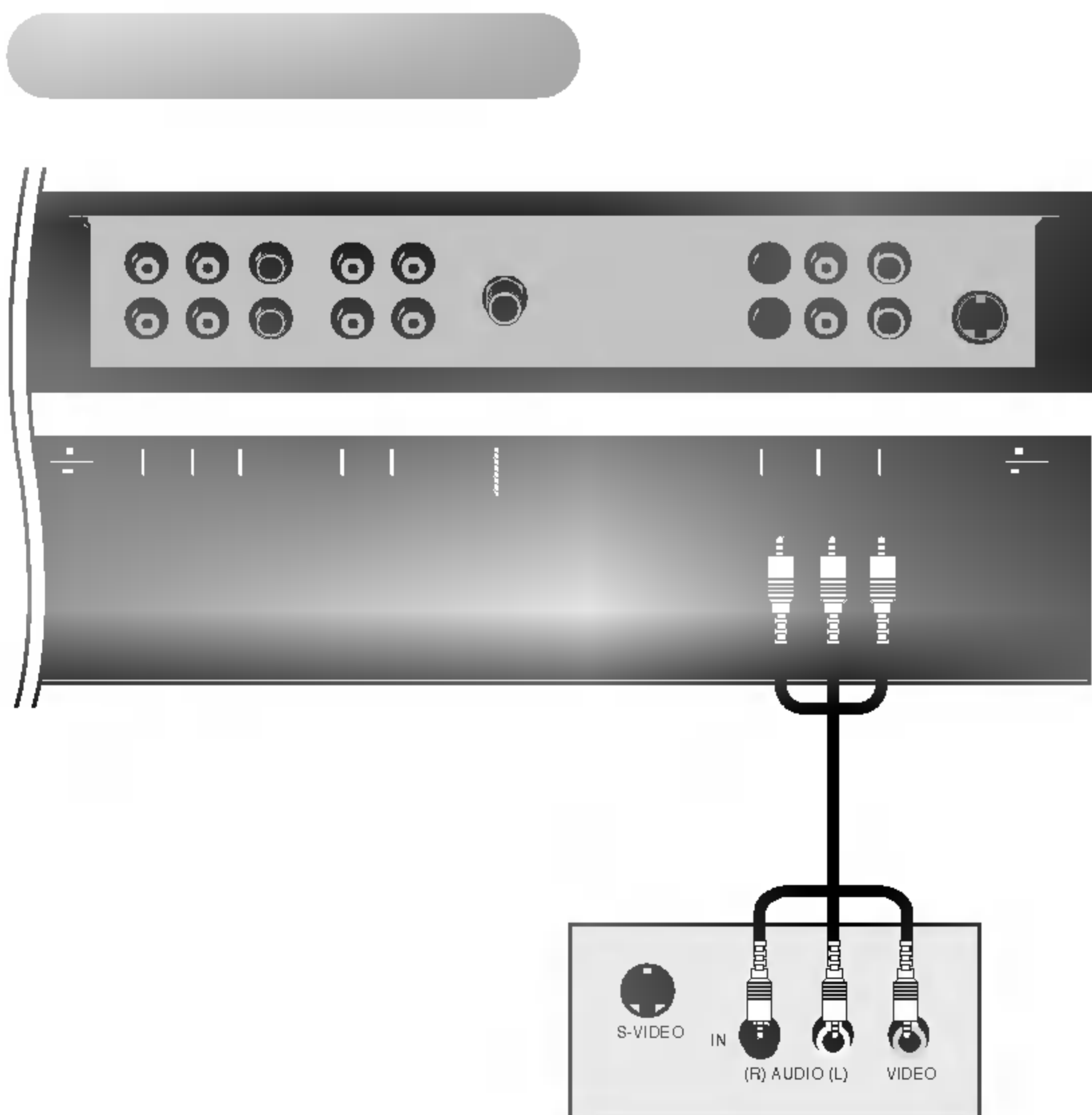

The TV has a special signal output capability which allows you to hook up a second TV or monitor.

Connect the second TV or monitor to the TV's MONITOR OUTPUT. See the Operating Manual of the second TV or monitor for further details regarding that device's input settings.

**NOTE**

- Component, RGB, HDMI input sources cannot be used for Monitor out.

### How to connect

1. To get the best picture quality, adjust the PC graphics card to 640x 480, 60Hz.
2. Use the TV's RGB INPUT or HDMI/DVI (VIDEO) INPUT port for video connections, depending on your PC connector.
  - If the graphic card on the PC does not output analog and digital RGB simultaneously, connect only one of either RGB INPUT or HDMI/DVI (VIDEO) to display the PC on the TV.
  - If the graphic card on the PC does output analog and digital RGB simultaneously, set the TV to either RGB or HDMI/DVI (VIDEO); (the other mode is set to Plug and Play automatically by the TV.)
3. Then, make the corresponding audio connection. If using a sound card, adjust the PC sound as required.

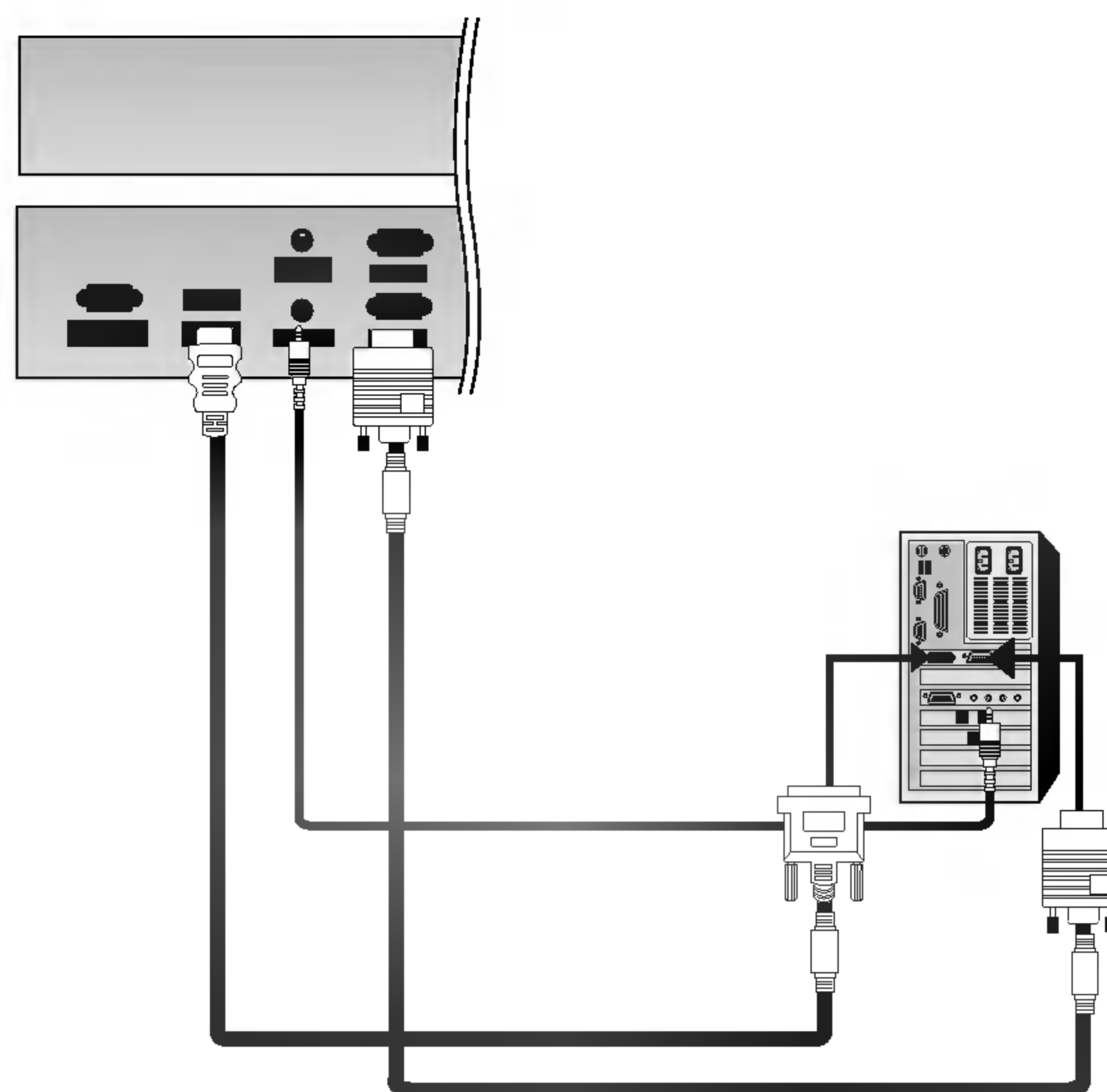

### How to use

1. Turn on the PC and the TV.
2. Turn on the display by pressing the POWER button on the TV's remote control.
3. Use **TV/VIDEO** or **MULTIMEDIA** on the remote control to select **RGB** or **HDMI** source.
4. Check the image on your TV. There may be noise associated with the resolution, vertical pattern, contrast or brightness in PC mode. If noise is present, change the PC mode to another resolution, change the refresh rate to another rate or adjust the brightness and contrast on the menu until the picture is clear. If the refresh rate of the PC graphic card can not be changed, change the PC graphic card or consult the manufacturer of the PC graphic card.

- NOTES:**
- Avoid keeping a fixed image on the TV's screen for a long period of time. The fixed image may become permanently imprinted on the screen. Use the Orbiter screen saver when possible.
  - The synchronization input form for Horizontal and Vertical frequencies is separate.
  - When you use too long RGB-PC cable, there might be a noise on the screen. We recommend using under 5m of the cable. It provides the best picture quality.

## Displayable Monitor Specifications

RGB / HDMI mode

Resolution	Horizontal Frequency(KHz)	Vertical Frequency(Hz)
640x350	31.468	70.09
	37.861	85.08
720x400	31.469	70.08
	37.927	85.03
640x480	31.469	59.94
	35.000	66.66
	37.861	72.80
	37.500	75.00
848x480	43.269	85.00
	31.500	60.00
	37.799	70.00
	39.375	75.00
852x480	31.500	60.00
	37.799	70.00
	39.375	75.00
800x600	31.500	60.00
	37.799	70.00
	39.375	75.00
	35.156	56.25 (RGB)
832x624	37.879	60.31
	48.077	72.18
	46.875	75.00
	53.674	85.06
1024x768	49.725	74.55
	48.363	60.00
	56.476	70.06
	60.023	75.02
1360x768	68.677	85.00
	47.700	60.00
	59.625	75.02
1366x768	68.500	85.00
	47.700	60.00
	59.625	75.02
1152x864	69.500	85.00
	54.348	60.05
	63.995	70.01
1152x870	67.500	75.00
	77.487	85.00
	68.681	75.06
1280x768	47.693	60.00
	60.091	75.00
	68.504	85.00
1280x960	60.023	60.02
1280x1024	63.981	60.02

# Operation

## Turning the TV On

\* In this manual, the OSD (On Screen Display) may be different from your TV's because it is just an example to help you with the TV operation.

- When using the remote control, aim it at its sensor on the set.



1. Connect power cord correctly, the set is switched to standby mode.
2. Press the  $\odot$  / I, TV/VIDEO or CH  $\blacktriangle$  /  $\blacktriangledown$  button on the set or press the **POWER**, **MULTIMEDIA**, **TV/VIDEO**, **CH  $\blacktriangle$  /  $\blacktriangledown$**  or **NUMBER** buttons on the remote control and then the set will switch on.



If the set was turned off with the remote control power button and the  $\odot$  / I button on the set.

- Press the  $\odot$  / I, TV/VIDEO or CH  $\blacktriangle$  /  $\blacktriangledown$  button on the set or press the **POWER**, **MULTIMEDIA**, **TV/VIDEO**, **CH  $\blacktriangle$  /  $\blacktriangledown$**  or **NUMBER** button on the remote control to turn the set on.

### NOTE

- If you intend to be away on vacation, disconnect the power plug from the wall power outlet.

## Menu Language Selection

- The menus can be shown on the screen in the selected language. First select your language.

1. Press the **MENU** button and then use  $\blacktriangle$  /  $\blacktriangledown$  button to select the **SPECIAL** menu.
2. Press the  $\blacktriangleright$  button and then use  $\blacktriangle$  /  $\blacktriangledown$  button to select **Language**.
3. Press the  $\blacktriangleright$  button and then use  $\blacktriangle$  /  $\blacktriangledown$  button to select your desired language.  
From this point on, the on-screen menus will be shown in the language of your choice.
4. Press the **ENTER** button to save.

# Channel Menu Options

Auto Program should be used to memorize all the active channels in your area before you are able to use the TV.

There are two ways of storing channels in the TV's memory. You can use either.

One is called AUTO PROGRAM and the other is called MANUAL PROGRAM.

In AUTO PROGRAM mode, the TV will memorize the channels in ascending numerical order. If there are additional channels you want to add or delete, you can manually add or delete those channels with Manual Program.

## Auto Program: Channel Search

- Redo Auto Program if the Plasma Display is ever moved to another location.
- Auto Program will search for channels only through the Antenna jack.
- If channels numbers for broadcast over-the air TV and cable TV are duplicated where different channels have the same number, press the same number buttons again to toggle between:



(For example, press 17 to go to the channel, press 17 again to go to the duplicated channel.)

1. Press the **A.PROG** button and then press the **▶** button. AUTO PROGRAM starts the channel search. If you want to stop auto programming, press the **ENTER** button. Only the channels found up to at that time are memorized.
  - You can also select the **Auto program** option and do a channel search in the **CHANNEL** menu.

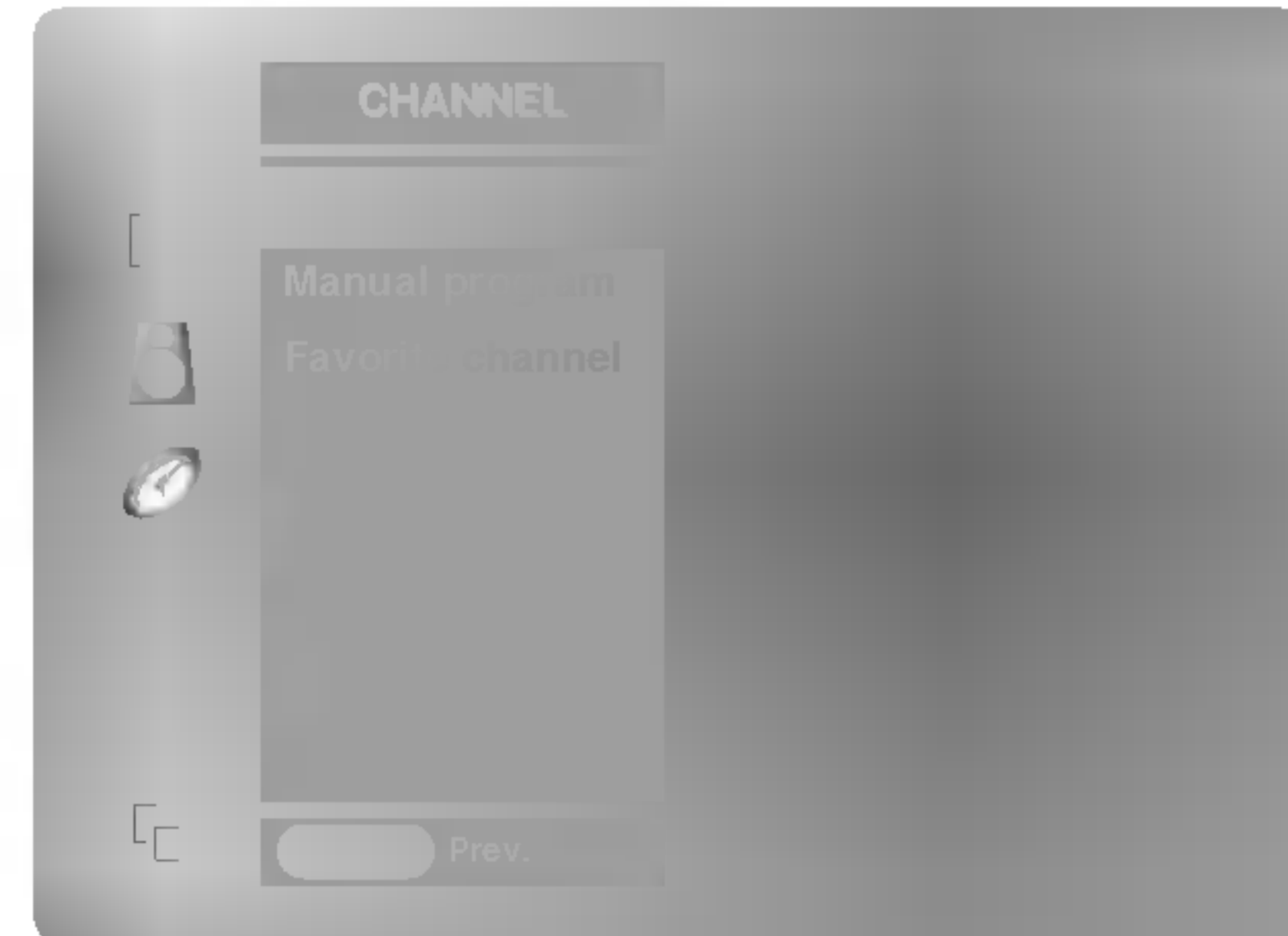

## Manual Program: Adding/Deleting Channels

- You can add or delete channels from the channel scan manually.

1. Use the **▲ / ▼** or **NUMBER** buttons to select the channel number you want to add or delete.
2. Press the **MEMORY/ERASE** button.
3. Use the **MEMORY/ERASE** button to select **Memory** or **Erase**.
4. Press the **ENTER** button.
  - You can also do **Manual program** with the **CHANNEL** menu.

- Use this function to correct the picture's instability and condition if it is poor.

1. Press the **MENU** button and then use **▲ / ▼** button to select the **CHANNEL** menu.
2. Press the **▶** button and then use **▲ / ▼** button to select **Manual program**.
3. Press the **▶** button and then use **▲ / ▼** button to select **Fine**.
4. Use the **◀ / ▶** button to adjust the picture to your preference.
5. Press the **ENTER** button to save.

### Notes

- To remove fine tuning from a channel, reprogram the finely-tuned channel with Auto program or Manual Program.
- If a finely-tuned channel is memorized, the color of the channel number changes to yellow.

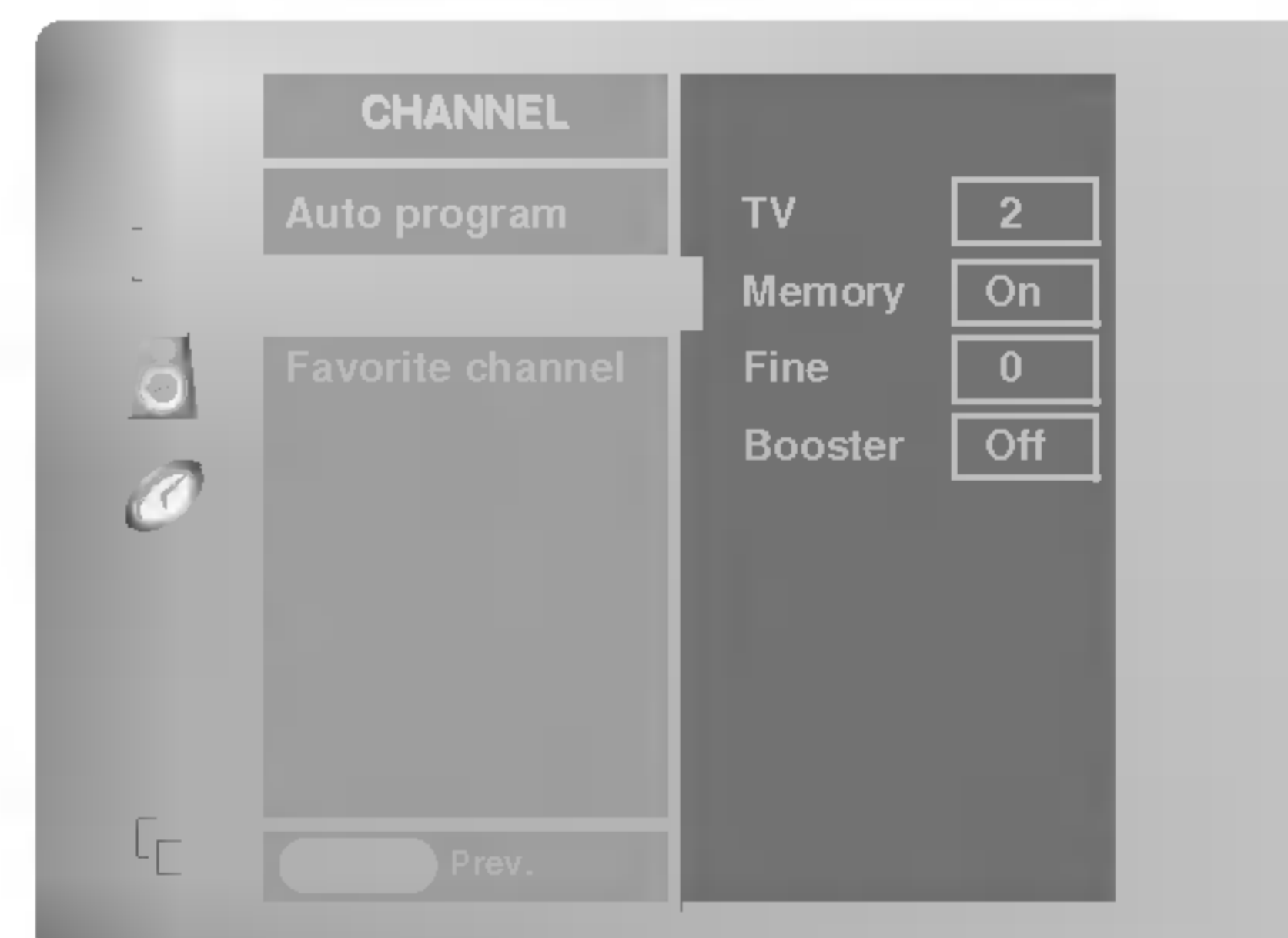

## Signal Reception Booster

- If TV signal reception is poor because you are in a fringe area, set Booster to On. If the picture condition is good, set Booster to Off.
- Adjustments for one channel don't affect the adjustment for other channels. Set booster to on or off for each channel separately.

1. Press the **MENU** button and then use **▲ / ▼** button to select the **CHANNEL** menu.
2. Press the **▶** button and then use **▲ / ▼** button to select **Manual program**.
3. Press the **▶** button and then use **▲ / ▼** button to select **Booster**.
4. Use **◀ / ▶** button to select **On** or **Off**.
5. Press the **ENTER** button to save.

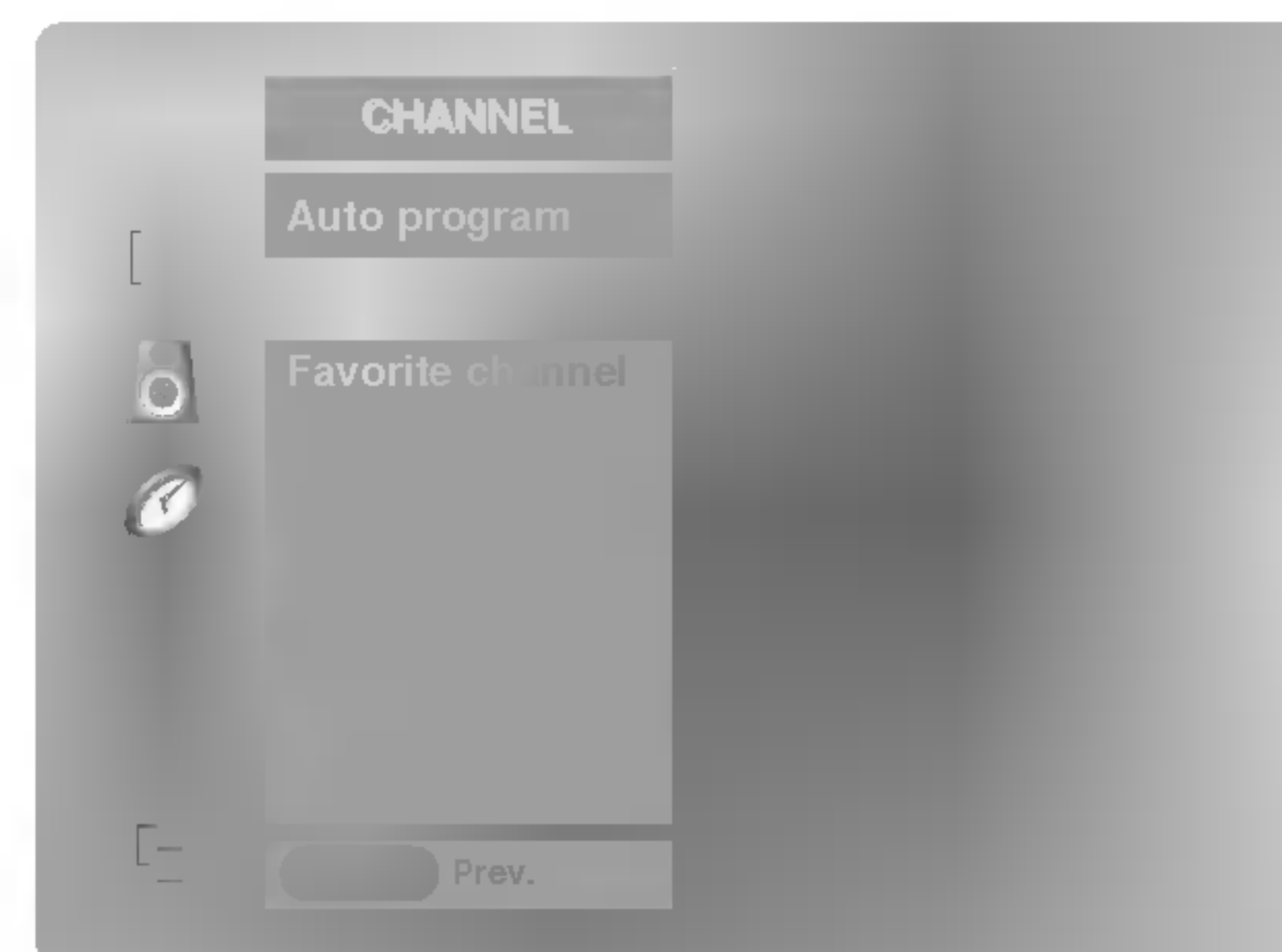

- Favorite Channels is a convenient feature that lets you quickly scan up to 8 channels of your choice without having to wait for the TV to scan through all the in-between channels.

1. Press the **MENU** button and then use **▲ / ▼** button to select the **CHANNEL** menu.
2. Press the **▶** button and then use **▲ / ▼** button to select **Favorite channel**.
3. Press the **▶** button and then use **▲ / ▼** button to select the first favorite channel position.
4. Use the **◀ / ▶** button to set the desired channel number for first favorite channel.
5. Press the **ENTER** button to save.
6. Repeat steps 3 to 5 to memorize other favorite channels.

- To tune to a favorite channel, press the **FCR** (Favorite Channel Review) button repeatedly. The eight favorite channels appear on the screen in numerical order.



# Picture Menu Options

- APC adjusts the TV to the best picture appearance.
- If adjusting picture options (contrast, brightness, color, sharpness or tint) manually, APC automatically changes to **User**.

1. Press the **APC** button repeatedly to select the picture appearance setup option as shown below.

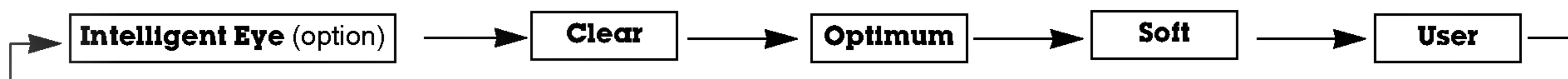

- You can also adjust **APC** in the **PICTURE** menu.
- **Intelligent Eye** (option), **Clear**, **Optimum** and **Soft** settings are preset for good picture quality at the factory and cannot be changed.

## Auto Color Temperature Control

- To initialize values (reset to default settings), select the **Normal** option.
1. Press the **MENU** button and then use **▲ / ▼** button to select the **PICTURE** menu.
  2. Press the **▶** button and then use **▲ / ▼** button to select **ACC**.
  3. Press the **▶** button and then use **▲ / ▼** button to select either: **Cool** (Preset), **Normal** (Default), or **Warm** (Preset).
  4. Press the **ENTER** button to save.

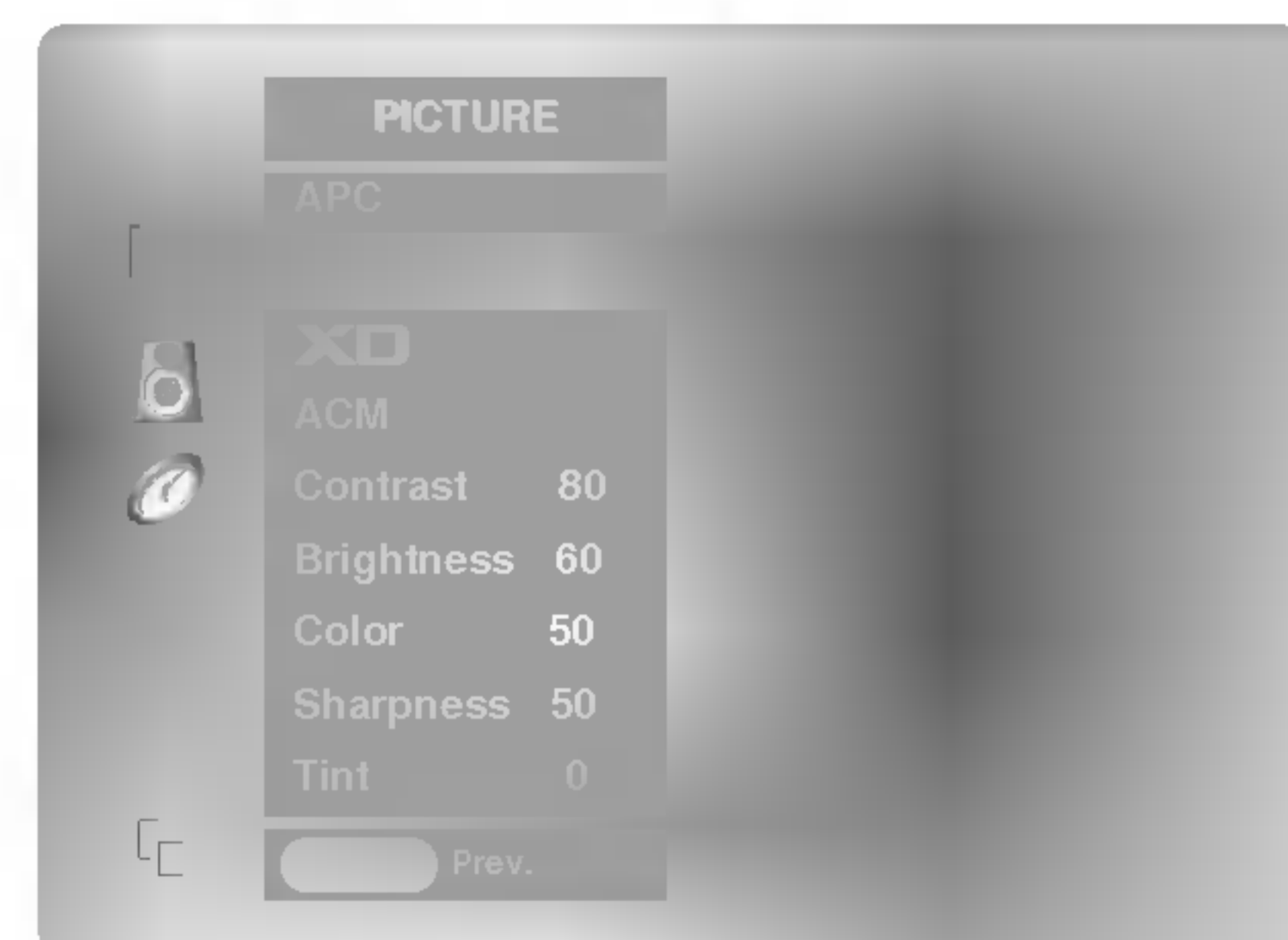

## Manual Color Temperature Control (ACC set to User option)

- You can adjust red, green, or blue to any color temperature you prefer.
1. Press the **MENU** button and then use **▲ / ▼** button to select the **PICTURE** menu.
  2. Press the **▶** button and then use **▲ / ▼** button to select **ACC**.
  3. Press the **▶** button and then use **▲ / ▼** button to select **User**.
  4. Press the **▶** button and then use **▲ / ▼** button to select **Red**, **Green** or **Blue**.
  5. Use the **◀ / ▶** button to make appropriate adjustments.
    - The adjustment range of **Red**, **Green** and **Blue** is -40 ~ +40.
  6. Press the **ENTER** button to save.

- XD is LG Electronic's unique picture improving technology to display a real HD source through an advanced digital signal processing algorithm.
- When selecting APC options (Intelligent Eye (option), Clear, Optimum and Soft), XD is automatically change to On.
- XD is not available for RGB (PC) and HDMI (PC) sources.

1. Press the **MENU** button and then use **▲ / ▼** button to select the **PICTURE** menu.
2. Press the **▶** button and then use **▲ / ▼** button to select **XD**.
3. Press the **▶** button and then use **▲ / ▼** button to set **On** or **Off**.
4. Press the **ENTER** button to save.



- Adjust the **ACM** to select the desired skin color option.
- This function works in the following mode:  
TV, VIDEO1,2, COMPONENT1, 2, RGB-DTV, HDMI-DTV.
- It's not available to use this function in **XD Off** mode.

1. Press the **MENU** button and then use **▲ / ▼** button to select the **PICTURE** menu.
2. Press the **▶** button and then use **▲ / ▼** button to select **ACM**.
3. Press the **▶** button and then use **◀ / ▶** button to make appropriate adjustments.
4. Press the **ENTER** button to save.

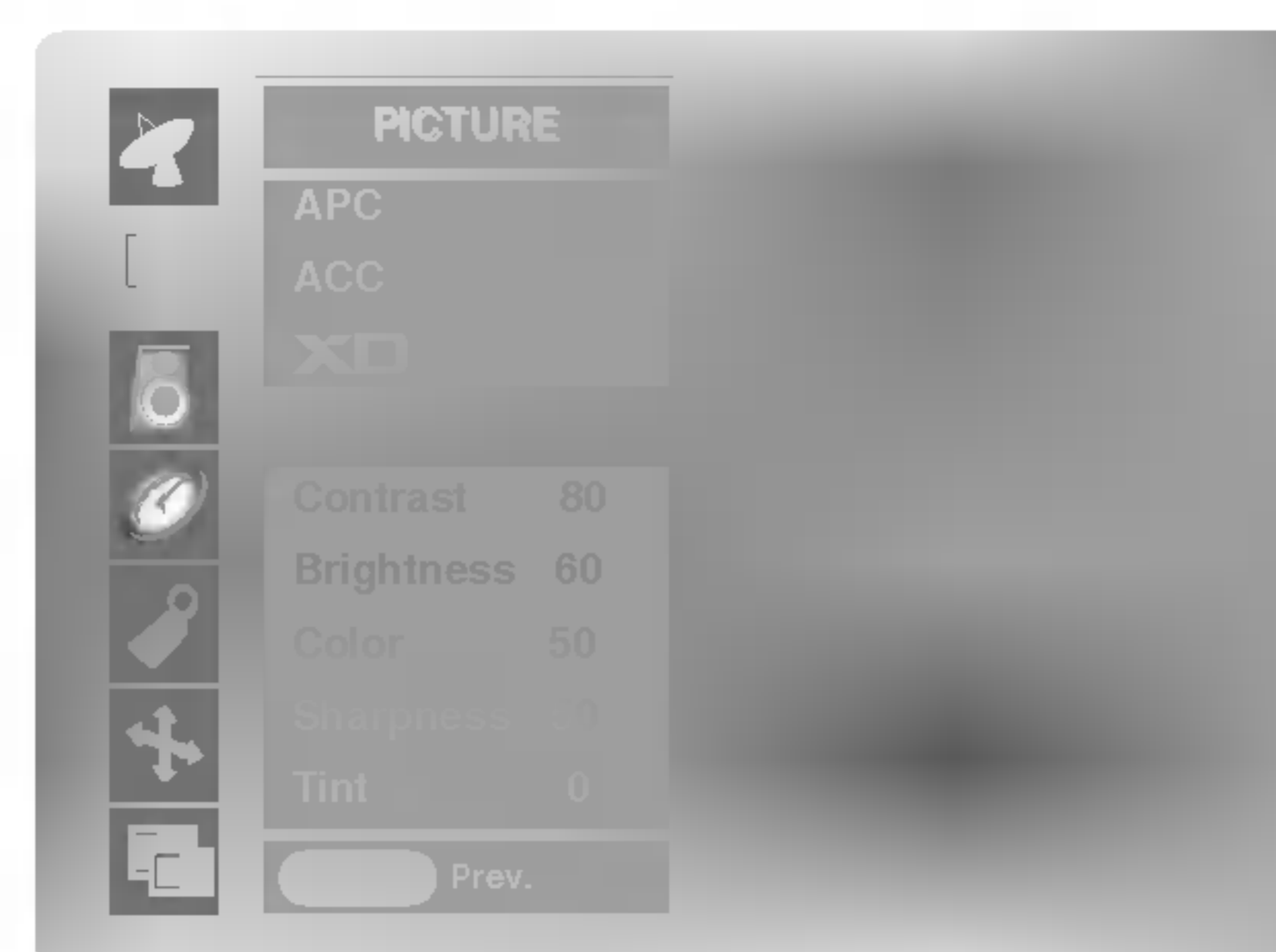

### sRGB (only RGB-PC, HDMI-PC Modes)

- If the TV is connected to external equipment using sRGB, set sRGB to On to adjust for the color difference.

1. Press the **MENU** button and then use **▲ / ▼** button to select the **PICTURE** menu.
2. Press the **▶** button and then use **▲ / ▼** button to select **sRGB**.
3. Press the **▶** button and then use **▲ / ▼** button to select **On** or **Off**.
4. Press the **ENTER** button to save.

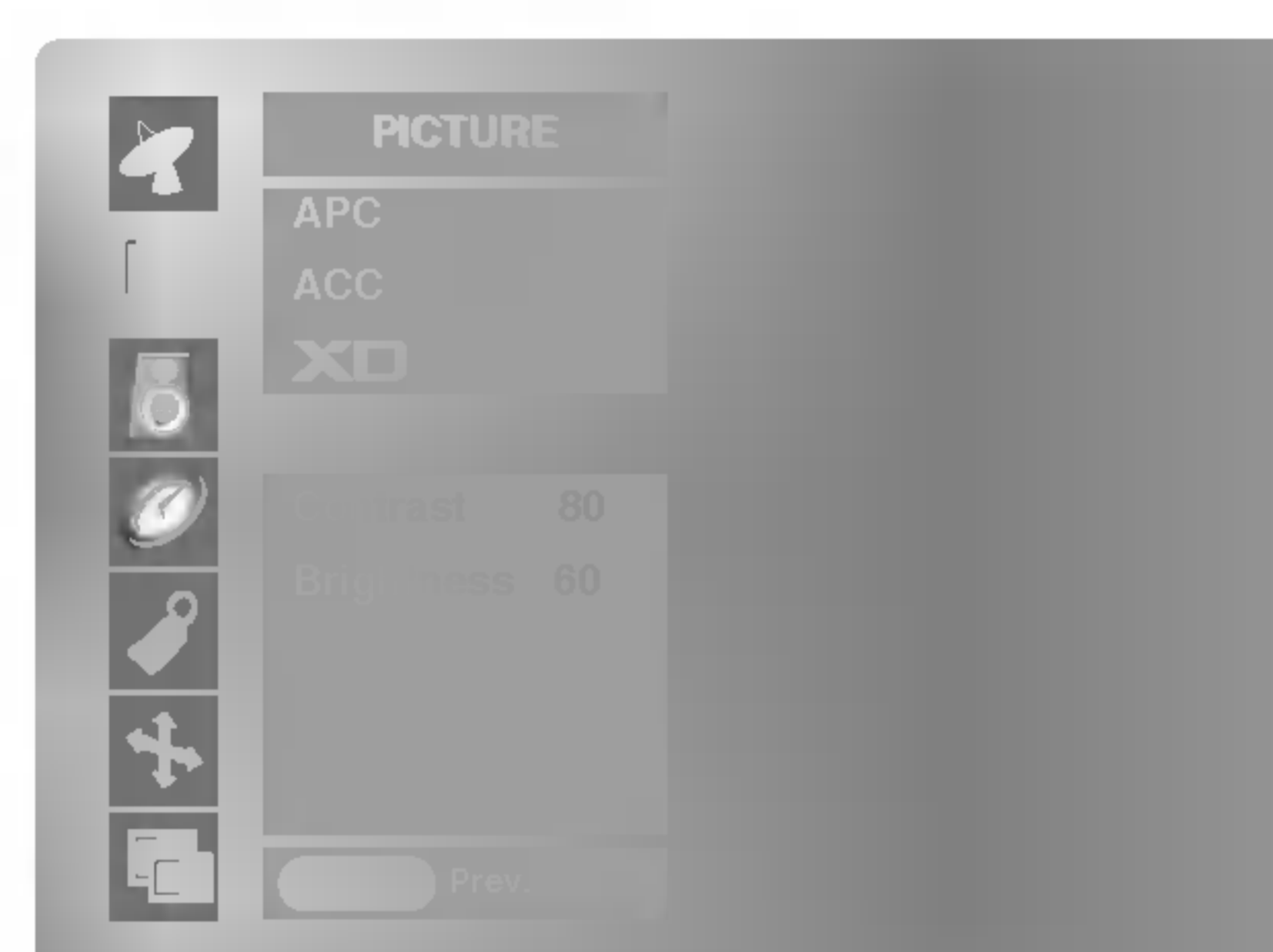

### Manual Picture Control (**APC** set to **User** option)

- You can adjust picture contrast, brightness, color, sharpness, and tint options to the levels you prefer.

1. Press the **MENU** button and then use **▲ / ▼** button to select the **PICTURE** menu.
2. Press the **▶** button and then use **▲ / ▼** button to select the desired picture option (**Contrast, Brightness, Color, Sharpness, Tint**).
3. Press the **▶** button and then use **◀ / ▶** button to make appropriate adjustments.
4. Press the **ENTER** button to save.

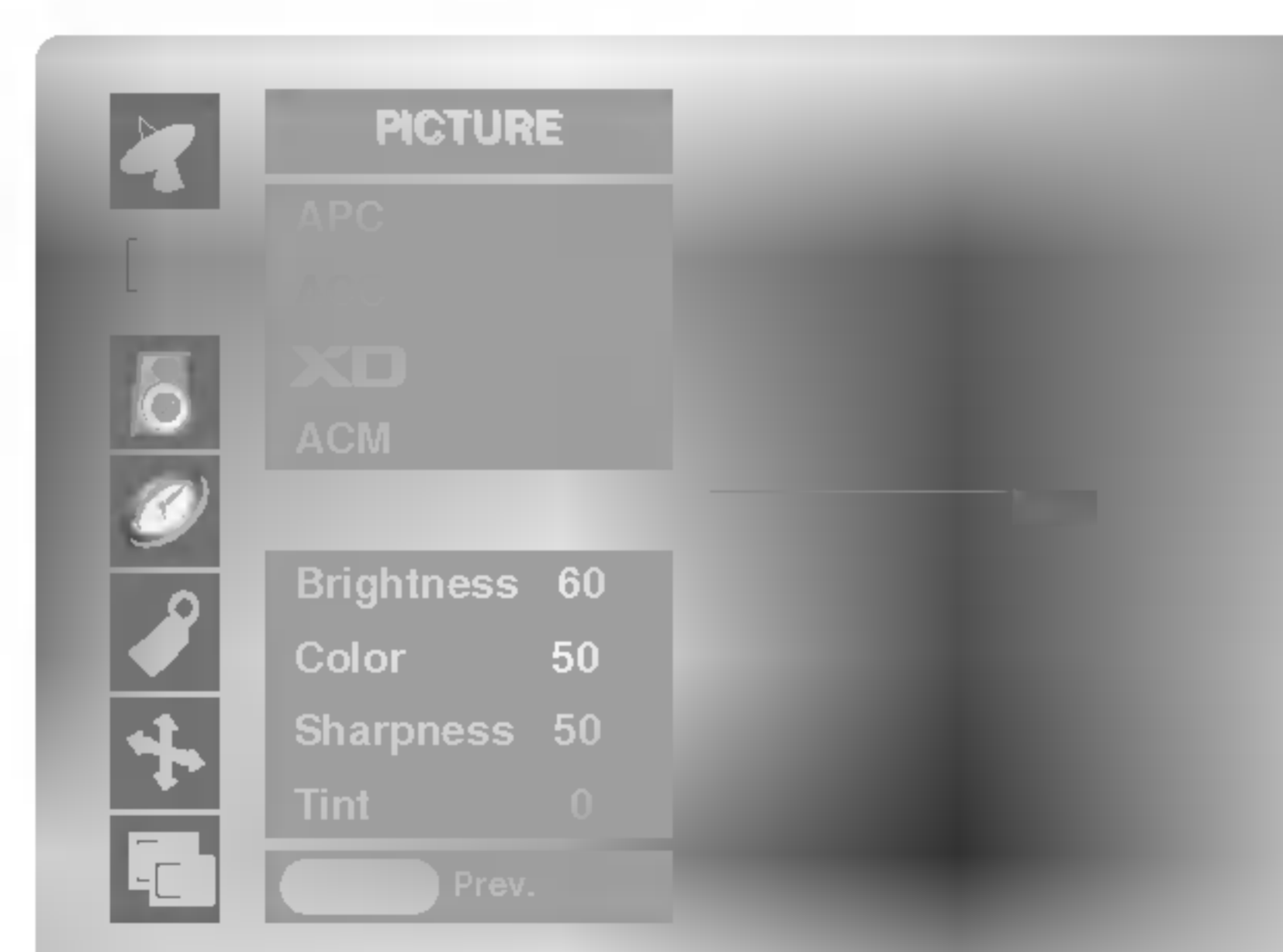

# Sound Menu Options

## DASP (Digital Auto Sound Processing)

- This function lets you enjoy the best sound without any special adjustment because the TV has the appropriate sound options based on the program content.
- If you adjust sound options (Treble and Bass) manually, DASP automatically changes to **User**.

1. Press the **DASP** button repeatedly to select the appropriate sound setup as shown below.

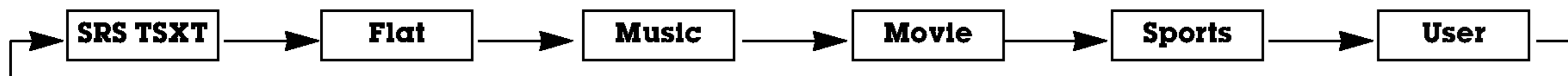

- You can also adjust **DASP** in the **SOUND** menu.
- **SRS TSXT**, **Flat**, **Music**, **Movie**, and **Sports** are preset for good sound quality at the factory and cannot be changed.
- **SRS TSXT** is a trademark of SRS Labs, Inc.
- TruSurround XT technology is incorporated under license from SRS Labs, Inc.

- BBE High Definition Sound restores clarity and presence for better speech intelligibility and music realism.

1. Press the **MENU** button and then use **▲ / ▼** button to select the **SOUND** menu.
2. Press the **▶** button and then use **▲ / ▼** button to select **BBE**.
3. Press the **▶** button and then use **▲ / ▼** button to select **On** or **Off**.
4. Press the **ENTER** button to save.

- **BBE**. Manufactured under license from BBE Sound, Inc.
- Treble, Bass or BBE aren't suitable for **SRS TSXT** mode.

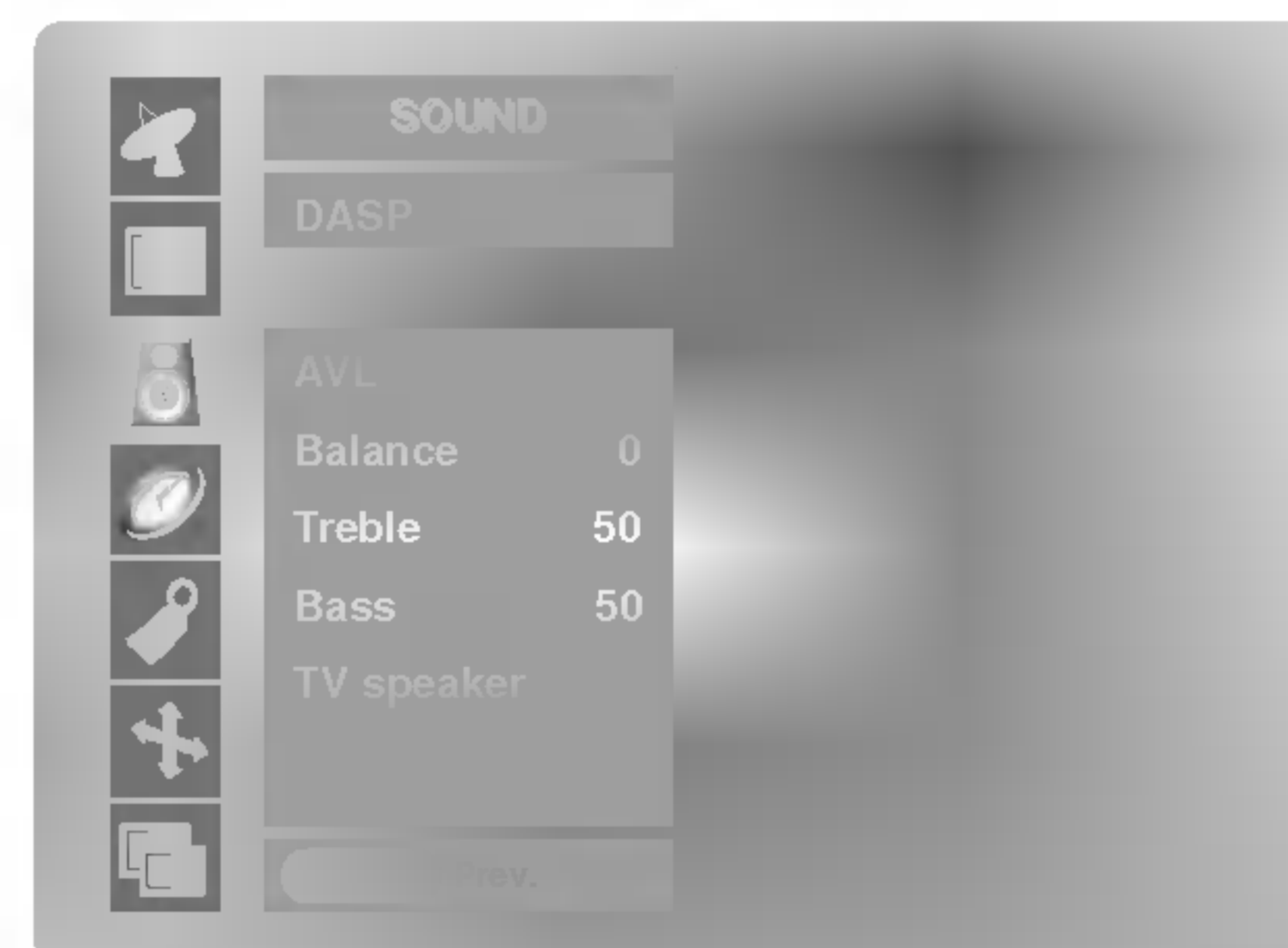

- AVL maintains an equal sound level; even if you change channels.

1. Press the **MENU** button and then use **▲ / ▼** button to select the **SOUND** menu.
2. Press the **▶** button and then use **▲ / ▼** button to select **AVL**.
3. Press the **▶** button and then use **▲ / ▼** button to select **On** or **Off**.
4. Press the **ENTER** button to save.

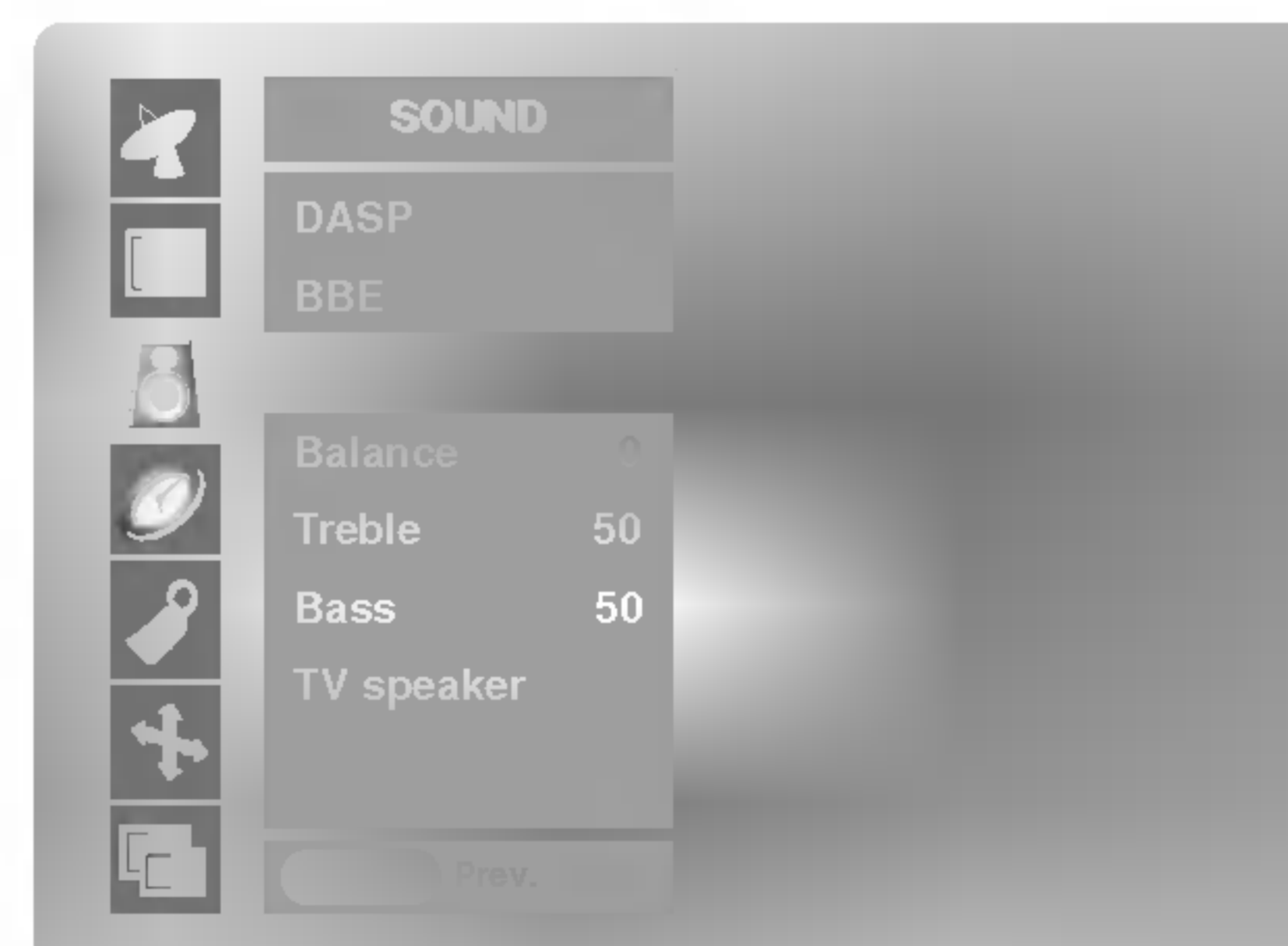

- You can adjust sound options Balance, Treble, and Bass to the levels you prefer.

1. Press the **MENU** button and then use **▲ / ▼** button to select the **SOUND** menu.
2. Press the **▶** button and then use **▲ / ▼** button to select the desired sound option (**Balance, Treble, Bass**).
3. Press the **▶** button and then use **◀ / ▶** button to make appropriate adjustments.
4. Press the **ENTER** button to save.

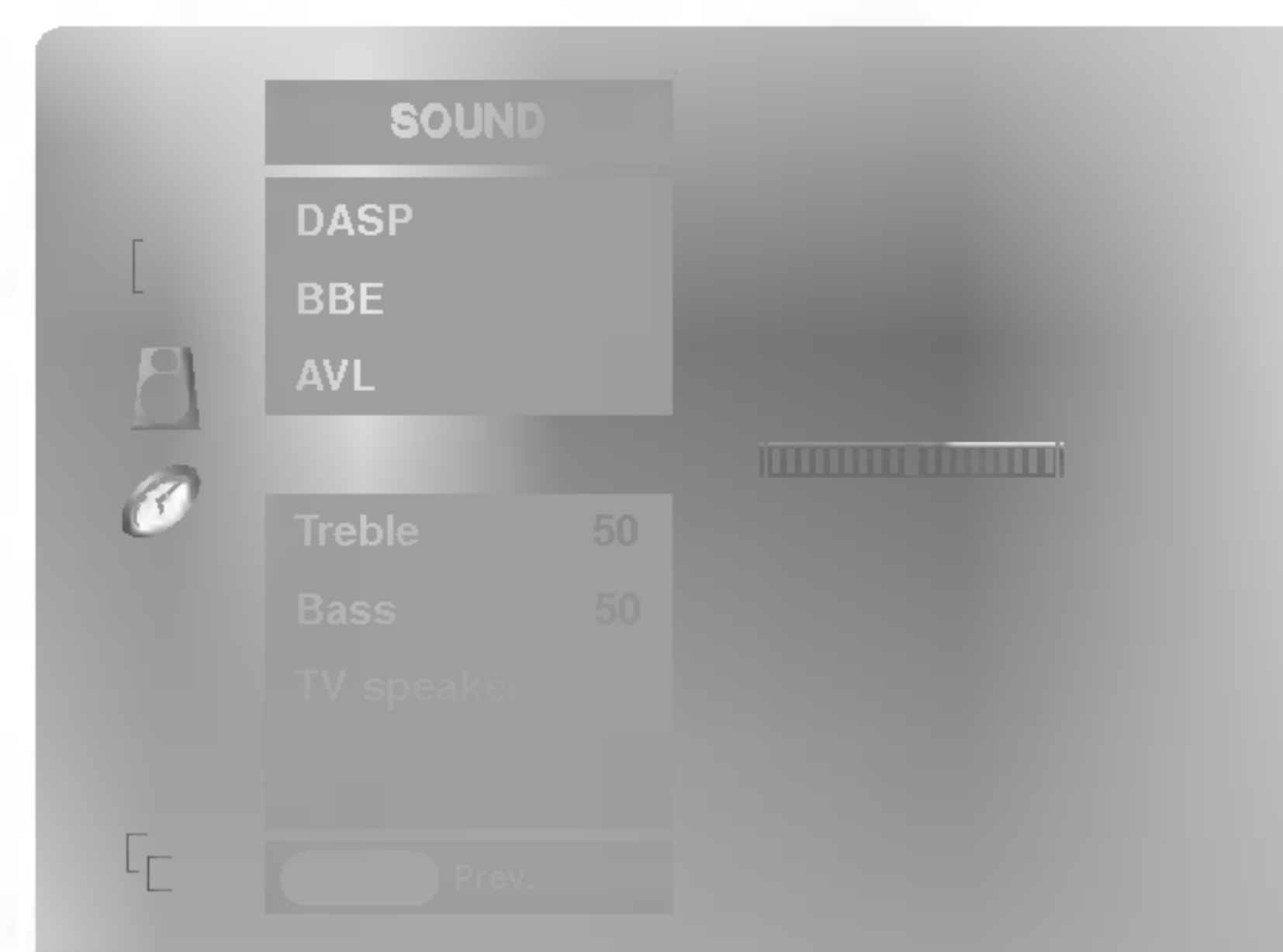

- You can adjust internal speaker status.  
 - If you want to use your external hi-fi stereo system, turn off the internal speakers of the set.

1. Press the **MENU** button and then use **▲ / ▼** button to select the **SOUND** menu.
2. Press the **▶** button and then use **▲ / ▼** button to select **TV speaker**.
3. Press the **▶** button and then use **▲ / ▼** button to select **On** or **Off**.
4. Press the **ENTER** button to save.

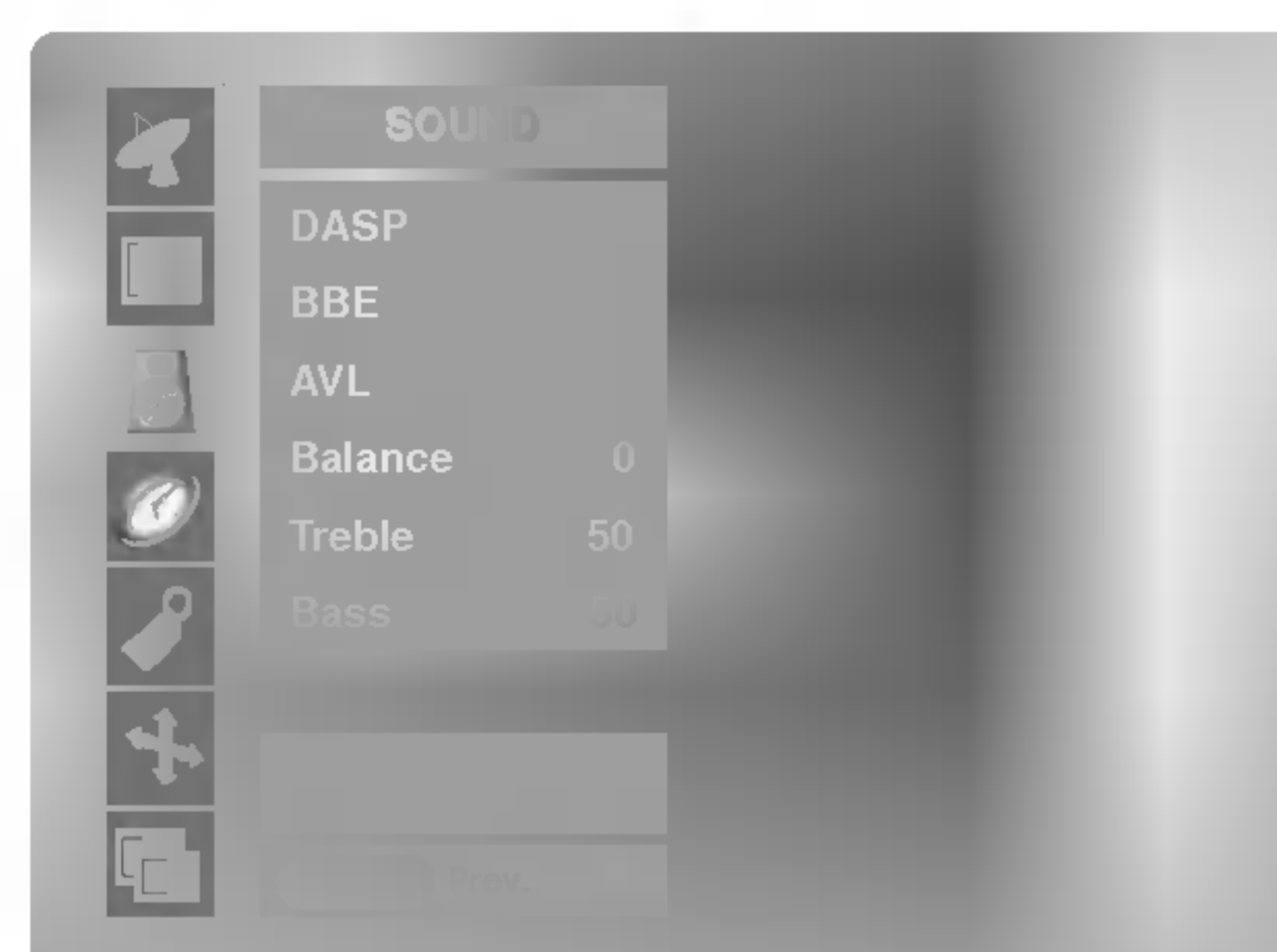

### Stereo/SAP Broadcasts Setup

- The TV can receive MTS stereo programs and any SAP (Secondary Audio Program) that accompanies the stereo program; if the broadcaster transmits one additional sound signal in addition to the original one.
- Mono: The primary language is heard from left and right speakers. Signal mode is mono.
- Stereo: The primary language is heard from left and right speakers. Signal mode is stereo.
- SAP: The secondary language is heard from left and right speakers in mono sound.

1. Press the **MTS** button repeatedly.



- Select mono sound mode if the signal is not clear or in poor signal reception areas.
- **Stereo, SAP** modes are available only if included on the broadcast signal.

# Timer Menu Options

- If current time setting is wrong, reset the clock manually.

1. Press the **MENU** button and then use ▲ / ▼ button to select the **TIMER** menu.
2. Press the ► button and then use ▲ / ▼ button to select **Clock**.
3. Press the ► button and then use ▲ / ▼ button to set the hour.
4. Press the ► button and then use ▲ / ▼ button to set the minutes.
5. Press the **ENTER** button to save.



- Timer function operates only if current time has been set.
- Off-Timer function overrides On-Timer function if they are set both set to the same time.
- The TV must be in standby mode for the On-Timer to work.
- If you do not press any button within 2 hours after the TV turns on with the On Timer function, the TV will automatically revert to standby mode.

1. Press the **MENU** button and then use ▲ / ▼ button to select the **TIMER** menu.
2. Press the ► button and then use ▲ / ▼ button to select **Off timer** or **On timer**.
3. Press the ► button and then use ▲ / ▼ button to select **On**.
  - To cancel **On/Off timer** function, select **Off**.
4. Press the ► button and then use ▲ / ▼ button to set the hour.
5. Press the ► button and then use ▲ / ▼ button to set the minutes.
6. **For only On timer function**
  - Press the ► button and then use ▲ / ▼ button to set the volume level at turn-on.
  - Press the ► button and then use ▲ / ▼ button to select the channel at turn-on.
7. Press the **ENTER** button to save.

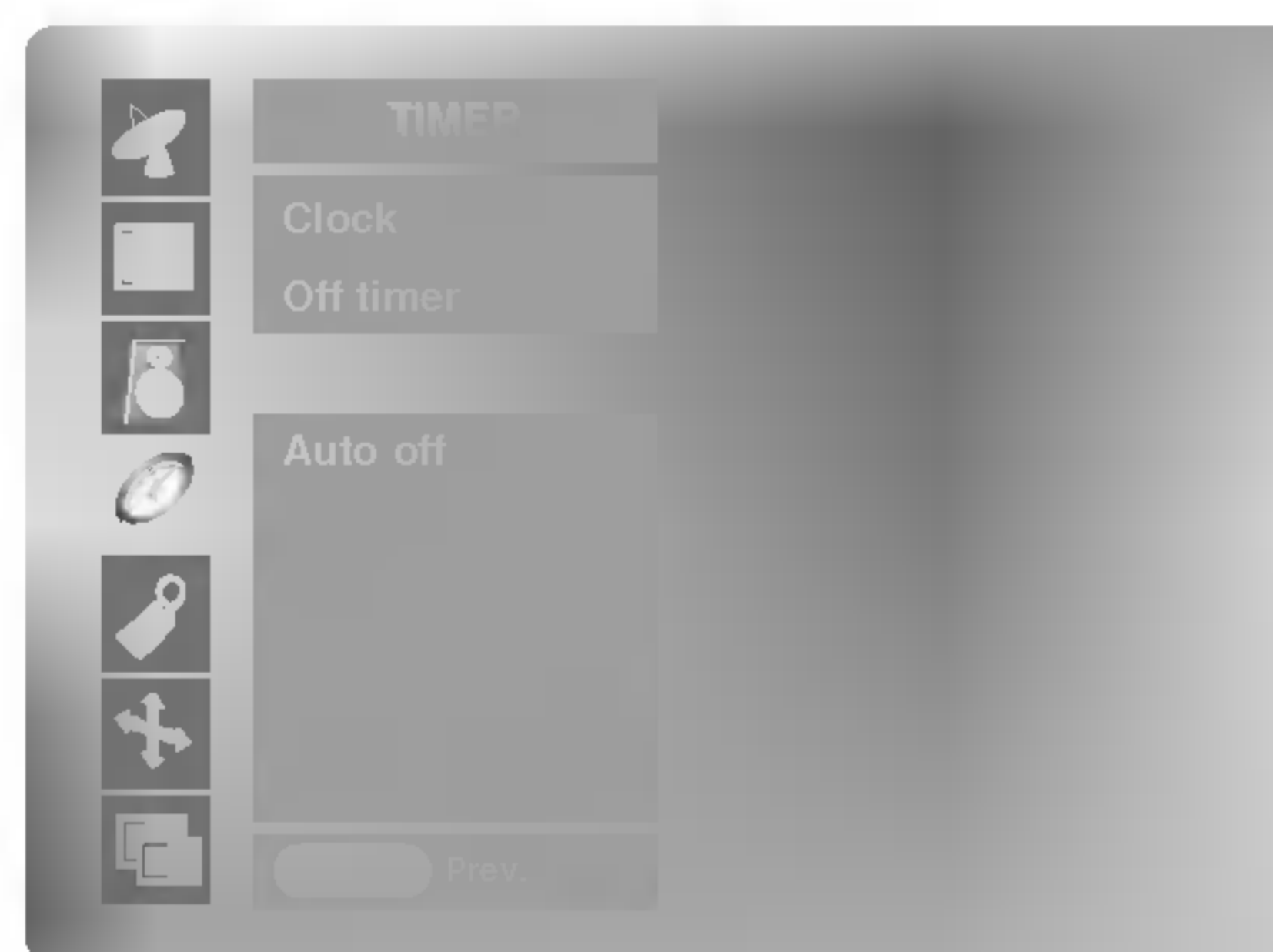

- If set to on and there is no input signal, the TV turns off automatically after 10 minutes.

1. Press the **MENU** button and then use ▲ / ▼ button to select the **TIMER** menu.
2. Press the ► button and then use ▲ / ▼ button to select **Auto off**.
3. Press the ► button and then use ▲ / ▼ button to select **On** or **Off**.
4. Press the **ENTER** button to save.



- The Sleep Timer turns the TV off at the preset time. Note that this setting is cleared when the TV is turned off.

1. Press the **SLEEP** button repeatedly to select the number of minutes. First the **L<sup>zz</sup> --- Min** option appears on the screen, followed by the following sleep timer options:  
10, 20, 30, 60, 90, 120, 180, and 240 minutes.
2. When the number of minutes you want is displayed on the screen, press the **ENTER** button. The timer begins to count down from the number of minutes selected.
3. To check the remaining minutes before the monitor turns off, press the **SLEEP** button once.
4. To cancel the Sleep Timer, press the **SLEEP** button repeatedly until **L<sup>zz</sup> --- Min** appears.

# Special Menu Options

- The TV can be set up so that it can only be used with the remote control.
- This feature can be used to prevent unauthorized viewing by locking out the front panel controls.
- This TV is programmed to remember which option it was last set to even if you turn the TV off.

1. Press the **MENU** button and then use ▲ / ▼ button to select the **SPECIAL** menu.
2. Press the ► button and then use ▲ / ▼ button to select **Key lock**.
3. Press the ► button and then use ▲ / ▼ button to select **On** or **Off**.
4. Press the **ENTER** button to save.
  - With the Key lock On, the display '▲ Key lock' appears on the screen if any button on the front panel is pressed.

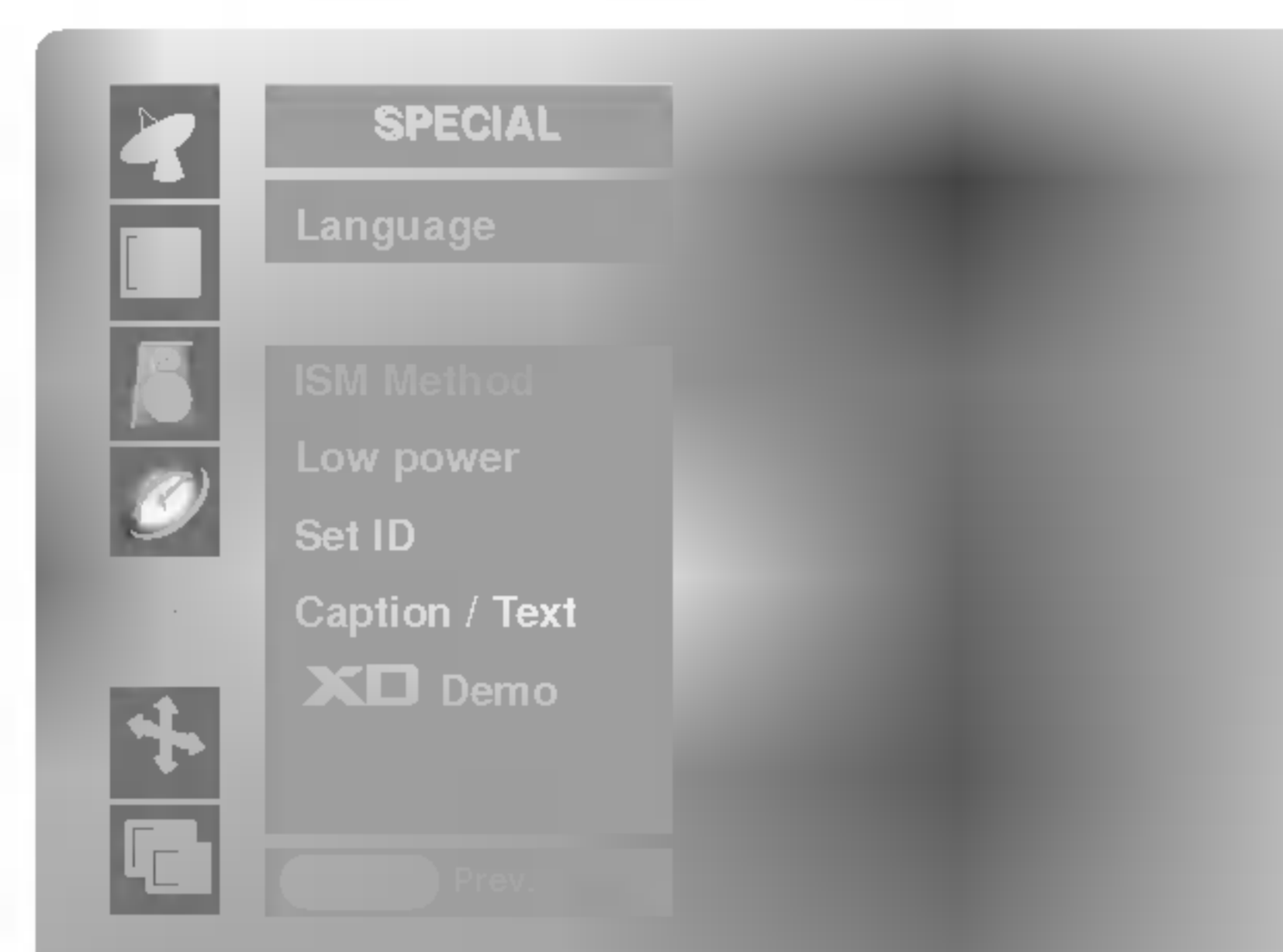

## ISM (Image Sticking Minimization) Method

- A frozen still picture from a PC/video game displayed on the screen for prolonged periods will result in a ghost image remaining even when you change the image. Avoid allowing a fixed image to remain on the TV's screen for a long period of time.

1. Press the **MENU** button and then use ▲ / ▼ button to select the **SPECIAL** menu.
2. Press the ► button and then use ▲ / ▼ button to select **ISM Method**.
3. Press the ► button and then use ▲ / ▼ button to select either **Normal**, **White wash**, **Orbiter** or **Inversion**.
  - **Normal**  
If image sticking is never a problem, ISM is not necessary - set to Normal.
  - **White wash**  
White Wash removes permanent images from the screen. Note: An excessive permanent image may be impossible to clear entirely with White Wash. To return to normal viewing, press any button.
  - **Orbiter**  
Orbiter may help prevent ghost images. However, it is best not to allow any fixed image to remain on the screen. To avoid a permanent image on the screen, the image will move every 2 minutes: Right → Right → Downside → Downside → Left → Left → Upside → Upside.
  - **Inversion**  
Inversion will automatically invert the TV panel color every 30 minutes.
4. Press the **ENTER** button to save.

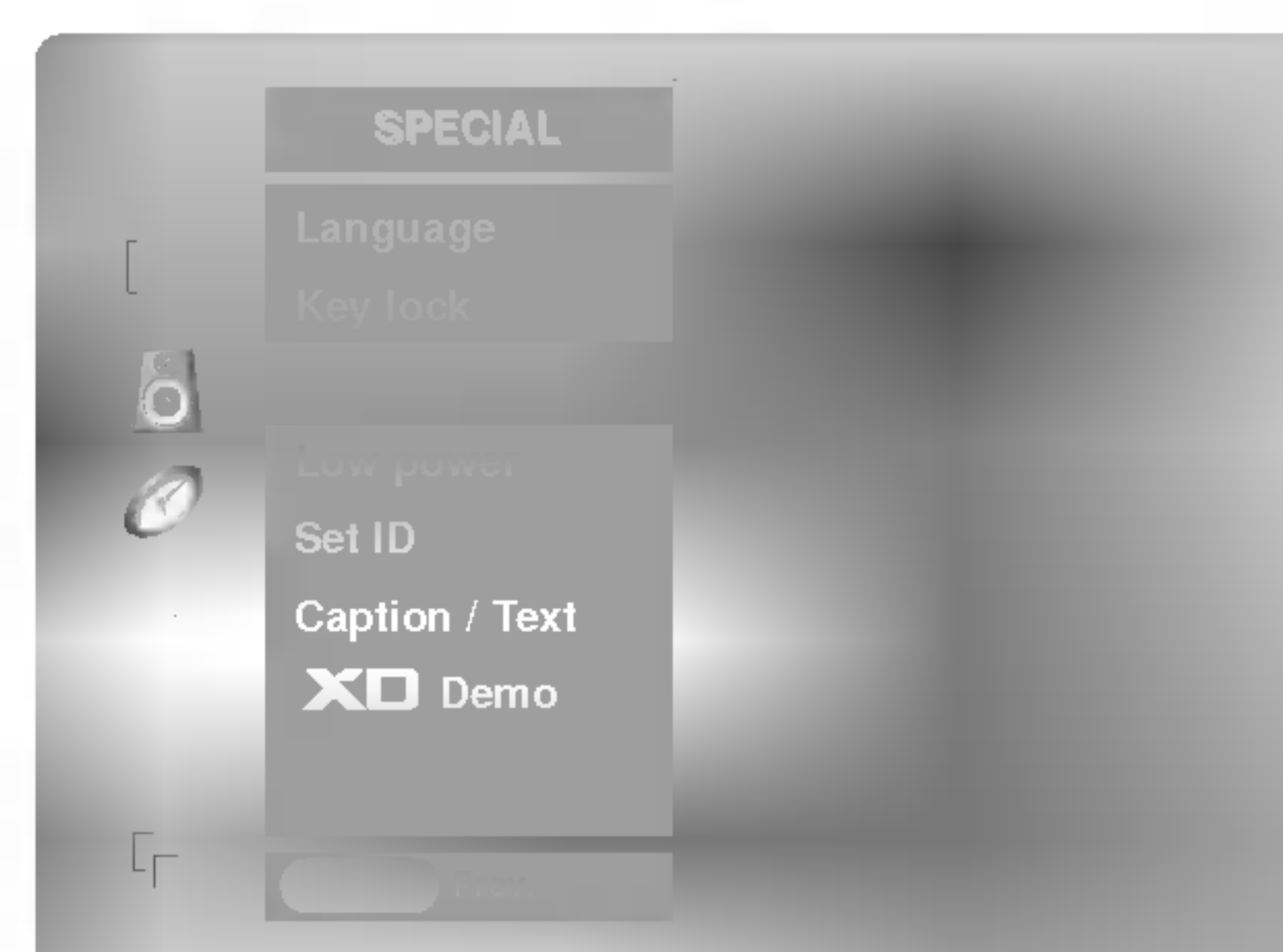

## Special Menu Options continued



- Low power reduces the plasma display power consumption.

1. Press the **MENU** button and then use ▲ / ▼ button to select the **SPECIAL** menu.
2. Press the ► button and then use ▲ / ▼ button to select **Low power**.
3. Press the ► button and then use ▲ / ▼ button to select **On** or **Off**.
  - When you select **On**, the screen darkens.
4. Press the **ENTER** button to save.

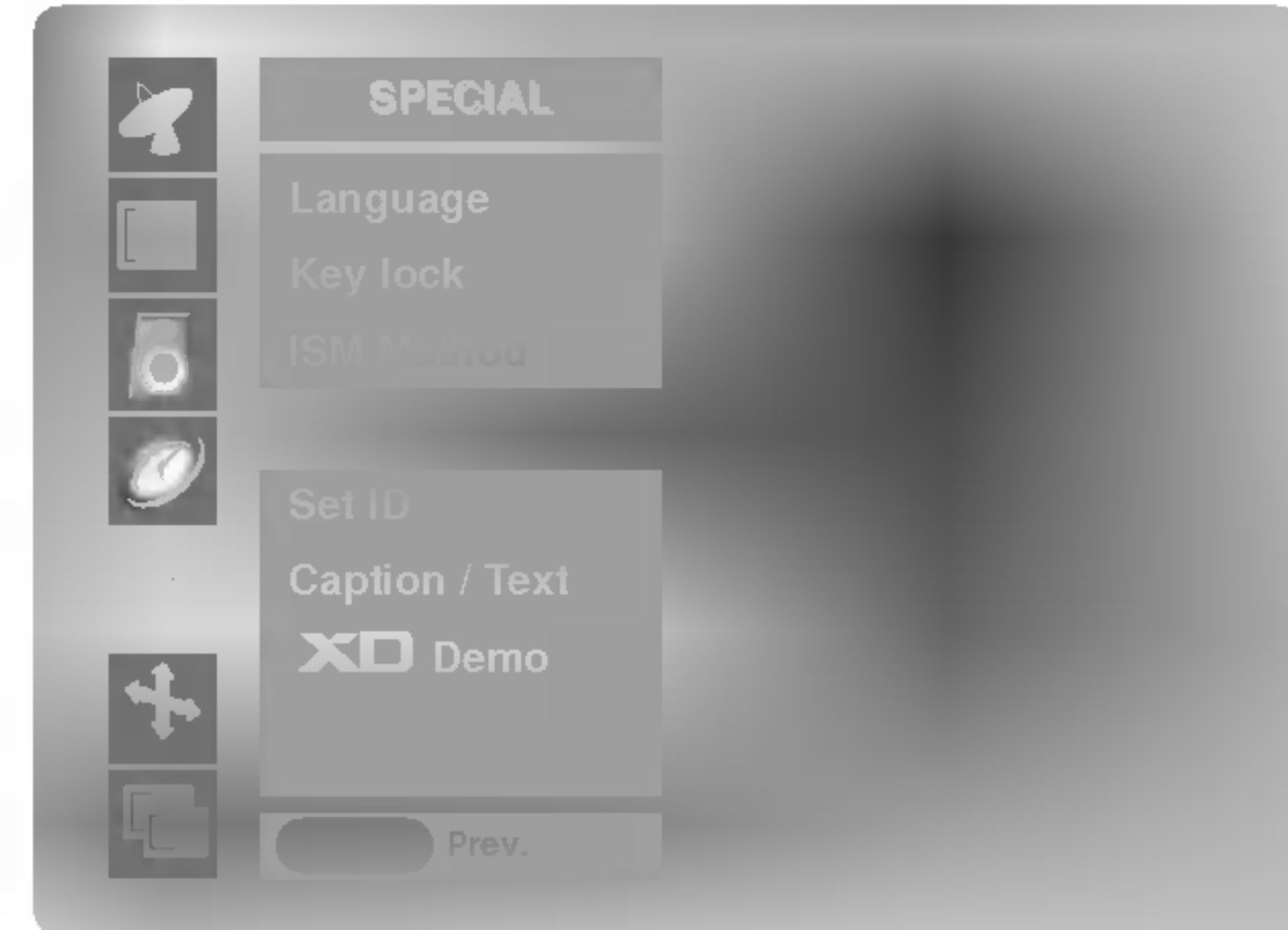

- Use it to see the difference between XD Demo on and XD Demo off.  
- It's not available to use this function in RGB[PC], HDMI[PC] mode.

1. Press the **MENU** button and then use ▲ / ▼ button to select the **SPECIAL** menu.
2. Press the ► button and then use ▲ / ▼ button to select **XD Demo**.
3. Press the ► button to begin **XD Demo**.
4. Press the **EXIT** button to stop **XD Demo**.

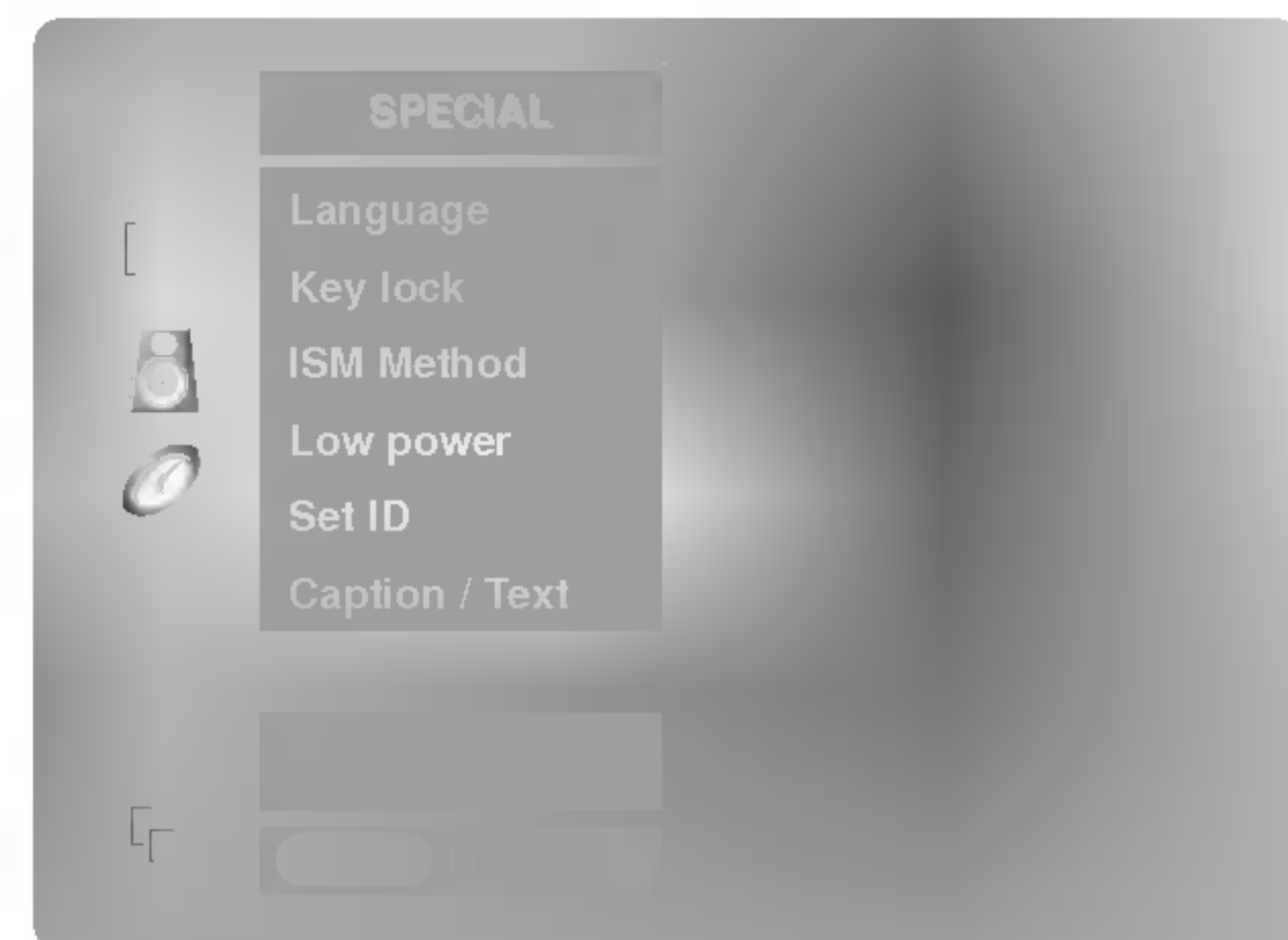

## Closed Captions

Closed captioning is a process which converts the audio portion of a television program into written words which then appear as subtitles on the television screen. Closed captions allow viewers to read the dialogue and narration of television programs.

### Using Closed Captions

Captions are the subtitles of the dialogue and narration of television programs. For prerecorded programs, program dialogue can be arranged into captions in advance. It's possible to caption a live program by using a process called real-time captioning, which creates captions instantly. Real-time captioning is normally done by professional reporters using a machine shorthand system and computer for translation into English.

Captioning is an effective system for the hearing-impaired, and it can also aid in teaching language skills.

• The picture at left shows a typical caption.

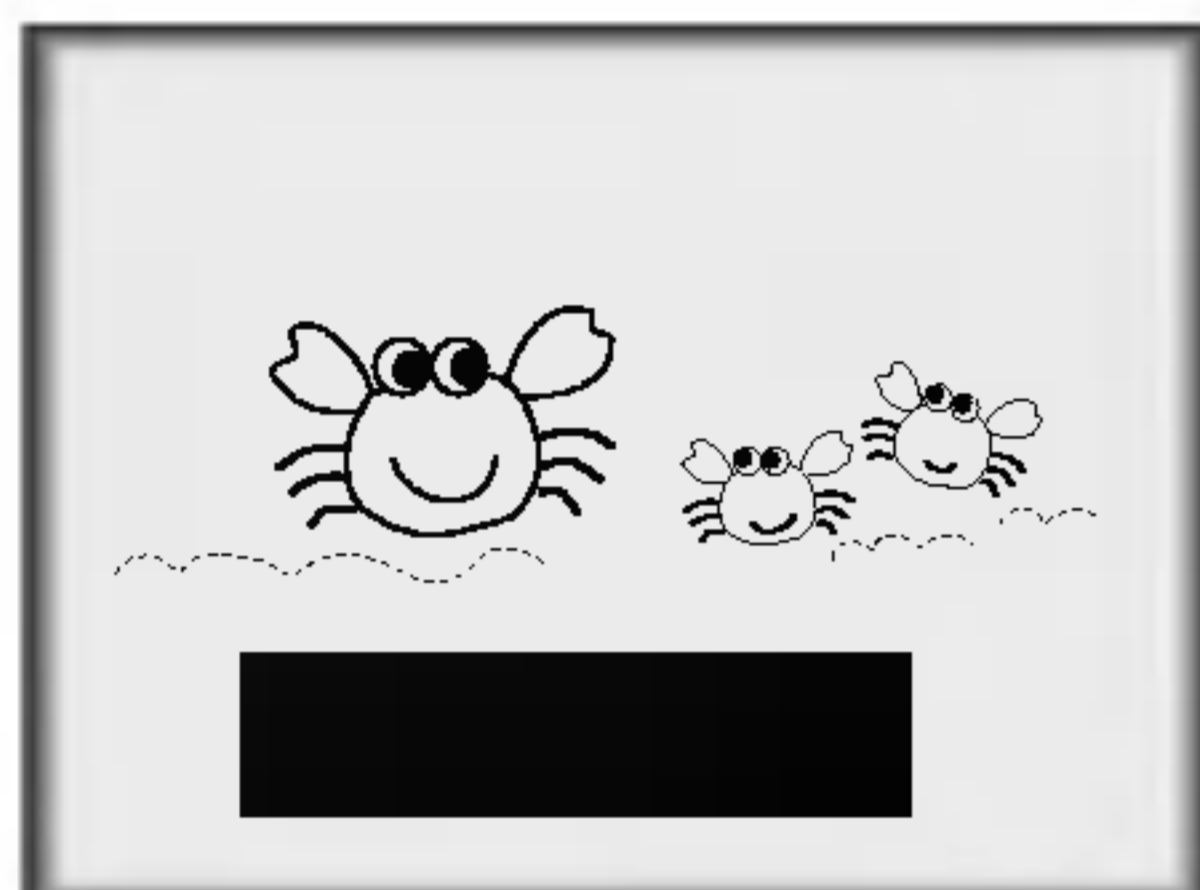

### Caption Tips

- Not all TV broadcasts include closed caption signals.
- Sometimes TV stations broadcast four different caption signals on the same channel. By selecting **Model** to **Mode2**, you can choose which signal you view. **Model** is usually the signal with the captions, while **Another mode** might show demonstration or programming information.
- Your TV might not receive caption signals normally in the following situations.

1. Poor reception conditions are encountered:



#### • IGNITION:

Picture may flutter, drift, suffer from black spots, or horizontal streaking. Usually caused by interference from automobile ignition systems, neon lamps, electrical drills, and other electrical appliances.



#### • GHOSTS:

Ghosts are caused when the TV signal splits and follows two paths. One is the direct path and the other is reflected off tall buildings, hills or other objects. Changing the direction or position of the antenna may improve reception.



#### • SNOW:

If your receiver is located at the weak, fringe area of a TV signal, your picture may be marred by small dots. It may be necessary to install a special antenna to improve the picture.

2. An old, bad, or illegally recorded tape is being played.
3. Strong, random signals from a car or airplane interfere with the TV signal.
4. The signal from the antenna is weak.
5. The program wasn't captioned when it was produced, transmitted, or taped.

Press the **CAPTION** button repeatedly to select your caption selection.



- You can also adjust **Caption/Text** in the **SPECIAL** menu.

# Screen Menu Options

- RGB (PC) mode only; This function doesn't work for RGB (DTV) mode.
- Automatically adjusts picture position and minimizes image shaking.
- After adjustment, if the image is still not correct, your TV is functioning properly but needs further adjustment.
- The **Auto config.** and **Manual config.** are not active in HDMI mode.

1. Press the **MENU** button and then use **▲ / ▼** button to select the **SCREEN** menu.
2. Press the **▶** button and then use **▲ / ▼** button to select **Auto config.**
3. Press the **▶** button to run Auto configure.
  - When **Auto config.** has finished, **OK** will be shown on screen.
  - If the position of the image is still not correct, try Auto adjustment again.
4. In RGB (PC) mode, if the image needs to be adjusted more after using **Auto config.**, you can make further adjustments with the **Manual config.** option.

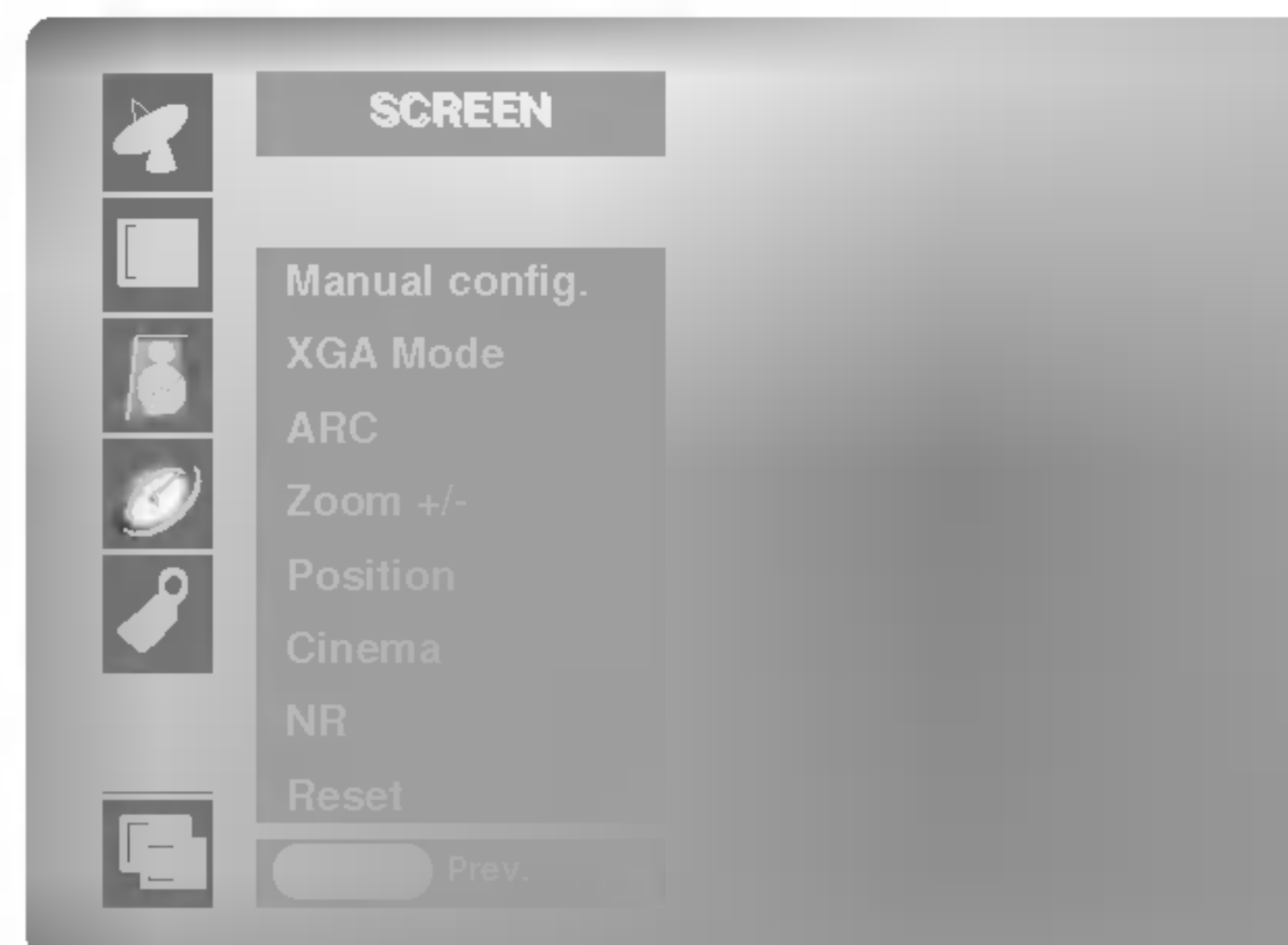

- Caution: If a 4:3 fixed image is on the screen for a long time, it may remain visible.
- Set every aspect ratio for TV, Video, Component 480i sources.
- Use 4:3 or 16:9 for other RGB(PC), HDMI(PC) sources.
- Horizon is not available for RGB (DTV), HDMI (DTV), and Component (DTV) sources.

1. Press the **ARC** button repeatedly to select the desired picture format. You can also adjust **ARC** in the **SCREEN** menu.
  - **4:3**  
Choose **4:3** when you want to view a picture with an original 4:3 aspect ratio, with black bars appearing at both the left and right sides.
  - **16:9**  
Choose **16:9** when you want to adjust the picture horizontally, in a linear proportion to fill the entire screen.
  - **Horizon**  
Choose **Horizon** when you want to adjust the picture in a non-linear proportion, that is, more enlarged at both sides, to create a spectacular view.
  - **Zoom**  
- Choose **Zoom** when you want to view the picture without any alteration. However, the top and bottom portions of the picture will be cropped.

- If the image still isn't clear after auto adjustment and especially if characters are still jittery, adjust the picture Phase manually.
- To correct the screen size, adjust **Clock**.
- This function works in the following mode : RGB, COMPONENT, HDMI-DTV(480p, 720p,1080i).
- It's not available to use Phase, Clock function in RGB, COMPONENT, HDMI-DTV (480p, 720p,1080i) mode.

1. Press the **MENU** button and then use **▲ / ▼** button to select the **SCREEN** menu.
2. Press the **▶** button and then use **▲ / ▼** button to select **Manual config.**
3. Press the **▶** button and then use **▲ / ▼** button to select **Phase**, **Clock**, **H-Position** or **V-Position**.
4. Use the **◀ / ▶** button to make appropriate adjustments.
  - The **Phase** adjustment range is 0 ~ 63.
  - The **Clock** adjustment range is -20 ~ +50.
5. Press the **ENTER** button to save.



## Selecting VGA/XGA Mode (RGB mode only)

- To see a normal picture, match the resolution of RGB XGA mode (1024x768, 1360x768, 1366x768) with the selection for XGA mode and the resolution of RGB VGA mode (640x480, 848x480, 852x480) with the selection for VGA mode in the **SCREEN** menu.
- If the input source is RGB VGA mode, the screen menu option will be changed from **XGA Mode** to **VGA Mode** automatically.

1. Press the **MENU** button and then use **▲ / ▼** button to select the **SCREEN** menu.
2. Press the **▶** button and then use **▲ / ▼** button to select **VGA Mode/XGA Mode**.
3. Press the **▶** button and then use **▲ / ▼** button to select the desired VGA/XGA resolution.
4. Press the **ENTER** button to save.



- When enlarging or reducing the picture, the screen may be display unnatural picture.

Press the **Zoom+/Zoom-** button.

Press the **Zoom+/Zoom-** button to make appropriate adjustments.



- You are available to this function after adjusting Zoom +/-.

1. Press the **MENU** button and then use **▲ / ▼** button to select the **SCREEN** menu.
2. Press the **▶** button and then use **▲ / ▼** button to select **Position**.
3. Press the **▶** button and then use **▲ / ▼ / ◀ / ▶** button to adjust the position.
4. Press the **ENTER** button to save.

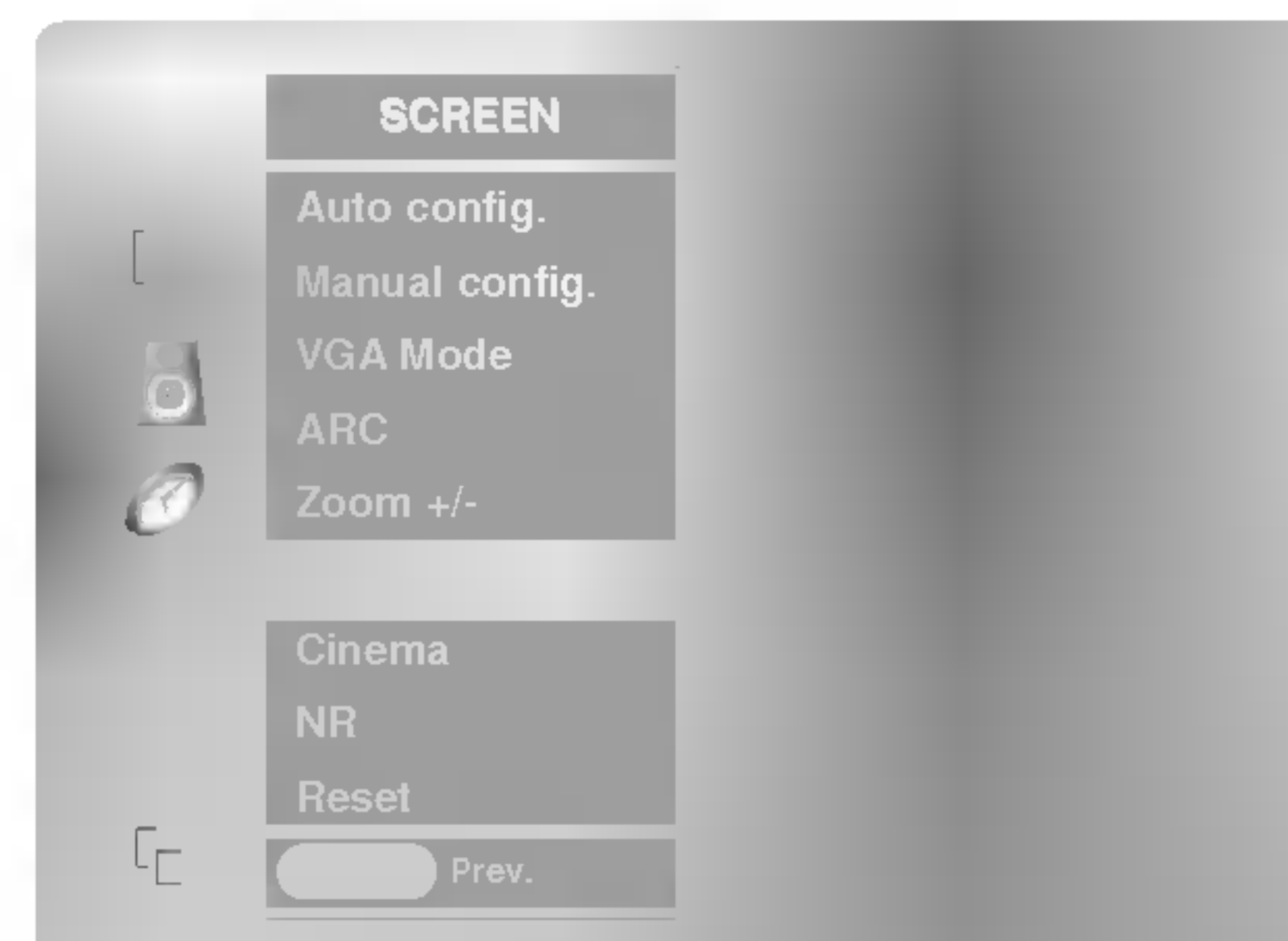

### Cinema Mode Setup (TV, Video1-2 and Component 480i mode only)

- Sets up the TV for the best picture appearance for viewing movies.
- This function works in the following mode:  
TV, Video 1, Video 2 or COMPONENT (480i).

1. Press the **MENU** button and then use **▲ / ▼** button to select the **SCREEN** menu.
2. Press the **▶** button and then use **▲ / ▼** button to select **Cinema**.
3. Press the **▶** button and then use **▲ / ▼** button to select **On** or **Off**.
4. Press the **ENTER** button to save.

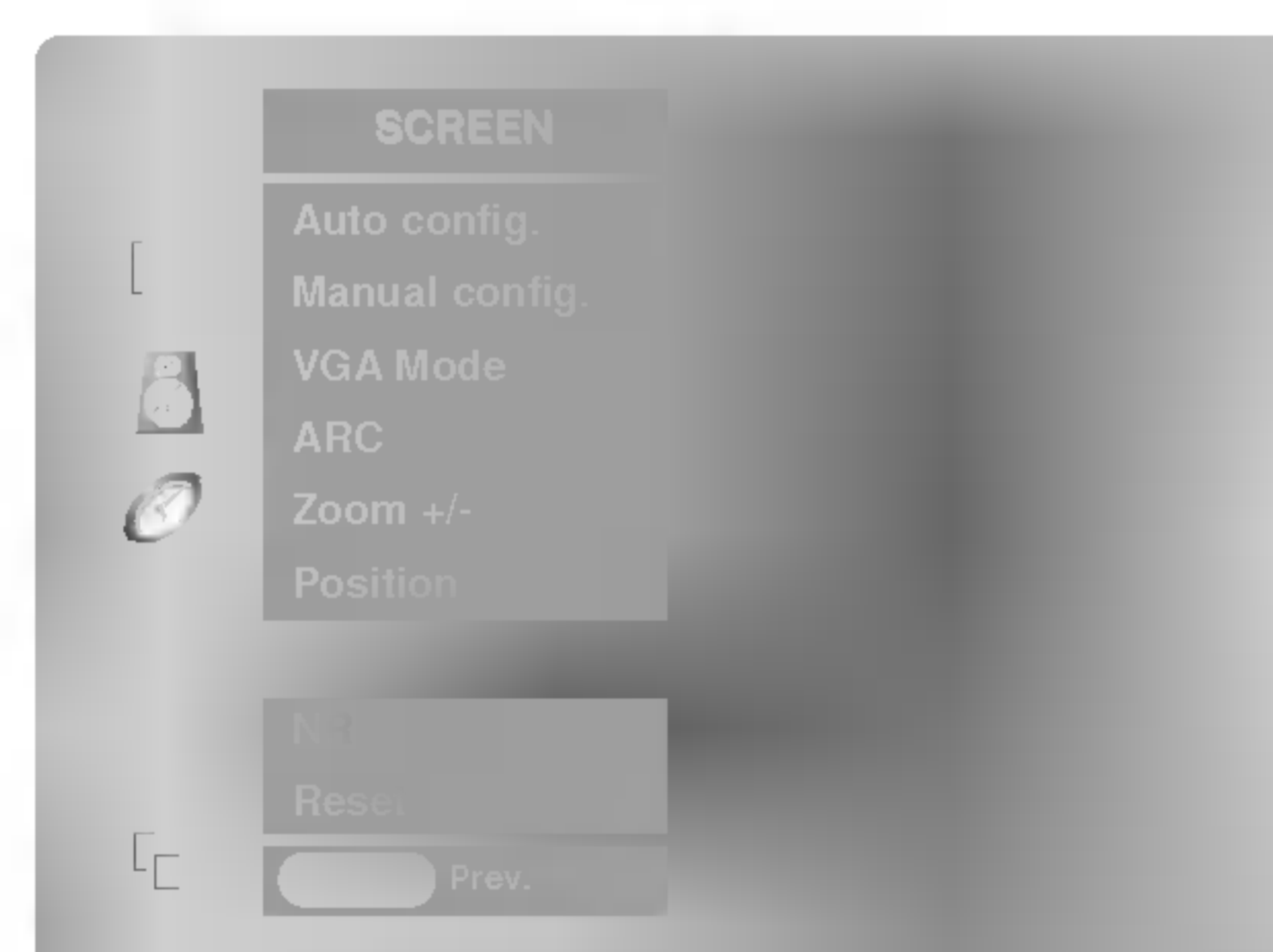

- You can select **3D NR** or **MPEG NR** to reduce the picture noise which may appear on the screen during watching the TV.

1. Press the **MENU** button and then use **▲ / ▼** button to select the **SCREEN** menu.
2. Press the **▶** button and then use **▲ / ▼** button to select **NR**.
3. Press the **▶** button and then use **▲ / ▼** button to select **3D NR** or **MPEG NR**.
4. Press the **◀ / ▶** button to make appropriate adjustments.
5. Press the **ENTER** button to save.

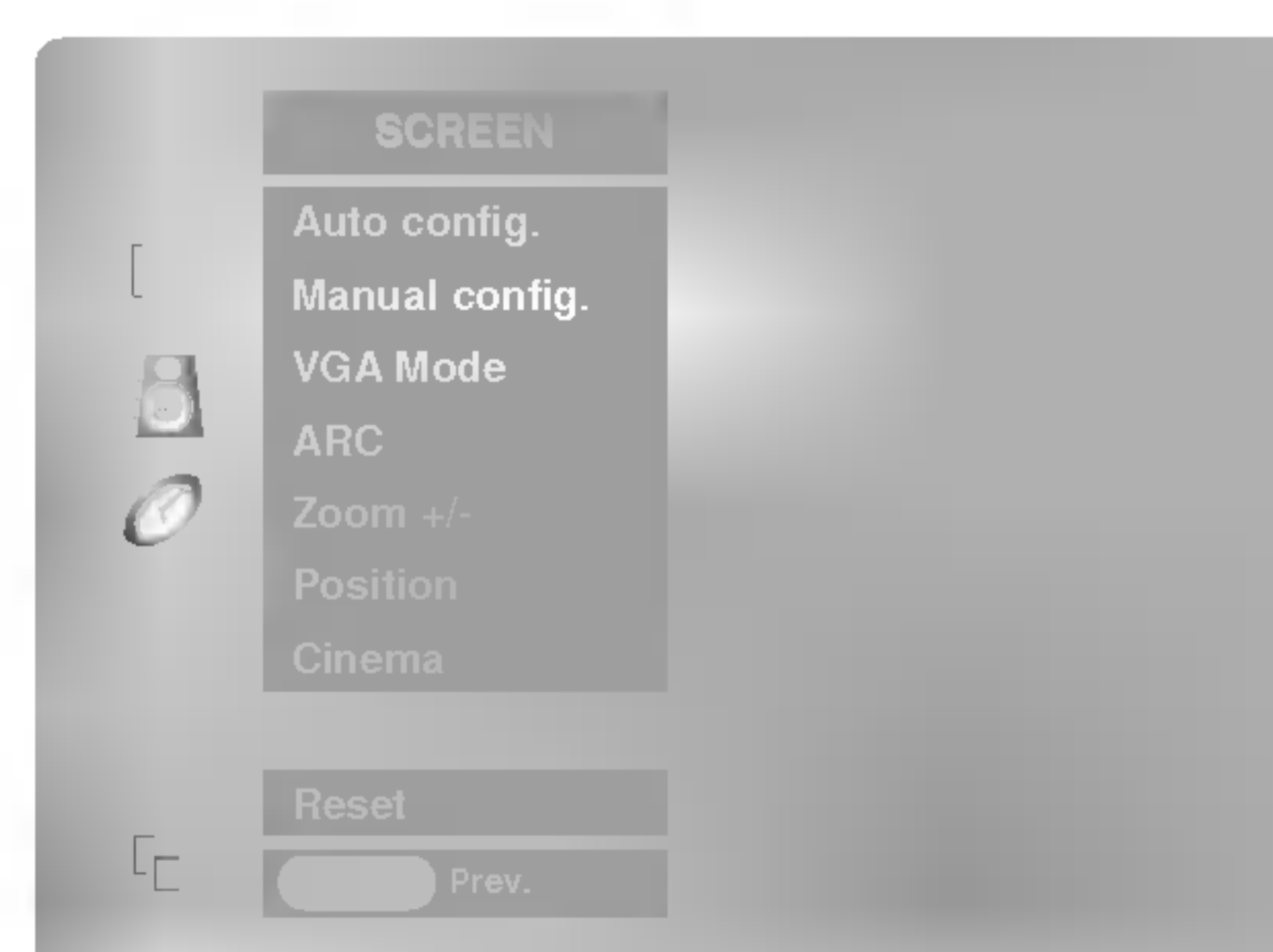

### Initializing (Reset to original factory value)

- Reset is unique to each function: Manual config., Position, PIP Transparency, Zoom +/-, win. position, win. size and sub picture size for double window.
- Use the Reset option to initialize the adjusted settings.

1. Press the **MENU** button and then use **▲ / ▼** button to select the **SCREEN** menu.
2. Press the **▶** button and then use **▲ / ▼** button to select **Reset**.
3. Press the **▶** button.





- You can use the JPEG and MP3 file by memorizing to Memory card in **XSTUDIO** mode.

## Memory Card

This is a device equipment to communicate the data between AV external equipment. It's used to a digital camera, camcorder, MP3 player, notebook or PDA.

## Precaution for Using the Memory Card

- Please be sure to insert the correct memory card type in the right direction.  
(Confirm between the two memory slots before insertion.)
- Don't insert the metal substances into the slots of the memory card.
- Do not bend, drop or apply strong shock to memory card.
- After pulling the memory card out from the TV, please keep the memory stick in a appropriate case to prevent it from static shock.
- The stored data may be changed or lost as a result of misuse, static electricity.
- Do not turn the power off while the memory card is in operation.
- Don't eject the memory card while in use. Otherwise, it may cause a data loss or card damage.
- Insert only one card to each slot.
- To prevent a change or loss for stored data, don't misuse the TV or don't let static electricity or electrical noise for TV.
- This Company takes no responsibility for problems such as the damage or malfunction that occurs while using the TV set, inappropriate TV settings, or any other reasons, except for defects or malfunctions intrinsic to the product.
- Ensure to use a memory card that lists the manufacturers name and serial number.
- The manufacturer will not be responsible for any data damage. Making back up data is strongly recommended.
- Make sure to comply with the following steps when ejecting a memory card.
- Each Memory Card is complied with standard.

## How to insert and eject the Memory Card

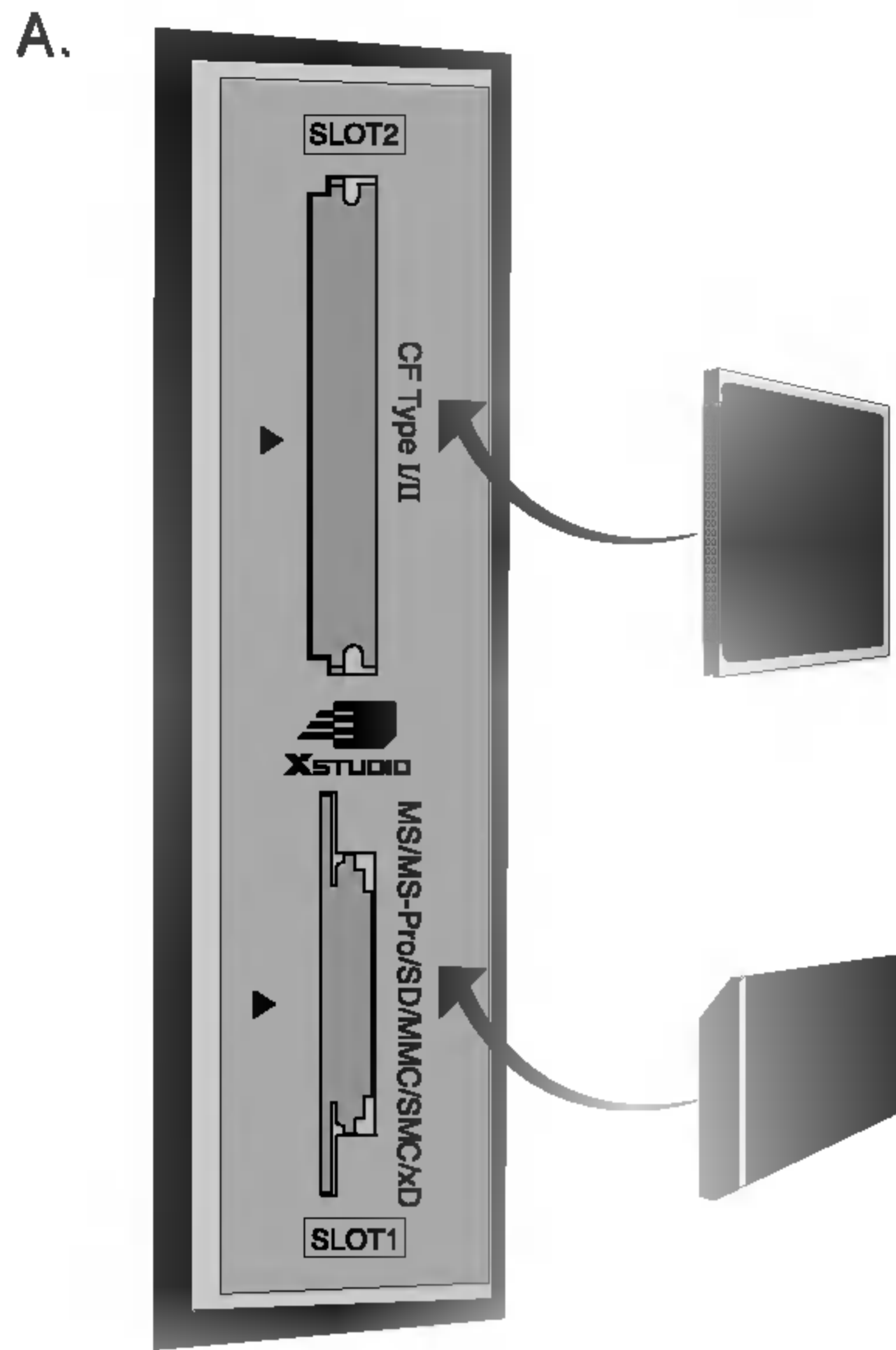

### ◆ Inserting a Card

1. Insert the Memory Card to Memory card slots of TV side panel.
2. Two slots support different types of the Memory Cards.
3. If a Memory Card is not inserted, each slot is disabled.

### ◆ Ejecting a card

1. Press the **M/C EJECT** button on the remote control.
2. Select the **Slot 1** or **Slot 2** based on the inserted card location.  
If you select **Cancel**, OSD will disappear.
3. Eject the card by the hand.



**Caution:** Press the **M/C EJECT** button of remote control before removing the memory card. Failure to do so may damage the card.

- Use the specified card based on the slot location.
- 8 types of Memory Card can be used for this set.
- NTFS file system is not supported.

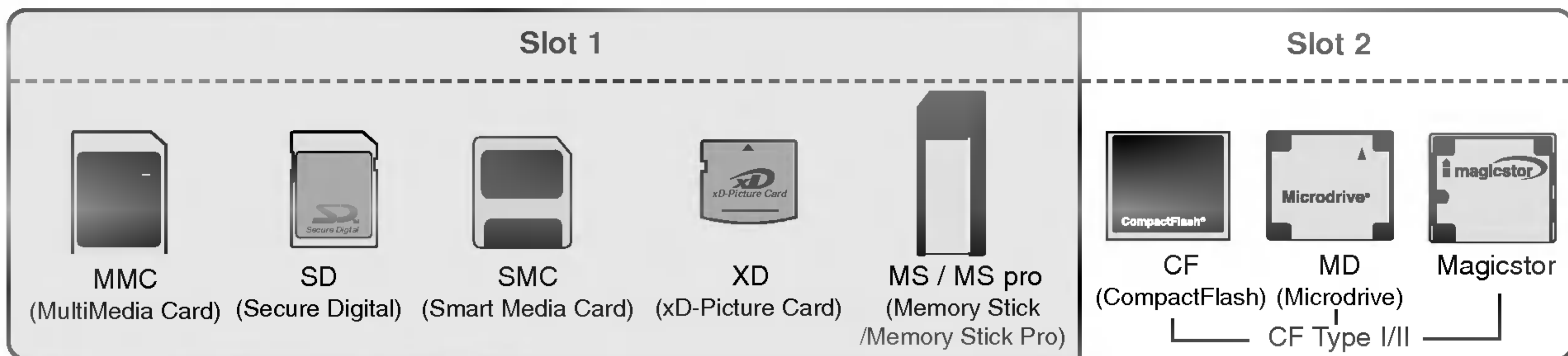





### Available file in **XSTUDIO** mode

A sort of file	Photo Image (JPEG)	Music File (MP3)
Compatibility	*.jpg	*.mp3
Memory card capacity	CF: 2GB Microdrive: 2GB Magicstor: 2.2GB MMC: 256MB SD: 512MB - <b>Some MagicStor Plus cards are not usable.</b> An error may occur if you use a memory card with greater than the specified capacity.	SMC: 128MB XD: 512MB MS: 128MB MS PRO: 1GB
Unsupported or damaged file	Unsupported or damaged JPEG or MP3 files can cause errors. Do not try to change the file extension of unsupported file types to the file extension of supported file types.	

- Playback speed can vary dependent on the card type.
- You can assign 8 characters for the file name of the card. If the file name is longer than 8 characters, it will be truncated at 6 digits and "~1, 2, 3, and 4" will be appended to the 7-8th position.



The JPEG Decoding/The Image Preview Supplied Spec

	Compression Method		Colour format		
	Baseline	Progressive	4:4:4 11:11:11 (Y, Cb, Cr)	4:2:2 21:11:11 (Y, Cb, Cr) 12:11:11 (Y, Cb, Cr)	4:2:0 22:11:11 (Y, Cb, Cr)
JPEG Decoding Support	○	X	X	○	○
Image Display	Image	invalid format	invalid format	Image	Image
Preview Image Display	Display  when there is no thumbnail.			Display  when there is no thumbnail.	Display  when there is no thumbnail.

- If a error occur when decoding the JPEG, "**Corrupted file**" is displayed on screen.

How to insert and eject the card

◆ Inserting a Card

1. Insert the card into the Slot 1 and/or Slot 2 with the hand softly and slowly.
2. Press the  button to enter the **XSTUDIO** mode.  
Press the  button again to exit the **XSTUDIO** mode.

◆ Ejecting a card

1. Press the **M/C EJECT** button on the remote control.
2. Press **▲ / ▼** button to Select the **Memory 1 Eject** or **Memory 2 Eject** based on the inserted card location.  
If selecting **Cancel**, OSD will disappear.
3. Eject the card with the hand.

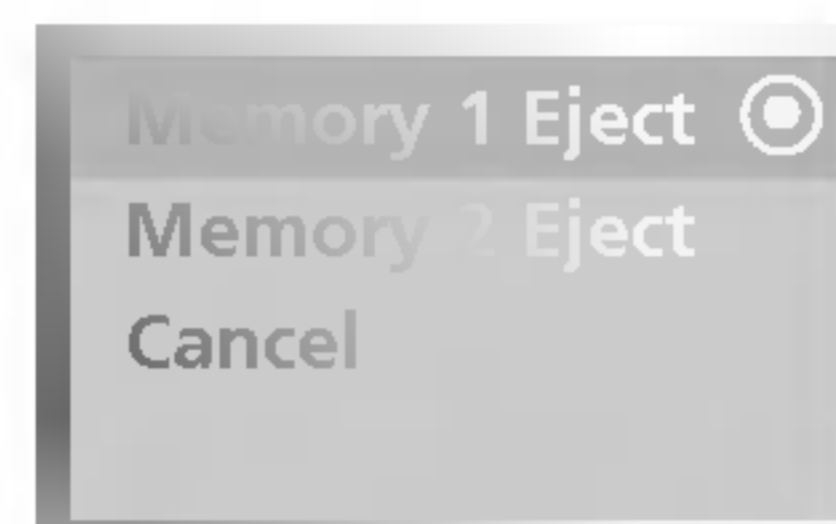

Notes:

- Screen saver will appear if you do not remove the card with the hand after operating the eject function.
- When entering the photo or music media at first, the **M/C EJECT** button will not work.  
It's possible to use the **M/C EJECT** button during using the photo or music media.



**Caution:** Press the **M/C EJECT** button of remote control before removing the memory card.  
Failure to do so may damage the card.

\* In this manual, the OSD (On Screen Display) may be different from your TV's because it is just an example to help you with the TV operation.

### Select the Photo or Music Media

- When you plug a memory card or press the  button, the below screens will be displayed.



1. Press **▲ / ▼ / ◀ / ▶** button to select photo or music for slot1/2.
2. Press the **ENTER** button to enter the photo or music media.
3. Press the  button to exit the **XSTUDIO** mode.

#### Notes:

- The OSD of the ejected card slot is inactivated when ejecting the card with the hand.
- If there is any error in a memory card, it's impossible to enter **XSTUDIO** mode.

- When you select **Photo** in entry menu, you will now see a screen filled with thumbnail photo media.



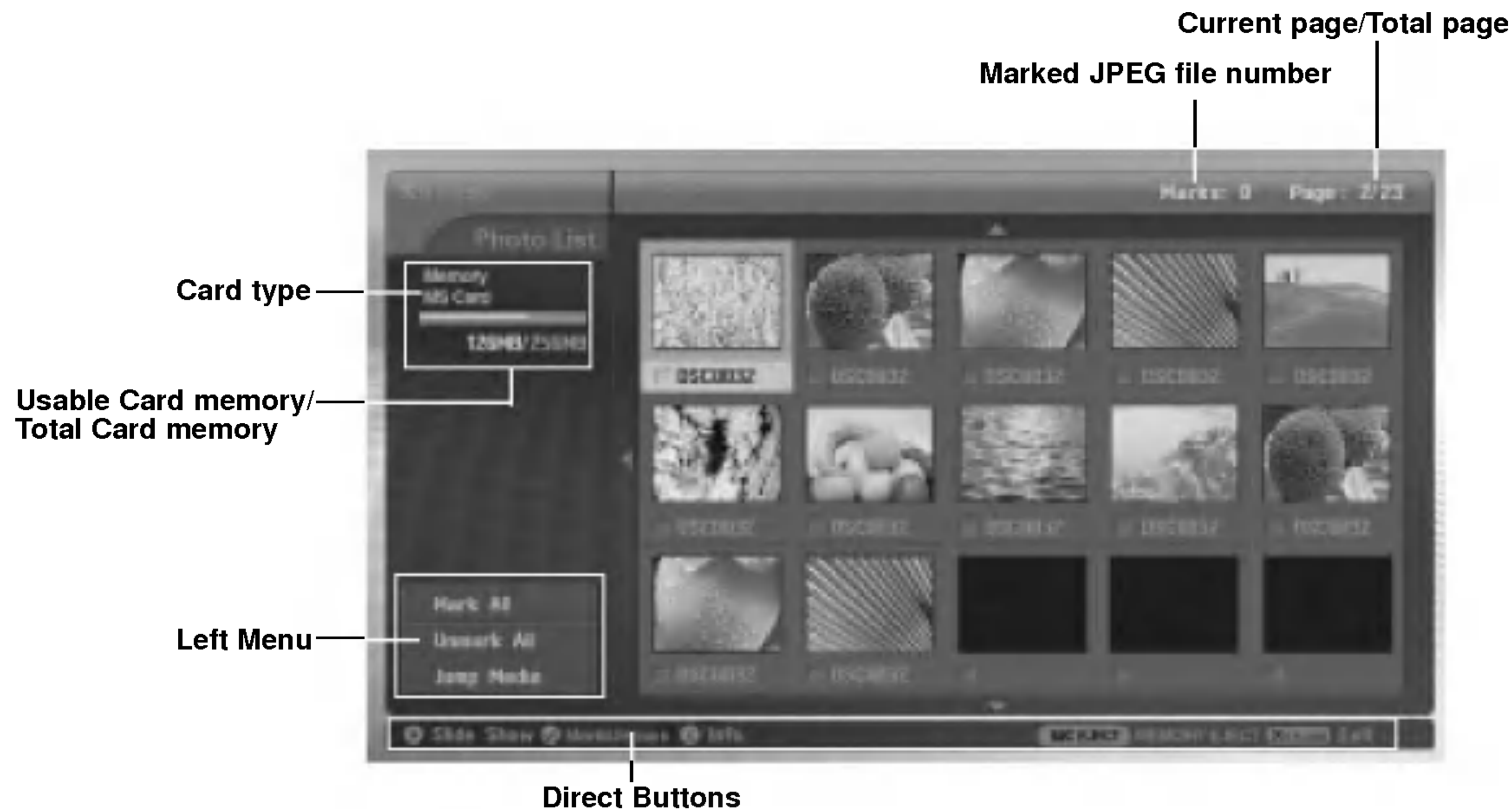







\* In this manual, the OSD (On Screen Display) may be different from your TV's because it is just an example to help you with the TV operation.



### Photo Selection and PopUp menu

- Select your desired image file.



1. Insert the memory card to Slot 1 and/or Slot 2 on the TV front panel.
2. Press the  button.
3. Use  /  /  /  button to select photo media for slot1 or slot 2.
4. Press the **ENTER** button to enter the photo media.  
*Note: It's possible to display 15 JPEG files per page.*
5. Press the  /  /  /  button to select JPEG file and then press the **ENTER** button.
6. Press the  /  button to select **View** and then press the **ENTER** button. The selected image will display on entire screen.

## Mark/Unmark for JPEG file

- You can mark/unmark the file to view the desired file or use slide show for desired file conveniently.
- The selected file displays orange in color.  
When pressing the **ENTER** button after marking some a file, the marked file displays green in color.



### ◆ Mark/Unmark for all files

1. In photo media, repeatedly press ◀ button to enter the menu on the left.
2. Press the ▲ / ▼ button to select **Mark All** or **Unmark All**.
  - If you select **Mark All**, every file is selected.
  - If you select **Unmark All**, the selection for every file is released.
3. Press the **ENTER** button and then ▶ button to return to the photo list.

### ◆ Mark/Unmark for some file

Press the **MARK** button repeatedly to mark or unmark some JPEG file.

- Use this function to jump to other media during using photo media.

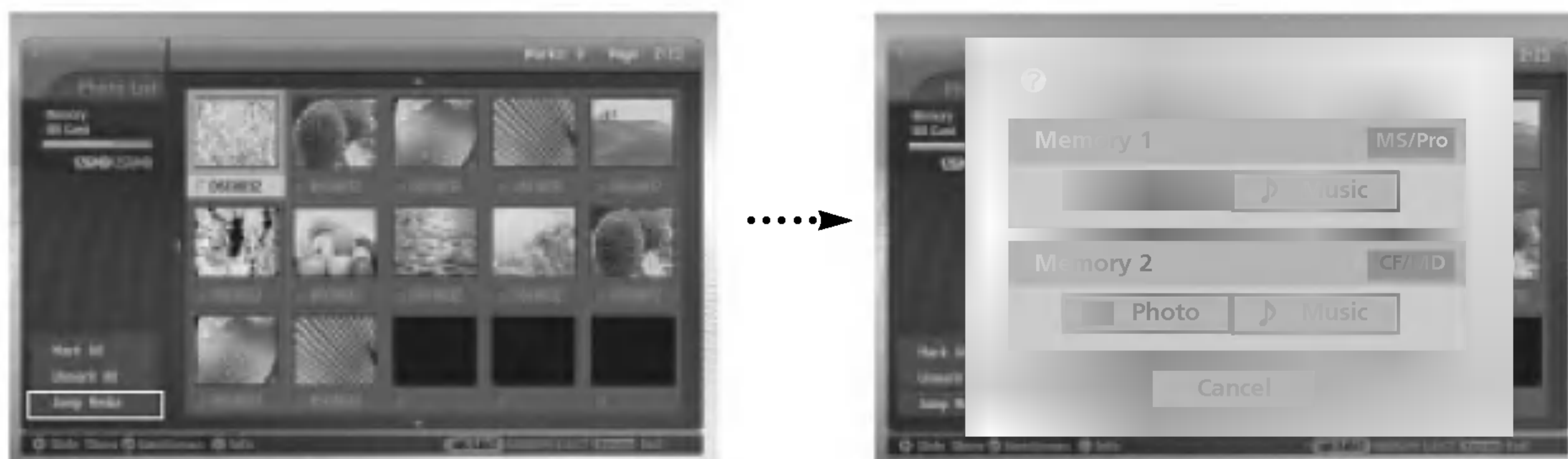

1. In photo media, press ◀ button repeatedly to enter the left menu.
2. Press the ▲ / ▼ button to select **Jump media** and then press the **ENTER** button.
3. Press the ▲ / ▼ / ◀ / ▶ button to select desired media and then press the **ENTER** button. The screen displays each media list.

## The Image Adjustment

- You can display the selected image on entire screen and do the various adjustment for the JPEG file.



1. Press the ▲ / ▼ / ◀ / ▶ button to select JPEG file and then press the **ENTER** button.
2. Press the ▲ / ▼ button to select **View** and then press the **ENTER** button The selected image will display on entire screen.
3. Adjust the JPEG file.



<b>Image selection</b>	<ul style="list-style-type: none"> <li>• Press the ▶ button to select next image.</li> <li>• Press the ◀ button to select previous image.</li> <li>• If you mark for a file, you can see only the marked image.</li> </ul>
<b>Image Rotation</b>	<ul style="list-style-type: none"> <li>• Press the ▲ / ▼ button to rotate the image.</li> <li>• ▲: Rotate clockwise</li> <li>• ▼: Rotate counterclockwise</li> <li>• The enlarged image cannot be rotated.</li> </ul>
<b>Image Zoom In/Out</b>	<ul style="list-style-type: none"> <li>• Press the CH ▲ / ▼ button to enlarge or reduce the image 2 or 4 times.</li> <li>• Press the ▲ / ▼ / ◀ / ▶ button to move the enlarged image.</li> </ul>
<b>Image Deletion</b>	<ul style="list-style-type: none"> <li>• Press the <b>MARK</b> button to delete the current image.</li> </ul>
<b>Go to the Menu</b>	<ul style="list-style-type: none"> <li>• Press the <b>EXIT</b> button to return to the photo list.</li> </ul>
<b>Shown/Hidden the menu</b>	<ul style="list-style-type: none"> <li>• Each press of the <b>ENTER</b> button, the menu will toggle hidden or shown.</li> <li>• The OSD menu will automatically disappear after a while.</li> </ul>

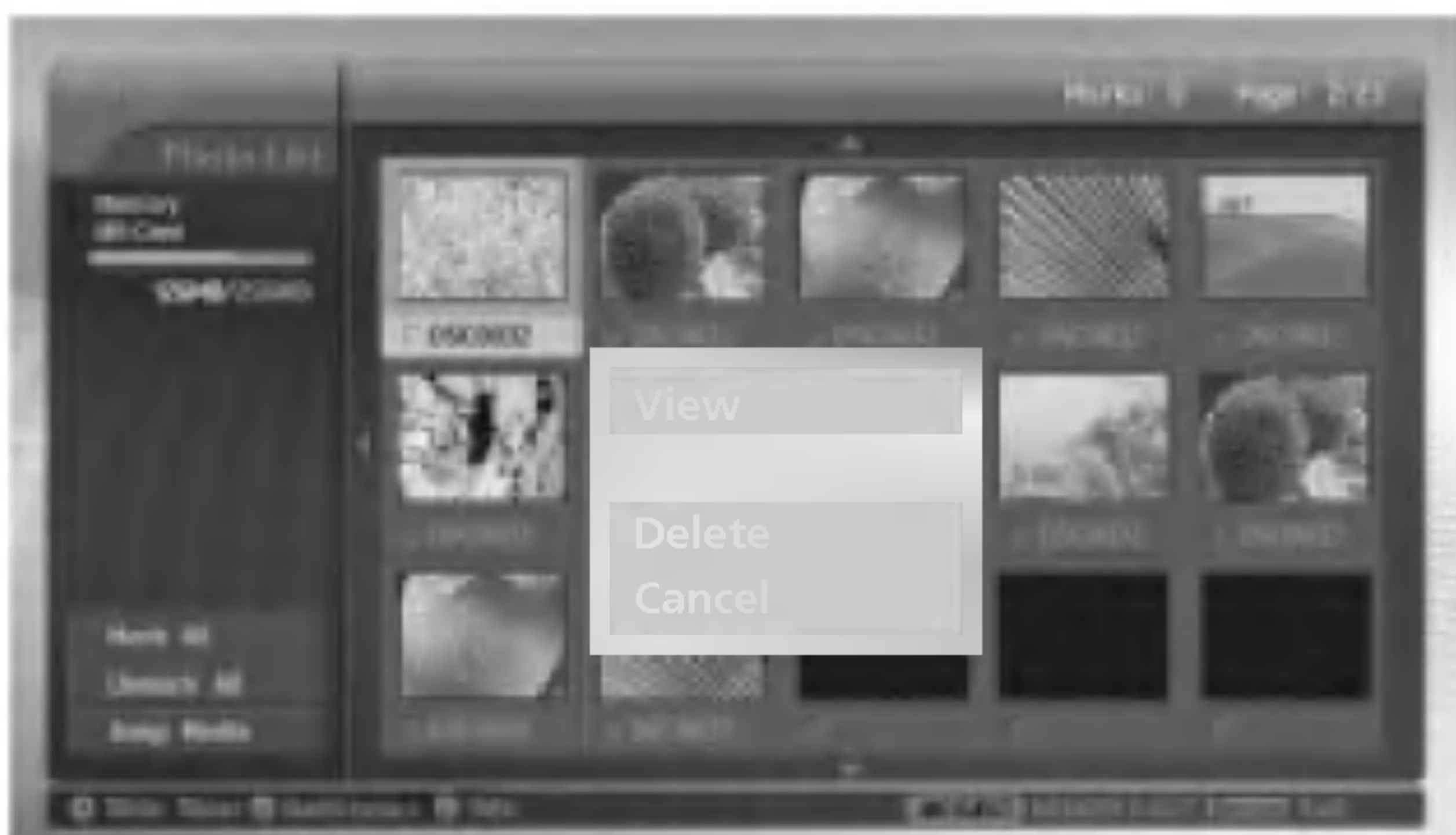

1. Press the ▲ / ▼ / ◀ / ▶ button to select JPEG file and then press the **ENTER** button.
2. Press the ▲ / ▼ button to select **Slide Show** or **Show Marked** and then press the **ENTER** button. (If you mark the file with using **MARK** button, **Show Marked** is displayed on screen.)



3. You can choose the slide show delayed time and effect. Press the ▲ / ▼ / ◀ / ▶ button to choose the slide show delayed time and effect.
4. Press the ▲ / ▼ / ◀ / ▶ button to select **OK**. Slide show start.

**Notes:**

- You can also operate the **Slide Show** or **Show Marked** with  button directly as shown.
- If you mark for a file, slide show will show only the marked image.



<b>Next / previous Image Selection</b>	<ul style="list-style-type: none"> <li>• Press the ▶ button to select next image.</li> <li>• Press the ◀ button to select previous image.</li> </ul>
<b>Image Pause</b>	<ul style="list-style-type: none"> <li>• Press the    button to pause the current image.</li> <li>• Press the  button to restart the slide show.</li> <li>• By pressing ◀ / ▶ button, you can also select the next or previous image while pausing the image.</li> </ul>
<b>Go to the menu</b>	<ul style="list-style-type: none"> <li>• Press the <b>EXIT</b> button to return to the photo list.</li> </ul>
<b>Shown/Hidden the menu</b>	<ul style="list-style-type: none"> <li>• Each press of the <b>ENTER</b> button, the menu is toggle hidden or shown.</li> <li>• The OSD menu will automatically disappear after a while.</li> </ul>

## JPEG file Deletion and Cancel



1. Use the ▲ / ▼ / ◀ / ▶ button to select JPEG file and then press the **ENTER** button.
2. To delete the file, press the ▲ / ▼ button to select **Delete** and then press the **ENTER** button. When “Do you want to delete the file?” message is displayed, select **YES (YES or NO)** with ◀ / ▶ button. The file is deleted, all the following files are shifted up one position.



\* If you select **Delete** after marking some file, all of the marked file is deleted. But in case MS,SMC,SD memory card setted the write protection, “ Protection Mode. Please push the **OK** button.” message is displayed. When you select the **OK**, the screen will return to the photo list.(Release the write protection to delete a JPEG file.)

3. To return to the photo list, press the ▲ / ▼ button to select **Cancel** and then press the **ENTER** button.

- Use it to check information for selected JPEG file.



1. In photo media, select your desired JPEG file.
2. Press the **INFO** button. The file information for selected JPEG file is displayed. If JPEG file has no information, you can't check it.
3. Press the **ENTER**, **EXIT** or **INFO** button to return to the photo list.

- If you don't press any button about 30 seconds while displaying the photo list, the screen saver is worked.



\* The 'Screen Saver'?  
Screen saver is to prevent screen pixel burning caused by long time still picture.

- Press the ▲ / ▼ / ◀ / ▶, **EXIT**, ▶(play), II, ■, ◀◀, ▶▶, **INFO**, **CH** ▲ / ▼, **MARK** buttons to release the screen saver.

- Purchased MP3/music files may contain copyright restrictions. Playback of these files may not be supported by this model.

## Screen Components

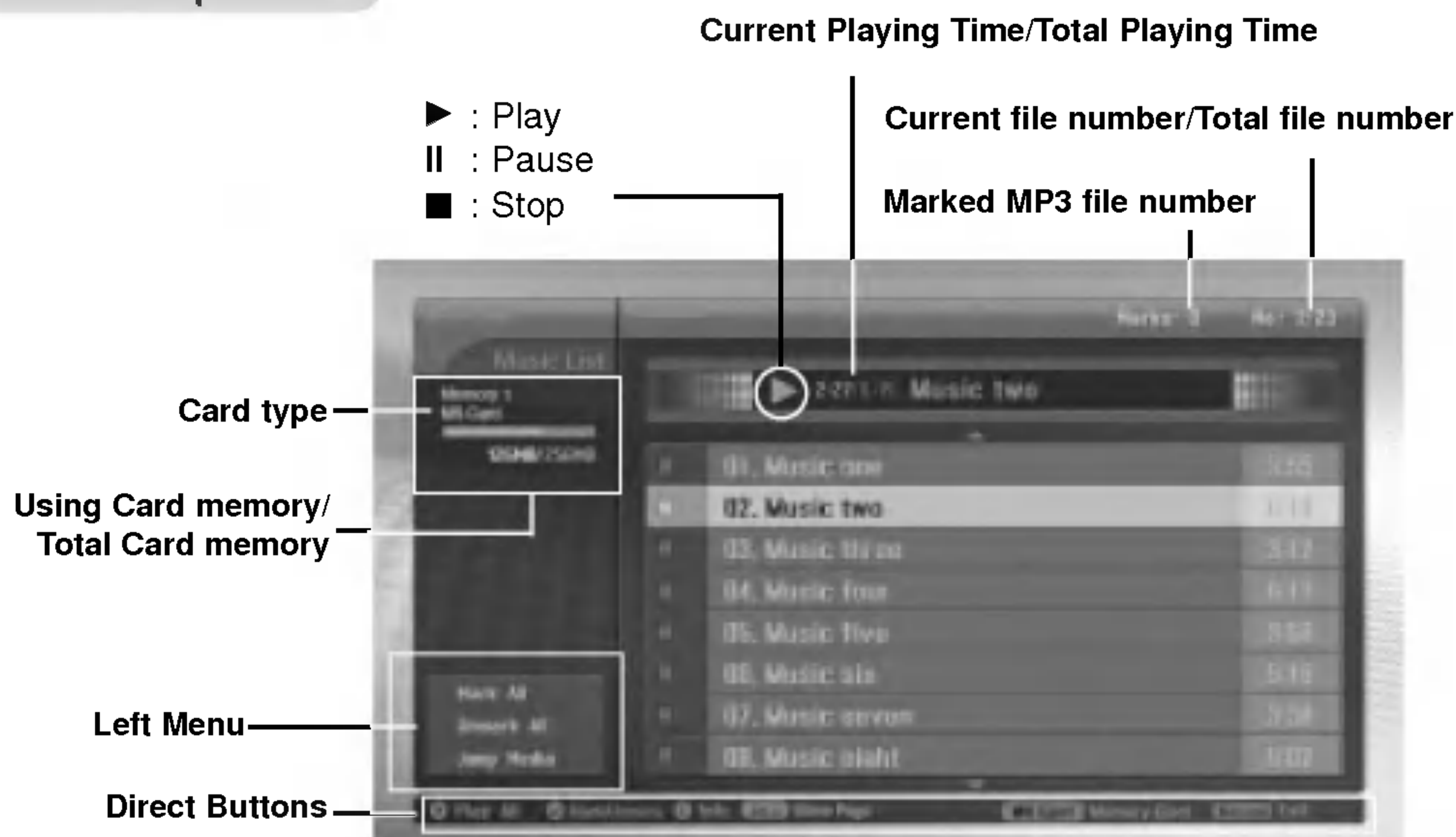

## MP3 File Selection and Playback

- MP3 file Selection and deletion function don't work while playing music.
- If pressing any button except , , button on the remote control while playing music, the music playing is stopped.
- Moves from the current 8 files list to the next files list with **CH ▲ / ▼** button.

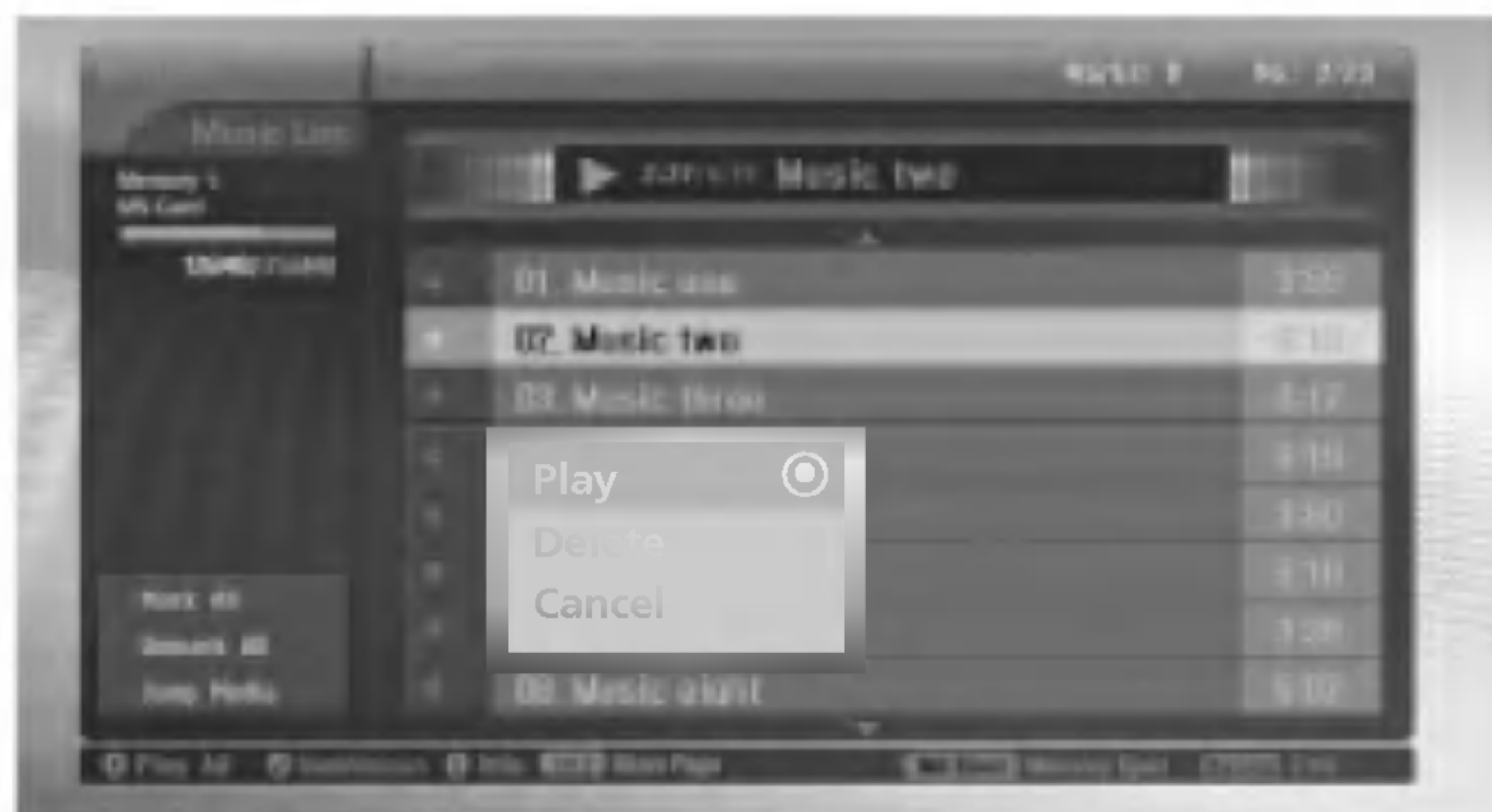

1. Insert the memory card into Slot 1 and/or Slot 2 on the TV front panel.
2. Press the button.
3. Use **▲ / ▼ / ◀ / ▶** button to select music media for slot1 or slot 2.
4. Press the **ENTER** button to enter the music media.  
**Note:** It's possible to display 8 MP3 files per page.
5. Press the **▲ / ▼** button to select desired MP3 file and then press the **ENTER** button.
6. Press the **▲ / ▼** button to select **Play** or **Play Marked** and then press the **ENTER** button.(If you mark the file with using **MARK** button, **Play Marked** is displayed on screen.)

### Notes:

- You can also play the music with button directly.
- The current playing MP3 file displays in front of the title.
- While playing music, press the **I◀◀** or **▶▶I** button to select the previous or next music directly.
- If you press the **I◀◀** button while playing music, the MP3 will replay from beginning.  
(If you press the **I◀◀** button within 1~2 seconds after playing the music, the MP3 plays the previous file.)

\* In this manual, the OSD (On Screen Display) may be different from your TV's because it is just an example to help you with the TV operation.

## Stop/Pause Playback

### ◆ Stop Playback

To stop playback, press the **■** button on the remote control.

To stop playback, press the **ENTER**, **VOL (◀ / ▶)**, **CH (▲ / ▼)** button on the TV.

#### Notes:

- If you replay the MP3 file after stopping, the highlighted MP3 file on menu will play.
- On stopping, **VOL (◀ / ▶)** and **CH (▲ / ▼)** buttons on the TV are used to navigate.

### ◆ Pause Playback

1. Press the **II** button to pause playback.
2. Press the **II** or **⏮** button to starts from the point of your paused part.

## Mark/Unmark for MP3 file

- You can mark/unmark the file to play the desired file only.
- The menu on the left can be used when playback is stopped.



### ◆ Mark/Unmark for all files

1. In music media, press the **◀** button.
2. Press the **▲ / ▼** button to select **Mark All** or **Unmark All**.
  - If you select **Mark All**, every file is selected.
  - If you select **Unmark All**, the selection for every file is released.
3. Press the **ENTER** button and then **▶** button to return to the music list.

### ◆ Mark/Unmark for some file

Press the **MARK** button repeatedly to mark or unmark some MP3 file.

- Use this function to jump to other media during using music media.

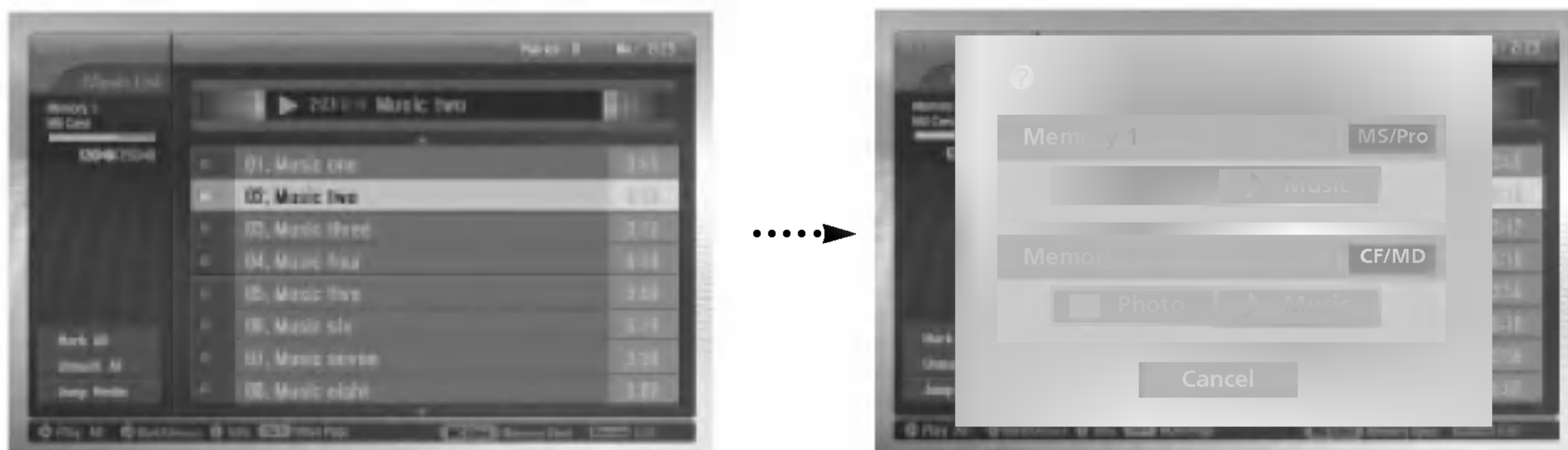

1. In music media, press the ◀ button.
2. Press the ▲ / ▼ button to select **Jump media** and then press the **ENTER** button.
3. Press the ▲ / ▼ / ◀ / ▶ button to select desired media and then press the **ENTER** button. The screen displays each media list.

- If you don't press any button for about 30 seconds, the screen saver is activated.

#### ◆ During playing the MP3

\* The 'Screen Saver'?  
Screen saver is to prevent screen pixel burning caused by long time still picture.

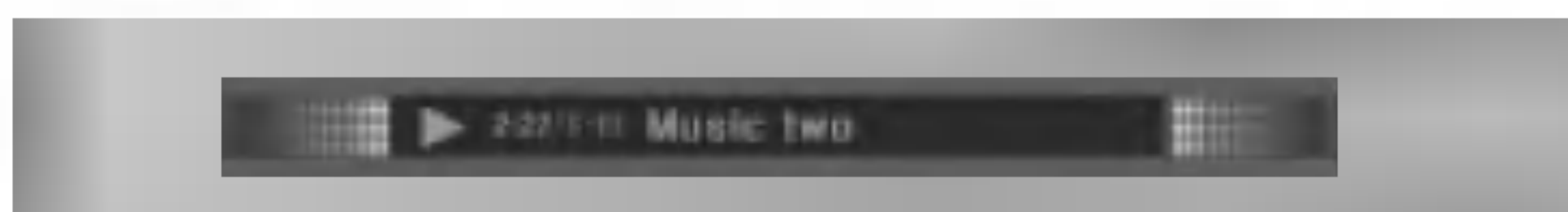

- Press the ⏮, ⏪, ⏩, ⏭ buttons. The screen saver is released but the MP3 playback is restarted.
- ⏮, ⏪ : Return to a initial portion of the MP3 playback.
- ⏩ : Playback the next MP3.
- If you press any other button, the screen saver is released and the MP3 playback is stopped.

#### ◆ During stopping the MP3



- Press the ▲ / ▼ / ◀ / ▶, **EXIT**, ▶(play), **II**, **■**, **I◀◀**, **▶▶I**, **INFO**, **CH ▲ / ▼**, **MARK** buttons to release the screen saver.

## MP3 file deletion and Cancel

- It's impossible to delete the music during playback.

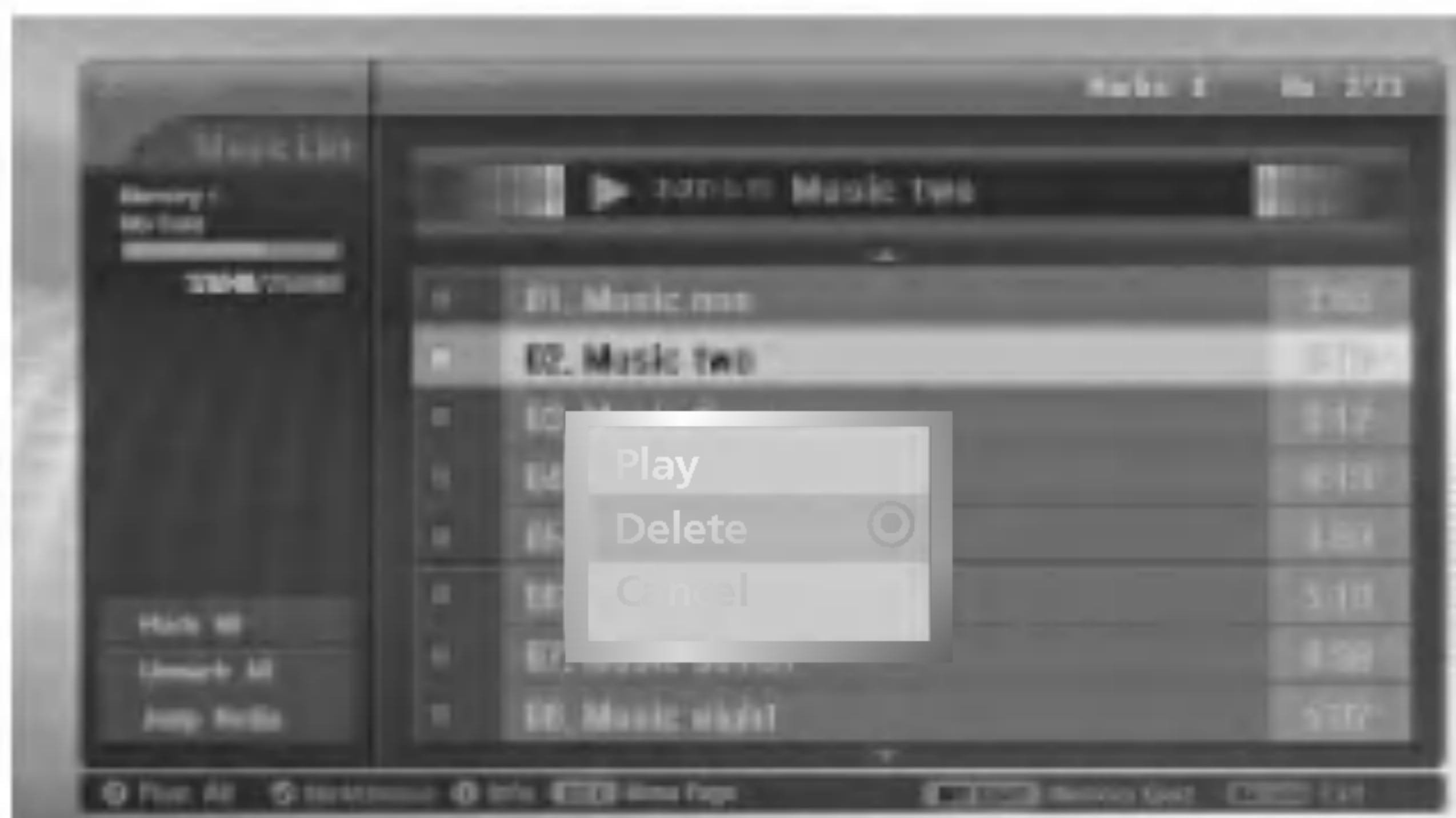

1. Use the ▲ / ▼ button to select MP3 file and then press the **ENTER** button.
2. To delete the file, press the ▲ / ▼ button to select **Delete** and then press the **ENTER** button. When “Do you want to delete the file?” message is displayed, select **YES (YES or NO)** with ◀ / ▶ button. The file is deleted, all the following files are shifted up one position.



\* If you select **Delete** after marking some files, all of the marked files are deleted. But in case MS, SMC, SD memory card set the write protection, “Protection Mode. Please push the **OK** button.” message is displayed. When you select the **OK**, the screen is returned to the photo list. (Release the write protection to delete a MP3 file.)

3. To return to the music list, press the ▲ / ▼ button to select **Cancel** and then press the **ENTER** button.

- Use it to check information for selected MP3 file.

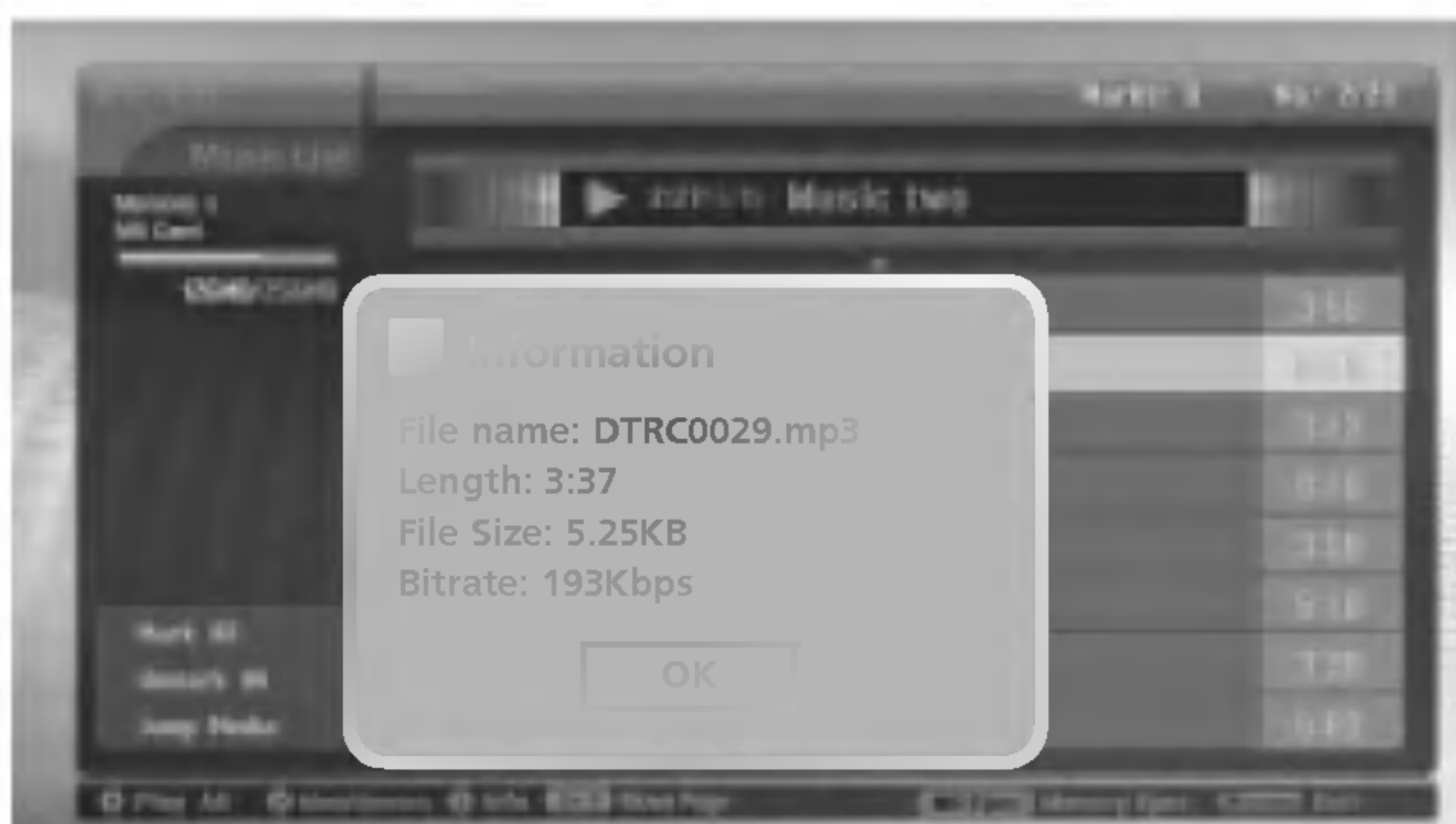

1. In music media, select your desired MP3 file.
2. Press the **INFO** button. The file information for selected MP3 file is displayed. If MP3 file has no information, you can't check it.
3. Press the **ENTER**, **EXIT** or **INFO** button to return the previous menu.

# PIP (Picture-In-Picture)/Double Window Feature

- PIP lets you view 2 different inputs pictures (sources) on your TV screen at the same time. One source will be large, and the other source will show a smaller inset image.
- Double Window mode splits the screen into 2, allowing 2 picture sources to be shown on the TV screen at the same time. Each source is given half the screen.

## Watching PIP/Double Window

Press the **PIP** button to access the sub picture. Each press of PIP changes the PIP options as shown below.

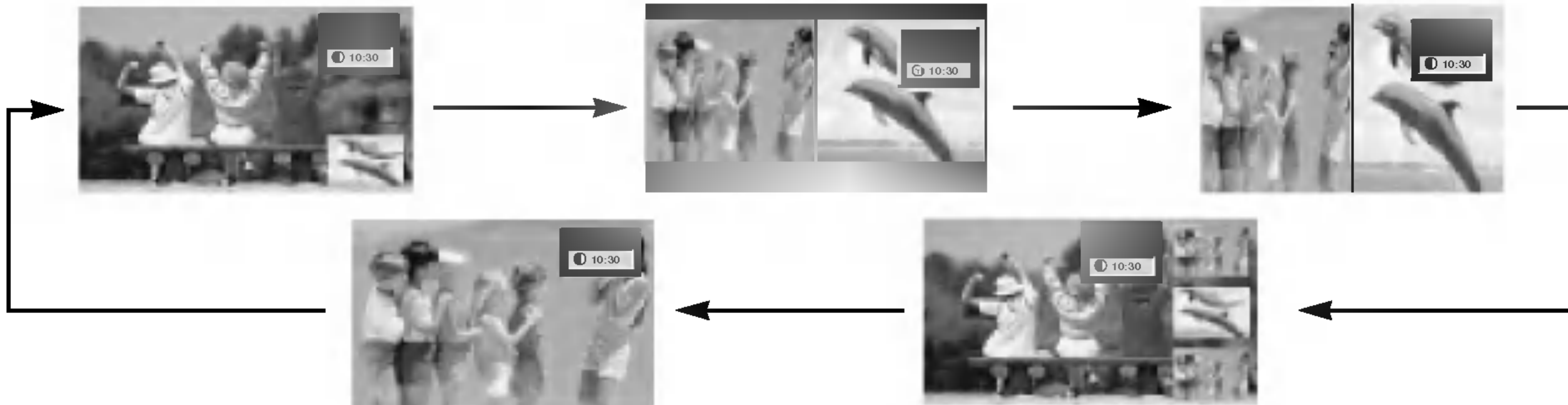

## Swapping the PIP/Double Window

Use the **SWAP** button to switch the main and sub pictures.

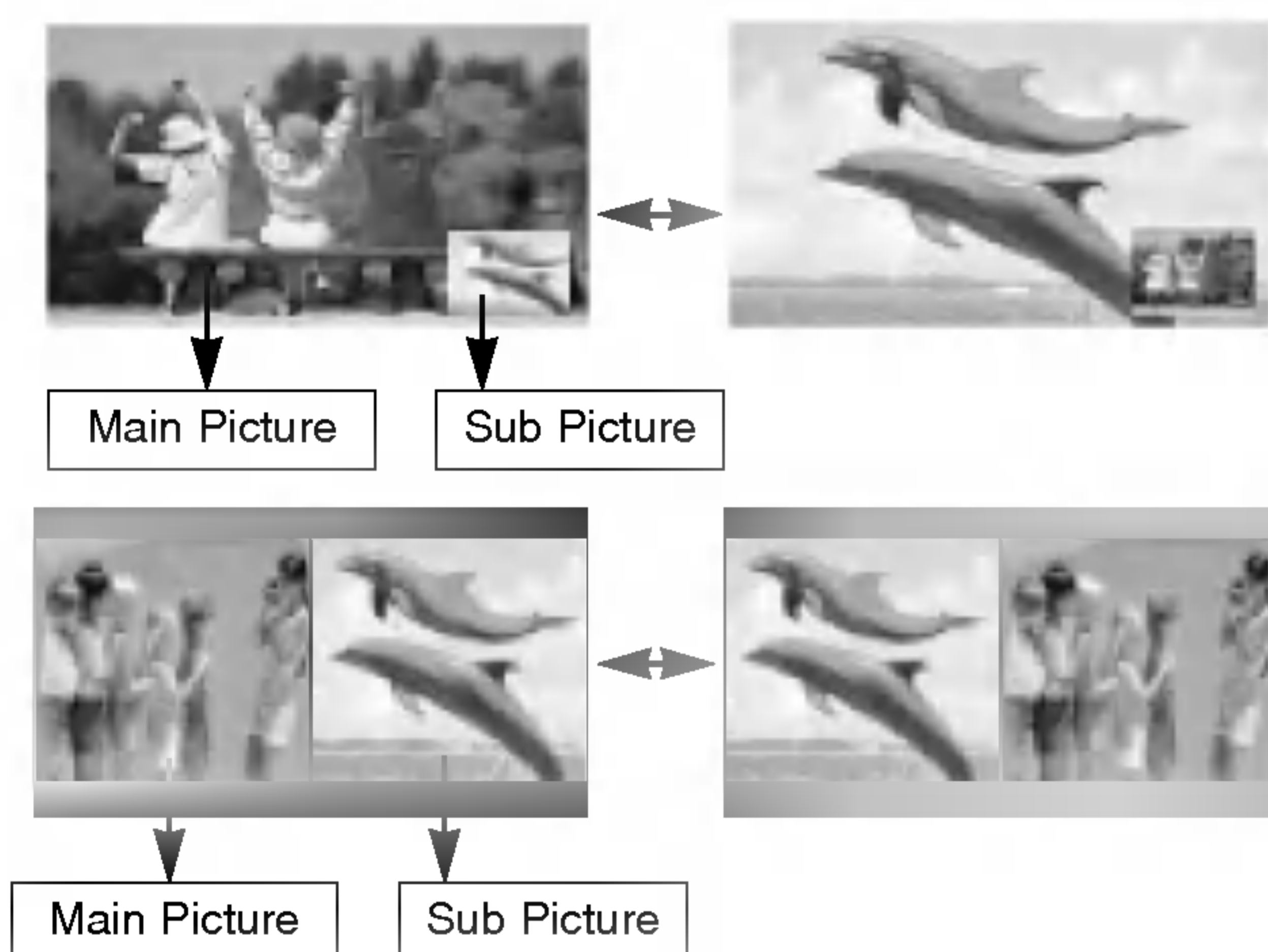

- To make the PIP clear or opaque.
1. Press the **MENU** button and then use **▲ / ▼** button to select the **PIP/DW** menu.
  2. Press the **▶** button and then use **▲ / ▼** button to select **PIP Transparency**.
  3. Press the **▶** button and then use **◀ / ▶** button to adjust PIP transparency.
    - The adjustment range of **PIP Transparency** is 0 ~ 10.
  4. Press the **ENTER** button to save.

# PIP (Picture-In-Picture)/Double Window Feature

## Moving the PIP (PIP Mode only)

Press the **POSITION** button.

Press the **▲ / ▼ / ◀ / ▶** button repeatedly until desired position is achieved. The sub picture moves up/down/left/right.

- You can also move the PIP position with **Win.position** in the **PIP/DW** menu.

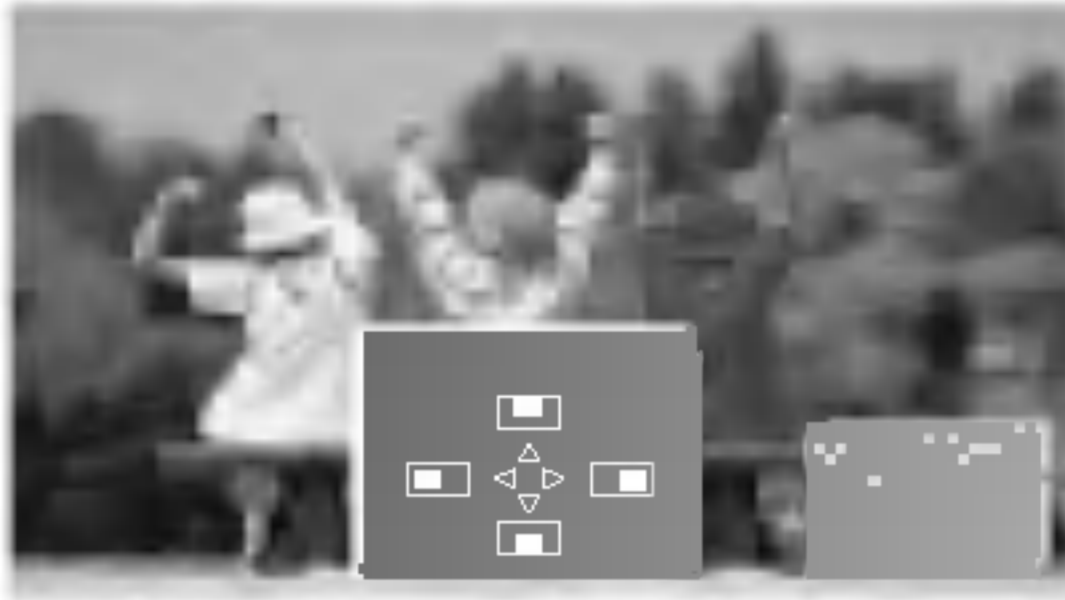

## POP(Picture-out-of-Picture: Channel Scan

Use POP to search the programmes of all the memorized channels one-by-one on the 3 PIP screen display, (while the main picture source remains the current channel). The pictures of all the programmed channels are searched with the 3 POP screen.

## Selecting an Input Signal Source for PIP/DW

Use the **PIP INPUT** button to select the input source for the sub picture. Each press of **PIP INPUT** button changes the PIP source.

Press the **SIZE** button and then use **◀ / ▶** button to change the sub picture size.

- Using the **Win.size** function in Double Window mode, main and sub picture sizes are changed simultaneously. Using the **Win.size** function in PIP mode, sub picture size is changed.
- You can also change the sub picture size with **Win.size** in the **PIP/DW** menu.



Press the **PIPCH+ / PIPCH-** button to select a channel for the sub picture in PIP mode.

# External Control Device Setup

- Connect the RS-232C input jack to an external control device (such as a computer or an AV control system) and control the set's functions externally.

## How to connect external control equipment

- Connect the serial port of the control device to the RS-232C jack on the Monitor back panel.
- RS-232C connection cables are not supplied with the set.
- The set remote control and front panel controls (except main power) will not be functional if the Monitor is controlled by a PC computer or other external device.

< Back panel of the set >

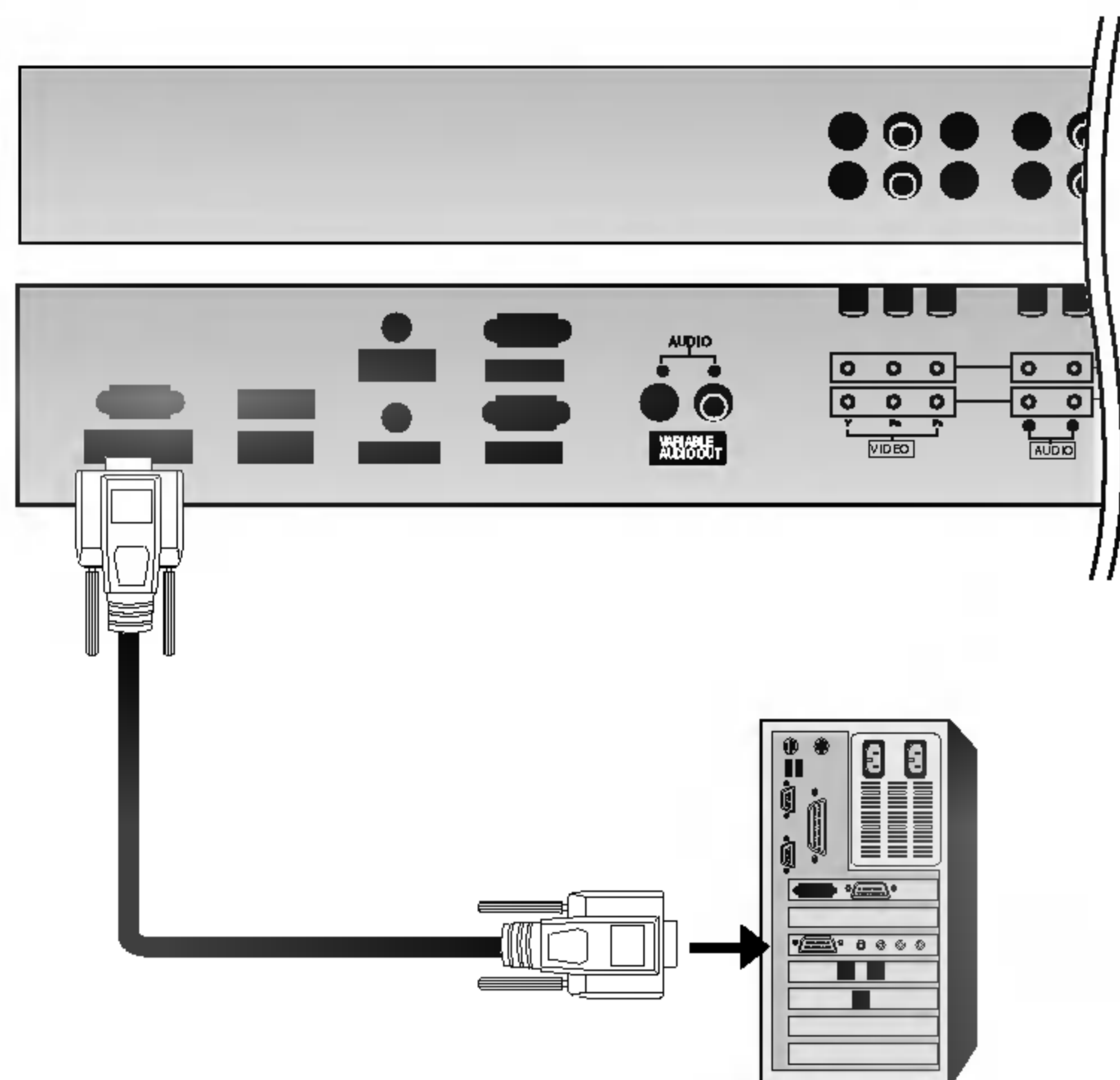

## Type of connector; D-Sub 9-pin male

No.	Pin name
1	No connection
2	RXD (Receive data)
3	TXD (Transmit data)
4	DTR (DTE side ready)
5	GND
6	DSR (DCE side ready)
7	RTS (Ready to send)
8	CTS (Clear to send)
9	No Connection

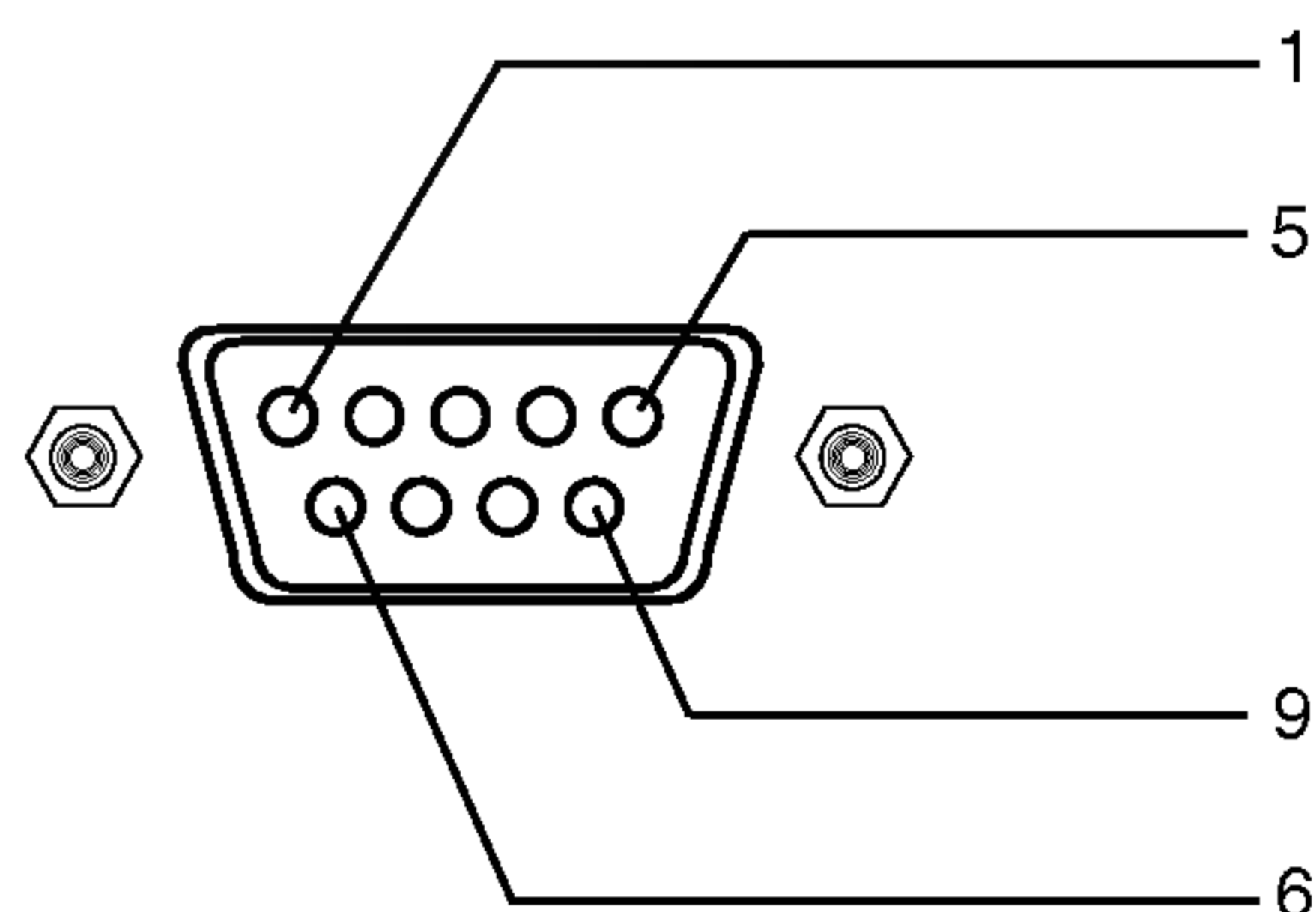

## RS-232C configurations

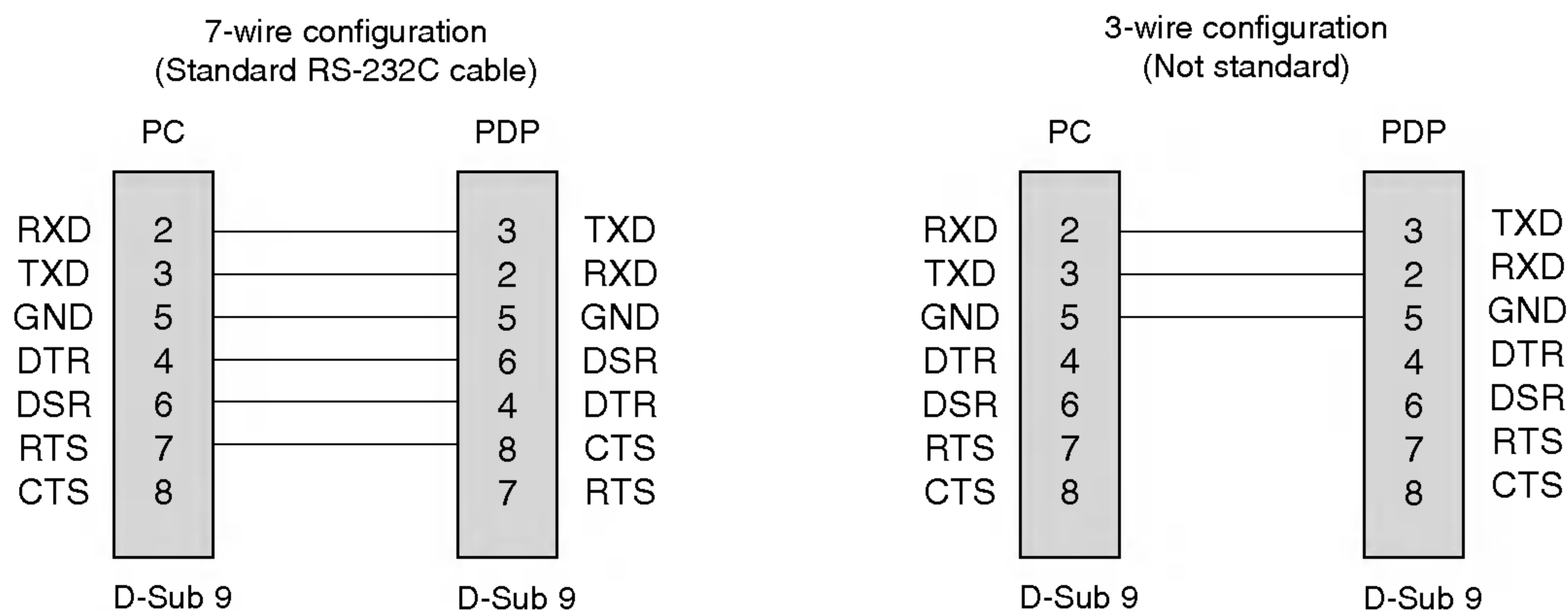

- Use this function to specify a monitor ID number.
- Refer to 'Real Data Mapping 1'. See page 54.

1. Press the **MENU** button and then use **▲ / ▼** button to select the **SPECIAL** menu.
2. Press the **▶** button and then use **▲ / ▼** button to select **Set ID**.
3. Press the **▶** button and then use **◀ / ▶** button to adjust **Set ID** to choose the desired monitor ID number. The adjustment range of **Set ID** is 1 ~ 99.
4. Press the **ENTER** button to save.

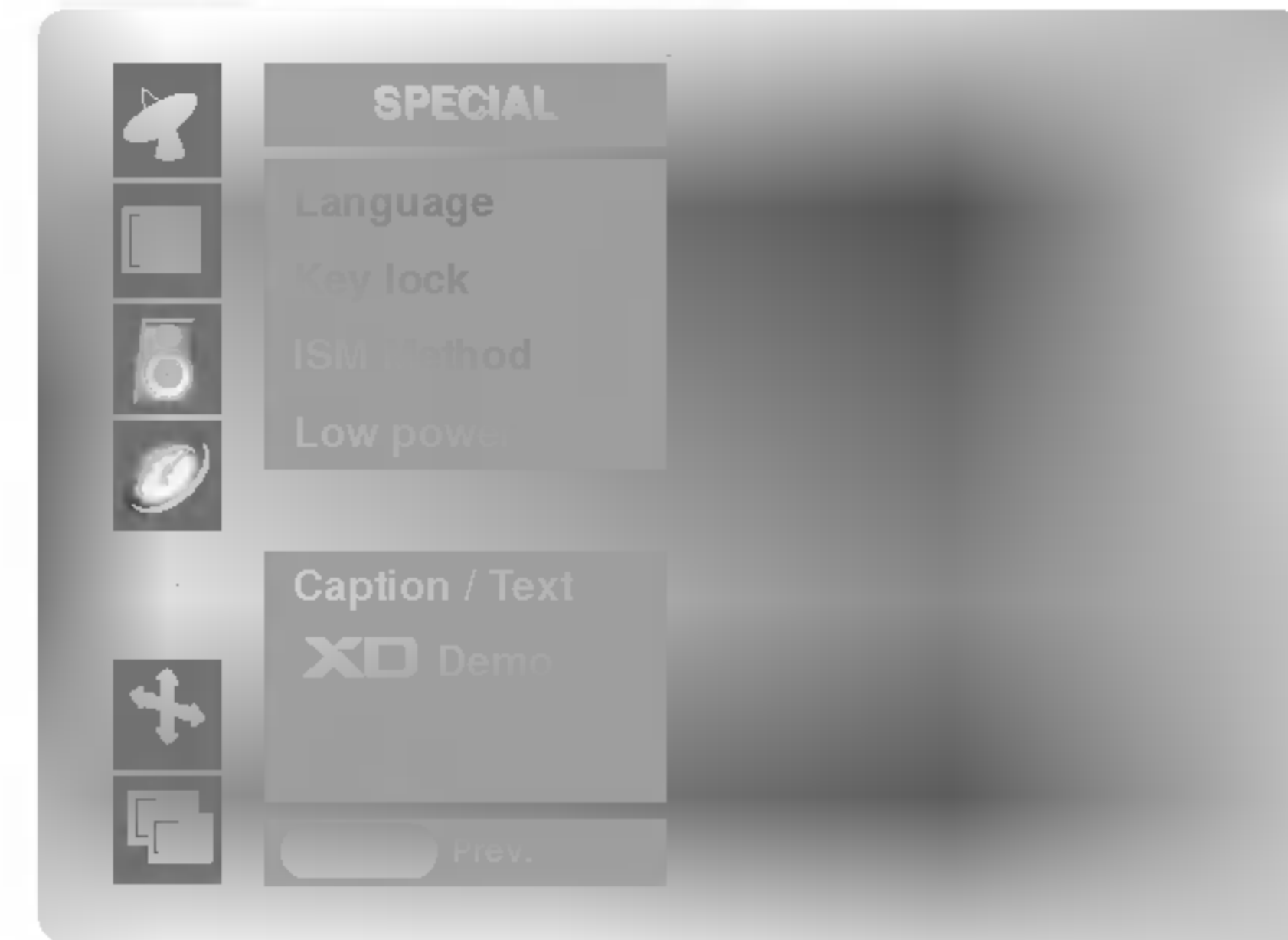

### Communication Parameters

- Baud rate : 9600 bps (UART)
- Data length : 8 bits
- Parity : None
- \* Use a crossed (reverse) cable.
- Stop bit : 1 bit
- Communication code : ASCII code

### Command Reference List

	COMMAND 1	COMMAND 2	DATA (Hexadecimal)
01. Power	k	a	0 ~ 1
02. Input Select	k	b	0 ~ 6
03. Aspect Ratio	k	c	Refer to p. 51
04. Screen Mute	k	d	0 ~ 1
05. Volume Mute	k	e	0 ~ 1
06. Volume Control	k	f	0 ~ 64
07. Contrast	k	g	0 ~ 64
08. Brightness	k	h	0 ~ 64
09. Color	k	i	0 ~ 64
10. Tint (option)	k	j	0 ~ 64
11. Sharpness	k	k	0 ~ 64
12. OSD Select	k	l	0 ~ 1
13. Remote control lock mode	k	m	0 ~ 1
14. PIP/DW	k	n	Refer to p. 52
15. PIP Position	k	q	0 ~ 3
16. Treble	k	r	0 ~ 64
17. Bass	k	s	0 ~ 64
18. Balance	k	t	0 ~ 64
19. Color Temperature (ACC)	k	u	0 ~ 3
20. Red Adjustment	k	v	0 ~ 50
21. Green Adjustment	k	w	0 ~ 50
22. Blue Adjustment	k	\$	0 ~ 50
23. PIP input Source	k	y	0 ~ 6
24. Abnormal Status	k	z	0 ~ a
25. ISM Method	j	p	0 ~ 3
26. Low Power	j	q	0 ~ 1
27. Orbiter Time Setting	j	r	1 ~ FE
28. Orbiter Pixel Setting	j	s	1 ~ 3
29. Picture Size	j	t	0 ~ 20
30. Auto Configure	j	u	1
31. Tune command	m	a	0 ~ 7D
32. Channel Add/Del	m	b	0 ~ 1
33. Key	m	c	Key Code
34. Input select (Main)	x	b	Refer to p. 55
35. Input select (PIP)	x	y	Refer to p. 55

\* When setting the 24 ~ 30, a menu doesn't display on screen.

### Transmission / Receiving Protocol

#### Transmission

[Command1][Command2][ ][Set ID][ ][Data][Cr]

- \* [Command 1] : First command to control PDP set.  
(j, k, m or x)
- \* [Command 2] : Second command to control PDP set.
- \* [Set ID] : You can adjust the set ID to choose desired monitor ID number in special menu.  
Adjustment range is 1 ~ 99.  
When selecting Set ID '0', every connected PDP set is controlled.  
Set ID is indicated as decimal (1~99) on menu and as Hexa decimal (0x0~0x63) on transmission/receiving protocol.
- \* [DATA] : To transmit command data.  
Transmit 'FF' data to read status of command.
- \* [Cr] : Carriage Return  
ASCII code '0x0D'
- \* [ ] : ASCII code 'space (0x20)'

#### OK Acknowledgement

[Command2][ ][Set ID][ ][OK][Data][x]

- \* The Monitor transmits ACK (acknowledgement) based on this format when receiving normal data. At this time, if the data is data read mode, it indicates present status data. If the data is data write mode, it returns the data of the PC computer.

#### Error Acknowledgement

[Command2][ ][Set ID][ ][NG][Data][x]

- \* The Monitor transmits ACK (acknowledgement) based on this format when receiving abnormal data from non-viable functions or communication errors.

- Data 1: Illegal Code  
2: not support function  
3: Wait more time

**01. Power (Command 2:a)**

- ▶ To control Power On/Off of the TV.

Transmission

```
[k][a][ ][Set ID][ ][Data][Cr]
```

Data 0 : Power Off                      1 : Power On

Ack

```
[a][ ][Set ID][ ][OK][Data][x]
```

- ▶ To show Power On/Off.

Transmission

```
[k][a][ ][Set ID][ ][FF][Cr]
```

Ack

```
[a][ ][Set ID][ ][OK][Data][x]
```

\* In like manner, if other functions transmit '0xFF' data based on this format, Acknowledgement data feed back presents status about each function.

**02. Input Select (Command 2 : b)**

- ▶ To select input source for the TV.  
You can also select an input source using the TV/VIDEO button on the Monitor's remote control.

Transmission

```
[k][b][ ][Set ID][ ][Data][Cr]
```

Data 0 : RGB                              4 : Component1  
1 : HDMI                                  5 : Component2  
2 : Video1                                6 : TV  
3 : Video2

Ack

```
[b][ ][Set ID][ ][OK][Data][x]
```

**03. Aspect Ratio (Command 2 : c) (Main Picture Size)**

- ▶ To adjust the screen format. (Main picture format)  
You can also adjust the screen format using the ARC (Aspect Ratio Control) button on remote control or in the SCREEN menu.

Transmission

```
[k][c][ ][Set ID][ ][Data][Cr]
```

Data 1 : Normal screen (4:3)  
2 : Wide screen (16:9)  
3 : Horizon  
4 : Zoom

Ack

```
[c][ ][Set ID][ ][OK][Data][x]
```

\* Using the PC input, you select either 16:9 or 4:3 screen aspect ratio.

**04. Screen Mute (Command 2 : d)**

- ▶ To select screen mute on/off.

Transmission

```
[k][d][ ][Set ID][ ][Data][Cr]
```

Data 0 : Screen mute off (Picture on)  
1 : Screen mute on (Picture off)

Ack

```
[d][ ][Set ID][ ][OK][Data][x]
```

**05. Volume Mute (Command 2 : e)**

- ▶ To control volume mute on/off.  
You can also adjust mute using the MUTE button on remote control.

Transmission

```
[k][e][ ][Set ID][ ][Data][Cr]
```

Data 0 : Volume mute off (Volume on)  
1 : Volume mute on (Volume off)

Ack

```
[e][ ][Set ID][ ][OK][Data][x]
```

**06. Volume Control (Command 2 : f)**

- ▶ To adjust volume.  
You can also adjust volume with the volume buttons on remote control.

Transmission

```
[k][f][ ][Set ID][ ][Data][Cr]
```

Data Min : 0 ~ Max : 64

\* Refer to 'Real data mapping 1'. See page 54.

Ack

```
[f][ ][Set ID][ ][OK][Data][x]
```

**07. Contrast (Command 2 : g)**

- ▶ To adjust screen contrast.  
You can also adjust contrast in the PICTURE menu.

Transmission

```
[k][g][ ][Set ID][ ][Data][Cr]
```

Data Min : 0 ~ Max : 64

\* Refer to 'Real data mapping 1'. See page 54.

Ack

```
[g][ ][Set ID][ ][OK][Data][x]
```

**08. Brightness (Command 2 : h)**

- ▶ To adjust screen brightness.  
You can also adjust brightness in the PICTURE menu.

Transmission

```
[k][h][ ][Set ID][ ][Data][Cr]
```

Data Min : 0 ~ Max : 64

\* Refer to 'Real data mapping 1'. See page 54.

Ack

```
[h][ ][Set ID][ ][OK][Data][x]
```

**09. Color (Command 2 : i)**

- ▶ To adjust the screen color.  
You can also adjust color in the PICTURE menu.

Transmission

```
[k][i][ ][Set ID][ ][Data][Cr]
```

Data Min : 0 ~ Max : 64  
\* Refer to 'Real data mapping 1'. See page 54.

Ack

```
[i][ ][Set ID][ ][OK][Data][x]
```

**10. Tint (Command 2 : j) (option)**

- ▶ To adjust the screen tint.  
You can also adjust tint in the PICTURE menu.

Transmission

```
[k][j][ ][Set ID][ ][Data][Cr]
```

Data Red : 0 ~ Green : 64  
\* Refer to 'Real data mapping 1'. See page 54.

Ack

```
[j][ ][Set ID][ ][OK][Data][x]
```

**11. Sharpness (Command 2 : k)**

- ▶ To adjust the screen sharpness.  
You can also adjust sharpness in the PICTURE menu.

Transmission

```
[k][k][ ][Set ID][ ][Data][Cr]
```

Data Min : 0 ~ Max : 64  
\* Refer to 'Real data mapping 1'. See page 54.

Ack

```
[k][ ][Set ID][ ][OK][Data][x]
```

**12. OSD Select (Command 2 : l)**

- ▶ To select OSD (On Screen Display) on/off when controlling remotely.

Transmission

```
[k][l][ ][Set ID][ ][Data][Cr]
```

Data 0 : OSD off                    1 : OSD on

Ack

```
[l][ ][Set ID][ ][OK][Data][x]
```

**13. Remote control lock mode (Command 2 : m)**

- ▶ To lock the front panel controls on the monitor and remote control.

Transmission

```
[k][m][ ][Set ID][ ][Data][Cr]
```

Data 0 : Lock off                    1 : Lock on

Ack

```
[m][ ][Set ID][ ][OK][Data][x]
```

\* If you're not using the remote control, use this mode.  
When main power is on/off, external control lock is released.

**14. PIP / DW (Command 2 : n)**

- ▶ To control the PIP (Picture In picture)/DW.  
You can also control the PIP/DW using the PIP button on the remote control or in the PIP/DW menu.

Transmission

```
[k][n][ ][Set ID][ ][Data][Cr]
```

Data 0: PIP/DW off                    3: DW2  
1: PIP                                    5: POP  
2: DW1

Ack

```
[n][ ][Set ID][ ][OK][Data][x]
```

**15. PIP Position (Command 2 : q)**

- ▶ To select sub picture position for PIP.  
You can also adjust the sub picture position using POSITION button on the remote control or in the PIP/DW menu.

Transmission

```
[k][q][ ][Set ID][ ][Data][Cr]
```

Data 0 : Right down on screen  
1 : Left down on screen  
2 : Left up on screen  
3 : Right up on screen

Ack

```
[q][ ][Set ID][ ][OK][Data][x]
```

**16. Treble (Command 2 : r)**

- ▶ To adjust treble.  
You can also adjust treble in the SOUND menu.

Transmission

```
[k][r][ ][Set ID][ ][Data][Cr]
```

Data Min : 0 ~ Max : 64  
\* Refer to 'Real data mapping 1'. See page 54.

Ack

```
[r][ ][Set ID][ ][OK][Data][x]
```

**17. Bass (Command 2 : s)**

- ▶ To adjust bass.  
You can also adjust bass in the SOUND menu.

Transmission

```
[k][s][ ][Set ID][ ][Data][Cr]
```

Data Min : 0 ~ Max : 64  
\* Refer to 'Real data mapping 1'. See page 54.

Ack

```
[s][ ][Set ID][ ][OK][Data][x]
```

**18. Balance (Command 2 : t)**

- ▶ To adjust balance.  
You can also adjust balance in the SOUND menu.

Transmission

```
[k][t][ ][Set ID][ ][Data][Cr]
```

Data Min : 0 ~ Max : 64  
\* Refer to 'Real data mapping 1'. See page 54.

Ack

```
[t][ ][Set ID][ ][OK][Data][x]
```

**19. Color Temperature (Command 2 : u)**

- ▶ To adjust color temperature.  
You can also adjust ACC in the PICTURE menu.

Transmission

```
[k][u][ ][Set ID][ ][Data][Cr]
```

Data 0: Cool 1: Normal 2: Warm 3: User

Ack

```
[u][ ][Set ID][ ][OK][Data][x]
```

**20. Red Adjustment (Command 2 : v)**

- ▶ To adjust red in color temperature.

Transmission

```
[k][v][ ][Set ID][ ][Data][Cr]
```

Data Min : 0 ~ Max : 50  
\* Refer to 'Real data mapping 2'. See page 54.

Ack

```
[v][ ][Set ID][ ][OK][Data][x]
```

**21. Green Adjustment (Command 2 : w)**

- ▶ To adjust green in color temperature.

Transmission

```
[k][w][ ][Set ID][ ][Data][Cr]
```

Data Min : 0 ~ Max : 50  
\* Refer to 'Real data mapping 2'. See page 54.

Ack

```
[w][ ][Set ID][ ][OK][Data][x]
```

**22. Blue Adjustment (Command 2 : \$)**

- ▶ To adjust blue in color temperature.

Transmission

```
[k][$][ ][Set ID][ ][Data][Cr]
```

Data Min : 0 ~ Max : 50  
\* Refer to 'Real data mapping 2'. See page 54.

Ack

```
[$][ ][Set ID][ ][OK][Data][x]
```

**23. PIP Input Select (Command 2 : y)**

- ▶ To select input source for sub picture in PIP/DW picture mode. You can also adjust input source for sub picture using PIP INPUT button on remote control.

Transmission

```
[k][y][ ][Set ID][ ][Data][Cr]
```

Data 0 : RGB	4 : Component1
1 : HDMI	5 : Component2
2 : Video1	6 : TV
3 : Video2	

Ack

```
[y][ ][Set ID][ ][OK][Data][x]
```

**24. Abnormal State (Command 2 : z)**

- ▶ To recognize an abnormal state.

Transmission

```
[k][z][ ][Set ID][ ][FF][Cr]
```

Data FF : Read

Ack

```
[z][ ][Set ID][ ][OK][Data][x]
```

Data 0: Normal (Power on and signal exist)  
1: No signal (Power on)  
2: Turn the TV off by remote control  
3: Turn the TV off by sleep time function  
4: Turn the TV off by RS-232C function  
5: 5V down  
6: AC down  
7: Turn the TV off by Fan Alarm function (option)  
8: Turn the TV off by Off time function  
9: Turn the TV off by Auto sleep function  
a: Turn the TV off by AV board detect

\* This function is "read only".

**25. ISM Method (Command 1 : j, Command 2 : p)**

- ▶ To control the ISM method. You can also adjust ISM Method in SPECIAL menu.

Transmission

```
[j][p][ ][Set ID][ ][Data][Cr]
```

Data 0 : Normal Mode	2 : Orbiter
1 : White Wash	3 : Inversion

Ack

```
[p][ ][Set ID][ ][OK][Data][x]
```

**26. Low Power**

(Command 1 : j, Command 2 : q)

- ▶ To reduce the power consumption of the TV. You can also adjust Low Power in SPECIAL menu.

Transmission

```
[j][q][ ][Set ID][ ][Data][Cr]
```

Data 0 : Off  
1 : On

Ack

```
[q][ ][Set ID][ ][OK][Data][x]
```

**27. Orbiter Time Setting**

(Command 1 : j, Command 2 : r)

- ▶ To adjust orbiter operation time term.

Transmission

```
[j][r][ ][Set ID][ ][Data][Cr]
```

Data Min: 1 ~ Max: FE  
\* Refer to 'Real data mapping 1'.

Ack

```
[r][ ][Set ID][ ][OK][Data][x]
```

**28. Orbiter Pixel Setting**

(Command 1 : j, Command 2 : s)

- ▶ To adjust pixel number in orbiter function.

Transmission

```
[j][s][ ][Set ID][ ][Data][Cr]
```

Data Min: 1 ~ Max: 3  
\* Refer to 'Real data mapping 1'.

Ack

```
[s][ ][Set ID][ ][OK][Data][x]
```

**29. Picture Size Setting for DW Mode**

(Command 1 : j, Command 2 : t)

- ▶ To select the DW picture format. You can also select the DW picture format using the SIZE on the remote control.

Transmission

```
[j][t][ ][Set ID][ ][Data][Cr]
```

Data Min: 0 ~ Max: 20  
\* Refer to 'Real data mapping 1'.

Ack

```
[t][ ][Set ID][ ][OK][Data][x]
```

**30. Auto Configure**

(Command 1 : j, Command 2 : u)

- ▶ To adjust picture position and minimize image shaking automatically. It works only in RGB (PC) mode.

Transmission

```
[j][u][ ][Set ID][ ][Data][Cr]
```

Data 1: To set

Ack

```
[u][ ][Set ID][ ][OK][Data][x]
```

**31. Tune Command**

(Command 1 : m, Command 2 : a)

- ▶ Tune Channel to following Physical number.

Transmission

```
[m][a][ ][Set ID][ ][Data0][ ][Data1][ ][Data2][ ][Data3][ ][Data4][ ][Data5][Cr]
```

Data0 Min: 0 ~ Max: 7D  
Data1~4 Don't care  
Data5 High -> Main channel: 0 Sub channel: 8  
Low -> Air : 0, CATV : 1

Ack

```
[a][ ][Set ID][ ][OK][Data0][ ][Data1][ ][Data2][ ][Data3][ ][Data4][ ][Data5][x]
```

**32. Channel Add/Del**

(Command 1 : m, Command 2 : b)

- ▶ To add and delete the channels.

Transmission

```
[m][b][ ][Set ID][ ][Data][Cr]
```

Data 0 : Channel Erase  
1 : Channel Memory

Ack

```
[b][ ][Set ID][ ][OK][Data][x]
```

<p>* Real data mapping 1</p> <p>0 : Step 0 ⋮ A : Step 10 (Set ID 10) ⋮ F : Step 15 (Set ID 15) 10 : Step 16 (Set ID 16) ⋮ 64 : Step 100 ⋮ 6E : Step 110 ⋮ 73 : Step 115 74 : Step 116 ⋮ C7 : Step 199</p>	<p>* Real data mapping 2</p> <p>0 : -40 1 : -39 2 : -38 ⋮ 28 : 0 ⋮ 4E : +38 4F : +39 50 : +40</p>
---	---

**33. Key**  
(Command 1 : m, Command 2 : c)

► To send IR remote key code.

Transmission

[m][c][ ][Set ID][ ][Data][Cr]

Data Key code - Refer to page 57.

Ack

[c][ ][Set ID][ ][OK][Data][x]

**34. Input select (Command 1 : x, Command 2 : b)**  
(Main Picture Input)

► To select input source for TV

Transmission

[x][b][ ][Set ID][ ][Data][Cr]

Data Structure

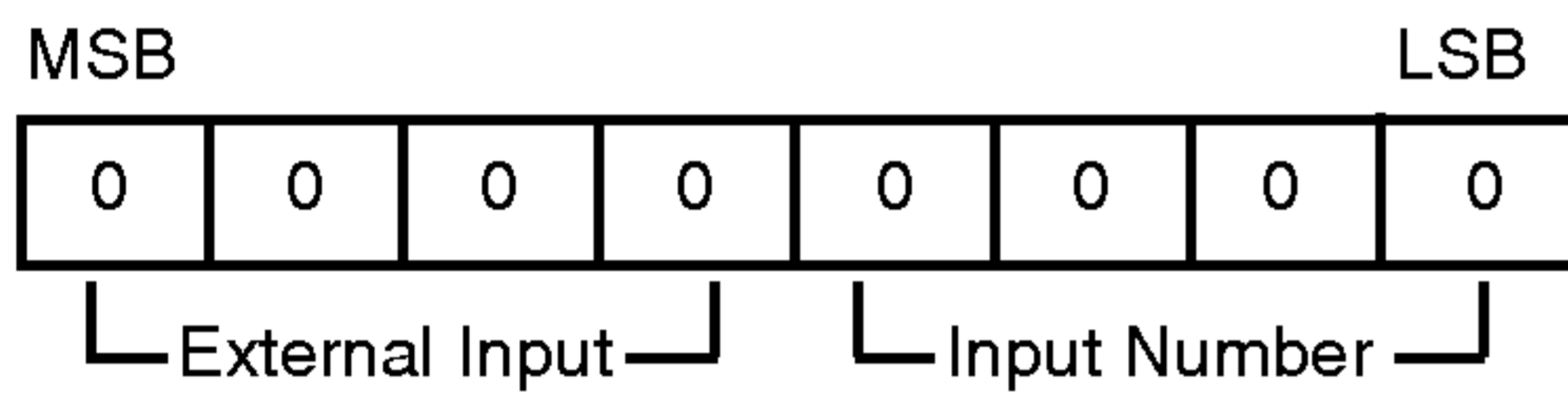

External Input				Data
0	0	0	1	Analog
0	0	1	0	Video
0	1	0	0	Component
0	1	0	1	RGB-DTV
0	1	1	0	RGB-PC
1	0	0	1	HDMI

Input Number				Data
0	0	0	0	Input1
0	0	0	1	Input2

Ack

[b][ ][Set ID][ ][OK][Data][x]

**35. Input select (Command 1 : x, Command 2 : y)**

► To adjust input source for sub picture in PIP mode.

Transmission

[x][y][ ][Set ID][ ][Data][Cr]

Data Structure

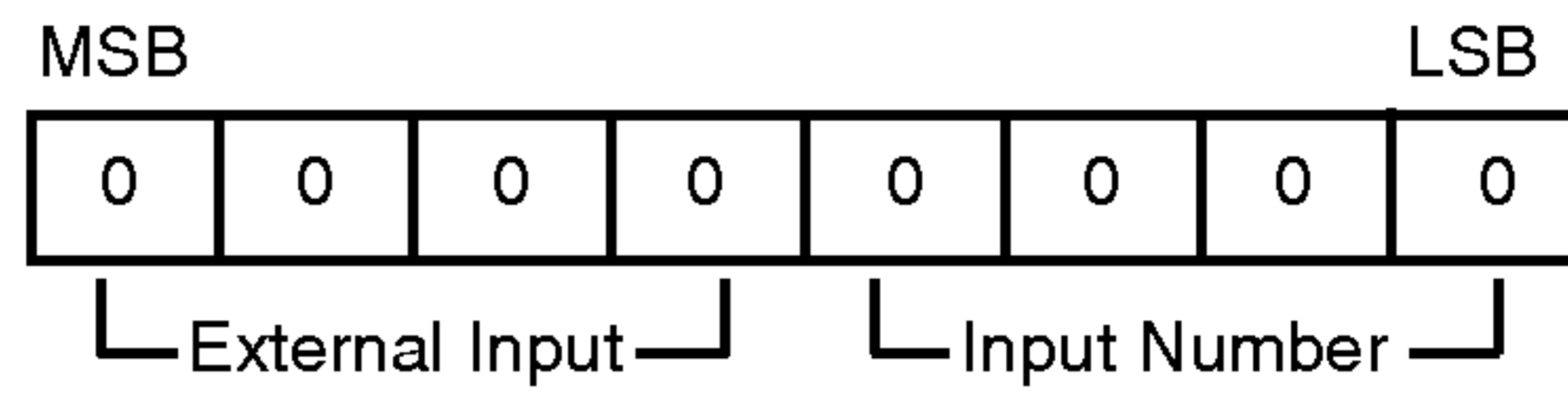

External Input				Data
0	0	0	1	Analog
0	0	1	0	Video
0	1	0	0	Component
0	1	0	1	RGB-DTV
0	1	1	0	RGB-PC
1	0	0	1	HDMI

Input Number				Data
0	0	0	0	Input1
0	0	0	1	Input2

Ack

[y][ ][Set ID][ ][OK][Data][x]

# IR Codes

▶ Connect your wired remote control to the Remote Control port on the Monitor.

▶ **Output waveform**

Single pulse, modulated with 37.917KHz signal at 455KHz

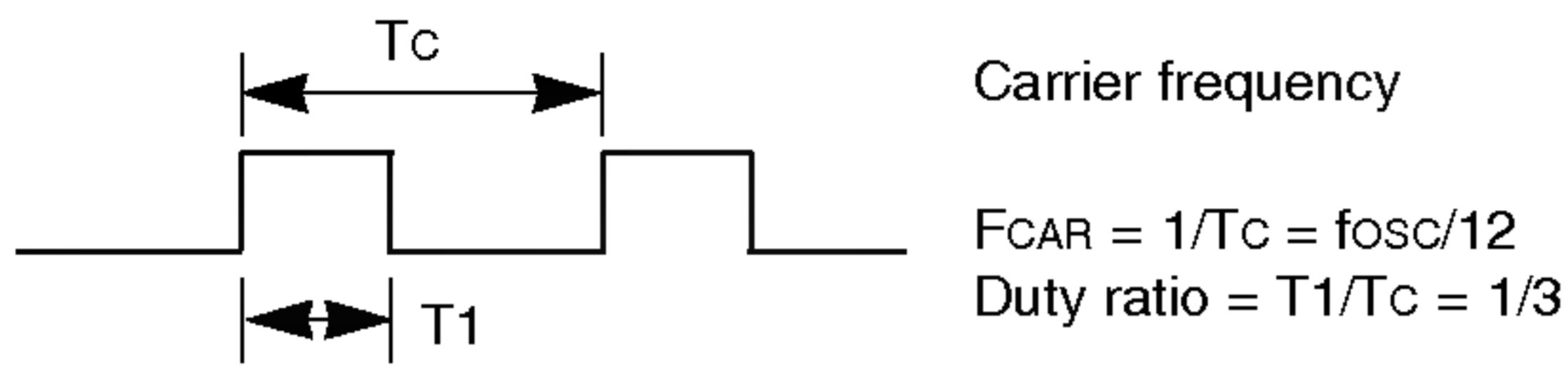

▶ **Configuration of frame**

• 1st frame

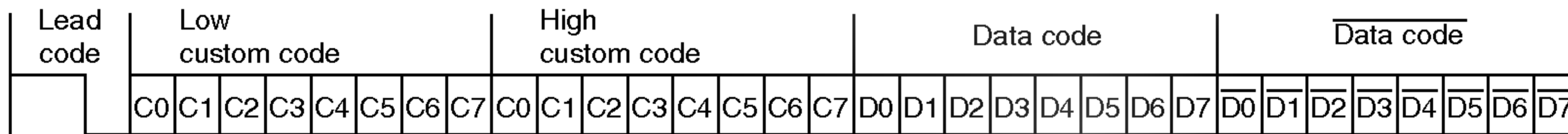

• Repeat frame

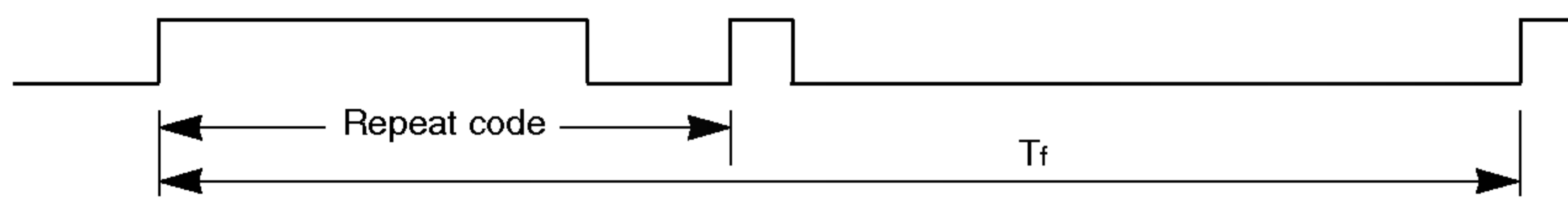

▶ **Lead code**

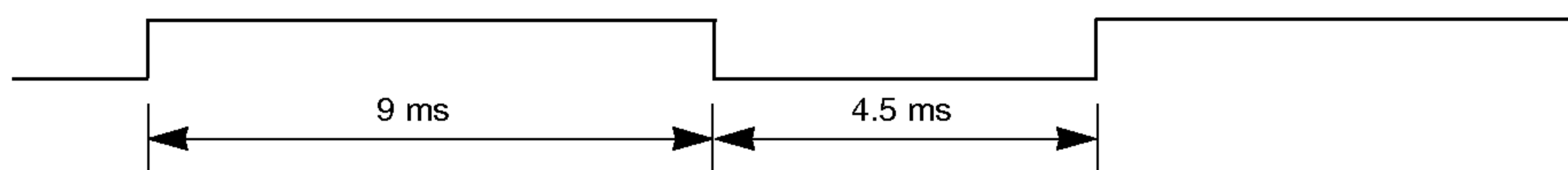

▶ **Repeat code**

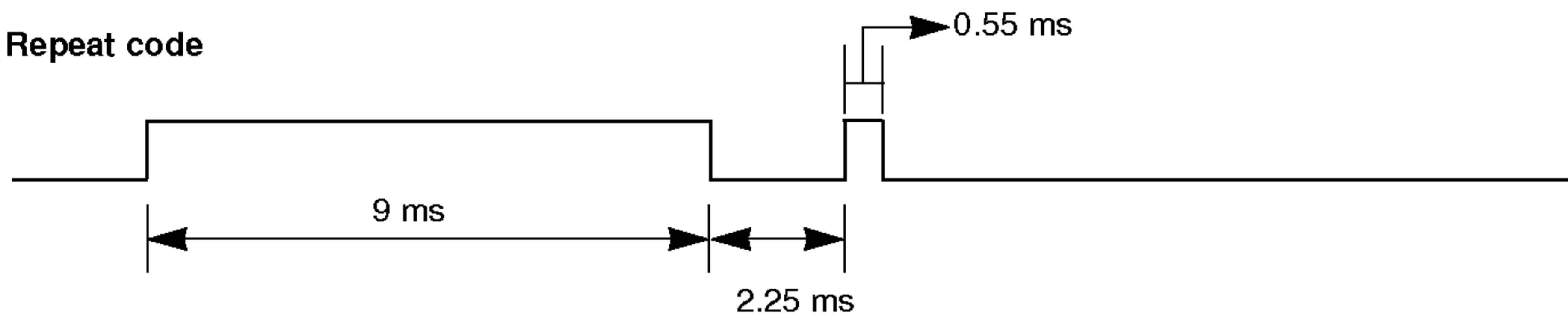

▶ **Bit description**

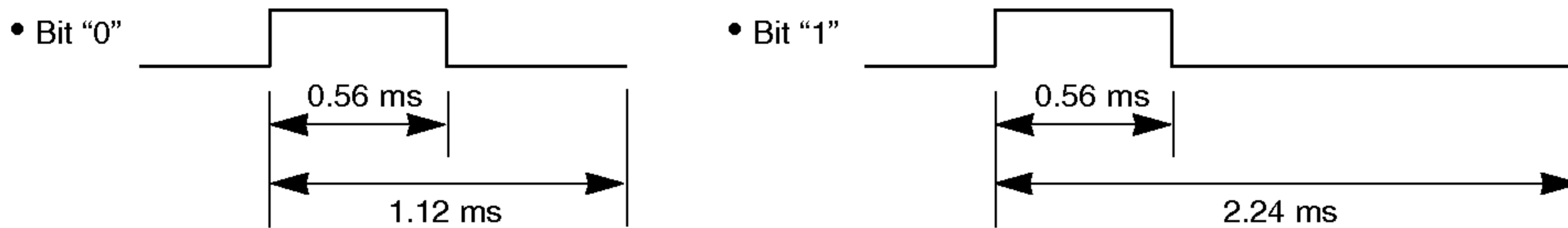

▶ **Frame interval : Tf**

The waveform is transmitted as long as a key is depressed.

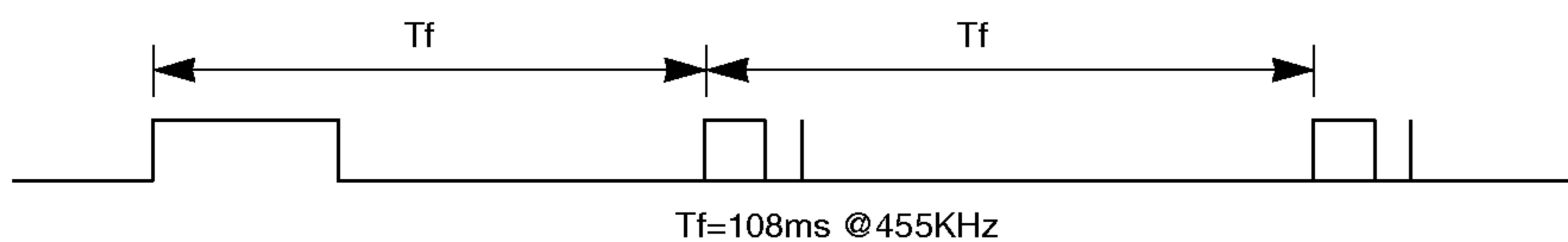

Code (Hexa)	Function	Note
00	CH (▲)	R/C Button
01	CH (▼)	R/C Button
02	VOL (▶)	R/C Button
03	VOL (◀)	R/C Button
40	▲	R/C Button
41	▼	R/C Button
06	▶	R/C Button
07	◀	R/C Button
08	POWER	R/C Button (Power On/Off)
C4	POWER ON	Discrete IR Code (Only Power On)
C5	POWER OFF	Discrete IR Code (Only Power Off)
09	MUTE	R/C Button
5B	EXIT	R/C Button
10	Number Key 0	R/C Button
11	Number Key 1	R/C Button
12	Number Key 2	R/C Button
13	Number Key 3	R/C Button
14	Number Key 4	R/C Button
15	Number Key 5	R/C Button
16	Number Key 6	R/C Button
17	Number Key 7	R/C Button
18	Number Key 8	R/C Button
19	Number Key 9	R/C Button
98	MULTIMEDIA	R/C Button
0B	TV/VIDEO	R/C Button
D6	TV	Discrete IR Code (Input TV Selection)
5A	VIDEO1	Discrete IR Code (Input VIDEO1 Selection)
D0	VIDEO2	Discrete IR Code (Input VIDEO2 Selection)
BF	COMPONENT1	Discrete IR Code (Input COMPONENT1 Selection)
D4	COMPONENT2	Discrete IR Code (Input COMPONENT2 Selection)
C6	HDMI	Discrete IR Code (Input HDMI Selection)
D5	RGB	Discrete IR Code (Input RGB Selection)
0E	SLEEP	R/C Button
43	MENU	R/C Button
44	ENTER	R/C Button
4D	APC	R/C Button
52	DASP	R/C Button
60	PIP	R/C Button
61	PIP INPUT	R/C Button
63	SWAP	R/C Button
64	SIZE	R/C Button
62	POSITION	R/C Button
71	PIP CH+	R/C Button
72	PIP CH-	R/C Button
5D	ZOOM -	R/C Button
5C	ZOOM +	R/C Button
79	ARC	R/C Button
76	ARC (4:3)	Discrete IR Code (Only 4:3 mode)
77	ARC (16:9)	Discrete IR Code (Only 16:9 mode)
AF	ARC (Zoom)	Discrete IR Code (Only Zoom mode)
1E	FCR	R/C Button
1A	REVIEW	R/C Button
54	AUTO PROGRAM	R/C Button
55	MEMORY/ERASE	R/C Button
0A	MTS	R/C Button
39	CAPTION	R/C Button
99	AUTO CONFIG	Discrete IR Code

# Programming the Remote

- ▶ The remote control is a multi-brand or a universal remote control. It can be programmed to operate most remote-controllable devices of other manufacturers.  
Note that the remote control may not control all models of other brands.

## Programming a code into a remote mode

1. Test your remote control.  
To find out whether your remote control can operate the component without programming, turn on the component such as a VCR and press the corresponding the desired component button on the remote control, while illuminating on the selected component. Test the **POWER** buttons to see if the component responds properly. If not, the remote requires programming to operate the device.
2. Turn on the component to be programmed, then press the corresponding the desired component button on the remote control.
3. Simultaneously, press the **MENU** and **MUTE** buttons for 2 seconds, the button selected component lights on the remote control.  
If you don't press any button for 20 seconds, the button selected component will turn off on the remote control. At a moment, you have to repeat from step 2.
4. There is a way to find the right code for the component.  
Enter a code number using the number buttons on the remote. When pressing the button, the light is blinked at a time. Programming code numbers for the corresponding component can be found on the following pages. Again, if the code is correct, the device will turn off.
5. Press the **MENU** button to store the code. After blinking twice, this code is stored.
6. Test the remote control functions to see if the component responds properly. If not, repeat from step 2.

# Programming Codes



Brand	Codes	Brand	Codes	Brand	Codes	Brand	Codes
AIWA	034	KENWOOD	014 034 039 043	PORTLAND	108	TATUNG	039 043
AKAI	016 043 046 124		047 048	PULSAR	072	TEAC	034 039 043
	125 146	LG (GOLDSTAR)	001 012 013 020	QUARTZ	011 014	TECHNICS	031 033 070
AMPRO	072		101 106 114 123	QUASAR	033 066 075 145	TEKNIKA	019 031 033 034
ANAM	031 033 103	LLOYD	034	RCA	013 020 033 034		101
AUDIO DYNAMICS	012 023 039 043	LXI	003 009 013 014		040 041 062 063	THOMAS	034
BROKSONIC	035 037 129		017 034 101 106		107 109 140 144	TMK	006
CANON	028 031 033	MAGIN	040		145 147	TOSHIBA	008 013 042 047
CAPEHART	108	MAGNAVOX	031 033 034 041	REALISTIC	003 008 010 014		059 082 112 131
CRAIG	003 040 135		067 068		031 033 034 040	TOTEVISION	040 101
CURTIS MATHES	031 033 041	MARANTZ	012 031 033 067		053 054 101	UNITECH	040
DAEWOO	005 007 010 064		069	RICO	058	VECTOR RESEARCH	012
	065 108 110 111	MARTA	101	RUNCO	148	VICTOR	048
	112 116 117 119	MATSUI	027 030	SALORA	014	VIDEO CONCEPTS	012 034 046
DAYTRON	108	MEI	031 033	SAMSUNG	032 040 102 104	VIDEOSONIC	040
DBX	012 023 039 043	MEMOREX	003 010 014 031		105 107 109 112	WARDS	003 013 017 024
DYNATECH	034 053		033 034 053 072		113 115 120 122		031 033 034 040
ELECTROHOME	059		101 102 134 139	SANSUI	125		053 054 131
EMERSON	006 017 025 027	MGA	045 046 059	SANYO	022 043 048 135	YAMAHA	012 034 039 043
	029 031 034 035	MINOLTA	013 020		003 007 010 014	ZENITH	034 048 056
	036 037 046 101	MITSUBISHI	013 020 045 046		102 134		058 072 080 101
	129 131 138 153		049 051 059 061	SCOTT	017 037 112 129		
FISHER	003 008 009 010		151		131		
FUNAI	034	MTC	034 040	SEARS	003 008 009 010		
GE	031 033 063 072	MULTITECH	024 034		013 014 017 020		
	107 109 144 147	NEC	012 023 039 043		031 042 073 081		
GO VIDEO	132 136		048		101		
HARMAN KARDON	012 045	NORDMENDE	043	SHARP	031 054 149		
HITACHI	004 018 026 034	OPTONICA	053 054	SHINTOM	024		
	043 063 137 150	PANASONIC	066 070 074 083	SONY	003 009 031 052		
INSTANTREPLAY	031 033		133 140 145		056 057 058 076		
JCL	031 033	PENTAX	013 020 031 033		077 078 149		
JCPENNY	012 013 015 033		063	SOUNDESIGN	034		
	040 066 101	PHILCO	031 034 067	STS	013		
JENSEN	043	PHILIPS	031 033 034 054	SYLVANIA	031 033 034 059		
JVC	012 031 033 043		067 071 101		067		
	048 050 055 060	PILOT	101	SYMPHONIC	034		
	130 150 152	PIONEER	013 021 048	TANDY	010 034		

Brand	Codes	Brand	Codes	Brand	Codes	Brand	Codes
ABC	003 004 039 042 046 052 053	GOLDEN CHANNEL	030		065 085 090	SPRUCER	047 078
AJIN	112	HAMLIN	049 050 055	PIONEER	034 051 052 063	STARCOM	002 004 008 009
ANTRONIK	014	HITACHI	052 055		076	STARGATE	008 030
ARCHER	005 007 014 024	HOSPITALITY	070 077	POST NEWS WEEK	016	TADIRAN	030
CABLE STAR	026	JERROLD	002 003 004 008	PRUCER	059	TAEKWANG	110
CENTURION	092		009 010 052 069	PTS	011 048 071 072	TAIHAN	105
CENTURY	007		074		073 074	TANDY	017
CITIZEN	007	LG (GOLDSTAR)	001 106 101 005	PULSAR	100	TEXSCAN	029
COLOUR VOICE	065 090	M-NET	037	RCA	047	TOCOM	039 040 056
COMBANO	080 081	MACOM	033	REGAL	049 050	TOSHIBA	100
COMTRONICS	019 030	MAGNAVOX	010 012 064 079	REGENCY	057	UNIKA	007 014 024
DIAMOND	023	MEMOREX	100	REMBRANT	025	UNITED CABLE	004 053
EAGLE	020 030 040	MOVIE TIME	028 032	SAMSUNG	102 107 030 068	UNIVERSAL	005 007 014 024
EASTERN	057 062 066	NSC	015 028 038 071	SCIENTIFIC ATLANTA	003 011 041 042		026 027 032 035
ELECTRICORD	032		073		043 045 046	VIEWSTAR	012 015 018 086
GE	072	OAK	016 031 037 053	SHERITECH	022		087 088 089
GEMINI	008 022 025 054	PANASONIC	044 047	SIGNAL	030	ZENITH	100 114 060 093
GI	052 074	PARAGON	100	SIGNATURE	052		
		PHILIPS	006 012 013 020	SL MARX	030		

Brand	Codes	Brand	Codes	Brand	Codes	Brand	Codes
ALPHASTAR DSR	123	FUJITSU	017 021 022 027	NEXTWAVE	028 124 125	STARCAST	041
AMPLICA	050		133 134	NORSAT	069 070	SUPER GUIDE	020 124 125
BIRDVIEW	051 126 129	GENERAL INSTRUMENT	003 004 016 029	PACE SKY SATELLITE	143	TEECOM	023 026 075 087
CHANNEL MASTER	013 014 015 018		031 059 101	PANASONIC	060 142		088 090 107 130
	036 055	HITACHI	139 140	PANSAT	121		137
CHAPARRAL	008 009 012 077	HOUSTON TRACKER	033 037 039 051	PERSONAL CABLE	117	TOSHIBA	002 127
CITOH	054		057 104	PHILIPS	071	UNIDEN	016 025 042 043
CURTIS MATHES	050 145	HUGHES	068	PICO	105		044 045 048 049
DRAKE	005 006 007 010	JANIEL	060 147	PRESIDENT	019 102		078 079 080 086
	011 052 112 116	JERROLD	061	PRIMESTAR	030 110 111		101 135 136
	141	KATHREIN	108	PROSAT	072	VIEWSTAR	115
DX ANTENNA	024 046 056 076	LEGEND	057	RCA	066 106	WINEGARD	128 146
ECHOSTAR	038 040 057 058	LG	001	REALISTIC	043 074	ZENITH	081 082 083 084
	093 094 095 096	LUTRON	132	SAMSUNG	123		091 120
	097 098 099 100	LUXOR	062 144	SATELLITE SERVICE CO	028 035 047 057		
	122	MACOM	010 059 063 064		085		
ELECTRO HOME	089		065	SCIENTIFIC ATLANTA	032 138		
EUROPLUS	114	MEMOREX	057	SONY	103		

Brand	Codes	Brand	Codes	Brand	Codes	Brand	Codes
AIWA	014 028 070 096 125 129 139 229	INKEL	152 153 154 155 157 158 159 160	MCS	104	SHARP	072 082 117 119
	230		189 207 222 224	MEMOREX	107		156 184 199 200
AKAI	163		225 226 227 243	NAD	046	SHERWOOD	206 209
ANAM	003 014 017 023		247	ONKYO	013 040 041 047		005 006 158
	059 106 189 216	JVC	004 013 141		048 056 057 132	SONY	044 045 109 114
	217 235 236	KEC	185 186 187		133 140		118 126 248 249
BURMECTER	252	KENWOOD	038 050 067 089	OPTIMUS	158	TAEKWANG	012 020 073 074
CARVER	086		170 171 197 206	PANASONIC	007 033 064 113		076 077 105 161
CLARION	199		215 222		142 220 241 251		162 163 164 165
DAEWOO	027 053 060 084	KOHEL	030	PENNEY	104		166 167 168 169
	102 148 198 221	NAD	045 046	PHILIPS	026 112 143		205 231 233 242
DENON	015 075 130 143	LOTTE	014 016 036 098	PIONEER	039 042 043 063	TEAC	010 085 106 136
FANTASIA	071		100 172 173 174		065 091 093 094		185 187 237
FINEARTS	022		175 176 177 178	QUASAR	113	TECHNICS	101 113 128 134
FISHER	089 099		179 180 181 183	RCA	080		147 218
LG(GOLDSTAR)	001 021 024 029		201 202 208 213	RCX	092	TOSHIBA	137
	087 107 108 110		214 219 223 232	REALISTIC	103 106	THE	061
	190 191 192 210		238 240	SAMSUNG	124 145 146 182	VICTOR	088 131
	211 212 239	LXI	103		193 194 195 203	WARDS	089
HAITAI	034 035 188 222	MAGNAVOX	111	SANSUI	011 135 138 144	YAMAHA	054 055 066 092
HARMAN/KARDON	068	MARANTZ	002 018 020 025	SANYO	019 083 234		199
INKEL	037 058 062 069		034 041 081 090	SCOTT	106 186		
	078 079 095 121	MCINTOSH	049	SHARP	031 032 051 052		
	122 149 150 151						

Brand	Codes	Brand	Codes	Brand	Codes	Brand	Codes
APEX DIGITAL	022	MAGNAVOX	013	PHILIPS	013	SONY	007
DENON	020 014	MARANTZ	024	PIONEER	004 026	THOMPSON	005 006
GE	005 006	MITSUBISHI	002	PROCEED	021	TOSHIBA	019 008
HARMAN KARDON	027	NAD	023	PROSCAN	005 006	YAMAHA	009 018
JVC	012	ONKYO	008 017	RCA	005 006	ZENITH	010 016 025
LG	001 010 016 025	PANASONIC	003 009	SAMSUNG	011 015		

# Troubleshooting Checklist

<p><b>No picture &amp; No sound</b></p>	<ul style="list-style-type: none"> <li>• Check whether the TV is turned on.</li> <li>• Is the power cord inserted into wall power outlet?</li> <li>• Test the wall power outlet, plug another product's power cord into the outlet where the TV's power cord was plugged in.</li> </ul>
<p><b>Picture OK &amp; No sound</b></p>	<ul style="list-style-type: none"> <li>• Press the <b>VOLUME</b> (▶) button.</li> <li>• Sound muted? Press <b>MUTE</b> button.</li> </ul>
<p><b>The remote control doesn't work</b></p>	<ul style="list-style-type: none"> <li>• Check to see if there is any object between the TV and the remote control causing obstruction.</li> <li>• Are batteries installed with correct polarity (+ to +, - to -)? (Refer to p.8)</li> <li>• Correct remote operating mode set: TV, VCR etc.?</li> <li>• Install new batteries. (Refer to p.8)</li> </ul>
<p><b>Picture appears slowly after switching on</b></p>	<ul style="list-style-type: none"> <li>• This is normal, the image is muted during the TV startup process. Please contact your service center, if the picture has not appeared after five minutes.</li> </ul>
<p><b>No or poor color or poor picture</b></p>	<ul style="list-style-type: none"> <li>• Select <b>Color</b> in the <b>PICTURE</b> menu and press the <b>VOLUME</b> (▶) button. (Refer to p.25)</li> <li>• Keep a sufficient distance between the TV and the VCR.</li> <li>• Activate any function to restore the brightness of the picture. (If still picture is on the screen for more than 5 minutes, the screen gets dark.)</li> </ul>
<p><b>Horizontal/vertical bars or picture shaking</b></p>	<ul style="list-style-type: none"> <li>• Check for local interference such as an electrical appliance or power tool.</li> </ul>
<p><b>No output from one of the speakers</b></p>	<ul style="list-style-type: none"> <li>• Adjust <b>Balance</b> in the <b>SOUND</b> menu. (Refer to p.27)</li> </ul>
<p><b>Unusual sound from inside the TV</b></p>	<ul style="list-style-type: none"> <li>• A change in ambient humidity or temperature may result in an unusual noise when the plasma display is turned on or off and does not indicate a fault with the TV.</li> </ul>

# Product Specifications

Width (inches / mm)	49.3 / 1252
Height (inches / mm)	27.8 / 705.5
Depth (inches / mm)	10.6 / 270.7
Weight (pounds / kg)	91 / 41.4
Resolution	1024 x 768 (Dot)
Power requirement	AC100-240V, 50/60Hz
Television System	NTSC, PAL-M/N
Program Coverage	VHF 2 ~ 13, UHF 14 ~ 69, CATV 1 ~ 125
External Antenna Impedance	75 $\Omega$
Operating Temperature Range	32 ~ 104°F (0 ~ 40°C)
Operating Humidity Range	Less than 80%

Width (inches / mm)	57.5 / 1461	57.5 / 1461
Height (inches / mm)	30.7 / 780	32.9 / 835
Depth (inches / mm)	13 / 331.3	13 / 332
Weight (pounds / kg)	128 / 58.2	130 / 58.8
Resolution	1366 x 768 (Dot)	1366 x 768 (Dot)
Power requirement	AC100-240V, 50/60Hz	
Television System	NTSC, PAL-M/N	
Program Coverage	VHF 2 ~ 13, UHF 14 ~ 69, CATV 1 ~ 125	
External Antenna Impedance	75 $\Omega$	
Operating Temperature Range	32 ~ 104°F (0 ~ 40°C)	
Operating Humidity Range	Less than 80%	

- The specifications shown above may be changed without notice for quality improvement.

