



# Digital LCD DVD Combo TV OWNER'S MANUAL

MODEL : KP-17LZ21

Please read this manual carefully before operating your set.  
Retain it for future reference.  
Record model number and serial number of the set.  
See the label attached on the back cover and quote this  
information to your dealer when you require service.



Internet Home Page <http://www.lge.com>  
<http://www.lge.com.br>

9828TUL287N (0407-REV00)

Printed in Korea

# Safety Instructions

**WARNING : TO REDUCE THE RISK OF FIRE OR ELECTRIC SHOCK, DO NOT EXPOSE THIS PRODUCT TO RAIN OR MOISTURE.**  
**CAUTION : TO REDUCE THE RISK OF ELECTRIC SHOCK, DO NOT REMOVE COVER(OR BACK). NO USER-SERVICEABLE PARTS IN SIDE. REFER SERVICING TO QUALIFIED SERVICE PERSONNEL.**

## Cleaning

Unplug this television receiver from the wall outlet before cleaning. Do not use liquid cleaners or aerosol cleaners. Use a damp cloth for cleaning.

Do not use attachments not recommended by the television receiver manufacturer as they may cause hazards.

## Power Supply

This television receiver should be operated only from the type of power source indicated on the marking label. If you are not sure of the type of power supplied to your home, consult your television dealer or local power company.

## Installation

Do not use this television receiver near water, for example, near a bathtub, washbowl, kitchen sink, or laundry tub, in a wet basement, or near a swimming pool, etc.

Do not place this television receiver on an unstable cart, stand, or table. The television receiver may fall, causing serious injury to a child or an adult, and serious damage to the appliance.

Use only with a cart or stand recommended by the manufacturer, or sold with the television receiver. Wall or shelf mounting should follow the manufacturer's instructions and should use a mounting kit approved by the manufacturer.

Slots and openings in the cabinet and the back or bottom are provided for ventilation, and to insure reliable operation of the television receiver, and to protect it from overheating. These openings must not be blocked or covered. The openings should never be blocked by placing the television receiver on a bed, sofa, rug, or other similar surface. This television receiver should not be placed in a builtin installation such as a bookcase unless proper ventilation is provided.

It is recommended not to operate this unit near speakers or big metallic furnitures in order to keep their magnetism from disturbing colors purity (uniformity) on the screen.

## Use

Do not allow anything to rest on the power cord. Do not locate this television receiver where the cord will be abused by persons walking on it.

Do not overload wall outlets and extension cords as this can result in fire or electric shock.

Never push objects of any kind into this television receiver through cabinet slots as they may touch dangerous voltage points or short out parts that could result in a fire or electric shock.

Never spill liquid of any kind on the television receiver.

## Service

Do not attempt to service this television yourself as opening or removing covers may expose you to dangerous voltage or other hazards. Refer all servicing to qualified personnel.

## Writing Model And Serial Numbers

The serial number and model number are found on the back of this unit. The serial number is unique to this unit. You should record requested information here and retain this guide as a permanent record of your purchase. Please retain your purchase receipt as your proof of purchase.

Date of Purchase \_\_\_\_\_  
Dealer Purchased from \_\_\_\_\_  
Dealer Address \_\_\_\_\_  
Dealer Phone No. \_\_\_\_\_  
Model No. \_\_\_\_\_  
Serial No. \_\_\_\_\_

# Contents

|   |      |  |              |
|---|------|--|--------------|
| Safety Instructions .....                       | 2    | Time Menu Options                              |              |
| <b>Introduction</b>                             |      | Clock Setup .....                              | 19           |
| Controls .....                                  | 4    | On/Off Timer Setup .....                       | 19           |
| Connection Options .....                        | 5    | Sleep Timer Setup .....                        | 19           |
| Remote Control Key Functions .....              | 6    | Special Menu Options                           |              |
| <b>Installation</b>                             |      | Closed Captions .....                          | 20           |
| Accessories .....                               | 7    | Caption .....                                  | 21           |
| Power Connections .....                         | 7    | Key Lock .....                                 | 21           |
| Installation Instruction .....                  | 8    | Auto Off .....                                 | 21           |
| External Equipment Connections .....            | 9~12 | RGB-PC Menu Options                            |              |
| Antenna Connection .....                        | 9    | Auto Config. Adjustment .....                  | 22           |
| VCR Setup .....                                 | 10   | Horizontal/Vertical Position Adjustments ..... | 22           |
| Cable TV Setup .....                            | 10   | Phase/Clock Adjustments .....                  | 22           |
| External A/V Source Setup .....                 | 10   | PIP (Picture-in-Picture) Feature               |              |
| DVD Setup .....                                 | 11   | Watching PIP/Double Window .....               | 23           |
| DTV Setup .....                                 | 11   | TV Program Selection for PIP .....             | 23           |
| Using Headphones .....                          | 11   | Using PIP Still Function .....                 | 23           |
| DVD Output Setup (Option) .....                 | 12   | PIP Size .....                                 | 23           |
| PC Setup .....                                  | 12   | Moving the PIP .....                           | 23           |
| <b>Operation</b>                                |      | Swapping the PIP .....                         | 24           |
| TV Operation Overview .....                     | 13   | Selecting an Input Signal Source for PIP ..... | 24           |
| Menu Language Selection .....                   | 13   | POP (Picture-Out-Picture: Channel Scan) .....  | 24           |
| Channel Menu Options                            |      | <b>Notes on Discs .....</b>                    | <b>25</b>    |
| Memorizing the Channels with Auto Program ..... | 14   | <b>DVD &amp; VCD Operation .....</b>           | <b>26~36</b> |
| Add/Delete Channels with Manual Program .....   | 14   | DVD Menu Options .....                         | 29~31        |
| Fine Tuning Adjustment .....                    | 14   | <b>MP3 Files Operation .....</b>               | <b>32</b>    |
| Favorite Channels Setup .....                   | 14   | <b>Audio CD Operation .....</b>                | <b>33</b>    |
| Picture Menu Options                            |      | <b>JPEG File Viewing Options .....</b>         | <b>34</b>    |
| APC (Auto Picture Control) .....                | 15   | <b>Product Specifications .....</b>            | <b>35</b>    |
| Manual Picture Control .....                    | 15   | <b>Troubleshooting Checklist .....</b>         | <b>36</b>    |
| Auto Color Control Adjustment .....             | 15   |  |              |
| Manual Color Temperature Control .....          | 16   |  |              |
| DRP (Digital Reality Picture) .....             | 16   |  |              |
| Picture Format Setup .....                      | 16   |  |              |
| Sound Menu Options                              |      |  |              |
| DASP (Digital Auto Sound Processing) .....      | 17   |  |              |
| Equalizer Adjustments .....                     | 17   |  |              |
| Sound Balance .....                             | 17   |  |              |
| AVL (Auto Volume Leveler) .....                 | 17   |  |              |
| Sound Selection in PC Mode .....                | 18   |  |              |
| Stereo/SAP Broadcasts Setup .....               | 18   |  |              |

After reading this manual, keep it handy for future reference.

# Introduction

## Controls

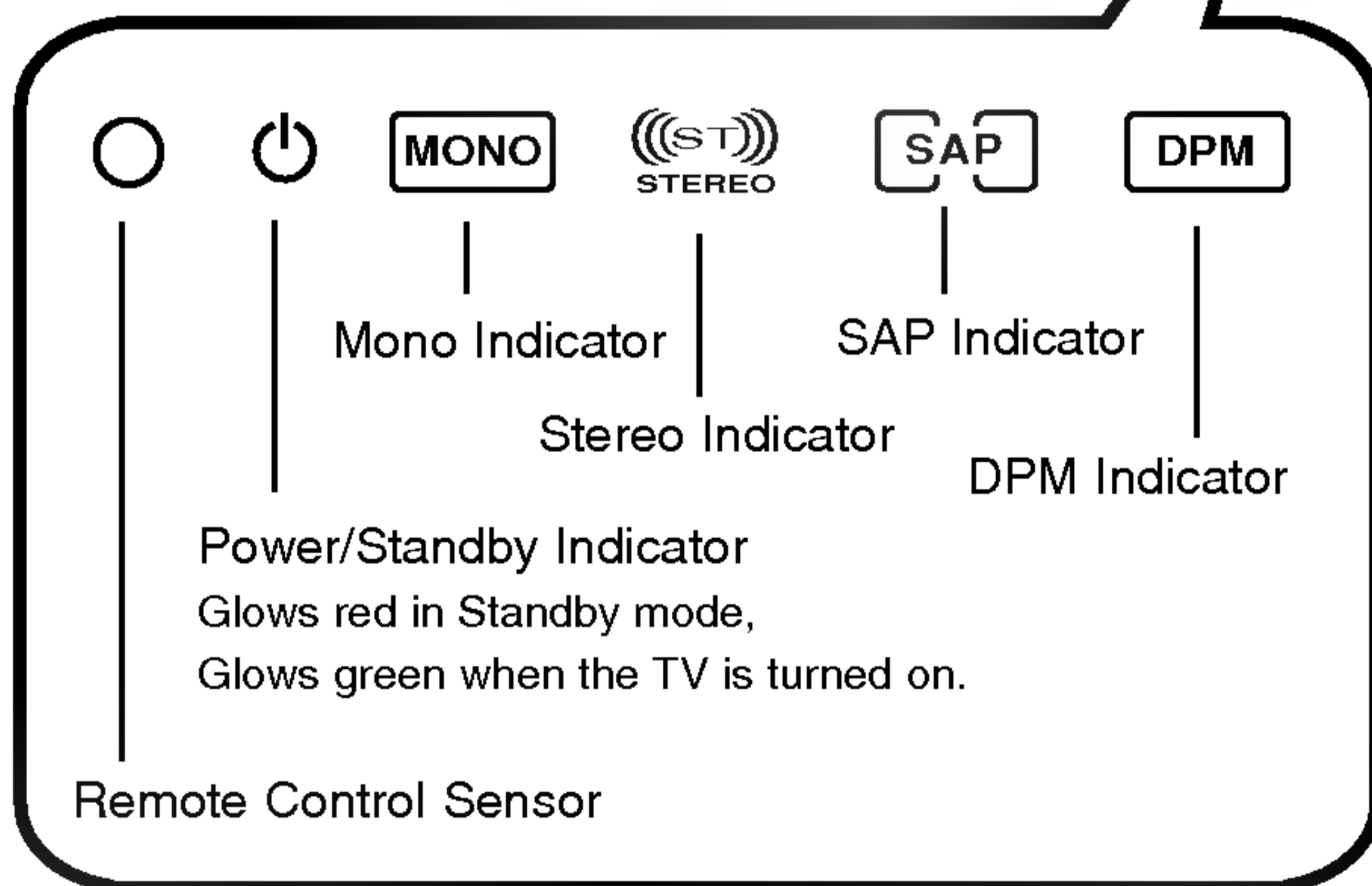
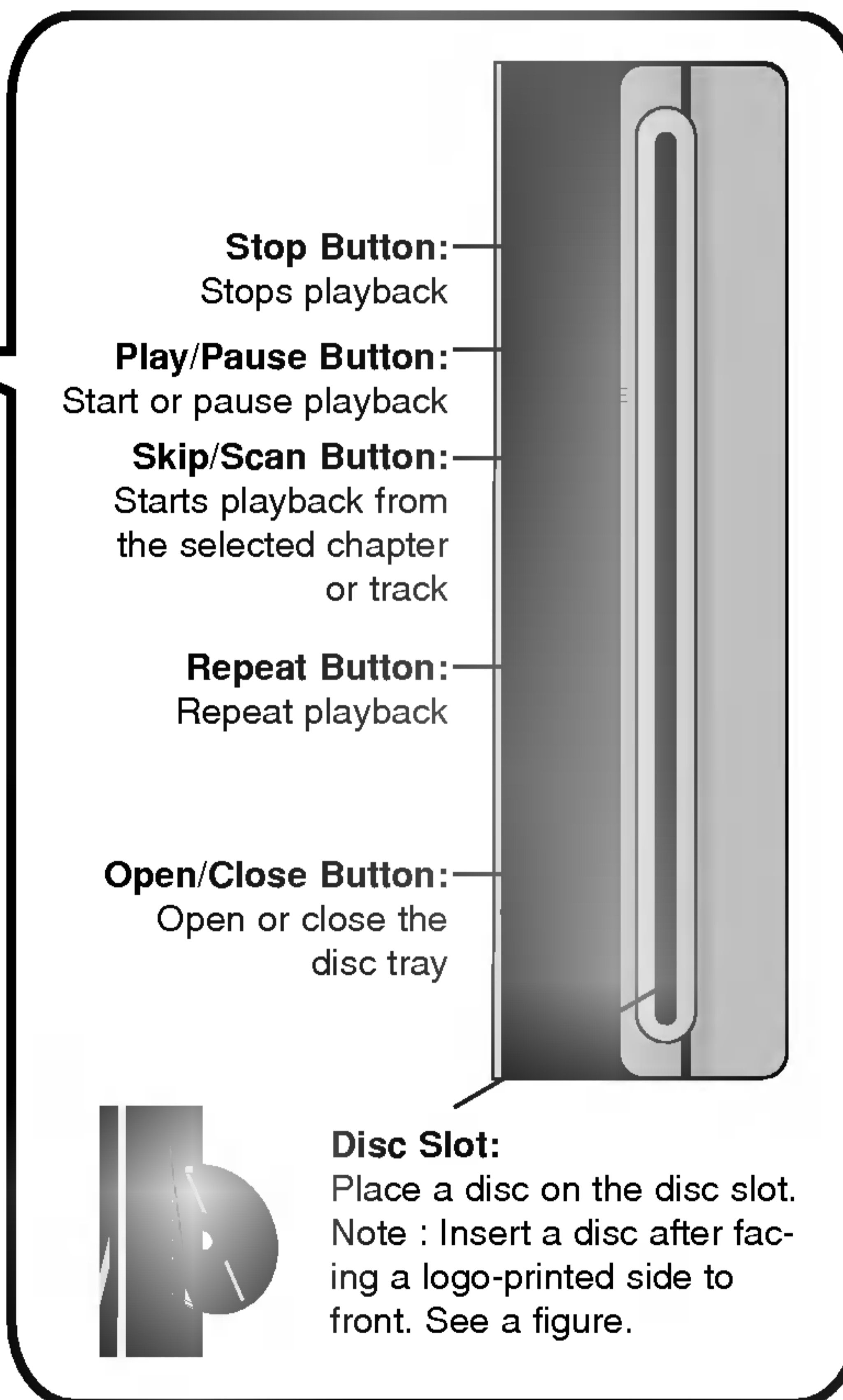
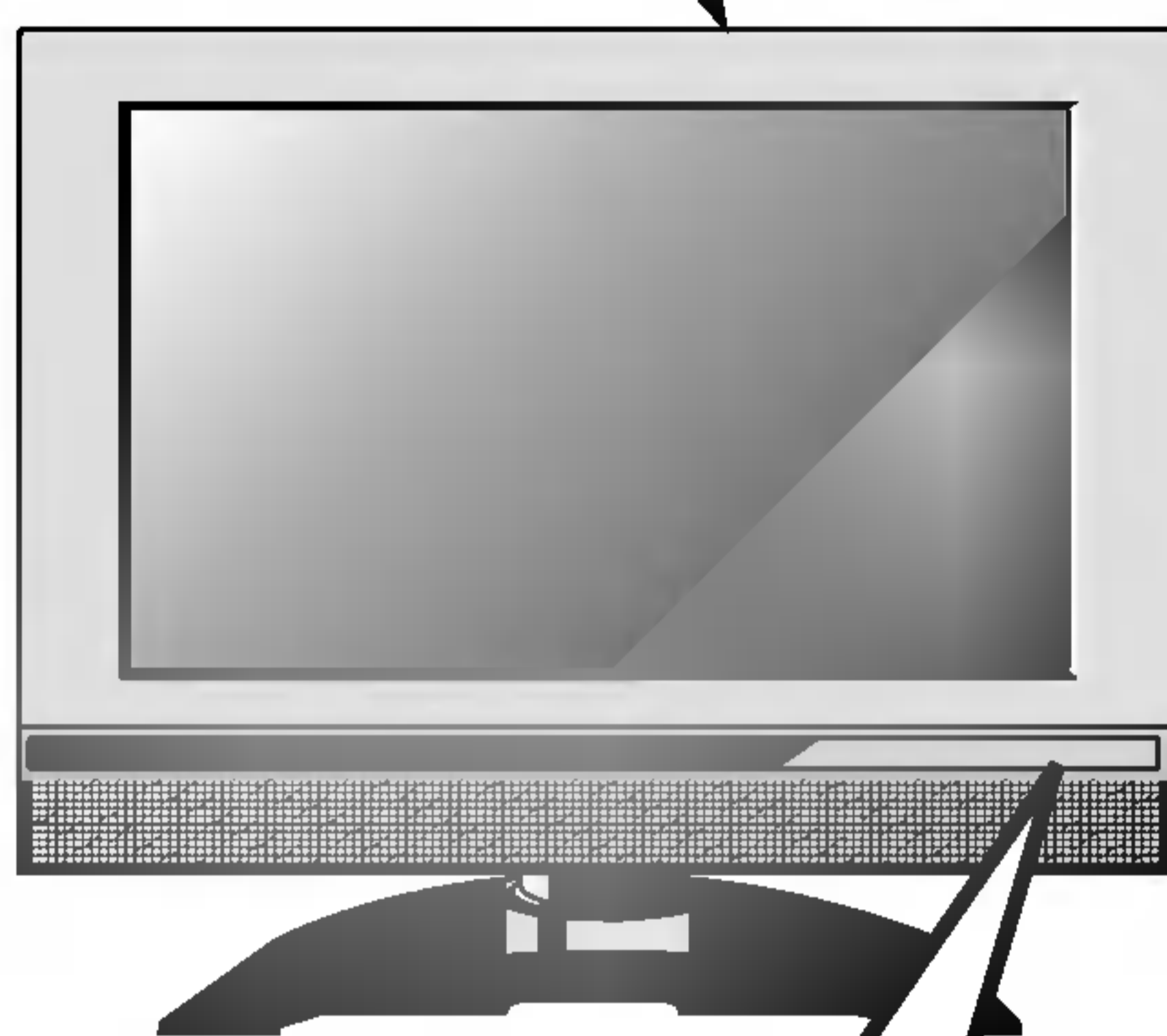
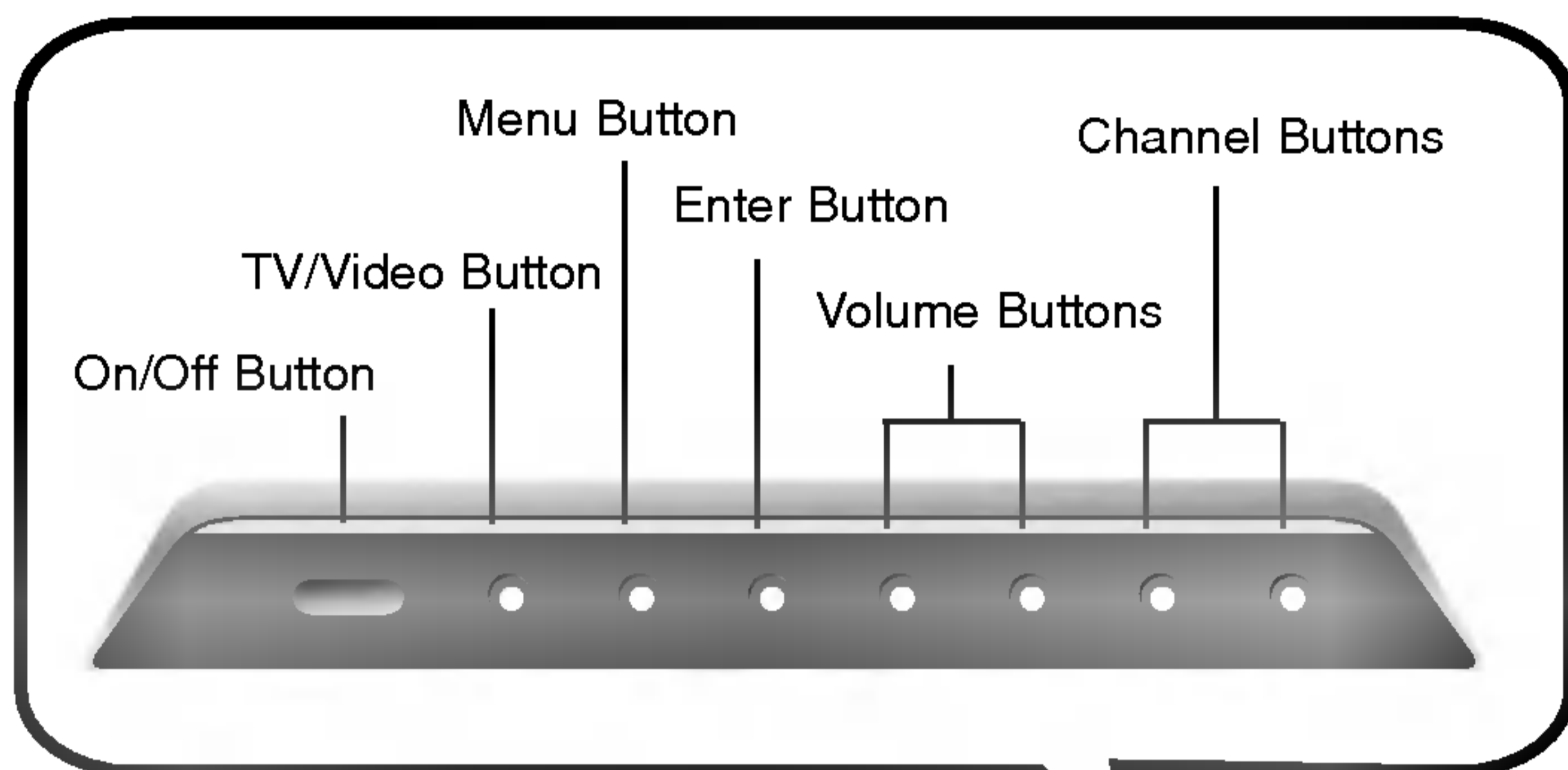

# Connection Options

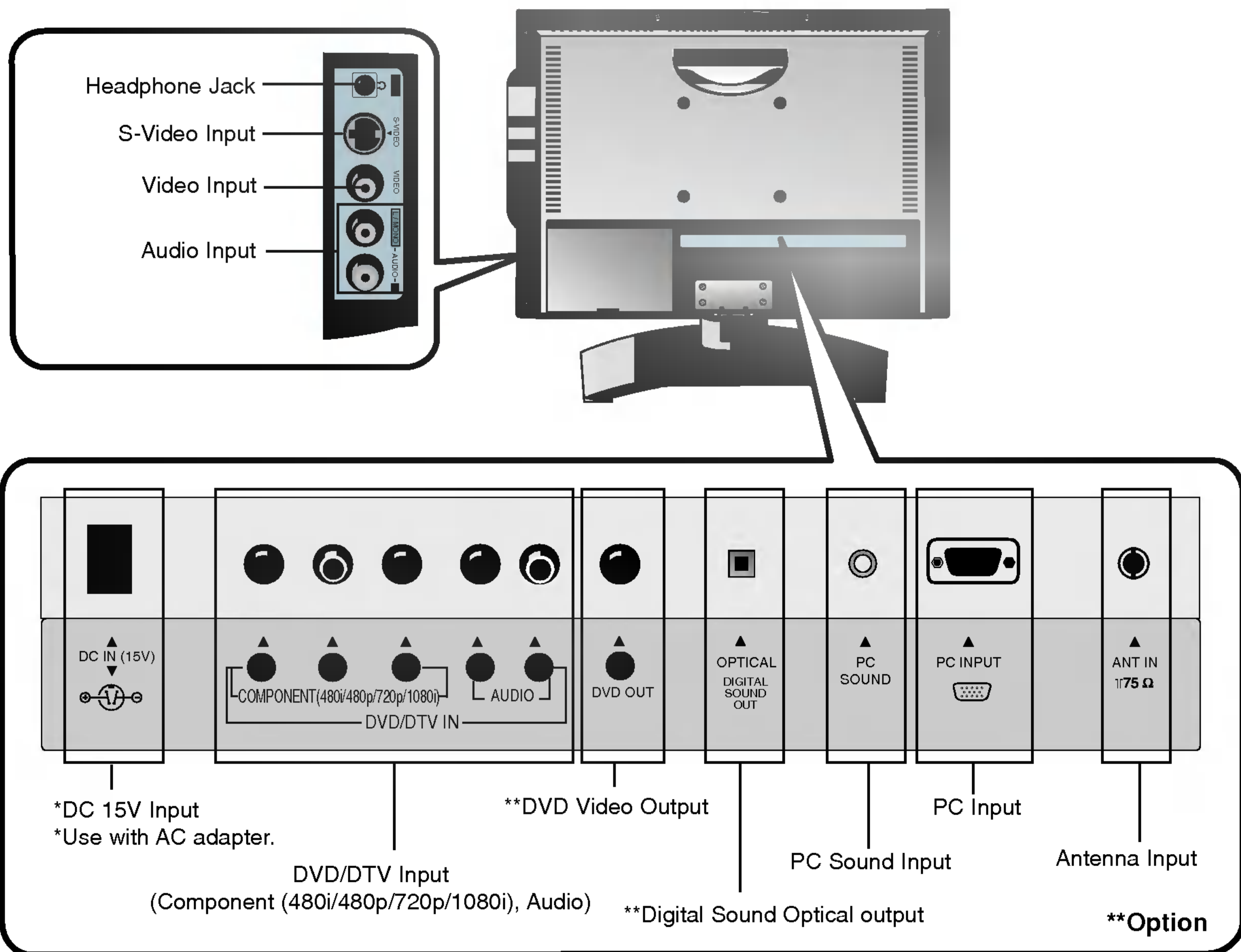

# Remote Control Key Functions

- When using the remote control, aim it at the remote control sensor on the TV.

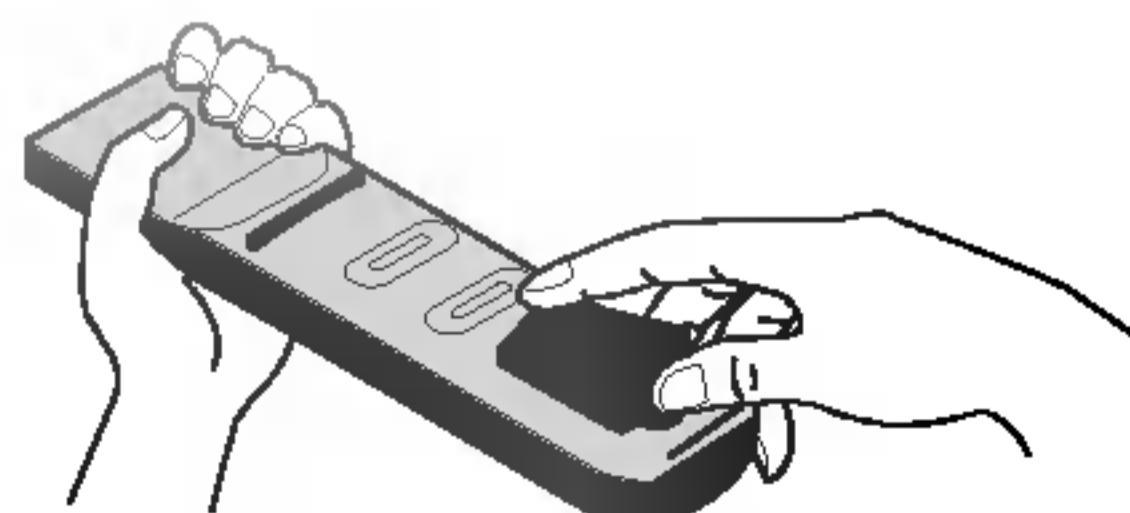
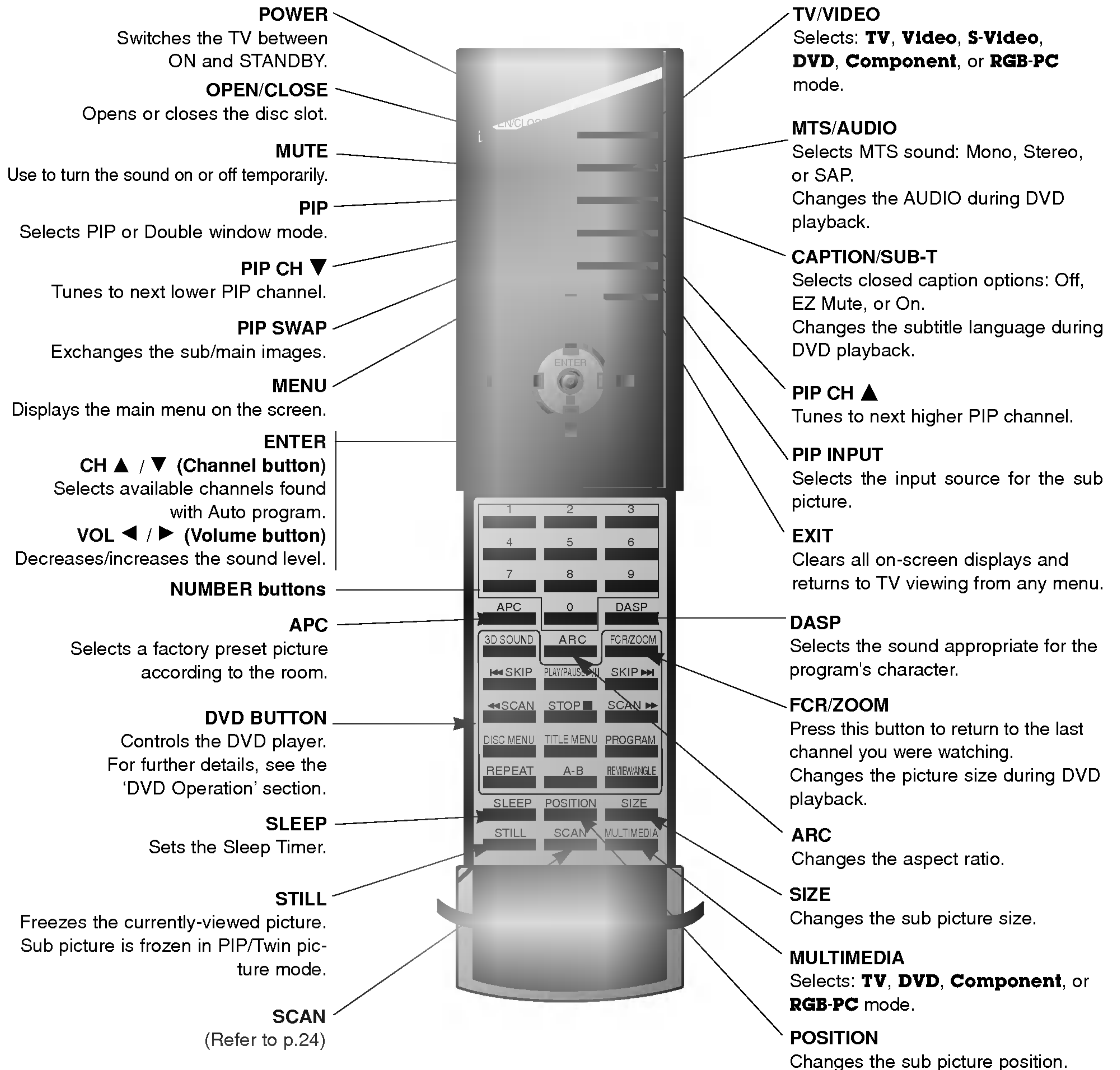

- Open the battery compartment cover on the back side and insert the batteries with correct polarity.
- Install two 1.5V batteries of AAA type. Don't mix used batteries with new batteries.

# Installation

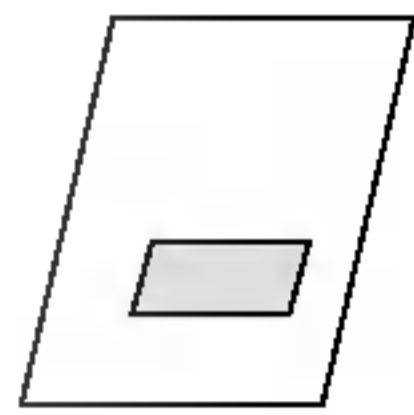

Operating Guide

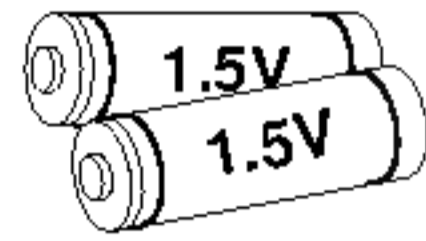

AAA Batteries

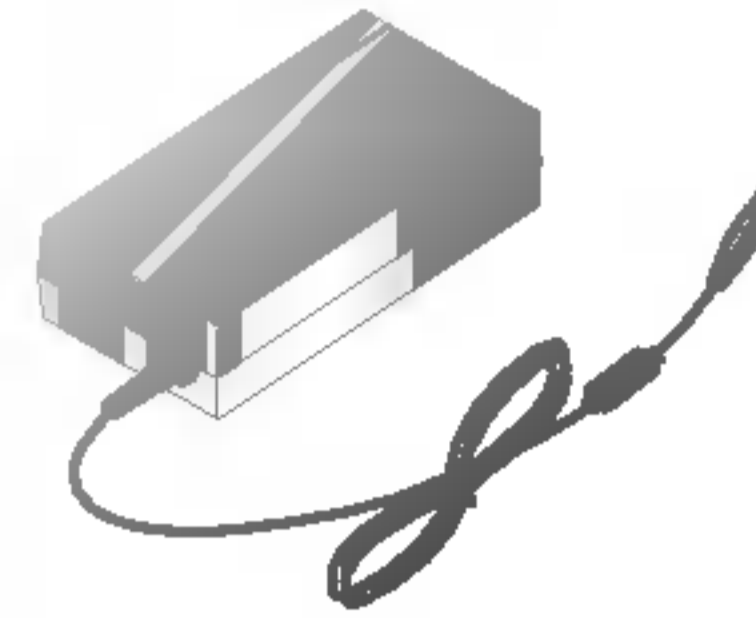

AC Adapter

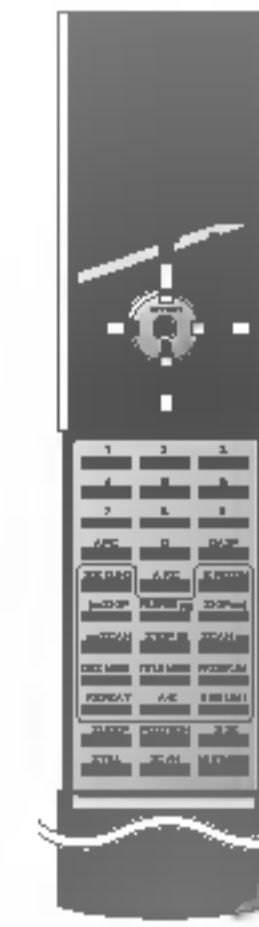

Remote Control

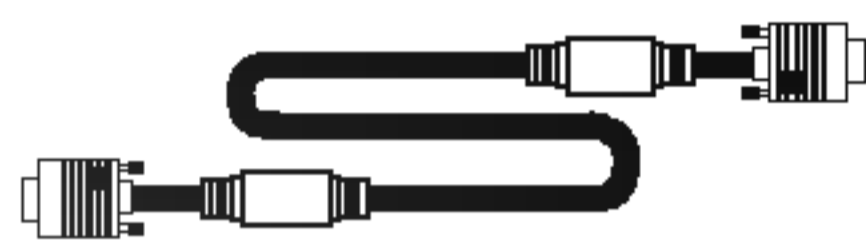

PC Signal Cable



PC Sound Cable



Power Cord



\* Caution: Please be sure to connect the TV to the AC power adapter before connecting the TV's power plug to a wall power outlet.

- Remove the connection panel cover as shown below.
- Connect the antenna cable to the antenna input port on the TV.
- Connect the AC adapter plug to the power input jack on the TV.
- Connect the power cord to the AC adapter first, then plug the power cord into the wall power outlet.
- Reinstall the connection panel cover.

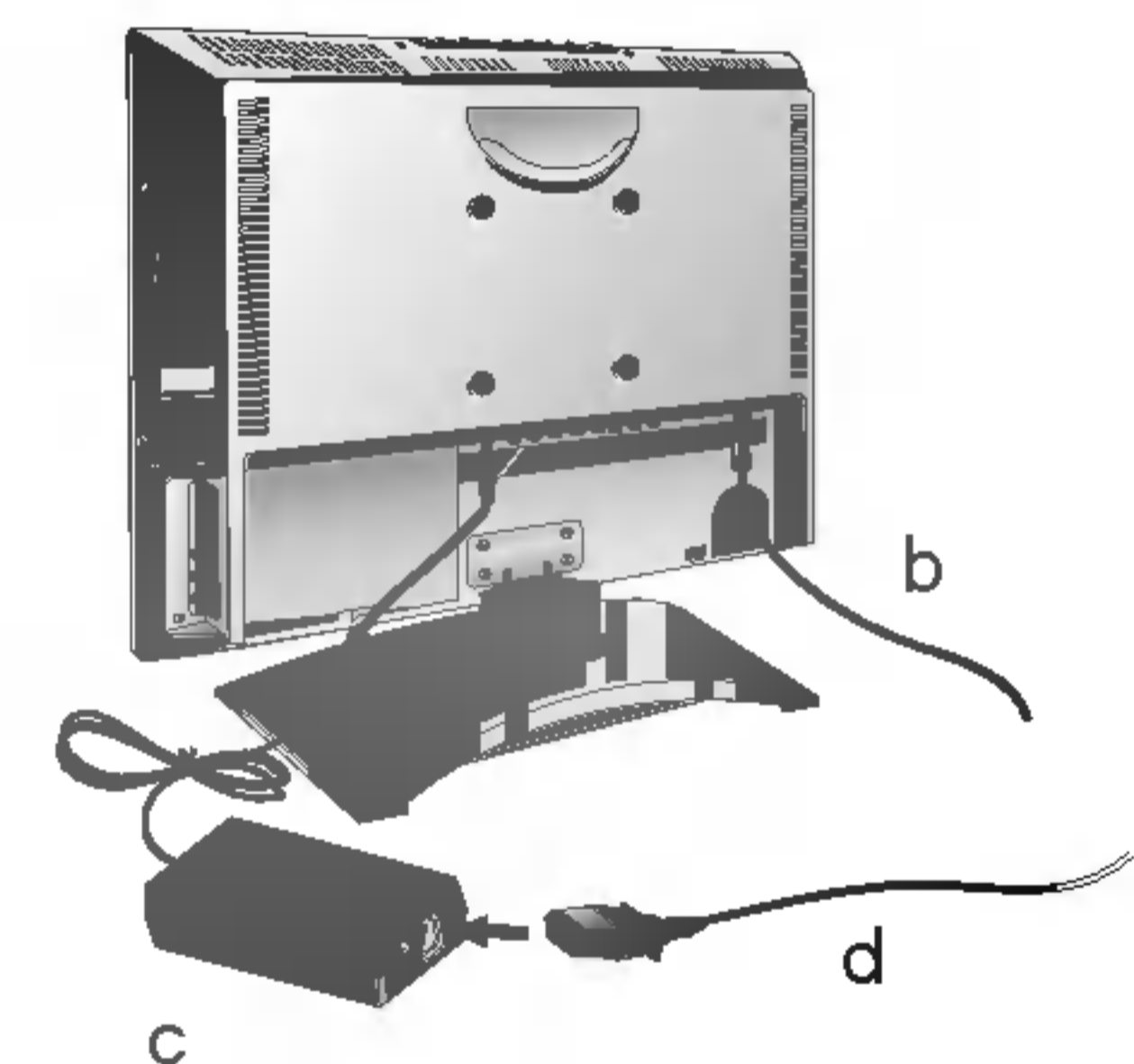
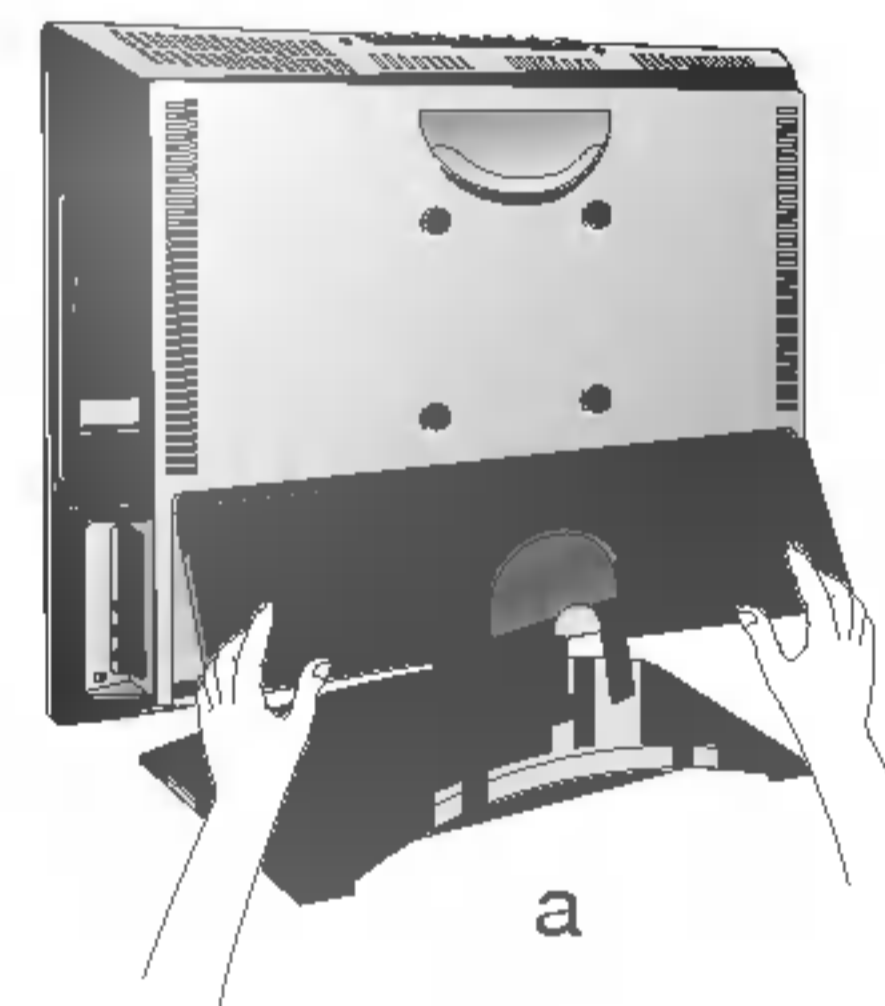

## NOTES

- If the TV feels cold to the touch, there may be a small "flicker" when it is turned on. This is normal, there is nothing wrong with TV.
- Some minute dot defects may be visible on the screen, appearing as tiny red, green, or blue spots. However, they have no adverse effect on the monitor's performance.
- Avoid touching the LCD screen or holding your finger(s) against it for long periods of time. Doing so may produce some temporary distortion effects on the screen.

## Installation Instruction

- \* The connection panel is hidden behind the A/V cover.
- Remove the cover.
  - Install wires as necessary.
  - Reinstall the cover. Position the A/V cover with the TV back panel, tilt it back as shown.
  - Align the holes on the TV back panel with the two tabs on the rear A/V cover and insert.
  - Close cover.

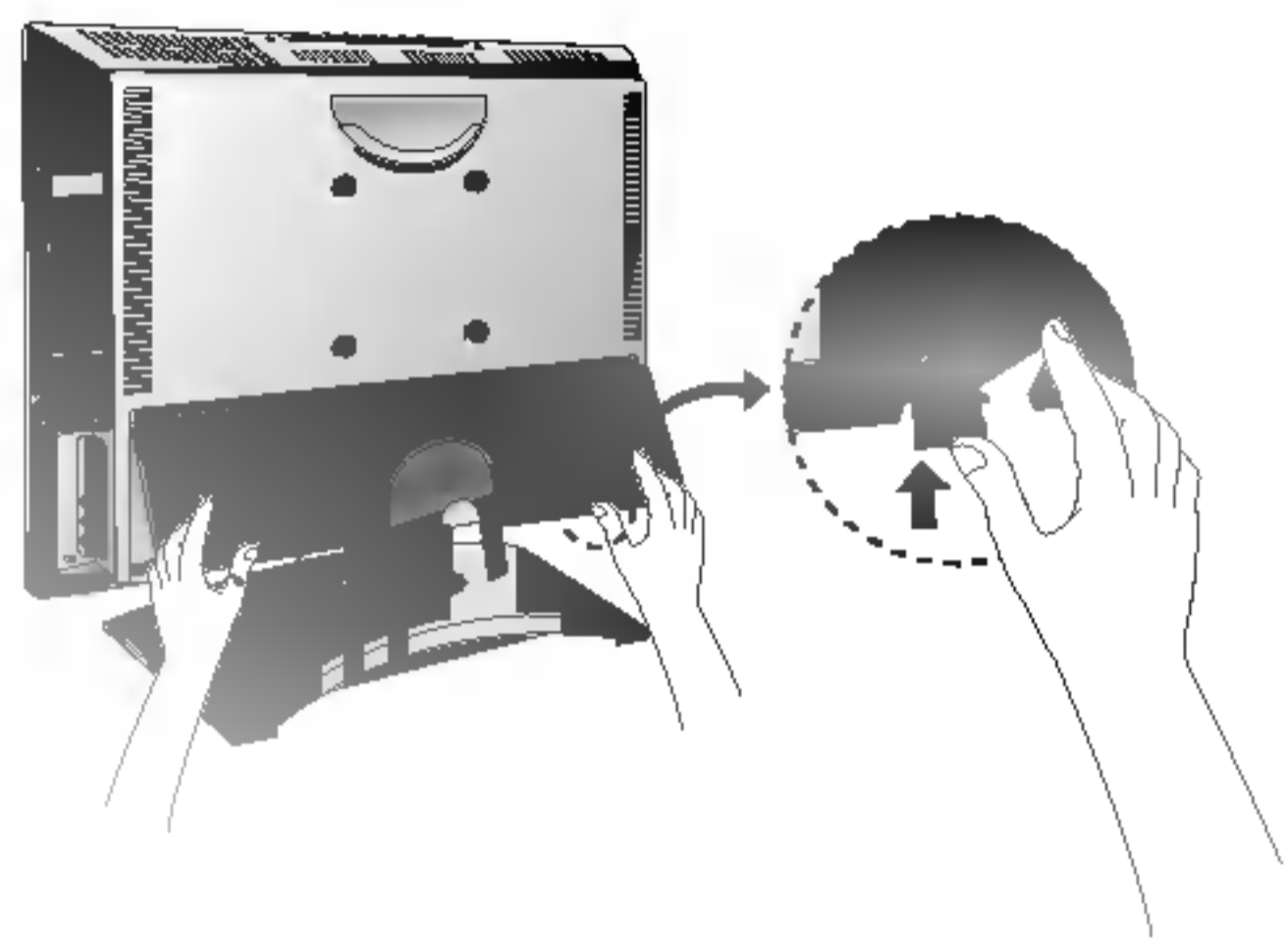

- Thread, then pull the wires through the hole on the TV stand.



- You can adjust the vertical viewing angle of the TV between 3° and 12°.

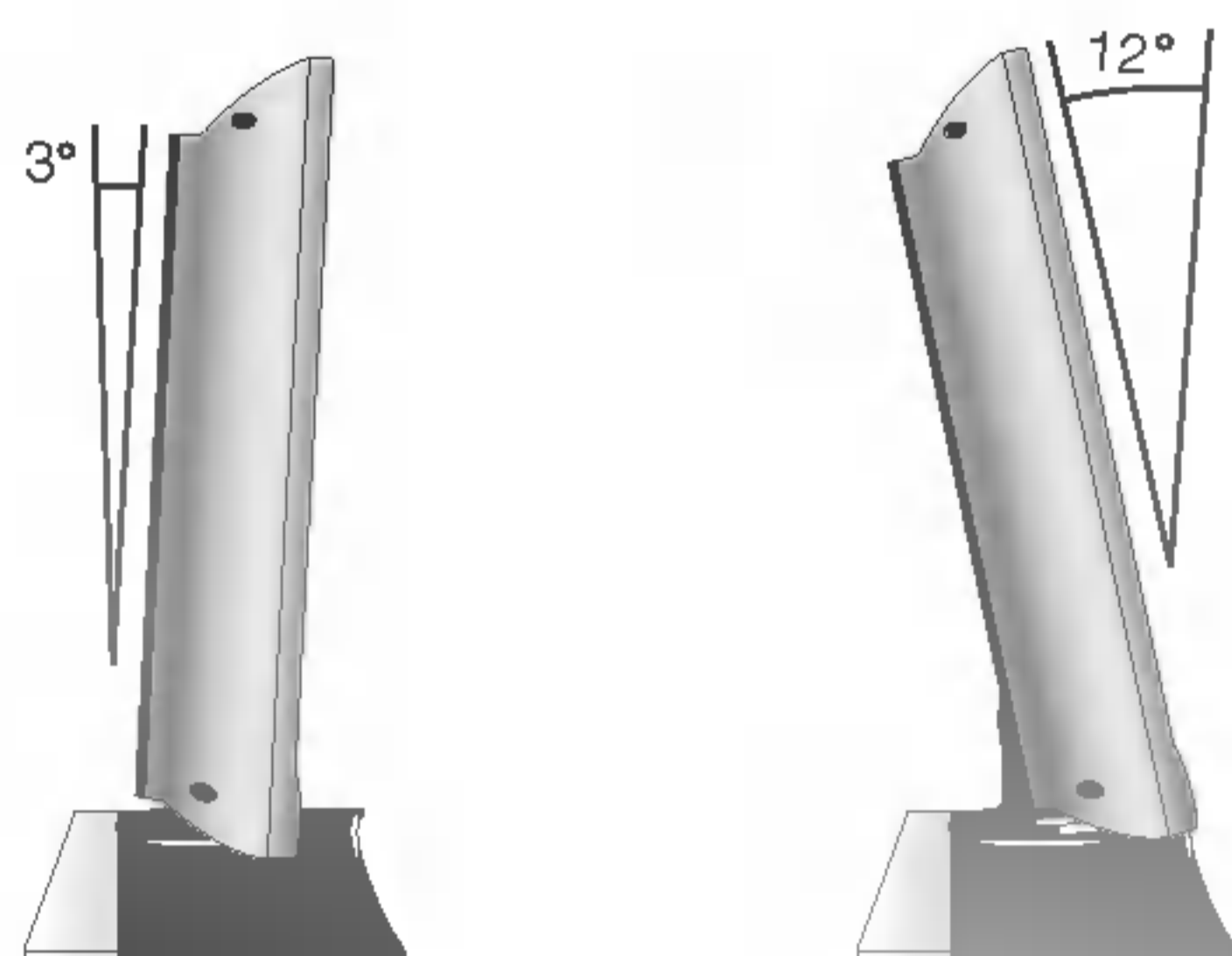

- The TV can be conveniently swiveled on its stand 25° to the left or right to provide the optimum viewing angle.

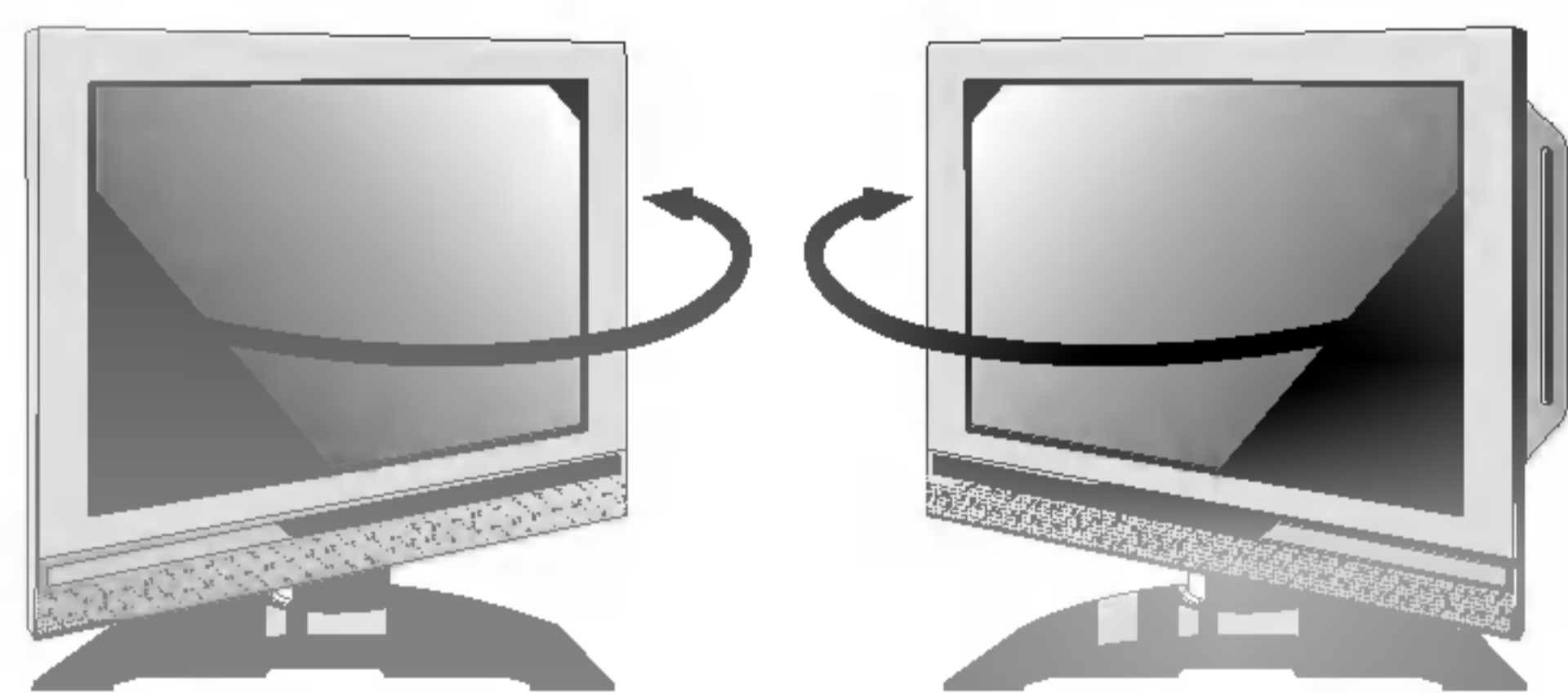

- An optional wall mount is available for this TV, see your dealer. For installation, follow the instructions provide with the optional wall mount.

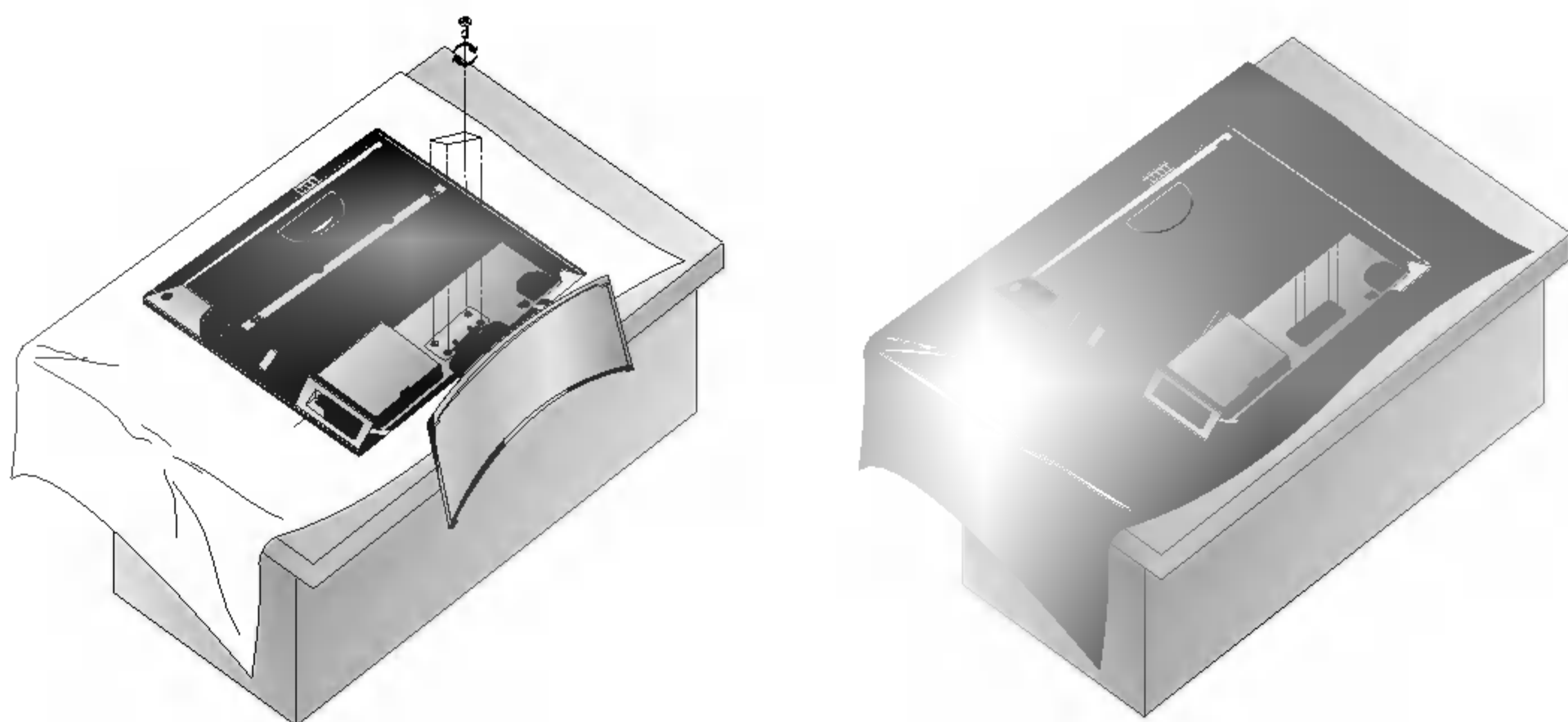

# External Equipment Connections

- For optimum picture quality, adjust antenna direction.

## Connecting to an Inside Antenna Setup

- Typical wall antenna jack used in apartment buildings, connect the antenna cable as shown below. (Use the correct type of antenna cable for the type of wall antenna jack.)

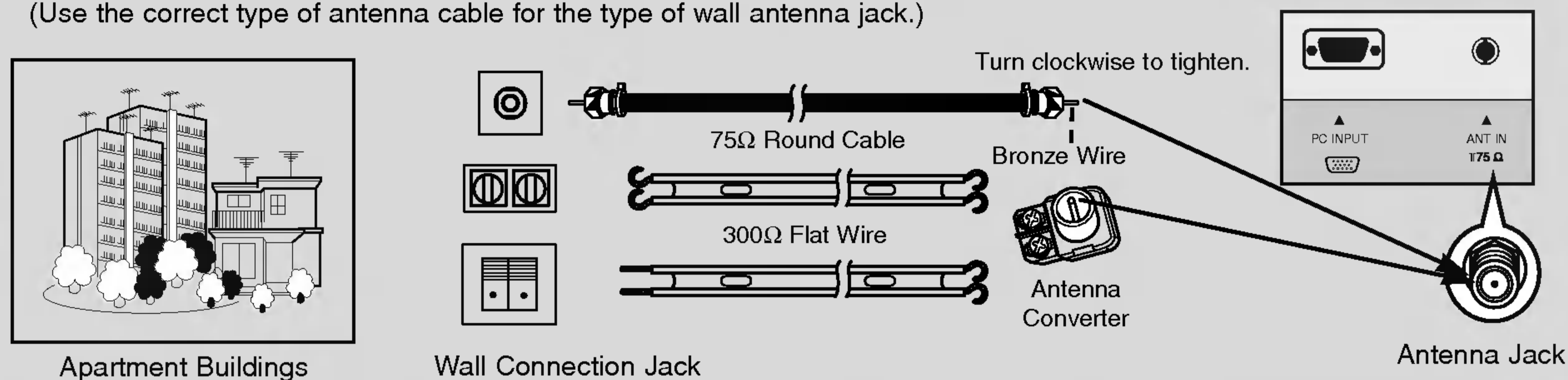

- If you have a 75Ω round cable, insert the bronze wire and then tighten the connection nut. If you have a 300Ω flat wire, connect the twisted wire to the antenna converter and then connect the converter to the antenna jack on the TV.
- If using 75Ω round cable, do not bend the bronze wire. It may cause poor picture quality.

## Connecting to an Outside Antenna Setup

- This type of antenna is commonly used in single family dwellings.

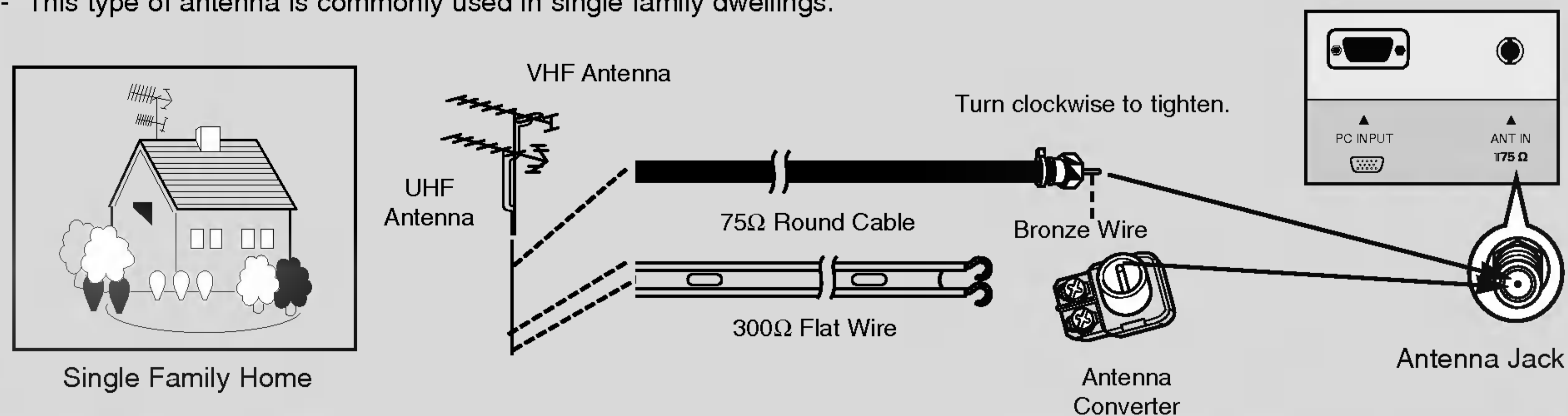

- In poor signal areas, to get better picture quality, install a signal amplifier to the antenna as shown to the right.
- If signal needs to be split for two TVs, use an antenna signal splitter for connection.

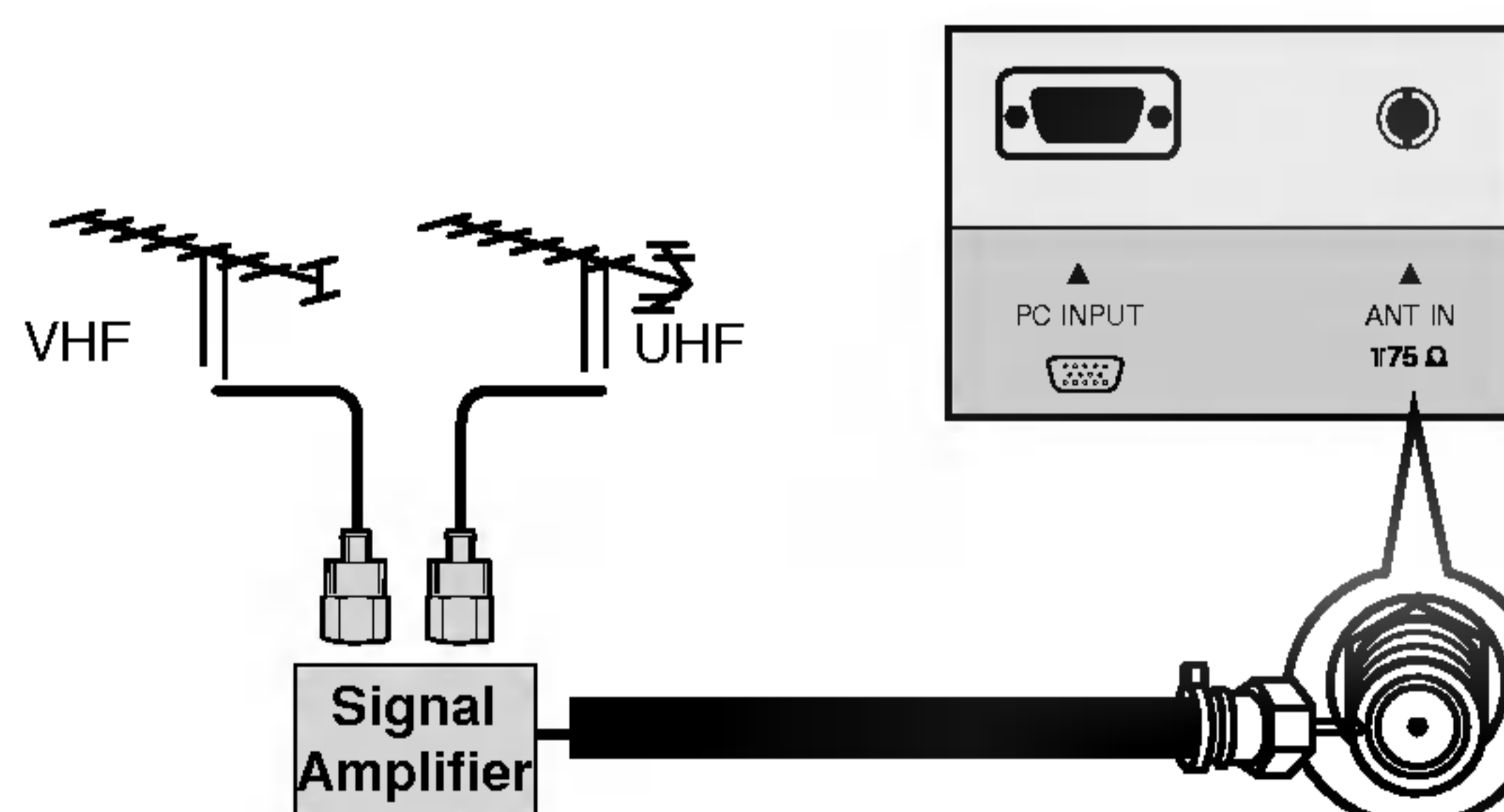

## External Equipment Connections Continued



### Connection 1

Set VCR switch to 3 or 4 and then tune TV to the same channel number.

### Connection 2

1. Connect the audio/video output jacks on VCR to the corresponding input jacks on the TV. When connecting the TV to a VCR, match the jack colors (Video = yellow, Audio Left = white, and Audio Right = red).
2. Insert a video tape into the VCR and press PLAY on the VCR. (Refer to the VCR owner's manual.)
3. Use the **TV/VIDEO** button on the remote control to select **Video**. (If connected to S-VIDEO on side panel, select the **S-Video** external input source.)

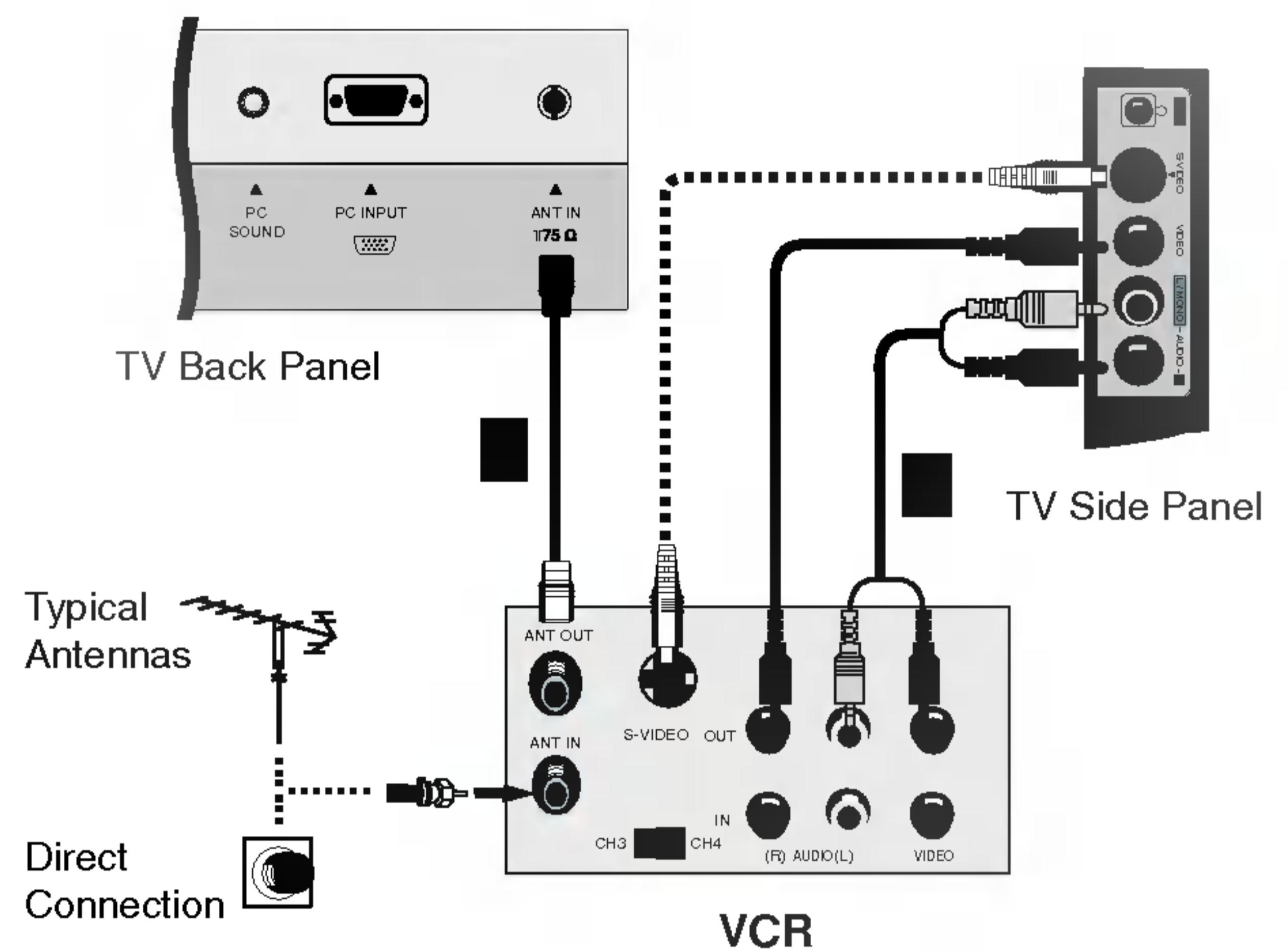

- After subscribing to a local cable TV service and installing a converter, you can watch cable TV programming.
- For further cable TV information, contact a local cable service provider.

### Connection 1

1. Select 3 or 4 with channel switch on cable box.
2. Tune the TV channel to the same selected output channel of cable box.
3. Select channels at the cable box or with the cable box remote control.

### Connection 2

1. Connect the audio/video output jacks on Cable Box to the corresponding input jacks on the TV. When connecting the TV to Cable Box, match the jack colors (Video = yellow, Audio Left = white, and Audio Right = red).
2. Use the **TV/VIDEO** button on the remote control to select **Video**.
3. Select channels with the cable box remote control.

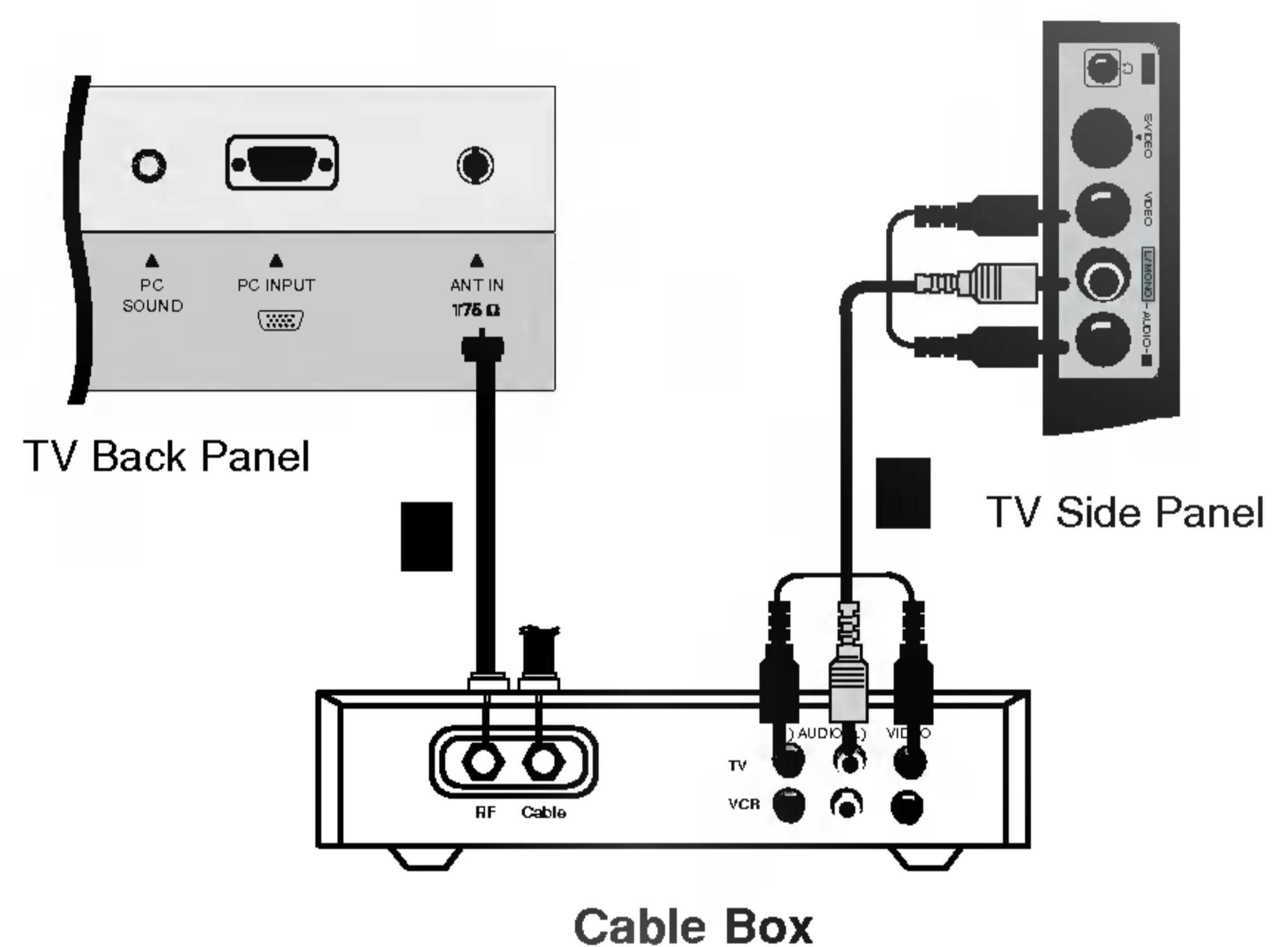

### Connections

Connect the audio/video output jacks on the external A/V equipment to the corresponding input jacks on the TV. When connecting the TV to external A/V equipment, match the jack colors (Video = yellow, Audio Left = white, and Audio Right = red).

### Viewing Setup

1. Turn on the external A/V equipment.
2. Use the **TV/VIDEO** button on the remote control to select **Video**.
3. Operate the corresponding external equipment. Refer to external equipment operating guide.

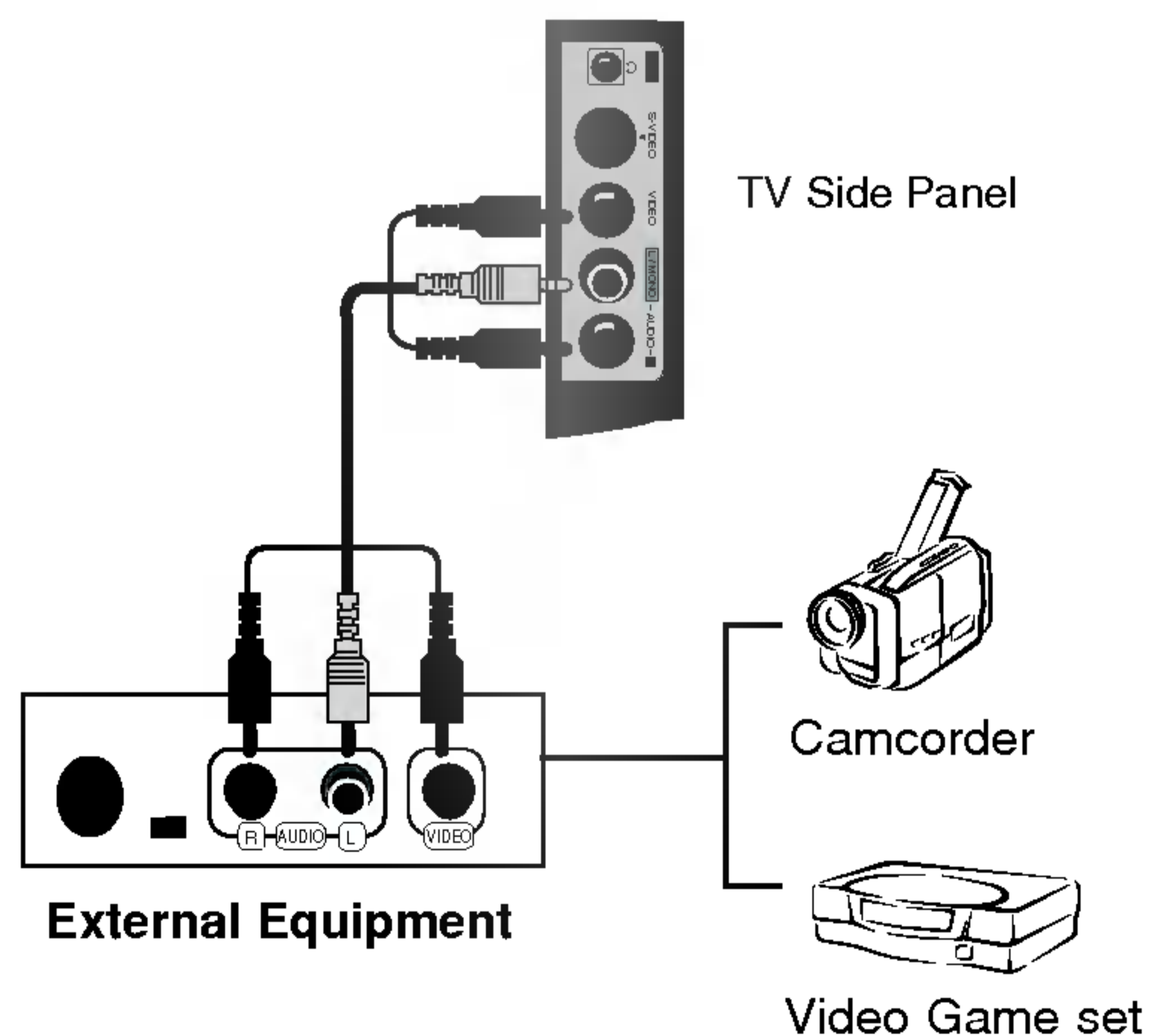

- This TV can play a DVD without other DVD player. However, if you do watch a DVD from other DVD player, refer to the figure as shown right.

### Connections

Connect the DVD video outputs to the COMPONENT (Y, PB, PR) jacks and connect the DVD audio outputs to the AUDIO jacks.

### Viewing Setup

1. Turn on the DVD player, insert a DVD.
2. Use the **TV/VIDEO** or **MULTIMEDIA** button on the remote control to select **Component**.
3. Refer to the DVD player's manual for operating instructions.

#### • Component Input ports

To get better picture quality, connect a DVD player to the component input ports as shown below.

|                                  |   |     |  |
|----------------------------------|---|-----|--|
| Component ports of the TV        | Y |     |  |
| Video output ports of DVD player | Y | Pb  |  |
|                                  | Y | B-Y |  |
|                                  | Y | Cb  |  |
|                                  | Y | PB  |  |

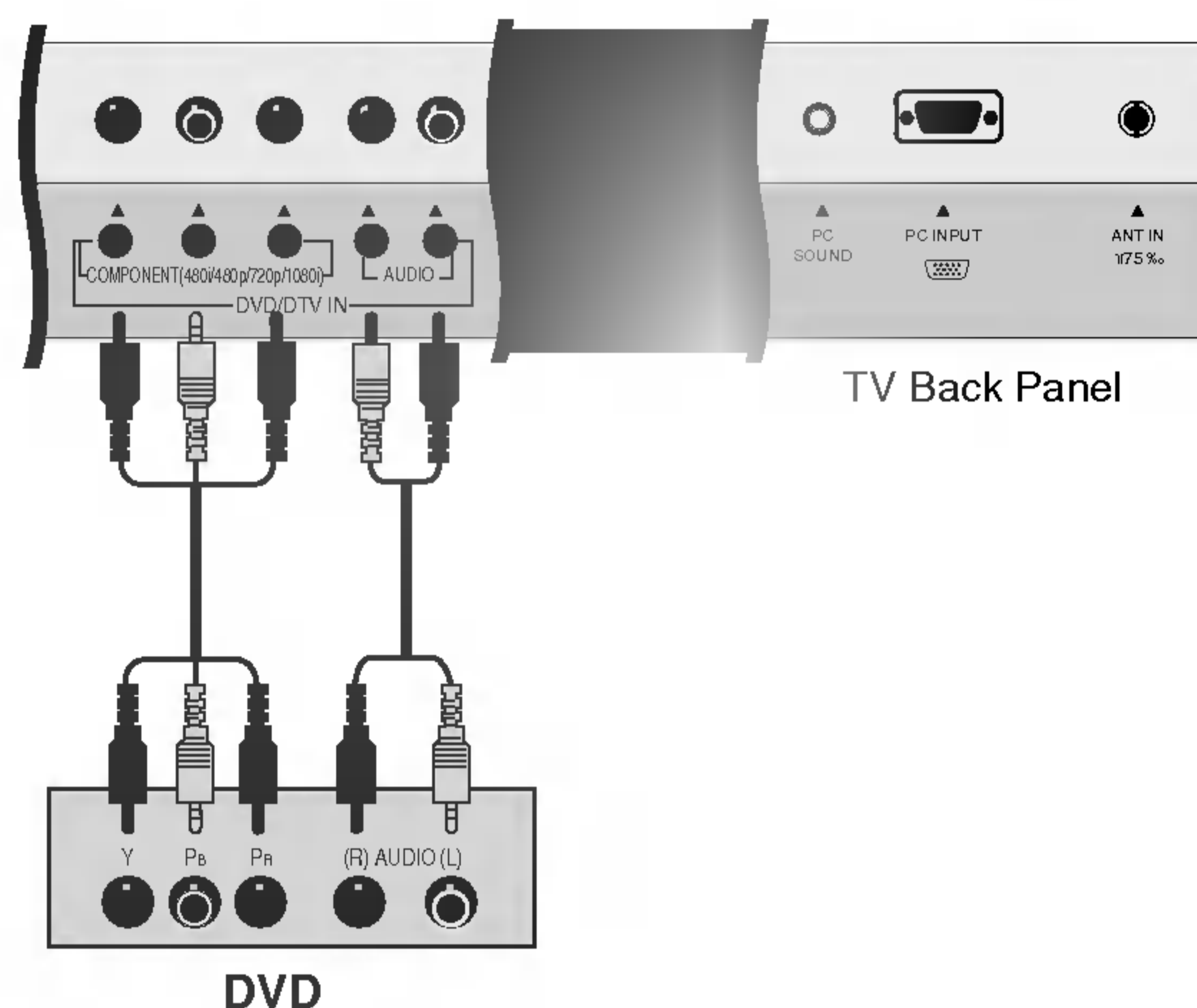

- To watch digitally broadcast programs, purchase and connect a digital set-top box.

### Connections

Connect the digital set-top box video outputs to the COMPONENT (Y, PB, PR) jacks and connect the digital set-top box audio outputs to the AUDIO jacks.

### Viewing Setup

1. Turn on the digital set-top box. (Refer to the owner's manual for the digital set-top box.)
2. Use the **TV/VIDEO** or **MULTIMEDIA** button on the remote control to select **Component**.

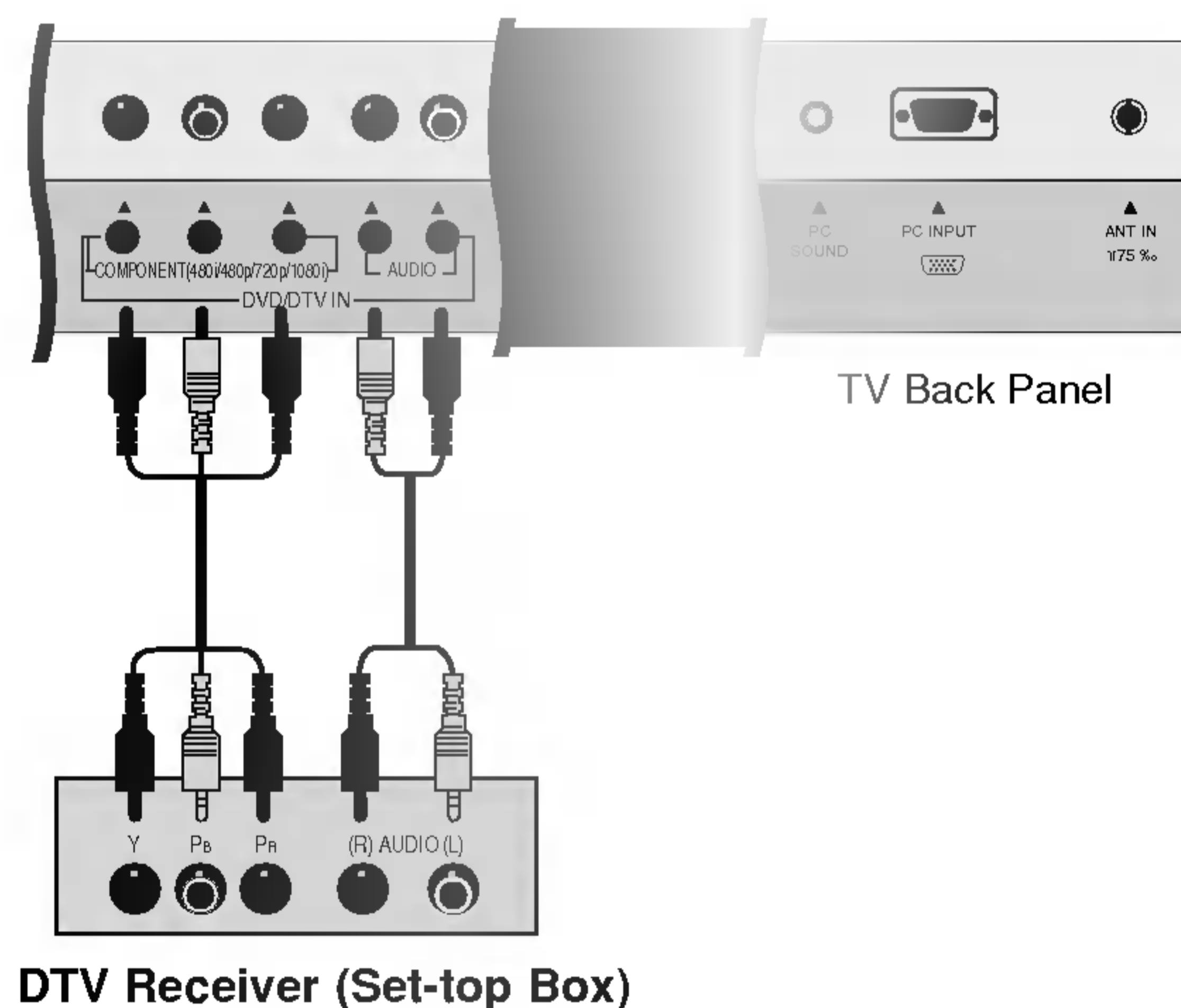

- Plug headphones in to H/P jack as shown.
- Adjust sound level to a headphone using the volume (◀, ▶) buttons. While you are listening to sound through a headphone(s), TV speakers will not be heard.

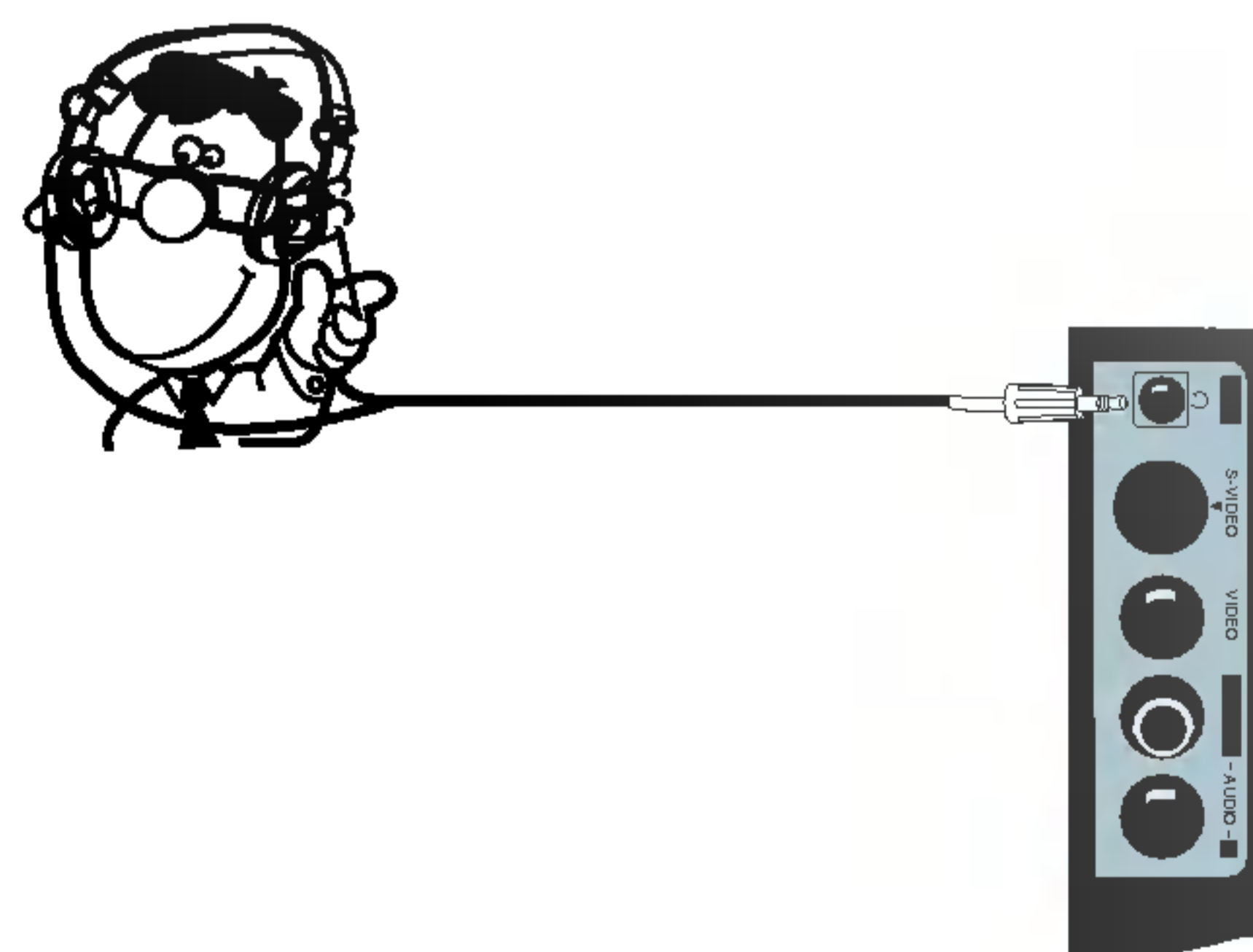

The TV has a special signal output capability which allows you to hook up a second TV or monitor.

Connect the second TV or monitor to the TV' DVD OUTPUT and OPTICAL DIGITAL SOUND OUT jack. See the Operating Manual of the second TV or monitor for further details regarding that device's input settings.

- Notes:
- If your DVD has no optical digital audio input jack, it's impossible to use DVD sound output.
  - Do not look into the optical output port. Looking at the laser beam may damage your vision.
  - If your external audio equipment has a digital audio input optical port, you can connect it to your TV.

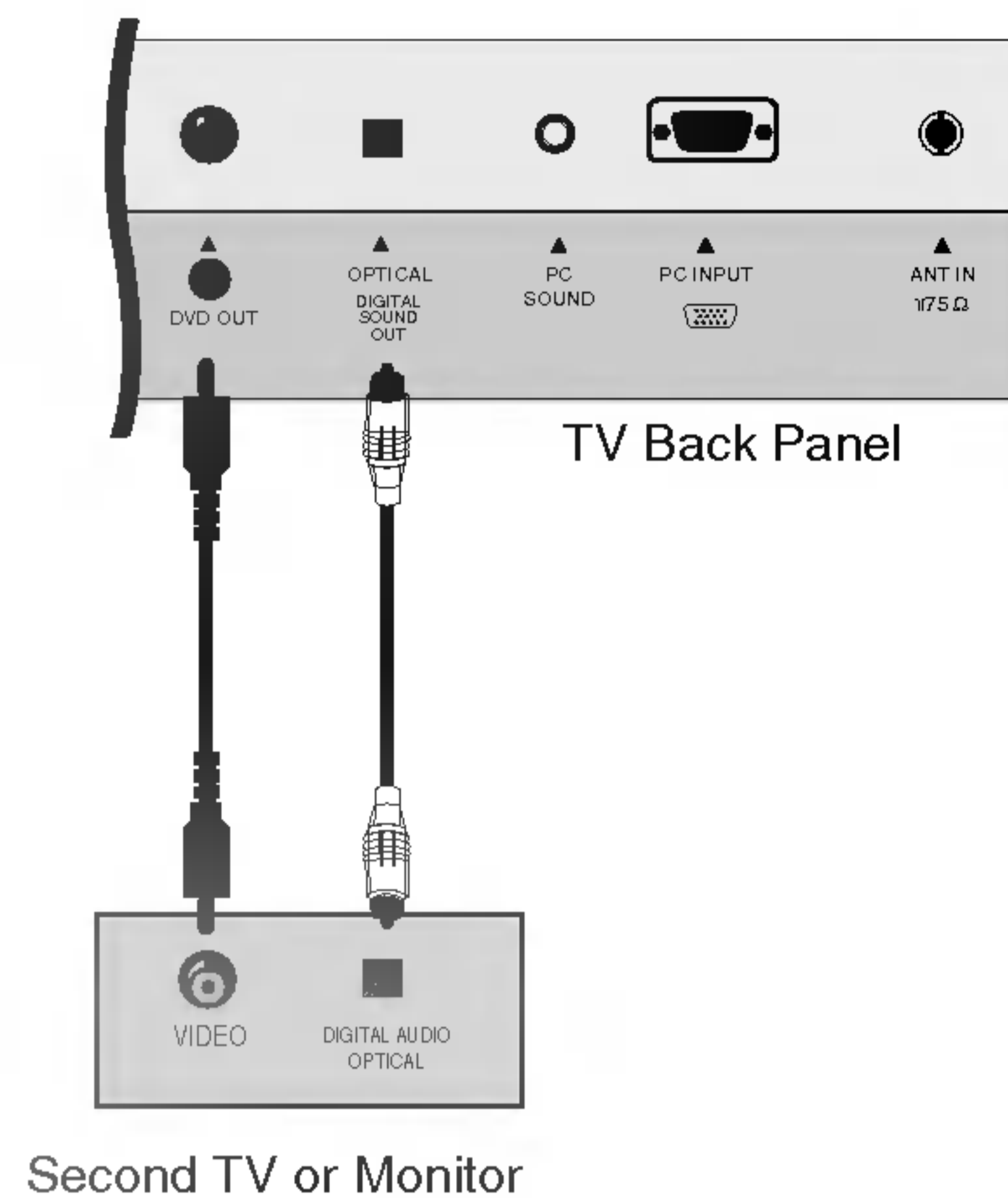

- After setup, be sure to select RGB-PC source on TV.

### Connections

1. Set the monitor output resolution on the PC before connecting to the TV.
2. Connect the TV to the PC with the PC cable.
3. Connect the PC audio output to the TV's PC SOUND input.

### Viewing Setup

1. Turn on the PC.
2. Use the **TV/VIDEO** or **MULTIMEDIA** button on the remote control to select **RGB-PC**.

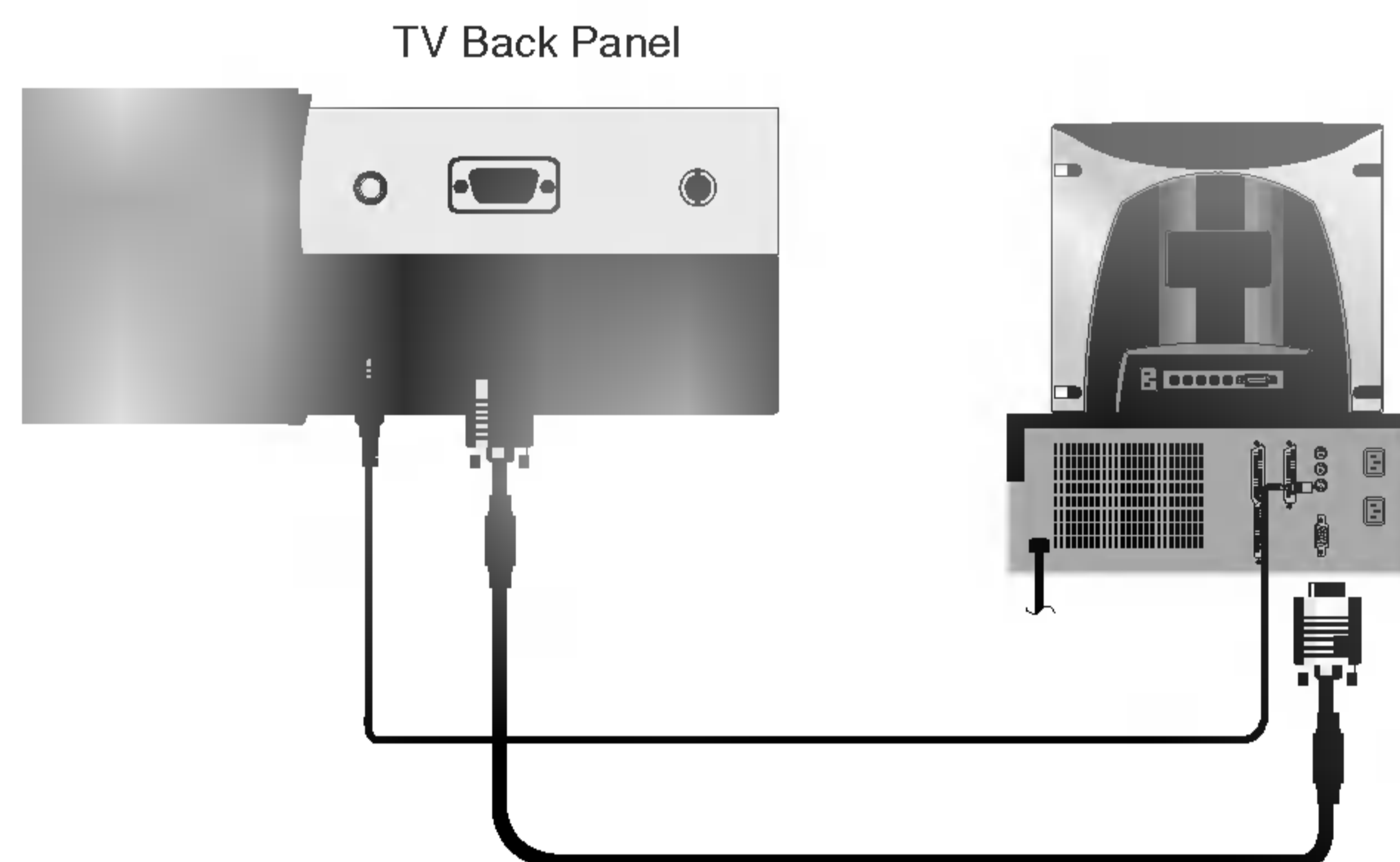

### Monitor Display Specifications

| Resolution | Horizontal Frequency(KHz) | Vertical Frequency(Hz) | Resolution | Horizontal Frequency(KHz) | Vertical Frequency(Hz) |
|------------|---------------------------|------------------------|------------|---------------------------|------------------------|
| 640x480    | 31.4                      | 60                     | 832x624    | 49.7                      | 75                     |
|            | 35                        | 67                     | 1024x768   | 48.3                      | 60                     |
|            | 37.5                      | 75                     |            | 56.4                      | 70                     |
|            | 43.2                      | 85                     |            | 60                        | 75                     |
| 800x600    | 35.1                      | 56                     | 1280x768   | 39.5                      | 50                     |
|            | 37.8                      | 60                     |            | 47.6                      | 60                     |
|            | 48                        | 72                     |            |                           |                        |
|            | 46.8                      | 75                     |            |                           |                        |
|            | 53.6                      | 85                     |            |                           |                        |

### NOTES

- a. For optimum picture quality, use standard XGA (1024x768) computer output at a 60Hz refresh rate. Using other formats (VGA, SVGA, etc.) or refresh rates may result in reduced picture quality. (To change the computer video output format, please refer to the operating manual for the computer you are using).
- b. If the message "**Out of range**" appears on the screen, adjust the PC output to a format listed in the 'Monitor Display Specifications' chart above.
- c. The synchronization input form for Horizontal and Vertical frequencies is separate.

### DPM (Display Power Management) mode

If the PC goes to power saving mode, the monitor automatically switches to DPM mode. If you don't use the PC cable provided, DPM mode may not work.

# Operation

\* In this manual, the OSD (On Screen Display) may be different from your TV's because it is just example to help the TV operation.

## TV Operation Overview

1. First, make all equipment connections. Plug the AC Adapter into the TV, then plug the AC Adapter into a power outlet. At this time, the TV is switched to standby mode.
  - In standby mode, press the **POWER**, **CH** (▲, ▼), **TV/VIDEO**, **MULTIMEDIA** or **number** button on the remote control or **ON/OFF**, **CH** (▲, ▼), **TV/VIDEO** located on the TV to turn the TV on.
2. Select the viewing source by pressing **TV/VIDEO** or **MULTIMEDIA** repeatedly.
  - Note: See page 14 if you have not auto programmed the TV to receive channels in your local broadcast area.
3. After viewing, press the **POWER** button on the remote control or **ON/OFF** located on the TV. The TV reverts to standby mode.

### NOTE

- If you want to turn the TV off, press the on/off button located on the TV. If you intend to be away on vacation, disconnect the power plug from the wall power outlet.

## Menu Language Selection

- The menus can be shown on the screen in the selected language. First select your language.

1. Press the **MENU** button and then use ▲ / ▼ button to select the **Special** menu.
2. Press the ► button and then use ▲ / ▼ button to select **Language**.
3. Use the ◀ / ▶ button to select your desired language.  
From this point on, the on-screen menus will be shown in the language of your choice.
4. Press the **EXIT** button to save and return to TV viewing.

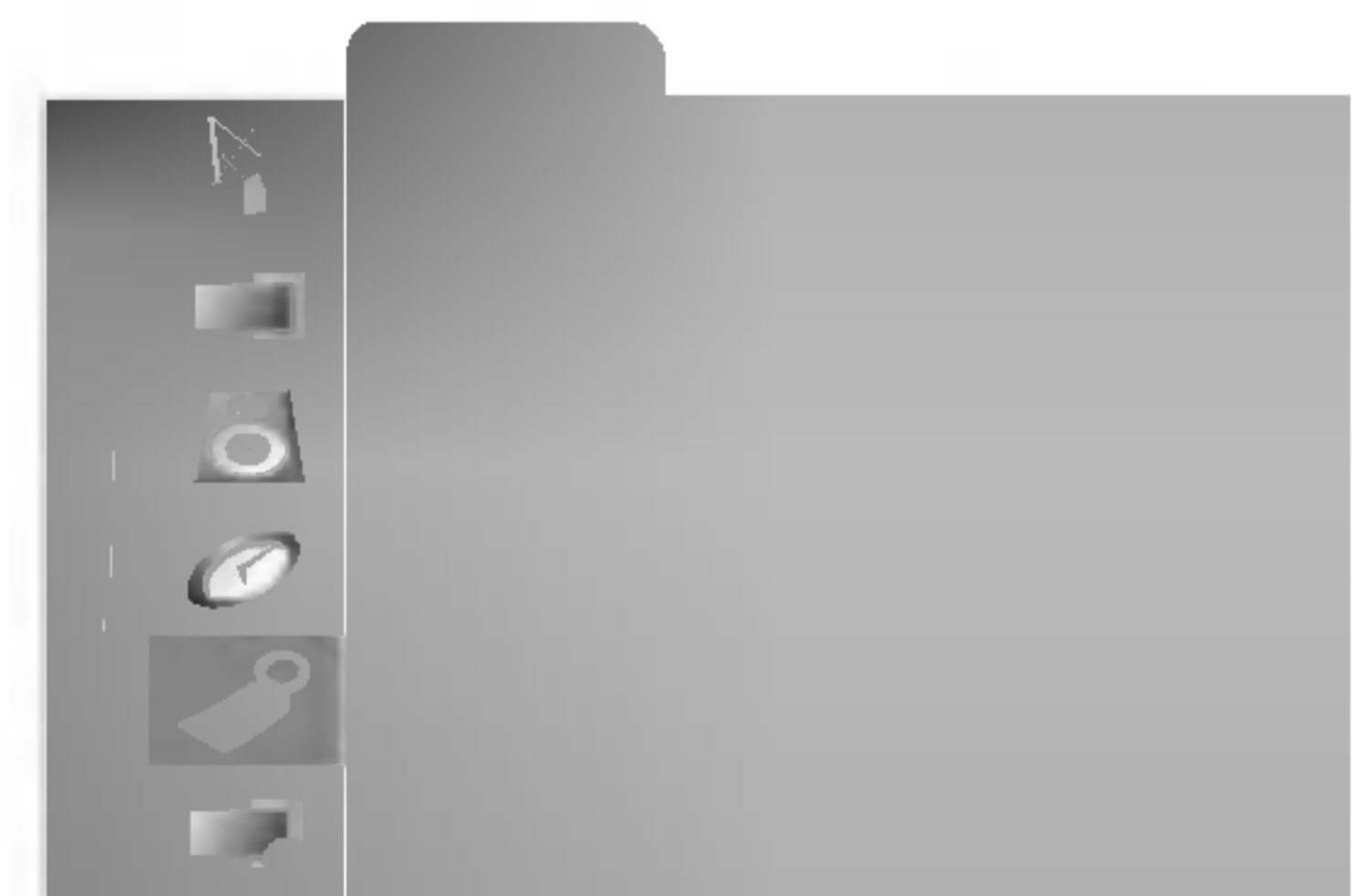

# Channel Menu Options

- For Auto programming to work, the programming source must be connected to the TV and the TV must be receiving programming signals either over-the-air or from a cable-type service provider.

1. Press the **MENU** button and then use ▲ / ▼ button to select the **Channel** menu.
2. Press the ► button and then use ▲ / ▼ button to select **Auto program**.
3. Press the ► button to begin the channel search.
  - Wait for auto program to complete the channel search cycle before choosing a channel. The TV scans for over-the-air channels and then channels provided by a cable service.



## NOTES

- When the channel search is completed, use the ▲ / ▼ buttons to review the memorized channels.
- If you press the **ENTER** button in Auto programming, the function will stop and only channels programming up to that time will remain.
- Auto program function can memorize only the channels which are being received at that time.

- You can manually include or erase individual channels.

1. Press the **MENU** button and then use ▲ / ▼ button to select the **Channel** menu.
2. Press the ► button and then use ▲ / ▼ button to select **Manual prog..**
3. Press the ► button and then use ◀ / ▶ button to select a channel you want to add to memory or erase.
4. Press the ▼ button and then use ◀ / ▶ button to select **Memory** (add) or **Erase** (delete).
5. Press the **EXIT** button to save and return to TV viewing. The current channel is added to Memory or Erased from the channel list.

The current channel number is displayed.



- This function adjusts the pictures stability and condition when it is poor.

1. Press the **MENU** button and then use ▲ / ▼ button to select the **Channel** menu.
2. Press the ► button and then use ▲ / ▼ button to select **Manual prog..**
3. Press the ► button and then use ▲ / ▼ button to select **Fine**.
4. Use the ◀ / ▶ button to adjust the picture to your preference.
5. Press the **EXIT** button to save and return to TV viewing.

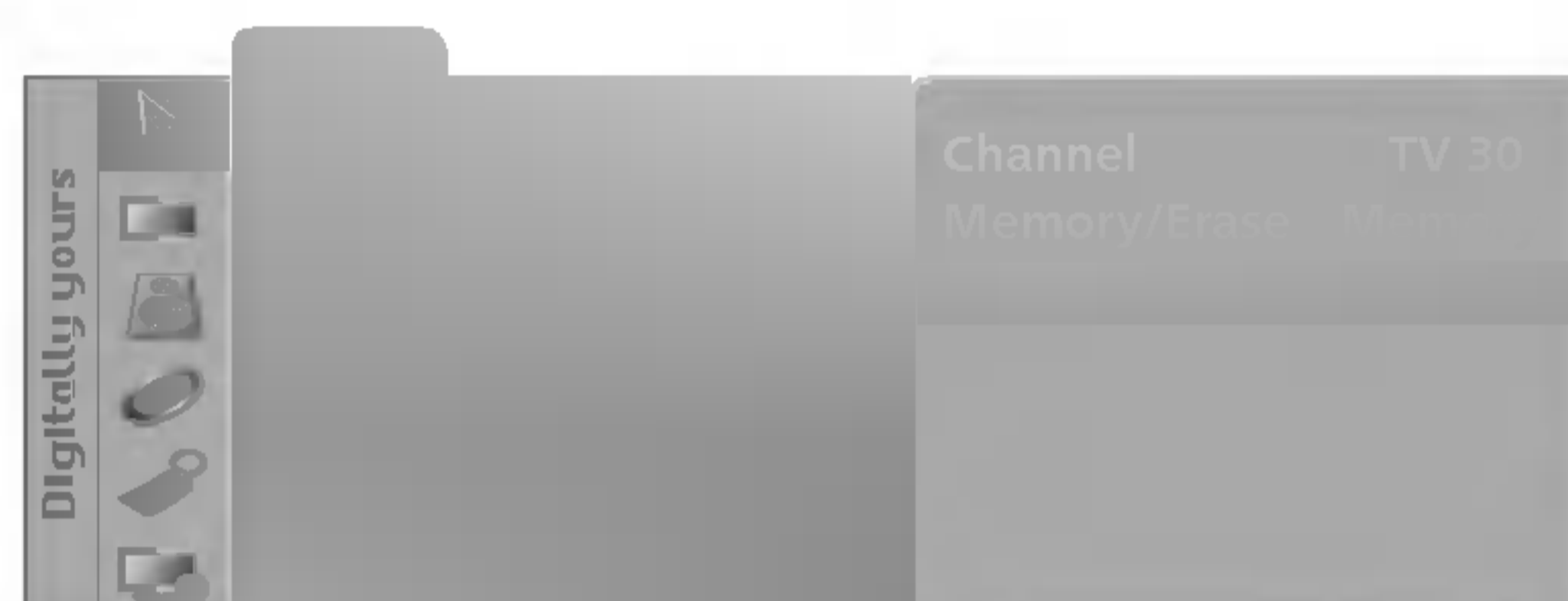

- Favorite Channel lets you quickly tune in up to 5 channels of your choice without having to wait for the TV to scan through all the in-between channels.

1. Press the **MENU** button and then use ▲ / ▼ button to select the **Channel** menu.
2. Press the ► button and then use ▲ / ▼ button to select **Favorite ch..**
3. Press the ► button and then use ▲ / ▼ button to select the first favorite channel position.
4. Use the ◀ / ▶ button to set the desired channel number for first favorite channel.
5. Repeat steps 3 to 4 to memorize other channels.
6. Press the **ENTER** button to save.



- To tune to a favorite channel, press the **FCR** (Favorite Channel Review) button repeatedly. The 5 favorite channels appear on the screen one-by-one.

# Picture Menu Options

- This function adjusts the TV for the best picture appearance.

1. Press the **APC** button repeatedly to select the picture appearance setup option as shown below.

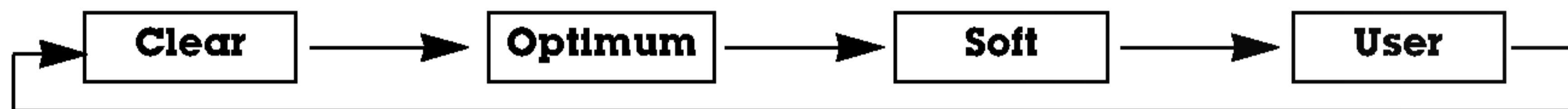

- You can also adjust **APC** in the **Picture** menu.
- **Clear**, **Optimum** and **Soft** are preset for good picture quality at the factory and cannot be changed.

- You can adjust picture contrast, brightness, color, sharpness and tint to the levels you prefer.

1. Press the **MENU** button and then use **▲ / ▼** button to select the **Picture** menu.
2. Press the **▶** button and then use **▲ / ▼** button to select **APC**.
3. Press the **ENTER** button and then use **▲ / ▼** button to select the desired picture option (**Contrast**, **Brightness**, **Color**, **Sharpness**, **Tint**).
4. Use the **◀ / ▶** button to make appropriate adjustments.
  - Contrast, Brightness, Color, and Sharpness are adjustable from 0 to 100.
  - Tint is adjustable from Red 50 to Green 50.
5. Press the **EXIT** button to save and return to TV viewing.

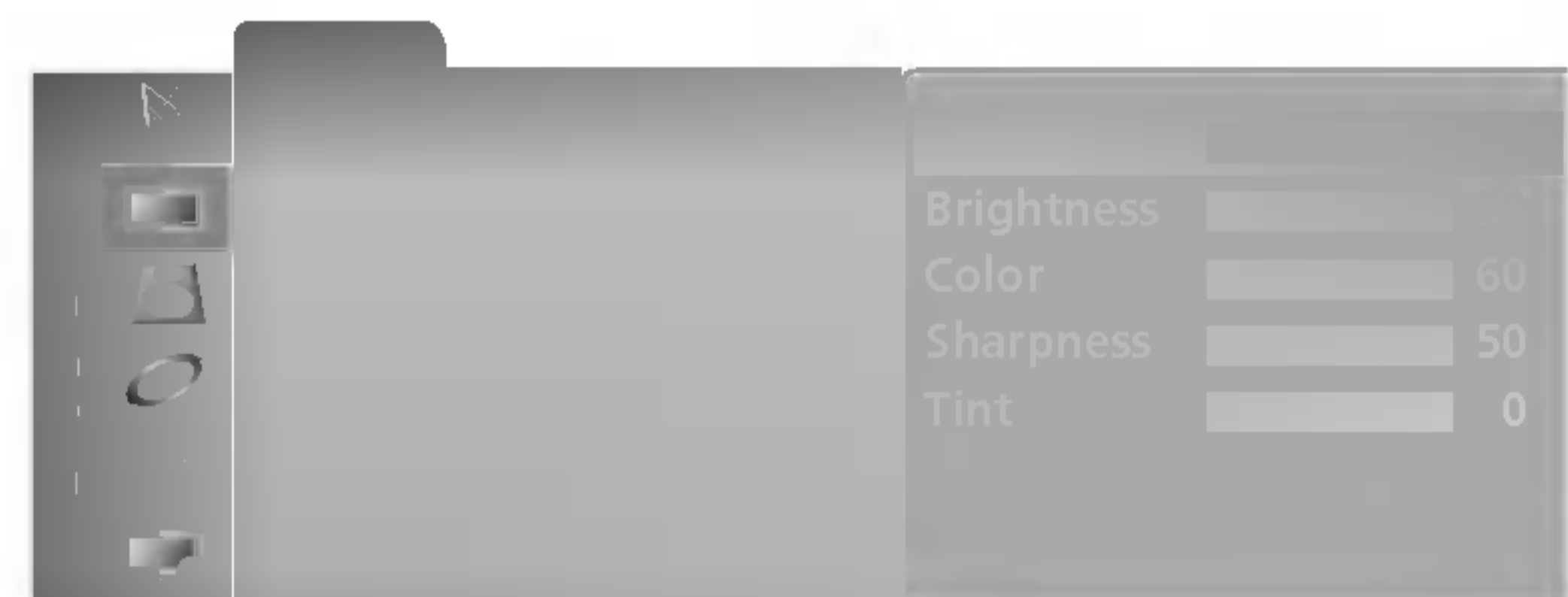

- To initialize values (reset to default settings), select the **Normal** option.

1. Press the **MENU** button and then use **▲ / ▼** button to select the **Picture** menu.
2. Press the **▶** button and then use **▲ / ▼** button to select **ACC**.
3. Use the **◀ / ▶** button to select either **Normal** (Default), **Warm** (Preset), **User** (Manual Adjustment) or **Cool** (Preset).
4. Press the **EXIT** button to save and return to TV viewing.



## Picture Menu Options Continued

- You can adjust red, green, or blue to any color temperature you prefer.

1. Press the **MENU** button and then use **▲ / ▼** button to select the **Picture** menu.
2. Press the **▶** button and then use **▲ / ▼** button to select **ACC**.
3. Press the **ENTER** button and then use **▲ / ▼** button to select **Red**, **Green** or **Blue**.
4. Use the **◀ / ▶** button to make appropriate adjustments.
  - The adjustment range of **Red**, **Green**, and **Blue** is 0 ~100.
5. Press the **EXIT** button to save and return to TV viewing.



- Improves picture outline in dark areas.

1. Press the **MENU** button and then use **▲ / ▼** button to select the **Picture** menu.
2. Press the **▶** button and then use **▲ / ▼** button to select **DRP**.
3. Use the **◀ / ▶** button to select **Clear** or **Soft**.
4. Press the **EXIT** button to save and return to TV viewing.

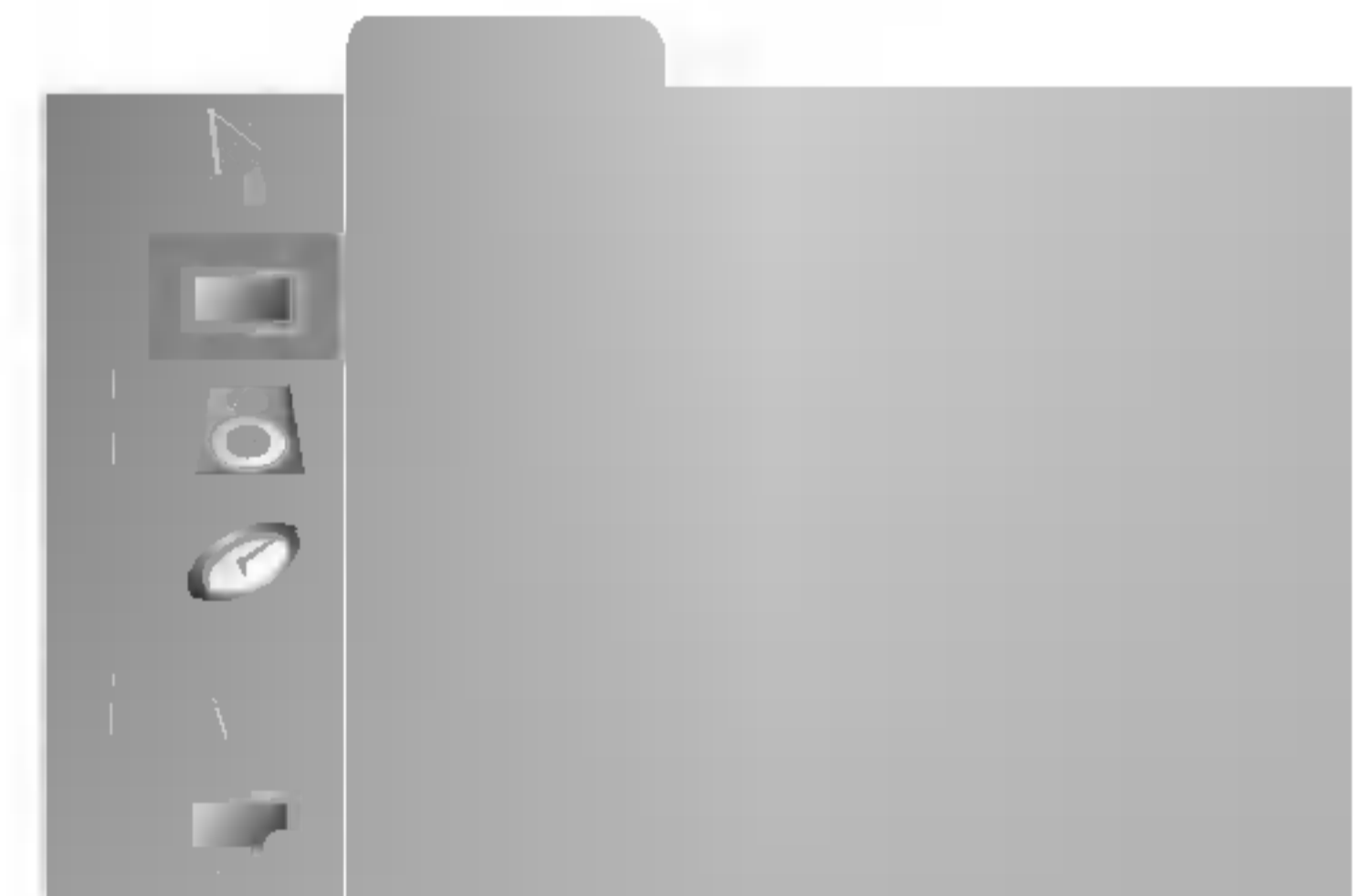

1. Press the **ARC** button repeatedly to select the desired picture format.



- Picture format **“Zoom”** is not available in Component and RGB-PC mode.

# Sound Menu Options

- This function lets you enjoy the best sound without any special adjustment because the TV selects the appropriate sound option based on the program content.

1. Use the **DASP** button to select the appropriate sound setup as shown below.



- You can also adjust **DASP** in the **Sound** menu.
- Manufactured under license from Dolby Laboratories. “Dolby” and the double-D symbol are trademarks of Dolby Laboratories.

1. Press the **MENU** button and then use **▲ / ▼** button to select the **Sound** menu.
2. Press the **▶** button and then use **▲ / ▼** button to select **DASP**.
3. Press the **ENTER** button and then use **◀ / ▶** button to select the band you want to adjust. Then, use **▲ / ▼** button to adjust the band level.
4. Press the **EXIT** button to save and return to TV viewing.



1. Press the **MENU** button and then use **▲ / ▼** button to select the **Sound** menu.
2. Press the **▶** button and then use **▲ / ▼** button to select **Balance**.
3. Use the **◀ / ▶** button to adjust the sound balance.
  - Balance is adjustable from Left 50 to Right 50.
4. Press the **EXIT** button to save and return to TV viewing.



- AVL maintains an equal volume level automatically even if the channel is changed.

1. Press the **MENU** button and then use **▲ / ▼** button to select the **Sound** menu.
2. Press the **▶** button and then use **▲ / ▼** button to select **AVL**.
3. Use the **◀ / ▶** button to to select **On** or **Off**.
4. Press the **EXIT** button to save and return to TV viewing.



## Sound Menu Options Continued



- Be sure to select the RGB-PC source and turn on the PIP before operation.

1. Press the **MENU** button and then use **▲ / ▼** button to select the **Sound** menu.
2. Press the **▶** button and then use **▲ / ▼** button to choose **Sound select**.
3. Use the **◀ / ▶** button to select desired screen sound (**RGB-PC** or **PIP**).
4. Press the **EXIT** button to save and return to TV viewing.



- The TV can receive MTS stereo programs and any SAP (Secondary Audio Program) that accompanies the stereo program, if the broadcaster transmits an additional sound signal as well as the original one.
- Mono: The primary language is heard from left and right speakers. Signal mode is mono.
- Stereo: The primary language is heard from left and right speakers. Signal mode is stereo.
- SAP: The secondary language is heard from left and right speakers.

1. Press the **MTS** button repeatedly.



- Select mono sound mode if the signal is not clear or in poor signal reception areas.
- **Stereo, SAP** mode are available only if included on the broadcast signal.

## Time Menu Options

- If the time on the clock is incorrect, reset the clock manually.

1. Press the **MENU** button and then use **▲ / ▼** button to select the **Timer** menu.
2. Press the **▶** button and then use **▲ / ▼** button to select **Clock**.
3. Press the **▶** button and then use **▲ / ▼** button to set the hour.
4. Press the **▶** button and then use **▲ / ▼** button to set the minutes.
5. Press the **EXIT** button to save and return to TV viewing.



- Timer function operates only if current time is set.
- Off-Timer function overrides On-Timer function if they are set to the same time.
- The TV must be in standby mode for the On-Timer to work.
- If you don't press any button within 2 hours after turning on the TV with the On-Timer function, the TV will automatically revert to standby mode.

1. Press the **MENU** button and then use **▲ / ▼** button to select the **Timer** menu.
2. Press the **▶** button and then use **▲ / ▼** button to select **Off timer** or **On timer**.
3. Press the **▶** button and then use **▲ / ▼** button to set the hour.
4. Press the **▶** button and then use **▲ / ▼** button to set the minutes.
5. **For On timer function only:**  
Press the **▶** button and then use **▲ / ▼** button to set the channel at turn-on. Then, press the **▶** button and then use **▲ / ▼** button to set the turn-on sound level.
6. Press the **▶** button and then use **▲ / ▼** button to select **Run** or **Hold**.
  - **Hold: Off timer/On timer** will not work.
  - **Run: Off timer/On timer** are active.
7. Press the **EXIT** button to save and return to TV viewing.



- The Sleep Timer turns the TV off at a preset time.

1. Press the **SLEEP** button repeatedly to select the number of minutes. First the **⓪<sup>z</sup>---** option appears on the screen, followed by the following sleep timer options: 10, 20, 30, 60, 90, 120, 180, and 240 minutes.
2. When the number of minutes you want is displayed on the screen, press the **ENTER** button. The timer begins to count down from the number of minutes selected.
3. To check the remaining minutes before the TV turns off, press the **SLEEP** button once.
4. To cancel the Sleep Timer, press the **SLEEP** button repeatedly until **⓪<sup>z</sup>---** appears.

# Special Menu Options

## Closed Captions

Closed captioning is a process which converts the audio portion of a television program into written words which then appear as subtitles on the television screen. Closed captions allow viewers to read the dialogue and narration of television programs.

### Using Closed Captions

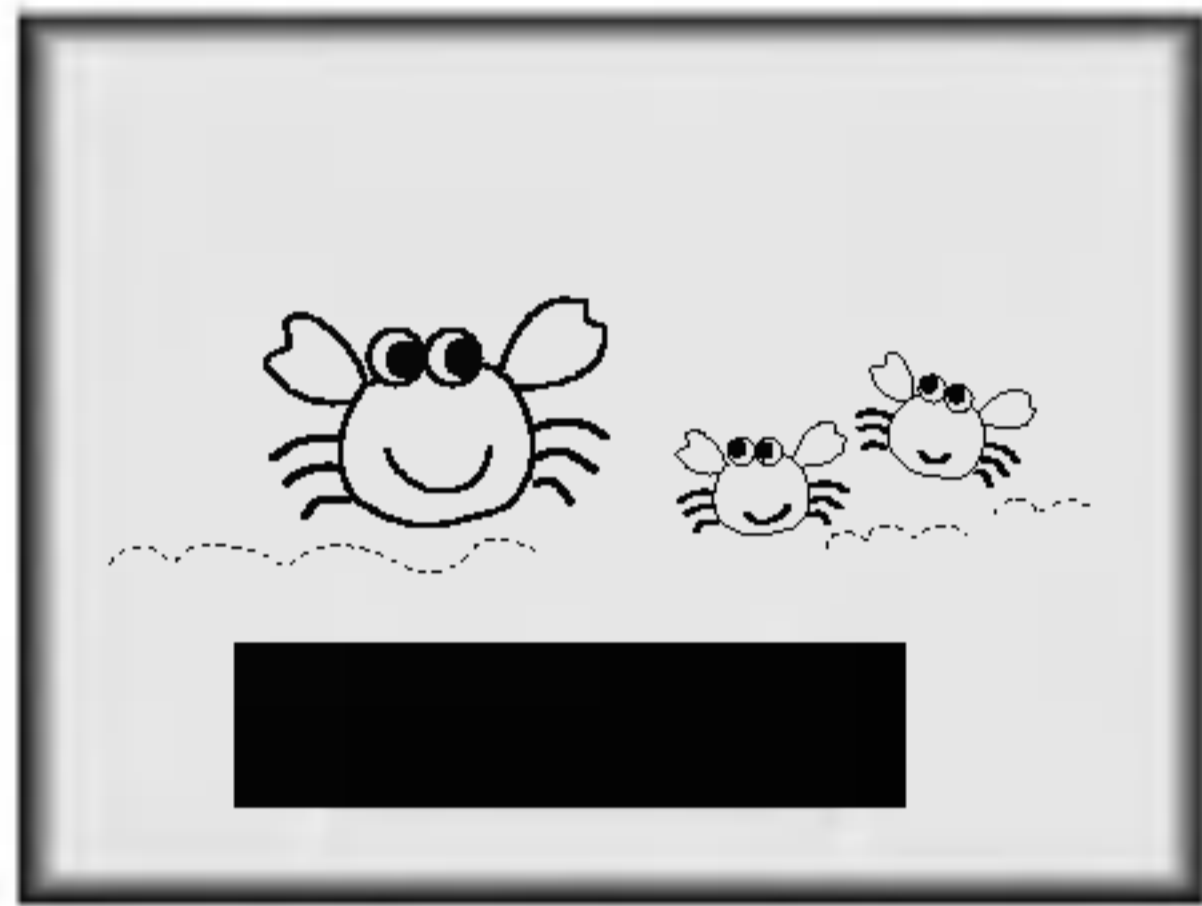

Captions are the subtitles of the dialogue and narration of television programs. For prerecorded programs, program dialogue can be arranged into captions in advance. It's possible to caption a live program by using a process called real-time captioning, which creates captions instantly. Real-time captioning is normally done by professional reporters using a machine shorthand system and computer for translation into English.

Captioning is an effective system for the hearing-impaired, and it can also aid in teaching language skills.

- The picture at left shows a typical caption.

### Caption Tips

- Not all TV broadcasts include closed caption signals.
- Sometimes TV stations broadcast four different caption signals on the same channel. By selecting **Mode 1** or **Mode 2**, you can choose which signal you view. **Mode 1** is usually the signal with the captions, while **Mode 2** might show demonstration or programming information.
- Your TV might not receive caption signals normally in the following situations.

1. Poor reception conditions are encountered:



- **IGNITION:**

Picture may flutter, drift, suffer from black spots, or horizontal streaking. Usually caused by interference from automobile ignition systems, neon lamps, electrical drills, and other electrical appliances.



- **GHOSTS:**

Ghosts are caused when the TV signal splits and follows two paths. One is the direct path and the other is reflected off tall buildings, hills or other objects. Changing the direction or position of the antenna may improve reception.



- **SNOW:**

If your receiver is located at the weak, fringe area of a TV signal, your picture may be marred by small dots. It may be necessary to install a special antenna to improve the picture.

2. An old, bad, or illegally recorded tape is being played.
3. Strong, random signals from a car or airplane interfere with the TV signal.
4. The signal from the antenna is weak.
5. The program wasn't captioned when it was produced, transmitted, or taped.



1. Use the **CAPTION** button to select your caption selection as shown below.



• You can also adjust **Caption** in the **Special** menu.



- The TV can be set up so that it can only be used with the remote control.
- This feature can prevent unauthorized viewing.

1. Press the **MENU** button and then use **▲ / ▼** button to select the **Special** menu.
2. Press the **▶** button and then use **▲ / ▼** button to select **Key lock**.
3. Use the **◀ / ▶** button to select **On** or **Off**.
4. Press the **EXIT** button to save and return to TV viewing.



- If Auto Off is active and there is no input signal, the TV switches to Standby mode automatically after 10 minutes.

1. Press the **MENU** button and then use **▲ / ▼** button to select the **Special** menu.
2. Press the **▶** button and then use **▲ / ▼** button to select **Auto off**.
3. Use the **◀ / ▶** button to select **On** or **Off**.
4. Press the **EXIT** button to save and return to TV viewing.

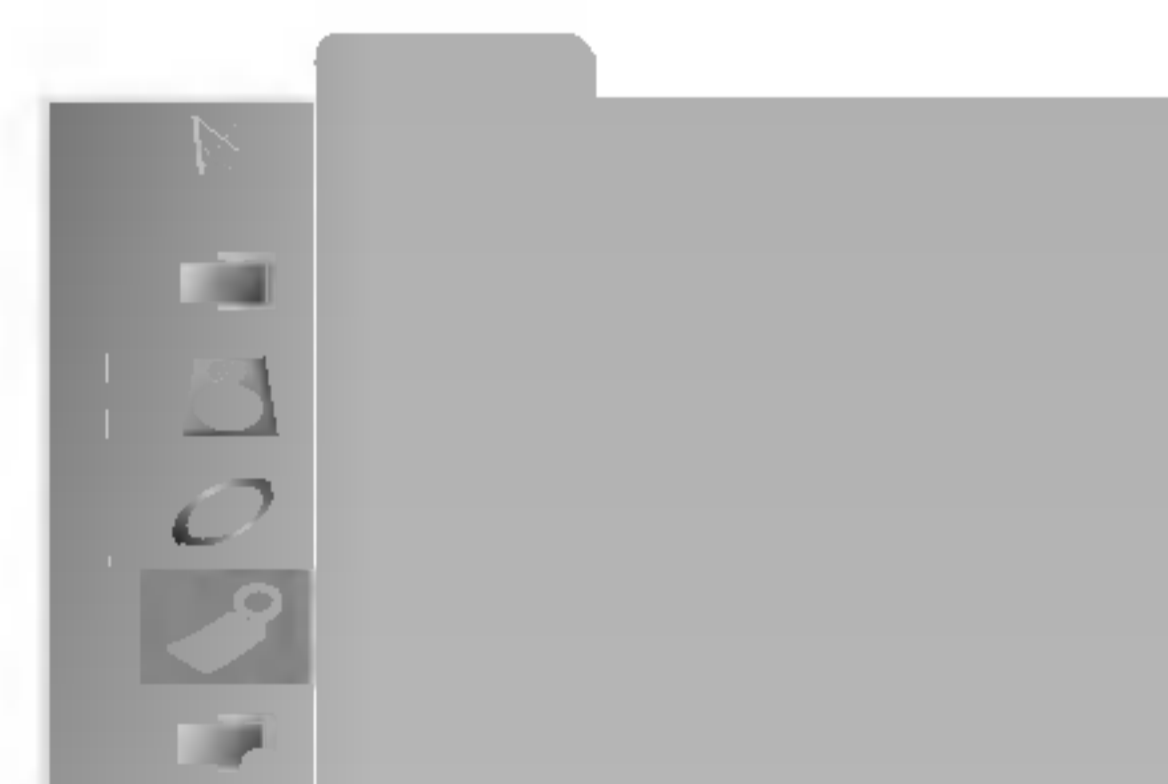

## RGB-PC Menu Options

- Be sure to select the RGB-PC source before operation.

- Automatically adjusts picture position and minimizes image shaking.
- If the image is still not correct, your TV is functioning properly but needs further adjustment.

1. Press the **MENU** button and then use ▲ / ▼ button to select the **RGB-PC** menu.
2. Press the ► button and then use ▲ / ▼ button to select **Auto configure**.
3. Press the ► button to run Auto configure.
  - If the position of the image is still not correct, try Auto adjustment again.
4. If picture needs to be adjusted more after Auto adjustment in RGB-PC mode, you can adjust the **Clock / Phase**.



1. Press the **MENU** button and then use ▲ / ▼ button to select the **RGB-PC** menu.
2. Press the ► button and then use ▲ / ▼ button to select **H-Position / V-Position**.
3. Press the ◀ / ▶ button to make adjustments.
  - The adjustment range is 0 ~ 100.
4. Press the **EXIT** button to save and return to TV viewing.

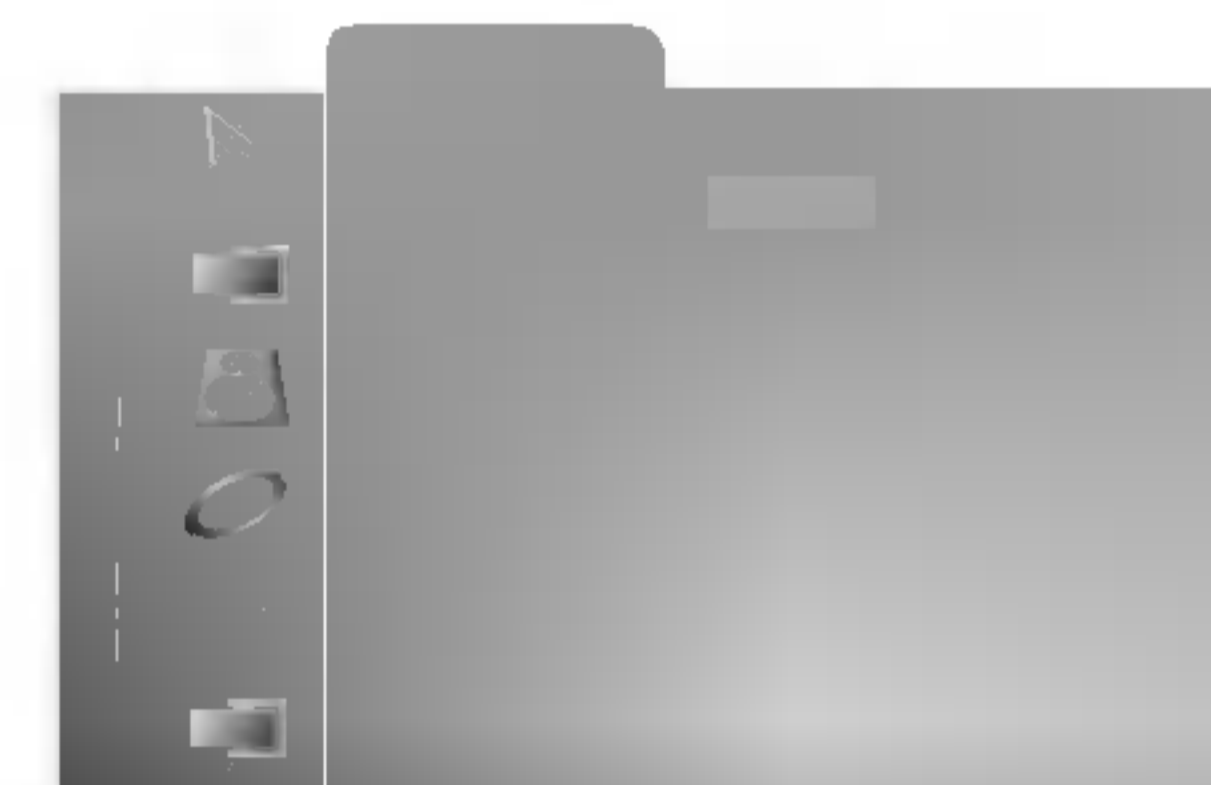

- If the picture isn't clear after auto adjustment and especially if characters are still jittery, adjust the picture Phase manually.

1. Press the **MENU** button and then use ▲ / ▼ button to select the **RGB-PC** menu.
2. Press the ► button and then use ▲ / ▼ button to select **Clock** or **Phase**.
3. Use the ◀ / ▶ button to make appropriate adjustments.
  - The **Clock** adjustment range is 0 ~ 100.
  - The **Phase** adjustment range is 0 ~ 31.
  - Based on the input mode, the adjustment range for **Clock / Phase** may change.
4. Press the **EXIT** button to save and return to TV viewing.

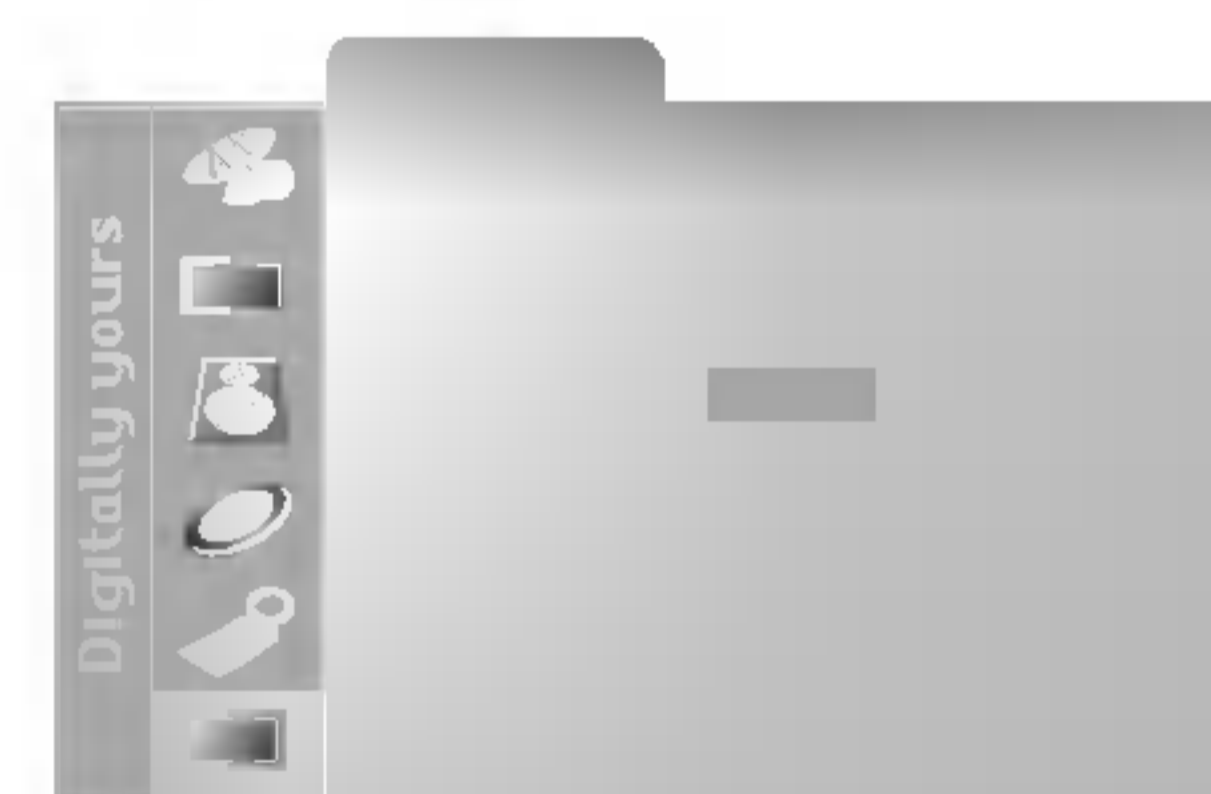

# PIP (Picture-in-Picture) Feature

- PIP lets you view 2 different inputs pictures (sources) on your TV screen at the same time. One source will be large, and the other source will show a smaller inset image.
- Double Window splits the screen into 2, allowing 2 picture sources to be shown on the TV screen at the same time. Each source is given half the screen.



Press the **PIP** button repeatedly to select one of the PIP options.

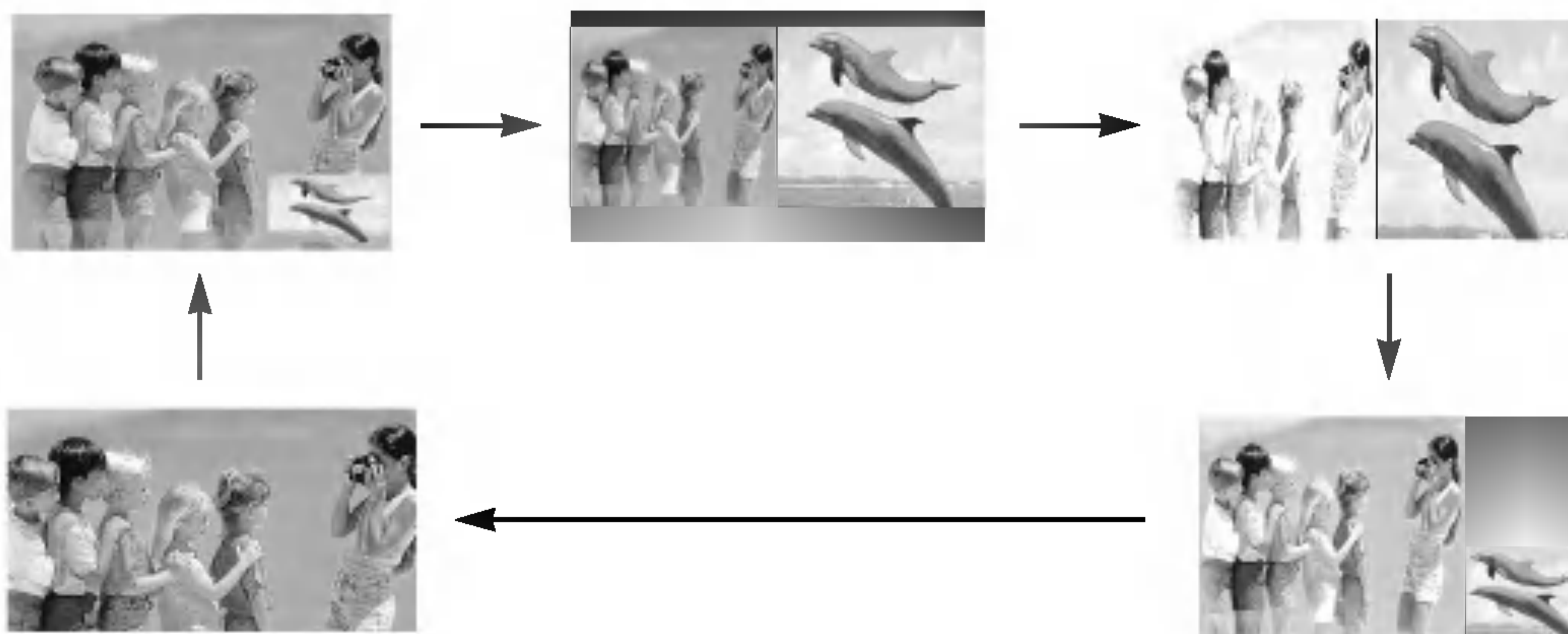

\* You can only select this Double Window using RGB-PC for main picture source. With this setup, the main and sub pictures cannot be swapped.



Use the **CH ▲ / CH ▼** button to select a channel for the sub picture in PIP mode.



1. Press the **STILL** button in PIP mode.
  - In PIP mode, the PIP (inset) picture's image is frozen.
2. To return to normal viewing, press the **STILL** button again.



Press the **SIZE** button and then use **◀ / ▶** button to change the sub picture size.



Press the **POSITION** button in PIP mode. Press the **▲ / ▼ / ◀ / ▶** button repeatedly until desired position is achieved. The sub picture moves up/down/left/right.



## PIP (Picture-in-Picture) Feature Continued



Press the **PIP SWAP** button to switch the main and sub pictures.

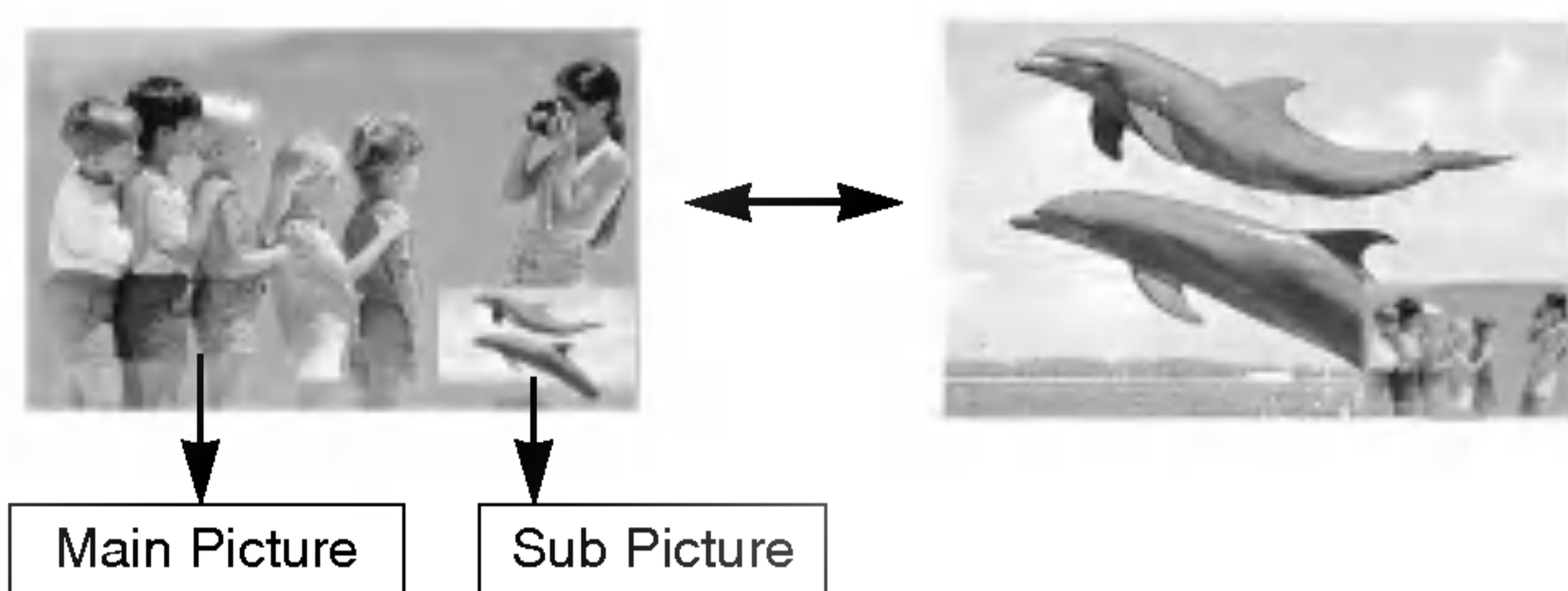

Use the **PIP INPUT** button to select the input source for the sub picture. Each press of **PIP INPUT** button changes the PIP source.

| Main Picture Source        | Available Sub Picture Sources |
|----------------------------|-------------------------------|
| TV, Video, S-Video, or DVD | Component, or RGB-PC          |
| Component, or RGB-PC       | TV, Video, S-Video, or DVD    |



- Use POP to search the programs of all the memorized channels one-by-one, while the main picture source remains the current channel.
- Press the **SCAN** button in PIP mode. Each press of **SCAN** button changes the screen as shown below.
- Note: Run Auto program channel search before using POP mode.

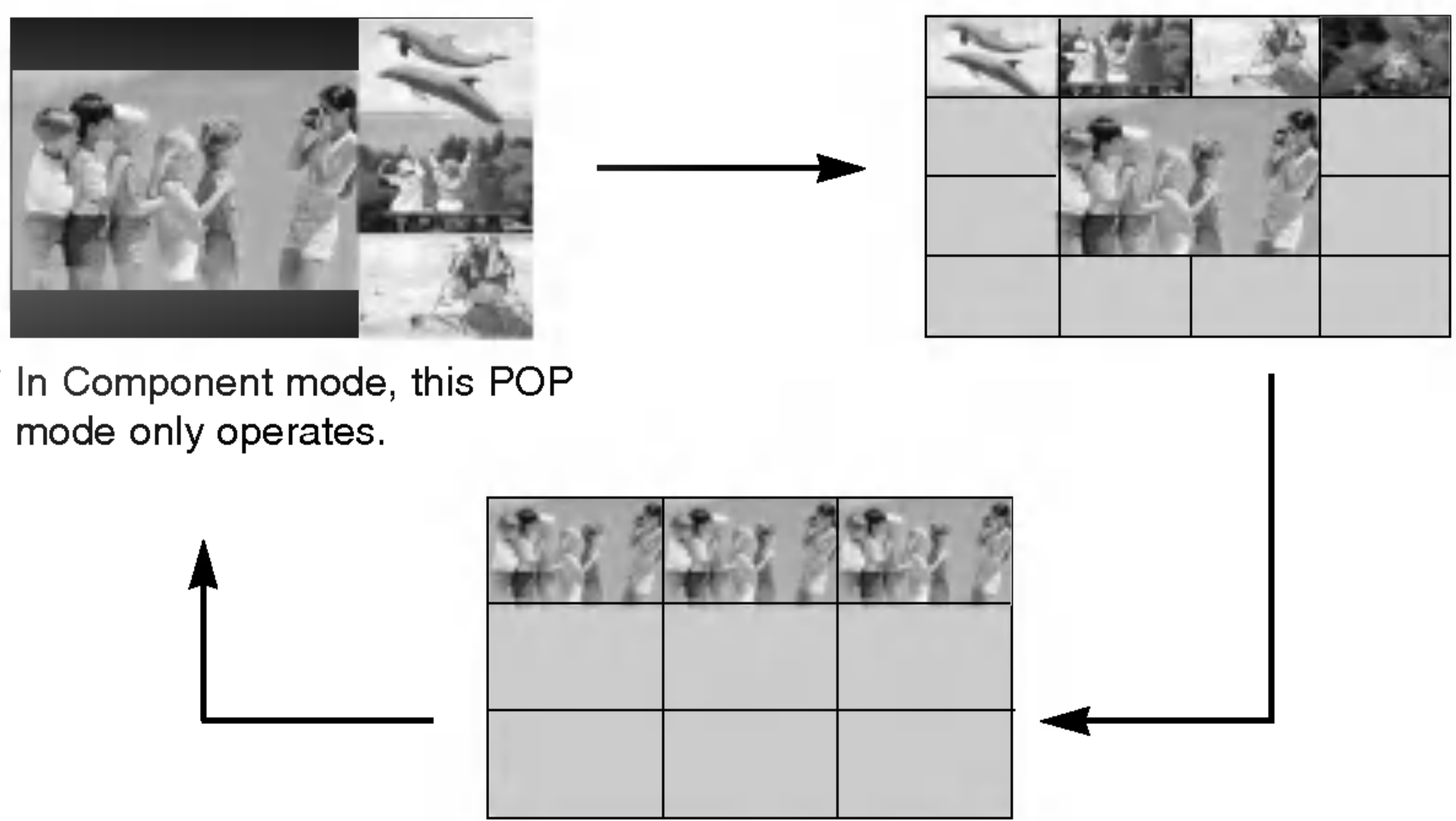

# Notes on Discs

- Do not touch the playback side of the disc.
- Do not attach paper or tape to discs.



- Do not store discs in a place subject to direct sunlight or near heat sources.
- Do not store discs in place subject to moisture and dust such as a bathroom or near a humidifier.
- Store discs vertically in a case. Stacking or placing object on discs outside of their case may cause warping.

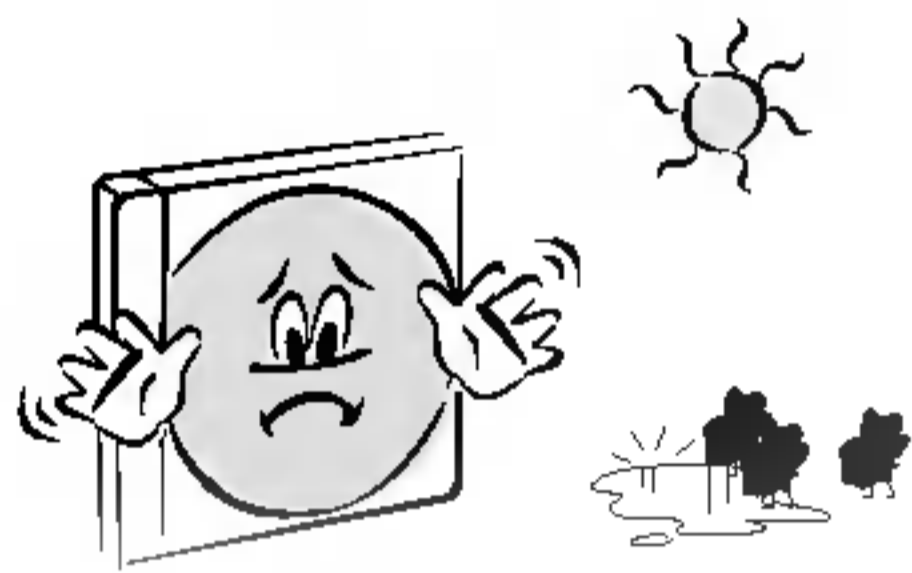

- Fingerprints and dust on the disc cause picture and sound deterioration. Wipe the disc from the center outward with a soft cloth. Always keep the disc clean.
- Do not use any type of solvent such as thinner, benzene, commercially available cleaners or antistatic spray for vinyl LPs. Doing so may damage the disc.



## DVD Video Disc Structure

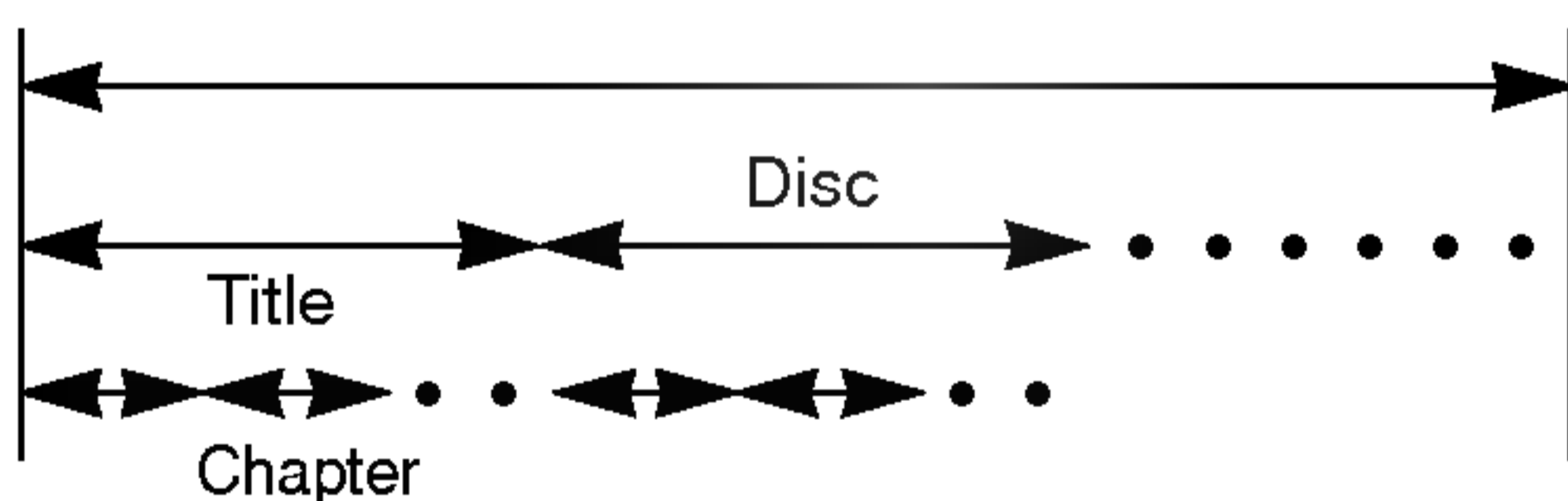

## Video CD/Audio CD Structure

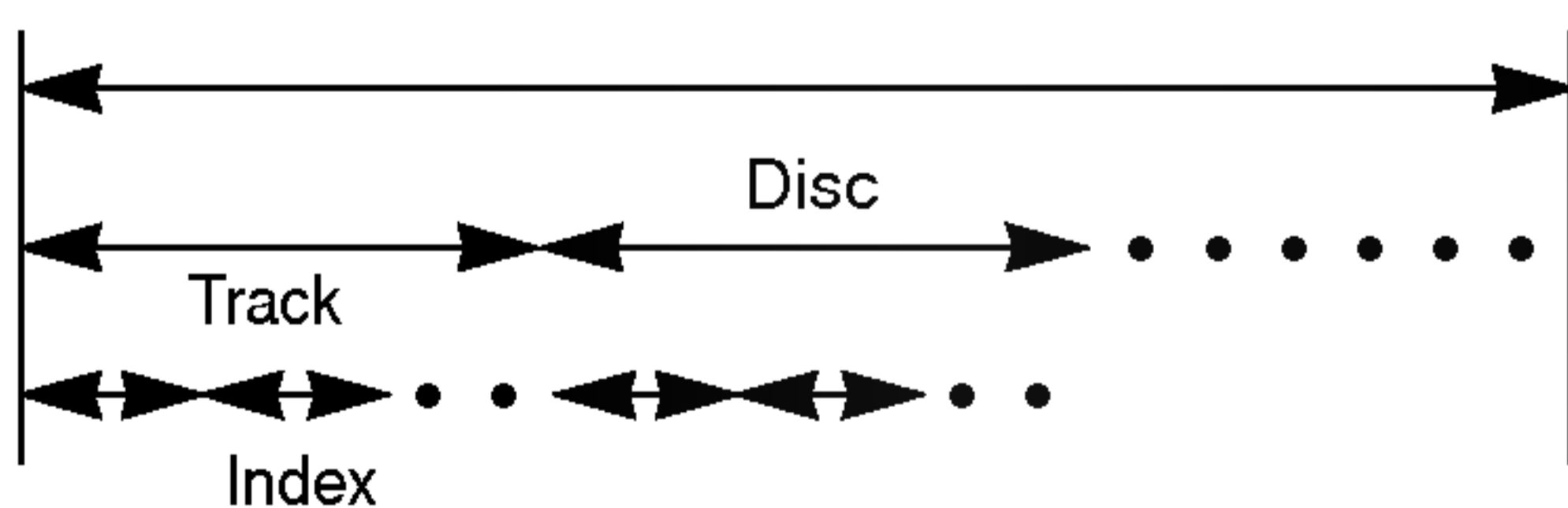

- **Title:** When two or more movies are recorded on a disc, the disc is divided into two or more parts. Each part is called a "TITLE".
- **Chapter:** The titles can be subdivided into many sections. Each section is called a "CHAPTER".
- **Track:** An audio CD can contain several items. These are assigned to the tracks.

## Notes

- If an MP3 or JPEG file CD is created using an incorrect method, the player may not be able to recognize it. If this happens, try reburning another CD after setting up the disc writing parameters correctly on your PC.
- Manufactured under license from Dolby Laboratories. "Dolby" and the double-D symbol are trademarks of Dolby Laboratories.

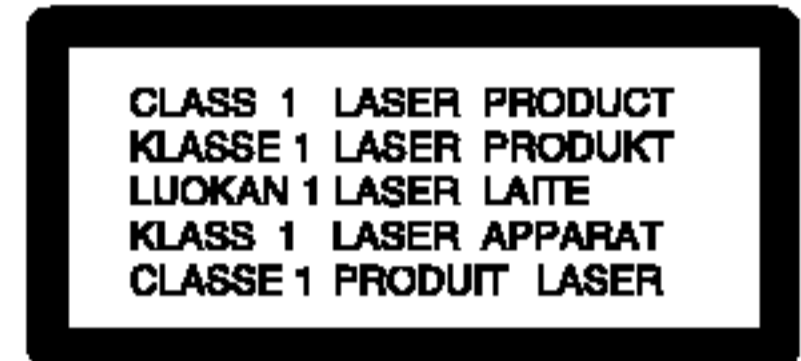

## CAUTION:

This Digital Video Disc Player employs a Laser System. To ensure proper use of this product, please read this owner's manual carefully and retain for future reference should the unit require maintenance, contact an authorized service location (see service procedure). Use of controls, adjustments, or the performance of procedures other than those specified herein may result in hazardous radiation exposure. To prevent direct exposure to laser beam, do not try to open the enclosure. Visible laser radiation when open. **DO NOT STARE INTO BEAM.**

**CAUTION:** The apparatus should not be exposed to water (dripping or splashing) and no objects filled with liquids, such as vases, should be placed on the apparatus.

## Regional code of the DVD player and DVDs

This DVD player is designed and manufactured for playback of region "1" encoded DVD software. The region code on the labels of some DVD discs indicates which type of player can play those discs. This unit can play only DVD discs labeled "1" or "ALL". If you try to play any other discs, the message "Check Regional Code" will appear on the TV screen. Some DVD discs may not have a region code label even though their playback is prohibited by area limits.



"DTS" and "DTS Digital Surround" are trademarks of Digital Theater System, Inc.

APPARATUS CLAIMS OF U.S. PATENT NOS. 4,631,603, 4,577,216, 4,819,098, AND 4,907,093 LICENSED FOR LIMITED VIEWING USER ONLY.

# DVD & VCD Operation

1. Press the **POWER** button to turn the unit on.
2. Slide your chosen disc into the disc slot on the side panel. Be sure to face the top of the disc (with title etc.) toward the front of the screen. Playback starts.
3. Press the **OPEN/CLOSE** button to remove the disc.

1. Press the **STOP** button to stop playback. At this time, DVD/VCD player stops playback temporarily and maintains the current playback position.
2. Press the **STOP** button again to stop playback fully. (At this time, if you press **PLAY/PAUSE** ►/|| button, disc playback start from the beginning.)

1. Press the **PLAY/PAUSE** ►/|| button during playback.
2. Press the **PLAY/PAUSE** ►/|| button again to return to normal playback.

**Note :**

- a. Press the **PLAY/PAUSE** ►/|| button to return to DVD mode in TV, Video or RGB-PC mode.
- b. If you have a disc problem during playback, remove the disc by pressing and holding down the **OPEN/CLOSE** button on the side panel for more than 4 seconds.

1. Press the **SCAN** ►► or ◀◀ **SCAN** button during playback.  
Each time you press **SCAN** ►► or ◀◀ **SCAN** button, the playback speed changes as shown.
  - **scan** ►►: ►► 2x → ►► 4x → ►► 8x → ►► 16x → ►► 32x → 1x.
  - ◀◀ **scan**: ◀◀ 2x → ◀◀ 4x → ◀◀ 8x → ◀◀ 16x → ◀◀ 32x → 1x.
2. Press the **PLAY/PAUSE** ►/|| button to resume normal playback.

1. Press the **PLAY/PAUSE** ►/|| button and then press **SCAN** ►► or ◀◀ **SCAN** button.  
Each time you press **SCAN** ►► or ◀◀ **SCAN** button, the playback speed changes as shown:
  - **SCAN** ►►: ►► 1/2 → ►► 1/4 → ►► 1/8 → ►► 1/16 → 1x.
  - ◀◀ **SCAN**: ◀◀ 1/2 → ◀◀ 1/4 → ◀◀ 1/8 → ◀◀ 1/16 → 1x. (DVD only)
2. Press the **PLAY/PAUSE** ►/|| button to resume normal playback.

**Note :** There is no sound during fast or slow playback for DVDs or Video CDs.

1. Press the **SKIP** ►►I button or I◀◀ **SKIP** button to locate a desired chapter during playback. Each time you press the button, a chapter or track is skipped.

1. Press the **SKIP** ►►I button or I◀◀ **SKIP** button in the still mode, one frame is displayed at a time. This function maybe operate differently depending on the disc type. (The backward frame function doesn't work in VCD disc.)

**Note :** “⊘” may appear on the TV screen during operation. A “⊘” means that the operation is not permitted by the unit or is not available on the disc.

- You can display the playback status on TV screen as following; Title, Chapter number, Playing time.

1. Press the **ENTER** button during DVD playback. Title, Chapter information appears on screen. Each time you press the **enter** button, the OSD changes as follows.
  - DVD: Title Elapsed → Title Remain → Chapter Elapsed → Chapter Remain → Display off
  - VCD: Single Elapsed → Single Remain → Total Elapsed → Total Remain → Display off

**Note:** OSD display may different depending on a sort of DVD disc.

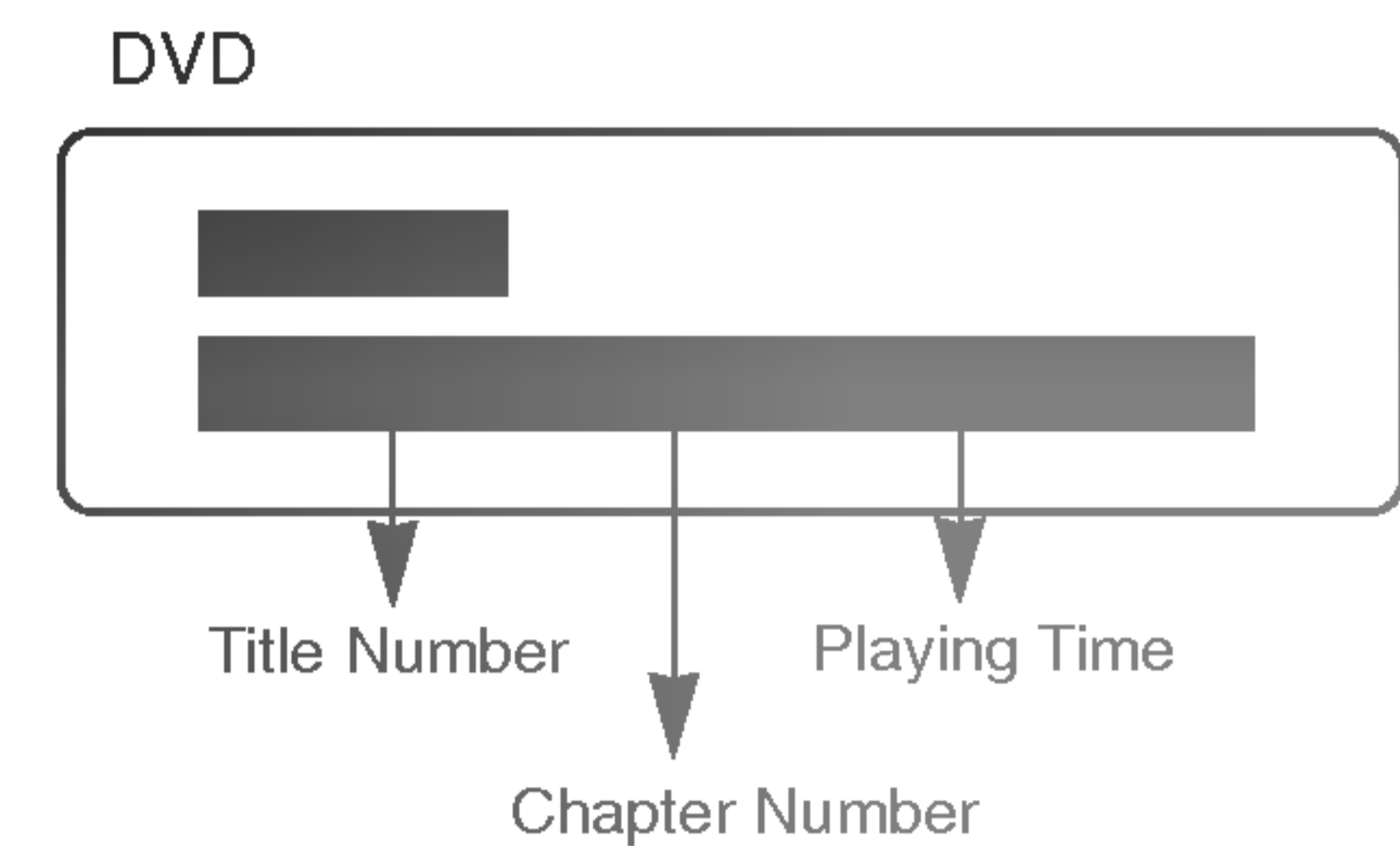

1. Press the **DISC MENU** button during playback.
2. Use the **▲ / ▼**, **◀ / ▶**, or **ENTER** button to select the desired menu option.

1. Press the **TITLE MENU** button during playback.
2. Use the **▲ / ▼**, **◀ / ▶**, or **ENTER** button to select the desired item.

**Note :** The unit may not be able to select the disc or title menu depending on a sort of DVD disc.

- You can play a specific title, chapter, track, or segment repeatedly.

1. Press the **REPEAT** button during playback. Each time you press the **REPEAT** button, the repeat mode changes as follows.
  - DVD : Chapter → Title → ALL → Repeat Off
  - VCD : Track → ALL → Repeat Off

- A-B repeat playback allows you to repeat material between two selected points.

1. Press the **A-B** button to select the start point during playback. " A" is displayed on TV screen and the starting point of your selected segment is set up.
2. Press the **A-B** button again to select the end point. " AB" is displayed on TV screen and the ending point is set up. Playback starts at the point that you selected. Playback stops at the end point, returns to Point A automatically, then starts again.
3. Repeatedly press the **A-B** button again to resume normal playback. "Off" appears on the screen.

- You can arrange the order of playback for tracks on a disc.

1. Press the **PROGRAM** button in the stop mode or during playback.
2. Use the **▲ / ▼** button to select the program position.
3. Use the **NUMBER** buttons to key in the desired Title and Track numbers.  
To program others, repeat Step steps 2 - 3.
4. Press the **PROGRAM** button to resume normal playback.

TT 01/03 CH 01/09 0:28:22

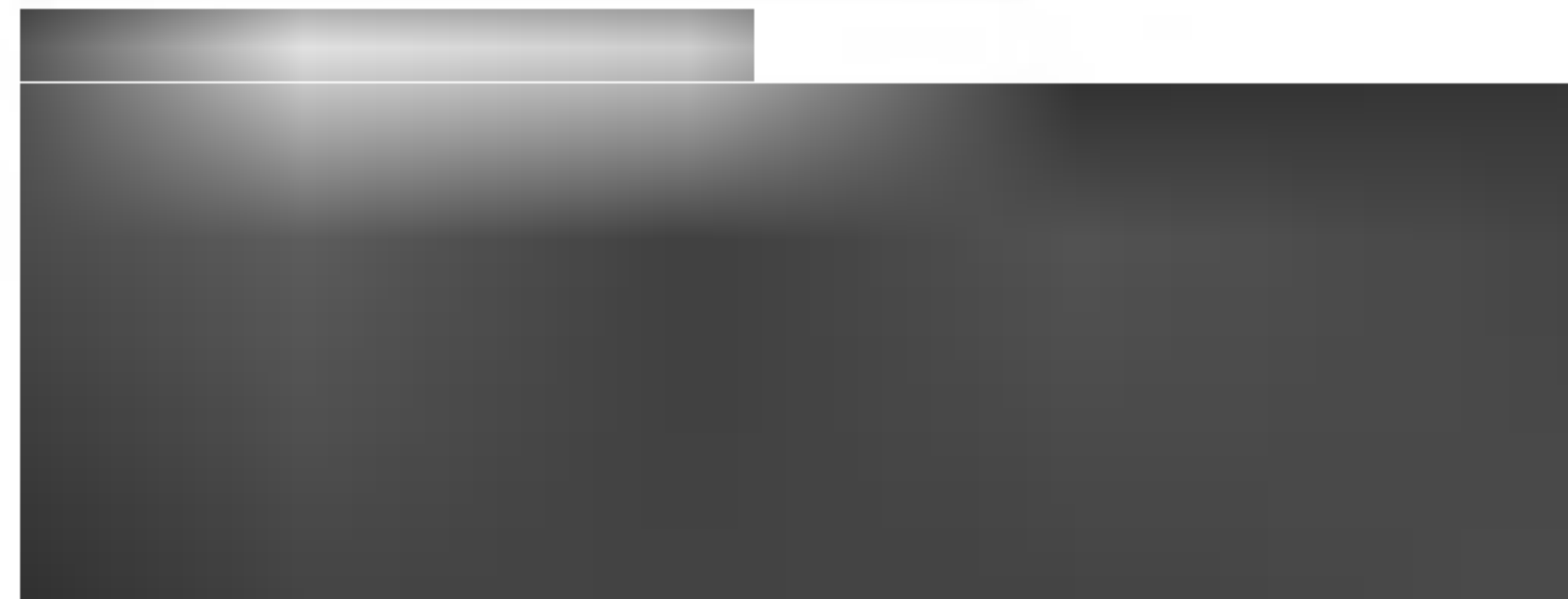

**Note:** Depending on the disc, programmed playback may not be possible.

- If the scene was recorded from multiple angles, you can easily change the camera angle of the scene you are currently watching.

1. Press the **ANGLE** button during playback.
2. Repeatedly press the **ANGLE** button to select the desired angle.

**Notes: :**

- a. You can only change the angle for DVDs that provide multiple angles of scenes.
- b. The angle function will not work on DVD video discs that do not contain scenes recorded at different angles.
- c. The number of angles varies from disc to disc.

- Take advantage of any multichannel format from just two speakers without the need to add extra speakers or equipment.

1. Press the **3D SOUND** button during playback.
2. Each press of the **3D SOUND** button changes the sound display as indicated below:  
: Off → Concert → Living room → Hall → Bathroom → Arena.

- When enlarging or reducing the picture, it may become distorted.

1. Press the **ZOOM** button during playback.
2. Each press of the **ZOOM** button changes the screen display as indicated below:  
: 2x, 3x, 4x, 1/2, 1/3, 1/4
3. Adjust the main picture position using the **▲ / ▼ / ◀ / ▶** buttons while in the enlarged picture mode.

## DVD Menu Options

- Select your preferred audio language. If an audio language is selected, the selected audio language is played whenever you start a new disc playback. (The disc must contain the selected language )
- You can also select another available audio language during playback with the **audio** button on the remote control during playback.

1. Press the **MENU** button twice and then use the **▲ / ▼** button to select **Audio Language**.
2. Press the **▶** button and then use **▲ / ▼** button to select your desired language.
3. Press the **ENTER** button.
4. Press the **EXIT** button to resume normal playback.

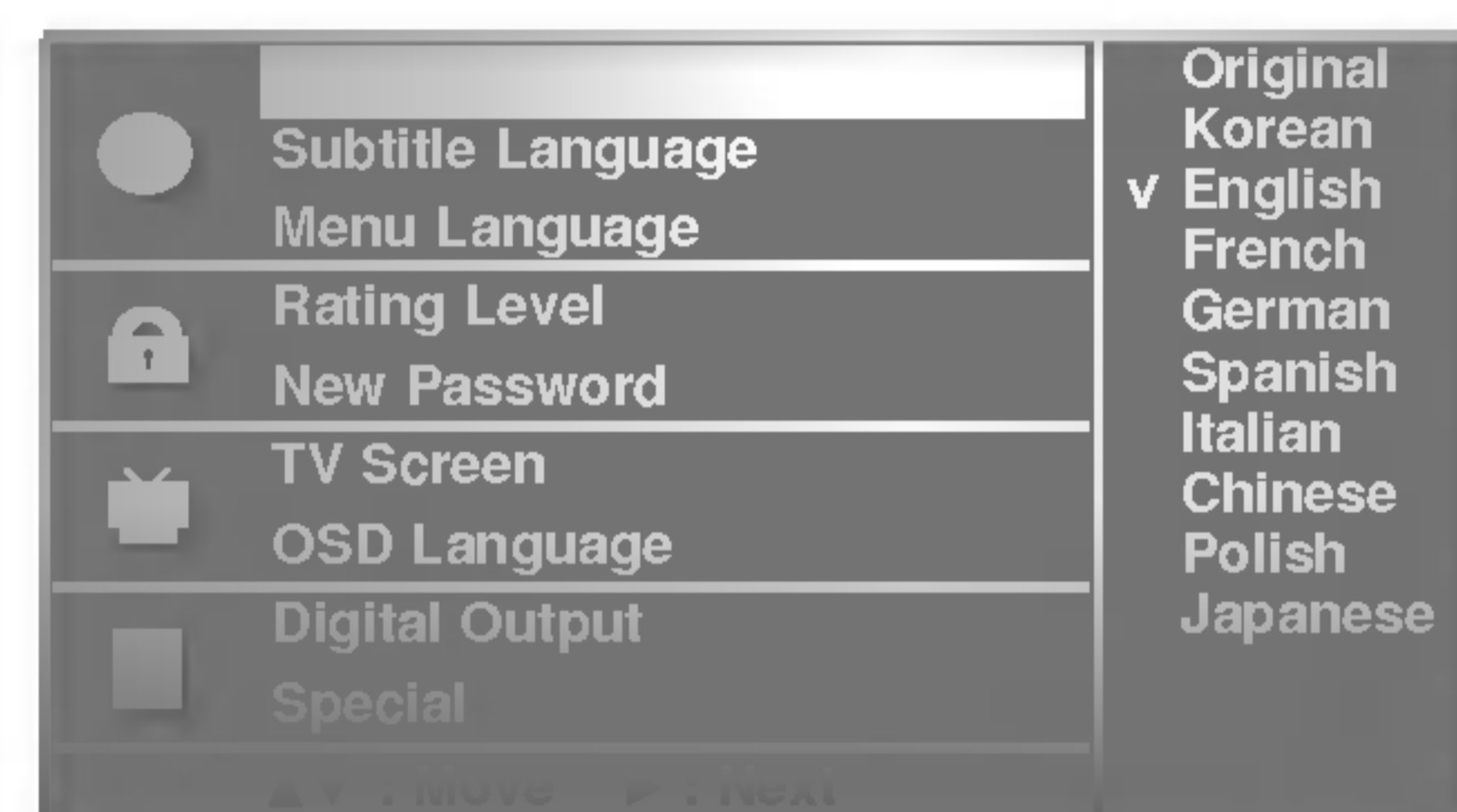

- Select your preferred subtitle language. If a subtitle language is selected, the selected subtitle language is played whenever you start a new disc playback. (The disc must contain the selected language)
- You can also select another available subtitle language during playback with the **sub-t** button on the remote control during playback.

1. Press the **MENU** button twice and then use the **▲ / ▼** button to select **Subtitle Language**.
2. Press the **▶** button and then use **▲ / ▼** button to select your desired language.
3. Press the **ENTER** button.
4. Press the **EXIT** button to resume normal playback.

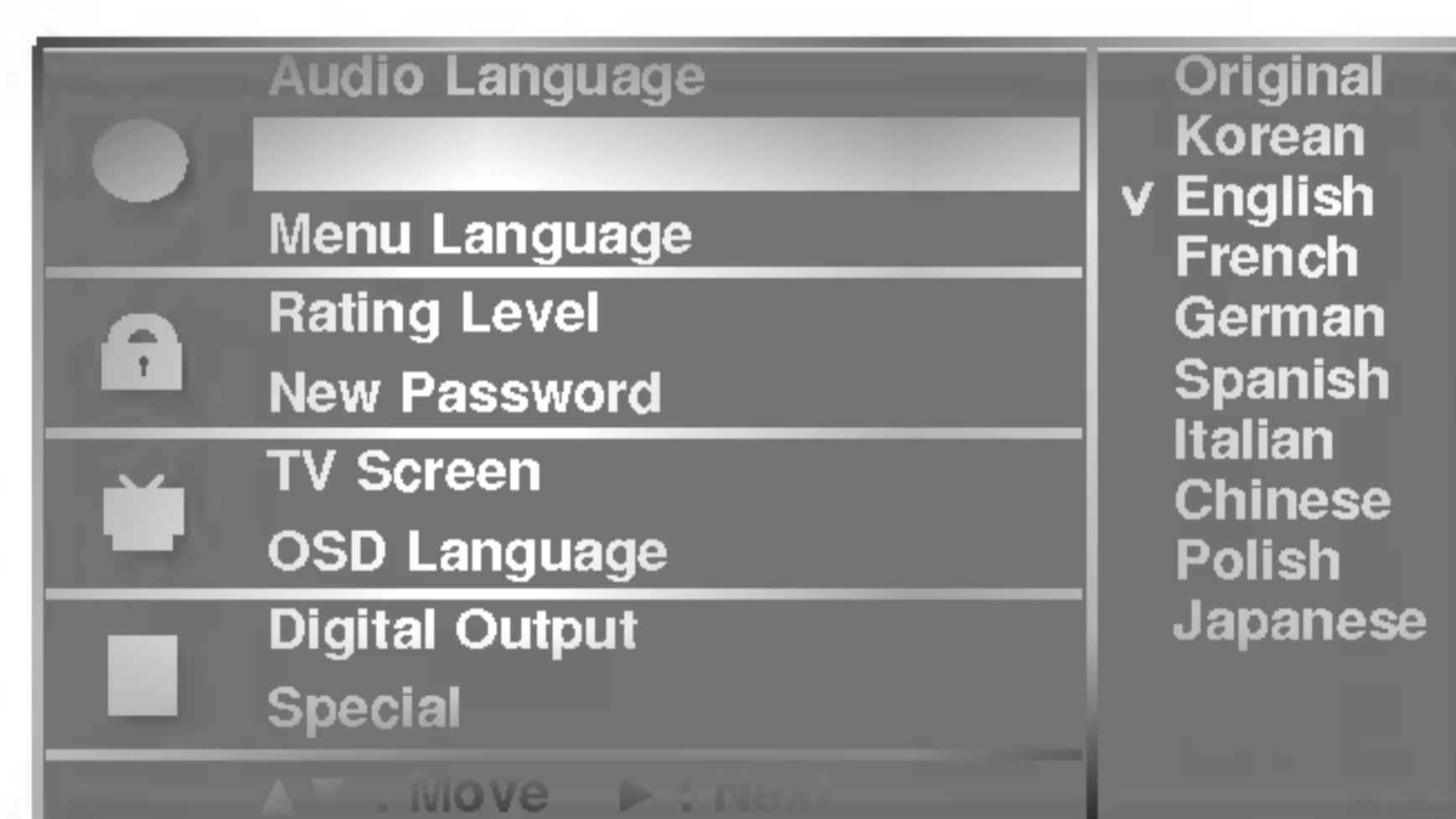

- Select your preferred language for the disc menus and DVD messages. (The disc must contain the selected language)

1. Press the **MENU** button twice and then use the **▲ / ▼** button to select **Menu Language**.
2. Press the **▶** button and then use **▲ / ▼** button to select your desired language.
3. Press the **ENTER** button.  
The menus and on screen displays will appear in the selected language.
4. Press the **EXIT** button to resume normal playback.

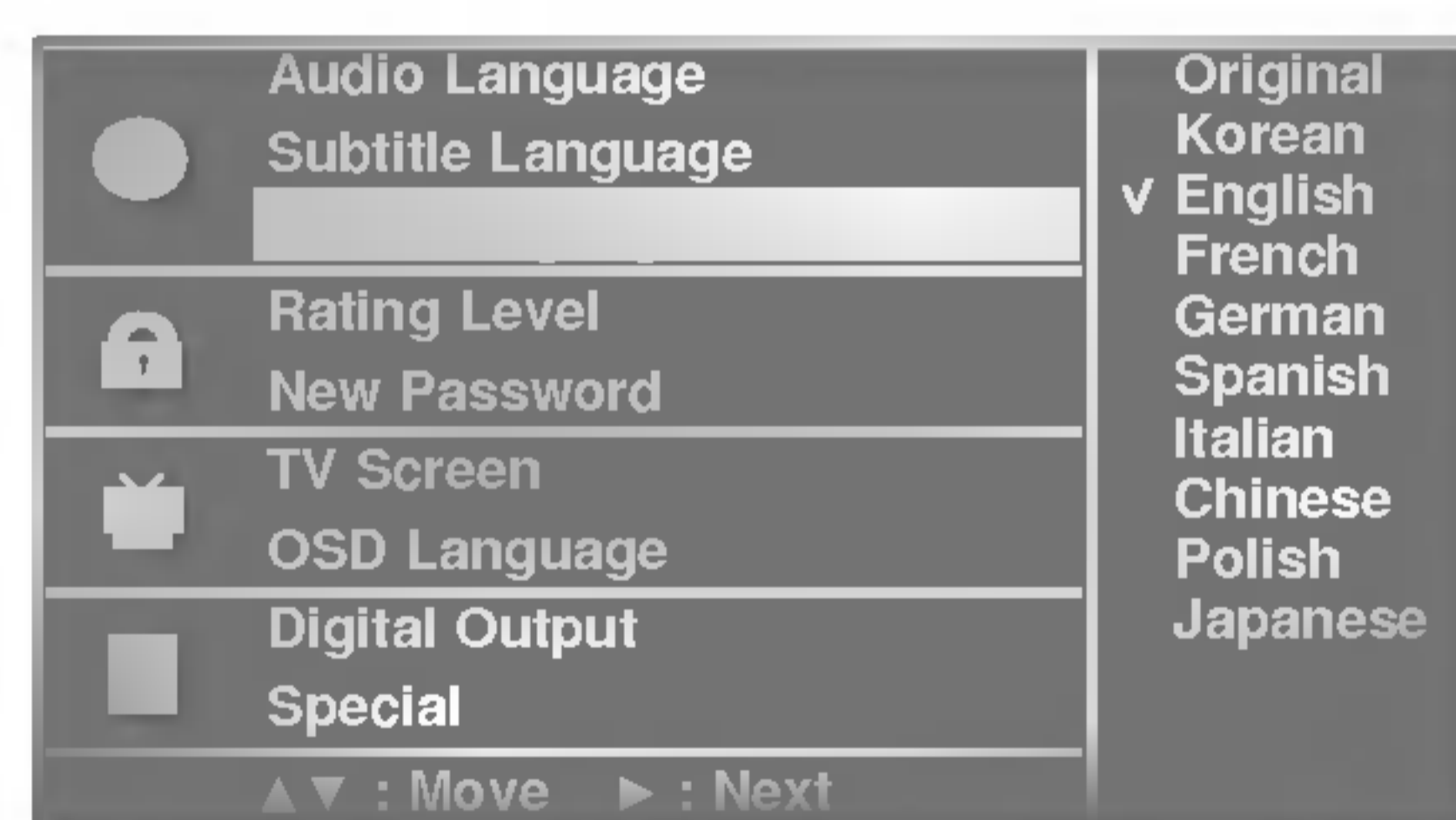

- Use to block viewing of unsuitable discs.

1. Press the **MENU** button twice and then use the **▲ / ▼** button to select **Rating Level**.
2. Press the **▶** button and then use number buttons to key in a 4-digit password. Be sure to remember the password! If you key in an incorrect number, press the **EXIT** button and start over.
3. Use the **▲ / ▼** button to set the restriction level from 0 to 8. Viewing becomes more restricted as the number increases.
  - 0: Unlock
  - 1: Kids
  - 2: G (General audience)
  - 3: PG (Parental guidance suggested)
  - 4: PG-13 (13 years and older)
  - 5: PG-r
  - 6: R (Restricted)
  - 7: NC-17 (18 years and older)
  - 8: Adult (Adults only)
4. Press the **EXIT** button to resume normal playback.

**Note:** If you ever forget your password, key in '7', '7', '7', '7' on the remote control.

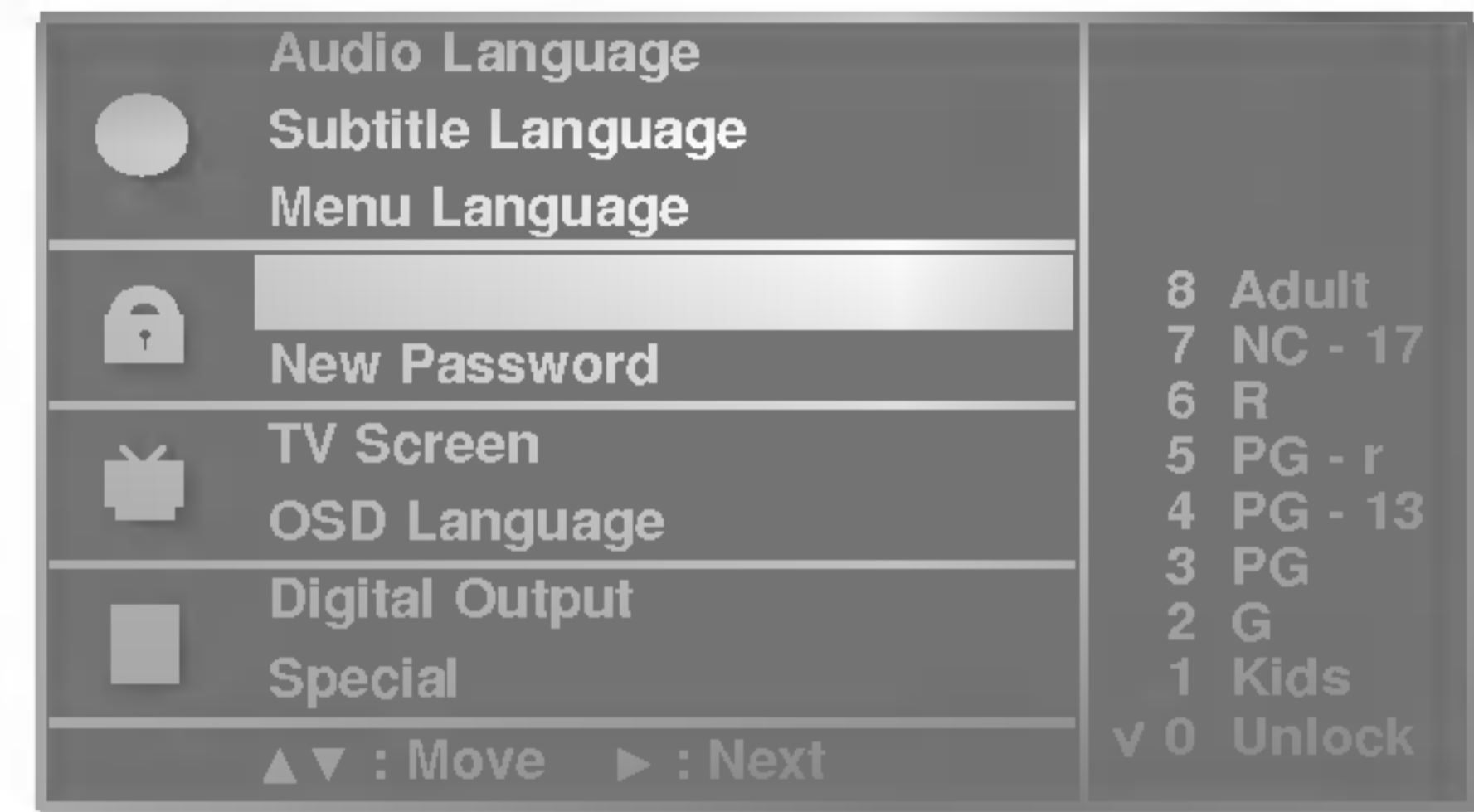

1. Press the **MENU** button twice and then use the **▲ / ▼** button to select **Rating Level**.
2. Press the **▶** button and then use number buttons to key in a 4-digit password.
3. Press the **◀** button and then use the **▲ / ▼** button to select **New password**.
4. Press the **▶** button and then enter a 4 digit password. Enter it again when requested.
5. Press the **EXIT** button to resume normal playback.

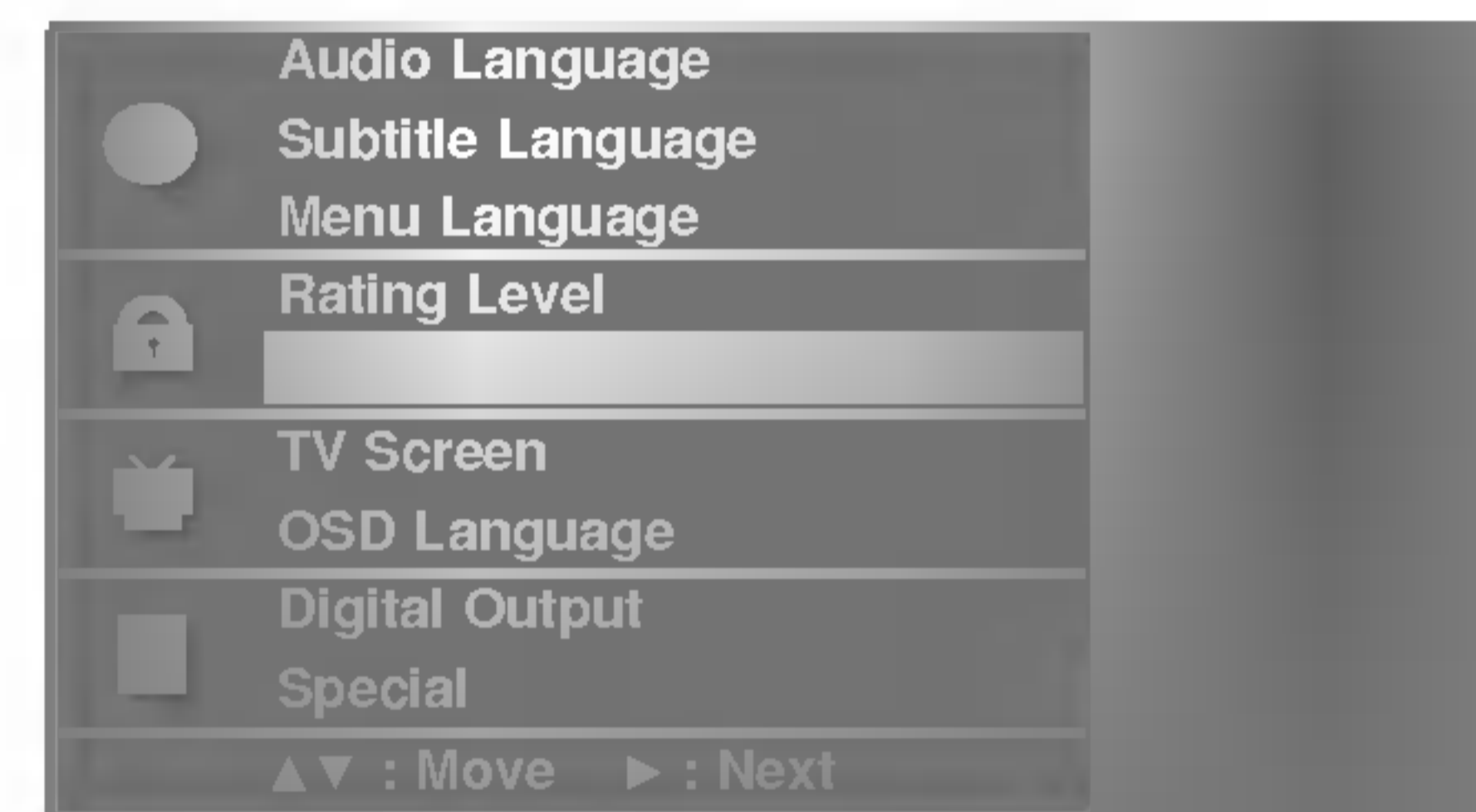

- You can watch TV in various picture formats.

1. Press the **MENU** button twice and then use the **▲ / ▼** button to select **TV Screen**.
2. Press the **▶** button and then use **▲ / ▼** button to select **4 : 3 LB**, **4 : 3 PS**, or **16 : 9 Wide**.
3. Press the **ENTER** button.
4. Press the **EXIT** button to resume normal playback.

**Note :** Depending on the disc, the TV screen feature may not be available.

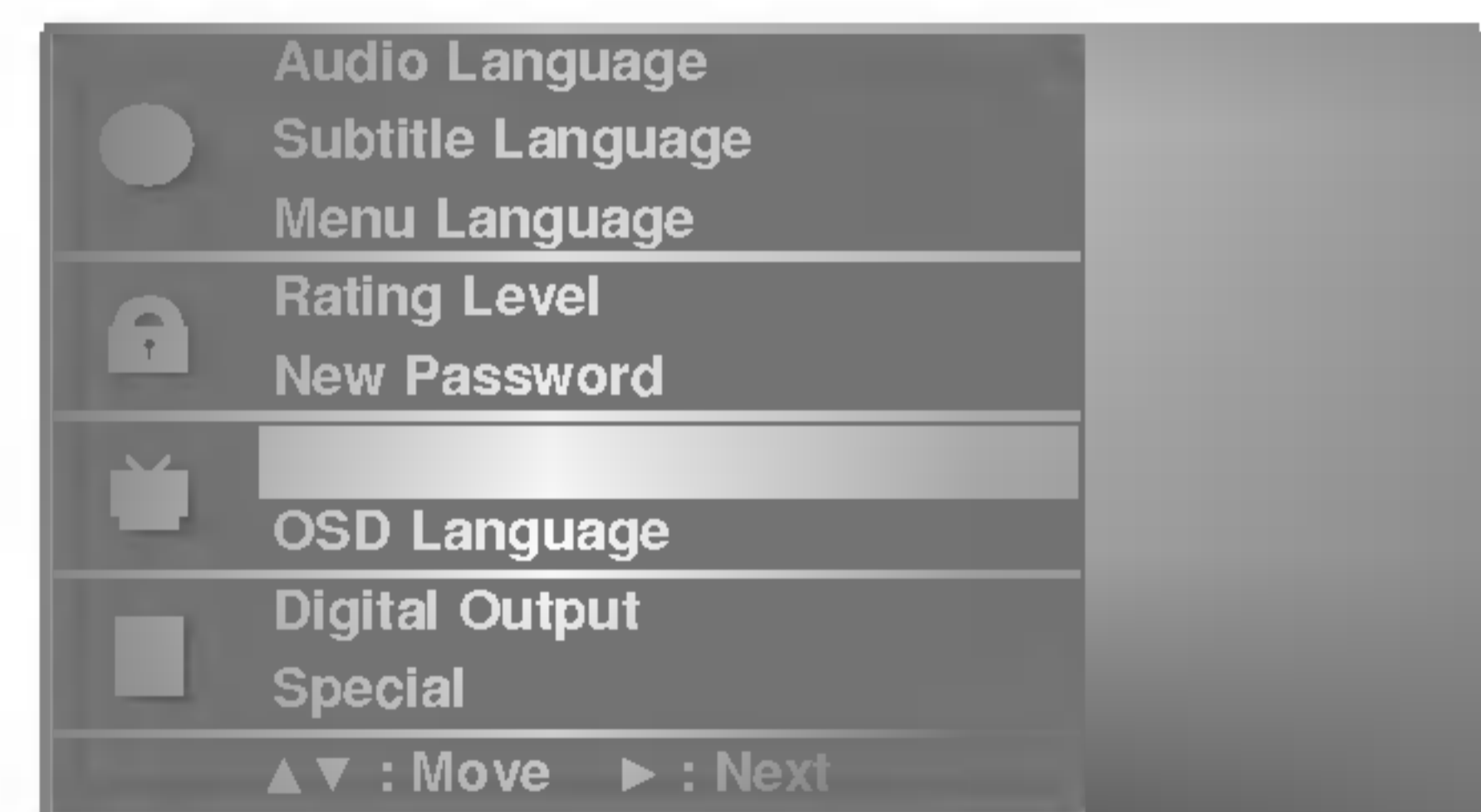

Letter Box (4:3 LB)



Pan & Scan (4:3 PS)



16:9 Wide

## DVD Menu Options Continued

- The onscreen display can be shown on the screen in your specified language.

1. Press the **MENU** button twice and then use the **▲ / ▼** button to select **OSD Language**.
2. Press the **▶** button and then use **▲ / ▼** button to select your desired language. All the on screen displays will appear in the selected language.
3. Press the **EXIT** button to resume normal playback.

- You can select the output for SPDIF (Sony/Philips Digital Interface).

1. Press the **MENU** button twice and then use the **▲ / ▼** button to select **Digital Output**.
2. Press the **▶** button and then use **▲ / ▼** button to select **OFF**, **Raw** (Original SPDIF signal), or **PCM** (Pulse Code Modulation: Encodes SPDIF signal to PCM).
3. Press the **ENTER** button.
4. Press the **EXIT** button to resume normal playback.

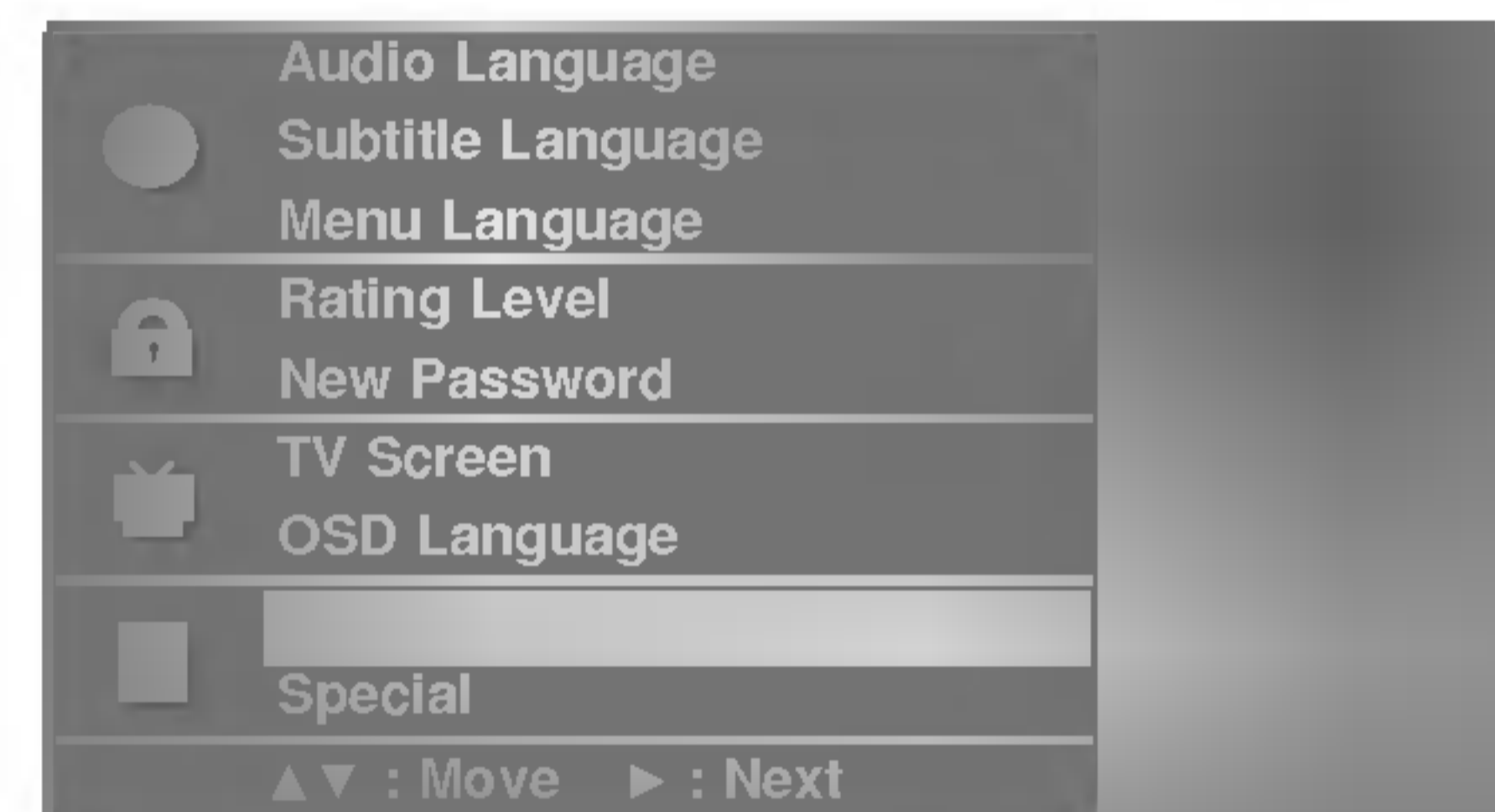

- Confines the audio range to prevent excessively loud sound yet allows you to hear the low sounds clearly.

1. Press the **MENU** button twice and then use the **▲ / ▼** button to select **Special**.
2. Press the **▶** button and then use **▲ / ▼** button to select **DRC Off** (Decrease the DRC range) or **DRC On** (Reset the DRC range to original values).
3. Press the **ENTER** button.
4. Press the **EXIT** button to resume normal playback.

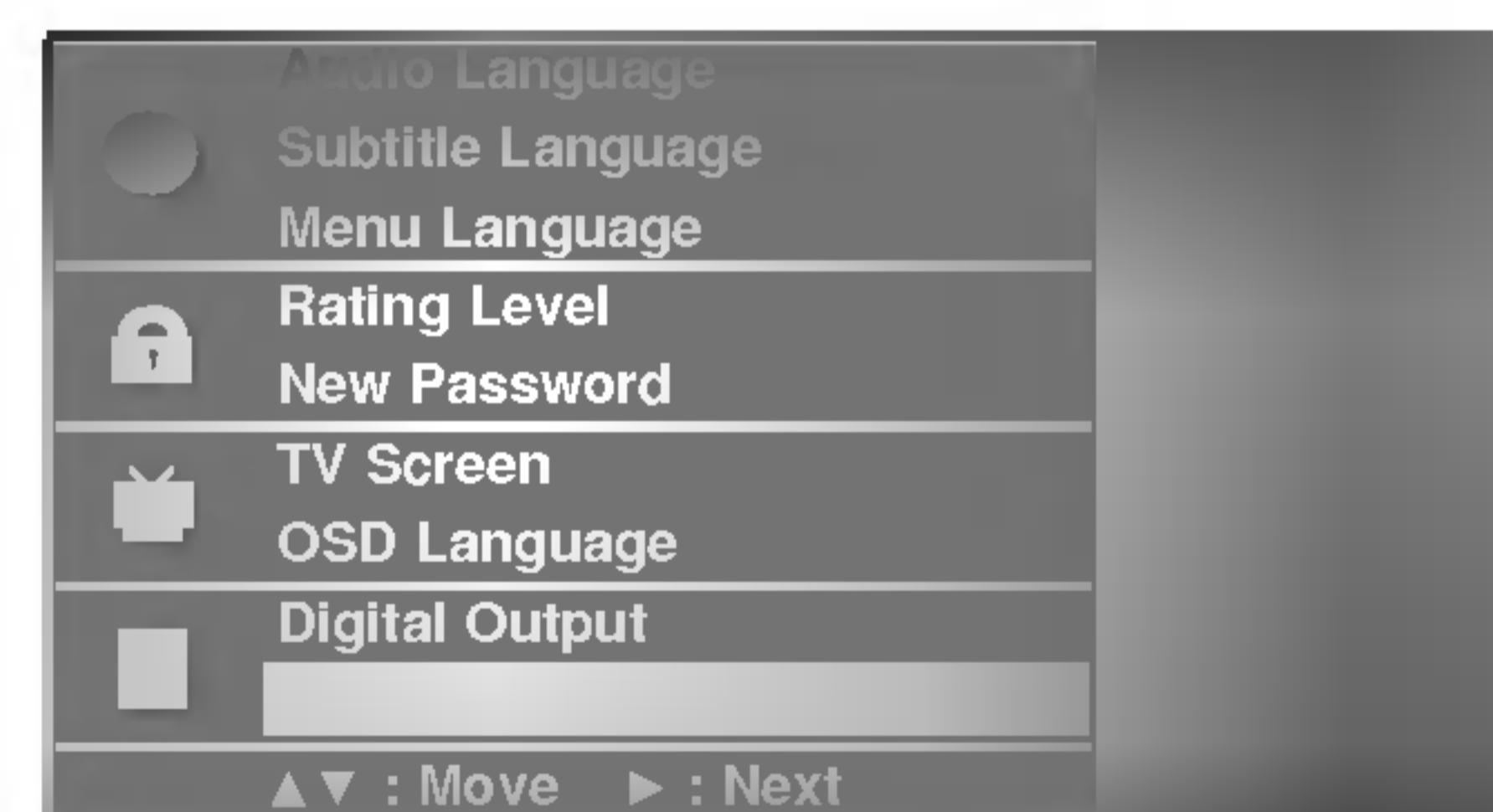

# MP3 Files Operation

1. When inserted, the MP3 menu screen appears automatically depending on the MP3 disc's folder (directory) structure as shown to the right.
2. Use the ▲ / ▼ to find desired folder and then press the **ENTER** button.
3. Use the ▲ / ▼ button to find the desired MP3 title and then press the **ENTER** or **PLAY/PAUSE ▶/||** button.

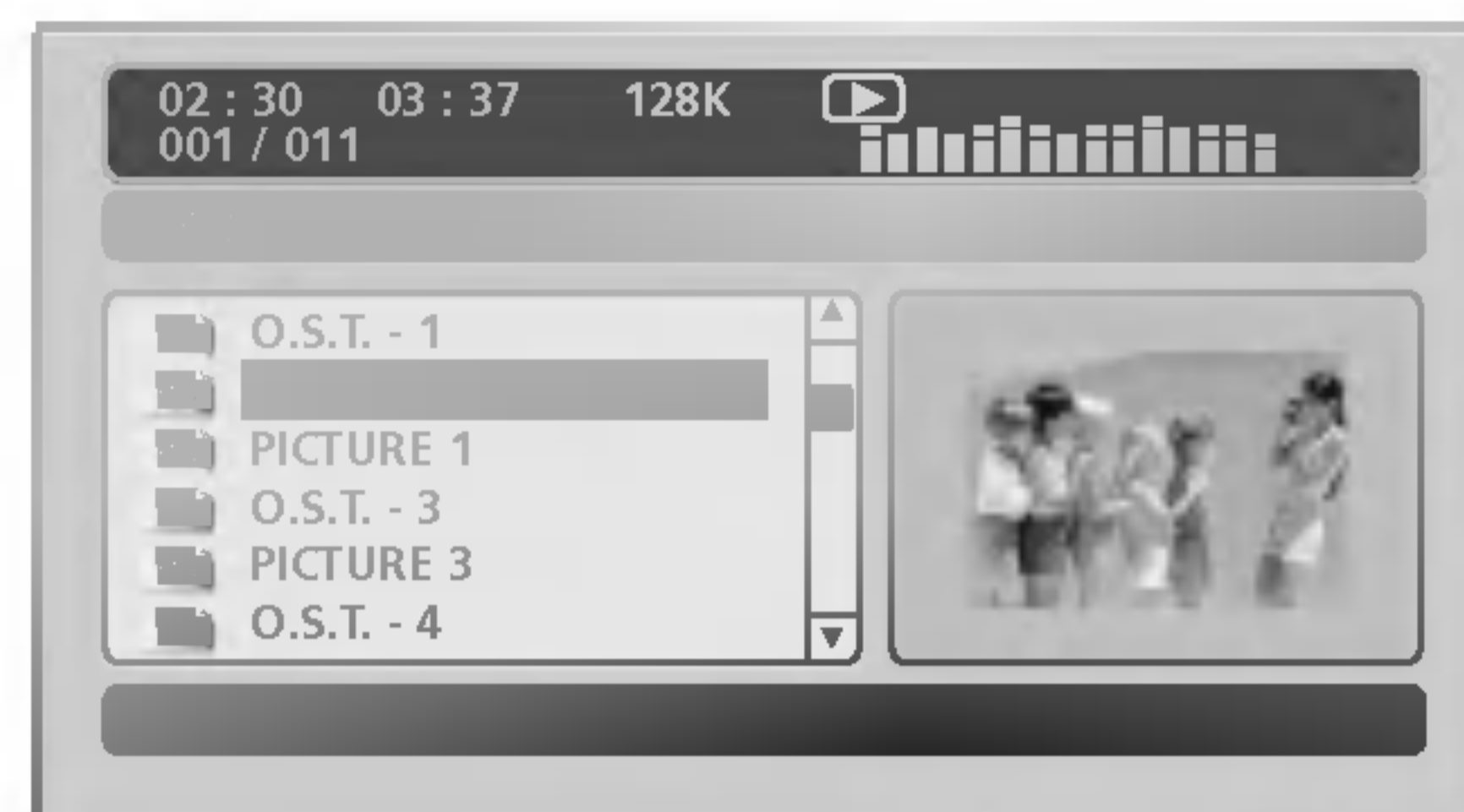

## Stop Playback

Press the **STOP** button to stop playback.

## Pause Playback

1. Press the **PLAY/PAUSE ▶/||** button during playback.
2. Press the **PLAY/PAUSE ▶/||** button again to return to normal playback.

- Take advantage of any multichannel format from just two speakers without the need to add extra speakers or equipment

1. Press the **3D SOUND** button during playback.
2. Each press of the **3D SOUND** button changes the sound option as indicated below:  
: Off → Concert → Living room → Hall → Bathroom → Arena.

- You can play a specific track repeatedly.

1. Press the **REPEAT** button during playback.  
Each time you press the **REPEAT** button, the repeat mode changes in the following order:  
: Random → Track → Repeat Track → Repeat Directory → Off

- A-B repeat playback allows you to repeat material between two selected points.

1. Press the **A-B** button to select the start point during playback. "⌚ A" is displayed on TV screen and the starting point of your selected segment is set up.
2. Press the **A-B** button again to select the end point. "⌚ AB" is displayed on TV screen and the ending point is set up.  
Playback starts at the point that you selected. Playback stops at the end point, returns to Point A automatically, then starts again.
3. Repeatedly press the **A-B** button until "Off" appears on the screen to resume normal playback.

# Audio CD Operation

- You can display the Track, and Playback time status on the TV screen.

1. Press the **ENTER** button during DVD playback. Track information appear on screen.  
Each time you press the **ENTER** button, the OSD changes as follows:  
Single Elapsed → Single Remain → Total Elapsed → Total Remain

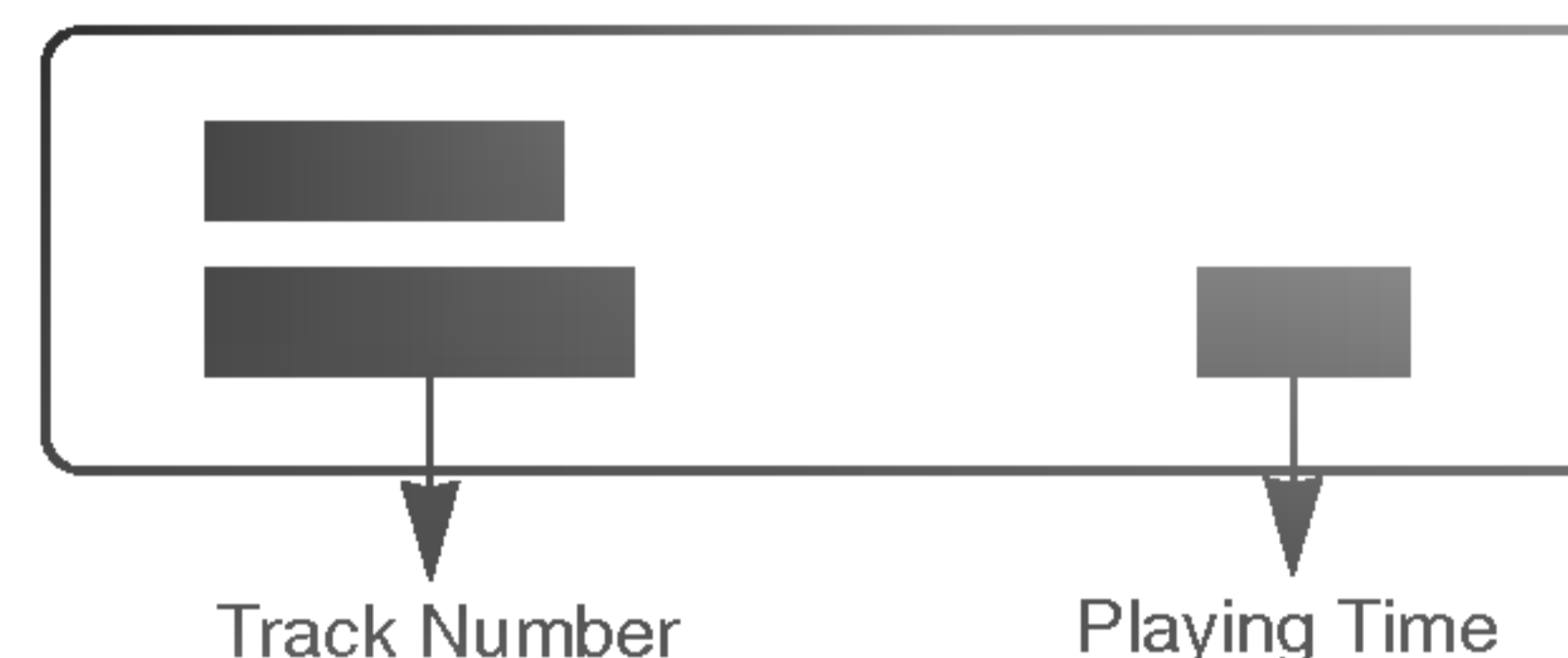

1. Press the **STOP** button to stop playback. At this time the CD player stops playback temporarily and maintains the current playback position.
2. Press the **STOP** button again to stop playback fully. (At this time if you press the **PLAY/PAUSE** ►/II button, disc playback starts from the beginning.)

1. Press the **PLAY/PAUSE** ►/II button during playback.
2. Press the **PLAY/PAUSE** ►/II button again to return to normal playback.

1. Press the **SCAN** ►► or ◀◀ **SCAN** button during playback.  
Each time you press **SCAN** ►► or ◀◀ **SCAN** button, the playback speed changes as shown.

- **scan** ►►: ►► 2x → ►► 4x → ►► 8x → ►► 16x → ►► 32x.
- **scan** ◀◀: ◀◀ 2x → ◀◀ 4x → ◀◀ 8x → ◀◀ 16x → ◀◀ 32x.

2. Press the **PLAY/PAUSE** ►/II button to resume normal playback.

- You can play a specific track repeatedly.

1. Press the **REPEAT** button during playback.  
Each time you press the **REPEAT** button, the repeat mode changes as indicated: Track → ALL → Random → Repeat Off

- You can arrange the playback order of tracks on the disc.

1. Press the **PROGRAM** button in the stop mode or during playback.
2. Use the ▲ / ▼ button to select the program position.
3. Use the number buttons to select the desired Track numbers.  
To program others, repeat Steps 2 and 3.
4. Press the **PROGRAM** button to resume normal playback.

- Take advantage of any multichannel format from just two speakers without the need to add extra speakers or equipment

1. Press the **3D SOUND** button during playback.
2. Each press of the **3D SOUND** button changes the sound mode as indicated: Off, Concert, Living room, Hall, Bathroom, or Arena.

1. Use the **SKIP** ►►I or I◀◀ **SKIP** button to locate a desired track during playback. Each time you press the button, the unit skips to the next/previous track.

- A-B repeat playback allows you to repeat material between two selected points.

1. Press the **A-B** button to select the start point during playback. "⌚ A" is displayed on TV screen and the starting point of your selected segment is set up.
2. Press the **A-B** button again to select the end point. "⌚ AB" is displayed on TV screen and the ending point is set up.  
Playback starts at the point that you selected. Playback stops at the end point, returns to Point A automatically, then starts again.
3. Repeatedly press the **A-B** button again to resume normal playback.  
"Off" appears on the screen.

Track 14/21

00:03



# JPEG File Viewing Options

- As a JPEG file is loaded, the table of contents appears on the TV screen. 16 slide show transition modes are available.

1. Use the ▲ / ▼ button to select the desired picture. The selected JPEG file appears on the right side of the screen.
2. Press the **ENTER** or **PLAY/PAUSE ▶/II** button to enlarge the JPEG file to fill the screen.
3. Press the **PLAY/PAUSE ▶/II** button again to start slide show mode. Press the **STOP** button to return to the menu.

**Note:** If you press the **ENTER** or **PLAY/PAUSE ▶/II** button while playing an MP3 disc, the picture slide show starts.

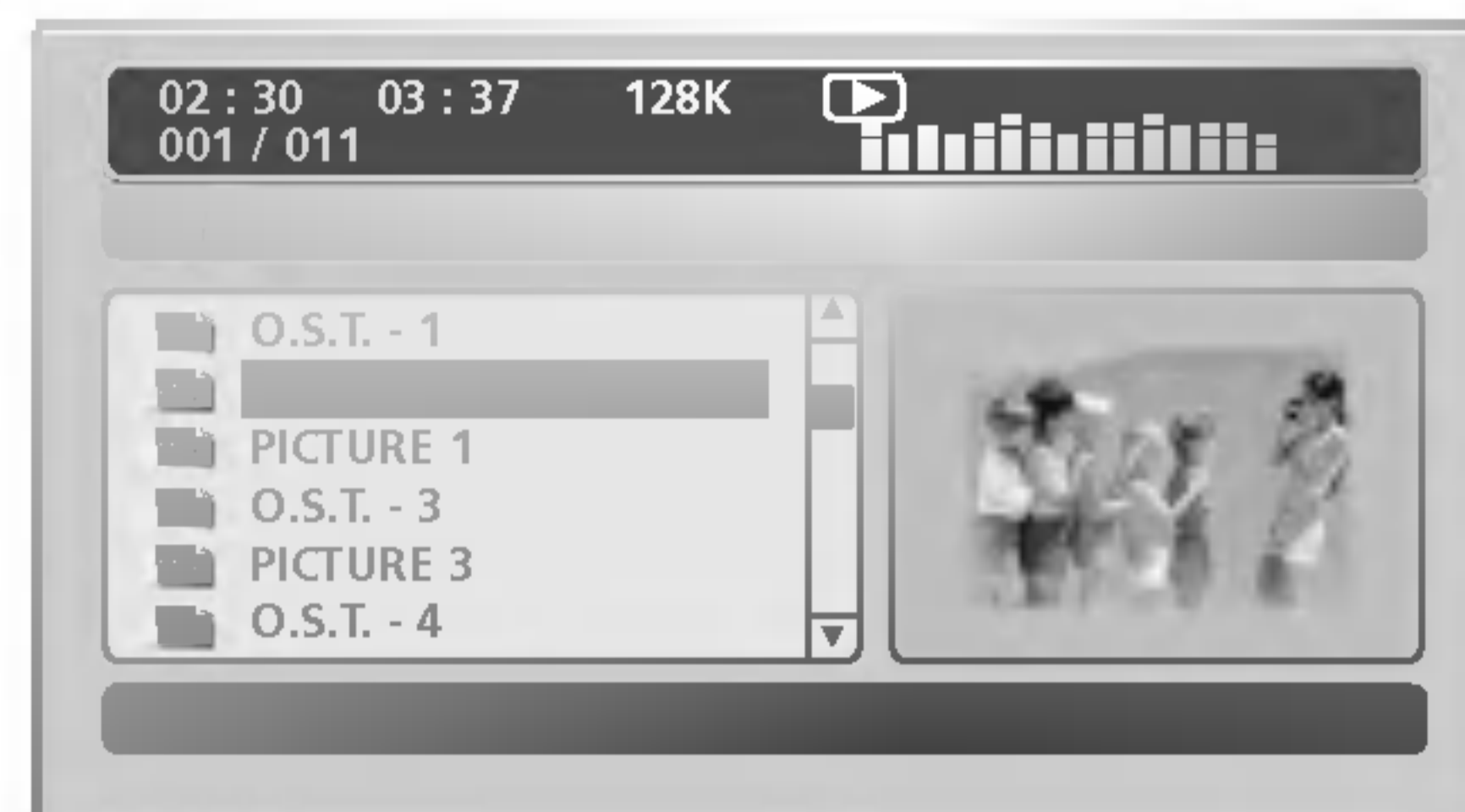

1. Use **PROGRAM** button to change the slide show transition mode as shown below:

Wipe Top → Wipe Bottom → Wipe Left → Wipe Right → Diagonal Wipe Left Top → Diagonal Wipe Right Top → Diagonal Wipe Left Bottom → Diagonal Wipe Right Bottom → Extend From Center H → Extend From Center V → Compress To Center H → Compress To Center V → Window H → Window V → Wipe From Edge To Center → Move in From Top → None

Use the ▲ / ▼ button to rotate a picture. There are 2 modes to rotate picture:

- ▲ button: invert.
- ▼ button: mirror

1. Press the **ZOOM** button and use the **SCAN ▶▶** or **◀◀ SCAN** button to see the zoom mode at 50% ~ 200%.
2. Adjust the picture position using the ▲ / ▼ / ◀ / ▶ buttons while in the enlarged picture mode. To exit Zoom mode, press the **ZOOM** button one more time.
3. Press the **STOP** button to return to the menu.

- You can show JPEG files repeatedly.

1. Press the **REPEAT** button during playback. Each time you press the **REPEAT** button, the repeat mode changes as indicated: Random → Repeat One → Repeat All → Repeat Off  
If you play MP3 and JPEG slide show simultaneously, repeat function is applied either a MP3 and JPEG file.

# Product Specifications

|                            |   |
|----------------------------|---|
| Power Requirements*        | DC15V/4.5A  |
| Adapter (AC to DC Power)   | In: AC 100-240V ~ 1.6A-0.7A, 50/60Hz<br>Out: DC 15V, 4.5A |
| Television System          | NTSC, PAL M-N   |
| Television Channels        | VHF: 2 ~ 13, UHF: 14 ~ 69, Cable: 01 ~ 125                |
| Television Screen          | LCD Panel   |
| External Antenna Impedance | 75 $\Omega$   |
| Audio Output               | 3 W + 3 W   |

# Troubleshooting Checklist

## SYMPTOMS

No power

No picture or sound

Poor picture but good sound

Poor reception

Lines in picture

Ghosts (multiple images)

Remote control does not work.

Cannot tune desired channel.



## CHECK THESE THINGS

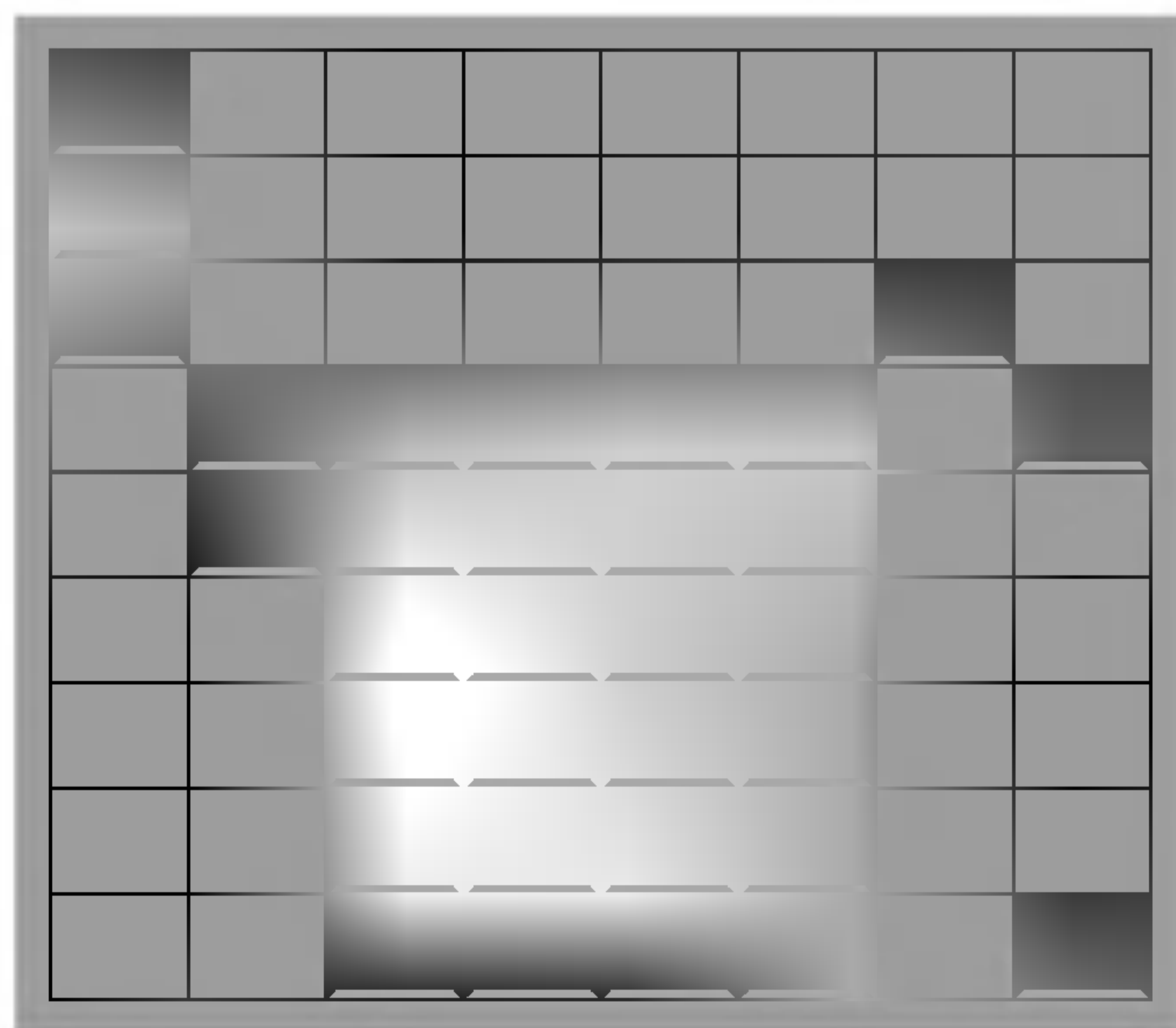

- Is power cord plugged in ?
- Is television turned on ?
- Check batteries in remote control.
- Try another channel (station trouble).
- Check antenna connectings.
- Check for local interference.
- Adjust the antenna.
- Adjust the picture control.
- Program channel using AUTO PROGRAM.