



LCD TV

## Owner's Manual

Before connecting, operating or adjusting this product,  
please read this instruction booklet carefully and completely.

P/NO : 3828TUL300K (0508-REV00)  
Printed in Korea

---

# Contents

---

<b>Installation</b>	<b>3</b>
<b>Location and function of controls</b>	<b>4</b>
Remote control	
Internal generator charge / Front/Side panel / Back panel	
<b>Basic operation</b>	<b>8</b>
On and off / Programme selection	
Volume adjustment	
Quick view / Mute function	
On screen language selection (option)	
<b>ON SCREEN Menus</b>	<b>9</b>
Menu selection	
<b>STATION Menu</b>	<b>10</b>
Auto programme tuning	
Manual programme tuning	
Assigning a station name/Fine tuning	
Programme edit	
Favourite programme/Calling the programme table	
<b>PICTURE Menu</b>	<b>15</b>
PSM (Picture Status Memory)	
Picture adjustment	
ACC/ XD	
<b>SOUND Menu</b>	<b>17</b>
SSM (Sound Status Memory)	
Sound adjustment/SRS WOW	
Stereo/Dual reception / NICAM reception	
Sound output selection	
<b>TIMER menu</b>	<b>20</b>
Clock / On/Off Time / Auto Off / Sleep timer	
<b>SPECIAL Menu</b>	<b>22</b>
Main Picture Source Selection	
Child lock/Power Indicator/Transparency	
Picture Size Zoom/Reset	
<b>SCREEN Menu</b>	<b>25</b>
Picture format	
Auto adjustment /Clock and Phase	
SCREEN Position	
Manual Configure	
Screen adjustments	
Initializing (Reset to original factory value)	
Selecting Wide XGA mode	
YNR (Y-signal Noise Reduction) / Split Zoom	
<b>PIP/POP/PBP operation</b>	<b>28</b>
PIP/POP/PBP mode / Input mode selection for sub picture	
Sub Picture / Size Source	
Image / Sound /Moving the sub Picture	
Swap / Swapping between main and sub pictures	
Programme selection for sub picture	
<b>Teletext (option)</b>	<b>32</b>
Switch on/off / SIMPLE text / TOP text (option)	
FASTEXT / Special teletext functions	
<b>Connection of external equipment</b>	<b>35</b>
Aerial socket / Euro scart sockets	
S-Video/Audio in sockets (S-Video)	
PC in socket / Audio/Video in sockets	
<b>Displayable Monitor Specification</b>	<b>37</b>
RGB Mode / DVI Mode	
<b>External Control Device Setup</b>	<b>38</b>
RS-232C input socket / D-Sub 9-pin male	
Set ID / Communication Parameters	
Command Reference List	
Transmission/Receiving Protocol	
<b>Programming the Remote control</b>	<b>42</b>
<b>Programming Codes</b>	<b>43</b>
<b>Troubleshooting check list</b>	<b>47</b>

---

---

# Installation

---

## Power

This set operates on an AC mains supply, the voltage is as indicated on the label on the back cover. Never apply DC power to the set. In the event of thunderstorms or powercuts, please pull out the aerial and mains plugs.

- a. Open the back panel cover.
- b. After connecting the power cord to the set, connect the power cord to an AC mains.
- c. Fix cables with the supplied cable tie after collecting connected cables.
- d. Pull the cables through the hole on the set.
- e. Close the back panel cover.

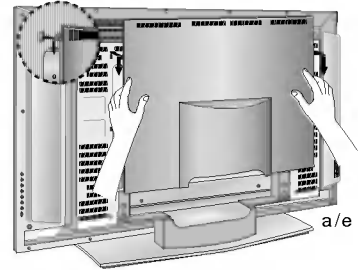

## Warning

To prevent fire or shock hazard, do not expose the set to rain or moisture. Do not rub or strike the Active Matrix LCD with anything hard as this may scratch, mar, or damage the Active Matrix LCD permanently.

## Service

Never remove the back cover of the set as this can expose you to high voltage and other hazards. If the set does not operate properly, unplug it and call your dealer.

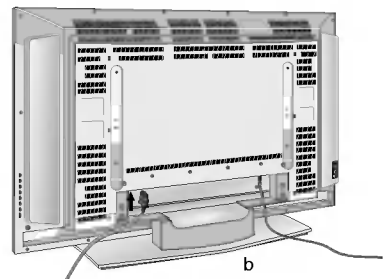

## Aerial

Connect the aerial cable to the socket marked  $75 \Omega$  on the back. For the best reception an outdoor aerial should be used.

## Location

Position your set so that no bright light or sunlight falls directly onto the screen. Care should be taken not to expose the set to any unnecessary vibration, moisture, dust or heat. Also ensure that the set is placed in a position to allow a free flow of air. Do not cover the ventilation openings on the back cover.

If you intend to mount the TV to a wall, attach VESA standard mounting interface (optional parts) to the back of the TV. When you install the set to use the wall mounting bracket (optional parts), fix it carefully so as not to drop.

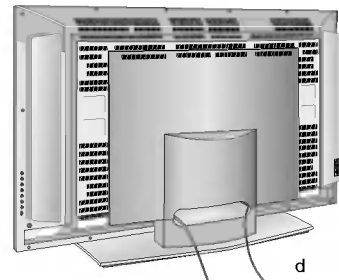

## Cleaning

Unplug the set before cleaning the face of the LCD Screen. Dust the set by wiping the screen and the cabinet with a soft, clean cloth. If the screen requires additional cleaning, use a clean, damp cloth. Do not use liquid cleaners or aerosol cleaners.

## On Disposal

The fluorescent lamp used in this product contains a small amount of mercury.

Do not dispose of this product with general household waste. Disposal of this product must be carried out in accordance to the regulations of your local authority.

# Location and function of controls

All the functions can be controlled with the remote control. Some functions can also be adjusted with the buttons on the side panel of the set.

## Remote Control

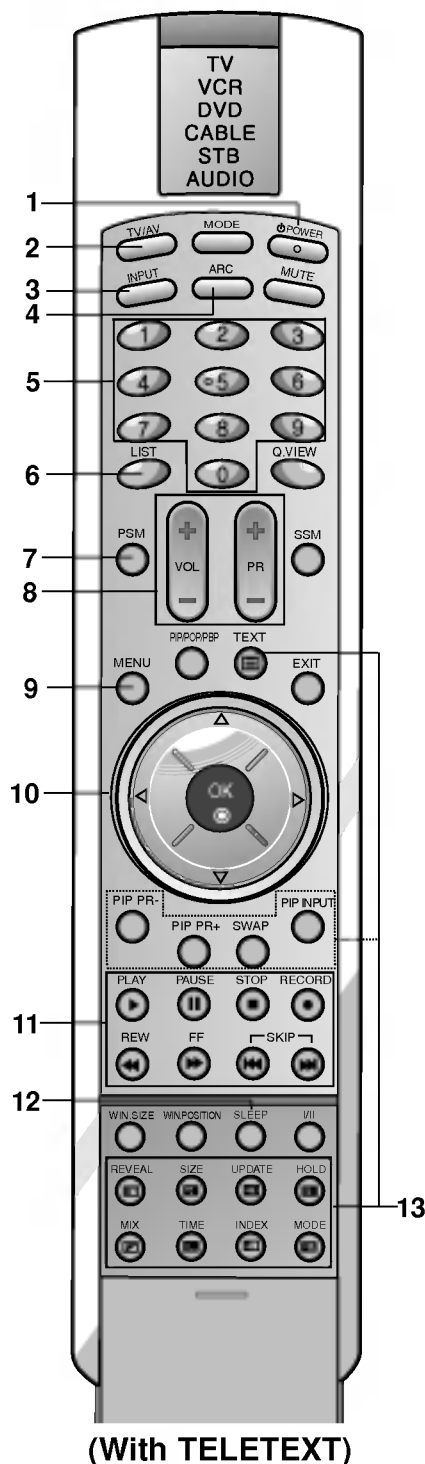

(With TELETEXT)

1. **POWER**  
Switches the set on from standby or off to standby.
2. **TV/AV**  
Selects **TV, AV, S-Video, Component1, Component2, RGB PC, DVI PC** modes.  
switches the set on from standby.
3. **INPUT**  
Selects **TV, AV, S-Video, Component1, Component2, RGB PC, DVI PC** modes.
4. **ARC (Aspect Ratio Control)**  
Changes the picture format.
5. **NUMBER BUTTONS**  
Switches the set on from standby or directly select a number.
6. **LIST**  
Displays the programme table.
7. **PSM (Picture Status Memory)**  
Recalls your preferred picture setting.
8. **VOLUME UP/DOWN**  
Adjusts the volume.  
**Programme UP/DOWN**  
Selects a programme.
9. **MENU**  
Selects a menu.
10. **▲ / ▼ / ◀ / ▶ (Up/Down/Left/Right) BUTTONS**  
Selects a menu item.  
Adjusts menu settings.  
**OK**  
Accepts your selection or displays the current mode.
11. **VCR/DVD BUTTONS**  
Control some video cassette recorders or DVD player ("RECORD" button is not available for DVD player).
12. **SLEEP**  
Sets the sleep timer.
13. **TELETEXT BUTTONS (option)**  
These buttons are used for teletext.  
For further details, see the 'Teletext' section.  
**\* : No function**

# Location and function of controls

## 14. MODE

Selects the remote operating mode: TV, VCR, DVD, CABLE, STB or AUDIO. Select other operating modes, for the remote to operate external devices.

## 15. MUTE

Switches the sound on or off.

## 16. Q.VIEW

Returns to the previously viewed programme.  
Selects a favorite programme.

## 17. SSM (Sound Status Memory)

Recalls your preferred sound setting.

## 18. PIP BUTTONS

### PIP/POP/PBP

Switches the sub picture select PIP, POP, PBP or off modes.

### PIP PR +/-

Selects a programme for the sub picture.

### SWAP

Alternates between main and sub picture.

### PIP INPUT

Selects the input mode for the sub picture.

### WIN.SIZE

Adjusts the sub picture size.

### WIN POSITION

Moves the sub picture to ▲ / ▼ or ◀ / ▶ direction.

## 19. EXIT

Clears all on-screen displays and returns to TV viewing from any menu.

## 20. I/II

Selects the language during dual language broadcast.

Selects the sound output.

**Note:** In teletext mode, the **PIP PR +/-**, **SWAP** and **PIP INPUT** buttons are used for teletext function.

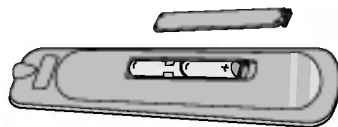

## Installing Batteries

- Open the battery compartment cover on the back side and insert two 1.5V AA size batteries in correct polarity (+ with +, - with -).
- Don't mix old or used batteries with new ones.
- Close the cover.

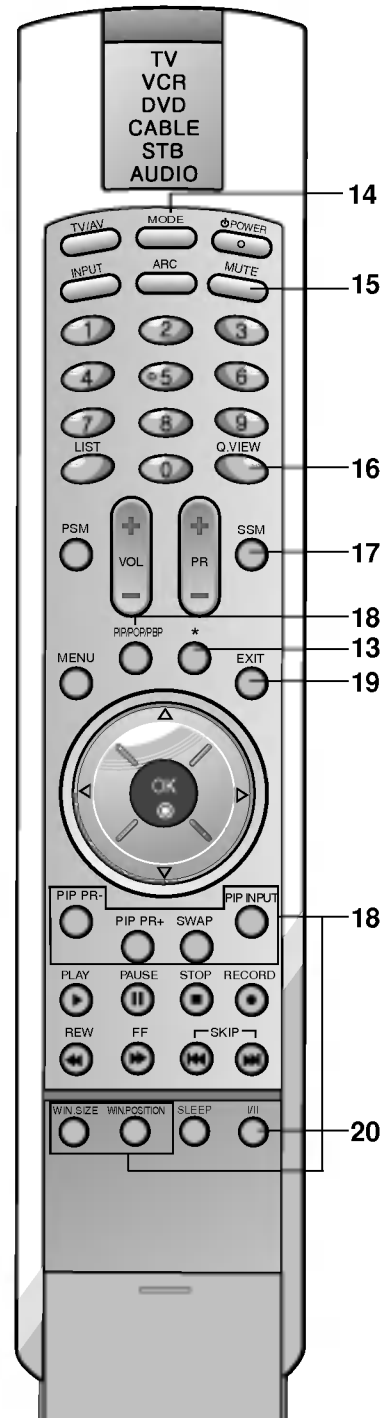

(Without TELETEXT)

---

# Location and function of controls

---

## Front / Side panel

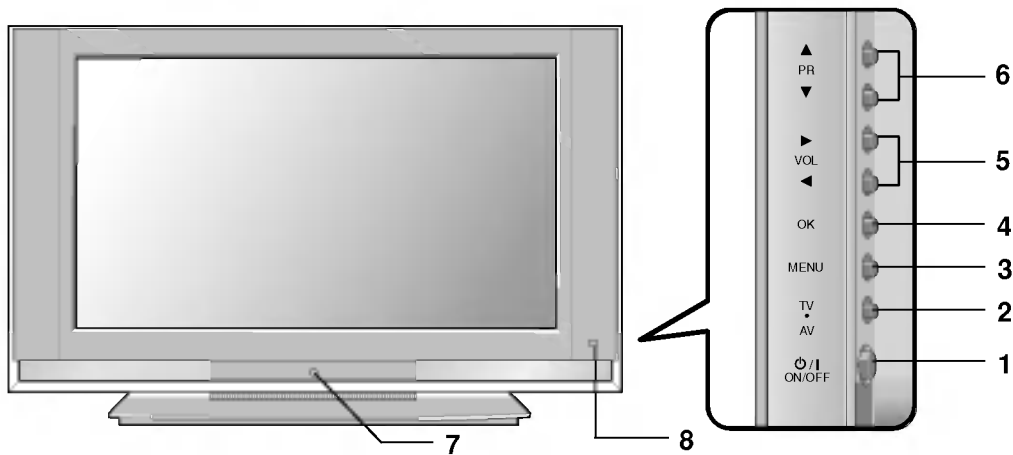

- 1. / I (ON / OFF)**  
Switches the set on or off.
- 2. TV / AV**  
Selects **TV, AV, S-Video, Component1, Component2, RGB PC, DVI PC** modes  
switches the set on from standby.
- 3. MENU**  
Selects a menu.
- 4. OK**  
Accepts your selection or displays the current mode.
- 5. (Volume Down/Up)**  
Adjusts the volume.  
Adjusts menu settings.
- 6. (Programme Up/Down)**  
Selects a programme or a menu item.  
Switches the set on from standby.
- 7. POWER/STANDBY Indicator**  
Illuminates red in standby mode.  
Illuminates green when the set is switched on.  
Illuminates amber in RGB PC/DVI PC mode (DPM Mode).
- 8. Remote Control Sensor**

---

# Location and function of controls

---

## Back panel

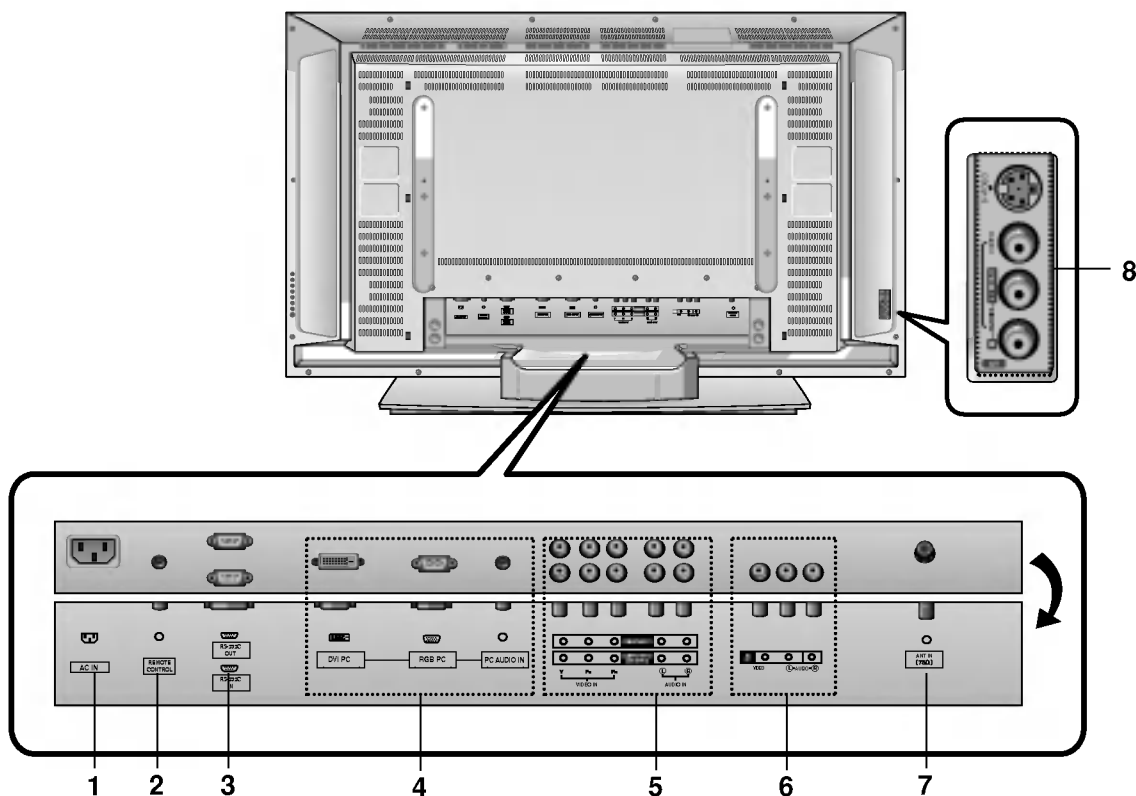

- |  |  |
|--|--|
| <ol style="list-style-type: none"> <li>1. <b>POWER CORD SOCKET</b></li> <li>2. <b>REMOTE CONTROL JACK</b></li> <li>3. <b>RS-232C SERIAL PORTS</b></li> <li>4. <b>DVI (Digital Visual Interface) PC / RGB PC / PC AUDIO IN SOCKETS</b><br/>Connect the set output socket of the PERSONAL COMPUTER to this socket.</li> <li>5. <b>COMPONENT1(DTV, DVD), COMPONENT2 (DVD) IN SOCKETS</b><br/>Connect the audio/video out sockets of external equipment to these sockets.</li> </ol> | <ol style="list-style-type: none"> <li>6. <b>AV OUT SOCKETS</b></li> <li>7. <b>AERIAL SOCKET</b><br/>Connect the RF socket of the VCR to the aerial socket.</li> <li>8. <b>AUDIO/VIDEO IN SOCKETS (AV)</b><br/>Connect the audio/video out sockets of external equipment to these sockets.<br/><b>S-VIDEO/AUDIO IN SOCKETS (SAV)</b><br/>Connect the video out socket of an S-VIDEO VCR to the <b>S-VIDEO</b> socket.<br/>Connects the audio out sockets of the S-VIDEO VCR to the audio sockets as in <b>AV</b>.</li> </ol> |
|--|--|

---

# Basic Operation

---

## On and off

1. Press the main power button to switch the set on.
2. If the set is in standby mode, press the **POWER**, **TV/AV**, **PR +/-**, **INPUT**, or **NUMBER** buttons on the remote control to switch it on fully.
3. Press the **POWER** button on the remote control. The set reverts to standby mode.
4. Press the main power button again to switch the set off.

**Note :** If, while the set is switched on, the mains plug is disconnected the set will switch to standby or power on when the mains plug is replaced in the mains power socket.

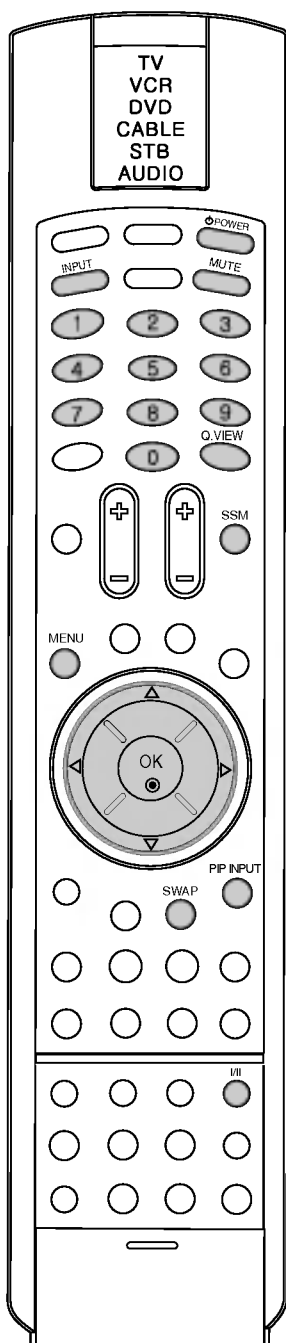

## Programme selection

You can select a programme number with the **PR +/-** or **NUMBER** buttons.

## Volume adjustment

Press the **VOL +/-** button to adjust the volume.

## Quick view

Press the **Q.VIEW** button to view the last programme you were watching.

**Note :** This function works only when *Favourite programme is set to Off* . Otherwise each press of this button will select a stored favourite programme.

## Mute function

Press the **MUTE** button. The sound is switched off and the display  appears. You can cancel it by pressing the **MUTE**, **VOL +/-**, **I/II** or **SSM** button.

## On screen language selection (option)

The menu can be displayed on the screen in your desired language. First select your language.

1. Press the **MENU** button and then **▲ / ▼** button to select the **SPECIAL** menu.
2. Press the **▶** button and then **▲ / ▼** button to select **Language**.
3. Press the **▶** button and then the **▲ / ▼** button to select your desired language. All the on screen displays will appear in the selected language.
4. Press the **MENU** button to save.

---

# On Screen Menus

---

The dialogue between you and your set takes place on screen with an operator menu.

## Menu selection

1. Press the **MENU** button and then **▲** / **▼** button to display each menu.
2. Press the **▶** button and then the **▲** / **▼** button to select a menu item.
3. Repeatedly press the **MENU** button to return to normal TV viewing.

**Note** : In the teletext mode, menus are not displayed.

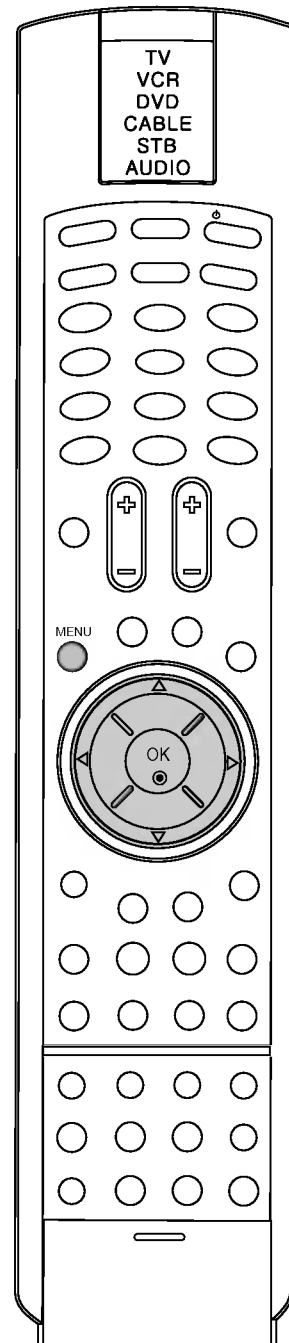
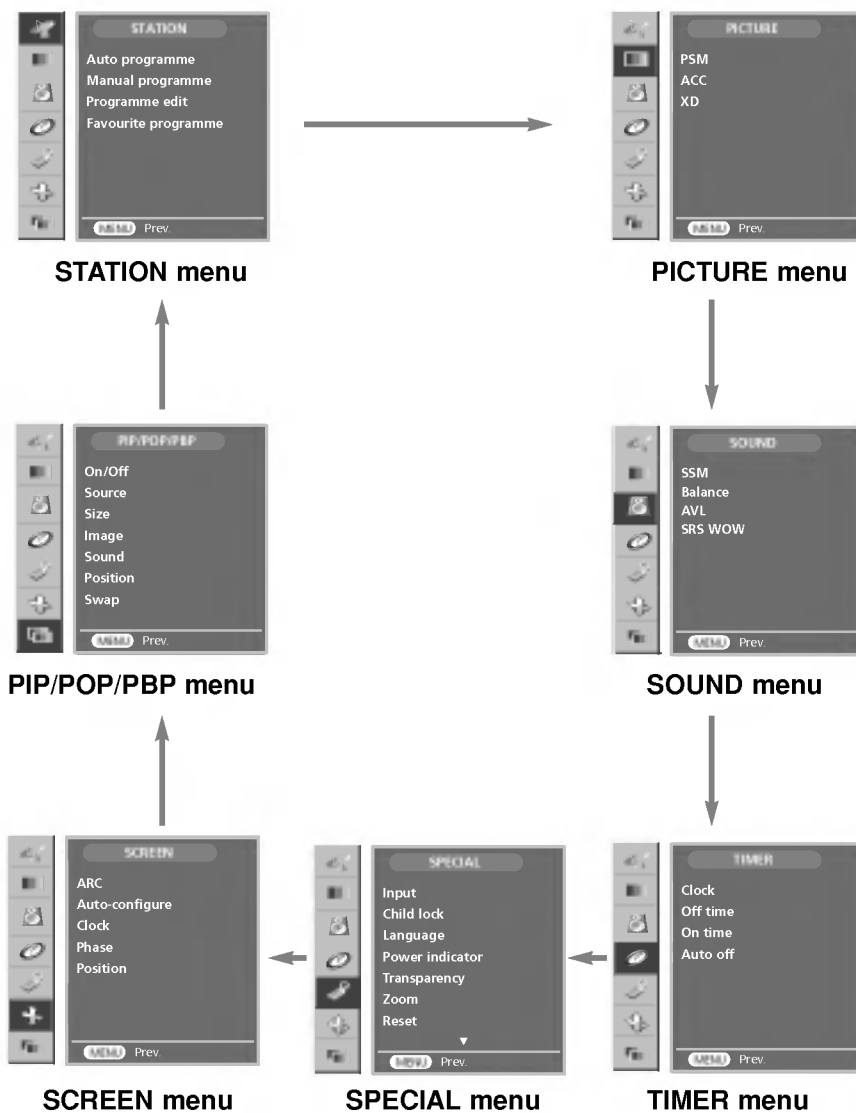

# STATION Menu



STATION menu

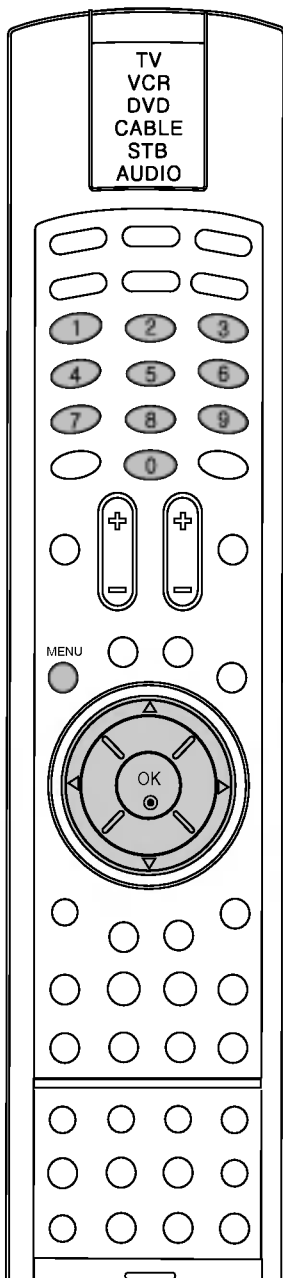

Up to 100 (only china : 200) TV stations can be stored in this set by programme numbers (0 to 99(only china :0 to 199)). Once you have preset the stations, you will be able to use the ▲ / ▼ or NUMBER buttons to scan the stations you programmed. Stations can be tuned using automatic or manual modes.

## Auto programme tuning

All stations that can be received are stored by this method. It is recommended that you use auto programme during installation of this set.

1. Press the **MENU** button and then ▲ / ▼ button to select the **STATION** menu.
2. Press the ► button and then ▲ / ▼ button to select **Auto Programme**.
3. Press the ► button. Select a TV system with the ► button and then ▲ / ▼ button on the **System** menu;



**BG** : (Asia/New Zealand/M.East/Africa/Australia)

**I** : (Hong Kong/South Africa)

**DK** : (East Europe/China/Africa/CIS)

**M** : (USA/Korea/Philippines) (option)

4. Press the **OK** button.
5. Press the ▲ / ▼ button to select **Storage from**. And press the ► button. Select the beginning programme number with the ▲ / ▼ button or NUMBER buttons on the **Storage from** menu.
6. Press the **OK** button.
7. Press the ▲ / ▼ button to select **Start**.



8. Press the ► button to begin auto programming. All receivable stations are stored. The station name is stored for stations which broadcast VPS (Video Programme Service), PDC (Programme Delivery Control) or TELETEXT data. If no station name can be assigned to a station, the channel number is assigned and stored by a number as shown below.

	AUSTRALIA		CHINA		ELSE	
	V/UHF	Cable	V/UHF	Cable	V/UHF	Cable
BG	1 ~ 75	2 ~ 44	1 ~ 69	1 ~ 47	1 ~ 69	1 ~ 47
I	1 ~ 69	1 ~ 47	1 ~ 69	1 ~ 47	1 ~ 69	1 ~ 47
DK	1 ~ 69	1 ~ 47	1 ~ 62	1 ~ 41	1 ~ 69	1 ~ 47
M	2 ~ 83	1 ~ 71	2 ~ 83	1 ~ 71	2 ~ 83	1 ~ 71

To stop auto programming, press the **MENU** button.

When auto programming is completed, the **Programme edit** menu appears on the screen. See the 'Programme edit' section to edit the stored programme.

9. Repeatedly press the **MENU** button to return to normal TV viewing.

# STATION Menu

## Manual programme tuning

Manual programme lets you manually tune and arrange the stations in whatever order you desire. Also you can assign a station name with five characters to each programme number.

1. Press the **MENU** button and then **▲ / ▼** button to select the **STATION** menu.
2. Press the **▶** button and then **▲ / ▼** button to select **Manual Programme**.
3. Press the **▶** button and then **▲ / ▼** button to select **System**.



4. Select a TV system with the **▶** button and then **▲ / ▼** button on the **System** menu;
  - BG** : (Asia/New Zealand/M.East/Africa/Australia)
  - I** : (Hong Kong/South Africa)
  - DK** : (East Europe/China/Africa/CIS)
  - M** : (USA/Korea/Philippines) (option)
5. Press the **OK** button.
6. Press the **▲ / ▼** button to select **Storage**. And press the **▶** button. Select the beginning programme number with the **▲ / ▼** button or **NUMBER** buttons on the **Storage** menu.
7. Press the **OK** button.



8. Press the **▲ / ▼** button to select **Channel**.
9. Press the **▶** button and then **▲ / ▼** button to select **VHF/UHF** or **Cable** on the **Channel** menu. Then press the **▶** button. You can select the desired channel number with the **NUMBER** buttons. If possible, select the channel number directly with the number buttons. Refer to page 10.
10. Press the **OK** button.
11. Press the **▲ / ▼** button to select **Search**.
12. Press the **▶** button.
13. Press the **OK** button to store it.
14. To store another station, repeat steps 3 to 12.
15. Repeatedly press the **MENU** button to return to normal TV viewing.



STATION menu

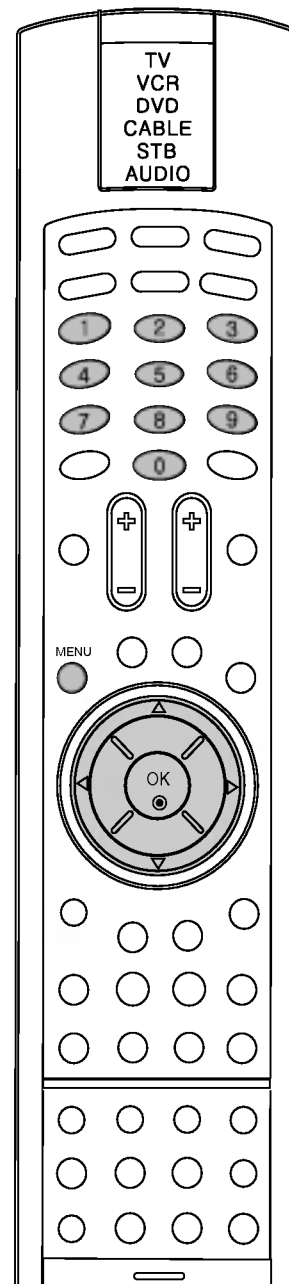

---

# STATION Menu

---



**STATION menu**

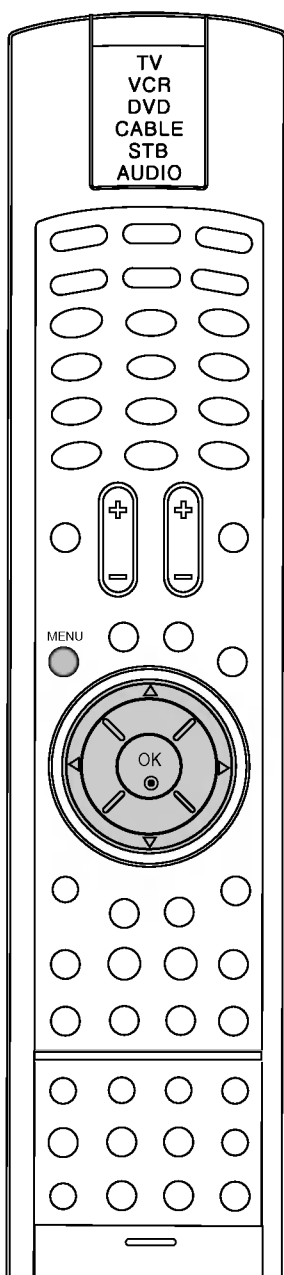

## Assigning a station name

1. Repeat the 'Manual programme tuning' steps 1 to 2.
2. Press the ► button and then ▲ / ▼ button to select **Name**.

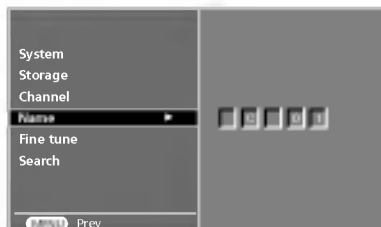

3. Press the ► button and then use the ▲ / ▼. You can use a blank, +, -, the number 0 to 9 and the alphabet A to Z. With the ◀ button you can select in the opposite direction.
4. Select the position by pressing the ◀ / ► button and then make your choice of the second character, and so on.
5. Press the **OK** button to store it.
6. Repeatedly press the **MENU** button to return to normal TV viewing.

## Fine tuning

Normally fine tuning is only necessary if reception is poor.

1. Repeat the 'Manual programme tuning' steps 1 to 2.
2. Press the ► button and then ▲ / ▼ button to select **Fine tune**.



3. Press the ► button to fine tune for the best picture and sound.
4. Press the **OK** button.
5. Repeatedly press the **MENU** button to return to normal TV viewing.  
The finely tuned programme will be indicated by yellow number during programme selection.

---

# STATION Menu

---

## Programme edit

This function enables you to delete or skip the stored programmes. Also you can move some stations to other programme numbers or copy a blank station data into the selected programme number.

1. Press the **MENU** button and then use **▲ / ▼** button to select the **STATION** menu.
2. Press the **▶** button and then **▲ / ▼** button to select **Programme edit**.
3. Press the **▶** button to display the **Programme edit** menu.

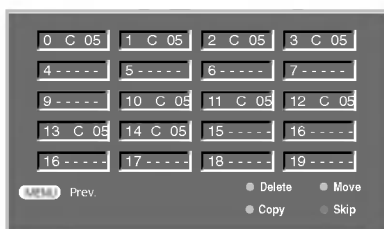

STATION menu

## Deleting a programme

1. Select a programme to be deleted with the **▲ / ▼** or **◀ / ▶** button.
2. Press the **RED** button twice.  
The selected programme is deleted, all the following programmes are shifted up one position.

## Copying a programme

1. Select a programme to be copied with the **▲ / ▼** or **◀ / ▶** button.
2. Press the **GREEN** button.  
All the following programmes are shifted down one position.

## Moving a programme

1. Select a programme to be moved with the **▲ / ▼** or **◀ / ▶** button.
2. Press the **YELLOW** button.
3. Move the programme to the desired programme number with the **▲ / ▼** or **◀ / ▶** button.
4. Press the **YELLOW** button again to release this function.

## Skipping a programme number

1. Select a programme number to be skipped with the **▲ / ▼** or **◀ / ▶** button.
2. Press the **BLUE** button. The skipped programme turns to blue.
3. Press the **BLUE** button again to release the skipped programme.

When a programme number is skipped it means that you will be unable to select it using the **▲ / ▼** button during normal TV viewing. If you want to select the skipped programme, directly enter the programme number with the **NUMBER** buttons or select it in the programme edit or table menu.

Repeatedly press the **MENU** button to return to normal TV viewing.

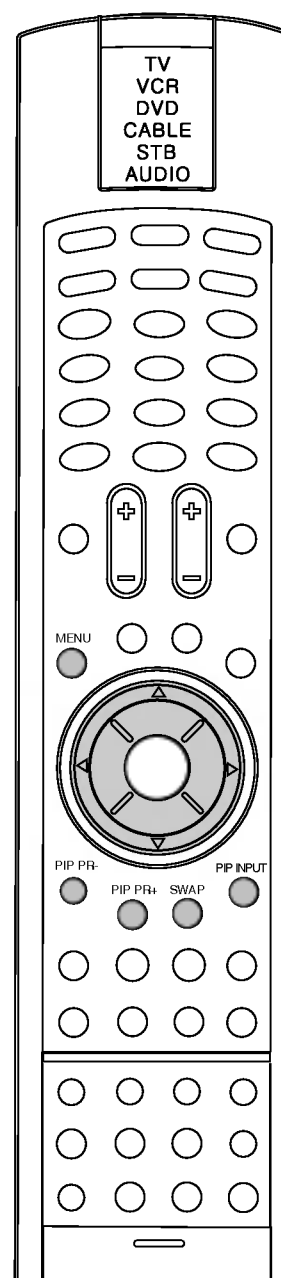

# STATION Menu



STATION menu

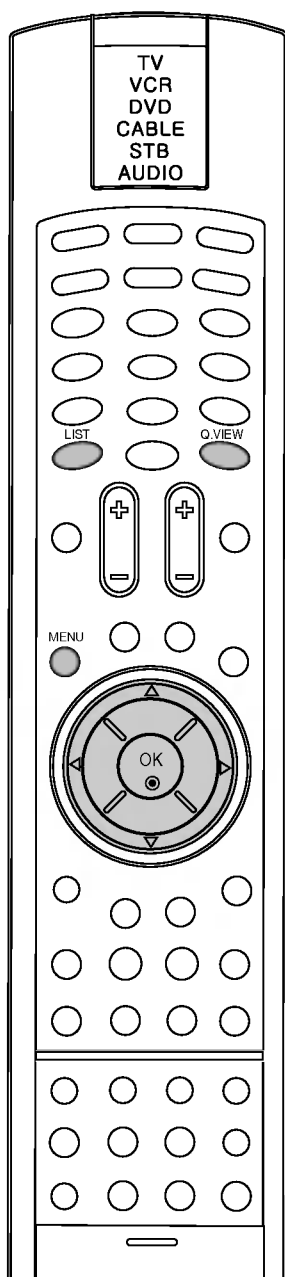

## Favourite programme

This function lets you select your favourite programmes directly.

1. Press the **MENU** button and then **▲ / ▼** button to select the **STATION** menu.
2. Press the **▶** button and then **▲ / ▼** to select **Favourite programme**.

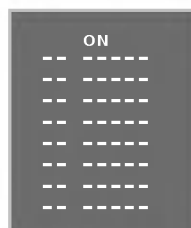

3. Press the **▶** button and then **◀ / ▶** button to select **On** or **Off**.
4. Press the **▲ / ▼** button to select -- ----.
5. Select a desired programme with the **◀ / ▶** button.
6. To store another programme, repeat steps 4 to 5.  
You can store up to 8 programmes.
7. Press the **MENU** button to return to normal TV viewing.

Repeatedly press the **Q.VIEW** button to select stored favourite programmes.

## Calling the programme table

You can check the programmes stored in the memory by displaying the programme table.

### Displaying programme table

Press the **LIST** button to display the Programme table menu. The programme table appears on the screen.

PROGRAMME LIST			
0 C 05	1 C 05	2 C 05	3 C 05
4 ----	5 ----	6 ----	7 ----
9 ----	10 C 05	11 C 05	12 C 05
13 C 05	14 C 05	15 ----	16 ----
16 ----	17 ----	18 ----	19 ----

### Note :

- a. You may find some blue highlighted programmes shown. They have been set up in the programme edit mode.
- b. Some programmes with the channel number shown in the programme table indicate there is no station name assigned.

### Selecting a programme in the programme table

Select a programme with the **▲ / ▼** or **◀ / ▶** button. Then press the **OK** button. The set switches to the chosen programme number.

### Paging through a programme table

There are 10 programme table pages in which contain 199 programmes.

Pressing the **▲ / ▼** or **◀ / ▶** button repeatedly turns the pages.

Repeatedly press the **MENU** button to return to normal TV viewing.

---

# PICTURE Menu

---

## PSM (Picture Status Memory)

1. Press the **MENU** button and then **▲ / ▼** button to select the **PICTURE** menu.
2. Press the **▶** button and then **▲ / ▼** button to select **PSM**.



PICTURE menu

3. Press the **▶** button and then **▲ / ▼** button to select a picture setting on the **PSM** menu.
4. Press the **MENU** button to save.

You can also recall a desired picture (**Dynamic**, **Standard**, **Mild**, **Game** or **User**) with **PSM** button on the remote control. The picture **Dynamic**, **Standard**, **Mild** and **Game** are programmed for optimum picture reproduction at the factory and cannot be changed.

## Picture adjustment

You can adjust picture contrast, brightness, colour intensity, sharpness and tint (NTSC only) to the levels you prefer.

1. Press the **MENU** button and then **▲ / ▼** button to select the **PICTURE** menu.
2. Press the **▶** button and then **▲ / ▼** button to select **PSM**.



3. Press the **▶** button and then **▲ / ▼** button to select **User**.
4. Press the **◀** button and then **▲ / ▼** button to select the desired picture option. (**Contrast**, **Brightness**, **Color**, **Sharpness** and **Tint**)
5. Press the **◀ / ▶** button to make appropriate adjustments.
6. Press the **MENU** button to save.

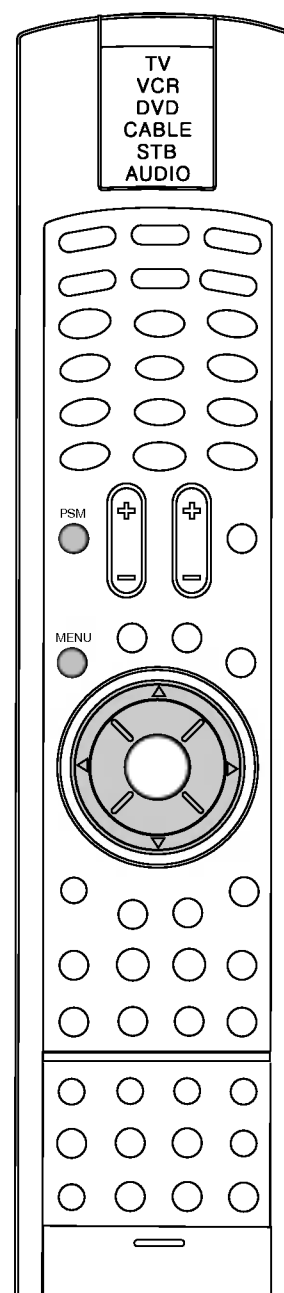

# PICTURE Menu

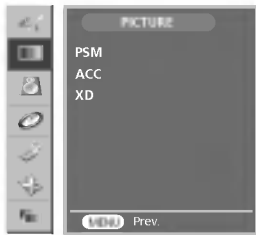

PICTURE menu

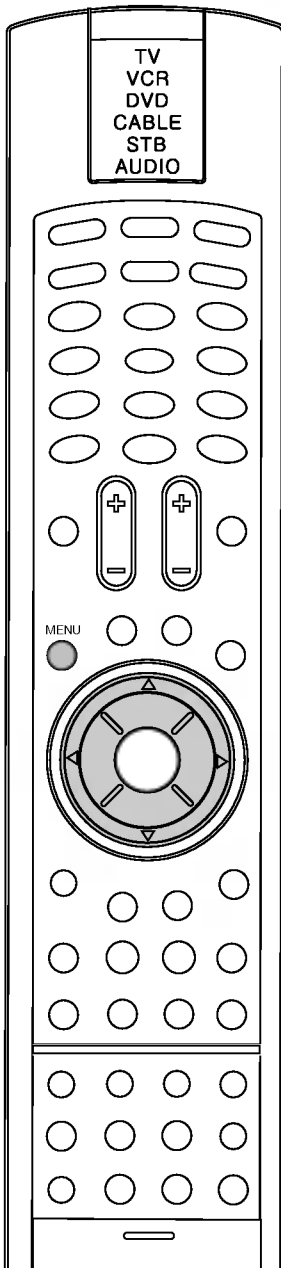

## ACC

To initialize values (reset to default settings), select the **Normal** option.

1. Press the **MENU** button and then **▲ / ▼** button to select the PICTURE menu.
2. Press the **▶** button and then **▲ / ▼** button to select **ACC**.

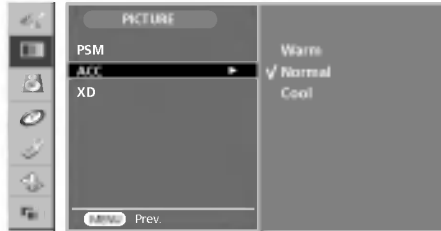

3. Press the **▶** button and then **▲ / ▼** button to select **Warm**, **Normal** or **Cool**.
4. Press the **MENU** button to save.

## XD

XD is LG Electronic's unique picture improving technology to display a real HD source though an advanced digital signal processing algorithm.

**XD Demo** - Use to see the difference between XD Demo On and XD Demo Off.

1. Press the **MENU** button and then **▲ / ▼** button to select the PICTURE menu.
2. Press the **▶** button and then **▲ / ▼** button to select **XD**.
3. Press the **▶** button and then **▲ / ▼** button to select **Off**, **On** or **XD Demo**.



4. Press the **MENU** button to save **Off** or **On**. Press the **EXIT** button to stop **XD Demo**.

# SOUND Menu

## SSM (Sound Status Memory)

You can select your preferred sound setting; Flat, Music, Movie or Speech and you can also adjust the sound frequency of equalizer.

1. Press the **MENU** button and then **▲ / ▼** button to select the **SOUND** menu.



**SOUND menu**

2. Press the **▶** button and then **▲ / ▼** button to select **SSM**.
3. Press the **▶** button and then **▲ / ▼** button to select a sound setting on the **SSM** menu.

### Sound Frequency Adjustment

- a. Press the **OK** button in **User**.

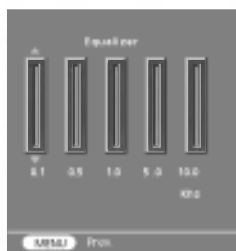

- b. Select a sound band by pressing the **◀ / ▶** button.
  - c. Make appropriate sound level with the **▲ / ▼** button.
  - d. Press the **OK** button to store it for the sound **User**.
4. Press the **MENU** button to save.

You can also recall a desired sound setting (**Flat**, **Music**, **Movie**, **Speech** or **User**) with **SSM** button on the remote control. The sound settings **Flat**, **Speech**, **Movie** and **Music** are programmed for optimum sound reproduction at the factory and cannot be changed.

**Note :** If you press the **SSM** button after making appropriate adjustment on the **User** sub menu, the display **User** automatically appears even though you have already set a factory preset setting; **Flat**, **Music**, **Movie** or **Speech**.

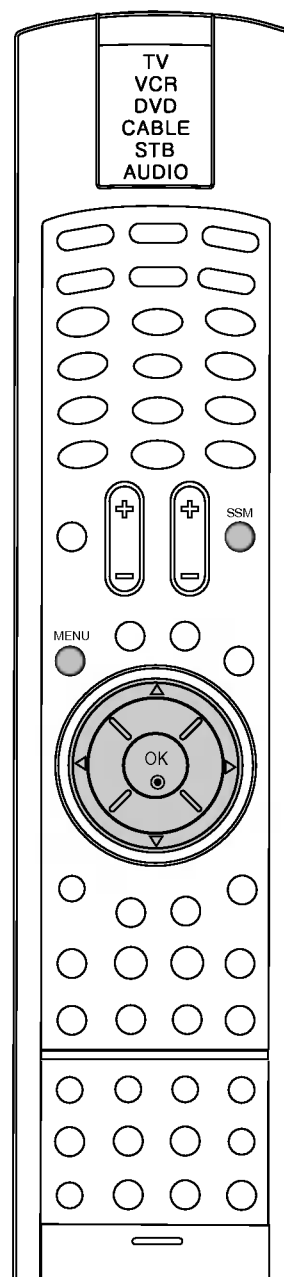

---

# SOUND Menu

---



SOUND menu

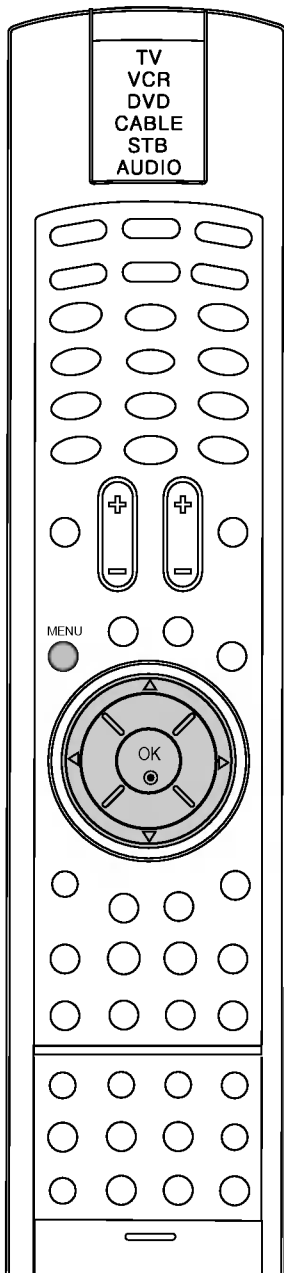

## Sound adjustment

You can adjust balance, AVL (Auto Volume Leveler). AVL automatically keeps on an equal volume level even if you change programmes.

1. Press the **MENU** button and then **▲ / ▼** button to select the **SOUND** menu.



2. Press the **▶** button and then **▲ / ▼** button to select the desired sound item; **Balance** or **AVL**.
3. **Balance:** Make desired adjustment with the **◀ / ▶** and then press the **OK** button.  
**AVL:** Press the **▲ / ▼** button to select **Off** or **On**.
4. Press the **MENU** button to save.

## SRS WOW

The SRS WOW function plays back the mono or stereo sound input with the dynamic surround effects. It will provide rich and profound sound tone. If you set the **SRS WOW** on, user audio setting can not be adjusted.

1. Press the **MENU** button and then **▲ / ▼** button to select the **SOUND** menu.
2. Press the **▶** button and then **▲ / ▼** button to select **SRS WOW**.



3. Press the **▶** button and then **▲ / ▼** button to select **Off** or **On**.
4. Press the **MENU** button to save



is a trademark of SRS Labs, Inc.  
technology is incorporated under license from SRS Labs, Inc.

# SOUND Menu

## Stereo/Dual reception

When a programme is selected, the sound information for the station appears after the programme number and station name disappear.

Broadcast	On Screen Display
Mono	<b>MONO</b>
Stereo	<b>STEREO</b>
Dual	<b>DUAL I</b>



SOUND menu

## Mono sound selection

In stereo reception if the stereo signal is weak, you can switch to mono by pressing the I/II button twice. In mono reception the depth of sound is improved. To switch back to stereo, press the I/II button twice again.

## Language selection for dual language broadcast

If a programme received in two languages (dual language), you can switch to **DUAL I**, **DUAL II** or **DUAL I+II** by pressing the I/II button repeatedly.

**DUAL I** sends the primary broadcast language to the loudspeakers.

**DUAL II** sends the secondary broadcast language to the loudspeakers.

**DUAL I+II** sends a separate language to each loudspeaker.

## NICAM reception

If your set is equipped with the receiver for NICAM reception, the high quality NICAM (Near Instantaneous Companding Audio Multiplex) digital sound can be received.

Sound output can be selected according to the type of received broadcast as follows by pressing the I/II button repeatedly.

1. When NICAM mono is received, you can select **NICAM MONO** or FM MONO.
2. When NICAM stereo is received, you can select **NICAM STEREO** or FM MONO. If the stereo signal is weak, switch to FM mono.
3. When NICAM dual is received, you can select **NICAM DUAL I**, **NICAM DUAL II** or **NICAM DUAL I+II** or **MONO**.

## Sound output selection

In Component1, Component2 mode, you can select output sound for the left and right loudspeakers.

Repeatedly press the I/II button to select the sound output.

**L+R** : Audio signal from audio L input is sent to the left loud speaker and audio signal from audio R input is sent to the right loud speaker.

**L+L** : Audio signal from audio L input is sent to left and right loudspeakers.

**R+R** : Audio signal from audio R input is sent to left and right loudspeakers.

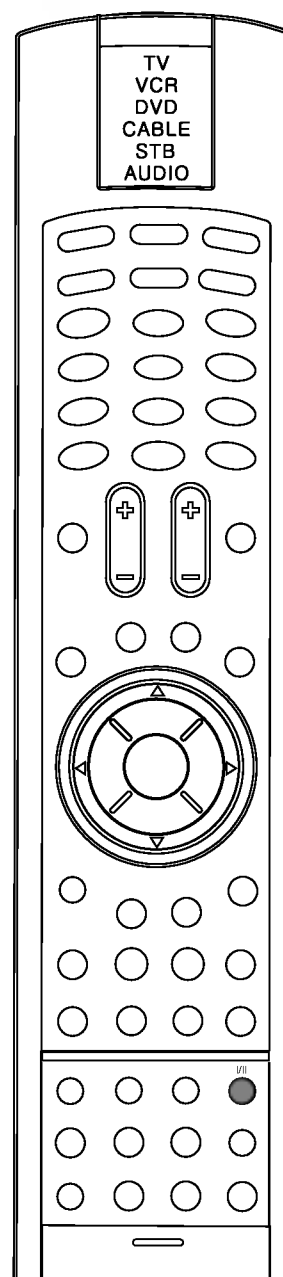

# TIMER Menu



TIMER menu

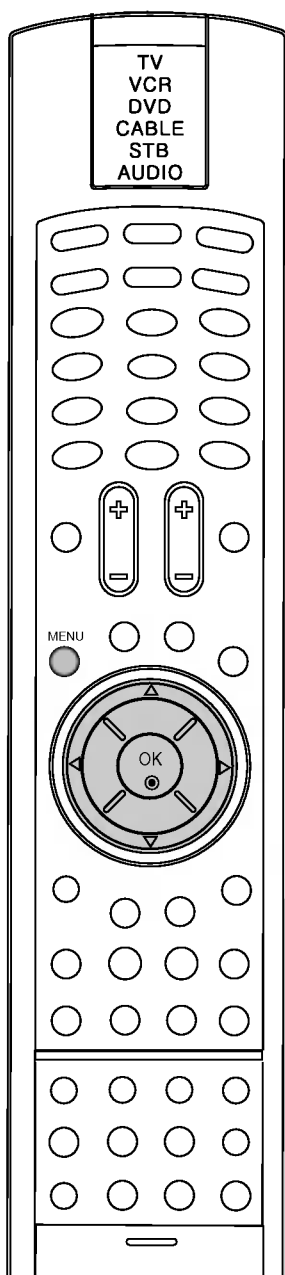

## Clock

You must set the time correctly before using on/off time function.

1. Press the **MENU** button and then **▲ / ▼** button to select the **TIMER** menu.
2. Press the **▶** button and then **▲ / ▼** button to select **Clock**.

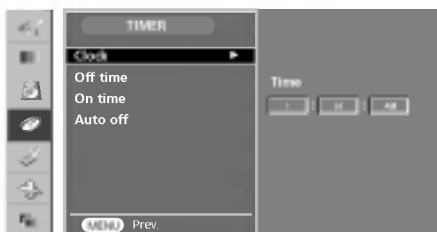

3. Press the **▶** button and then **▲ / ▼** button to adjust the hour.
4. Press the **▶** button and then **▲ / ▼** button to adjust the minute.
5. Press the **▶** button and then **▲ / ▼** button to select AM or PM.
6. Press the **MENU** button to save.

## On/Off time

The off timer automatically switches the set to standby at the pre-set time.

1. Press the **MENU** button and then **▲ / ▼** button to select the **TIMER** menu.
2. Press the **▶** button and then **▲ / ▼** button to select **Off time** or **On time**.

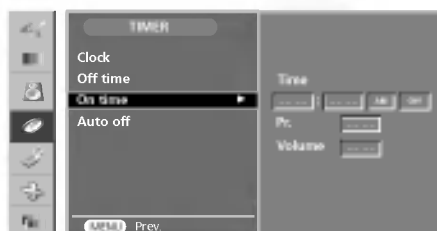

3. Press the **▶** button and then **▲ / ▼** button to adjust the hour.
4. Press the **▶** button and then **▲ / ▼** button to adjust the minute.
5. Press the **▶** button and then **▲ / ▼** button to adjust the morning(AM) or afternoon(PM).
6. Press the **▶** button and then **▲ / ▼** button to select **On** or **Off**. To cancel **Off/On time** function, press the **▲ / ▼** button to select **Off**.
7. **Only On Time function:** Press the **▶** button and then **▲ / ▼** button to select the programme at turn-on and then press the **▶** button and then **▲ / ▼** button to adjust volume level.
8. Press the **MENU** button to save.

### Note :

- a. In the event of power interruption (disconnection or power failure), the clock must be reset.
- b. Two hours after the set is switched on by the on time function it will automatically switch back to standby mode unless a button has been pressed.
- c. Once the on or off time is set, these functions operate daily at the preset time.
- d. Off Time function overrides On Time function if they are set to the same time.
- e. The set must be in standby mode for the On Time to work.

---

# TIMER Menu

---

## Auto off

If you select **On** on the **Auto off** menu, the set will automatically switch itself to standby mode approximately ten minutes after a TV station stops broadcasting.

1. Press the **MENU** button and then **▲ / ▼** button to select the **TIMER** menu.
2. Press the **▶** button and then **▲ / ▼** button to select **Auto off**.
3. Press the **▶** button and then **▲ / ▼** button to select **Off** or **On**.

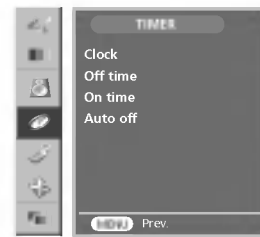

TIMER menu



4. Press the **MENU** button to save.

## Sleep timer

You don't have to remember to switch the set off before you go to sleep. The sleep timer automatically switches the set to standby after the preset time has elapsed.

Press the **SLEEP** button to select the number of minutes. The display '● 0 MIN' will appear on the screen, followed by **10, 20, 30, 60, 90, 120, 180** and **240**. The timer begins to count down from the number of minutes selected.

### Note :

- a. To view the remaining sleep time, press the **SLEEP** button once.
- b. To cancel the sleep time, repeatedly press the **SLEEP** button until the display '● 0 MIN' appears.
- c. When you switch the set off, the set releases the preset sleep time.

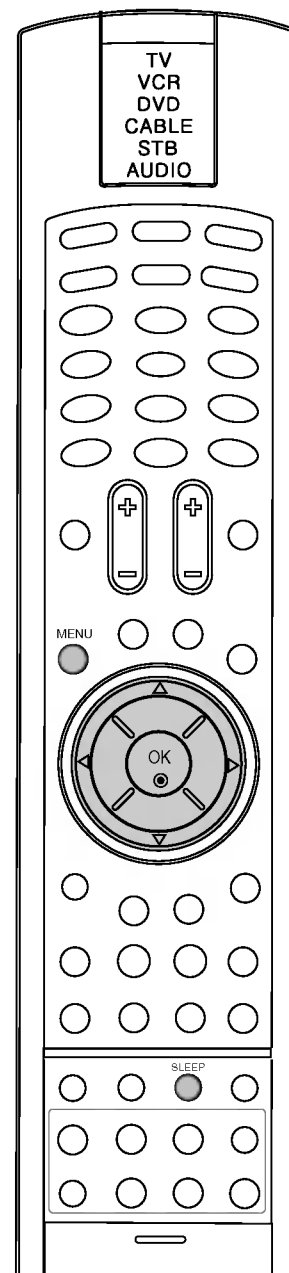

# SPECIAL Menu

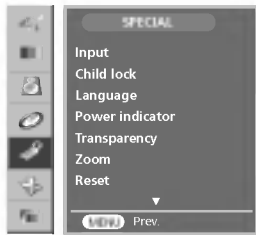

**SPECIAL menu**

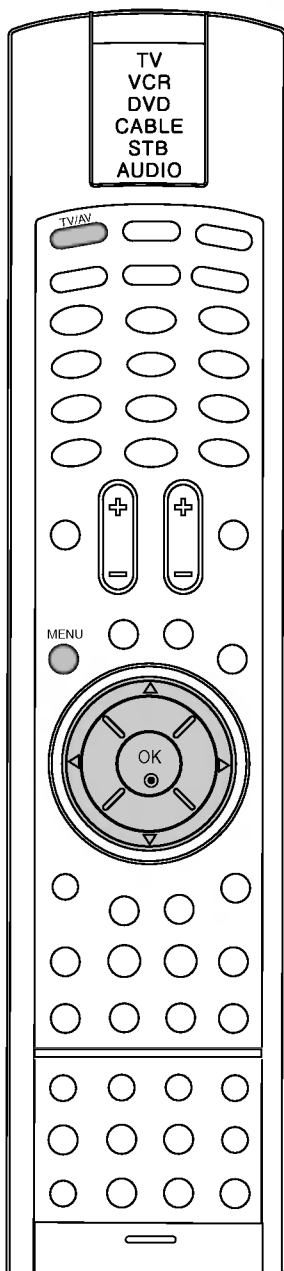

## Main Picture Source Selection

Inputs can be set for TV, AV, S-Video, Component1, Component2, RGB PC, DVI PC mode. AV mode is used when a video cassette recorder (VCR), or other equipment is connected to the set.

**Note :** When a VCR is connected via the aerial socket the set is used in TV mode. See the 'Connection of external equipment' section.

1. Press the **MENU** button and then **▲ / ▼** button to select the SPECIAL menu.
2. Press the **▶** button and then **▲ / ▼** button to select **Input**.
3. Press the **▶** button and then **▲ / ▼** button to select **TV, AV, S-Video, Component1, Component2, RGB PC, DVI PC**.

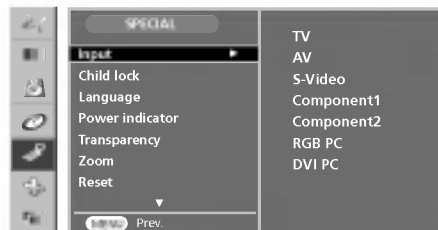

AV: VCR connected to the RCA jack on the side panel.

S-Video: S-VIDEO VCR connected to the **S-VIDEO** sockets on the side panel set

Component1: DTV connected to the **Component 1** sockets on the back of set.

Component2: DVD connected to the **Component 2 (480i, 576i)** sockets on the back of set.

RGB PC: PC connected to the RGB socket on the set

DVI PC: PC connected to the DVI socket on the set

4. Press the **MENU** button to save.

You can select the Inputs can be set for TV, AV, S-Video, Component1, Component2, RGB PC, DVI PC mode by pressing the **TV/AV** button.

In AV, S-Video, Component1, Component2, RGB PC, DVI PC mode, press the PR +/- or NUMBER buttons to return to TV mode.

# SPECIAL Menu

## Child lock

The TV can be set so that the remote control handset is needed to control it. This feature can be used to prevent unauthorized viewing.

1. Press the **MENU** button and then ▲ / ▼ button to select the **SPECIAL** menu.
2. Press the ► button and then ▲ / ▼ button to select **Child lock**.

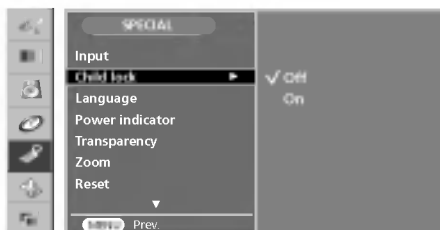

3. Press the ► button and then ▲ / ▼ button to select **Off** or **On**.
4. Press the **MENU** button to save.

With the lock on, the display **Controls locked** appears on the screen if any button on the side panel is pressed while viewing the TV.

## Power indicator

Use this function to set the power indicator on the front side of the TV to ON or OFF. If you set OFF, it will go off after 15 seconds. If you set ON at any time, the power indicator will automatically be turned on.

1. Press the **MENU** button and then ▲ / ▼ button to select the **SPECIAL** menu.
2. Press the ► button and then ▲ / ▼ button to select **Power indicator**.
3. Press the ► button and then ▲ / ▼ button to select **Off** or **On**.
4. Press the **MENU** button to save.

## Transparency

To adjust the transparency of the OSD menu screen.

1. Press the **MENU** button and then ▲ / ▼ button to select the **SPECIAL** menu.
2. Press the ► button and then ▲ / ▼ button to select **Transparency**.

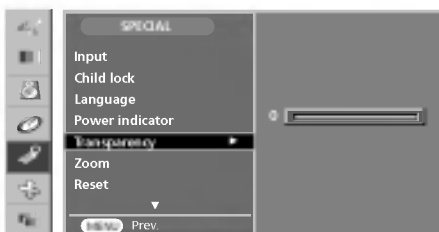

3. Press the ► button and then press the ◀ / ▶ button to make appropriate adjustments.
4. Press the **MENU** button to save.

### Note :

• The adjustment range of **Transparency** is 0~100.

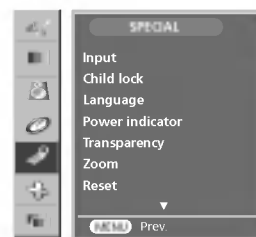

**SPECIAL menu**

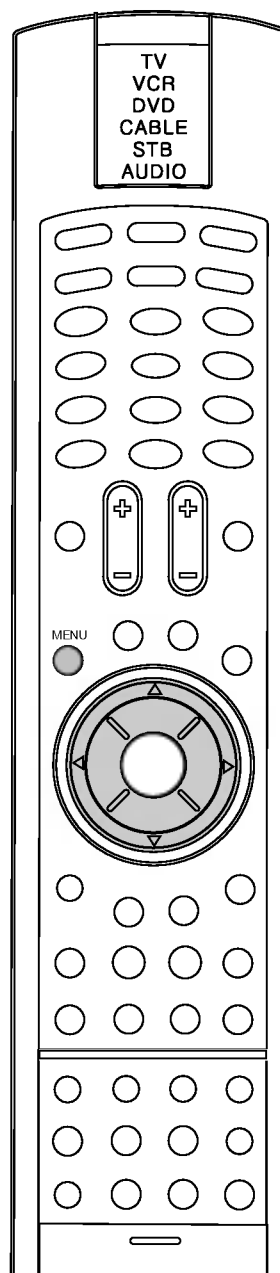

---

# SPECIAL Menu

---

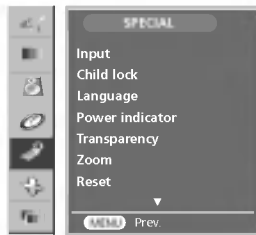

**SPECIAL menu**

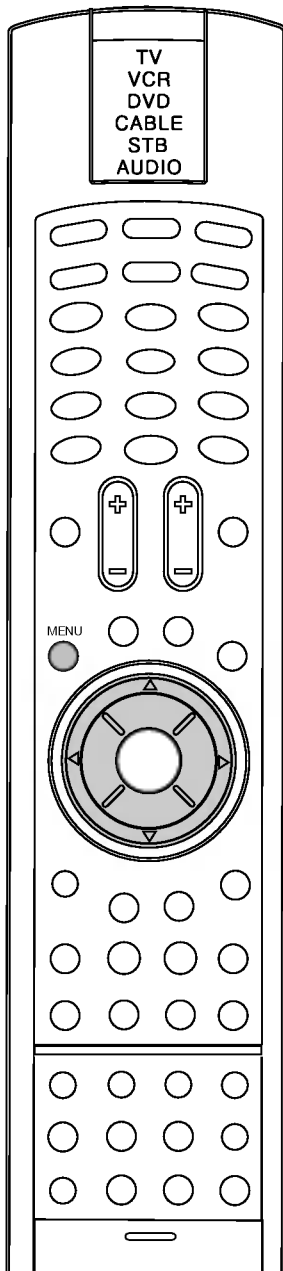

## Picture Size Zoom

Use this function to zoom in the screen.

When you turn the TV off and on again, the default screen size will be restored.

1. Press the **MENU** button and then **▲ / ▼** button to select the **SPECIAL** menu.
2. Press the **▶** button and then **▲ / ▼** button to select **Zoom**.



3. Press the **▶** button and then **▲ / ▼** button to select **Zoom**. Press the **◀ / ▶** button to enlarge or reduce the picture size.
4. Press the **▲ / ▼** button to select **H Position** or **V Position**. Press the **◀ / ▶** button to adjust the picture position while in enlarged picture mode.
5. Press the **MENU** button to save.

**Note :** If the zooming value is set to '0', vertical and horizontal positioning cannot be adjusted.

## Reset

Use this function to reset the set to the factory default. However, language selection will not be initialized.

1. Press the **MENU** button and then **▲ / ▼** button to select the **SPECIAL** menu.
2. Press the **▶** button and then **▲ / ▼** button to select **Reset**.

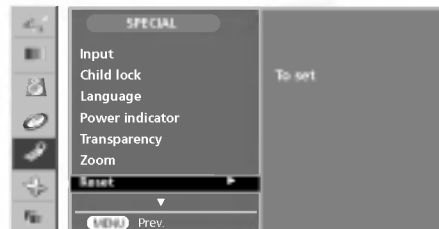

3. Press the **▶** button to start **Reset**.
4. Repeatedly press the **MENU** button to return to normal TV viewing.

**Note :** This function operates in every mode.

---

# SCREEN Menu

---

## Picture format

You can watch TV in various picture formats; Full, 4:3, Spectacle, Zoom1 and Zoom2.

1. Press the **MENU** button and then ▲ / ▼ button to select the **SCREEN** menu.
2. Press the ► button and then ▲ / ▼ button to select **ARC**.



SCREEN menu

3. Press the ► button and then ▲ / ▼ button to select your desired picture format.
4. Press the **MENU** button to save.

You can also select **Full**, **4:3**, **Spectacle**, **Zoom1** or **Zoom2** with the **ARC** button on the remote control.

### Full

When your TV receives the wide screen signal, it will lead you to adjust the picture horizontally or vertically, in a linear proportion, to fill the entire screen fully.

### 4:3

It will lead you to view a picture with an original 4:3 aspect ratio, with gray bars appearing at both the left and right sides.

### Spectacle

When your TV receives the wide screen signal, it will lead you to adjust the picture horizontally, in a linear proportion, to fill the entire screen.

### Zoom1

Choose **Zoom1** when you want to view the picture without any alteration. However, the top and bottom portions of the picture will be cropped.

### Zoom2

Choose **Zoom2** when you want the picture to be altered, both vertically extended and cropped. The picture taking a halfway trade off between alteration and screen coverage.

### Note :

- a. In PIP/POP/PBP mode, ARC function isn't available.
- b. In RGB, DVI modes, you can only select **1:1** and **Full** screen.

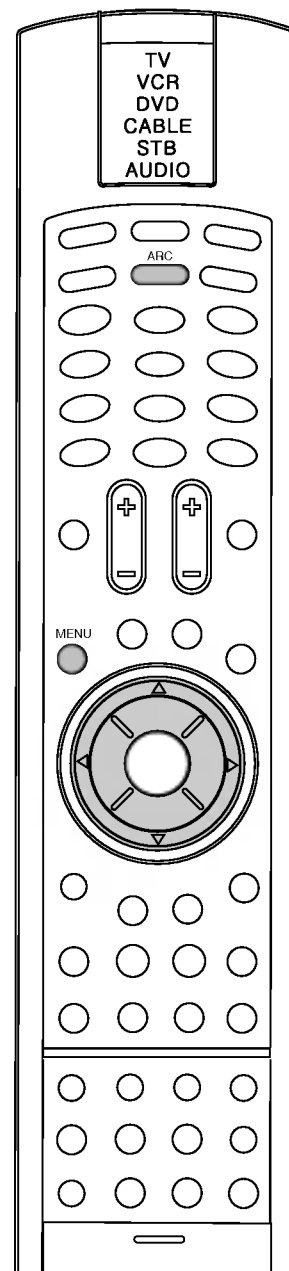

---

# SCREEN Menu

---



SCREEN menu

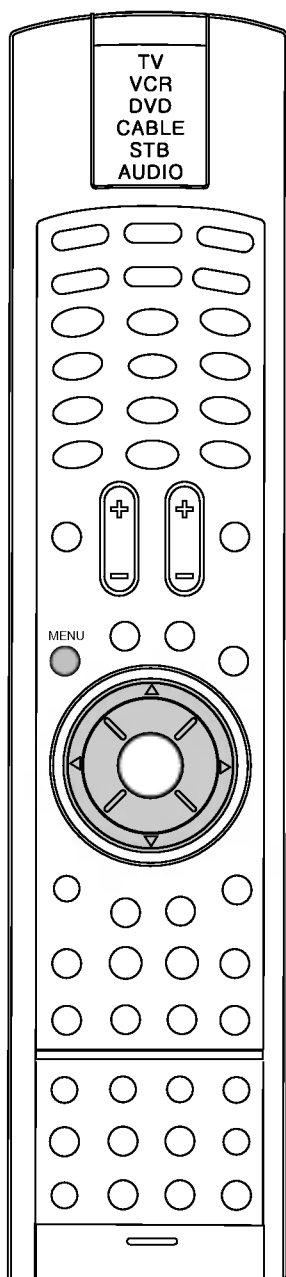

## Auto adjustment (RGB [PC] mode only)

Automatically adjusts picture position and minimizes image shaking.

1. Press the **MENU** button and then **▲ / ▼** button to select the **SCREEN** menu.
2. Press the **▶** button and then **▲ / ▼** button to select **Auto-Configure**.



3. Press the **▶** button to start **Auto-configure**.  
If the position of the image is still not correct, try Auto adjustment again.
4. Repeatedly press the **MENU** button to return to normal TV viewing.

## Clock and Phase (RGB [PC] mode only)

If the picture isn't clear after auto adjustment and especially that characters are still trembling, adjust the picture phase manually. To correct the screen size, adjust **Clock**.

1. Press the **MENU** button and then **▲ / ▼** button to select the **SCREEN** menu.
2. Press the **▶** button and then **▲ / ▼** button to select **Clock** or **Phase**.
3. Press the **▶** button and then press the **◀ / ▶** button to make appropriate adjustments.

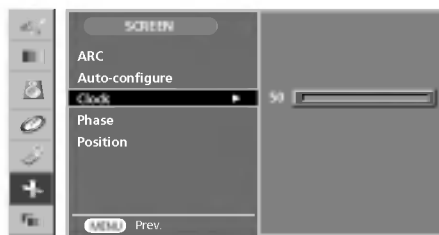

4. Press the **MENU** button to save.

### Note :

- a. The adjustment range of **Phase** is 0~100.
- b. The adjustment range of **Clock** is 0~100.

---

# SCREEN Menu

---

## SCREEN Position (RGB [PC] mode only)

1. Press the **MENU** button and then ▲ / ▼ button to select the SCREEN menu.
2. Press the ► button and then ▲ / ▼ button to select **Position**.

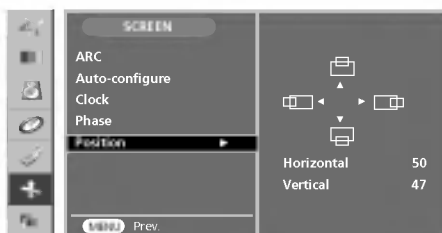

3. Press the ► button and then ▲ / ▼ or ◀ / ▶ button until desired position is achieved.
4. Press the **MENU** button to save.



SCREEN menu

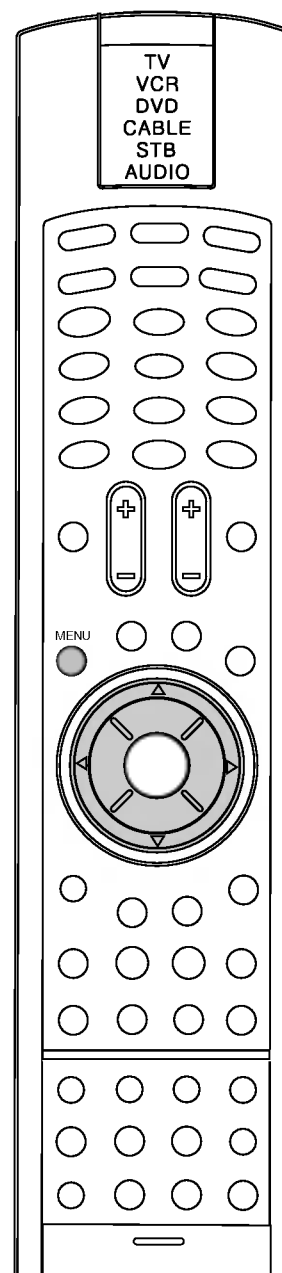

# PIP/POP/PBP operation



PIP/POP/PBP menu

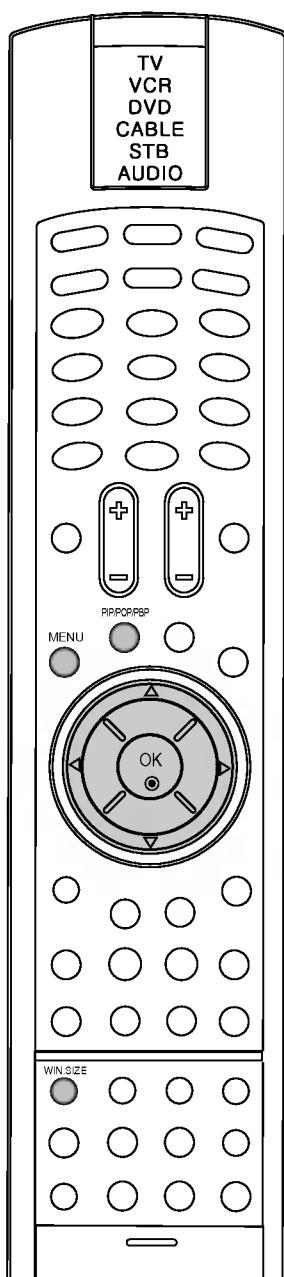

## PIP/POP/PBP mode

1. Press the **MENU** button and then **▲ / ▼** button to select the PIP/POP/PBP menu.
2. Press the **▶** button and then **▲ / ▼** button to select **On/Off**.



3. Press the **▶** button and then **▲ / ▼** button to select **Off, PIP, POP** or **PBP**.
4. Press the **MENU** button to save.



### PIP

After selecting PIP in the PIP On/Off menu, the following menu items can be adjusted.



### POP

After selecting POP in the POP On/Off menu, the following menu items can be adjusted.



### PBP

After selecting PBP in the PBP On/Off menu, the following menu items can be adjusted.

You can also select **PIP, POP, PBP** or **Off** with the **PIP/POP/PBP** button on the remote control.

## Sub Picture Size

To adjust the size of the PIP/PBP screen. (PIP: Small, Medium, Large / PBP : Full, 4:3)

1. Press the **MENU** button and then **▲ / ▼** button to select the PIP/POP/PBP menu.
2. Press the **▶** button and then **▲ / ▼** button to select **Size**.
3. Press the **▶** button and then **▲ / ▼** button to adjust the sub picture size.

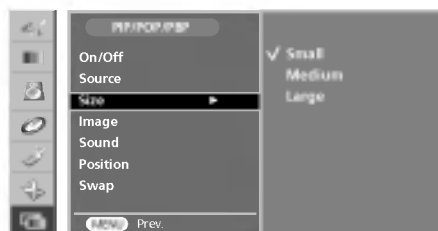

4. Press the **MENU** button to save.

You can also adjust this function with the **WIN.SIZE** button on the remote control.

# PIP/POP/PBP operation

## Source

To select an input signal for PIP/POP/PBP.

Inputs can be set for TV, AV, S-Video, Component1, Component2, RGB PC, DVI PC mode. AV mode is used when a video cassette recorder (VCR), or other equipment is connected to the set.

**Note :** When a VCR is connected via the aerial socket the set is used in TV mode. See the 'Connection of external equipment' section.

1. Press the **MENU** button and then **▲ / ▼** button to select the PIP/POP/PBP menu.
2. Press the **▶** button and then **▲ / ▼** button to select **Source**.



3. Press the **▶** button and then **▲ / ▼** button to select **TV, AV, S-Video, Component 1, Component 2, RGB PC, DVI PC**.

AV: VCR connected to the RCA jack on the side panel.

S-Video: S-VIDEO VCR connected to the **S-VIDEO** sockets on the back panel set

Component1: DTV connected to the **Component 1** sockets on the back of set.

Component2: DVD connected to the **Component 2** sockets on the back of set.

RGB PC: PC connected to the RGB socket on the set

DVI PC: PC connected to the DVI socket on the set

4. Press the **MENU** button to save.

### <Table of PIP/POP/PBP Function Support>

Main Screen Sub-Screen	TV	AV	S-Video	COMPONENT1	COMPONENT2	RGB-PC	DVI-PC
	TV	X	X	X	X	X	●
AV	X	X	X	X	X	●	●
S-Video	X	X	X	X	X	●	●
COMPONENT 1	X	X	X	X	X	●	●
COMPONENT 2	X	X	X	X	X	●	●
RGB-PC	●	●	●	●	●	X	●
DVI-PC	●	●	●	●	●	●	X

You can also adjust this function with the **PIP INPUT** button on the remote control.



PIP/POP/PBP menu

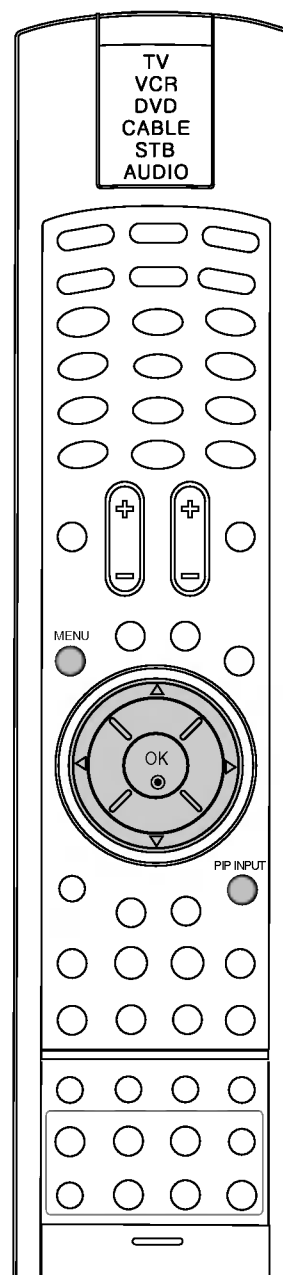

# PIP/POP/PBP operation



PIP/POP/PBP menu

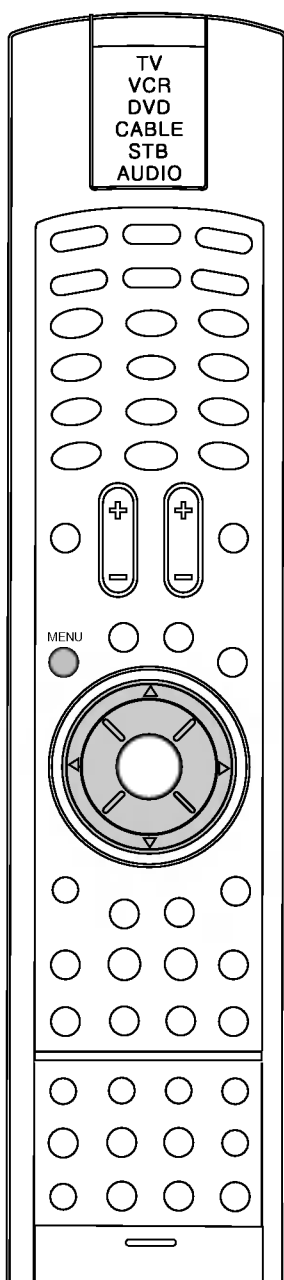

## Image

To adjust the image of the PIP/POP/PBP screen.

1. Press the **MENU** button and then ▲ / ▼ button to select the PIP/POP/PBP menu.
2. Press the ► button and then ▲ / ▼ button to select **Image**.



3. Press the ► button and then ▲ / ▼ button to select **Contrast**, **Brightness**, **Color** or **Tint** (NTSC only).
4. Press the ◀ / ▶ button to make appropriate adjustments
5. Press the **MENU** button to save.

*Note : When PIP input source, only Color and Tint is TV mode.*

## Sound

To turn the PIP/POP/PBP sound on/off

1. Press the **MENU** button and then ▲ / ▼ button to select the PIP/POP/PBP menu.
2. Press the ► button and then ▲ / ▼ button to select **Sound**.

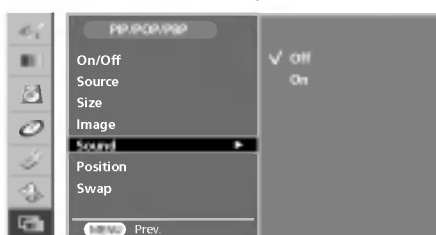

3. Press the ► button and then ▲ / ▼ button to select **Off** or **On**.
4. Press the **MENU** button to save.

## Moving the sub Picture

To adjust the position to PIP screen.

1. Press the **MENU** button and then ▲ / ▼ button to select the PIP/POP/PBP menu.
2. Press the ► button and then ▲ / ▼ button to select **Position**.



3. Press the ► button and then ▲ / ▼ button until desired position is achieved.  
The sub picture moves up/down or left/right.
4. Press the **MENU** button to save.

You can also adjust this function with **WIN.POSITION** button on the remote control.

# PIP/POP/PBP operation

## Swap

To switch the main-screen and sub-screen in PIP/POP/PBP mode.

1. Press the **MENU** button and then **▲ / ▼** button to select the PIP/POP/PBP menu.



PIP/POP/PBP menu

2. Press the **▶** button and then **▲ / ▼** button to select **Swap**.
3. Press the **▶** button to switch the main-screen and sub-screen.
4. Press the **MENU** button to save.

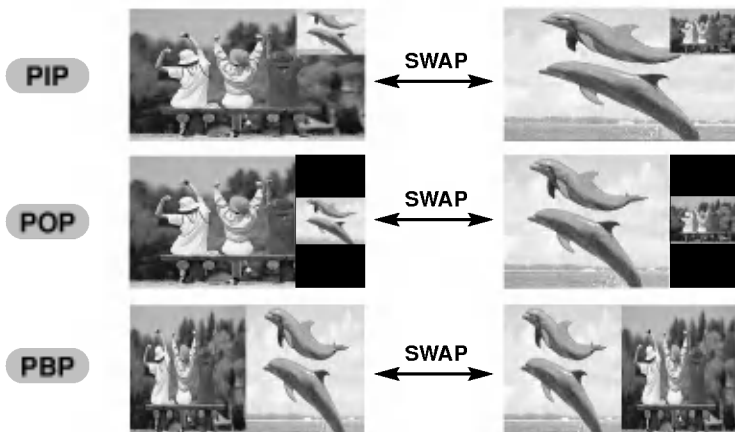

Press the **SWAP** button to exchange the main and sub pictures.

## Programme selection for sub picture

The sub picture programme selection is available when the sub picture is TV mode. Press the **PIP PR +/-** buttons to select a programme for the sub picture.

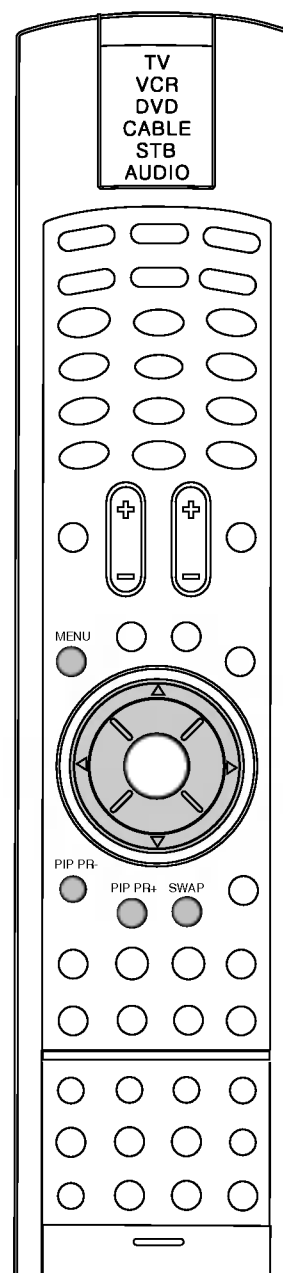

---

## Teletext (option)

---

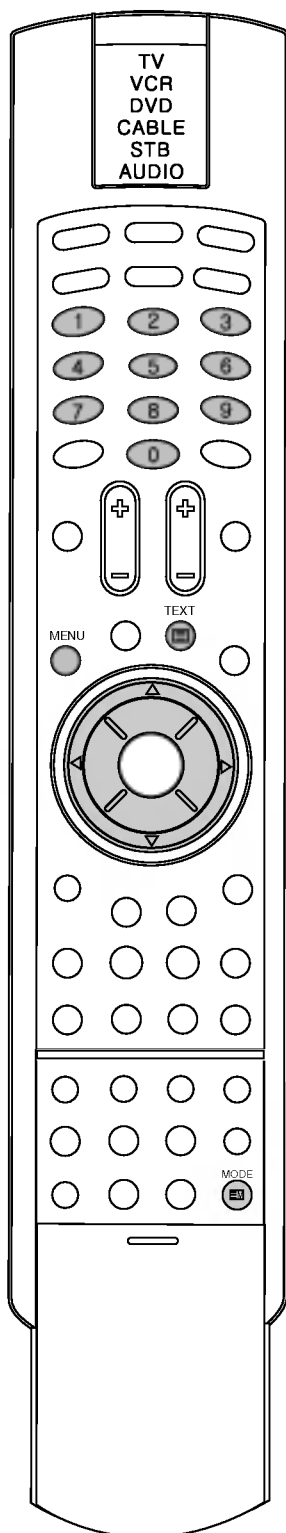

Teletext (or TOP text) is an optional function, therefore only a set with the teletext system can receive the teletext broadcast.

Teletext is a free service broadcast by most TV stations which gives up-to-the-minute information on news, weather, television programmes, share prices and many other topics.

The teletext decoder of this TV can support the SIMPLE, TOP and FASTEXT systems. SIMPLE (standard teletext) consists of a number of pages which are selected by directly entering the corresponding page number. TOP and FASTEXT are more modern methods allowing quick and easy selection of teletext information.

### Switch on/off

Press the **TEXT** button to switch to teletext.

The initial page or last page appears on the screen.

Two page numbers, TV station name, date and time are displayed on the screen headline. The first page number indicates your selection, while the second shows the current page displayed.

Press the **TEXT** button to switch off teletext. The previous mode reappears.

### SIMPLE text

#### Page selection

1. Enter the desired page number as a three digit number with the **NUMBER** buttons. If during selection you press a wrong number, you must complete the three digit number and then re-enter the correct page number.
2. The **▲ / ▼** button can be used to select the preceding or following page.

#### Programming a colour button in LIST mode

If the TV is in SIMPLE text, TOP text or FASTEXT mode, press the **EM** button to switch to LIST mode.

Four teletext page numbers of your choice can be colour coded and easily selected by pressing the corresponding coloured button on the remote control.

1. Press a coloured button.
2. Using the **NUMBER** buttons, select the page you wish to programme.
3. Press the **OK** button. The selected page is stored as the selected page number, blinking once to confirm this. From now on, you can select this page with the same coloured button.
4. The three other coloured buttons are programmed in this way.

---

## Teletext (option)

---

### TOP text (option)

The user guide displays four fields-red, green, yellow and blue at the bottom of the screen. The yellow field denotes the next group and the blue field indicates the next block.

#### Block / group / page selection

1. With the blue button you can progress from block to block.
2. Use the yellow button to proceed to the next group with automatic overflow to the next block.
3. With the green button you can proceed to the next existing page with automatic overflow to the next group.  
Alternatively the ▲ button can be used.
4. The red button permits to return to previous selection.  
Alternatively the ▼ button can be used.

#### Direct page selection

Corresponding to the SIMPLE teletext mode, you can select a page by entering it as a three digit number using the NUMBER buttons in TOP mode.

### FASTEXT

The teletext pages are colour coded along the bottom of the screen and are selected by pressing the corresponding coloured button.

#### Page selection

1. Press the  button to select the index page.
2. You can select the pages which are colour coded along the bottom line with the same coloured buttons.
3. Corresponding to the SIMPLE teletext mode, you can select a page by entering its three digit page number with the NUMBER buttons in FASTEXT mode.
4. The ▲ / ▼ button can be used to select the preceding or following page.

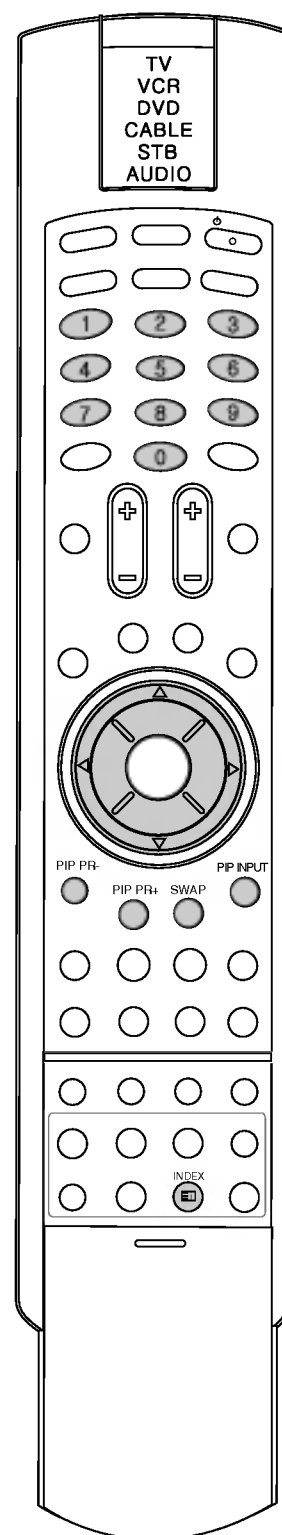

---

## Teletext (option)

---

### Special teletext functions

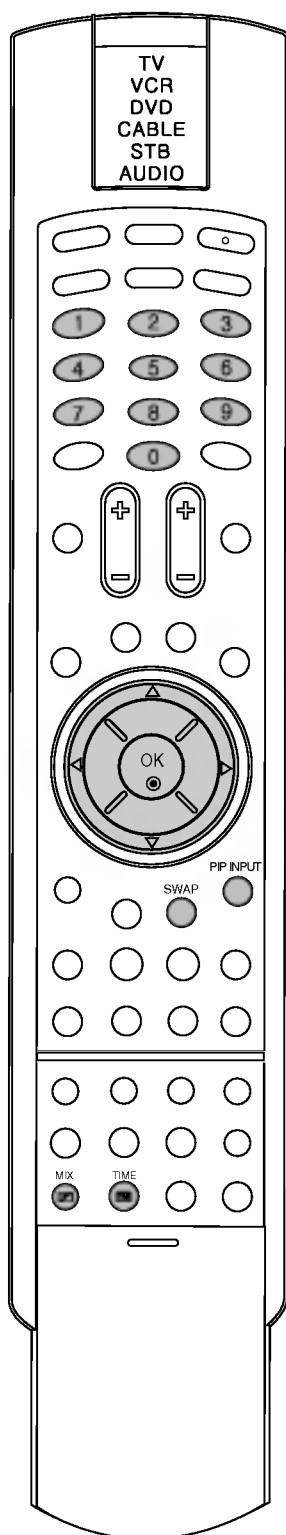

#### REVEAL

Press this button to display concealed information, such as solutions of riddles or puzzles.

Press this button again to remove the information from the display.



#### SIZE

Selects double height text.



Press this button to enlarge the top half of the page.

Press this button again to enlarge the bottom half of the page.

Press this button again to return to the normal display.



#### UPDATE

Displays the TV picture on the screen while waiting for the new teletext page. The display  will appear at the top left hand corner of the screen. When the updated page is available then display  will change to the page number.

Press this button to view the updated teletext page.



#### HOLD

Stops the automatic page change which will occur if a teletext page consists of 2 or more sub pages. The number of sub pages and the sub page displayed is, usually, shown on the screen below the time. When this button is pressed the stop symbol is displayed at the top left-hand corner of the screen and the automatic page change is inhibited.

To continue press this button again.





#### MIX

Displays the teletext pages superimposed on the TV picture.

To switch the TV picture off press this button again.



#### TIME

When viewing a TV programme, press this button to display the time at the top right hand corner of the screen. Press this button again to remove the display. In the teletext mode, press this button to select a sub page number. The sub page number is displayed at the bottom of the screen. To hold or change the sub page, press the RED / GREEN,  /  or NUMBER buttons.

Press this button again to exit this function.

---

## Connection of external equipment

---

You can connect additional equipment, such as VCRs, camcorders etc. to your set.

Here shown may be somewhat different from your set.

### Aerial socket

1. Connect the RF out socket of the VCR to the aerial socket on the back of the set.
2. Connect the aerial cable to the RF aerial in socket of the VCR.
3. Store the VCR channel on a desired programme number using the 'Manual programme tuning' section.
4. Select the programme number where the VCR channel is stored.
5. Press the **PLAY** button on the VCR.

### DVD input sockets

1. Connect the DVD output sockets (Y Cb Cr, Y Pb Pr, Y B-Y R-Y or Y PB PR) of the DVD to the **COMPONENT 1, 2 IN** sockets (Y PB PR) of the set.
2. Connect the audio cable from the DVD to **DVD INPUT AUDIO** sockets of the set.
3. Press the **TV/AV** or **INPUT** button to select **Component 1, 2**.
4. Press the **PLAY** button on the DVD.  
The DVD playback picture appears on the screen.

#### Note :

- a. **Component1** : DTV , DVD source
- b. **Component2** : DVD source.

### DTV in sockets

1. Connect the SET TOP outputs to the **COMPONENT1 IN** sockets (Y P<sub>B</sub> P<sub>R</sub>) of the set.
2. Connect the audio cable from the SET TOP to the **AUDIO** sockets of the set.
3. Press the **TV/AV** or **INPUT** button to select **Component 1**.

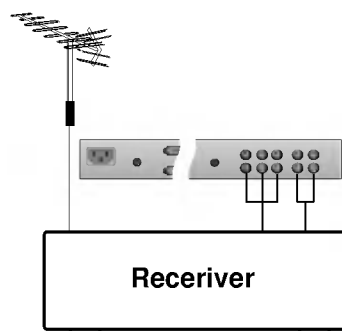
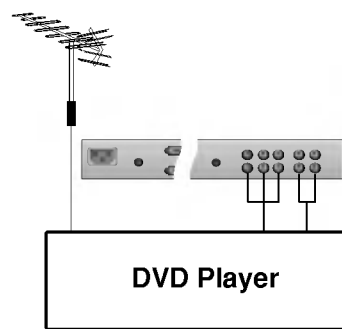
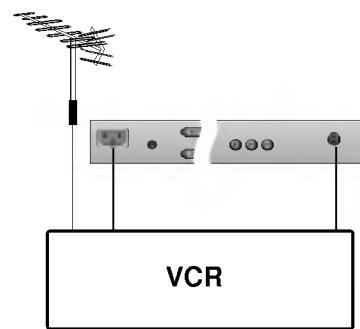

---

## Connection of external equipment

---

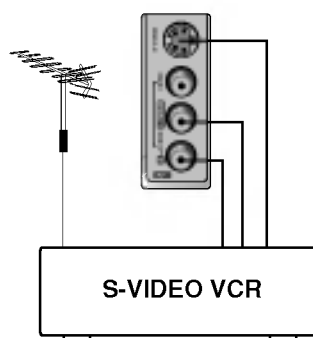

### S-Video/Audio in sockets (S-Video)

When connecting an S-VIDEO VCR to the **S-VIDEO** socket, the picture quality will be further improved.

1. Connect the S-Video socket of the VCR to the **S-VIDEO** socket of the set.
2. Connect the audio cable from the S-VIDEO VCR to the **AV / AUDIO L/R** sockets of the set.
3. Select **S-Video** by pressing the **TV/AV** button repeatedly.
4. Press the **PLAY** button on the VCR.  
The VCR playback picture appears on the screen.

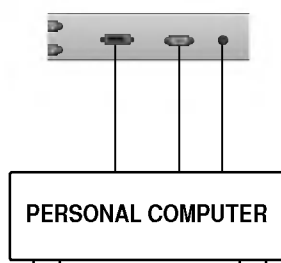

### PC in socket

1. Connect the signal cable from the TV output socket of the **PERSONAL COMPUTER** to the **RGB PC IN** or **DVI PC IN** socket of the set.
2. Connect the audio cable from the PC to the **AUDIO INPUT** sockets of the set.
3. Press the **INPUT** or **TV/AV** button to select **RGB PC** or **DVI PC**.
4. Switch on the PC, and the PC screen appears on the set.  
The set can be operated as the PC monitor.

**Note :** If you have an Apple macintosh, connect the VGA desktop block (not supplied) from the 3 row 15 pin to 2 row 15 pin with the signal cable and connect the VGA desktop block to the Macintosh.

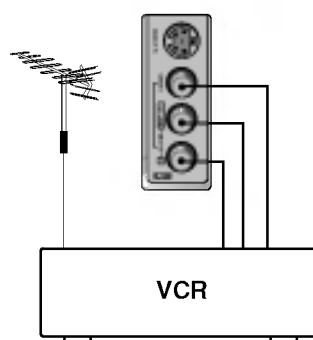

### Audio/Video in sockets

1. Connect the audio/video out sockets of the VCR to audio/video in sockets of the set.
2. Press the **TV/AV** button to select **AV**.
3. Press the **PLAY** button on the VCR.  
The VCR playback picture appears on the screen.

**Note :** If you have a mono VCR, connect the audio cable from the VCR to the **AUDIO L/MONO** socket of the set.

---

# Displayable Monitor Specification

---

## RGB Mode

MODE	Resolution	Horizontal Frequency (KHz)	Vertical Frequency (Hz)
1	640x350	31.47	70.80
2	720x400	31.47	70.80
3	640x480	31.47	59.94
4		37.50	75.00
5		43.27	85.00
6	800x600	37.88	60.32
7		46.88	75.00
8		53.67	85.06
9	832x624	49.73	74.55
10	1024x768	48.36	60.00
11		60.12	75.03
12		68.68	85.00
13	1280x720	44.77	59.86
14	1280x1024	63.98	60.02
15		79.98	75.02
16	1360x768	47.72	59.80
17	1600x1200	75.00	60.00

(Synchronization input form : separate)

**Note :**

- a. If the set is cold, there may be a small "flicker" when the set is switched on. This is normal, there is nothing wrong with the set.
- b. If possible, use the 1,360x768@60Hz video mode to obtain the best image quality for your LCD monitor. If used under the other resolutions, some scaled or processed pictures may appear on the screen. If used to PC vertical frequency 85Hz, some noise can be seen when PIP is on. In this case, set the PC vertical frequency to 60Hz.
- c. Some dot defects may appear on the screen, like Red, Green or Blue spots. However, this will have no impact or effect on the monitor performance.
- d. Do not press the LCD screen with your finger for a long time as this may produce some temporary distortion effects on the screen.
- e. When the PC screen appears on the set, a message may appear on the screen, and the message will differ according to the Window system version (Win98, 2000). If a message appears click "Next" until the message finishes.
- f. If the message "**Out of range**" appears on the screen, adjust the PC as in the 'Displayable Monitor Specification' section.

MODE 1~17 : D-Sub  
 MODE 1~14,16 : DVI-D

# External Control Device Setup

Connect the RS-232C input jack to an external control device (such as a computer or an A/V control system) and control the set's functions externally.

## RS-232C input socket

1. Connect the serial port of the control device to the RS-232C jack on the set.
2. RS-232C connection cables are not supplied with the set.
3. The set's remote control handset and side panel controls (except main power) will not be functional if the set is controlled by a PC computer or other external device.

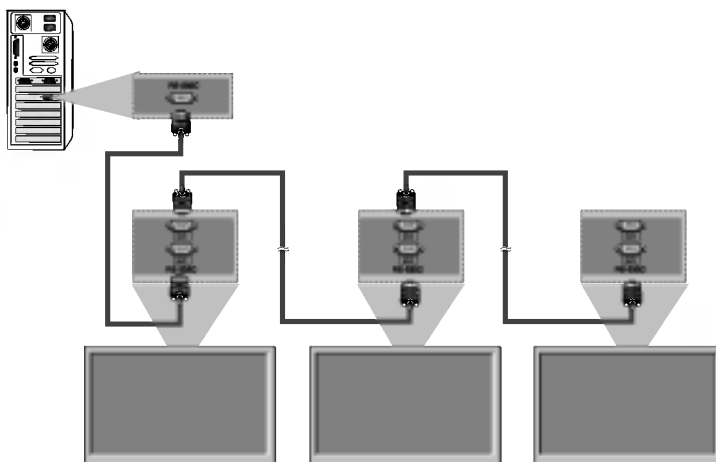

## D-Sub 9-pin male

No.	Pin name
1	No connection
2	RXD (Receive data)
3	TXD (Transmit data)
4	DTR (DTE side ready)
5	GND
6	DSR (DCE side ready)
7	RTS (Ready to send)
8	CTS (Clear to send)
9	No Connection

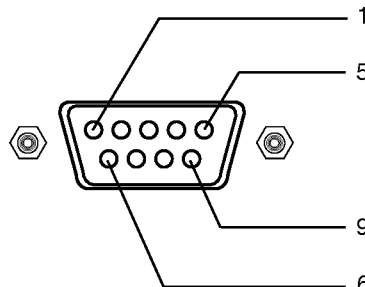

## Set ID

Use this function to specify a monitor ID number. Refer to 'Real Data Mapping'. See page 40.

1. Press the **MENU** button and then use the **▲ / ▼** button to select the **SPECIAL** menu.
2. Press the **▶** button and then use **▲ / ▼** button to select **Set ID**.
3. Press the **▶** button and then use **◀ / ▶** button to adjust **Set ID** to choose the desired monitor ID number.

**Note :** The adjustment range of **Set ID** is 0 ~ 99.



## Communication Parameters

- Baud rate : 9600 bps (UART)
  - Parity : None
  - Communication code : ASCII code
  - Data length : 8 bits
  - Stop bit : 1 bit
- \* Use a crossed (reverse) cable.

---

# External Control Device Setup

---

## Command Reference List

	COMMAND 1	COMMAND 2	DATA (Hexadecimal)
01. Power	k	a	0 ~ 1
02. Input Select	k	b	0 ~ 8
03. Volume Mute	k	e	0 ~ 1
04. Volume Control	k	f	0 ~ 64
05. Contrast	k	g	0 ~ 64
06. Brightness	k	h	0 ~ 64
07. Color	k	i	0 ~ 64
08. Tint	k	j	0 ~ 64
09. Sharpness	k	k	0 ~ 64
10. PIP/PBP/POP ON/OFF	k	n	0 ~ 3
11. PIP Position	k	q	0 ~ 3
12. Balance	k	t	0 ~ 64
13. ACC	k	u	0 ~ 3
14. PIP/PBP/POP SOURCE	k	y	0 ~ 8

## Transmission / Receiving Protocol

### Transmission

[Command1][Command2][ ][Set ID][ ][Data][Cr]

- \* [Command 1] : First command. (j or k)
- \* [Command 2] : Second command.
- \* [Set ID] : You can adjust the set ID to choose desired monitor ID number in Special menu. Adjustment range is 1~ 99. When selecting Set ID '0', every connected TV set is controlled. Set ID is indicated as decimal (1~99) on menu and as Hexa decimal (0x0~0x63) on transmission/receiving protocol.
- \* [DATA] : To transmit command data. Transmit 'FF' data to read status of command.
- \* [Cr] : Carriage Return ASCII code '0x0D'
- \* [ ] : ASCII code Space (0x20)'

### OK Acknowledgement

[Command2][ ][Set ID][ ][OK][Data][x]

- \* The Monitor transmits ACK (acknowledgement) based on this format when receiving normal data. At this time, if the data is data read mode, it indicates present status data. If the data is data write mode, it returns the data of the PC computer.

### Error Acknowledgement

[Command2][ ][Set ID][ ][NG][Data][x]

- \* The Monitor transmits ACK (acknowledgement) based on this format when receiving abnormal data from non-viable functions or communication errors.
- Data 1 : Illegal Code  
 2 : Not supported function  
 3 : Wait more time

---

# External Control Device Setup

---

## 01. Power On (Command : a)

- ▶ To control Power On/Off of the Set.

### Transmission

[k][a][ ][Set ID][ ][Data][Cr]

Data 0 : Power Off                    1 : Power On

### Acknowledgement

[a][ ][Set ID][ ][OK][Data][x]

- ▶ To show the status of Power On/Off.

### Transmission

[k][a][ ][Set ID][ ][FF][Cr]

Data 0 : Power Off                    1 : Power On

### Acknowledgement

[a][ ][Set ID][ ][OK][Data][x]

\* The Monitor transmits ACK (acknowledgement) based on this format when receiving normal data. At this time, if the data is data read mode, it indicates present status data. If the data is data write mode, it returns the data of the PC computer.

## 02. Input Select (Command : b) (Main Picture Input)

- ▶ To select input source for the Set.  
You can also select an input source using the INPUT button on the remote control.

### Transmission

[k][b][ ][Set ID][ ][Data][Cr]

Data 0 : TV                                5 : Component 2  
      2 : AV                                6 : RGB PC  
      3 : S-Video                        8 : DVI PC  
      4 : Component 1

### Acknowledgement

[b][ ][Set ID][ ][OK][Data][x]

Data 0 : TV                                5 : Component 2  
      2 : AV                                6 : RGB PC  
      3 : S-Video                        8 : DVI PC  
      4 : Component 1

## 03. Volume Mute(Command : e)

- ▶ To control On/Off of the Volume Mute.

### Transmission

[k][e][ ][Set ID][ ][Data][Cr]

Data 0 : Volume Mute On (Volume Off)  
      1 : Volume Mute Off (Volume On)

### Acknowledgement

[e][ ][Set ID][ ][OK][Data][x]

Data 0 : Volume Mute On (Volume Off)  
      1 : Volume Mute Off (Volume On)

## 04. Volume Control(Command : f)

- ▶ To control On/Off of the volume.

### Transmission

[k][f][ ][Set ID][ ][Data][Cr]

Data        Min : 00H ~ Max : 64H  
(Hexadecimal code)

### Acknowledgement

[f][ ][Set ID][ ][OK][Data][x]

Data        Min : 00H ~ Max : 64H

## 05. Contrast (Command : g)

- ▶ To adjust screen contrast.  
You can also adjust the contrast in the Picture menu.

### Transmission

[k][g][ ][Set ID][ ][Data][Cr]

Data        Min : 00H ~ Max : 64H  
\*Refer to 'Real data mapping' as shown below.

### Acknowledgement

[g][ ][Set ID][ ][OK][Data][x]

## 06. Brightness (Command : h)

- ▶ To adjust screen brightness.  
You can also adjust the brightness in the Picture menu.

### Transmission

[k][h][ ][Set ID][ ][Data][Cr]

Data        Min : 00H ~ Max : 64H  
\* Refer to 'Real data mapping' as shown below.

### Acknowledgement

[h][ ][Set ID][ ][OK][Data][x]

\* Real data mapping  
0 : Step 0  
  ⋮  
A : Step 10 (SET ID 10)  
  ⋮  
F : Step 15 (SET ID 15)  
10 : Step 16 (SET ID 16)  
  ⋮  
64 : Step 100

\* Tint,Balance :-50 ~ +50

# External Control Device Setup

## 07. Color (Command : i) (TV,AV only)

- ▶ To adjust the screen color.  
You can also adjust the color in the Picture menu.

### Transmission

[k][i][ ][Set ID][ ][Data][Cr]

Data Min : 00H ~ Max : 64H  
(Hexadecimal code)

### Acknowledgement

[i][ ][Set ID][ ][OK][Data][x]

Data Min : 00H ~ Max : 64H

## 08. Tint (Command : j) (TV,AV -NTSC only)

- ▶ To adjust the screen tint.  
You can also adjust the tint in the Picture menu.

### Transmission

[k][j][ ][Set ID][ ][Data][Cr]

Data Red: 00H ~ Green: 64H  
(Hexadecimal code)

### Acknowledgement

[j][ ][Set ID][ ][OK][Data][x]

Data Red: 00H ~ Green: 64H

## 09. Sharpness (Command : k) (TV,AV only)

- ▶ To adjust the screen Sharpness.  
You can also adjust the sharpness in the Picture menu.

### Transmission

[k][k][ ][Set ID][ ][Data][Cr]

Data Min : 00H ~ Max : 64H  
(Hexadecimal code)

### Acknowledgement

[k][ ][Set ID][ ][OK][Data][x]

Data Min : 00H ~ Max : 64H

## 10. PIP/PBP/POP ON/OFF(Command : n)

- ▶ To control PIP/PBP/POP On/Off of the Set.

### Transmission

[k][n][ ][Set ID][ ][Data][Cr]

Data 0 : OFF 1 : PIP  
2 : PBP 3 : POP

### Acknowledgement

[n][ ][Set ID][ ][OK][Data][x]

Data 0 : OFF 1 : PIP  
2 : PBP 3 : POP

## 11. PIP Position(Command : q)

- ▶ To adjust PIP position.

### Transmission

[k][q][ ][Set ID][ ][Data][Cr]

Data 0 : Bottom of the right side on screen  
1 : Bottom of the left side on screen  
2 : Top of the left side on screen  
3 : Top of the right side on screen

### Acknowledgement

[q][ ][Set ID][ ][OK][Data][x]

Data 0 : Bottom of the right side on screen  
1 : Bottom of the left side on screen  
2 : Top of the left side on screen  
3 : Top of the right side on screen

## 12. Balance(Command : t)

- ▶ To adjust the screen Balance.

### Transmission

[k][t][ ][Set ID][ ][Data][Cr]

Data Min : 00H ~ Max : 64H  
(Hexadecimal code)

### Acknowledgement

[t][ ][Set ID][ ][OK][Data][x]

Data Min : 00H ~ Max : 64H

## 13. ACC(Command : u)

- ▶ To adjust the screen color temperature.

### Transmission

[k][u][ ][Set ID][ ][Data][Cr]

Data 0 : Normal (9300K) 1 : Cool  
2 : Warm (6500K) 3 : User  
PC : 0,2,3, AV : 0,1,2

### Acknowledgement

[u][ ][Set ID][ ][OK][Data][x]

Data 0 : Normal 1 : Cool  
2 : Warm 3 : User

## 14. PIP/PBP/POP SOURCE(Command : y)

- ▶ To select the sub-screen source.

Data 0 : TV 5 : Component 2  
2 : AV 6 : RGB PC  
3 : S-video 8 : DVI PC  
4 : Component 1

### Transmission

[k][y][ ][Set ID][ ][Data][Cr]

Data Min : 00H ~ Max : 08H  
(Hexadecimal code)

### Acknowledgement

[y][ ][Set ID][ ][OK][Data][x]

Data Min : 00H ~ Max : 08H

---

## Programming the Remote control

---

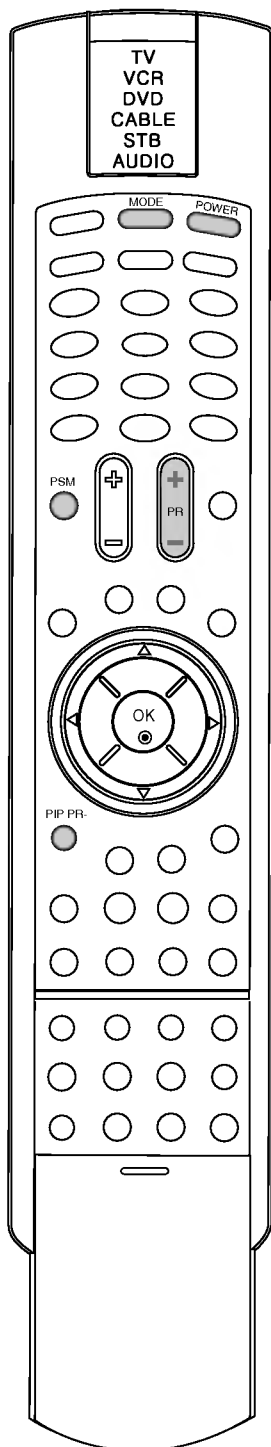

- ▶ The remote control is a multi-brand or universal remote control. It can be programmed to operate most remote-controllable devices of other manufacturers.  
Note that the remote control may not control all models of other brands.

### Programming a code into a remote mode

1. Test your remote control.  
To find out whether your remote control can operate the component without programming, turn on the component such as a VCR and press the corresponding **MODE** button (VCR) on the remote control, while pointing at the component. Test the **POWER** and **PR +/-** buttons to see if the component responds properly. If not, the remote requires programming to operate the device.
2. Turn on the component to be programmed, then press the corresponding **MODE** button on the remote control.
3. Press the **PSM** and **PIP PR-** buttons simultaneously, the remote control is ready to be programmed for the code.
4. Enter a code number using the number buttons on the remote. Programming code numbers for the corresponding component can be found on the following pages. Again, if the code is correct, the device will turn off.
5. Press the **PIP PR-** button to store the code.
6. Test the remote control functions to see if the component responds properly. If not, repeat from step 2.

# Programming Codes

## VCRs

Brand	Codes	Brand	Codes	Brand	Codes	Brand	Codes
AIWA	034	KENWOOD	014 034 039 043	PORTLAND	108	TATUNG	039 043
AKAI	016 043 046 124		047 048	PULSAR	072	TEAC	034 039 043
AMPRO	125 146	LG (GOLDSTAR)	001 012 013 020	QUARTZ	011 014	TECHNICS	031 033 070
ANAM	072		101 106 114 123	QUASAR	033 066 075 145	TEKNIKA	019 031 033 034
AUDIO DYNAMICS	031 033 103	LLOYD	034	RCA	013 020 033 034		101
BROKSONIC	012 023 039 043	LXI	003 009 013 014		040 041 062 063	THOMAS	034
CANON	035 037 129	MAGIN	017 034 101 106	REALISTIC	107 109 140 144	TMK	006
CAPEHART	028 031 033	MAGNAVOX	040		145 147	TOSHIBA	008 013 042 047
CRAIG	108	MARANTZ	031 033 034 041		003 008 010 014		059 082 112 131
CURTIS MATHES	003 040 135		067 068	RICO	031 033 034 040	TOTEVISION	040 101
DAEWOO	031 033 041	MARTA	012 031 033 067	RUNCO	053 054 101	UNITECH	040
	005 007 010 064	MATSUI	069	SALORA	058	VECTOR RESEARCH	012
	065 108 110 111	MEI	101	SAMSUNG	148	VICTOR	048
DAYTRON	112 116 117 119	MEMOREX	027 030		014	VIDEO CONCEPTS	012 034 046
DBX	108		031 033		032 040 102 104	VIDEOSONIC	040
DYNATECH	012 023 039 043	MGA	003 010 014 031	SANSUI	105 107 109 112	WARDS	003 013 017 024
ELECTROHOME	034 053	MINOLTA	033 034 053 072	SANYO	113 115 120 122		031 033 034 040
EMERSON	059	MITSUBISHI	101 102 134 139		125		053 054 131
	006 017 025 027		045 046 059	SCOTT	022 043 048 135	YAMAHA	012 034 039 043
	029 031 034 035	MTC	013 020		003 007 010 014	ZENITH	034 048 056
	036 037 046 101	MULTITECH	013 020 045 046		102 134		058 072 080 101
	129 131 138 153	NEC	049 051 059 061		017 037 112 129		
FISHER	003 008 009 010	NORDMENDE	151	SEARS	131		
FUNAI	034	OPTONICA	034 040	010	003 00 009		
GE	031 033 063 072	PANASONIC	024 034		013 014 017 020		
	107 109 144 147		012 023 039 043		031 042 073 081		
GO VIDEO	132 136		048		101		
HARMAN KARDON	012 045	PENTAX	043	SHARP	031 054 149		
HITACHI	004 018 026 034	PHILCO	053 054	SHINTOM	024		
	043 063 137 150	PHILIPS	066 070 074 083	SONY	003 009 031 052		
INSTANTREPLAY	031 033		133 140 145		056 057 058 076		
JCL	031 033	PILOT	013 020 031 033		077 078 149		
JCPENNY	012 013 015 033	PIONEER	063	SOUNDESIGN	034		
	040 066 101		031 034 067	STS	013		
JENSEN	043		031 033 034 054	SYLVANIA	031 033 034 059		
JVC	012 031 033 043		067 071 101		067		
	048 050 055 060		101	SYMPHONIC	034		
	130 150 152		013 021 048	TANDY	010 034		

## CATV

Brand	Codes	Brand	Codes	Brand	Codes	Brand	Codes
ABC	003 004 039 042	GOLDEN CHANNEL	030		065 085 090	SL MARX	030
	046 052 053	HAMLIN	049 050 055	PIONEER	034 051 052 063	SPRUCER	047 078
AJIN	112	HITACHI	052 055		076	STARCOM	002 004 008 009
ANTRONIK	014	HOSPITALITY	070 077	POST NEWS WEEK	016	STARGATE	008 030
ARCHER	005 007 014 024	JERROLD	002 003 004 008	PRUCER	059	SYLVANIA	067
CABLE STAR	026		009 010 052 069	PTS	011 048 071 072	TADIRAN	030
CENTURION	092		074		073 074	TAEKWANG	110
CENTURY	007	LG (GOLDSTAR)	001 106 101 005	PULSAR	100	TAIHAN	105
CITIZEN	007	M-NET	037	RCA	047	TANDY	017
COLOUR VOICE	065 090	MACOM	033	REGAL	049 050	TEXSCAN	029 067
COMBANO	080 081	MAGNAVOX	010 012 064 079	REGENCY	057	TOCOM	039 040 056
COMTRONICS	019 030	MEMOREX	100	REMBRANT	025	TOSHIBA	100
DIAMOND	023	MOVIE TIME	028 032	RK	091	UNIKA	007 014 024
EAGLE	020 030 040	NSC	015 028 038 071	SAMSUNG	102 107 030 068	UNITED CABLE	004 053
EASTERN	057 062 066		073	SCIENTIFIC ATLANTA	003 011 041 042	UNIVERSAL	005 007 014 024
ELECTRICORD	032	OAK	016 031 037 053		043 045 046		026 027 032 035
GE	072	PANASONIC	044 047	SHERITECH	022	VIEWSTAR	012 015 018 086
GEMINI	008 022 025 054	PARAGON	100	SIGNAL	030		087 088 089
GI	052 074	PHILIPS	006 012 013 020	SIGNATURE	052	ZENITH	100 114 060 093

# Programming Codes

## STB

Brand	Codes	Brand	Codes	Brand	Codes	Brand	Codes
ALPHASTAR DSR	123	EUROPLUS	114	MEMOREX	057	STARCAST	041
AMPLICA	050	FUJITSU	017 021 022 027	NEXTWAVE	028 124 125	SUPER GUIDE	020 124 125
BIRDVIEW	051 126 129		133 134	NORSAT	069 070	TEECOM	023 026 075 087
BSR	053	GENERAL INSTRUMENT	003 004 016 029	PACE SKY SATELLITE	143		088 090 107 130
CAPETRONICS	053		031 059 101	PANASONIC	060 142		137
CHANNEL MASTER	013 014 015 018	HITACHI	139 140	PANSAT	121	TOSHIBA	002 127
	036 055	HOUSTON TRACKER	033 037 039 051	PERSONAL CABLE	117	UNIDEN	016 025 042 043
CHAPARRAL	008 009 012 077		057 104	PHILIPS	071		044 045 048 049
CITOH	054	HUGHES	068	PICO	105		078 079 080 086
CURTIS MATHES	050 145	HYTEK	053	PRESIDENT	019 102		101
DRAKE	005 006 007 010	JANIEL	060 147	PRIMESTAR	030 110 111	UNIDEN	135 136
	011 052 112 116	JERROLD	061	PROSAT	072	VIEWSTAR	115
	141	KATHREIN	108	RCA	066 106	WINEGARD	128 146
DX ANTENNA	024 046 056 076	LEGEND	057	REALISTIC	043 074	ZENITH	081 082 083 084
ECHOSTAR	038 040 057 058	LG	001	SAMSUNG	123		091 120
	093 094 095 096	LUTRON	132	SATELLITE SERVICE CO	028 035 047 057		
	097 098 099 100	LUXOR	062 144		085		
	122	MACOM	010 059 063 064	SCIENTIFIC ATLANTA	032 138		
ELECTRO HOME	089		065	SONY	103		

## Audio

Brand	Codes	Brand	Codes	Brand	Codes	Brand	Codes
AIWA	014 028 070 096	JVC	004 013 141	PHILIPS	026 112 143 253	TOSHIBA	147 218
	125 129 139 229	KEC	185 186 187	PIONEER	039 042 043 063		137
	230	KENWOOD	038 050 067 089		065 091 093 094	THE	061
AKAI	163		170 171 197 206	QUASAR	113	VICTOR	088 131
ANAM	003 014 017 023		215 222	RCA	080	WARDS	089
	059 106 189 216	KOHEL	030	RCX	092	YAMAHA	054 055 066 092
	217 235 236	NAD	045 046	REALISTIC	103 106		199
BURMECTER	252	LOTTE	014 016 036 098	SAMSUNG	124 145 146 182		
CARVER	086		100 172 173 174		193 194 195 203		
CLARION	199		179 180 181 183	SANSUI	011 135 138 144		
DAEWOO	027 053 060 084		201 202 208 213	SANYO	019 083 234		
	102 148 198 221		214 219 223 232	SCOTT	106 186		
DENON	015 075 130 143		238 240	SHARP	031 032 051 052		
FANTASIA	071	LXI	103		072 082 117 119		
FINEARTS	022	MAGNAVOX	111	SHERWOOD	005 006 158		
FISHER	089 099	MARANTZ	002 018 020 025	SONY	044 045 109 114		
LG(GOLDSTAR)	001 021 024 029		034 041 081 090		118 126 248 249		
	087 107 108 110	MCINTOSH	049	TAEKWANG	012 020 073 074		
	190 191 192 210	MCS	104		076 077 105 161		
	211 212 239	MEMOREX	107		162 163 164 165		
HAITAI	034 035 188 222	NAD	046		166 167 168 169		
HARMAN/KARDON	068	ONKYO	013 040 041 047		205 231 233 242		
INKEL	037 058 062 069		048 056 057 132	TEAC	010 085 106 136		
	078 079 095 121	OPTIMUS	133 140		185 187 237		
	122 149 150 151	PANASONIC	007 033 064 113	TECHNICS	101 113 128 134		
	152 153 154 155		142 220 241 251				
	157 158 159 160	PENNEY	104				
	189 207 222 224						
	225 226 227 243						
	247						

## DVD

Brand	Codes	Brand	Codes	Brand	Codes	Brand	Codes
APEX DIGITAL	022	MAGNAVOX	013	PHILIPS	013	SONY	007
DENON	020 014	MARANTZ	024	PIONEER	004 026	THOMPSON	005 006
GE	005 006	MITSUBISHI	002	PROCEED	021	TOSHIBA	019 008
HARMAN KARDON	027	NAD	023	PROSCAN	005 006	YAMAHA	009 018
JVC	012	ONKYO	008 017	RCA	005 006	ZENITH	010 016 025
LG	001 010 016 025	PANASONIC	003 009	SAMSUNG	011 015		

---

## Note

---

---

## Note

---



