





website <http://www.lgservice.com>

LG

# LG

## Ventilator

### ***OWNER'S MANUAL***

Prior to installation, this ventilation unit must be submitted for approval by the utility service which provides electricity (EN 61000-2, EN 61000-3 Norm).

#### **IMPORTANT**

- Please read this owner's manual carefully and thoroughly before installing and operating your product.
- Please retain this owner's manual for future reference after reading it thoroughly.

# TABLE OF CONTENTS

Safety Precautions .....	3
Prior to Operation .....	8
Introduction .....	9
Electrical Safety .....	10
Characteristics .....	11
Operating Instructions.....	12
Maintenance and Service .....	20
Check Item prior to notify a failure .....	23



## FOR YOUR RECORDS

Write the model and serial numbers here:

**Model #** \_\_\_\_\_

**Serial #** \_\_\_\_\_

You can find them on a label on the side of each unit.

**Dealer's Name** \_\_\_\_\_

**Date Purchased** \_\_\_\_\_

■ Staple your receipt to this page in the event you need it to prove date of purchase or for warranty issues.



## READ THIS MANUAL

Inside you will find many helpful hints on how to use and maintain your ventilator properly. Just a little preventive care on your part can save you a great deal of time and money over the life of your Ventilator.

You'll find many answers to common problems in the chart of troubleshooting tips. If you review our chart of

**Troubleshooting Tips** first, you may not need to call for service at all.



## PRECAUTION

- Contact the authorized service technician for repair or maintenance of this unit.
- Contact the installer for installation of this unit.
- The ventilator is not intended for use by young children or invalids without supervision.
- Young children should be supervised to ensure that they do not play with the ventilator.
- When the power cord is to be replaced, replacement work shall be performed by authorized personnel only using only genuine replacement parts.
- Installation work must be performed in accordance with the National Electric Code by qualified and authorized personnel only.

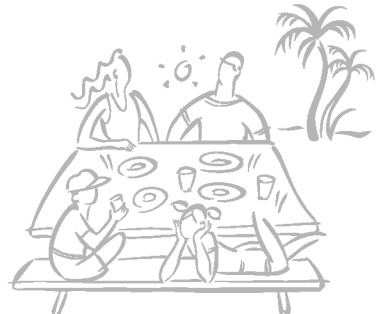

# Safety Precautions



To prevent injury to the user or other people and property damage, the following instructions must be followed.

■ Incorrect operation due to ignoring instruction will cause harm or damage. The seriousness is classified by the following indications.

**⚠ WARNING** This symbol indicates the possibility of death or serious injury.

**⚠ CAUTION** This symbol indicates the possibility of injury or damage.

■ Meanings of symbols used in this manual are as shown below.

	<b>Be sure not to do.</b>
	<b>Be sure to follow the instruction.</b>

## ⚠ WARNING

### ■ Installation

Do not use a defective or underrated circuit breaker. Use this appliance on a dedicated circuit.

- There is risk of fire or electric shock.

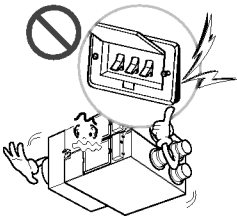

For electrical work, contact the dealer, seller, a qualified electrician, or an Authorized Service Center.

- Do not disassemble or repair the product. There is risk of fire or electric shock.



Always ground the product.

- There is risk of fire or electric shock.

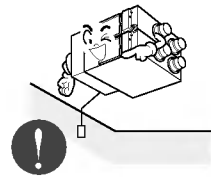

Install the panel and the cover of control box securely.

- There is risk of fire or electric shock.

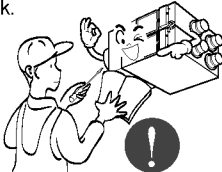

Always install a dedicated circuit and breaker.

- Improper wiring or installation may cause fire or electric shock

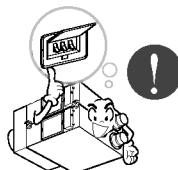

Use the correctly rated breaker or fuse.

- There is risk of fire or electric shock.

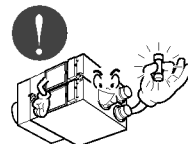

**Do not modify or extend the power cable.**

- There is risk of fire or electric shock.

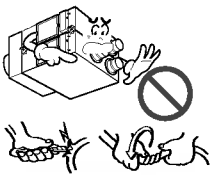

**Do not install, remove, or re-install the unit by yourself (customer).**

- There is risk of fire, electric shock, explosion, or injury.

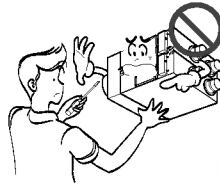

**Be cautious when unpacking and installing the product.**

- Sharp edges could cause injury. Be especially careful of the case edges and the fins on the condenser and evaporator.

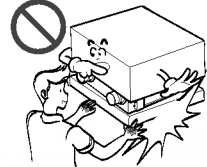

**For installation, always contact the dealer or an Authorized Service Center.**

- There is risk of fire, electric shock, explosion, or injury.

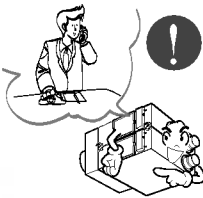

**Do not install the product on a defective installation stand.**

- It may cause injury, accident, or damage to the product.

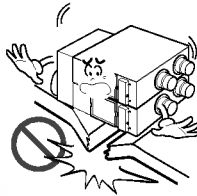

**Do not let the ventilator run for a long time when the humidity is very high and a door or a window is left open.**

- Moisture may condense and wet or damage furniture.



**For re-installation of the installed product, always contact the dealer or an Authorized Service Center.**

- There is risk of fire, electric shock, explosion or injury.

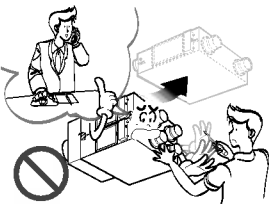

**Do not open the maintenance cover of the main body during operation.**

- Otherwise, it may cause electrical shock.

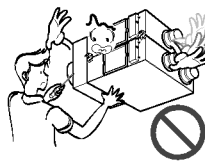

**Use the outdoor air suction hole with the net installed to ensure that birds could not come in.**

- Remove estrange things like the bird's nest. Otherwise, it may cause scarcity of indoor oxygen.

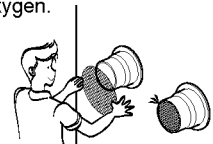

**Install the outdoor air suction hole at a place where exhaust air is not directly sucked.**

- Otherwise, it may cause pollute indoor air and so result in obstacle of health.

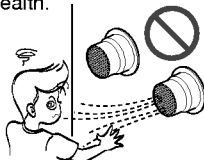

**Install the product a place that can support its weight.**

- Otherwise, it may cause accident due to falling of the product.

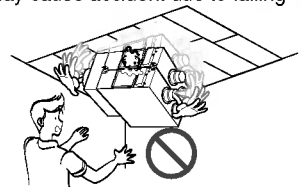

## ■ Operation

**Take care to ensure that power cable could not be pulled out or damaged during operation.**

- There is risk of fire or electric shock.

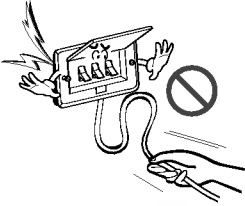

**Do not place anything on the power cable.**

- There is risk of fire or electric shock.

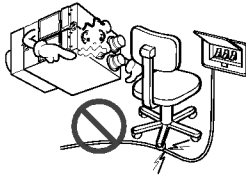

**Do not plug or unplug the power supply plug during operation.**

- There is risk of fire or electric shock.

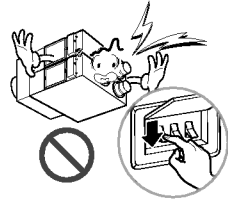

**Do not touch (operate) the product with wet hands.**

- There is risk of fire or electrical shock.

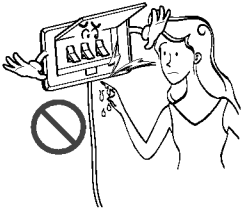

**Do not place a heater or other appliances near the power cable.**

- There is risk of fire and electric shock.

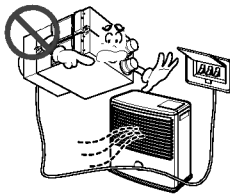

**Do not allow water to run into electric parts.**

- It may cause There is risk of fire, failure of the product, or electric shock.

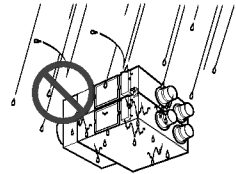

**Do not store or use flammable gas or combustibles near the product.**

- There is risk of fire or failure of product.



**When flammable gas leaks, turn off the gas and open a window for ventilation before turn the product on.**

- Do not use the telephone or turn switches on or off. There is risk of explosion or fire



**If strange sounds, or small or smoke comes from product. Turn the breaker off**

- There is risk of electric shock or fire.



**Stop operation and close the window in storm or hurricane. If possible, remove the product from the window before the hurricane arrives.**

- There is risk of property damage, failure of product, or electric shock.

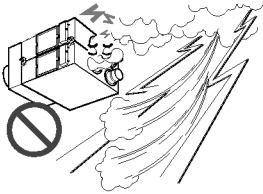

**When the product is soaked (flooded or submerged), contact an Authorized Service Center.**

- There is risk of fire or electric shock.



**Be cautious that water could not enter the product.**

- There is risk of fire, electric shock, or product damage.

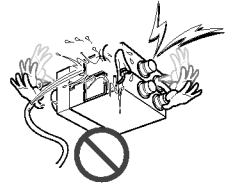

**Turn the breaker off when cleaning or maintaining the product.**

- There is risk of electric shock.

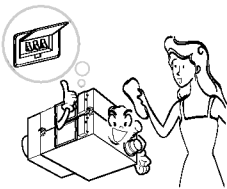

**When the product is not used for a long time, disconnect the power supply plug or turn off the breaker.**

- There is risk of product damage or failure, or unintended operation.

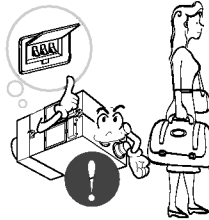

**Avoid fire equipment**

- There is risk of fire.

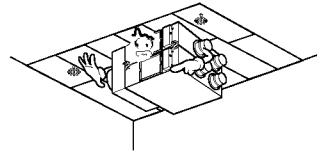

**Don't touch a dedicated circuit or breaker with wet hands.**

- There is risk of electric shock.

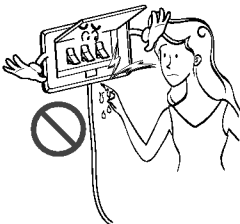

**Use a firm stool or ladder when cleaning or maintaining the product.**

- Be careful and avoid personal injury.

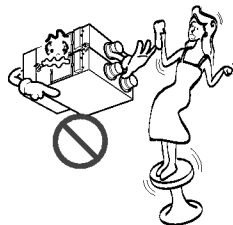

# CAUTION

## Installation

Use two or more people to lift and transport the product.

- Avoid personal injury.

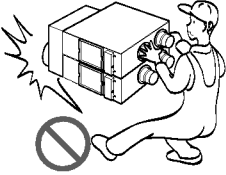

Do not install the product where it will be exposed to sea wind (salt spray) directly.

- It may cause corrosion on the product. Corrosion, particularly on the condenser and evaporator fins, could cause product malfunction or inefficient operation.

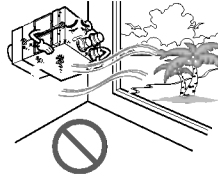

## Operation

Do not expose the skin directly to cool air for long periods of time. (Don't sit in the draft.)

- This could harm your health.

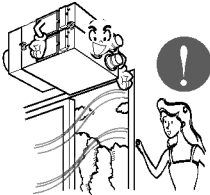

Do not use the product for special purposes, such as preserving foods, works of art, etc. It is a consumer ventilator, not a precision refrigeration system.

- There is risk of damage or loss of property.

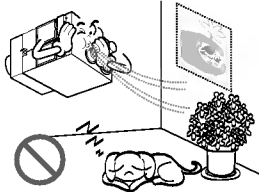

Use a soft cloth to clean. Do not use harsh detergents, solvents, etc.

- There is risk of fire, electric shock, or damage to the plastic parts of the product.

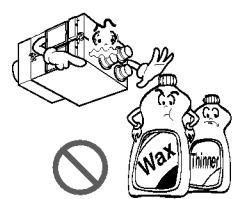

Do not step on or put anything on the product. (outdoor units)

- There is risk of personal injury and failure of product.

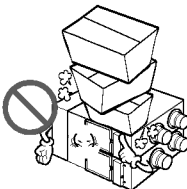

Use a firm stool or ladder when cleaning or maintaining the product.

- Be careful and avoid personal injury.

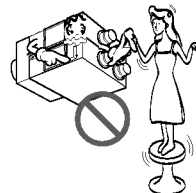

## Prior to Operation

### Preparing for operation

1. Contact an installation specialist for installation.
2. Plug in the power plug properly.
3. Use a dedicated circuit.
4. Do not use an extension cord.
5. Do not start/stop operation by plugging/unplugging the power cord.
6. If the cord/plug is damaged, replace it with only an authorized replacement part.

### Usage

1. Being exposed to direct airflow for an extended period of time could be hazardous to your health. Do not expose occupants, pets, or plants to direct airflow for extended periods of time.
2. Due to the possibility of oxygen deficiency, ventilate the room when used together with stoves or other heating devices.
3. Do not use this ventilator for non-specified special purposes (e.g. preserving precision devices, food, pets, plants, and art objects). Such usage could damage the items.

### Cleaning and maintenance

1. Do not touch the metal parts of the unit when removing the filter. Injuries can occur when handling sharp metal edges.
2. Do not use water to clean inside the ventilator. Exposure to water can destroy the insulation, leading to possible electric shock.
3. When cleaning the unit, first make sure that the power and breaker are turned off. The fan rotates at a very high speed during operation. There is a possibility of injury if the unit's power is accidentally triggered on while cleaning inner parts of the unit.

### Service

For repair and maintenance, contact your authorized service dealer.

# Introduction

## Symbols used in this Manual



This symbol alerts you to the risk of electric shock.



This symbol alerts you to hazards that could cause harm to the ventilator.

**NOTICE**

This symbol indicates special notes.

## Features



**WARNING:** This appliance should be installed in accordance with national wiring regulations. This guide acts as a guide to help to explain product features.

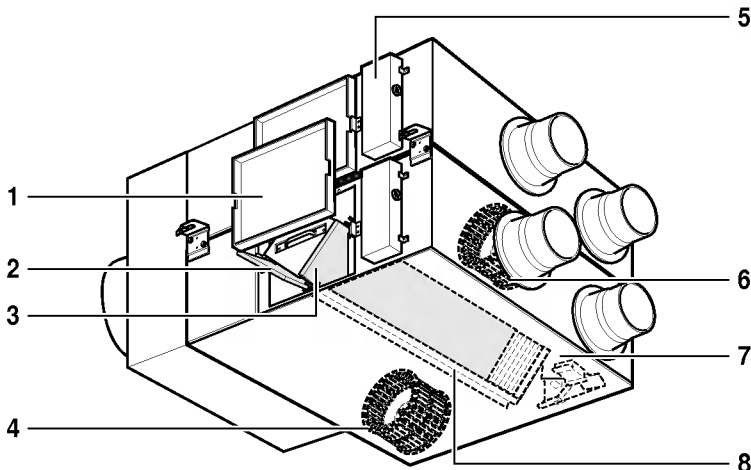

### 1. Maintenance cover

### 2. Air Filter

Prevents clogging of the Total heat exchanger due to dust.

### 3. Total Heat Exchanger

Exchanges temperature and moisture between air supply air and exhaust air.

### 4. Blower for Exhausting

A blower for draining polluted air outside.

### 5. Control Box

### 6. Blower for Air Supply

A blower for sucking outside air.

### 7. Damper Plate

Converts the ventilation via Total heat exchange to the normal ventilation.

### 8. Holder for Total Heat Exchanger

Used for installation guide of the Total heat guide.

\* The figure of Total heat Exchanger can be different by the Product Model.

# Electrical Safety



**WARNING: This appliance must be properly grounded.**

To minimize the risk of electric shock, you must always plug into a grounded outlet.

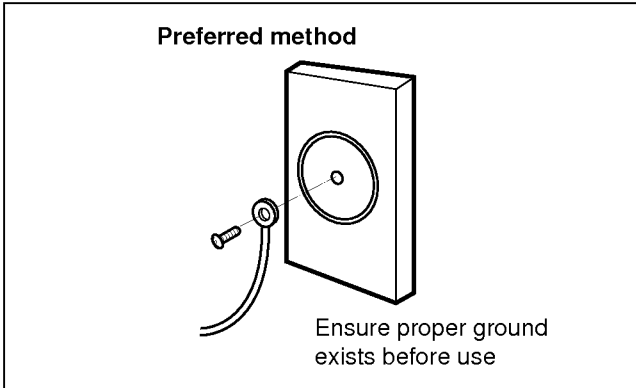

**WARNING: Do not cut or remove the grounding prong from the power wire.**



**WARNING: Attaching the adapter ground terminal to the wall receptacle cover screw does not ground the appliance unless the cover screw is metal and not insulated, and the wall receptacle is grounded through the house wiring.**



**WARNING: If you have any doubt whether the ventilator is properly grounded, have the wall receptacle and circuit checked by a qualified electrician.**

# Characteristics

## Ventilation via Total Heat Exchanger

### Exhausts indoor air via the Total heat exchanger outdoor.

- The outdoor air heat exchanged is supplied to indoor. Operate the ventilator in the [Ventilation via Total heat exchanger] in summer/winter when cool/heat operation is done.

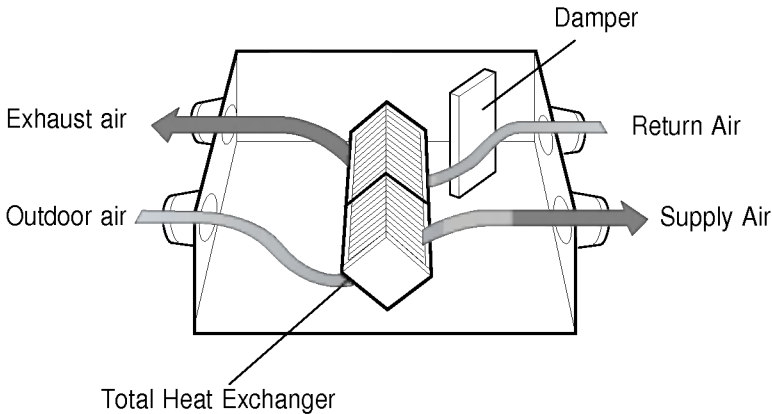

## Normal Ventilation

### Exhausts the polluted indoor-air directly without via the Total heat exchanger.

- Operate the ventilator in the [Normal Ventilation] in spring/autumn when the Total heat exchanger is not required.

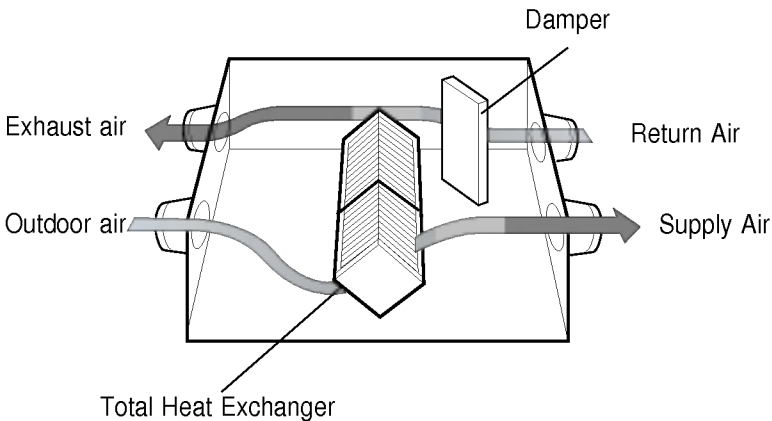

**CAUTION:** In case of high outdoor pollution degree like yellow sand please pause the ventilator.

# Operating Instructions

## LCD Remote Controller (Ventilation System Remote Controller AZLRAD0)

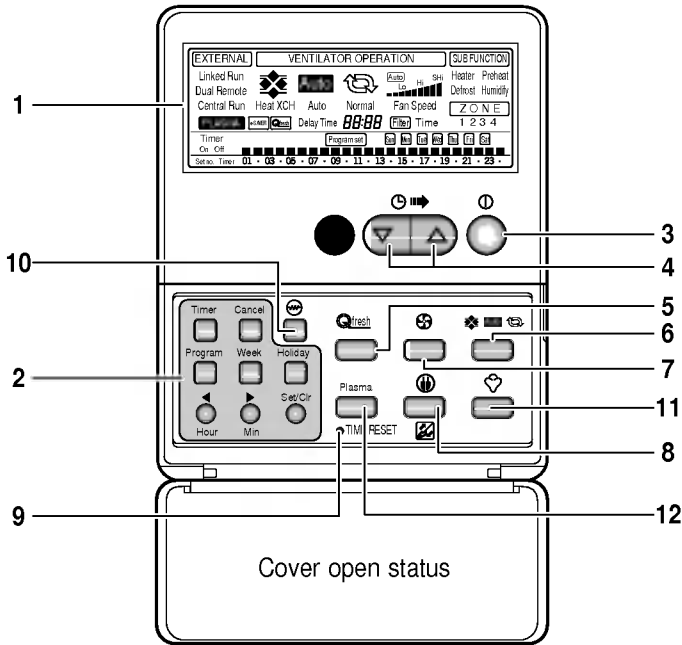

• Every function is not available by a kind of models.

- |  |   |
|--|---|
| <p>1. Display Window</p> <p>2. Execute/Cancel of Time Reservation, Weekly Reservation/Week Day Select/Holiday Select Button</p> <p>3. Operation/Stop Button</p> <p>4. Delay Time Button</p> <p>5. Rapid Ventilation Button</p> <p>6. Ventilation Mode Button</p> | <p>7. Air volume Select Button</p> <p>8. Power Saving/Filter Cleaning Button</p> <p>9. Time Reset Button</p> <p>10. Heater Button</p> <p>11. Humidification Button</p> <p>12. Plasma Button</p> |
|--|---|

## Method to operate and select air volume

- Every function is not available by a kind of models.

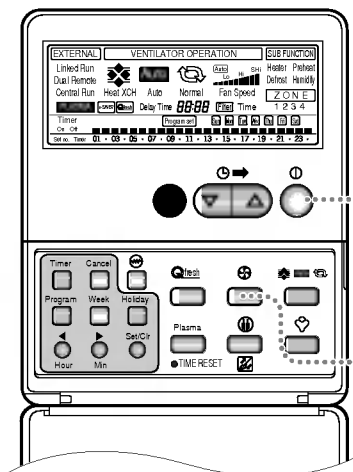

### Operation selection

Press the Operation/Stop button.

- The ventilation system operates if you press the Operation/Stop button of the main power.
- If you press it again, the ventilation system stops.



### Blowing operation

Select the desired air volume by pressing the Air volume Select button.

- You can select the air volume in the order of **Low** → **High** → **Super High** → **Auto** whenever you press the Air volume Select button.
- The initially set Air volume in operation is 'High'.



## Ventilation Mode Setting

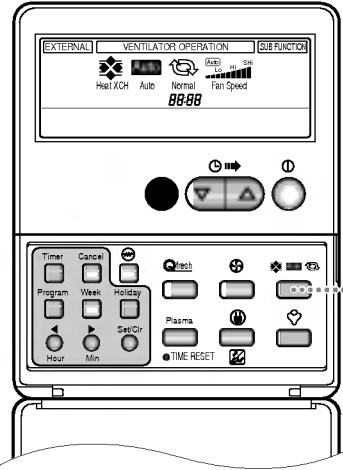

- Every function is not available by a kind of models.

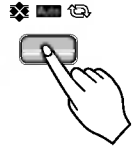

Select the desired operation mode by pressing the Ventilation Mode button.

- You can select the Operation Mode in the order of **Total Heat** → **Auto** → **Normal** whenever you press the Ventilation Mode button.



Select Mode	Display Window	Functions
1. The Ventilation via Total Heat Exchange mode	 Heat XCH	Mode that supply/exhaust air is ventilated via the Total heat exchanger. Appropriate for use in summer/winter when temperature difference between indoor/outdoor air is severe (See 'Characteristics').
2. The Auto mode	 Auto	Automatically operates in the optimum ventilation mode by measuring the indoor/outdoor air of the ventilation system. ※ Searches the optimum status by operation mode or setting temperature of ventilator as well as by indoor/outdoor temperature of the ventilation system in link of Multi-V. (Only for some models)
3. The Normal Ventilation	 Normal	Mode that exhaust air is ventilated without the Total heat exchanger. Appropriate for use in spring/autumn or in case of the high indoor pollution degree(See 'Characteristics').

## Rapid Ventilation/Power Saving Ventilation

- Every function is not available by a kind of models.

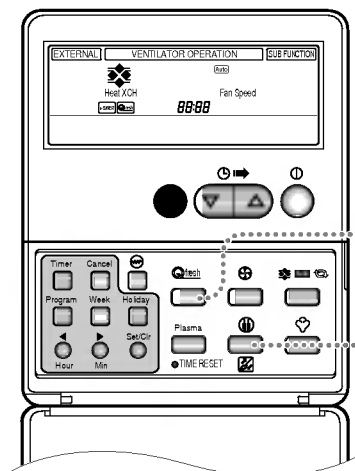

### Rapid Ventilation

Press the **[Rapid Ventilation]** button.

- Operation for preventing the polluted indoor air or moisture from extending to other rooms.
  - Supply Air fan : Low.
  - Exhaust fan : Super High
- [Rapid] is indicated on the remote controller and the air volume is indicated "Auto".
- \* It is better to use Rapid Ventilation function when the indoor pollution degree is high.
- Adjustable to Inflow Prevention operation in the initial installation Inflow prevention operation means function to improve pleasantness by preventing inflow of outdoor smell or moisture by more increasing Supply Air volume than Exhaust air volume.
  - Supply Air fan : Super high
  - Exhaust fan : Low

Refresh

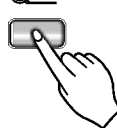

For more information, contact the professional installation agent.

### Power Saving Ventilation

Press the **[e-Saver]** button.

- Operation to achieve saving of power by searching for the best efficient operation point.
- Promote discharge of CO<sub>2</sub> by more Exhaust Air volume than supply Air volume.
- **[e-Saver]** is indicated on the remote controller and the air volume indicates 'Auto'.



## Optional Function

- Every function is not available by a kind of models.

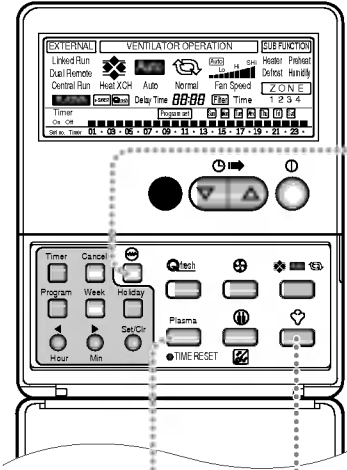

### Heating Operation

- In case of low outdoor temperature, this function enables ventilator to supply more refreshing air by raising total enthalpy efficiency.



### 'Plasma' Operation

- It makes ventilator supply air quality more better, fresher.
- Remote controller displays 'Plasma'.



### 'Humidification' Operation

- In case of dry indoor air, it makes product maintain uniform humidity by working humidifier.
- Remote controller displays 'Humidify'.
- Only when the indoor temperature is low, this function is available.

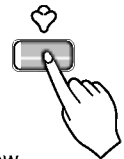

\* Every function is not available by a kind of models.

## Additional function

### Setting of current time

- You can easily set the current time.
  - Every function is not available by a kind of models.

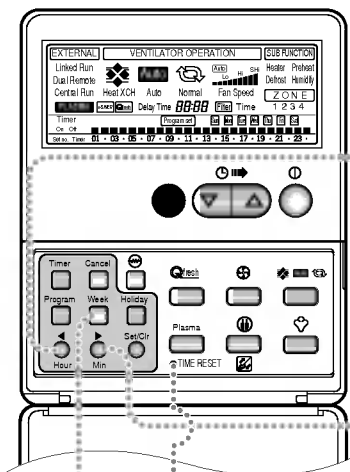

- Press the [Hour] button on the adjustment part of the remote controller. Figures change 00 through 23 whenever you press the button. Adjust the current time.



- Press the [Minute] button on the adjustment part of the remote controller. Figures change 00 through 59 whenever you press the button. Adjust the current time.

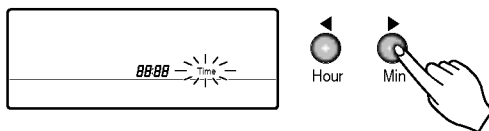

- Press the [Week Day Select] on the adjustment part of the remote controller. Weekdays change from Sunday through Saturday whenever you press the button. Adjust the current day.



- Press the [Reset] button on the adjustment part of the remote controller.

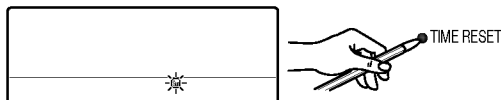

\*If you press [RESET] button once, current time is set. And if you press it once again, current set time cancelled.

## Weekly Reservation Setup

No reservation operation is done with the current time not setting up.

**Example)** To operate the ventilator at 06:00 ~ 08:00 and 13:00 ~ 22:00 on Monday

- Every function is not available by a kind of models.

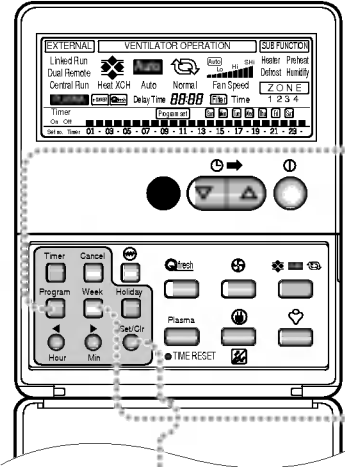

**1** Press the **[Program]** button on the adjustment part of the remote controller.

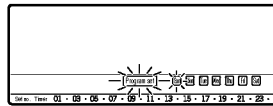

Program



**2** Press the **[Week]** button on the adjustment part of the remote controller.

- Adjust Monday

The day is changed when ever you press the button.

Week



**3** Set up the desired time by pressing the **[Set/Clr]** button after movement with the **[Hour, Min]** button. Setup the time until the desire time is setup.



Hour

Min

Set/Clr



**4** Setting display

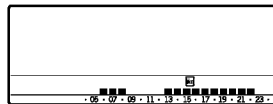

- If holiday is designated, input of the [Set/Clr] button is not done.
- Setup will be done automatically after 5 seconds.

## Holiday Setup

**Example)** In the case that it is holiday on Tuesday.

- Automatically turn off when the reservation day set up.
- Every function is not available by a kind of models.

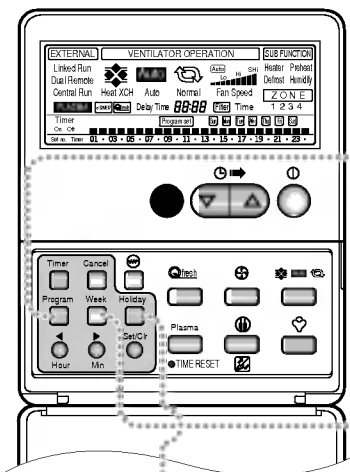

**1** Press the **[Program]** button on the adjustment part of the remote controller.

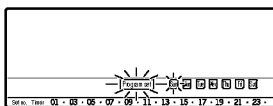

**2** Press the **[Week]** button on the adjustment part of the remote controller.

- Adjust Tuesday.

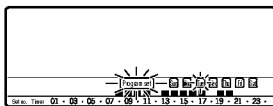

**3** Press the **[Holiday]** button on the adjustment part of the remote controller.

**[Tue]** is indicated on the adjustment part of the remote controller.

The outside square means a holiday.

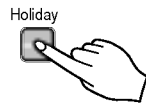
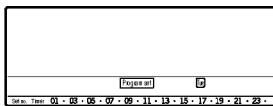

- Setup will be done automatically after 5 seconds.

## On/Off Reservation

### 'On' Reservation

- Automatically turn on when the reservation time set up.

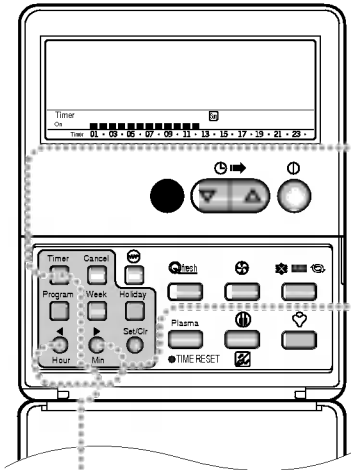

- Every function is not available by a kind of models.

**1** Press **[Timer]** button on the adjustment part of the remote controller.



**2** Set up desired time with **[Hour, Min]** button.

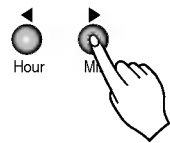

**3** Press **[Timer]** button once more or press the **Cancel** button in order to cancel reservation.

- You can reserve only when the product is 'off' and it automatically operates at set up time. During operation, the ventilator operates in the previous status memorized in the remote controller.



- Setup will be done automatically after 5 seconds.

### 'Off' Reservation

- Automatically turns off when the reservation time set up.

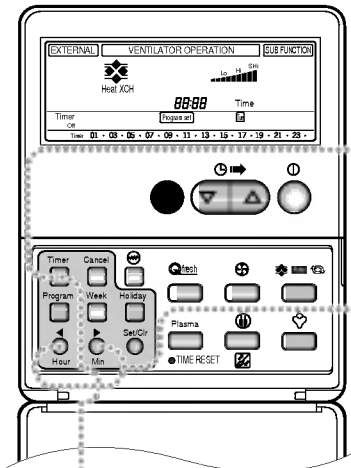

- Every function is not available by a kind of models.

**1** Press **[Timer]** button on the adjustment part of the remote control.

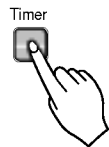

**2** Set up desired time with **[Hour, Min]** button.

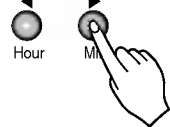

**3** Press **[Timer]** button once more or press the **Cancel** button in order to cancel reservation.

- You can reserve only when the product is during operation and operation automatically stops at set up time.

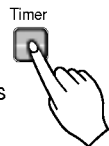

- Setup will be done automatically after 5 seconds.

# Maintenance and Service

## Handling and Cleaning

To prevent function of the ventilator deteriorating, clean dust adhered to the air filter and total heat exchanger regularly.

### Cleaning Cycle

- Air filter: More than once every 6 months.
- Total heat exchanger: More than once every 2 years (Cleaning cycle may increase according to pollution degree.)

### Method to take each part out

#### 1. Remove the maintenance cover.

Put the hands inside of the ceiling from the maintenance cover, and pull the maintenance cover up.  
(Loosen the hinge and detach the maintenance cover.)

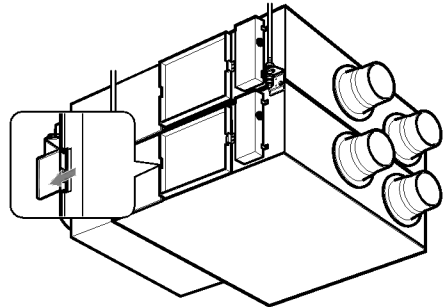

#### 2. Take the air filter out.

Take the air filter with each contained to the left/right downside of the Total heat exchanger.

※ If it adheres to the ceiling in reverse, it is equal to the left/right topside of the Total heat exchanger.



**CAUTION:** Take care to ensure that you could not damage when taking the air filter out since there is a sharp part on it.

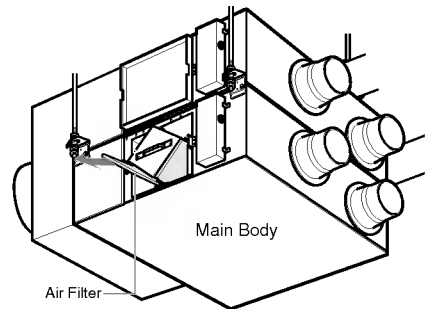

#### 3. Take the Total heat exchanger out.

Catch the handle and then take the Total heat exchanger out from the main body. (2 units)



**WARNING:** Turn the breaker off when cleaning the product.



**CAUTION:** Gloves should be worn when doing the maintenance work.

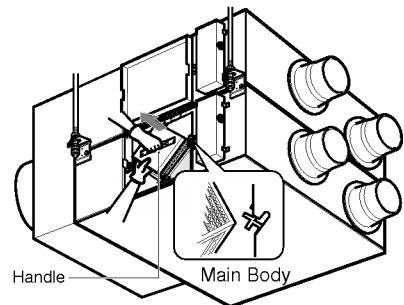

## Method to Clean and Replace Each Part

### 1. Cleaning of Air Filter

Clean once every 6 months.

- Clean dirt from the air filter using a vacuum cleaner or washing with water.  
(if dirt is conspicuous, wash with a neutral detergent in lukewarm water)
- After washing with water, dry well in the shade.  
(Do not expose the air filter to direct sunlight or heat from a fire when drying it)
- If the air filter is damaged, purchase it from the service center or professional agent.

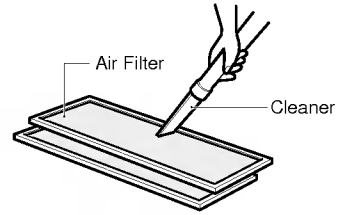

### 2. Cleaning of Total Heat Exchanger

Suck dusts adhered to the surface of the Total heat exchanger with a cleaner.

- Use the cleaner that attached to brush at its nozzle, and use a soft brush.
- Do not use a hard nozzle on the cleaner.  
(Otherwise, surface of the Total heat exchanger may be damaged.)
- Never wash the Total heat exchanger with water.
- Replacement expenses are for a consideration after 2 years from the purchasing date.
- Expenses are for a consideration when you will contact the service center even within 2 years from the purchasing date.
- For service, always contact the dealer or an Authorized Service Center.

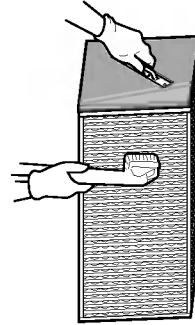

Air Filter



Total Heat Exchanger

## Assembly and Check after Maintenance

### 1. Assembly of Total heat exchanger

Securely put the corner parts (6 parts) of the Total heat exchanger into the holder for assembly and slide them into the inside of the main body.

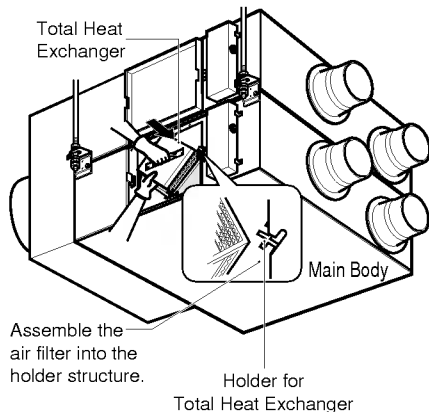

### 2. Assembly of air filter

Assemble the air filter into the holder structure of the Total heat exchanger.

- Take care to ensure that surface of the Total heat exchanger could not be damaged.
- Dusts adhered to the Total heat exchanger may cause deterioration of Air volume.

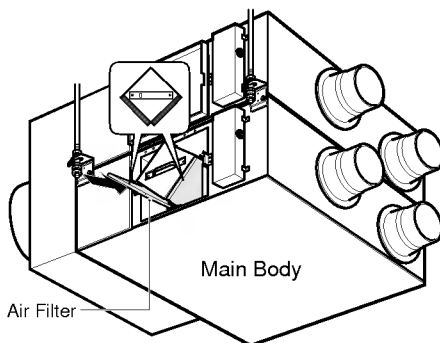

### 3. Assembly of maintenance cover

Fix the cover to the right hinge and fix it to the left side. (A nameplate is adhered toward the reading direction).



**WARNING:** Turn the breaker off when cleaning the product.



**CAUTION:** Gloves should be worn when doing the maintenance work.

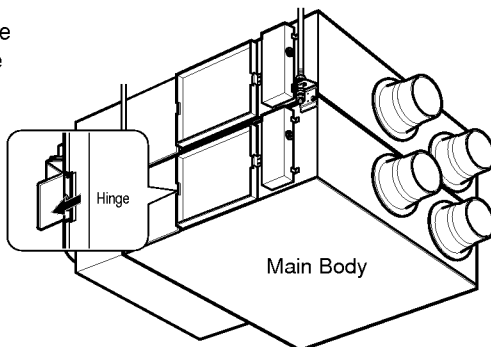

## Check Item prior to notify a failure

Symptom	Check Item	Counter-measure
The Product doesn't work	Is power not supplied?	Supply Power
	Is Air Filter, Total heat exchanger clogged severely?	Follow cleaning and changing method.
The Product doesn't work through you press the 'ON' switch	Is the Indoor temperature less than -15 °C or more than 45 °C?	It's standby mode for protecting Total Heat Exchanger.
Through you change the Indoor Air Volume, the operation mode doesn't change And it changes to 'Auto' or Low'.	Is the Indoor temperature less than 8 °C or more than 40 °C?	It's operation mode to protect Total Heat Exchanger.



