



CAR CD/MP3/WMA Receiver

OWNER'S MANUAL

MODEL : LAC-M8600R

Please read this instruction booklet carefully and completely before connecting, operating or adjusting this product.



Safety note

	CAUTION RISK OF ELECTRIC SHOCK DO NOT OPEN	
<p>TO REDUCE THE RISK OF ELECTRIC SHOCK DO NOT SPLIT COVER(OR BACK) NO USER SERVICEABLE PARTS INSIDE. REFER SERVICING TO QUALIFIED SERVICE PERSONNEL.</p>		



The lightning flash with the arrowhead symbol within an equilateral triangle is intended to alert the user about the presence of uninsulated dangerous voltage within the product's enclosure that may be of sufficient magnitude to constitute a risk of electric shock to persons.



The exclamation point within an equilateral triangle is intended to alert the user to the presence of important operating and maintenance (servicing) instructions in the literature accompanying the appliance.



Always operate the vehicle in a safe manner. Do not become distracted by the vehicle while driving, and always be fully aware of all driving conditions. Do not change settings, or any functions. Pull over in a safe and legal manner before attempting such operations.



Do not use for many hours at extremely low or high temperature. (-10~60°C)



To reduce the risk of electric shock, do not remove the cover or back of this product. There are no user-serviceable parts inside. Refer servicing to qualified service personnel.



To reduce the risk of fire or electric shock, do not expose this product to dripping or splashing water, rain, or moisture.



The temperature of units outside can be extremely high, please use the unit after proper installation in your vehicle.

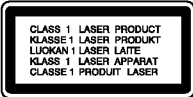

CAUTION : VISIBLE AND INVISIBLE LASER RADIATION WHEN OPEN AND INTERLOCKS DEFEATED.

CAUTION : This product uses a Laser System.
To ensure proper use of this product, please read this owner's manual carefully and retain it for future reference. Should the unit require maintenance, contact an authorized service center.
Performing controls, adjustments, or carrying out procedures other than those specified herein may result in hazardous radiation exposure.
To prevent direct exposure to the laser beam, do not try to open the enclosure. Visible laser radiation when open. **DO NOT STARE INTO BEAM.**

Safety note



- A defective or soiled disc inserted into the unit can cause the sound to drop during playback.
- Handle the disc by holding its inner and outer edges.
- Do not touch the surface of the unlabeled side of the disc.



Do not stick paper or tape, etc. on the surface.



Do not expose the disc to direct sunlight or excessive heat.



This unit cannot use 8 cm discs (use 12cm discs only).
If you insert an 8cm disc by mistake, press the EJECT button for a long time with the front panel opened.

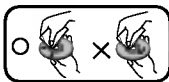

- Clean the disc before playback. Wipe the disc from the center outward with a cleaning cloth.
- Never use solvents such as benzine or alcohol to clean the disc.

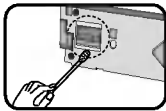

Periodically wipe the contacts on the back of the front panel with a cotton swab moistened with alcohol.

Bluetooth

Bluetooth® wireless technology is a system which allows radio contact between electronic devices within a max. range of 10 meters. Connecting individual devices with Bluetooth® wireless technology does not incur any charges. A mobile phone with Bluetooth® wireless technology can be operated via the Cascade if the connection was made via Bluetooth® wireless technology.

Table of contents

Safety notes	2-3
Table of contents	4
Before use	5
Front panel	6
Remote control	7
Installation	8
Connection diagram	9
Connection	10
Basic operation	11-14
Bluetooth operation	15-19
Radio operation	20
RDS operation	21-22
CD/MP3/WMA operation	23-24
Troubleshooting	25
Specifications	26



Disposal of your old appliance

1. When this crossed-out wheeled bin symbol is attached to a product, it means the product is covered by the European Directive 2002/96/EC.
2. All electrical and electronic products should be disposed of separately from the municipal waste stream via designated collection facilities appointed by the government or the local authorities.
3. The correct disposal of your old appliance will help prevent potential negative consequences for the environment and human health.
4. For more detailed information about disposal of your old appliance, please contact your city office, waste disposal service or the shop where you purchased the product.



This product is manufactured to comply with the radio interference requirements of EEC DIRECTIVE 89/336/EEC, 93/68/EEC and 73/23/EEC.

Before use

Detachable front panel

The front panel can be detached to prevent theft.

- 1 Press  (RELEASE) to open the front panel.
- 2 Hold the left part the front panel.
- 3 Pull the front panel.
- 4 Place the front panel in the supplied protective case.

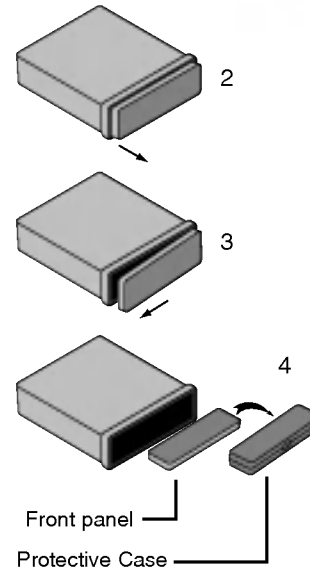

Attachable front panel

The front panel can be detached to prevent theft.

- 1 Align the right side of the panel with the stopper.
- 2 Push the left side of panel into the unit until it clicks.

Notes

- When detaching or attaching the front panel, do not press the display or control buttons.
- The control buttons may not work properly if the front panel is not attached properly. If this occurs, gently press the front panel.
- Do not leave the front panel in any area exposed to high temperatures or direct sunlight.
- Do not drop the front panel or otherwise subject it to a strong impact.
- Do not allow such volatile agents as benzine, thinner, or insecticides to come into contact with the surface of the front panel.
- Do not try to disassemble the front panel.

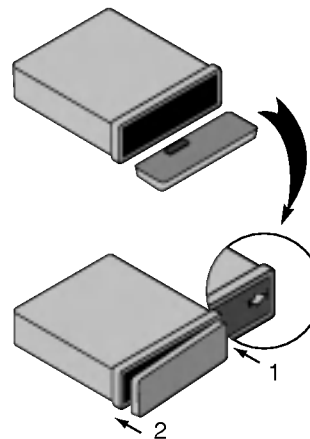

Front Panel

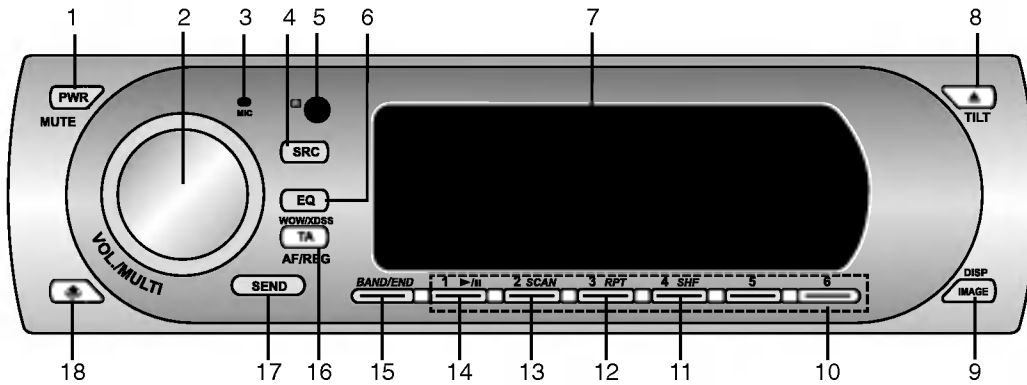

- | | |
|---|---|
| <ul style="list-style-type: none"> 1 POWER [PWR / MUTE] 2 • VOLUME [VOL./MULTI] • SELECT • MENU • SKIP ◀◀ ▶▶ / SEARCH ◀◀ ▶▶ • SEEK/ TUNE • PROGRAM TYPE [PTY] • MP3 TRACK +10/-10 MP3 WMA • FOLDER UP/DOWN MP3 WMA • AUTO STORE [AS] • PRESET SCAN [PS] 3 MICROPHONE [MIC] 4 SOURCE [SRC] 5 REMOTE SENSOR 6 EQUALIZER [EQ / WOW / XDSS] 7 DISPLAY WINDOW 8 • EJECT ▲ • [TILT] | <ul style="list-style-type: none"> 9 • [IMAGE] • DISPLAY [DISP] 10 PRESET STATION [1-6] 11 SHUFFLE [SHF] 12 REPEAT [RPT] 13 INTRO SCAN [SCAN] 14 PLAY/PAUSE ▶/ 15 [BAND/END] 16 • TRAFFIC ANNOUNCEMENT [TA] • ALTERNATIVE FREQUENCIES [AF] • REGIONAL [REG] 17 [SEND] 18 RELEASE ▲ |
|---|---|

Remote control

- 1 POWER [PWR] / MUTE
- 2 SELECTION [MENU/SEL]
- 3 SOURCE [SRC]
- 4 PLAY / PAUSE
- 5 INTRO SCAN [SCAN]
- 6 SHUFFLE [SHF]
- 7 • MP3 TRACK +10
• FOLDER UP
- 8 • CD SKIP / SEARCH
• SEEK / TUNE
- 9 [BAND]
- 10 VOLUME UP / DOWN
- 11 NUMBER [#]
- 12 REPEAT [RPT]
- 13 NUMBER [0-9]
- 14 • CD SKIP / SEARCH
• SEEK / TUNE
- 15 DISPLAY [DISP.]
- 16 • MP3 TRACK -10
• FOLDER DOWN

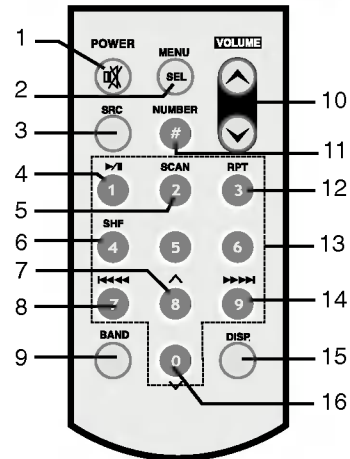

Battery installation

- 1 Remove the battery holder with a pencil or ball point pen.
- 2 Install the battery on the battery holder.
- 3 Install the battery holder back into its original position.

Notes

- Use only one CR2025 (3V) lithium battery.
- Remove the battery if the remote control is not used for a long period of time.
- Do not leave the product in a hot or humid place.
- Do not handle the battery using metallic tools.
- Do not store the battery together with metallic materials.
- In the event of battery leakage, wipe the remote control completely clean and install a new battery.

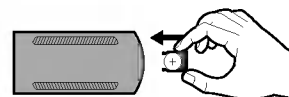
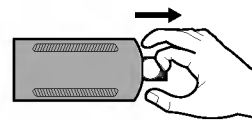
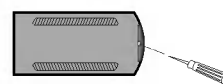

Installation

Basic Installation

Before installing, make sure that the ignition switch is set to OFF and remove the terminal of the car battery to avoid short-circuiting.

- 1 Remove the existing receiver unit.
- 2 Make the necessary connections.
- 3 Install the installation sleeve.
- 4 Install the unit into the installation sleeve.

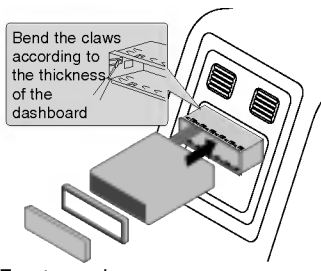

Front panel

Removing the existing receiver unit

If there is already an installation sleeve for the receiver unit in the dashboard, it must be removed.

- 1 Remove the rear support from the unit.
- 2 Remove the front panel and trim ring from the unit.
- 3 Insert the lever **A** into the hole on one side of the unit. Perform the same operation on the other side and pull the unit out from the mounting sleeve.

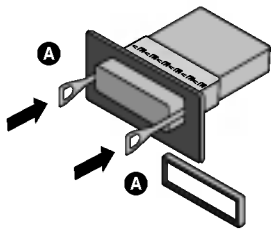

ISO-DIN Installation

- 1 Slide the unit into the ISO-DIN frame.
- 2 Install screws removed from the old unit.
- 3 Slide the unit and frame into the dash opening.
- 4 Install the dash panel or adapter plate.
- 5 Install the trim ring to in unit.
- 6 Install the faceplate by fitting the right edge into position then pushing the left edge closed.

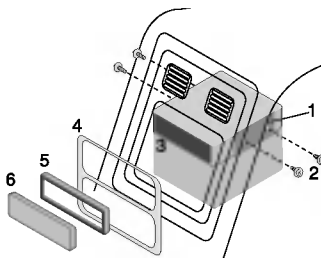

Front panel

Connection diagram

Before connecting, make sure that the ignition switch is set to OFF, and remove the battery ⊖ terminal to avoid short circuits.

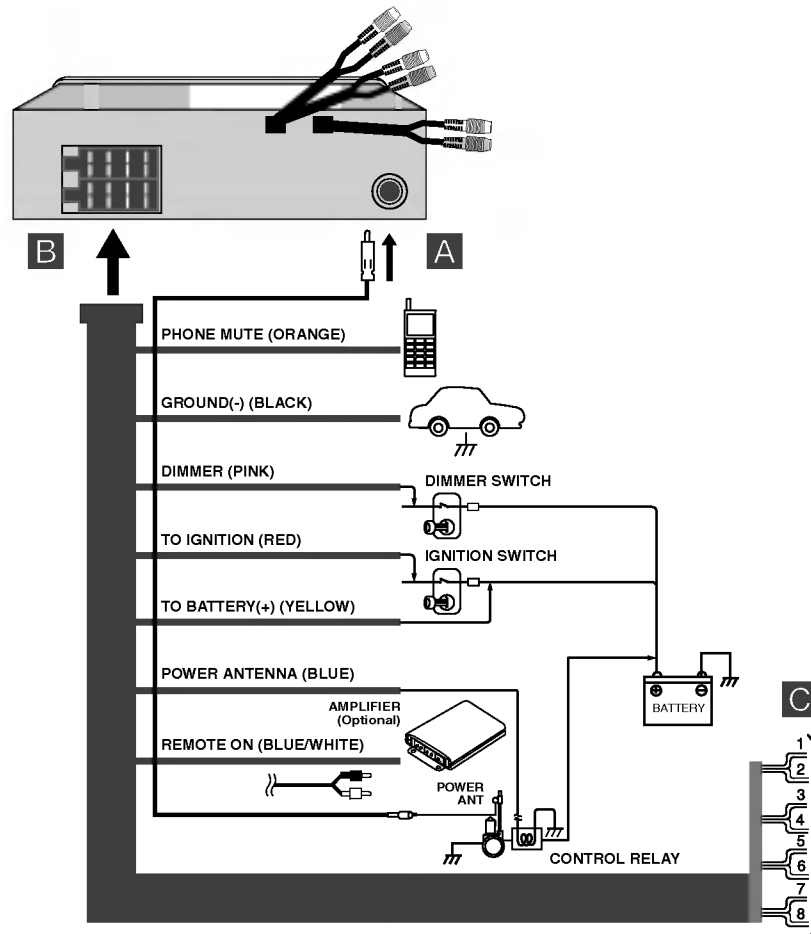

1. WHITE FL+
2. WHITE/BLACK STRIPE FL-
3. GRAY FR+
4. GRAY/ BLACK STRIPE FR-
5. GREEN RL+
6. GREEN/ BLACK STRIPE RL-
7. VIOLET RR+
8. VIOLET/ BLACK STRIPE RR-

Connection

C Speaker Connections

A From antenna

B To the wiring of the vehicle colors of leads.

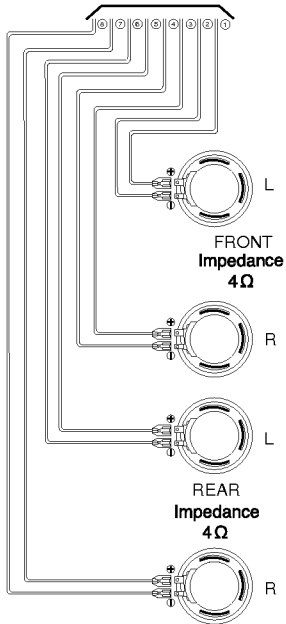

- **BLACK** : This lead is for the ground connection.
- **ORANGE** : This lead is for the phone line connection.
- **PINK** : This lead is for the dimmer line connection.
- **RED** : This lead is for connection to the power supply terminal when the ignition switch is set to ACC.
- **YELLOW** : This lead is for connection to the battery (back-up) terminal from which power is always supplied.
- **BLUE** : This lead is for the power antenna connection.
- **BLUE/WHITE** : This lead is for the remote amplifier on connection.

Connecting to Auxiliary Equipment (Optional)

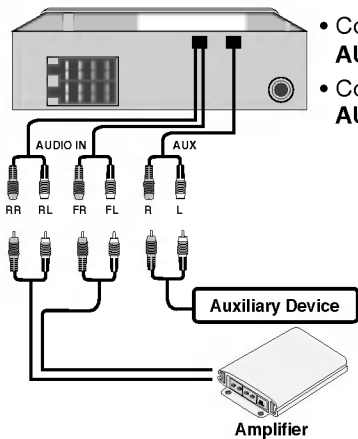

- Connect the **AUDIO INPUT** connector of this unit to the **AUDIO OUTPUT** connector of the Amplifier.
- Connect the **AUX INPUT** connector of this unit to the **AUX OUTPUT** connector of the Auxiliary Equipment.

Basic operation

Turning the unit on

Press **PWR/MUTE** (**POWER/MUTE**  on the remote control) or any other button.

Note

When you insert the CD in the CD slot, the unit turns on.

Turning the unit off

Press and hold the **PWR/MUTE** (**POWER/MUTE**  on the remote control) for more than 1.2 seconds.

Insert a disc

- 1 Press **▲/TILT** to open the front panel.
- 2 The disc is drawn in and playback starts automatically.

Eject a disc

Press **▲/TILT** to open the front panel. The disc automatically ejects from the loading slot. When the disc is ejected by pressing **▲/TILT** during playback, it will be loaded automatically after 10 seconds unless you pull out the disc from the unit.

Selecting a source

Press **SRC** repeatedly to select a source.

The indicator lights up in the following order. TUNER → CD → AUX → TUNER...

Adjusting the volume

Rotate **VOL./MULTI** (Press **VOLUME** **▲** **▼** on the remote control) to adjust the sound level.

Note

When you turn the unit off, the current volume level is automatically memorized. Whenever you turn the unit back on, it will operate at the memorized volume level.

Mute

- 1 Press **PWR/MUTE** (**POWER/MUTE**  on the remote control) to cut the sound.
- 2 To cancel it, press again.

Checking the clock

You can see the clock pressing **IMAGE/DISP** (**DISP.** on the remote control).

Basic operation

Changing the monitor angle

Press and hold **▲/TILT** to adjust the front panel to an easily viewable angle.

- The angle of front panel can be adjusted up to 3 steps.
- The adjusted LCD panel angle will be memorized and the monitor panel will automatically return to this angle the next time the monitor panel is opened.

Setting the menu

- 1 Press and hold **VOL./MULTI (MENU/SEL)** on remote control for about 1 second. The menu screen appears.
Beep ↔ EON TA ↔ DPI ↔ TA ↔ ECM ↔ SRS focus
- 2 Push **VOL./MULTI** up or down to scroll between menus.
(Press the **▲ ▼** on the remote control.)
- 3 Push **VOL./MULTI** left or right to select the settings of your choice.
(Press **I◀◀◀/▶▶▶I** on the remote control.)
- 4 Press **VOL./MULTI** shortly to exit the main screen.

SRS focus	Set the SRS focus quality. (HIGH / LOW)
Beep	Set the beep sound every time a button is pressed. <ul style="list-style-type: none"> • 2ND mode : The beep is only generated when a key is long pressed (1 sec) • ALL mode : The beep is generated when any key is pressed.
EON TA	<ul style="list-style-type: none"> • DISTANCE : EON TA switching is try to implemented by the information of current station. • LOCAL : When the found strength level of EON is less than the threshold level, the radio does not switch that station, and customer can hardly listen to any disturbances.
DPI	<ul style="list-style-type: none"> • SOUND : If the sound of a station with different PI is heard intermittently, the receiver mutes the sound after 1 second. • MUTE : If the situation described above is repeated, the receiver instantly mutes the sound.
TA	<ul style="list-style-type: none"> • ALARM : When a newly tuned station has no TP information for 5 seconds, a double beep sound is output. • SEEK : When the newly tuned station does not receive TP information for 5 seconds, the receiver retunes to the next station which has the same PI as the last station, but has the TP information.
ECM (Echo Cancellation Mode)	It is to decrease any echo phenomenon of voice coming from another person's Bluetooth phone when working in Bluetooth. Control the mode (1-3) to the appropriate condition when talking over the phone.

Basic operation

Using the EQ (Equalizer)

The equalizer lets you adjust the equalization to match the acoustic characteristics of the car's interior as desired.

Press the **EQ/WOW/XDSS** repeatedly. The indicator lights up in the following order.

POP → Classic → ROCK → JAZZ → VOCAL → SALSA → SAMBA → USER1 → USER2 → OFF

- POP : Optimized for R&B, Soul and Country music.
- Classic : Optimized for orchestral music.
- ROCK : Optimized for Hard Rock and Heavy Metal music.
- JAZZ : Sweet sound with soft feeling.
- VOCAL : Powerful realism with strong sound quality.
- SALSA : Reproduces salsa music acoustics.
- SAMBA : Reproduces samba music acoustics.
- USER1 : Use the menu to set the sound level you want.
- USER2 : Use the menu to set the sound level you want.

You can adjust each sound level to your preference. Once you select a USER mode and then make an adjustment, it is automatically stored for the currently selected USER mode. See "Adjusting the sound level" below.

Adjusting the sound level

- 1 Press **VOL./MULTI (MENU/SEL)** on the remote control repeatedly to select the mode you want to adjust from volume, equalizer, balance and fader. The indicator lights up in the following order.
VOL → EQ → BAL → FAD → MIC
- 2 Rotate **VOL./MULTI** (Press **VOLUME ▲ ▼** on the remote control) to adjust the sound quality.

	Turn right	Turn left
VOL	Increase the volume level.	Decrease the volume level.
EQ	Increase the equalizer level.	Decrease the equalizer level.
BAL	Decrease the level of the right speaker(s).	Decrease the level of the left speaker(s).
FAD	Decrease the level of the rear speaker(s).	Decrease the level of the front speaker(s).
MIC	Increase the microphone level.	Decrease the microphone level.

Push **VOL./MULTI** left or right to move the next stage.

(Press **I◀◀ ◀▶▶▶ I** on the remote control) : EQ setting

Note

Normally the function works as sound level control. You can not select EQ to adjust the EQ level when it is using the EQ (POP, Classic, ROCK JAZZ, VOCAL, SALSA, SAMBA) mode.

Basic operation

XDSS/XDSS+ (Extreme Dynamic Sound System)

Press and hold the **EQ/WOW/XDSS** to select XDSS or XDSS+.

XDSS → XDSS+ → SRS (FOCUS → TRU BASS → 3D-STEREO → WOW) → By pass

XDSS/XDSS+ : Improve the treble, bass sound.

SRS (Sound Retrieval System)

- 1 Press and hold the **EQ/WOW/XDSS** to select SRS.
- 2 Press the **EQ/WOW/XDSS** repeatedly to select sub SRS.
 - FOCUS : Improve the resolution sound.
 - TRUBASS : Improve the bass sound to make it spectacular.
 - 3D-STEREO: Enjoy the 3D surround effect.
 - WOW : Enjoy the SRS and TruBass simultaneously.

★ Notes

-  is a trademark of the SRS Labs, Inc.
- WOW technology is incorporated under license of the SRS Labs, Inc.
- You can not use the EQ function while using the SRS function.

Using the IMAGE

Press **IMAGE/DISP** repeatedly to select the background you want in the display window.

You can select one of 10 modes. It displays the change of sound output during play.

Bluetooth operation

Using a Bluetooth wireless connection

Your unit supports Bluetooth wireless connections. You can set up a wireless link with a Bluetooth phone.

Starting Bluetooth on your phone

Your phone's Bluetooth feature may be set to off by default. To use your car Bluetooth feature, Bluetooth must be turned on in your phone.

Note

Refer to your phone's user guide.

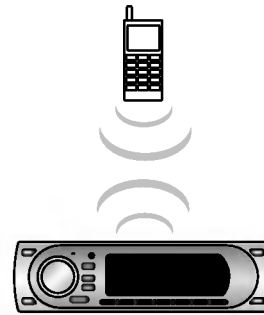

Pairing your unit and Bluetooth phone

Pairing links your unit and Bluetooth phone, and is required only once for the initial setup. Before you start the pairing procedure, make sure the Bluetooth feature is turned on in to your Bluetooth phone. Refer to your Bluetooth phone's user guide.

- 1 Press and hold **SEND** to connect your Bluetooth phone.
If connecting through a Bluetooth phone, the hands-free connection or headset connection may operate depending on the type of the phone.
Handsfree → Headset → OFF (No display)
- 2 If your Bluetooth phone does not support the handsfree connection, then initiate the headset connection.
The  indicator flashes.
- 3 Set the Bluetooth phone to look for your unit.
- 4 When the Bluetooth phone displays the device name, select the device.
- 5 The Bluetooth phone displays the PIN code enter screen, enter the PIN code.
LG CAR AUDIO PIN CODE : 1234
- 6 When your unit successfully paired with your Bluetooth phone, the flashing indicator stops.

Notes

- Your unit keeps lists of pairing you recently connected. A maximum of 4 pairing numbers can be saved.
- The Bluetooth phone which has a previous record showing that it has successfully connected will automatically start the connecting process when starting a car.
- Unlike the hands-free functionality, Headset connection will allow only two functions "answering calls" and "making a call from the latest call".
Also the caller's number is not displayed when answering calls.

Bluetooth phone not yet connected

If the Bluetooth phone has not been connected when you try to call up telephone mode, "Connecting" appears on the screen.

Bluetooth operation

Answering and Ending a call

Your unit, Bluetooth phone, or both may ring when you receive a call, press **SEND** to answer a call.

To end a call, press **BAND/END**.

Rejecting a call

When your unit rings, press **BAND/END**.

If the "Rejecting" function usable, then the phone connected to the device does not support the rejecting calls function.

Missed call notification

When an incoming call is not answered, the missed call message is displayed on the your screen.

- 1 The "Missing Call" appears on the screen.
- 2 Press **SEND** button to answer the call.
- 3 To end the call and hang up the phone, press **BAND/END** button.

Setting the menu

Once your unit and Bluetooth phone are paired, your phone automatically connects to the unit when you turn it on the next time. To confirm your unit and Bluetooth phone are successfully paired and operating property, make a call.

- 1 If your Bluetooth phone is already connected to a unit, press **SEND**.
The menu screen appears.
Dial preset → Dial last answered? → Dial last call?
- 2 Push **VOL./MULTI** up or down to select the menu.
- 3 Press **SEND** to enter the your choose.

Making a call from the latest call : Dial last call?

Your phone keeps a lists of your recently received and dialed even if the calls did not connected. The lists are sorted from newest to oldest entries.

Your unit keeps recorded of your recently received and dialed on phone.

Press **SEND** to place a call to entered phone number.

There is case that sending is done by pressing **SEND** button for a long time depending on type of mobile phone. (For basic setting, press **SEND** button shortly.)

"Calling Last Call" appears on the screen.

Note

When you want to make an international call, push **VOL./MULTI** up to add +.

Push **VOL./MULTI** toward down to deletes +.

+ can only be added when the detail list of Missed call, Dialed call or Received call is selected.

Bluetooth operation

Dial using a number from the list : Dial last answered?

Your unit keeps a record of your recently received and display.

- 1 Press **SEND**.
- 2 Push **VOL./MULTI** toward up or down to select the "Dial last answered?" menu.
- 3 Press **SEND**.
The "Last answered" and number appears on the screen.
- 4 Push **VOL./MULTI** toward up or down to scroll between numbers.
(Or press one of the **number 1 ~ 6**.)
- 5 Press **SEND** to place a call to entered phone number.

Note

When you want to make an international call, push **VOL./MULTI** toward up to add +.
Push the **VOL./MULTI** toward down to delete +.

Storing a call number : Dial Preset?

You can easily store up to 6 internal entries for later recall at the touch of a button.

- 1 Press **SEND**.
- 2 Push **VOL./MULTI** toward up or down to select the "Dial last answered?" menu.
- 3 Press the **SEND**.
The "Last answered" and number displays on the screen.
When you want to save an international call, push **VOL./MULTI** up to add +.
Push **VOL./MULTI** toward down to deletes +.
- 4 Press and hold **SEND**.
- 5 Push **VOL./MULTI** toward up or down to scroll between numbers or press one of the **number 1 ~ 6**.
- 6 Press **SEND**.
The selected number has been stored in memory.
(Or press and hold one of the **number 1 ~ 6**.)
- 7 Repeat steps 1 and 4 to save other calls.
The next time, you press the same **number 1 ~ 6**, the number is recalled from the memory.

Echo canceling and noise reduction

When you are doing hands-free phoning in the vehicle, you may hear undesired echo sounds.

This function reduces undesired echo sounds and noise while you are doing hands-free phoning, while maintaining a certain sound quality.

Please see page 12 for details.

Note

After setting ECM function, ensure to separate Car Audio Front Panel and mount it again.

Bluetooth operation

Pairing your unit and Bluetooth device (MP3 Player, MP3 Phone...)

When you activate your Bluetooth device's linked the unit, you can listen to MP3 with wireless connections.

- 1 Press and hold **SEND** to connect your Bluetooth device.
If connecting through a Bluetooth device, the hands-free connection or headset connection may operate depending on the type of the phone.
Handsfree → Headset → OFF (No display)
- 2 If your Bluetooth device does not support the handsfree connection, then initiate the headset connection.
The **i** indicator flashes.
- 3 Set the Bluetooth device to look for your unit.
- 4 When the Bluetooth device displays the device name, select the device.
- 5 The Bluetooth device displays the PIN code enter screen, enter the PIN code.
LG CAR AUDIO PIN CODE : 1234
- 6 When your unit successfully paired with your Bluetooth device, the flashing of indicator stops.

Playing MP3 files

When you turn Bluetooth on, your Bluetooth device display "Bluetooth" in the home screen.

The Bluetooth remains on until you press turn the device off.

Press **SRC** repeatedly to select a Bluetooth.

The indicator lights up in the following order.

TUNER → CD → AUX → BLUETOOTH → TUNER...

To play MP3 file stored on your Bluetooth device, refer to your Bluetooth device's user guide.

✦ Notes

- This function cannot be used with a device that it has no MP3 function.
- In order to use Bluetooth technology, devices must be able to interpret certain profiles.
This unit is compatible with following profiles.
 - GAP (Generic Access Profile)
 - HSP (Hands Set Profile)
 - HFP (Hands Free Profile)
 - GAVDP (Generic Audio/Video Distribution Profile)
 - A2DP (Advanced Audio Distribution Profile)
 - AVDTP (Audio/Video Distribution Transport Profile)
 - AVRCP (Audio/Video Distribution Remote Control Profile)
- When recording the keywords and the magic word, park your vehicle in a quiet place with the windows closed and the heater/air conditioner off.
This is necessary to obtain a higher recognition rate.

Bluetooth operation



GAP

GAP is short for Generic Access Profile. This is a basic profile of Bluetooth wireless technology.

HFP

HFP is short for Hands-Free Profile. This profile is used for hands-free phoning with the devices featuring Bluetooth wireless technology.

HSP

HSP is short for Head Set Profile. This profile is used for connecting a headset and for communicating terminal wireless technology.

GAVDP

This profile uses an Initiator (INT) a device (such as a portable player) that initiates a signalling procedure to send a request to an Acceptor (ACP), - such as headphones etc. Although this profile specifies signalling transaction procedures between two devices to set up, terminate and reconfigure streaming channels, using the GAVDP alone, it is required to use GAVDP in combination with profiles that depend on this profile - the AVRCP and the VDP.

A2DP

Mobile phones and devices with A2DP high quality stereo bluetooth profile. This profile is based on the GAVDP, and allows advanced audio to be transmitted (audio streaming) from a Source (SRK) - such as a CD player, to a Sink (SNK), such as headphones.

AVRCP

Based on the GAP Profile, it uses a Controller (CT) - PDA, computer mobile phone etc., that sends a command to a Target (TG) - TV, discman, headphone etc. The command can be to Play, record, colour control, volume control etc., depending on the nature of the devices involved and the scenario. The commands are transported by a new additional protocol, called the Audio/Video Control Transport Protocol (AVCTP). Some scenarios defined are Remote Control from a Separate Controller, Remote Control and Audio Stream Between Two Devices, Remote Controller with LCD.

Radio operation

Listening to radio stations

- 1 Press **SRC** to select the radio.
- 2 Press **BAND/END** repeatedly to select a band.
The indicator lights up in the following order. FM1 → FM2 → FM3 → MW(AM)
- 3 **Seek tuning** : Push **VOL./MULTI** left or right. (Press **◀◀ ▶▶** on the remote control.) The tuner will scan the frequencies until a broadcast with strong enough reception is found.
Manual tuning : Push and hold **VOL./MULTI** left or right until MANUAL starts flashing on the display, and then push it repeatedly.
(Press and hold **◀◀ ▶▶** on the remote control, and then press it repeatedly.) The frequencies move up or down step by step.

Auto search memory

This function lets you automatically store the 6 strongest broadcast frequencies.

- 1 Press **SRC** to select the tuner.
- 2 Push and hold **VOL./MULTI** for more than 1 second.
Scanning starts from the currently displayed frequency to higher frequencies and stops when 6 stations have been preset or the receivable frequencies have been scanned once.

Storing and recalling broadcast frequencies

You can easily store up to 6 broadcast frequencies for later recall at the touch of a button.

- 1 Select the desired frequency.
- 2 Press one of the **preset station 1 ~ 6** for more than 1 second.
The number you have pressed will flash in the preset number indicator and then remain lit. The selected radio station frequency has been stored in the memory.
- 3 Repeat steps 1 and 2 to preset other stations.
The next time you press the same **preset station 1 ~ 6**, the radio station frequency is recalled from the memory.

✦ Notes

- As FM1, FM2, FM3 have the same frequency range, up to 18 stations can be preset for FM.
- When a station is preset on the preset station button on which another station of the same band has already been preset, the previously preset station is automatically erased.

To scan the preset stations

Push **VOL./MULTI**. To stop the scanning, push **VOL./MULTI**.

To tune in the preset stations

Press **BAND/END** to select the desired band and press the desired number (1-6).
The number of the **preset station 1 ~ 6** is displayed and the preset station is received.

RDS operation

RDS Display options

In normal RDS operation the display will indicate the station name. Pressing the **IMAGE/DISP** enables you to cycle through the various data types in the following sequence:

(CT → FREQUENCY → PTY → RT → PS)

- **CT** (Time controlled by the channel)
- **PTY** (Program type recognition)
- **RT** (Radio text recognition)
- **PS** (Program Service name)
- **PI** (Program Identification)
- **AF** (Alternative Frequencies for the actual program)
- **TP** (Traffic Program Identification)
- **TA** (Traffic Announcement Identification)

PROGRAM TYPE function

To select a certain program type out of the reception band, the following procedure can be used.

- 1 Press **BAND/END** to select FM mode.
- 2 After, push the **VOL/MULTI** knob repeatedly in the down direction for selecting each mode.
music group → speech group → search off
- 3 Short press one of the **preset station 1 ~ 6**.
Each time this button is pressed, the display mode changes as follows.

No	Music group	No	Speech group
1.	Pop M, Rock M	1.	News, Affairs, Info
2.	Easy M, Light M.	2.	Sport, Educate, Drama
3.	Classics, Other M	3.	Culture, Science, Varied
4.	Jazz, Country	4.	Weather, Finance, Children
5.	Nation M, Oldies	5.	Social, Religion, Phone In
6.	Folk M	6.	Travel, Leisure, Document

Note

RDS is only available for FM reception.

RDS operation

RDS TA function

To switch on or off the TA (Traffic Announcement) function, press **TA/AF/REG** repeatedly.

- **TA ON**

Traffic programs and announcements can be automatically received using TP/TA features.

- **TA OFF**

Traffic programs and announcements can not be received using TP/TA features.

RDS AF/REG function

To switch on or off the AF function (Alternative Frequencies) or the REG (Regional Network Tracking) function, long press repeatedly the **TA/AF/REG** more than 2 seconds.

- **AF: ON / REG: ON**

Network-Tracking is activated. Regional mode is engaged (AF function changes between stations broadcasting the same program at all times). Regional mode shall be selected only in case of driving in certain local areas.

- **AF: ON / REG: OFF**

Network-Tracking is activated. AF function changes between stations belonging to the broadcast network being received.

- **AF: OFF / REG: OFF**

Network-Tracking is deactivated. Only station name will be displayed. In case of poor reception no alternative station can be used.

CD/MP3/WMA operation

Playing an Audio CD and MP3/WMA Disc

The unit can play MP3/WMA formatted recordings on CD-ROM, CD-R or CD-RW discs. Before playing MP3/WMA recordings, read the notes on MP3/WMA Recordings on page 26. If you change the source, CD play also stops (without ejecting the CD). Next time you select "CD" as the source, CD play starts from where playback has been stopped previously.

- To directly play a file, press **NUMBER (#)** on remote control and then press the track number with **0-9** number.

Pause CD MP3 WMA

- 1 Press **▶/||** during playback.
- 2 To return to playback, press **▶/||** again.

Moving to another track CD MP3 WMA

- Push **VOL./MULTI** left or right during playback to select the next track or to return the beginning of the current track. (Press **I◀◀◀/▶▶▶▶I** on the remote control.)
- Push **VOL./MULTI** left to select the previous track. (Press **I◀◀◀◀** on the remote control.) (If playing times is less than 4 seconds, there is no operation.)

Search CD MP3 WMA

Push **VOL./MULTI** knob (**I◀◀◀◀/▶▶▶▶I** on remote control) in left or right direction for about 1 second during playback and then release at the point you want.

Intro scan CD MP3 WMA

- 1 Press **SCAN**.
FOLDER SCAN appears in the display window. MP3 WMA
(The first 10 seconds of each files in the current selected folder on the disc are played.)
SCAN ALL appears in the display window. CD
(The first 10 seconds of each files on the disc are played.)
Press and hold **SCAN** for about 1 seconds during playback.
SCAN ALL appears in the display window. MP3 WMA
(The first 10 seconds of each files on the disc are played.)
- 2 Press **SCAN** again.
SCAN OFF appears in the display window. (The intro scan is cancelled.)

Repeat CD MP3 WMA

- 1 Press **RPT** during playback.
1 RPT appears in the display window. CD MP3 WMA
(The current selected music on the disc is played repeatedly.)
Press and hold **RPT** for about 1 seconds during playback.
FOLDER RPT appears in the display window. MP3 WMA
(The current selected folder on the disc is played repeatedly.)
- 2 Press **RPT** again.
RPT OFF appears in the display window. (The repeat mode is cancelled.)

CD/MP3/WMA operation

Random **CD** **MP3** **WMA**

- 1 Press **SHF** during playback.
FOLDER SHF appears in the display window. **MP3** **WMA**
(The current selected folder on the disc is played randomly.)
SHF ALL appears in the display window. **CD**
(All the music on the disc is played randomly.)
Press and hold **SHF** for about 1 seconds during playback.
SHF ALL appears in the display window. **MP3** **WMA**
(All the music on the disc is played randomly.)
- 2 Press **SHF** again.
SHF OFF appears in the display window.
(Random playback is cancelled.)

Note

During random playback, if you push **VOL./MULTI** (press **I**◀◀ ◀◀ on remote control) to left, you won't go back to the previous track.

CD TEXT / ID3 TAG **CD** **MP3** **WMA**

When playing a disc containing information, you can see the information CD TEXT/ID3 TAG information.

In a CD TEXT, some information about the disc (disc title, performer and track title) is recorded.

In a ID3 TAG, some information about the file (album title, Performer name, song title, recording year, music genre and a brief comment)is recorded.

If there is no information, "NO TEXT" will be shown in the display window.

Press the **IMAGE/DISP** repeatedly during MP3/WMA/CD TEXT file playback.

MP3/WMA TRACK -10/+10 **MP3** **WMA** (If there is no folder or one folder.)

During playback, push **VOL./MULTI** (press the **V** on remote control) down to skip to the previous 10 track, and push **VOL./MULTI** (press the **Λ** on remote control) up to skip to the next 10 track.

MP3/WMA FOLDER UP/DOWN **MP3** **WMA** (If there are more than two folders.)

During playback, push **VOL./MULTI** (press **V** on remote control) down to go to the previous folder, and push **VOL./MULTI** (press **Λ** on remote control) up to go to the next folder.

Note

Time display appearing on the display part when playing VBR file may vary and there may be some difference from actual time (both progress time and VBR are displayed at the same time when playing file).

Troubleshooting



Symptom	Cause	Correction
Power doesn't turn on. The unit doesn't operate.	<ul style="list-style-type: none"> Leads and connectors are not properly connected. The fuse is blown. Noise and other factors are causing the built-in microprocessor to operate incorrectly. 	<ul style="list-style-type: none"> Confirm once more that all connections are correct. Rectify the problem that caused the fuse to blow, and then replace it. Be very sure to install the correct fuse with the same rate. Turn the unit off and then on.
Playback is not possible.	<ul style="list-style-type: none"> The disc is dirty. The loaded disc is of a type this unit cannot play. 	<ul style="list-style-type: none"> Clean disc. Check what type the disc.
No sound is heard. The volume level will not rise.	<ul style="list-style-type: none"> Cables are not connected correctly. 	<ul style="list-style-type: none"> Connect the cables correctly.
There's no sound.	<ul style="list-style-type: none"> The volume level is low. 	<ul style="list-style-type: none"> Adjust the volume.
There's audio skipping.	<ul style="list-style-type: none"> This unit is not firmly secured. 	<ul style="list-style-type: none"> Secure this unit firmly.
The unit does not operate correctly even when the appropriate remote control buttons are pressed.	<ul style="list-style-type: none"> Battery power is low. Some operations are prohibited with certain discs. 	<ul style="list-style-type: none"> Load new battery. Check using another disc.

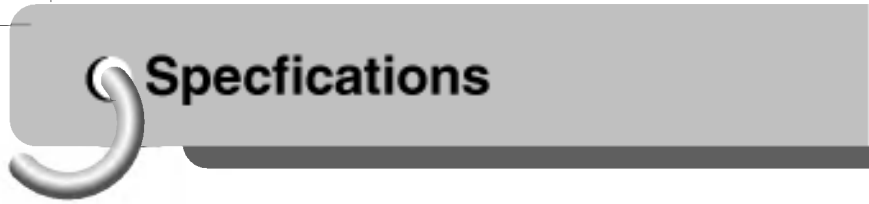

Specifications

MP3/WMA Disc compatibility with this unit is limited as follows:

1. Sampling Frequency / 8 - 48kHz (MP3), 22.05 - 48kHz (WMA)
2. Bit rate / within 8 - 320kbps (include VBR) (MP3), 32 - 320kbps (WMA)
3. CD-R/CD-RW file system should be "ISO 9660"
4. If you record MP3/WMA files using software which cannot create a FILE SYSTEM, for example "Direct-CD" etc., it will not be possible to playback MP3/WMA files. We recommend that you use "Easy-CD Creator" which creates an ISO9660 file system.

Customers should also note that permission is required in order to download MP3/WMA files and music from the Internet.

Our company has no right to grant such permission.

Permission should always be sought from the copyright owner.

GENERAL

Output Power	.50W x 4CH (Max.)
Power Source	.DC 12V
Speaker impedance	.4Ω
Ground System	Negative
Dimensions (W x H x D)	.180 x 51 x 171 mm (Without Front Panel)
Net Weight	.2.0 kg

CD SELECTION

Frequency Response	.20 Hz-20 kHz
S/N Ratio	.95 dB
Distortion	.0.1%
Channel Separation (1kHz)	.70 dB

RADIO SELECTION

FM	
Frequency Range	.87.5-107.9 or 87.5-108 MHz
S/N Ratio	.55 dB
Distortion	.0.7%
Usable Sensitivity	.12 dBμV
AM (MW)	
Frequency Range	.520-1720 or 522-1620 kHz
S/N Ratio	.45 dB
Distortion	.1.0%
Usable Sensitivity	.28 dBμV

Mobile phone list and manufacturing company applicable

Company	list	Company	list
Nokia	8910i	LG	LG KG800
Nokia	6021	LG	LG KU730
Nokia	3230	LG	U8210
Nokia	3650	LG	KP-4000
Nokia	6210i	Motorola	E1000
Nokia	6310i	Motorola	V600
Nokia	6230	Motorola	V3 razor
Nokia	6230i	Motorola	L6
Nokia	6260	Motorola	E1
Nokia	6600	Motorola	A1000
Nokia	9500	Sony-Ericsson	T68i
Nokia	6630	Sony-Ericsson	T610
Nokia	6680	Sony-Ericsson	K600i
Nokia	6681	Sony-Ericsson	K700i
Nokia	N70-1	Sony-Ericsson	S700i
Nokia	8800	Sony-Ericsson	V600
Nokia	8801	Sony-Ericsson	K750i
Samsung	SGH-D500	Sony-Ericsson	W550i
Samsung	SGH-D508	Sony-Ericsson	W800i
Samsung	SGH-D600	Sony-Ericsson	P910i
Samsung	SGH-Z500	QteK	9090
Samsung	SGH-Z500V	QteK	9100
Samsung	SGH-E770	QteK imate	8100
Samsung	SCH-V720	imate	K2
Samsung	SPH-E3700	QteK imate	8020
Samsung	SCH-A900	QteK imate	JASJAR
Samsung	SPH-V6900	HP	6515
Samsung	SPH-V7450	Siemens	S55
Samsung	SPH-V7400	Siemens	SL75
Samsung	SPH-X7700	Siemens	M75
Samsung	SPH-M600	Panasonic	X70
Samsung	SGH-E730	O2	XDA2 Mini
Samsung	SGH-E720	O2	XDA2 I
LG	KF-1000	Palmone	Treo 650
LG	LP-3900	Blackberry	7290
LG	P7200	Toshiba	A5504T
LG	S5200	SAZEM	myX6-2
LG	U8290		



P/NO : 3834RR0047Y