



NO.12 Ying Bin Road,Hai Ling District,Tai Zhou,Jiang Su,China
<http://www.lg.com>



LG

Life's Good

ENGLISH

ESPAÑOL

PORTUGUES

OWNER'S MANUAL

WINE CELLAR

Please read this guide thoroughly before operating and keep it handy for reference at all times.

Contents

Understanding & Preparation

Safety Instructions.....	3
Installation	8
Door Reversal	10
Movement, Transportation and Voltage Change.....	11

How To Use

Part identification.....	12
If this happens.....	14
Temperature regulation and related indication.....	15
Correct Way to Wine Storage.....	17

Cleaning

Cleaning.....	19
---------------	----

Confirmation

These are Not Faults.....	20
Please confirm the following before calling for service.....	21

Reference

Tips to help you enjoy your refrigerator.....	22
Energy-Saving Method.....	23

Thank you for purchasing LG products.

Safety Instruction

Safety notes are given for safe and correct use of the product.

- Safety notes are divided into “warning” and “caution” as described below.
- After reading, keep this manual in a convenient location for easy reference.
- ⚠ is an indication of a dangerous condition under specific conditions.

⚠ Warning

Personal injury or death may occur if operating rules are not followed.

⚠ CAUTION

Damage or property loss of house or contents may occur if operating rules are not followed.

This appliance is not intended for use by persons (including children) with reduced physical, sensory or mental capabilities, or lack of experience and knowledge, unless they have been given supervision or instruction concerning use of the appliance by a person responsible for their safety. Children should be supervised to ensure that they do not play with the appliance.

⚠ Warning (For Power Connection)

Use a Dedicated Power Outlet. Do Not Use An Extension Cord.

Sharing an outlet with another appliance can result in a circuit overload and fire.

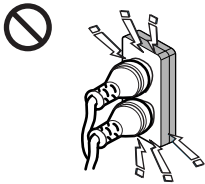

Make certain that the appliance is properly grounded.

Improper grounding (earthing) may cause electric shock or damage to the appliance. For specific grounding (earthing) requirements, refer to page 9.

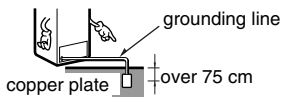

Before replacing the light bulb, always unplug the refrigerator to avoid an electric shock.

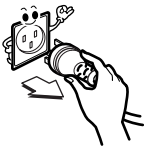

Power Plug Should Not Be Pinched by the back of the refrigerator.

The plug may be damaged, leading to fire or shock if it is pinched.

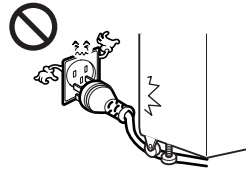

For cleaning, remove the power plug first.

Do not unplug with wet hands or you may receive an electric shock.

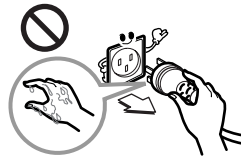

Insert the power plug tightly after checking to see that no dust or foreign matter is on it.

A dirty plug or a loose connection may result in a fire.



⚠ Warning (For Power Connection)

Clean dust off the power plug regularly to reduce the risk of fire.

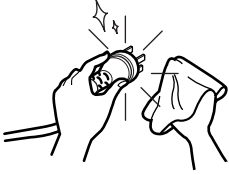

Do not place any foreign objects into the ventilation louvers. This could result in an electric shock or injury.

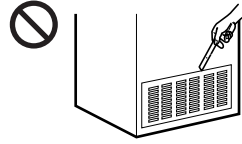

Do not damage, puncture, kink, stretch, or twist the power cord.

A damaged power cord can cause fire or electric shock.

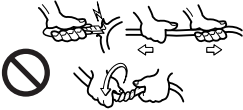

Do not modify or extend the Power Cord. It may cause electric shock or fire.

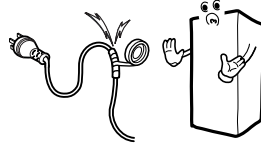

⚠ Warning (For Refrigerator Operation)

Do not disassemble, repair or change this product.

Injury, electric shock or fire may result and warranty coverage may be voided.



Do not place heavy items on top of the refrigerator.

They might fall and cause injury when the door is opened.

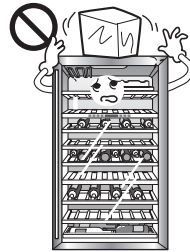

Do not climb on the refrigerator door. The refrigerator may tip over, resulting in damage and/or injury.

Special care should be given to prevent children from climbing on the refrigerator door.



Do not place any flammables such as ether, benzene, alcohol, or liquified gas into the refrigerator.

An explosion may result.



The appliance is not intended for use by young children. Children should not be permitted to play with the appliance.

⚠ Warning (For Refrigerator Operation)

Do not store drugs or chemicals in the refrigerator.

The Wine Cellar is not intended for the preservation of such temperature sensitive items. Deterioration or undesirable reactions may occur.

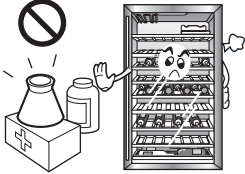

Keep refrigerator away from fire.

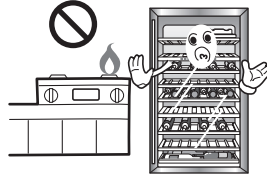

Do not use flammable or explosive sprays near the refrigerator.

A spark from an electric or control circuit can ignite a fire or explosion.

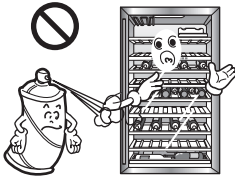

If you detect a gas leak, do not touch the refrigerator or power cord.

Vacate the home and phone the fire department from a mobile phone or a neighbor's phone.



Do not place vases, drinking glasses, or other liquid containers on the refrigerator.

Liquids spilled into electrical components may result in electric shock or other damage.



Do not use excessive water when cleaning the inside or outside of the refrigerator.

Wet insulation will adversely affect efficiency and may cause leakage or fire.

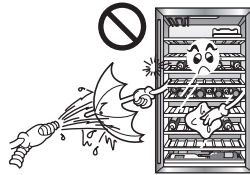

This Wine Cellar is intended for use only as a home appliance. It is not designed to withstand the rigors or environment of recreational vehicles or marine installations.

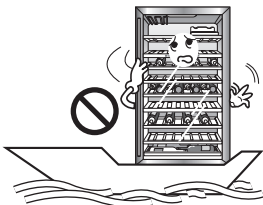

For disposal of this product, remove the door, leave the shelves and dividers in place, and put the unit in a location where children can not get inside.

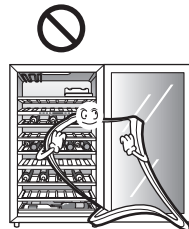

⚠ Warning (Important Safety Instruction)

- ⚠ Keep ventilation openings, in the appliance enclosure or in the built-in structure, clear of obstruction.
- ⚠ Do not use mechanical devices or other means to accelerate the defrosting process, other than those recommended by the manufacturer.
- ⚠ Do not damage the refrigerant circuit.
- ⚠ Do not use electrical appliances inside the food storage compartments of the appliance, unless they are of the type recommended by the manufacturer.
- ⚠ The refrigerant and insulation blowing gas used in the appliance require special disposal procedures. When disposal, please consult with service agent or a similarly qualified person.



This appliance contains a small amount of isobutane refrigerant (R600a), natural gas with high environmental compatibility, but it is also combustible. When transporting and installing the appliance, care should be taken to ensure that no parts of the refrigerating circuit are damaged. Refrigerant squirting out of the pipes could ignite or cause an eye injury. If a leak is detected, avoid any naked flames or potential sources of ignition and air the room in which the appliance is standing for several minutes.

In order to avoid the creation of a flammable gas air mixture if a leak in the refrigerating circuit occurs, the size of the room in which the appliance may be sited depends on the amount of refrigerant used. The room must be 1m² in size for every 8g of R600a refrigerant inside the appliance. The amount of refrigerant in your particular appliance is shown on the identification plate inside the appliance. Never start up an appliance showing any signs of damage. If in doubt, consult your dealer.

⚠ Caution

When removing the power plug, grasp the plug firmly and pull from the socket. Never pull the cord.



Do not use this product when the power cord or plug are damaged or fit loosely in the socket hole is loose.

These conditions may cause a short circuit resulting in fire.

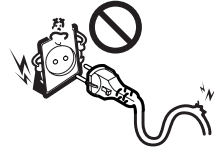

Unplug the refrigerator when it will not be used for an extended time.

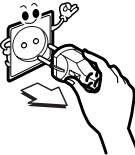

The refrigerator should be installed on a level and solid floor.

This will reduce vibration and avoid the possibility of tipping over when the door is opened.



Do not install the refrigerator in a damp place or where it can easily get wet.

Damp insulation will greatly reduce the efficiency of the refrigerator.



Do not install in a position where the glass door might hit, or be hit by, furniture or other objects when the door is opened.

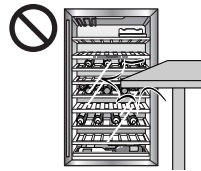

Do not reach under the refrigerator with your hands. Sharp edges on the metal base may cause injury.



Your refrigerator is heavy (54-83kg, depending on model). If it must be lifted, use 2 or 3 helpers.

Always carry the refrigerator in a nearly upright position - never tipped to the front, back, or side.

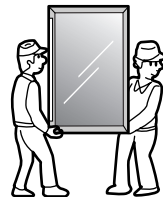

Installation

1. Choose a Good Location

Maintain proper distances between the refrigerator and items around it.

- To ensure proper air circulation around the fridge-freezer, please maintain sufficient space on both the sides as well as top and maintain at least 2 inches (5 cm) from the rear wall.
- If the refrigerator is too close to surrounding items, its operation may be affected and more energy will be consumed.

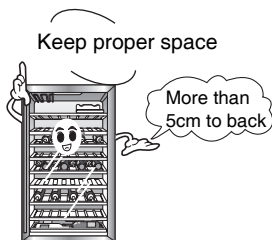

Install in a dry and well-ventilated place

- Do not install the refrigerator in a damp place or in places where it can easily get wet, to prevent metal parts from rusting or causing electric shock.
- Install the refrigerator in a well-ventilated place.

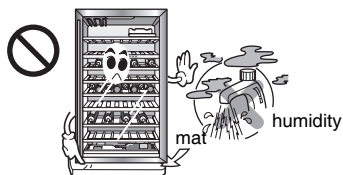

Avoid heat, and direct sunlight

- If surrounding temperature is high, it may decrease product efficiency and increase electric usage.

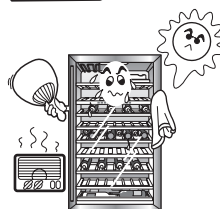

2. Levelling the refrigerator

Place in a firm and level location

- If the floor is not already level, use the adjustable feet to level the refrigerator from side to side.
- On carpeted floors and some types of hardwood floors, it is advisable to place the refrigerator on a thin sheet of plywood to prevent discoloration caused by heat from the refrigerator's condenser.
- An unstable floor can cause refrigerator vibration, noise, and door sag.

Adjust the front of the refrigerator slightly higher than the back

- Rock the refrigerator side to side, front to back, and corner to corner to be sure that it is solid; then readjust the front leveling feet so the front is slightly higher than the back.
- If the front is low, the door may not close tightly. Refrigerator performance will be affected and condensation may form on the interior.

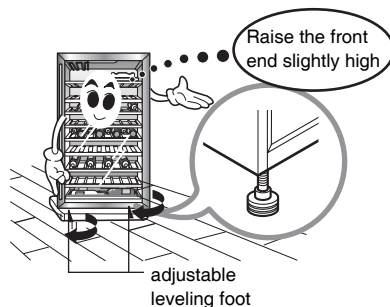

The Wine Cellar refrigerator is designed for best performance in an environment between 10°C and 35°C. A higher or lower temperature will affect the refrigerator's operation and shorten its useful life.

Installation

3. Grounding (Earth Ground)

Grounding must be done to prevent electric shock.

Grounded Outlet (earth ground) connections

- If the 230V outlet has a properly wired ground connection, no additional grounding is needed.

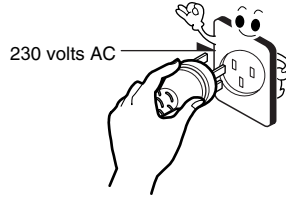

Connections without Grounded Outlets (earth ground)

- If a 230V grounded outlet is not available, a ground wire, connected to a copper plate buried underground, can be used.

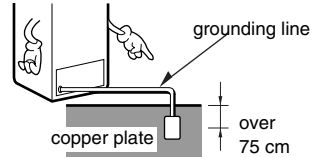

Places where grounding (Earth Ground) is impossible

- In places where access to ground is not possible, connect the refrigerator to a leakage protection switch (rated current 1.10A) and then connect it to the outlet.

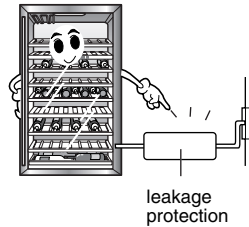

Places where no grounding is allowed

- Never connect ground wires to gas pipes, water pipes, a lightning arrester, or telephone lines.

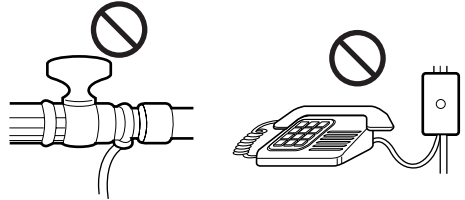

4. Please connect with power supply

Power supply connection

- Plug into a 230V outlet.

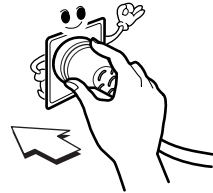

5. Storing your wine

- After power is connected, wait 4 hours before placing wine into the refrigerator.

Plastic pipe without conductive properties can not be used for grounding.

Door Reversal

- 1) HINGE COVER Disconnection
- 2) HINGE CAP Disconnection
- 3) BOLT Unfasten and HINGE Disconnection
- 4) DOOR Disconnection
- 5) DOOR CAP Disconnection
- 6) HINGE- L (1) Disconnection
- 7) HINGE- L (2) Disconnection

Adjust Screw Disconnection and Location Movement Assembly.

- 8) HINGE- L (1) and HINGE- L (2) Location Movement Assembly.
- 9) HINGE- PIN Disconnection Location Movement. Outer HOLE
- 10) DOOR 180° Rotation
- 11) HINGE STOPPER Disconnection Location Change Assembly
- 12) DOOR SET Attachment
- 13) HINGE Assembly
- 14) HINGE COVER Attachment
- 15) HINGE CAP Attachment
- 16) DOOR CAP Attachment.

Note

Reversing the doors is not covered by the warranty.

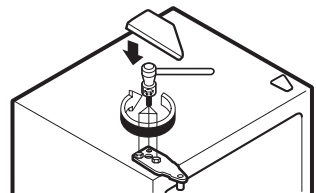
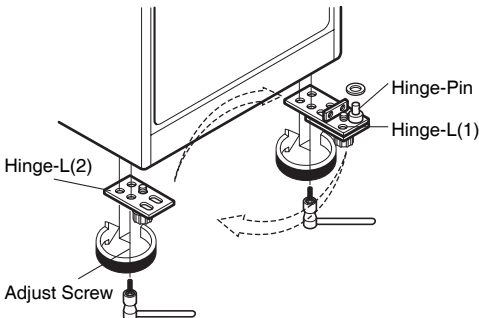
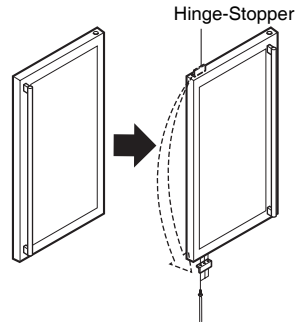
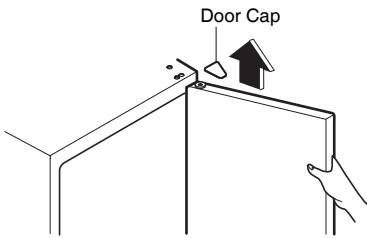
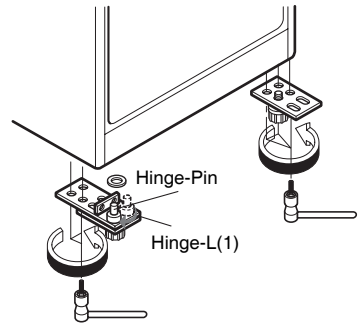
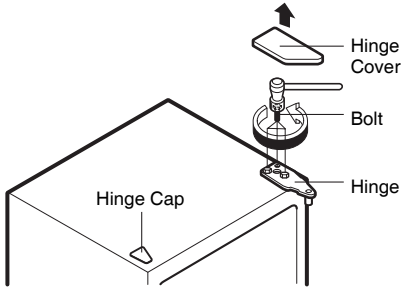

Movement, transportation and voltage change

Moving the refrigerator

Before moving

1. Remove all contents from the refrigerator.
2. Disconnect the power plug.
3. Secure loose parts, such as shelves, with tape.
4. Raise the refrigerator a little and screw the adjustable feet in as far as possible.

During transportation

1. Hold onto the adjustable feet while carrying.
2. Always carry the refrigerator in a nearly upright position - never tipped to the front, back, or side.
3. Refrigerators are heavy. If it must be lifted, get 2 or 3 helpers.

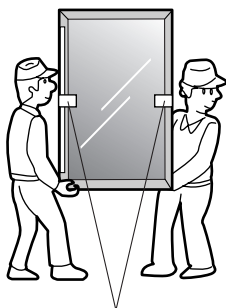

Fasten the door with transparent tape to prevent it from opening.

Note: If the refrigerator is moved by pushing, the adjustable feet must be screwed in tightly. The adjustable feet may scratch your floor or block the refrigerator from being moved.

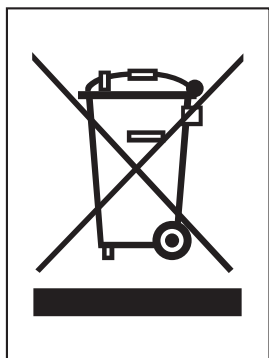

Disposal of your old appliance

1. When this crossed-out wheeled bin symbol is attached to a product it means the product is covered by the European Directive 2002/96/EC.
2. All electrical and electronic products should be disposed of separately from the municipal waste stream via designated collection facilities appointed by the government or the local authorities.
3. The correct disposal of your old appliance will help prevent potential negative consequences for the environment and human health.
4. For more detailed information about disposal of your old appliance, please contact your city office, waste disposal service or the shop where you purchased the product.

Part identification

Type 1

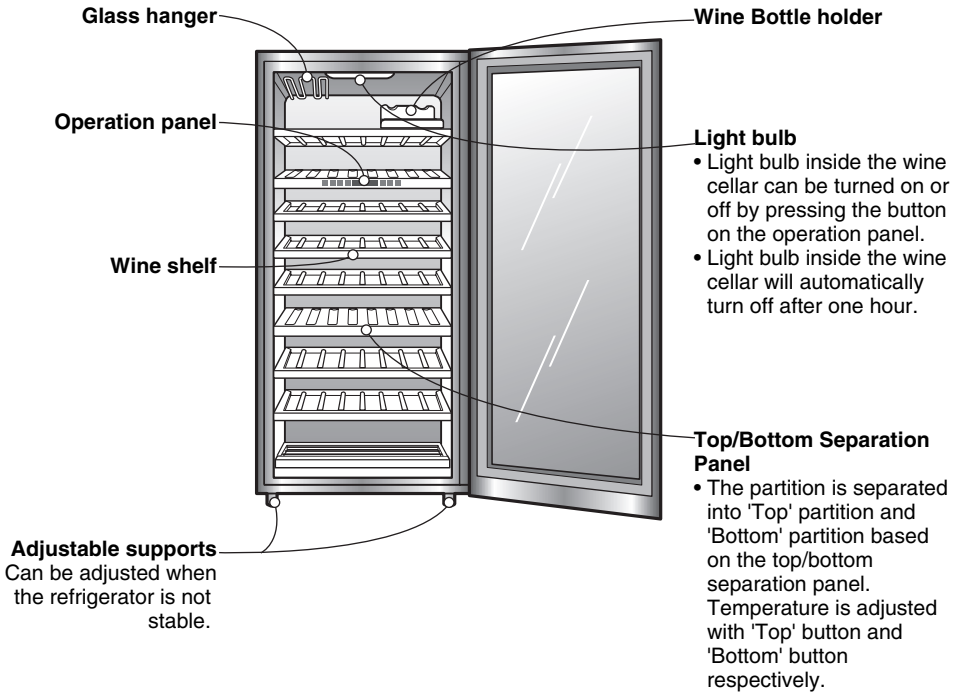

Part identification

Type 2

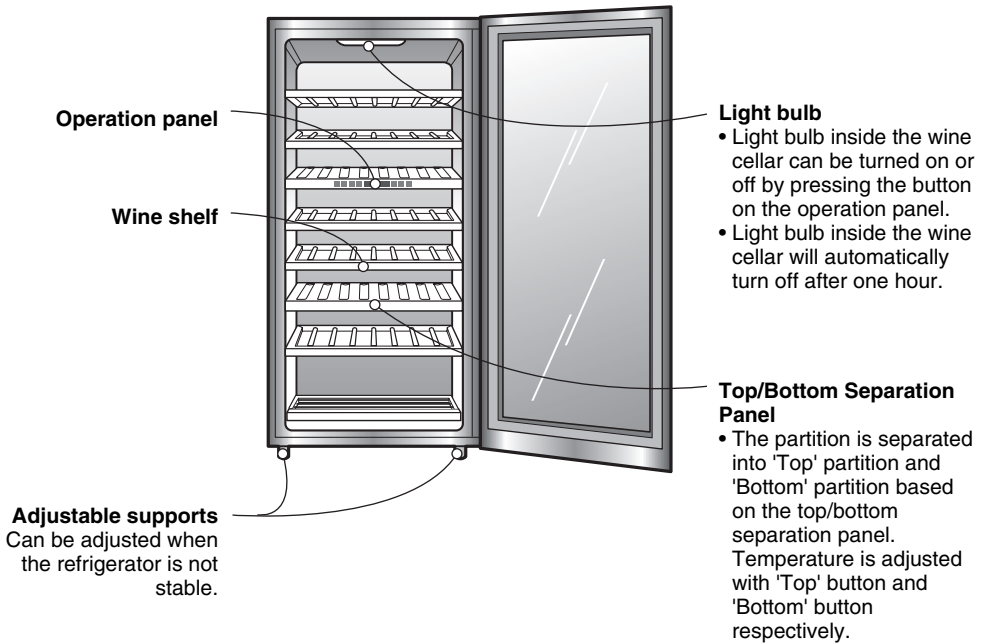

Type 3

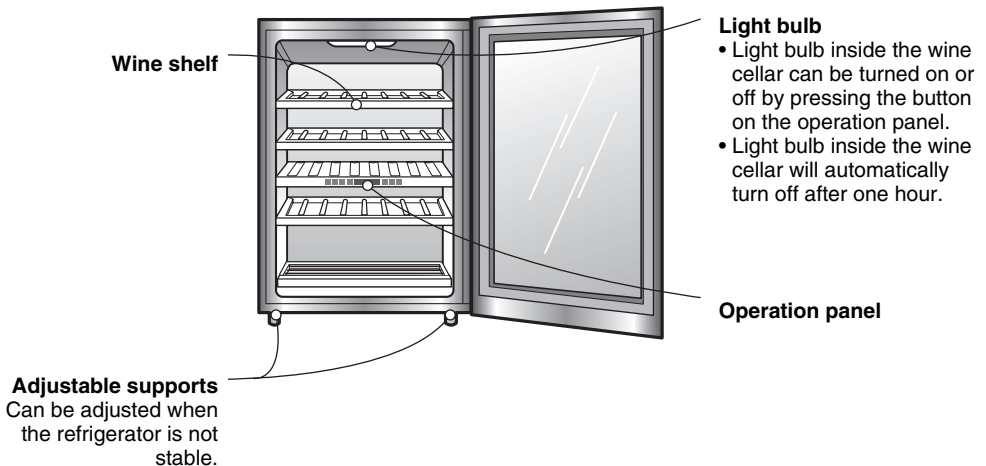

If this happens

When cooling capability weakens

When a large amount of wine is placed into the refrigerator, more time is needed to reach the desired temperature and get stabilized. (Sudden changes in temperature are the main reason for damage to wine flavor)

When power is off

Avoid opening the refrigerator door frequently and add no more wine for storage (to prevent the interior temperature from rising). After power is restored, the displayed temperature should be default (factory) setting. Reset is needed. (see page 15.16).

When light bulb malfunctions

Contact with the shop or after-sales service center.

When unit stays idle for a long time

Disconnect power supply and clean refrigerator interior. Open the door for 2-3 days to dry the refrigerator (To prevent mold and bad odor). When the refrigerator is restarted, the displayed temperature should be default (factory) setting. Reset is needed.

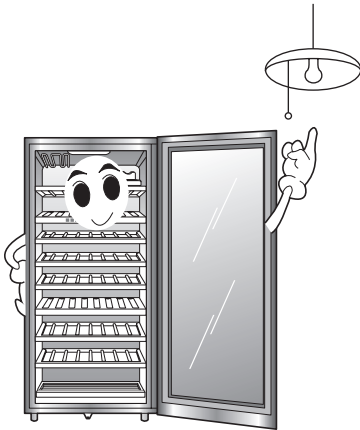

Temperature regulation and related indication

• Type 1 / Type 2

The regulated temperature range is 6°C to 18°C

Lock/Unlock Function

To change the temperature, press the button for 3 seconds.

Indication of "TOP" and "MIDDLE" set temperature

Indication of "BOTTOM" set temperature

Lighting bulb button

Push for ON, Push again for OFF (Light wil automatically turn off after one hour.)

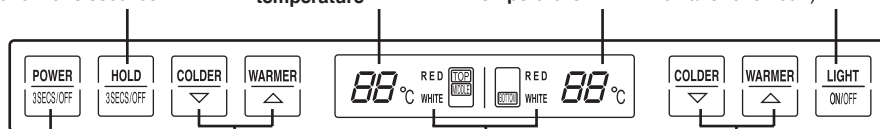

Power button

Press to turn ON, Press and hold 3 seconds to turn OFF

"TOP" and "MIDDLE" temperature control button

Indication of wine category

"BOTTOM" temperature control button

Change the Temperature

Default (factory) setting is 14°C for the upper section, the lower section is 8°C.

- Press "Hold" button for 3 seconds. In the unlocked state, the temperature indicators blink.

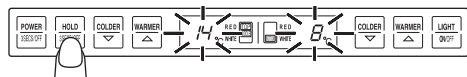

- For best results, select a temperature setting in the range specified for each type of wine.

WHITE 6°C~11°C
RED 12°C~18°C

* Children should be restricted from tampering with the "Hold" button to avoid causing unwanted changes.

- Each press of an upper or lower temperature button will raise or lower the temperature by 1°C. After the temperature is set the temperature display blinks for 10 seconds and then blinking is disabled and it is automatically locked.

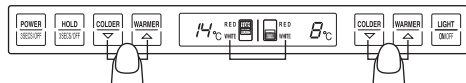

Storage Temperature for wine

- Note that the temperature of the upper section cannot be set colder than the lower section. If you want to adjust the upper section below the current temperature of the lower section, it is necessary to first lower the temperature in lower section.
- When it is delivered, the temperature is set to RED (14°C) for upper shelf, and WHITE (8°C) for lower shelf.
- The recommended temperature range for wine is:

WHITE 6°C~11°C

RED 12°C~18°C

- The time for the interior temperature to reach the set temperature varies with the specific usage of the refrigerator.
- The displayed temperature is the set temperature, which may be different from the actual temperature of the wine stored in the refrigerator.
- After a power outage, temperature resetting is needed. Resetting can be done in accordance with instructions in "Temperature Setting during Installation".

Temperature regulation and related indication

• Type 3

This model is not a power button.

The regulated temperature range is 6°C to 18°C

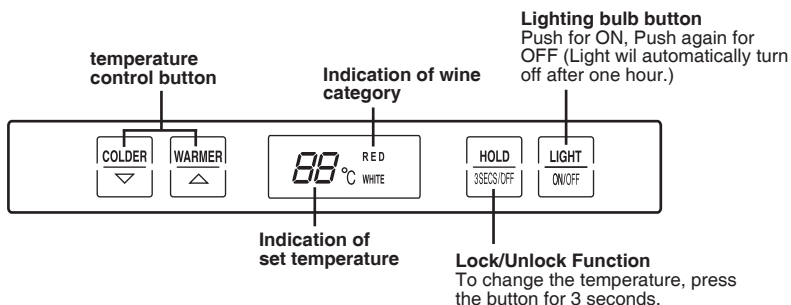

Change the Temperature

Default (factory) setting is 14°C for the section.

- ① Press “Hold ” button for 3 seconds.
In the unlocked state, the temperature indicators blink.

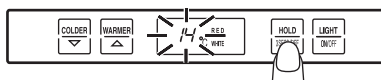

* Children should be restricted from tampering with the “Hold ” button to avoid causing unwanted changes.

- ② Each press of temperature button will raise or lower the temperature by 1°C.
After the temperature is set the temperature display blinks for 10 seconds and then blinking is disabled and it is automatically locked.



- ③ For best results, select a temperature setting in the range specified for each type of wine.

WHITE	6°C~11°C
RED	12°C~18°C

Storage Temperature for wine

- When it is delivered, the temperature is set to RED (14°C).
- The recommended temperature range for wine is:

WHITE 6°C~11°C

RED 12°C~18°C

- The time for the interior temperature to reach the set temperature varies with the specific usage of the refrigerator.
- The displayed temperature is the set temperature, which may be different from the actual temperature of the wine stored in the refrigerator.
- After a power outage, temperature resetting is needed. Resetting can be done in accordance with instructions in ‘Temperature Setting during Installation’.

Correct Way to Store Wine

The appliance is intended to be used exclusively for storage of wine.

Before Storage

At the Time of Setting...

Thoroughly clean the refrigerator interior.

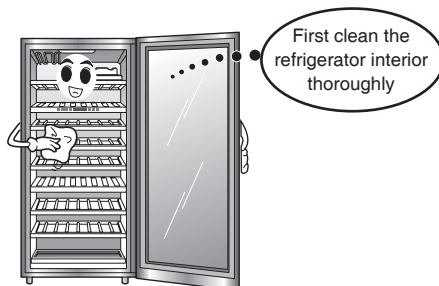

Put wine into the refrigerator around 4 hours after power is turned on.

When outdoor temperature is high, as in summer, the cooling time may exceed 4 hours.

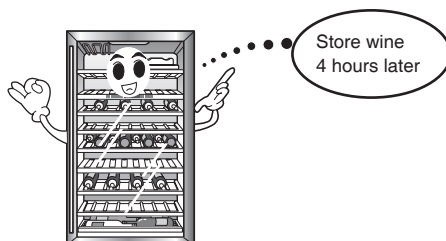

When placing wine into the refrigerator

At the time of cleaning!

For extended storage, wine labels must be protected with plastic foil.

(To prevent the labels from falling or molding)



Correct Way to Store Wine

Loading Direction

- **General Shelf:** When placing in the wine, place the wine bottle in alternate directions as shown in the picture.

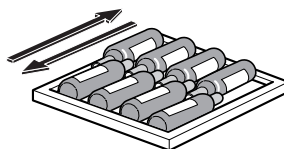

- **Bottom Shelf:** Bottom shelf can hold 4 bottles, maximum 9 bottles.

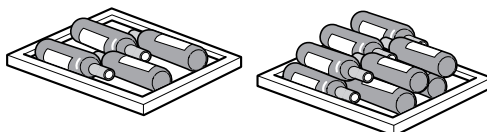

Wine Storage in the Decoration Cabinet

- Bottles with remaining wine inside should be recorked for storage.
- Bottles may break if the cork is forced into them.
- Sediment may appear with different categories of wines, their storing states in shops and their storage durations, but that does not mean the wine has become deteriorated and harmful.

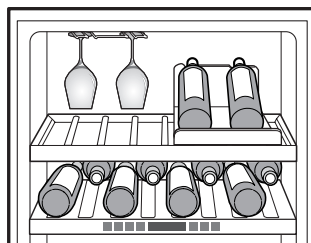

Cleaning

Clean the shelves and the refrigerator interior thoroughly once every year with power plug disconnected.

1. Before cleaning

Power plug must be pulled out first to secure the cleaning.

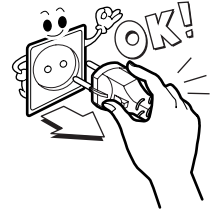

2. Please do not use the following articles for cleaning

Please do not use articles that can damage the refrigerator surface and its accessories, which include abrasive grain, petroleum, benzene, chlorohydric acid, solvent, hot water, brush, etc.

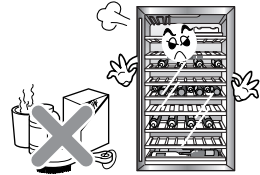

3. Do not wash with water

To wash the refrigerator directly with water will cause electricity leakage or other faults.

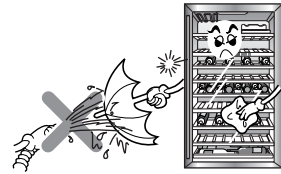

4. Cleaning refrigerator surface

Clean with soft towels dipped in warm water or detergent. If neutral detergent is used, it must be cleaned with clean towels.

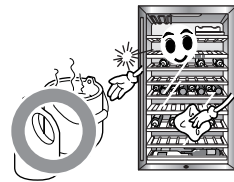

5. Cleaning door seals

Dirty door seals will get aged and damaged easily and that will cause cold air leakages.

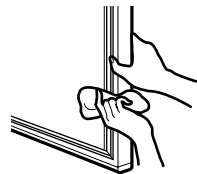

These Are Not Faults

There are abnormal noises inside the refrigerator

- Sound of coolant flowing.
There are cooling pipes in the rear, which often make noises. But that is not a fault.

Bulb is off when the door is either closed or opened

- Press “On/Off” button to turn on the bulb and it will automatically turn off an hour later.
- Press “On/Off” button again to turn off the bulb before closing the door.

Condensation drops on the door seal

- Condensate drops may appear on the door seal interface when outdoor temperature is high and humidity is thick.
Wipe them away with dry cloth.

Condensate Drops

Condensate drops on the surface

- Same as what happens when icy water is filled into a glass, i.e. condensate drops will appear on its outer surface.

Condensate drops will appear when warm and humid air touches the unit in the rainy season, especially in summer. Wipe them away with dry cloth.

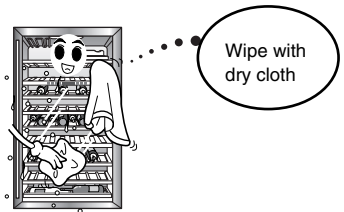

Condensate drops in interior

- Condensate drops will appear in interior if the door is opened frequently when it is hot and humid.

About 5-10 minutes later, the glass will become clean and transparent. This is not a fault.

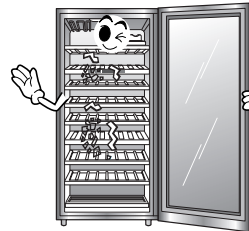

Odor



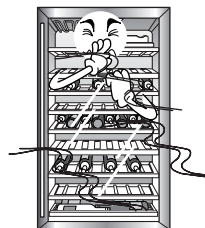

New product, but with odor

- Same as a new car or new furniture which will give off new odor.

The odor from the new product may come from plastic accessories or other various accessories used inside.

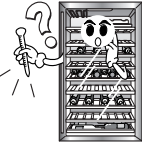

Please confirm the following before calling for service

Situation	Please check	Measures
The refrigerator does not operate 	<ul style="list-style-type: none"> • Is power supply cut? • Is power plug inserted into socket? • Is power voltage 230V? • Is the adopted booster switched on? 	<ul style="list-style-type: none"> • Check if other electric appliances operate or not. • Re-insert the plug properly. • Switch on the booster.
Inefficient cooling 	<ul style="list-style-type: none"> • Is the door closed tightly? • Is it under direct sunlight or near heat sources such as gas stove? • Is the distance between the refrigerator and surrounding items appropriate? • Is the temperature in the installation place appropriate? • Has anything such as carpet blocked the heat grill (ventilation)? 	<ul style="list-style-type: none"> • Raise the refrigerator front slightly using the adjustable foot. Move wine bottles away from the door to allow to close tightly. • Check the installation location. • Keep an appropriate distance away from surrounding items . • Temperatures above 10°C and below 35°C is appropriate. • Remove the blockage, such as carpet.
Strong noise and abnormal sound 	<ul style="list-style-type: none"> • Is the floor flat and firm and is it installed stably (noise may be a little strong on wooden floor)? • Are there any piled things in the refrigerator back or its top? 	<ul style="list-style-type: none"> • Please install it on flat and firm floor. • Move away the pile things.
Condensate drops appear in the interior 	<ul style="list-style-type: none"> • Is the door closed tightly? 	<ul style="list-style-type: none"> • The drops will automatically disappear after the door is close tightly. But the best way is to wipe them away first.
The door can not be closed tightly 	<ul style="list-style-type: none"> • Is the refrigerator tilted forward? • Are shelves placed correctly? 	<ul style="list-style-type: none"> • Please adjust the adjustable foot (adjusting the refrigerator front slightly higher will allow the door to be closed tightly). • Please place shelves properly.

Tips to help you enjoy your refrigerator

At the time of power failure

Please do not open and close the door frequently.

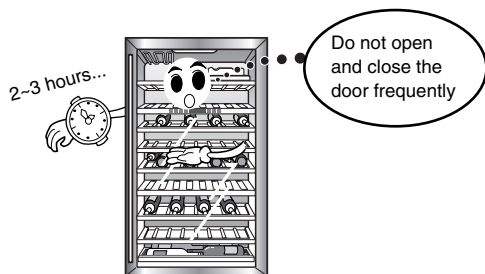

When top decoration cloth cover is used:

When top decoration cloth cover is used at the refrigerator top, make sure the cloth corners are not squeezed by the refrigerator door. Temperature will increase if the door is not closed tightly.



When the refrigerator is not used for a long time

Clean the interior thorough and keep the door open for 2-3 days to prevent molding and odor.



When the refrigerator is disposed

All connections in the refrigerator must be disconnected; door seals and shelves removed and the locking device dismantled. Do not place it in places where children often play, because they are easily entrapped into the refrigerator or hurt by the shelves.

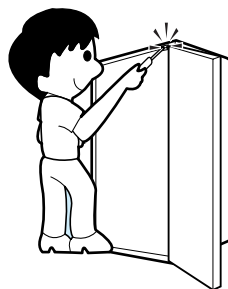

Energy-Saving Method

Do not open and close the door frequently if not necessary.

Please do not keep the door open for a long time.



Please do not open and close door frequently



Please close door in the shortest possible time