



MICROWAVE OVEN

OWNER'S MANUAL

MODLE : MS2047CZ
MS2047CB

PLEASE READ THIS OWNER'S MANUAL
THOROUGHLY BEFORE OPERATING.

How to read the manufactured month and year from the label
stuck on the back of the product.

Ex) 2 0 5 TA ?? 0 0 0 1

- Serial No.
- Algorithm
- Product code
- Month
- Year (The last digit of year)

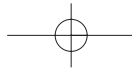

Precautions

Precautions to avoid possible exposure to excessive microwave energy.

You cannot operate your oven with the door open due to the safety interlocks built into the door mechanism. These safety interlocks automatically switch off any cooking activity when the door is opened; which in the case of a microwave oven could result in harmful exposure to microwave energy.

It is important not to tamper with the safety interlocks.

Do not place any object between the oven front face and the door or allow food or cleaner residue to accumulate on sealing surfaces.

Do not operate your oven if it is damaged. It is particularly important that the oven door closes properly and that there is no damage to the: (1) door(bent), (2) hinges and latches (broken or loosened), (3) door seals and sealing surfaces.

Your oven should not be adjusted or repaired by anyone except qualified service personnel.

- Utensils should be checked to ensure that they are suitable for use in microwave ovens.
- When heating food in plastic or paper containers, check the oven frequently due to the possibility of ignition.
- If smoke is observed, switch off or unplug the appliance and keep the door closed in order to stifle any flames.
- Microwave heating of beverages can result in delayed eruptive boiling. Therefore care has to be taken when handling the container.
- The contents of feeding bottles and baby food jars are to be stirred or shaken and the temperature is to be checked before consumption, in order to avoid burns.
- Eggs in their shell and whole hard-boiled eggs shall not be heated in microwave ovens since they may explode.

Warning

Please ensure cooking times are correctly set as over cooking may result in the FOOD catching fire and subsequent damage to your oven.

When heating liquids, e.g. soups, sauces and beverages in your microwave oven, overheating the liquid beyond boiling point can occur without evidence of bubbling. This could result in a sudden boil over of the hot liquid. To prevent this possibility the following steps should be taken:

1. Avoid using straight sided containers with narrow necks.
2. Do not overheat.
3. Stir the liquid before placing the container in the oven and again halfway through the heating time.
4. After heating, allow to stand in the oven for a short time, stir or shake them again carefully and check the temperature of them before consumption to avoid burns (especially, contents of feeding bottles and baby food jars).



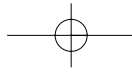

Precautions

Warning

Always allow food to stand after being cooked by microwaves and check the temperature of them before consumption. Especially contents of feeding bottles and baby food jars.

- **WARNING:** If the door or door seals are damaged, the oven must not be operated until it has been repaired by a trained person.
- **WARNING:** It is hazardous for anyone other than a trained person to carry out any service or repair operation which involves the removal of any cover which gives protection, against exposure to microwave energy.
- **WARNING:** Liquids or other foods must not be heated in sealed containers since they are liable to explode.
- **WARNING:** Only allow children to use the oven without supervision when adequate instructions have been given so that the child is able to use the oven in a safe way and understands the hazards of improper use.
- **WARNING :** When the appliance is operated in the combination mode, children should only use the oven under adult supervision due to the temperatures generated.
- **WARNING :** Accessible parts may become hot during use. Young children should be kept away.

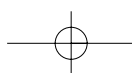

Table of Contents

4	TECHNICAL SPECIFICATIONS
5	INSTALLATION
6	INSTRUCTION
	HOW THE MICROWAVE OVEN WORKS
	GETTING THE BEST RESULTS FROM YOUR MICROWAVE OVEN
	HOW FOOD CHARACTERISTICS AFFECT MICROWAVE COOKING
	SPECIAL TECHNIQUES IN MICROWAVE COOKING
	MICROWAVE-SAFE UTENSILS
9	FEATURE DIAGRAM / CONTROL PANEL
10	OPERATING INSTRUCTIONS
	SETTING CLOCK
	QUICK START
	MICRO POWER COOKING
	TWO STAGE COOKING
	MICROWAVE POWER LEVELS
	CHILD LOCK
	AUTO COOK
	AUTO COOK CHART
	AUTO WEIGHT DEFROST
	AUTO WEIGHT DEFROST GUIDE
	QUICK DEFROST
15	HEATING OR REHEATING GUIDE
16	FRESH VEGETABLE CHART
17	OTHER HELPFUL INSTRUCTIONS
18	SAFETY PRECAUTIONS
19	QUESTIONS AND ANSWERS

Technical Specifications

	MS2047CZ	MS2047CB
Power Input	220V AC~50/60Hz	127V AC~60Hz
Output	700 W	
Microwave Frequency	2,450 MHz	
Outside Dimensions	455mm(W) X 281mm(H) X 325mm(D)	
Cavity Dimensions	310mm(W) X 205mm(H) X 294mm(D)	
Power Consumption	1,100 W	
Net weight	Approx. 12 Kg	
Shipping Weight	Approx. 13.2 Kg	

Installation

Install your oven by following three simple steps:

1. Remove all packing materials and accessories.
2. Place the oven in the level location of your choice with more than 85cm height but make sure there is at least 10 cm of space on the top and 10cm at the rear for proper ventilation. The side of the oven should be kept clear so there is air flow for ventilation.
An exhaust outlet is located on top or side of the oven. Blocking the outlet can damage the oven.
3. Plug your oven into a standard voltage household outlet. Be sure the electrical circuit is at least 13 amps and that your microwave oven is the only appliance on the circuit.

NOTE: • If your oven does not operate properly, unplug it from the AC household outlet and then plug it back in.

- **This appliance should not be used for commercial catering purposes.**

WARNING : THIS APPLIANCE MUST BE EARTHED

IMPORTANT

The wires in the mains lead are coloured in accordance with the following codes :

Blue or White	-	Neutral
Brown or Black	-	Live
Green & Yellow or Green	-	Earth

As the colours of the wires in the mains lead of this appliance may not correspond with the coloured markings identifying the terminals in your plug, proceed as follows :

The wire which is coloured blue or white must be connected to the terminal which is marked with the letter N or coloured black.

The wire which is coloured brown or black must be connected to the terminal which is marked with the letter L or coloured red.

The wire which is coloured green & yellow or green must be connected to the terminal which is marked with the letter E or \perp .

This utility article is provided with a mains cord of special performance, which in case it is damaged, must be replaced with a mains cord of the same type ; such a mains cord can be obtained from importer and be installed by a competent person.

Introduction

How the Microwave Oven Works

Microwaves are a form of energy similar to radio and television waves and ordinary daylight. Ordinarily, microwaves spread outwards as they travel through the atmosphere and disappear without effect.

Microwave ovens, however, have a magnetron which is designed to make use of the energy in microwaves. Electricity, supplied to the magnetron tube, is used to create microwave energy. These microwaves enter the cooking area through openings inside the oven. A turntable or tray is located at the bottom of the oven.

Microwaves cannot pass through metal walls of the oven, but they can penetrate such materials as glass, porcelain and paper, the materials out of which microwave-safe cooking dishes are constructed.

Microwaves do not heat the cookware, though cooking vessels will eventually get hot from the heat generated by the food.

A very safe appliance. Your microwave oven is one of the safest of all home appliances. When the door is opened, the oven automatically stops producing microwaves. Microwave energy is converted completely to heat when it enters food, leaving no “left over” energy to harm you when you cook your food.

Getting The Best Results From Your Microwave Oven

Keeping an eye on things. The recipes in this book have been formulated with great care, but your success in preparing them depends, of course, on how much attention you pay to the food as it cooks. Always watch your food while it cooks. Your microwave oven is equipped with a light that turns on automatically when the oven is in operation so that you can see inside and check the progress of your recipe. Directions given in recipes to ‘elevate’, ‘stir’, and the like should be thought of as the minimum steps recommended. If the food seems to be cooking unevenly, simply make the necessary adjustments you think appropriate to correct the problem.

Factors affecting cooking times. To check the wattage of your oven, refer to the specifications at the beginning of this book. Many factors affect cooking times. The temperature of ingredients used in a recipe makes a big difference in cooking times.

For example, a cake made with ice-cold butter, milk, and eggs will take considerably longer to bake than one made with ingredients that are at room temperature. All of the recipes in this book give a range of cooking times. In general, you will find that the food remains under-cooked at the lower end of the time range, and you may sometimes want to cook your food beyond the maximum time given, according to personal preference. The governing philosophy of this book is that it is best for a recipe to be conservative in giving cooking times. While undercooked food is ruined for good. Some of the recipes, particularly those for bread, cakes, and custards, recommend that food be removed from the oven when they are slightly undercooked. This is not a mistake. When allowed to stand, usually covered, these foods will continue to cook outside of the oven as the heat trapped within the outer portions of the foods gradually travels inward. If the foods are left in the oven until they are cooked all the way through, the outer portions will become overcooked or even burnt. As you gain experience in using your microwave oven, you will become increasingly skillful in estimating both cooking and standing times for various foods.

How Food Characteristics Affect Microwave Cooking

Density of foods: Light, porous food such as cakes and breads cook more quickly than heavy, dense foods such as roasts and casseroles. You must take care when microwaving porous foods that the outer edges do not become dry and brittle.

Height of foods: The upper portion of tall foods, particularly roasts, will cook more quickly than the lower portion. Therefore, it is wise to turn tall foods during cooking, sometimes several times.

Moisture content of foods: Since the heat generated from microwaves tends to evaporate moisture, relatively dry foods such as roasts and some vegetables should either be sprinkled with water prior to cooking or covered to retain moisture.

Bone and fat content of foods: Bones conduct heat and fat cooks more quickly than meat. Therefore, care must be taken when cooking bony or fatty cuts of meat that they do not cook unevenly and do not become overcooked.

Introduction

Quantity of foods: The number of microwaves in your oven remains constant regardless of how much food is being cooked. Therefore, the more food you place in the oven, the longer the cooking time. Remember to decrease cooking times by at least one third when halving a recipe.

Shape of foods: Microwaves penetrate only about 1 inch (2.5cm) into foods, the interior portion of thick foods are cooked as the heat generated on the outside travels inward. In other words, only the outer edge of any foods is actually cooked by microwave energy; the rest is cooked by convection. It follows then that the worst possible shape for a food that is to be microwaved is a thick square. The corners will burn long before the centre is even warm. Round thin foods and ring shaped foods cook successfully in the microwave.

Special Techniques In Microwave Cooking

Browning: Meats and poultry that are cooked fifteen minutes or longer will brown lightly in their own fat. Foods that are cooked for a shorter period of time may be brushed with a browning sauce to achieve an appetizing colour. The most commonly used browning sauces are Worcestershire sauce, soy sauce and barbecue sauce. Since relatively small amounts of browning sauces are added to foods, the original flavour of recipes are not altered.

Covering: A cover traps heat and steam which causes food to cook more quickly. You may either use a lid or microwave clingfilm with a corner folded back to prevent splitting.

Covering with greaseproof paper: Greaseproofing effectively prevents spattering and helps food retain some heat. But because it makes a looser cover than a lid or clingfilm, it allows the food to dry out slightly.

Wrapping in greaseproof or paper towel: Sandwiches and many other foods containing prebaked bread should be wrapped prior to microwaving to prevent drying out.

Arranging and spacing: Individual foods such as baked potatoes, small cakes and hors d'oeuvres will heat more evenly if placed in the oven an equal distance apart, preferably in a circular pattern. Never stack foods on top of one another.

Stirring: Stirring is one of the most important of all microwaving techniques. In conventional cooking, foods are stirred for the purpose of blending. Microwaved foods, however, are stirred in order to spread and redistribute heat. Always stir from the outside towards the centre as the outside of the food heats first.

Turning over: Large, tall foods such as roasts and whole chickens should be turned so that the top and bottom will cook evenly. It is also a good idea to turn cut up chicken and chops.

Placing thicker portions facing outwards: Since microwaves are attracted to the outside portion of foods, it makes sense to place thicker portions of meat, poultry and fish to the outer edge of the baking dish. This way, thicker portions will receive the most microwave energy and the foods will cook evenly.

Shielding: Strips of aluminum foil, which block microwaves, are sometimes placed over the corners or edges of square and rectangular foods to prevent those portions from overcooking. Never use too much foil and make sure the foil is tightly secured to the dish or it may cause 'arcing' in the oven.

Elevating: Thick or dense foods are often elevated so that microwaves can be absorbed by the underside and centre of the foods.

Piercing: Foods enclosed in a shell, skin or membrane are likely to burst in the oven unless they are pierced prior to cooking. Such foods include both yolks and whites of eggs, clams and oysters and many whole vegetables and fruits.

Testing if cooked: Because foods cook so quickly in a microwave oven, it is necessary to test food frequently. Some foods are left in the microwave until completely cooked, but most foods, including meats and poultry, are removed from the oven while still slightly undercooked and allowed to finish cooking during standing time. The internal temperature of foods will rise between 5 F(3 C) and 15 F(8 C) during standing time.

Standing time: Foods are often allowed to stand for 3 to 10 minutes after being removed from the microwave oven. Usually the foods are covered during standing time to retain heat unless they are supposed to be dry in texture (some cakes and biscuits, for example). Standing allows foods to finish cooking and also helps flavour blend and develop.

Introduction

Microwave-Safe Utensils

Never use metal or metal trimmed utensils in your microwave oven. Microwaves cannot penetrate metal. They will bounce off any metal object in the oven and cause arcing, an alarming phenomenon that resembles lightning.

Most heat resistant non metallic cooking utensils are safe for use in your microwave oven. However, some may contain materials that render them unsuitable as microwave cookware. If you have any doubts about a particular utensil, there's a simple way to find out if it can be used in your microwave oven.

Testing utensils for microwave use: Place the utensil in question next to a glass bowl filled with water in the microwave oven.

Microwave at power HIGH for 1 minute. If the water heats up but the utensil remains cool to the touch, the utensil is microwave-safe. However, if the water does not change temperature but the utensil becomes warm, microwaves are being absorbed by the utensil and it is not safe for use in the microwave oven. You probably have many items on hand in your kitchen right now that can be used as cooking equipment in your microwave oven. Just read through the following checklist.

1. Dinner plates: Many kinds of dinner-ware are microwave-safe. If in doubt consult the manufacturer's literature or perform the microwave test.

2. Glassware: Glassware that is heat-resistant is microwave-safe. This would include all brands of oven tempered glass cookware. However, do not use delicate glassware, such as tumblers or wine glasses, as these might shatter as the food warms.

3. Paper: Paper plates and containers are convenient and safe to use in your microwave oven, provided that the cooking time is short and foods to be cooked are low in fat and moisture. Paper towels are also very useful for wrapping foods and for lining baking trays in which greasy foods such as bacon are cooked. In general, avoid coloured paper products as the colour may run.

4. Plastic storage containers: These can be used to hold foods that are to be quickly reheated. However, they should not be used to hold foods that will need considerable time in the oven as hot foods will eventually warp or melt plastic containers.

5. Plastic cooking bags: These are microwave-safe, provided they are specially made for cooking. However, be sure to make a slit in the bag so that steam can escape. Never use ordinary plastic bags for cooking in your microwave oven, as they will melt and rupture.

6. Plastic microwave cookware: A variety of shapes and sizes of microwave cookware is available. For the most part, you can probably microwave items you already have on hand rather than investing in new kitchen equipment.

7. Pottery, stoneware and ceramic: Containers made of these materials are usually fine for use in your microwave oven, but they should be tested to be sure.

CAUTION: HIGH IRON CONTENT, HIGH LEAD CONTENT, SOME ITEMS NOT FOR COOKING.

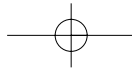

Feature Diagram / Control Panel

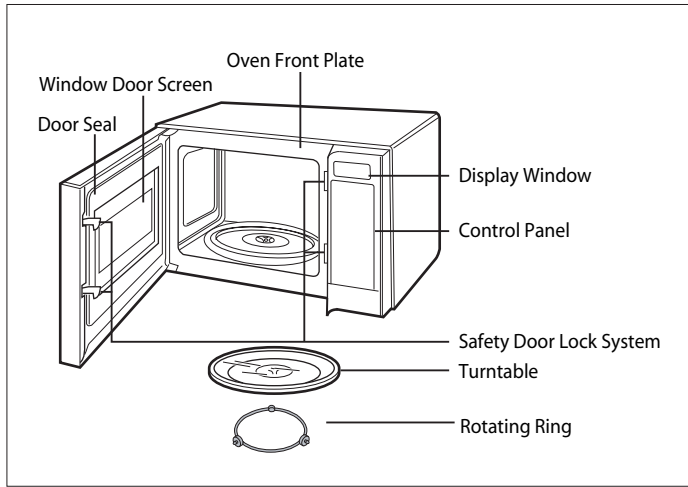

Your oven will be packed with the following materials:

Glass Turntable 1 each
 Owner's Manual 1 each

Rotating Ring 1 each

This microwave oven is designed for household use only. It is not recommended for commercial purposes.

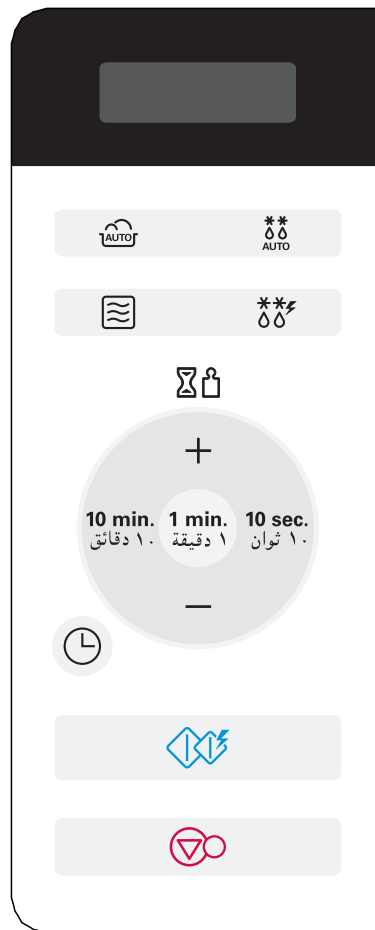

NOTE: A beep sounds when a pad on the control panel is touched, to indicate setting has been entered.

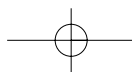

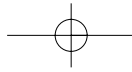

Operating Instructions

SETTING CLOCK

When your oven is plugged in for the first time or when power resumes after a power cut, a '0' will be shown in the display; you will have to reset the clock.

If the clock (or display) shows any strange looking symbols, unplug your oven from the electrical socket and plug it back in and reset the clock.

During clock setting the colon will flash.

After setting, the colon will stop flashing. You can set either 12 hour clock or 24 hour clock .

In the following example I will show you how to set the time for 14:35 when using the 24 clock.

Make sure that you have removed all packaging from your oven.

Make sure that you have correctly installed your oven as described earlier in this book. Make sure that you have correctly installed your oven as described earlier in this book.

1. Press **STOP/CLEAR** .

2. Press **CLOCK** once.

(If you want to use different option, Press **CLOCK** twice.
If you want to change different option after setting clock, you have to unplug and plug it back in.)

3. Press **10 MIN** fifteen times.
Press **1 MIN** three times.
Press **10 SEC** five times.

4. Press **CLOCK** to set the time.
The clock starts counting.

QUICK START

In the following example I will show you how to set 2 minutes of cooking on high power.

1. Press **STOP/CLEAR**.

2. Press **START** four times to select 2 minutes on HIGH power.
Your oven will start before you have finished the fourth press.

During **QUICK START** cooking, you can extend the cooking time up to 10 minutes by repeatedly pressing the **START** key.

NOTE: The **QUICK START** feature allows you to set 30 seconds intervals of HIGH power cooking with a touch of the **START** key.

MICRO POWER COOKING

This function allows you to cook food for a desired time. And in order to give you the best results, there are 5 power level settings in addition to HI-POWER because many food need slower cooking (at less than HI-POWER).

Example: To cook food on 80% Power (Power8) for 11 minutes .

1. Press **STOP/CLEAR**.

2. Press **POWER** twice to select 80% power.
"560" appears on the display.

3. Press **10 MIN** once.
Press **1 MIN** once.

4. Press **START**.

TWO STAGE COOKING

For Two Stage cooking, repeat power cooking steps 2 through 3 on the previous page before touching the **START** pad for additional Time and Power program you want to add.

Auto Weight Defrost can be programmed before the first stage to defrost first and then cook.

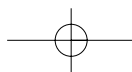

Operating Instructions

During two stage cooking the oven door can be opened and food checked. Close the oven door and press **START** and the cooking stage will continue.

At the end of stage1, BEEP sounds and stage 2 commences.

Should you wish to clear the programme press **STOP/CLEAR** twice.

MICROWAVE POWER LEVELS

Your oven has five microwave Power settings. High power is automatically selected but repeated presses of the **POWER** key will select a different power level .

POWER LEVEL	OUTPUT	USE
HIGH	100% (700W)	* Boil Water * Brown minced beef * Cook poultry pieces, fish, vegetables * Cook tender cuts of meat
MEDIUM HIGH	80% (560W)	* All reheating * Roast meat and poultry * Cook mushrooms and shellfish * Cook foods containing cheese and eggs
MEDIUM	60% (420W)	* Bake cakes and scones * Prepare eggs * Cook custard * Prepare rice, soup
DEFROST/ MEDIUM LOW	40% (280W)	* All thawing * Melt butter and chocolate * Cook less tender cuts of meat
LOW	20% (140W)	* Soften butter & cheese * Soften ice cream * Raise yeast dough

CHILD LOCK

This is a unique safety feature that prevents unwanted oven operation such as used by children. Once the child lock is set, you can't input any key.

To set the child lock

1. Press **STOP/CLEAR**.

L

2. Press and hold **STOP/CLEAR** until L appears in the display and two beeps are heard.

To cancel the child lock

Press and hold **STOP/CLEAR** until L disappears in the display. The time of day returns to the display window.

AUTO COOK

AUTO COOK allows you to cook most of your favorite food easily by selecting the food type and entering the weight of the food by pressing the **MORE/LESS** key.

CATEGORY	Press AUTO COOK
JACKET POTATO	1 time
FRESH VEGETABLE	2 times
FROZEN VEGETABLE	3 times

Example: I will show you how to cook 0.5 kg of jacket potato.



1. Press **STOP/CLEAR**.
* Place **POTATO** in the oven and close the door.



2. Press **AUTO COOK**.
"AC-1" appears on the display.



3. Select desired weight of potato.
Press **MORE** key five times to enter 0.5kg.

4. Press **START**.

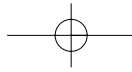

Operating Instructions

AUTO COOK CHART

CATEGORY	WEIGHT LIMIT	UTENSIL	FOOD TEMP.	INSTRUCTIONS
1. JACKET POTATO	0.1 kg ~ 1.0 kg	-	Room	Choose medium sized potatoes 170 -200g. Wash and dry potatoes. Pierce the potatoes several times with fork. Place the potatoes on the glass turntable. Adjust weight and press start. After cooking, remove the potatoes from the oven. Let stand covered with foil for 5 minutes.
2. FRESH VEGETABLE	0.2 kg ~ 0.8 kg	Microwave-safe bowl	Room	Place vegetables in a microwave-safe bowl. Add water. Cover with wrap. After cooking, stir and allow to stand for 2 minutes. Add amount of water according to the quantity. ** 0.2kg - 0.4kg : 2 Tablespoon ** 0.5kg - 0.8kg : 4 Tablespoon
3. FROZEN VEGETABLE	0.2 kg ~ 0.8 kg	Microwave-safe bowl	Frozen	Place vegetables in a microwave-safe bowl. Add water. Cover with wrap. After cooking, stir and allow to stand for 2 minutes. Add amount of water according to the quantity. ** 0.2kg - 0.4kg : 2 Tablespoon ** 0.5kg - 0.8kg : 4 Tablespoon

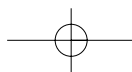

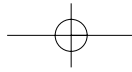

Operating Instructions

AUTO WEIGHT DEFROST

Four defrost sequences are preset in the oven. The defrost feature provides you with the best defrosting method for frozen foods. The cooking guide will show you which defrost sequence is recommended for the food you are defrosting. With the Auto Defrost feature, the oven automatically sets the defrosting time and power levels for you. The oven automatically determines required defrosting times for each food item according to the weight you enter.

For added convenience, the Auto Defrost includes a built-in beep mechanism that reminds you to check, turn over, separate, or rearrange as recommended in the Auto Defrosting AUTO DEFROST GUIDE.

Four different defrosting levels are provided.

- 1 **MEAT**
- 2 **POULTRY**
- 3 **FISH**
- 4 **BREAD**

NOTE:

When you touch the **START** pad, the display changes to defrost time count down. The oven will beep twice during the **DEFROST** cycle. At each beep, open the door and turn, separate, or rearrange the food. Remove any portions that have thawed. Return frozen portions to the oven and touch **START** to resume the defrost cycle. The oven will not **STOP** during the **BEEP** unless the door is opened.

- * For best results, remove fish, shellfish, meat, and poultry from its original closed paper or plastic package (wrapper). Otherwise, the wrap will hold steam and juice close to the foods, which can cause the outer surface of the foods to cook.
- * Place foods in a shallow glass baking dish or on a microwave roasting rack to catch drippings.
- * Food should still be somewhat icy in the center when removed from the oven.

Example: To defrost 1.4 Kg of frozen poultry, select Meat menu, enter the weight, and press START

1. Press **STOP/CLEAR**.



2. Press **AUTO DEFROST** Twice.



3. Press **MORE** fourteen times to enter 1.4 Kg.



4. Press **START**.
Defrosting starts.

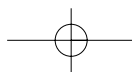

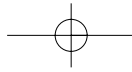

Operating Instructions

AUTO WEIGHT DEFROST GUIDE

- * Food to be defrosted should be in a suitable microwave proof container and place uncovered on the glass turntable.
- * If necessary, shield small areas of meat or poultry with flat pieces of aluminum foil. This will prevent thin areas becoming warm during defrosting. Ensure the foil does not touch the oven walls.
- * Separate items like minced meat, chops, sausages and bacon as soon as possible.
- * When BEEP, at this point remove the food from the microwave oven, turn the food over and return to the microwave oven. Press start to continue. At the end of the program, remove the food from the microwave oven, cover with foil and allow to stand until completely thawed. To thaw completely, for example joints of meat and whole chickens should STAND for a minimum of 1 hour before cooking.

CATEGORY	WEIGHT LIMIT	UTENSIL	FOOD
Meat Poultry Fish	0.1 – 4.0 kg	Microwave ware (Flat plate)	<p>Meat Minced beef, Fillet steak, Cubes for stew, Sirloin steak, Pot roast, Rump roast, Beef burger Lamp chops, Rolled roast, Sausage, Cutlets(2cm)</p> <p>Turn food over at beep. After defrosting, let stand for 5-15 minutes.</p> <p>Poultry Whole chicken, Legs, Breasts, Turkey breasts(under 2.0kg)</p> <p>Turn food over at beep. After defrosting, let stand for 20-30 minutes.</p> <p>Fish Filletts, Steaks, Whole fish, Sea foods</p> <p>Turn food over at beep. After defrosting, let stand for 10-20 minutes.</p>
Bread	0.1 – 0.5 kg	Paper towel or flat plate	<p>Sliced bread, Buns, Baguette, etc. Separate slices and place between paper towel or flat plate.</p> <p>Turn food over at beep. After defrosting, let stand for 1-2 minutes.</p>

QUICK DEFROST

Use this function to thaw only 0.5kg of Minced meat very quickly.

This will require a standing time to allow the center to thaw. In the following example will show you how to defrost 0.5kg of forzen minced meat.

1. Press **STOP/CLEAR**.
Weight the food that you are about to defrost. Be certain to remove any metallic ties or wraps; then place the food in your oven and close the oven door.
2. Press **Quick Defrost** to select the **MEAT** defrosting programme.
The oven will starts automatically.

During defrosting your oven will "BEEP", at which point open the oven door, turn food over and separate to ensure even thawing. Remove any portions that have thawed or shield them to help slow down thawing. After checking close the oven door and press **START** to resume defrosting.

Your oven will not stop defrosting (even when the beep sounded) unless the door is opened.

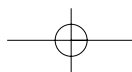

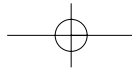

Heating or Reheating Guide

To heat or reheat successfully in the microwave, it is important to follow several guidelines. Measure the amount of food in order to determine the time needed to reheat. Arrange the food in a circular pattern for best results. Room temperature food will heat faster than refrigerated food. Canned foods should be taken out of the can and placed in a microwavable container. The food will be heated more evenly if covered with a microwavable lid or plastic wrap, vented. Remove cover carefully to prevent steam burns. Use the following chart as a guide for reheating cooked food.

Items	Cook time (at HIGH)	Special Instructions
Sliced meat 3 slices (0.5cm thick)	1~2 minutes	Place sliced meat on microwavable plate. Cover with plastic wrap and vent. * Note: Gravy or sauce helps to keep meat juicy.
Chicken pies 1 breast 1 leg and thigh	2~3 1/2 minutes 1 1/2~ 3 minutes	Place chicken pieces on microwavable plate. Cover with plastic wrap and vent.
Fish fillet (170~230 g.)	2~ 4 minutes	Place fish on microwavable plate. Cover with plastic wrap and vent.
Lasagna 1 serving (300g.)	4~6 minutes	Place lasagna on microwavable plate. Cover with plastic wrap and vent.
Casserole 1 cup 4 cups	1~3 1/2 minutes 5~8 minutes	COOK covered in microwavable casserole. Stir once halfway through cooking.
Casserole cream or cheese 1 cup 4 cups	1 1/2~3 minutes 3 1/2~5 1/2 minutes	COOK covered in microwavable casserole. Stir once halfway through cooking.
Sloppy Joe or Barbecued beef 1 sandwich (1/2 cup meat filling) without bun	1~2 1/2 minutes	Reheat filling and bun separately. Cook filling covered in microwavable casserole. Stir once. Heat bun as directed in chart below.
Mashed potatoes 1 cup 4 cups	1 1/2~3 minutes 5~8 minutes	COOK covered in microwavable casserole. Stir once halfway through cooking.
Baked beans 1 cup	1 1/2~3 minutes	COOK covered in microwavable casserole. Stir once halfway through cooking.
Ravioli or pasta in sauce 1 cup 4 cups	2 1/2~4 minutes 7 1/2~11 minutes	COOK covered in microwavable casserole. Stir once halfway through cooking.
Rice 1 cup 4 cups	1 1/2~3 1/2 minutes 4~6 1/2 minutes	COOK covered in microwavable casserole. Stir once halfway through cooking.
Sandwich roll or bun 1 roll	15~30 seconds	Wrap in paper towel and place on glass microwavable rack.
Vegetables 1 cup 4 cups	1 1/2~4 minutes 5~8 minutes	COOK covered in microwavable casserole. Stir once halfway through cooking.
Soup 1 serving(230 g.)	1 1/2~2 1/2 minutes	COOK covered in microwavable casserole. Stir once halfway through cooking.

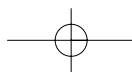

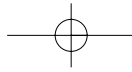

Fresh Vegetable Chart

Vegetable	Amount	Cook time at HIGH	Instructions	Standing Time
Artichokes (230g. each)	2 medium	5~8minutes	Trim. Add 2 tsp water and 2 tsp juice. Cover.	2-3 minutes
	4 medium	10~13minutes		
Asparagus, Fresh, Spears	450g	3~7minutes	Add 1/2 cup water. Cover.	2-3 minutes
Beans, Green & Wax	450g	8~12minutes	Add 1/2 cup water in 1- 1/2 litre. casserole. Stir halfway through cooking.	2-3 minutes
Beets, Fresh	450g	14~18minutes	Add 1/2 cup water in 1- 1/2 litre. covered casserole. Rearrange halfway through cooking.	2-3 minutes
Broccoli, Fresh, Spears	450g	5~9minutes	Place broccoli in baking dish. Add 1/2 cup water.	2-3 minutes
Cabbage, Fresh, Chopped	450g	6~8minutes	Add 1/2 cup water in 1- 1/2 litre. covered casserole. Stir halfway through cooking.	2-3 minutes
Carrots, Fresh, Sliced	2 cups	3~6minutes	Add 1/4 cup water in 1 litre. covered casserole. Stir halfway through cooking.	2-3 minutes
Cauliflower, Fresh, Whole	450g	7~11minutes	Trim. Add 1/4 cup water in 1litre. covered casserole. Stir halfway through cooking.	2-3 minutes
Fresh, Flowerettes	2 cups	3~5minutes	Slice. Add 1/2cup water in 1-1/2litre. covered casserole.	2-3 minutes
Celery, Fresh, Sliced	4 cups	7~9minutes	Stir halfway through cooking	
Corn, Fresh	2 ears	5~9minutes	Husk. Add 2 tbsp water in 1-1/2 litre. baking dish. Cover.	2-3 minutes
Mushrooms, Fresh, Sliced	230g	2~3 1/2minutes	Place mushrooms in 1-1/2 litre. covered casserole. Stir halfway through cooking.	2-3 minutes
Parsnips, Fresh, Sliced	450g	4~8minutes	Add 1/2 cup water in 1-1/2 litre. covered casserole. Stir halfway through cooking.	2-3 minutes
Peas, Green, Fresh	4 cups	7~10minutes	Add 1/2 cup water in 1-1/2 litre. covered casserole. Stir halfway through cooking.	2-3minutes
Sweet Potatoes Whole Baking (6-8 oz. each)	2 medium	5~10minutes	Pierce potatoes several times with fork.	2-3 minutes
	4 medium	7~13minutes	Place on 2 paper towels. Turn over halfway through cooking.	2-3 minutes
White potatoes, Whole Baking (6-8 oz. each)	2 potatoes	5~8minutes	Pierce potatoes several times with fork.	2-3 minutes
	4 potatoes	9~15minutes	Place on 2 paper towels. Turn over halfway through cooking	2-3 minutes
Spinach, Fresh, Leaf	450g	5~8minutes	Add 1/2 cup water in 2 litre. covered casserole.	2-3 minutes
Squash, Acorn or Butternut, Fresh	1 medium	7~9minutes	Cut squash in half. Remove seeds. Place in 8X8-inch baking dish. Cover.	2-3 minutes
Zucchini, Fresh, Sliced	450g	5~8minutes	Add 1/2 cup water in 1-1/2 litre. covered casserole. Stir halfway through cooking.	2-3 minutes
Zucchini, Fresh, Whole	450g	7~10minutes	Pierce. Place on 2 paper towels. Turn zucchini over and rearrange halfway through cooking.	2-3 minutes

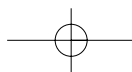

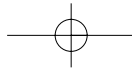

Other Helpful Instructions

For Best Results:

1. When determining the time for a particular food, begin by using minimum time and checking condition occasionally. It is easy to overcook food because microwaves cook very quickly.
2. Small quantities of food or foods with low water content may dry out and become hard if cooked too long.
3. Do not use the oven for drying kitchen towels or paper products. They may burn.
4. Break eggs before cooking them in the microwave.
5. For food items such as apples, potatoes, egg yolks, chicken livers, etc., be sure to pierce the skin or membrane to prevent bursting of the food while cooking in the oven.

Defrosting Frozen Foods:

1. Foods that have been frozen can be placed directly in the oven for thawing. (Be certain to remove any metallic ties or wraps.)
2. Defrost according to the Defrost Guide found in this Manual.
3. For areas of the food thawing faster than others, shield if necessary.
This helps slow down or stop the defrosting process.
4. Some foods should not be completely thawed before cooking. For example, fish cooks so quickly that it is sometimes better to begin cooking while still slightly frozen.
5. It may be necessary to increase or decrease the cooking time in some recipes, depending on the starting temperature of the foods.

NOTE:

Air from the vent may become warm during cooking. This is normal.

Browning:

There are a few foods which are not cooked long enough in the microwave oven to brown and may need additional colour.

Coatings such as SHAKE & BAKER®, paprika, and browning agents such kitchen bouquet® or Worcestershire sauce may be used on chops, meat patties or chicken parts.

Roasts, poultry or ham, cooked for 10-15 minutes or longer, will brown nicely without extra additives.

Cooking Utensils:

1. Most glass, ceramic glass and heat resistant glassware utensils are microwave-safe.
2. Most paper napkins, towels, plates, cups, cartons, and cardboard are convenient utensils. Some recycled paper products may contain impurities which could cause arcing or fires when used in the microwave oven.
3. Some plastic dishes, cups, containers, and wraps may be used in the microwave oven. Follow the manufacturer's instructions or information given in the cooking guide when using plastics in the microwave oven.
4. Metal utensils and utensils with metallic trim should not be used in the microwave oven.

To Clean Your Oven:

1. Keep the inside of the oven clean.
Food spatters or spilled liquids stick to oven walls and between seal and door surface. It is best to wipe up spillovers with a damp cloth right away. Crumbs and spillovers will absorb microwave energy and lengthen cooking times. Use a damp cloth to wipe out crumbs that fall between the door and the frame. It is important to keep this area clean to assure a tight seal. Remove greasy spatters with a soapy cloth then rinse and dry. Do not use harsh detergent or abrasive cleaners. The glass tray can be washed by hand or in the dishwasher.
2. Keep the outside of the oven clean.
Clean the outside of your oven with soap and water then with clean water and dry with a soft cloth or paper towel. To prevent damage to the operating parts inside the oven, the water should not be allowed to seep into the ventilation openings. To clean control panel, open the door to prevent oven from accidentally starting, and wipe with a damp cloth followed immediately by a dry cloth. Press STOP/CLEAR after cleaning.
3. If steam accumulates inside or around the outside of the oven door, wipe the panels with a soft cloth. This may occur when the microwave oven is operated under high humidity conditions and in no way indicates a malfunction of the unit.
4. The door and door seals should be kept clean. Use only warm, soapy water, rinse then dry thoroughly. DO NOT USE ABRASIVE MATERIALS, SUCH AS CLEANING POWDERS OR STEEL AND PLASTIC PADS. Metal parts will be easier to maintain if wiped frequently with a damp cloth.
5. Do not use any steam cleaner.

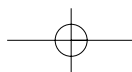

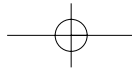

Safety Precautions

1. Do not attempt to tamper with, or make any adjustments or repairs to the door, control panel, safety interlock switches or any other part of the oven. Repairs should only be undertaken by a qualified service technician.
 2. Do not operate the oven when empty. It is best to leave a glass of water in the oven when not in use. The water will safely absorb all microwave energy, if the oven is accidentally started.
 3. Do not dry clothes in the microwave oven, which may become carbonized or burned if heated too long.
 4. Do not cook food wrapped in paper towels, unless your cook book contains instructions, for the food you are cooking.
 5. Do not use newspaper in place of paper towels for cooking.
 6. Do not use wooden containers. They may heat-up and char.
Do not use metal containers or crockery containers which have metallic (e.g. gold or silver) inlays. Always remove metal twist ties.
Metal objects in the oven may arc, which can cause serious damage.
 7. Do not operate the oven with a kitchen towel, a napkin or any other obstruction between the door and the front edges of the oven, which may cause microwave energy leakage.
 8. Do not use recycled paper products since they may contain impurities which may cause sparks and/or fires when used in cooking.
 9. Do not rinse the turntable by placing it in water just after cooking.
This may cause breakage or damage.
 10. Small amounts of food require shorter cooking or heating time. If normal times are allowed they may overheat and burn.
 11. Be certain to place the oven so the front of the door is 8cm or more behind the edge of the surface on which it is placed, to avoid accidental tipping of the appliance.
 12. Before cooking, pierce the skin of potatoes, apples or any such fruit or vegetable.
 13. Do not cook eggs in their shell. Pressure will build up inside the egg which will burst.
 14. Do not attempt deep fat frying in your oven.
 15. Remove the plastic wrapping from food before cooking or defrosting.
Note though that in some cases food should be covered with plastic film, for heating or cooking, as detailed in microwave cook books.
 16. The oven must never be used if the door seal is not in good working order.
 17. When liquids are cooked in microwave units, they may be overheated above their boiling point without visible bubbling. When the container is removed, the shock may cause the sudden for motion of steam bubbles. A fountain of hot liquid can spring up out of the container explosively.
 18. If smoke is observed keep the oven door closed and switch off or disconnect the oven from the power supply.
 19. When food is heated or cooked in disposable containers of plastic, paper or other combustible materials look at the oven frequently to check if the food container is deteriorating.
 20. This connection may be achieved by having the plug accessible or by incorporation a switch in the fixed wiring in accordance with the wiring rules.
 21. Do not use harsh abrasive cleaners or sharp metal scrapers to clean the oven door glass since they can scratch the surface, which may result in shattering of the glass.
 22. The temperature of accessible surfaces may be high when the appliance is operating. Ther door or the outer surface may get hot when the appliance is operating. The surfaces are liable to get hot during use.
- WARNING**—Please ensure cooking times are correctly set as over cooking may result in FIRE and subsequent DAMAGE to the OVEN.

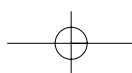

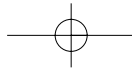

Questions And Answers

Q What's wrong when the oven light will not glow?

- A There may be several reasons why the oven light will not glow.
- Light bulb has blown.
 - Door is not closed.

Q Does microwave energy pass through the viewing screen in the door?

- A No. The holes, or ports, are made to allow light to pass; they do not let microwave energy through.

Q Why does the beep tone sound when a pad on the Control Panel is touched?

- A The beep tone sounds to assure that the setting is being properly entered.

Q Will the microwave oven be damaged if it operates empty?

- A Yes. Never run it empty or without the glass tray.

Q Why do eggs sometimes pop?

- A When baking, frying, or poaching eggs, the yolk may pop due to steam build up inside the yolk membrane. To prevent this, simply pierce the yolk before cooking. Never microwave eggs in the shell.

Q Why is standing time recommended after microwave cooking is over?

- A After microwave cooking is finished, food keeps on cooking during standing time. This standing time finishes cooking evenly throughout the food. The amount of standing time depends on the density of the food.

Q Is it possible to pop corn in a microwave oven?

- A Yes, if using one of the two methods described below:

- (1) Popcorn-popping utensils designed specifically for microwave cooking.
- (2) Prepackaged commercial microwave popcorn that contains specific times and power outputs needed for an acceptable final product.

FOLLOW EXACT DIRECTIONS GIVEN BY EACH MANUFACTURER FOR THEIR POPCORN PRODUCT. DO NOT LEAVE THE OVEN UNATTENDED WHILE THE CORN IS BEING POPPED. IF CORN FAILS TO POP AFTER THE SUGGESTED TIMES, DISCONTINUE COOKING. OVERCOOKING COULD RESULT IN THE CORN CATCHING FIRE.

CAUTION

NEVER USE A BROWN PAPER BAG FOR POPPING CORN. NEVER ATTEMPT TO POP LEFTOVER KERNELS.

Q Why doesn't my oven always cook as fast as the cooking guide says?

- A Check your cooking guide again to make sure you've followed directions correctly, and to see what might cause variations in cooking time. Cooking guide times and heat settings are suggestions, chosen to help prevent overcooking, the most common problem in getting used to a microwave oven. Variations in the size, shape, weight and dimensions of the food require longer cooking time. Use your own judgement along with the cooking guide suggestions to test food condition, just as you would do with a conventional cooker.

