



**ENGLISH**

**DV397H**



## Safety Precaution



**CAUTION:** TO REDUCE THE RISK OF ELECTRIC SHOCK. DO NOT REMOVE COVER (OR BACK). NO USER-SERVICEABLE PARTS INSIDE. REFER SERVICING TO QUALIFIED SERVICE PERSONNEL.

 This lightning flash with arrowhead symbol within an equilateral triangle is intended to alert the user to the presence of uninsulated dangerous voltage within the product's enclosure that may be of sufficient magnitude to constitute a risk of electric shock to persons.

 The exclamation point within an equilateral triangle is intended to alert the user to the presence of important operating and maintenance (servicing) instructions in the literature accompanying the product.

**WARNING:** TO PREVENT FIRE OR ELECTRIC SHOCK HAZARD, DO NOT EXPOSE THIS PRODUCT TO RAIN OR MOISTURE.

**WARNING:** Do not install this equipment in a confined space such as a book case or similar unit.

**CAUTION:** Do not block any ventilation openings. Install in accordance with the manufacturer's instructions. Slots and openings in the cabinet are provided for ventilation and to ensure reliable operation of the product and to protect it from over heating. The openings should be never be blocked by placing the product on a bed, sofa, rug or other similar surface. This product should not be placed in a built-in installation such as a bookcase or rack unless proper ventilation is provided or the manufacturer's instruction has been adhered to.

**CAUTION:** This product employs a Laser System.

To ensure proper use of this product, please read this owner's manual carefully and retain it for future reference. Should the unit require maintenance, contact an authorized service center.

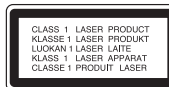

Use of controls, adjustments or the performance of procedures other than those specified herein may result in hazardous radiation exposure.

To prevent direct exposure to laser beam, do not try to open the enclosure.

Visible laser radiation when open. DO NOT STARE INTO BEAM.

**CAUTION:** The apparatus should not be exposed to water (dripping or splashing) and no objects filled with liquids, such as vases, should be placed on the apparatus.

### CAUTION concerning the Power Cord

**Most appliances recommend they be placed upon a dedicated circuit;**







That is, a single outlet circuit which powers only that appliance and has no additional outlets or branch circuits. Check the specification page of this owner's manual to be certain. Do not overload wall outlets. Overloaded wall outlets, loose or damaged wall outlets, extension cords, frayed power cords, or damaged or cracked wire insulation are dangerous. Any of these conditions could result in electric shock or fire. Periodically examine the cord of your appliance, and if its appearance indicates damage or deterioration, unplug it, discontinue use of the appliance, and have the cord replaced with an exact replacement part by an authorized service center.

Protect the power cord from physical or mechanical abuse, such as being twisted, kinked, pinched, closed in a door, or walked upon. Pay particular attention to plugs, wall outlets, and the point where the cord exits the appliance. To disconnect power from the mains, pull out the mains cord plug. When installing the product, ensure that the plug is easily accessible.

**Contents**

Safety Precaution ..... 2  
 Types of Playable Discs ..... 3  
 Hooking up the unit ..... 4-5  
 Remote Control ..... 6  
 Main Unit ..... 7  
 Adjust the settings ..... 8-9  
 Displaying Disc Information ..... 9  
 Playing a Disc ..... 10-11  
 Playing a DivX movie file ..... 11  
 Listening to Music Disc or files ..... 12  
 Viewing photo files ..... 12-13  
 Using the Karaoke ..... 13  
 Using an USB Flash Drive ..... 13  
 Language Codes ..... 14  
 Area Codes ..... 14  
 Troubleshooting ..... 15  
 Specifications ..... 15

**Types of Playable Discs**

Type	Logo
<b>DVD-VIDEO:</b> Discs such as movies that can be purchased or rented.	
<b>DVD-R:</b> Video mode and finalized only	
<b>DVD-RW:</b> VR mode, Video mode and finalized only	
<b>DVD+R:</b> Video mode only	
<b>DVD+RW:</b> Video mode only	
<b>Video CD (VCD/SVCD):</b> Video CDs or CD-R/CD-RW in Video CD/Super Video CD format.	
<b>Audio CD:</b> Music CDs or CD-R/CD-RW in music CD format that can be purchased.	

This unit plays DVD±R/RW and CD-R/RW that contains audio titles, DivX, MP3, WMA and/or JPEG files. Some DVD±RW/DVD±R or CD-RW/CD-R cannot be played on this unit due to the recording quality or physical condition of the disc, or the characteristics of the recording device and authoring software.

**About the  Symbol Display**

“  ” may appear on your TV display during operation and indicates that the function explained in this owner’s manual is not available on that disc.

**Regional Codes**

This unit has a regional code printed on the rear of the unit. This unit can play only DVD discs labeled same as the rear of the unit or “ALL”.

- Most DVD discs have a globe with one or more numbers in it clearly visible on the cover. This number must match your unit’s regional code or the disc cannot play.
- If you try to play a DVD with a different regional code from your player, the message “Check Regional Code” appears on the TV screen.

**Copyrights**

It is forbidden by law to copy, broadcast, show, broadcast via cable, play in public, or rent copyrighted material without permission. This product features the copy protection function developed by Macrovision. Copy protection signals are recorded on some discs. When recording and playing the pictures of these discs picture noise will appear. This product incorporates copyright protection technology that is protected by method claims of certain U.S. patents and other intellectual property rights owned by Macrovision Corporation and other rights owners. Use of this copyright protection technology must be authorized by Macrovision Corporation, and is intended for home and other limited viewing uses only unless otherwise authorized by Macrovision Corporation. Reverse engineering or disassembly is prohibited.

CONSUMERS SHOULD NOTE THAT NOT ALL HIGH DEFINITION TELEVISION SETS ARE FULLY COMPATIBLE WITH THIS PRODUCT AND MAY CAUSE ARTIFACTS TO BE DISPLAYED IN THE PICTURE. IN CASE OF 525 PROGRESSIVE SCAN PICTURE PROBLEMS, IT IS RECOMMENDED THAT THE USER SWITCH THE CONNECTION TO THE ‘STANDARD DEFINITION’ OUTPUT. IF THERE ARE QUESTIONS REGARDING OUR TV SET COMPATIBILITY WITH THIS MODEL 525p UNIT, PLEASE CONTACT OUR CUSTOMER SERVICE CENTER.

Manufactured under license from Dolby Laboratories. “Dolby” and the double-D symbol are trademarks of Dolby Laboratories.

HDMI, the HDMI logo and High-Definition Multimedia Interface are trademarks or registered trademarks of HDMI licensing LLC.

## Hooking up the unit

### Audio and Video Connection

The unit Audio/Video jacks are color coded (yellow for video, red for right audio and white for left audio). If your TV has only one input for audio (mono), connect it to the left (white) audio jack on the unit.

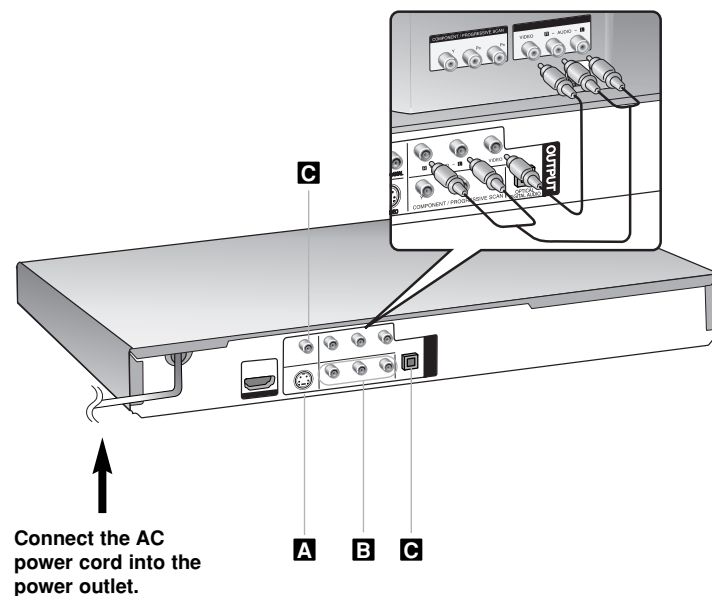

4

## Hooking up the unit - more you can do

### A S-Video connection

Connect the S-VIDEO OUTPUT jack on the unit to the corresponding input jacks on your TV using a S-Video cable.

You will still need to connect the left and right audio cables to the TV, or digital audio cable to your stereo.

### B Component Video Connections

Connect the COMPONENT/PROGRESSIVE SCAN OUTPUT jacks on the unit to the corresponding input jacks on your TV using a YPbPr cable.

You will still need to connect the left and right audio cables to the TV, or digital audio cable to your stereo.

### Resolution Setting

- You can change the resolution for component video output. Press RESOLUTION repeatedly to select the desired resolution - 480i, 480p, 720p, 1080i, 1080p.
- For 720p and 1080p resolution on the component video output, only non-copy protected discs can be played back. If the disc is copy protected, it will be displayed at the 480p resolution.
- Depending on your TV, some of the resolution settings may result in the picture disappearing or an abnormal picture appearing. In this case, press RESOLUTION repeatedly until the picture re-appears.

### C Digital Audio Output Connection

Connect one of the unit's DIGITAL AUDIO OUTPUT jacks (OPTICAL or COAXIAL) to the corresponding jack on your amplifier.

- If the audio format of the digital output does not match the capabilities of your amplifier, the amplifier will produce a strong, distorted sound or no sound at all.
- To see the audio format of the current disc in the on-screen display, press AUDIO.
- This unit does not perform internal (2 channel) decoding of a DTS sound track. To enjoy DTS multi channel surround, you must connect this unit to a DTS compatible amplifier via one of this unit's digital audio outputs

## Hooking up the unit

### HDMI Connection

Connect the HDMI OUTPUT jack on the unit to the HDMI input jack on an HDMI compatible TV using an HDMI cable.

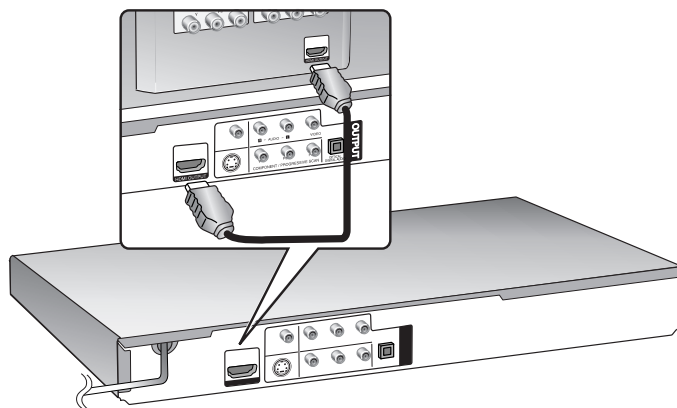

## Hooking up the unit - more you can do

### Resolution Setting

You can change the resolution for HDMI output. Press RESOLUTION repeatedly to select the desired resolution - 480i, 480p, 720p, 1080i, 1080p.

### Note for 1080p resolution

The unit is able to provide a 1080p full HD image to most 1080p-capable TVs in the market today. However, there are some 1080p TVs available from certain companies that are limited in the types of 1080p images that can be accepted. Specifically, 1080p-capable TVs that don't accept images in 60Hz can't display an image from this unit.

### About HDMI

HDMI (High Definition Multimedia Interface) supports both video and audio on a single digital connection for use with DVD Players, Set-Top Boxes, and other AV devices. HDMI was developed to provide the technologies of HDCP (High-bandwidth Digital Content Protection). HDCP is used to protect digital content transmitted and received.

HDMI has the capability to support standard, enhanced or high-definition video plus standard to multi-channel surround-sound audio, HDMI features include uncompressed digital video, a bandwidth of up to 5 gigabytes per second, one connector (instead of several cables and connectors), and communication between the AV source and AV devices such as DTVs.

### Notes on HDMI connection

- If your TV is not capable of handling 96 kHz sampling frequency, set the [Sampling Freq.] option to [48 kHz] on the setup menu (See page 8).
- If your TV is not equipped with Dolby Digital and MPEG decoder, set the [Dolby Digital and [MPEG] options to [PCM] on the setup menu (See page 8).
- Depending on your TV, some of the resolution settings may result in the picture disappearing or an abnormal picture appearing. In this case, press RESOLUTION repeatedly until the picture re-appears.
- Changing the resolution when the unit is connected with HDMI connector may result in malfunctions. To solve the problem, turn off the unit and then turn it on again.
- When you connect a HDMI or DVI compatible device make sure of the following:
  - Try switching off the HDMI/DVI device and this unit. Next, switch on the HDMI/DVI device and leave it for around 30 seconds, then switch on this unit.
  - The connected device's video input is set correctly for this unit.
  - The connected device is compatible with 720X480i, 720X480p, 1280X720p, 1920X1080i or 1920X1080p video input.
  - The 1080p, 720p and 480p resolutions are the progressive scan applied resolution
- Not all HDCP-compatible DVI devices will work with this unit.
  - The picture will not be displayed properly with non-HDCP device.



## Main Unit

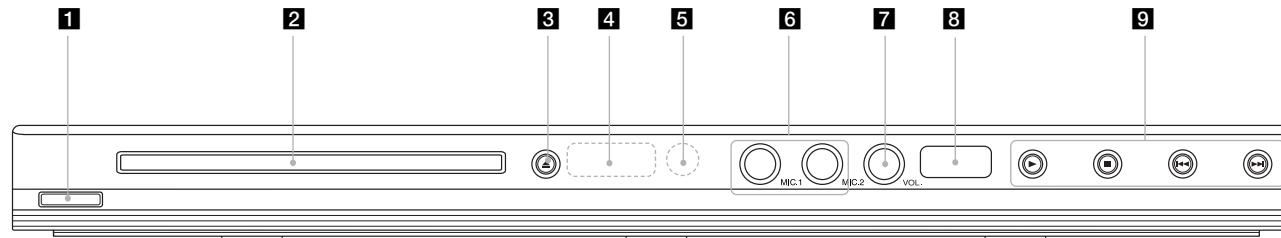

- 1** **⏻/⏻ (Power)**  
Turn the unit ON or OFF.
- 2** **Disc Tray**  
Insert a disc here.
- 3** **⏏ (Open / Close)**  
Opens or closes the disc tray.
- 4** **Display window**  
Shows the current status of the unit
- 5** **Remote sensor**  
Point the remote control here.
- 6** **MIC.**  
Connect a microphone.

- 7** **VOL.**  
Adjust microphone volume.
- 8** **USB Port**  
Connect an USB Flash Drive.
- 9**
  - **▶ (Play)**  
Starts playback.
  - **■ (Stop)**  
Stops playback.
  - **⏮ (Skip)**  
Returns to the beginning of current chapter or track or go to the previous chapter or track.
  - **⏭ (Skip)**  
Go to next chapter or track.

## Adjust the settings

	ON REMOTE
1 Display setup menu:	SETUP
2 Select a desired option on the first level:	▲▼
3 Move to second level:	▶
4 Select a desired option on the second level:	▲▼
5 Move to third level:	▶
6 Change the setting:	▲▼ / ENTER

## Adjust the settings - more you can do

### When you turn on for the first time

The menu for a language selection will appear when you turn on the unit for the first time. You must select a language to use the unit. Use ▲▼◀▶ to select a language then press **ENTER** and the confirm menu will appear. Use ◀▶ to select [Enter] then press **ENTER**.

### Adjust the language settings

**Menu Language** – Select a language for the Setup menu and on-screen display.

**Disc Audio/Subtitle/Menu** – Select a language for the Disc Audio/Subtitle/Menu.

[Original]: Refers to the original language in which the disc was recorded.

[Other]: To select another language, press number buttons then **ENTER** to enter the corresponding 4-digit number according to the language code list. (see page 14) If you make a mistake while entering number, press **CLEAR** to delete numbers then correct it.

[Off] (for Disc Subtitle): Turn off Subtitle.

### Adjust the display settings

**TV Aspect** – Select which screen aspect to use based on the shape of your TV screen.

[4:3]: Select when a standard 4:3 TV is connected.

[16:9]: Select when a 16:9 wide TV is connected.

**Display Mode** – If you selected 4:3, you'll need to define how you would like widescreen programs and films to be displayed on your TV screen.

[Letterbox]: This displays a widescreen picture with black bands at the top and bottom of the screen.

[Panscan]: This fills the entire 4:3 screen, cropping the picture as necessary.

### Adjust the audio settings

**Dolby Digital / DTS / MPEG** – Selects the type of digital audio signal when using the DIGITAL AUDIO OUTPUT jack.

[Bitstream]: Select this when you connect this unit's DIGITAL AUDIO OUTPUT jack to an amplifier with a built-in Dolby Digital, DTS or MPEG decoder.

[PCM] (for Dolby Digital / MPEG): Select this when you connect this unit's DIGITAL AUDIO OUTPUT jack to an amplifier without a built-in Dolby Digital or MPEG decoder.

[Off] (for DTS): Select this when you connect this unit's DIGITAL AUDIO OUTPUT jack to an amplifier without a built-in DTS decoder.

**Sample Freq. (Frequency)** – Selects the sampling frequency of the audio signal.

[48 KHz]: The audio signals are always converted to 48 kHz.

[96 KHz]: The audio signals are output in their original format.

**DRC (Dynamic Range Control)** – Make the sound clear when the volume is turned down (Dolby Digital only). Set to [On] for this effect.

**Adjust the lock settings**

You must set the [Area Code] option to use the lock options. Select [Area Code] option then press **▶**. Enter a 4-digit password then press **ENTER**. Enter it again then press **ENTER** to verify. If you make a mistake while entering number, press **CLEAR** then correct it.

If you forget your password you can reset it. Display setup menu then input the 6-digit number "210499". The "P CLR" appear in the display window and the password is deleted.

**Rating** – Select a rating level. The lower the level, the stricter the rating. Select [Unlock] to deactivate the rating.

**Password** – Sets or changes the password for lock settings.

[New]: Enter a new 4-digits password using the numerical buttons then press **ENTER**. Enter the password again to confirm.

[Change]: Enter the new password twice after entering the current password.

**Area Code** – Select a code for a geographic area as the playback rating level. This determines which area's standards are used to rate DVDs controlled by the parental lock. (See page 14)

**Adjust the others settings**

**PBC (Playback Control)** – Playback control provides special navigation features that are available on some Video CDs. Select [On] to use this feature.

**B.L.E. (Black Level Expansion)** – To select the black level of playback pictures. Set your preference and monitor's ability.

**DivX(R) VOD** – We provide you with the DivX® VOD (Video On Demand) registration code that allows you to rent and purchase videos using the DivX® VOD service. For more information, visit [www.divx.com/vod](http://www.divx.com/vod). Press **ENTER** when [Select] icon is highlighted and you can view the registration code of the unit. All the downloaded videos from DivX® VOD can only be played back on this unit.

**Score** – You can view the score after singing a song using microphone. Select [On] to use this feature. The score appears only when a chapter, title or track is fully finished. Fanfare sounds with high score.

**Displaying Disc Information**

	ON REMOTE
1 Press <b>DISPLAY</b> :	<b>DISPLAY</b>
2 Select a item:	<b>▲▼</b>
3 Adjust the Display menu settings:	<b>◀▶ / ENTER</b>
4 To return the exit:	<b>DISPLAY</b>

**Displaying Disc Information - more you can do**

You can select an item by pressing **▲▼** and change or select the setting by pressing **◀▶**.

	1 / 6	Current title (or track) number/total number of titles (or tracks)
	5 / 42	Current chapter number/total number of chapters
	0:13:45	Elapsed playing time
	1 ENG DVD 3 / 2.1CH	Selected audio language or channel
	OFF	Selected subtitle
	1 / 1	Selected angle/total number of angles

**Symbol Used in this Manual**

	All discs and file listed below		Audio CDs
	DVD and finalized DVD±R/RW		CD-G discs
	Video CDs		MP3 files
	DivX files		WMA files

## Playing a Disc

	ON REMOTE
1 Open the disc tray:	▲ OPEN/CLOSE
2 Insert a Disc:	-
3 Close the disc tray:	▲ OPEN/CLOSE
4 Start playback:	▶ PLAY
5 To stop playback:	■ STOP

## Playing a Disc - more you can do

### Stops the playback

The unit records the stopped point depending on the disc. "■" appears on the screen briefly. Press **PLAY** (▶) to resume playback (from the scene point). If you press **STOP** (■) again or unload the disc ("■" appears on the screen), the unit will clear the stopped point.

(■ = Resume Stop, ■ = Complete Stop) The resume point may be cleared when a button is pressed (for example :POWER, OPEN/CLOSE, etc).

### Playing a DVD or Video CD that has a menu **DVD VCD**

Most DVD or Video CD now have menus which load first before the film begins to play. You can navigate these menus using ▲▼◀▶ or number button to highlight an option. Press **ENTER** to select.

### Playing a DVD VR disc

This unit will play DVD-RW disc that is recorded using the Video Recording (VR) format. When you insert a disc DVD VR disc, the menu will appear on the screen. Use ▲▼ to select a title then press **PLAY** (▶). To display DVD-VR menu, press **DVD MENU** or **TITLE**.

Some DVD-VR disc are made with CPRM data by DVD RECORDER. Player does not support these kinds of discs.

### Skip to the next/previous chapter/track **ALL**

Press **SKIP** (▶▶) to move to the next chapter/track.

Press **SKIP** (◀◀) to return to the beginning of the current chapter/track.

Press **SKIP** (◀◀) twice briefly to step back to the previous chapter/track.

### Pause a playback **ALL**

Press **PAUSE/STEP** (⏸) to pause playback. Press **PLAY** (▶) to continue playback.

### Frame-by-Frame playback **DVD DivX VCD**

Press **PAUSE/STEP** (⏸) repeatedly to play Frame-by-Frame playback.

### Playing repeatedly **ALL**

Press **REPEAT** repeatedly to select an item to be repeated. The current title, chapter or track will be played back repeatedly. To return to normal playback, press **REPEAT** repeatedly to select [Off]. On a Video CD with PBC, you must set PBC to [Off] to use this function. (See page 9)

### Fast forward or fast reverse

**DVD DivX VCD ACD WMA MP3**

Press **SCAN** (◀◀ or ▶▶) to play fast forward or fast reverse during playback. You can change the various playback speed by pressing **SCAN** (◀◀ or ▶▶) repeatedly. Press **PLAY** (▶) to continue play at normal speed.

### Repeating a specific portion (A-B) **DVD DivX VCD ACD**

Press **A-B** at the beginning of the portion you wish to repeat and again at the end of the portion. Your selected portion will be repeated continually. To return to normal playback, press **A-B** to select [Off].

### Selecting a subtitle language **DVD DivX**

During playback, press **SUBTITLE** (☐) repeatedly to select a desired subtitle language.

### Watching from a different angle **DVD**

If the angle indicator appears on the screen for a moment, you can select a different camera angle by pressing **ANGLE** (⌂) repeatedly.

### Hearing a different audio **DVD DivX VCD CD-G**

During playback, press **AUDIO** (⌂) repeatedly to switch between the available audio languages, channels or encoding methods.

### Slow down the playing speed **DivX VCD (Forward only) DVD**

While playback is paused, press **SCAN** (◀◀ or ▶▶) to slow down reverse or forward playback. You can change the various playback speed by pressing **SCAN** (◀◀ or ▶▶) repeatedly. Press **PLAY** (▶) to continue play at normal speed.

**Watching a enlarged video image** **DVD** **DivX** **VCD**

During playback or pause mode, press **ZOOM** repeatedly to select zoom mode. You can move through the zoomed picture using **▲▼◀▶** buttons. Press **CLEAR** to exit.

**Viewing the title menu** **DVD**

Press **TITLE** to display the disc's title menu, if available.

**Viewing the DVD menu** **DVD**

Press **DVD MENU** to display the disc menu, if available.

**Marking a favorite scene** **DVD** **DivX** **VCD**

You can mark positions by pressing **MARKER** at the desired position up to 9 markers. Also you can recall or clear positions by pressing **SEARCH**.

Use **◀** or **▶** to select a desired marker on the [MARKER SEARCH] menu, then press **ENTER** to recall it or **CLEAR** to clear it.

**Starting play from selected time** **DVD** **DivX** **VCD**

Searches for the starting point of entered time code. Press **DISPLAY** then select clock icon. Enter a time then press **ENTER**. For example, to find a scene at 1 hours, 10 minutes, and 20 seconds, enter "11020" and press **ENTER**. If you enter the wrong number, press **CLEAR** to enter again.

**Last Scene Memory** **DVD** **ACD** **VCD 1.1**

This unit memorizes last scene from the last disc that is viewed. The last scene remains in memory even if you remove the disc from the player or switch off the unit. If you load a disc that has the scene memorized, the scene is automatically recalled.

**Screen Saver**

The screen saver appears when you leave the unit in Stop mode for about five minutes. If the Screen Saver is displayed for five minutes, the unit automatically turns itself off.

**Mixed disc or USB Flash Drive – DivX, MP3/WMA and JPEG**

When playing a disc or USB Flash Drive contained with DivX, MP3/WMA and JPEG files together, you can select which menu of files you would like to play by pressing **TITLE**.

**Playing a DivX movie file**

	ON REMOTE
1 Open the disc tray:	▲ OPEN/CLOSE
2 Insert a disc:	-
3 Close the disc tray:	▲ OPEN/CLOSE
4 Select a movie file from the menu:	▲▼, DVD MENU
5 Start playback:	▶ PLAY
6 To stop playback:	■ STOP

**Playing a DivX movie file - more you can do****Changing the character set to display DivX® subtitle correctly**

Press and hold **SUBTITLE** for 3 seconds during playback. The language code will appear. Press **◀▶** to select another language code until the subtitle is displayed properly and then press **ENTER**.

**DivX file requirement**

DivX file compatibility with this player is limited as follows:

- Available resolution size: 720x576 (W x H) pixel
- The file names of DivX and subtitle are limited to 56 characters.
- DivX file extensions: ".avi", ".mpg", ".mpeg"
- Playable DivX subtitle: SubRip (.srt / .txt), SAMI (.smi), SubStation Alpha (.ssa/.txt), MicroDVD (.sub/.txt), SubViewer 2.0 (.sub/.txt), TMLayer (.txt), DVD Subtitle System (.txt), VobSub (\*.sub) ➔ Sub/idx, stream based format
- Playable Codec format: "DIVX3.xx", "DIVX4.xx", "DIVX5.xx", "MP43", "3IVX", "XviD"
- Only the playback function is supported with DivX 6.0 in the unit.
- Playable Audio format: "Dolby Digital", "DTS", "PCM", "MP3", "WMA"
- Sampling frequency: within 8 - 48 kHz (MP3), within 22 - 48 kHz (WMA)
- Bit rate: within 8 - 320 kbps (MP3), within 32 - 256 kbps (WMA), less than 8Mbps (DivX file)
- CD-R/RW, DVD±R/RW Format: ISO 9660
- Maximum Files/Disc: Less than 650 (total number of files and folders)

## Listening to Music Disc or files

	ON REMOTE
1 Open the disc tray:	▲ OPEN/CLOSE
2 Insert a disc:	-
3 Close the disc tray:	▲ OPEN/CLOSE
4 Select a music from the menu:	▲▼, DVD MENU
5 Start playback:	▶ PLAY
6 To stop playback:	■ STOP

## Listening to Music Disc or files - more you can do

### Creating your own program

You can play the contents of a disc in the order you want by arranging the order of the musics on the disc. To add a music(s) on the program list, press

**PROGRAM** to enter the program edit mode (  mark appears on the menu). Select a desired music on the [List] then press **ENTER** to add the music to the program list. Select a music from the program list then press **ENTER** to start programmed playback. To clear a music from the program list, select the music you want to clear then press **CLEAR** in program edit mode. To clear all music from the program list, select [Clear All] then press **ENTER** in program edit mode. The program is cleared when the disc is removed or the unit is turned off.

### Playing an CD-G disc

Once you insert an CD-G disc, a menu appears on the screen. Use ▲▼ to select a track then press **PLAY** ( ▶ ). To display the CD-G menu during playback, press **STOP** ( ■ ) twice. You can display the setup menu by pressing **SETUP** only when CD-G menu appears on the TV screen.

### Displaying file information (ID3 TAG)

While playing a MP3 file containing file information, you can display the information by pressing **DISPLAY** repeatedly.

### MP3/WMA music file requirement

MP3/WMA compatibility with this unit is limited as follows:



- File extensions: ".mp3", ".wma"
- Sampling frequency: within 8 - 48 kHz (MP3), within 22 - 48kHz (WMA)
- Bit rate: within 8 - 320kbps (MP3), within 32 - 256kbps (WMA)
- CD-R/RW, DVD±R/RW Format: ISO 9660
- Maximum Files/Disc: Less than 650 (total number of files and folders)

## Viewing photo files



	ON REMOTE
1 Open the disc tray:	▲ OPEN/CLOSE
2 Insert a disc:	-
3 Close the disc tray:	▲ OPEN/CLOSE
4 Select a photo file on the menu:	▲▼, DVD MENU
5 Display the selected file in full screen:	▶ PLAY
6 To return to the menu:	■ STOP

## Viewing photo files - more you can do

### Viewing photo files as a slide show

Use ▲▼◀▶ to highlight (  ) icon then press **ENTER** to start slide show. You can change slide show speed using ◀▶ when (  ) icon is highlighted.

### Skip to the next/previous photo

Press **SKIP** (  or  ) to view the previous/next photo.

### Rotate a photo

Use ▲▼ to rotate the photo in full screen counterclockwise or clockwise while viewing a photo in full screen.

### Pause a slide show

Press **PAUSE/STEP** (  ) to pause a slide show. Press **PLAY** ( ▶ ) to continue the slide show.

### Listening to music during slide show

You can listen to music during slide show, if the disc contain music and photo files together. Use ▲▼◀▶ to highlight (  ) icon then press **ENTER** to start slide show.

**Watching a enlarged photo image**

While viewing a photo in full screen, press **ZOOM** repeatedly to select zoom mode. You can move through the zoomed photo using **▲▼▶▶** buttons. Press **CLEAR** to exit.

**Photo file requirement**

- JPEG file compatibility with this unit is limited as follows:
- File extensions: “.jpg”
  - Photo size: Less than 5M recommended
  - CD-R/RW, DVD±R/RW Format: ISO 9660
  - Maximum Files/Disc: Less than 650 (total number of files and folders)

**Using the Karaoke**

	ON REMOTE
1 Open the disc tray:	▲ OPEN/CLOSE
2 Insert a Karaoke DVD:	-
3 Close the disc tray:	▲ OPEN/CLOSE
4 Connect a microphone to MIC jack:	-
5 Start playback and sing a song:	▶ PLAY

**Using the Karaoke - more you can do.**

**Adjust the Karaoke menu settings**

Press **KARAOKE** to display karaoke menu. Use **▲▼** to select an option then press **◀▶** to adjust the value of the selected option.

**ECHO** – You can adjust the echo volume.

**MELODY** – If you wish to sing only to the backing band or orchestra unaccompanied by a vocal guide melody, set MELODY to Off.

**VOICE** – If you wish to sing a duet with the recorded karaoke singer, select a voice you desire.

Voice Select	Output	
	Left speaker	Right speaker
V1	Voice1	Voice1
V2	Voice2	Voice2
V1+V2	Voice1	Voice2
Off	None voice	None voice

**KEY** – You can change the key.

**EFFECT** – You can use Special Effects.

(Off → HARMONY → FLANGE → CHORUS)

**Notes the Karaoke**

- If a microphone is not connected, the karaoke menu will not appear.
- The karaoke feature functions only with karaoke-compatible discs.
- For more details, refer to the information attached with the disc.
- The VOICE and MELODY menus may not be available on some karaoke discs.
- Depending on the disc, a karaoke option may not work.

**Using an USB Flash Drive**

You can play MP3/WMA/JPEG/DivX files in the USB Flash Drive with version 1.1.

	ON REMOTE
1 Connect an USB Flash Drive to the USB port on the unit:	-
2 Display the menu screen in stop mode:	↻ RETURN
3 Select a file:	▲▼, DVD MENU
4 Play the file:	▶ PLAY
5 Remove the USB Flash Drive:	-

**Notes an USB Flash Drive**

- You can switch USB and DISC mode by pressing **RETURN (↻)** only in stop mode.
- Do not extract the USB device in operating.
- Aback up demands to prevent a data damage.
- If you use a USB extension cable or USB HUB, the USB device might not be recognized.
- Music files (MP3/WMA), photo files (JPEG) and DivX files can be played. For details of operations on each files, refer to relevant pages.
- This unit is not supported when the total number of files is more than 650.
- The USB function of this unit does not support all kinds of USB devices.
- Digital camera and mobile phone are not supported.

## Language Codes

Use this list to input your desired language for the following initial settings: Disc Audio, Disc Subtitle, Disc Menu.

Language	Code	Language	Code	Language	Code	Language	Code	Language	Code	Language	Code
Afar	6565	Croatian	7282	Hausa	7265	Lingala	7678	Quechua	8185	Tajik	8471
Afrikaans	6570	Czech	6783	Hebrew	7387	Lithuanian	7684	Rhaeto-Romance	8277	Tamil	8465
Albanian	8381	Danish	6865	Hindi	7273	Macedonian	7775	Rumanian	8279	Telugu	8469
Ameharic	6577	Dutch	7876	Hungarian	7285	Malagasy	7771	Russian	8285	Thai	8472
Arabic	6582	English	6978	Icelandic	7383	Malay	7783	Samoa	8377	Tonga	8479
Armenian	7289	Esperanto	6979	Indonesian	7378	Malayalam	7776	Sanskrit	8365	Turkish	8482
Assamese	6583	Estonian	6984	Interlingua	7365	Maori	7773	Scots Gaelic	7168	Turkmen	8475
Aymara	6588	Faroese	7079	Irish	7165	Marathi	7782	Serbian	8382	Twì	8487
Azerbaijani	6590	Fiji	7074	Italian	7384	Moldavian	7779	Serbo-Croatian	8372	Ukrainian	8575
Bashkir	6665	Finnish	7073	Javanese	7487	Mongolian	7778	Shona	8378	Urdu	8582
Basque	6985	French	7082	Kannada	7578	Nauru	7865	Sindhi	8368	Uzbek	8590
Bengali; Bangla	6678	Frisian	7089	Kashmiri	7583	Nepali	7869	Singhalese	8373	Vietnamese	8673
Bhutani	6890	Galician	7176	Kazakh	7575	Norwegian	7879	Slovak	8375	Volapük	8679
Bihari	6672	Georgian	7565	Kirghiz	7589	Oriya	7982	Slovenian	8376	Welsh	6789
Breton	6682	German	6869	Korean	7579	Panjabi	8065	Spanish	6983	Wolof	8779
Bulgarian	6671	Greek	6976	Kurdish	7585	Pashto, Pushto	8083	Sudanese	8385	Xhosa	8872
Burmese	7789	Greenlandic	7576	Laotian	7679	Persian	7065	Swahili	8387	Yiddish	7473
Byelorussian	6669	Guarani	7178	Latin	7665	Polish	8076	Swedish	8386	Yoruba	8979
Chinese	9072	Gujarati	7185	Latvian, Lettish	7686	Portuguese	8084	Tagalog	8476	Zulu	9085

## Area Codes

Choose a area code from this list.

Area	Code	Area	Code	Area	Code	Area	Code	Area	Code
Afghanistan	AF	Costa Rica	CR	Greenland	GL	Maldives	MV	Paraguay	PY
Argentina	AR	Croatia	HR	Hong Kong	HK	Mexico	MX	Philippines	PH
Australia	AU	Czech Republic	CZ	Hungary	HU	Monaco	MC	Poland	PL
Austria	AT	Denmark	DK	India	IN	Mongolia	MN	Portugal	PT
Belgium	BE	Ecuador	EC	Indonesia	ID	Morocco	MA	Romania	RO
Bhutan	BT	Egypt	EG	Israel	IL	Nepal	NP	Russian Federation	RU
Bolivia	BO	El Salvador	SV	Italy	IT	Netherlands	NL	Saudi Arabia	SA
Brazil	BR	Ethiopia	ET	Jamaica	JM	Netherlands Antilles	AN	Senegal	SN
Cambodia	KH	Fiji	FJ	Japan	JP	New Zealand	NZ	Singapore	SG
Canada	CA	Finland	FI	Kenya	KE	Nigeria	NG	Slovak Republic	SK
Chile	CL	France	FR	Kuwait	KW	Norway	NO	Slovenia	SI
China	CN	Germany	DE	Libya	LY	Oman	OM	South Africa	ZA
Colombia	CO	Great Britain	GB	Luxembourg	LU	Pakistan	PK	South Korea	KR
Congo	CG	Greece	GR	Malaysia	MY	Panama	PA	Spain	ES

## Troubleshooting

Symptom	Cause	Correction
No power.	The power cord is disconnected.	Plug the power cord into the wall outlet securely.
The power is on, but the unit does not work.	No disc is inserted.	Insert a disc.
No picture.	The TV is not set to receive the signal from the unit.	Select the appropriate video input mode on the TV.
	The video cable is not connected securely.	Connect the video cable securely.
No sound.	The equipment connected with the audio cable is not set to receive the signal from the unit.	Select the correct input mode of the audio amplifier.
	The AUDIO options are set to the wrong position.	Set the AUDIO settings to the correct position.
The unit does not start playback.	An unplayable disc is inserted.	Insert a playable disc. (Check the disc type and regional code.)
	The rating level is set.	Change the rating level.
The remote control does not work properly.	The remote control is not pointed at the remote sensor on the unit.	Point the remote control at the remote sensor of the unit.
	The remote control is too far from the unit.	Operate the remote control closer to the unit.

## Specifications

### General

Power requirements	AC 110-240V, 50/60 Hz
Power consumption	9W
Dimensions (Approx.)	430 x 35 x 200 mm (W x H x D) without foot
Net Weight (Approx.)	1.5 kg
Operating temperature	5 °C to 35 °C
Operating humidity	5 % to 90 %
Laser	Semiconductor laser
Signal system	NTSC

### Outputs

Video Output	1.0 V (p-p), 75 Ω, sync negative, RCA jack (L, R) x 1
Component Video Output	(Y) 1.0 V (p-p), 75 Ω, sync negative, RCA jack x 1 (Pb)/(Pr) 0.7 V (p-p), 75 Ω, RCA jack x 2
S-Video Output	(Y) 1.0 V (p-p), 75 Ω, sync negative, Mini DIN 4-pinX1 (C) 0.3 V, 75 Ω
HDMI Video/Audio Output	19 pin(HDMI standard, Type A)
Audio Output	2.0 Vrms (1 KHz, 0 dB), 600 Ω, RCA jack (L, R) x 1
Digital Output (Optical)	3 V (p-p), Optical jack x 1
Digital Output (Coaxial)	0.5 V (p-p), 75 Ω, RCA jack x 1

### Accessories

Video/Audio cable, Remote Control, Battery

**Designs and specifications are subject to change without prior notice.**