



## LCD TV | PLASMA TV OWNER'S MANUAL

### LCD TV MODELS

32LC5DC      32LC50CS  
32LC5DCS    32LC50CB  
32LC5DCB    32LX50C  
37LC5DC      32LX50CS  
37LC5DCB    37LC50C  
37LC5DC1    37LC50CB  
42LC5DC      42LB50C  
32LX5DC      42LC50C  
32LX5DCS    32LG500H  
42LB5DC      37LG500H  
32LC50C      42LG500H

### PLASMA TV MODEL

42PX8DC  
42PG65C  
42PG60C

Please read this manual carefully before operating your set.

Retain it for future reference.

Record model number and serial number of the set. See the label attached on the back cover and quote this information to your dealer when you require service.

# WARNING / CAUTION



**WARNING / CAUTION**  
RISK OF ELECTRIC SHOCK  
DO NOT OPEN



TO REDUCE THE RISK OF ELECTRIC SHOCK  
DO NOT REMOVE COVER (OR BACK). NO  
USER SERVICEABLE PARTS INSIDE. REFER TO  
QUALIFIED SERVICE PERSONNEL.



The lightning flash with arrowhead symbol, within an equilateral triangle, is intended to alert the user to the presence of uninsulated “dangerous voltage” within the product’s enclosure that may be of sufficient magnitude to constitute a risk of electric shock to persons.



The exclamation point within an equilateral triangle is intended to alert the user to the presence of important operating and maintenance (servicing) instructions in the literature accompanying the appliance.

## WARNING/CAUTION

TO REDUCE THE RISK OF FIRE AND ELECTRIC SHOCK, DO NOT EXPOSE THIS PRODUCT TO RAIN OR MOISTURE.

## NOTE TO CABLE/TV INSTALLER

This reminder is provided to call the CATV system installer’s attention to Article 820-40 of the National Electric Code (U.S.A.). The code provides guidelines for proper grounding and, in particular, specifies that the cable ground shall be connected to the grounding system of the building, as close to the point of the cable entry as practical.

# WARNING / CAUTION

To prevent fire or shock hazards, do not expose this product to rain or moisture.

## FCC NOTICE

### Class B digital device

This equipment has been tested and found to comply with the limits for a Class B digital device, pursuant to Part 15 of the FCC Rules. These limits are designed to provide reasonable protection against harmful interference in a residential installation. This equipment generates, uses and can radiate radio frequency energy and, if not installed and used in accordance with the instructions, may cause harmful interference to radio communications. However, there is no guarantee that interference will not occur in a particular installation. If this equipment does cause harmful interference to radio or television reception, which can be determined by turning the equipment off and on, the user is encouraged to try to correct the interference by one or more of the following measures:

- Reorient or relocate the receiving antenna.
- Increase the separation between the equipment and receiver.
- Connect the equipment to an outlet on a circuit different from that to which the receiver is connected.
- Consult the dealer or an experienced radio/TV technician for help.

**Any changes or modifications not expressly approved by the party responsible for compliance could void the user’s authority to operate the equipment.**

## CAUTION

Do not attempt to modify this product in any way without written authorization from LG Electronics. Unauthorized modification could void the user’s authority to operate this product

# SAFETY INSTRUCTION

## IMPORTANT SAFETY INSTRUCTIONS

Read these instructions.

Keep these instructions.

Heed all warnings.

Follow all instructions.



- 1 Do not use this apparatus near water.

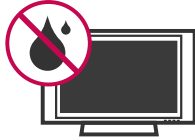

- 2 Clean only with dry cloth.



- 3 Do not block any ventilation openings. Install in accordance with the manufacturer's instructions.



- 4 Do not install near any heat sources such as radiators, heat registers, stoves, or other apparatus (including amplifiers) that produce heat.



- 5 Do not defeat the safety purpose of the polarized or grounding-type plug. A polarized plug has two blades with one wider than the other. A grounding type plug has two blades and a third grounding prong. The wide blade or the third prong are provided for your safety. If the provided plug does not fit into your outlet, consult an electrician for replacement of the obsolete outlet.



- 6 Protect the power cord from being walked on or pinched particularly at plugs, convenience receptacles, and the point where they exit from the apparatus.



- 7 Only use attachments/accessories specified by the manufacturer.



- 8 Use only with the cart, stand, tripod, bracket, or table specified by the manufacturer, or sold with the apparatus. When a cart is used, use caution when moving the cart/apparatus combination to avoid injury from tip-over.



- 9 Unplug this apparatus during lightning storms or when unused for long periods of time.

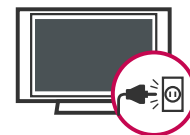

- 10 Refer all servicing to qualified service personnel. Servicing is required when the apparatus has been damaged in any way, such as power-supply cord or plug is damaged, liquid has been spilled or objects have fallen into the apparatus, the apparatus has been exposed to rain or moisture, does not operate normally, or has been dropped.

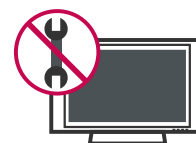

# SAFETY INSTRUCTION

**11** Never touch this apparatus or antenna during a thunder or lightning storm.

**12** When mounting a TV on the wall, make sure not to install the TV by the hanging power and signal cables on the back of the TV.

**13** Do not allow an impact shock or any objects to fall into the product, and do not drop onto the screen with something.

**14** **CAUTION** concerning the Power Cord :  
It is recommend that appliances be placed upon a dedicated circuit; that is, a single outlet circuit which powers only that appliance and has no additional outlets or branch circuits. Check the specification page of this owner's manual to be certain.  
Do not connect too many appliances to the same AC power outlet as this could result in fire or electric shock.

Do not overload wall outlets. Overloaded wall outlets, loose or damaged wall outlets, extension cords, frayed power cords, or damaged or cracked wire insulation are dangerous. Any of these conditions could result in electric shock or fire. Periodically examine the cord of your appliance, and if its appearance indicates damage or deterioration, unplug it, discontinue use of the appliance, and have the cord replaced with an exact replacement part by an authorized servicer. Protect the power cord from physical or mechanical abuse, such as being twisted, kinked, pinched, closed in a door, or walked upon. Pay particular attention to plugs, wall outlets, and the point where the cord exits the appliance.

Do not make the TV with the power cord plugged in. Do not use a damaged or loose power cord. Be sure do grasp the plug when unplugging the power cord. Do not pull on the power cord to unplug the TV.

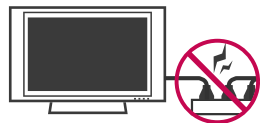

**15** **WARNING** - To reduce the risk of fire or electrical shock, do not expose this product to rain, moisture or other liquids. Do not touch the TV with wet hands. Do not install this product near flammable objects such as gasoline or candles or expose the TV to direct air conditioning.



**16** Do not expose to dripping or splashing and do not place objects filled with liquids, such as vases, cups, etc. on or over the apparatus (e.g. on shelves above the unit).



## **17** GROUNDING

Ensure that you connect the earth ground wire to prevent possible electric shock. (i.e. a TV with a three-prong grounded AC plug must be connected to a three-prong grounded AC outlet) If grounding methods are not possible, have a qualified electrician install a separate circuit breaker.

Do not try to ground the unit by connecting it to telephone wires, lightening rods, or gas pipes.

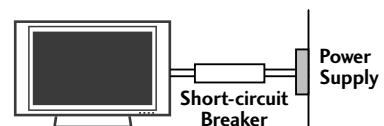

## **18** DISCONNECTING DEVICE FROM MAINS

Mains plug is the disconnecting device. The plug must remain readily operable.

**19** Keep the product away from direct sunlight.

## 20 ANTENNAS

### Outdoor antenna grounding

If an outdoor antenna is installed, follow the precautions below. An outdoor antenna system should not be located in the vicinity of overhead power lines or other electric light or power circuits, or where it can come in contact with such power lines or circuits as death or serious injury can occur.

Be sure the antenna system is grounded so as to provide some protection against voltage surges and built-up static charges.

Section 810 of the National Electrical Code (NEC) in the U.S.A. provides information with respect to proper grounding of the mast and supporting structure, grounding of the lead-in wire to an antenna discharge unit, size of grounding conductors, location of antenna discharge unit, connection to grounding electrodes and requirements for the grounding electrode.

### Antenna grounding according to the National Electrical Code, ANSI/NFPA 70

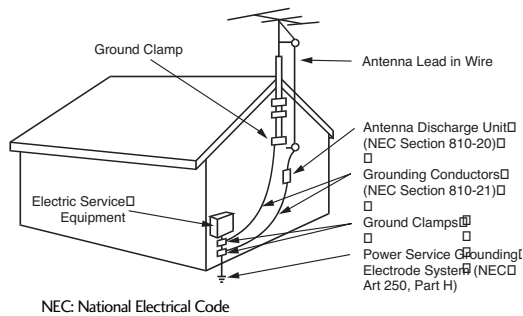

## 21 Cleaning

When cleaning, unplug the power cord and scrub gently with a soft cloth to prevent scratching. Do not spray water or other liquids directly on the TV as electric shock may occur. Do not clean with chemicals such as alcohol, thinners or benzene.

## 22 Moving

Make sure the product is turned off, unplugged and all cables have been removed. It may take 2 or more people to carry larger TVs. Do not press against or put stress on the front panel of the TV.

## 23 Ventilation

Install your TV where there is proper ventilation. Do not install in a confined space such as a bookcase. Do not cover the product with cloth or other materials (e.g.) plastic while plugged in. Do not install in excessively dusty places.

## 24

If you smell smoke or other odors coming from the TV or hear strange sounds, unplug the power cord contact an authorized service center.

## 25

Do not press strongly upon the panel with a hand or sharp object such as nail, pencil or pen, or make a scratch on it.

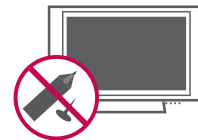

# CONTENTS

<b>WARNING / CAUTION</b> .....	A
<b>SAFETY INSTRUCTION</b> .....	1
<b>FEATURE OF THIS TV</b> .....	5

## PREPARATION

Accessories .....	5
Front Panel Controls .....	7
Back Panel Information .....	10
Back Cover for Wire Arrangement .....	12
Stand Installation .....	15
Attaching the TV to a Wall .....	17
Swivel Stand .....	17
Attaching the TV to a Desk .....	18
VESA Wall Mounting .....	19
Desktop Pedestal Installation .....	19
Antenna or Cable Connection .....	20

## EXTERNAL EQUIPMENT SETUP

HD Receiver Setup .....	21
DVD Setup .....	24
VCR Setup .....	26
Other A/V Source Setup .....	28
Digital Audio Output .....	28
PC Setup .....	29

## WATCHING TV / CHANNEL CONTROL

Remote Control Functions .....	32
Turning On TV .....	34
Channel Selection .....	34
Volume Adjustment .....	34
On-Screen Menus Selection .....	35
Channel Setup .....	36
- Auto Scan (EZ Scan) .....	36
- Add / Delete Channel (Manual Scan) .....	37
- Channel Editing .....	38
DTV Signal Strength .....	39
Channel Label .....	40

## PICTURE CONTROL

Watching DW (Double Window) .....	41
Picture Size (Aspect Ratio) Control .....	43
Preset Picture Settings .....	
- EZ Picture - Preset .....	45
- Color Tone - Preset .....	46
Manual Picture Adjustment .....	
- EZ Picture - User Mode .....	47
- Color Tone - User Mode .....	48
XD - Picture Improvement Technology .....	49
Advanced - Cinema Mode .....	50
Advanced - Black (Darkness) Level .....	51

Picture Reset .....	52
Low-Power Picture Mode .....	52
Image Sticking Minimization( ISM) Method .....	53

## SOUND & LANGUAGE CONTROL

Auto Volume Leveler (EZ SoundRite) .....	54
Preset Sound Setting (EZ Sound) .....	55
Sound Setting Adjustment - User Mode .....	56
Balance Adjustment .....	57
TV Speakers On/Off Setup .....	58
Stereo/SAP Broadcasts Setup .....	59
Audio Language .....	60
On-Screen Menus Language Selection .....	61
Caption/Text .....	62
- Analog Broadcasting System Captions .....	62
- Digital Broadcasting System Captions .....	63
Caption Options .....	64

## TIME SETTING

Clock Setting .....	65
- Auto Clock Setup .....	65
- Manual Clock Setup .....	66
Auto On/Off Timer Setting .....	67
Auto Shut-off Setting .....	68
Sleep Timer Setting .....	69

## SCREEN ADJUSTMENT

Auto Configure (RGB(PC) Mode only) .....	70
Manual Configure .....	71
Selecting XGA Mode .....	72
Initializing (Reset to Original Factory Settings) .....	73

## PARENTAL CONTROL / RATINGS

Set Password & Lock System .....	74
- Setting up Your Password .....	74
- Set Password .....	75
- Lock System .....	75
Channel Blocking .....	76
External Input Blocking .....	76
Movie & TV Rating .....	77
- Movie Rating (MPAA) .....	77
- Downloadable Rating .....	77
- TV Rating Children & General .....	78
- TV Rating English & French .....	79

## APPENDIX

Troubleshooting .....	80
Maintenance .....	82
Product Specifications .....	83
Programming the Remote Control .....	84
Set ID .....	86
IR Codes .....	87

# FEATURES OF THIS TV

## FOR LCD TV

If the TV feels cold to the touch, there may be a small “flicker” when it is turned on. This is normal, there is nothing wrong with TV.

Some minute dot defects may be visible on the screen, appearing as tiny red, green, or blue spots. However, they have no adverse effect on the monitor’s performance.

Avoid touching the LCD screen or holding your finger(s) against it for long periods of time. Doing so may produce some temporary distortion effects on the screen.

## On Disposal

- The fluorescent lamp used in this product contains a small amount of mercury.
- Do not dispose of this product with general household waste.
- Disposal of this product must be carried out in accordance to the regulations of your local authority.

# PREPARATION

## ACCESSORIES

Ensure that the following accessories are included with your product. If an accessory is missing, please contact the dealer where you purchased the product.

User must use shielded signal interface cables (D-sub 15 pin cable) with ferrite cores to maintain standard compliance for the product.

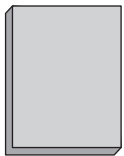

Owner’s Manual,  
Setup & Operation Guide  
for Commercial Mode



CD Manual

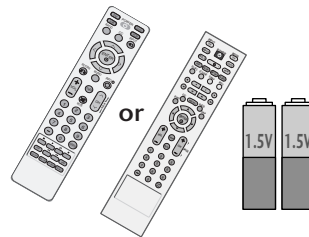

Remote Control,  
Batteries

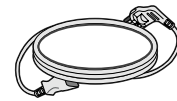

Power Cord

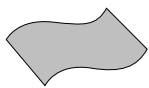

### Polishing Cloth

This feature is not available  
for all models.

\* Slightly wipe stained spot on the exterior only with the polishing cloth for the product exterior or if there is stain or fingerprint on surface of the exterior.

\* Do not wipe roughly when removing stain. Please be cautious of that excessive pressure may cause scratch or discoloration.

# PREPARATION

## LCD TV model only

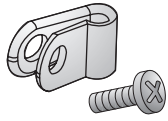

**Protective Bracket and Bolt for Power Cord**  
(This feature is not available for all models.)  
(Refer to P.12-13, 15)



**M4xL22**  
**Torx plus Star head screw**  
(Refer to p.7, 15)

### Option Extras

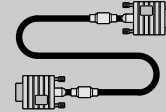

**D-sub 15 pin Cable**

Only 32/37/42LC5DC\*, 32/37/42LC50C\*, 42LB5DC, 42LB50C models

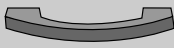

**Cable Management**  
(Refer to p.12)



**Cable Holder**  
(Refer to p.12-13)



**1-Bolt for fixing the Cable Holder**  
(Refer to p.12-13)



**4-Bolts for stand assembly**  
(Refer to p.16)  
*Only 32/37LC5DC\*, 32/37LC50C\* models*

Only 32/37/42LG500H models



**Bolts for stand assembly**  
(Refer to P.15)



**Screw for stand fixing**  
(Refer to P.19)

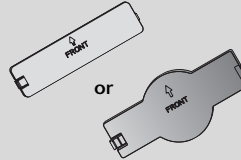

**Protection Cover**



**Cable Holder**



**Plug in type holder**

## Plasma TV models only



**75 ohm Round Cable**  
(Except 42PG60C/65C)

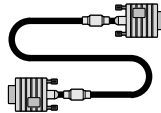

**D-sub 15 Pin Cable**  
(Except 42PG60C/65C)



**Cable Holder**  
(Except 42PX8DC)

Only 42PG65C model



**Cable Management Clip**



**Bolts for stand assembly**  
(Refer to P.14)

# FRONT PANEL CONTROLS

■ Here shown may be somewhat different from your TV.

32/37/42LC5DC\*, 32/37/42LC50C\*, 42LB5DC, 42LB50C

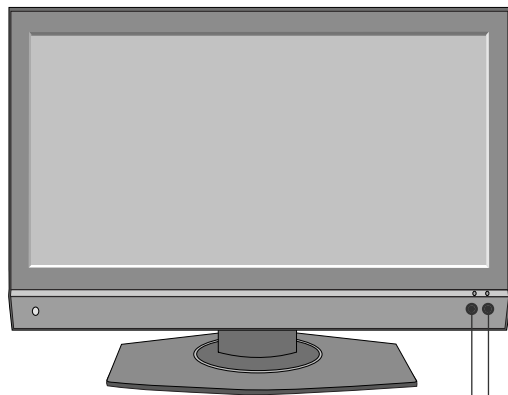

Remote Control Sensor

Power/Standby Indicator

Illuminates red when the TV is in standby mode.  
Illuminates green when the TV is switched on.

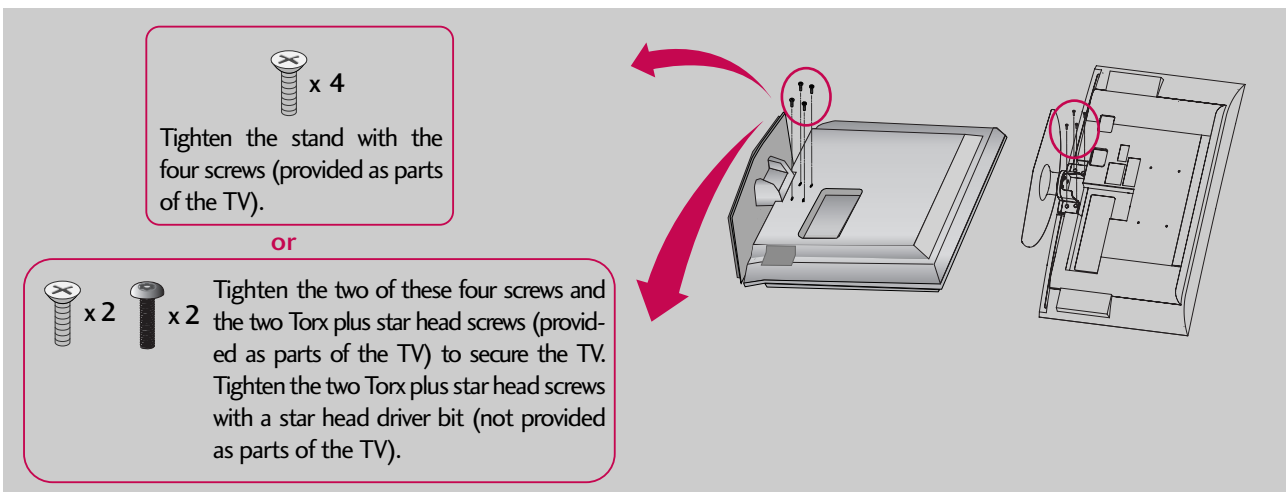
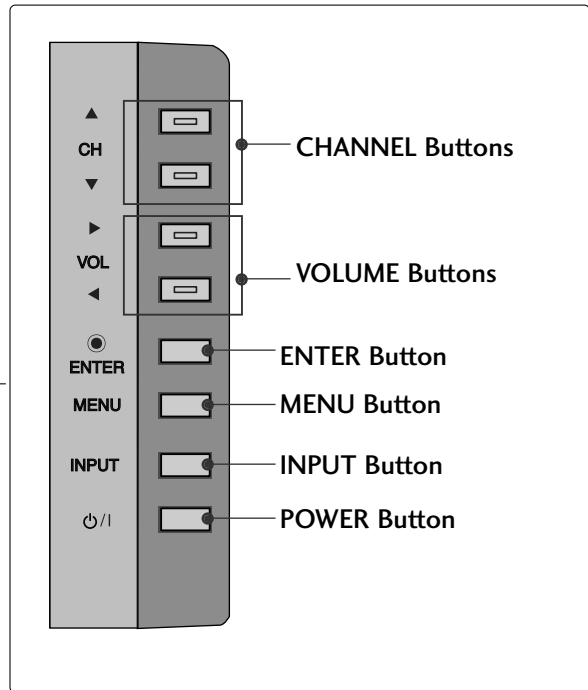

# PREPARATION

32LX5DC\*, 32LX50C\*

PREPARATION

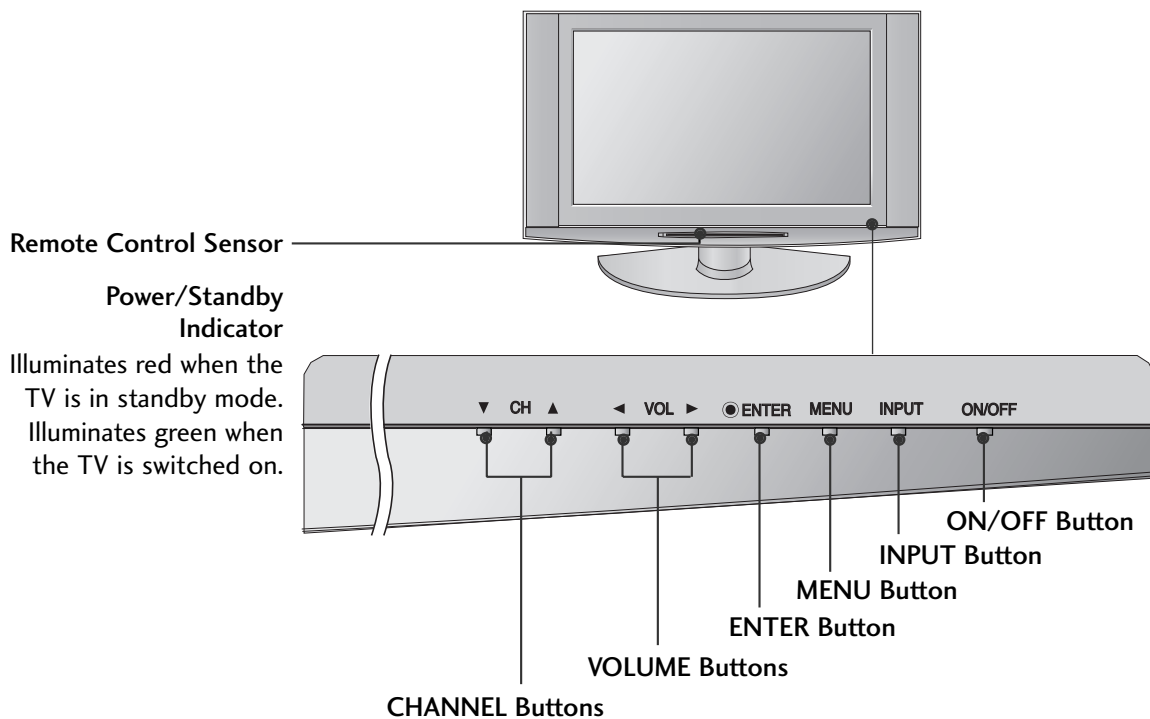

32/37/42LG500H

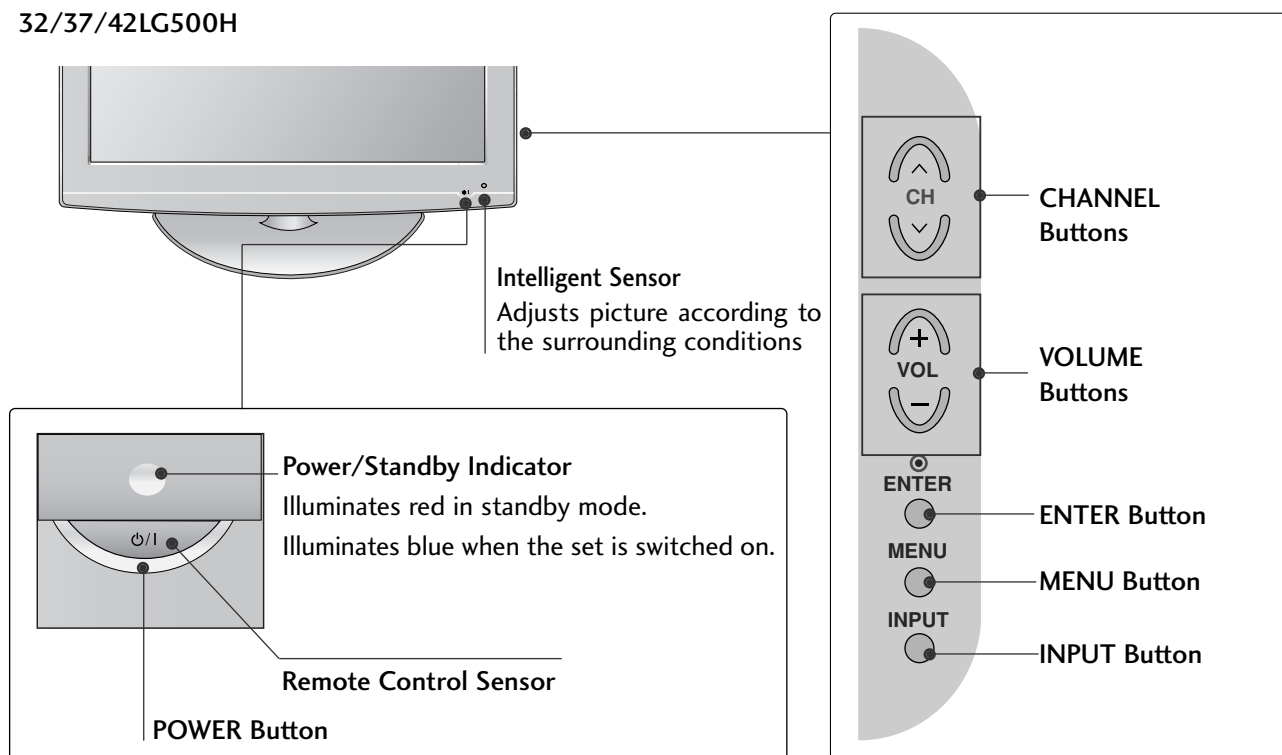

42PX8DC

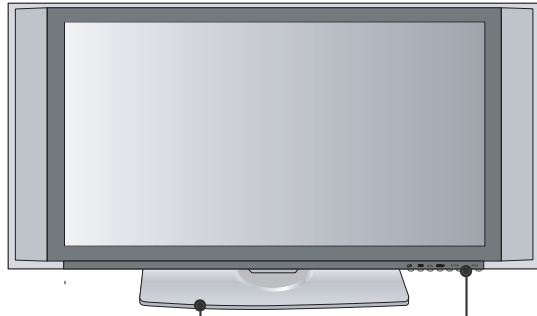

This TV's stand is sold, separately.



**Remote Control Sensor**  
**Power/Standby Indicator**  
 Illuminates red when the TV is in standby mode.  
 Illuminates green when the TV is switched on.

POWER Button  
 INPUT Button  
 MENU Button  
 ENTER Button  
 VOLUME Buttons  
 CHANNEL Buttons

42PG60C, 42PG65C

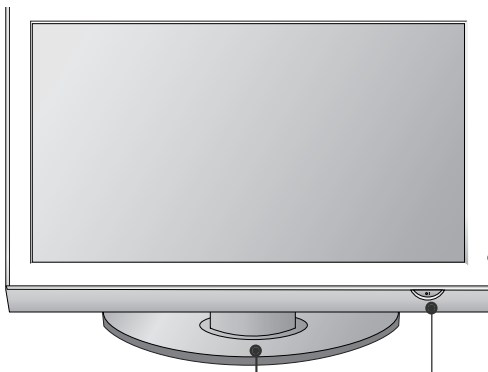

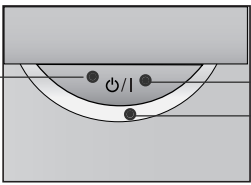

Remote Control Sensor  
 POWER Button

**Power/Standby Indicator**  
 Illuminates red in standby mode.  
 Illuminates blue when the set is switched on.

Stand (Only 42PG65C model)

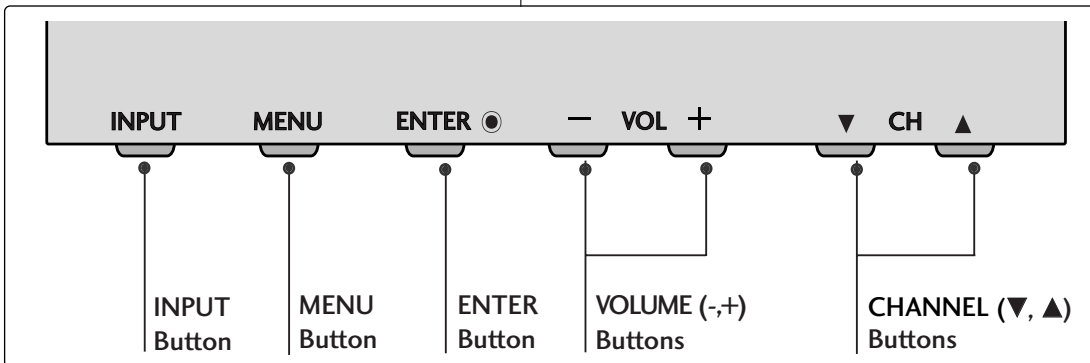

# PREPARATION

## BACK PANEL INFORMATION

■ Here shown may be somewhat different from your TV.

PREPARATION

32/37/42LC5DC\*, 32/37/42LC50C\*,  
42LB5DC, 42LB50C

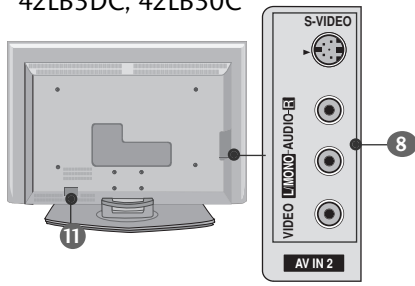

32LX5DC\*, 32LX50C\*

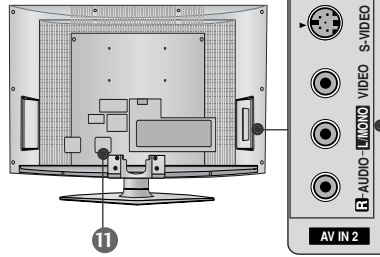

42PX8DC

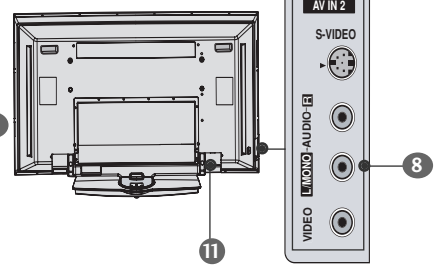

42PG60C, 42PG65C

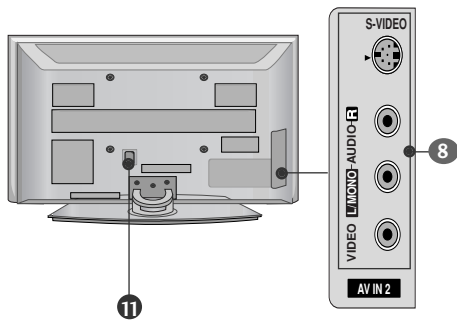

32/37/42LG500H

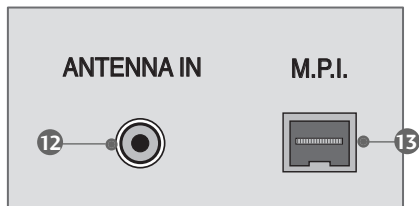
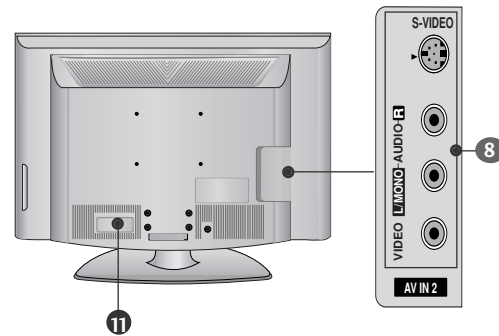

32/37/42LC5DC\*, 32/37/42LC50C\*,  
42LB5DC, 42LB50C, 32LX5DC\*, 32LX50C\*, 42PX8DC

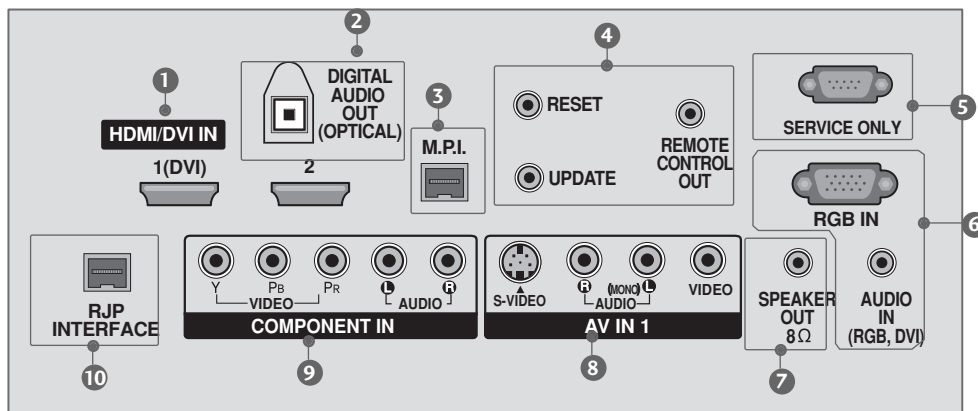

42PG60C, 42PG65C

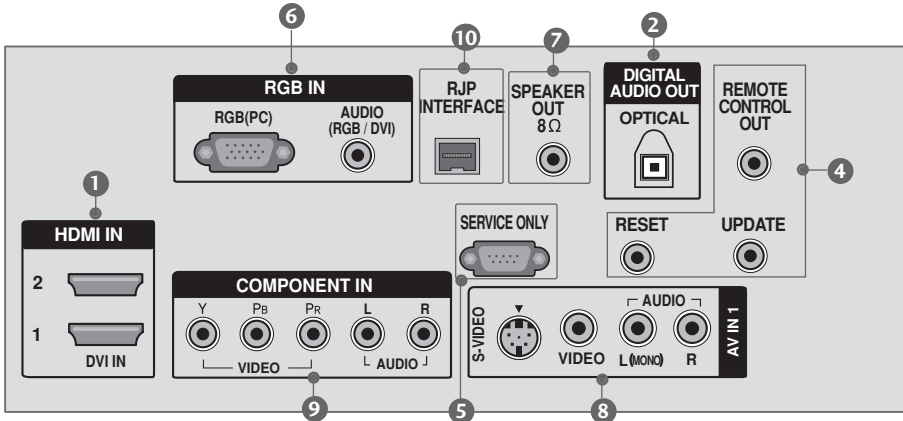

32/37/42LG500H

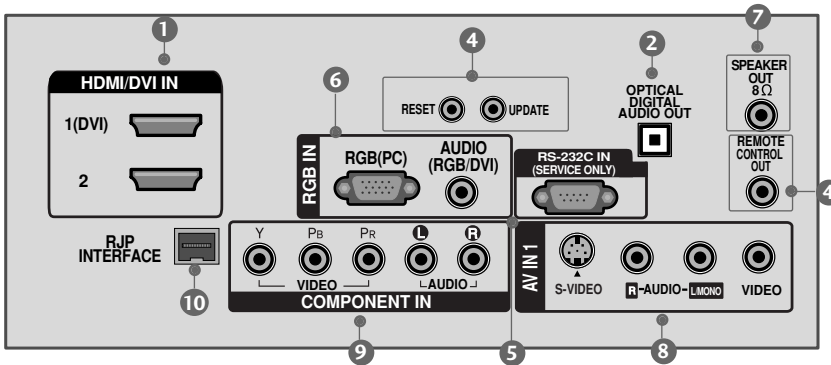

- ① **HDMI/DVI IN, HDMI IN**  
Connect a HDMI (DVI) connection to either input.
- ② **DIGITAL AUDIO OUT**  
Connect digital audio from various types of equipment.  
Note: In standby mode, these ports do not work.
- ③ ⑬ **M.P.I**
- ④ **RESET/UPDATE/REMOTE CONTROL OUT**
- ⑤ **SERVICE ONLY**
- ⑥ **RGB IN (PC)**  
Connect the output from a PC.  
**AUDIO IN (RGB, DVI)**  
Connect the audio from a PC or DTV.
- ⑦ **SPEAKER OUT 8Ω**
- ⑧ **AV (Audio/Video) IN**  
Connect audio/video output from an external device to these jacks.  
**S-VIDEO**  
Connect S-Video out from an S-VIDEO device.
- ⑨ **COMPONENT IN**  
Connect a component video/audio device to these jacks.
- ⑩ **RJP INTERFACE**
- ⑪ **Power Cord Socket**  
For operation with AC power.  
Caution: Never attempt to operate the TV on DC power.
- ⑫ **ANTENNA IN**  
Connect over-the air signals to this jack.

# PREPARATION

## BACK COVER FOR WIRE ARRANGEMENT

■ Here shown may be somewhat different from your TV.

(This feature is not available for all models.)

- 1 Connect the cables as necessary.  
To connect an additional equipment, see the **EXTERNAL EQUIPMENT SETUP** section.  
Secure the power cable with the **PROTECTIVE BRACKET** and the screw as shown. It will help prevent the power cable from being removed by accident.

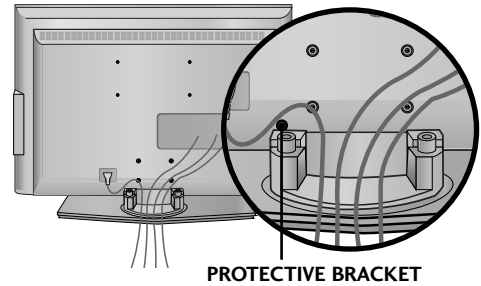

- 2 Install the **CABLE HOLDER** as shown.

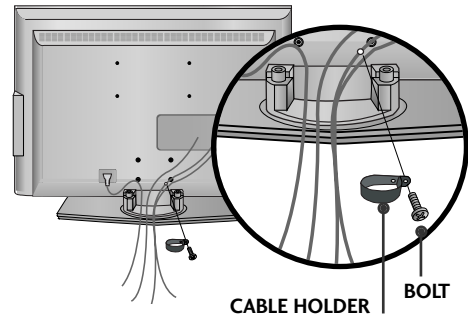

- 2 Install the **CABLE MANAGEMENT** as shown.

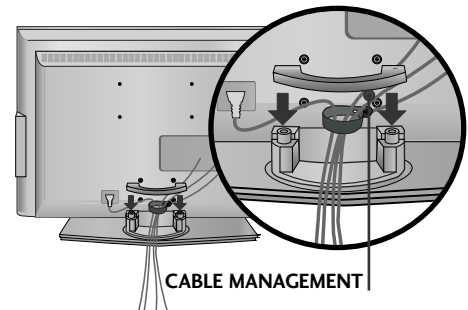

### ! NOTE

- ▶ Do not hold the **CABLE MANAGEMENT** when moving the product.
  - If the product is dropped, you may be injured or the product may be damaged.

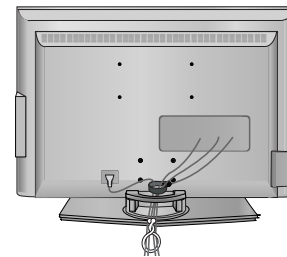

### How to remove the **CABLE MANAGEMENT**

- ▶ Hold the **CABLE MANAGEMENT** with both hands and pull it backward.

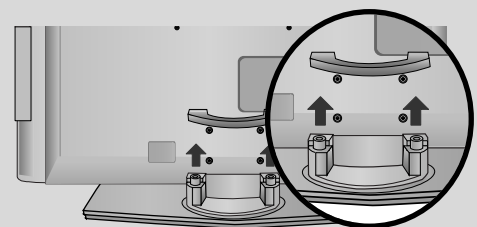

(This feature is not available for all models.)

- 1 To separate the **CABLE HOLDER**, loosen the bolt installed the set.

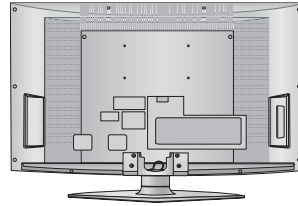

- 2 Connect the cables as necessary.  
To connect an additional equipment, see the **EXTERNAL EQUIPMENT SETUP** section.  
Secure the power cable with the **PROTECTIVE BRACKET** and the screw as shown. It will help prevent the power cable from being removed by accident.

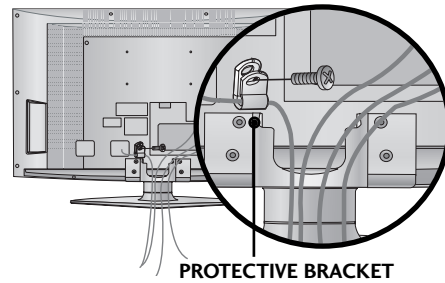

PROTECTIVE BRACKET

- 3 Install the **CABLE HOLDER** as shown.

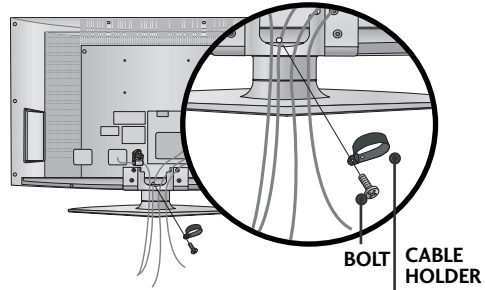

BOLT CABLE HOLDER

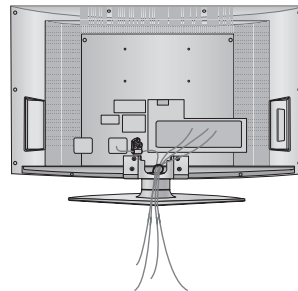

# PREPARATION

## BACK COVER FOR WIRE ARRANGEMENT

▪ Here shown may be somewhat different from your TV.

42PX8DC

- 1 Hold the **CABLE MANAGEMENT** with both hands and pull it as shown.

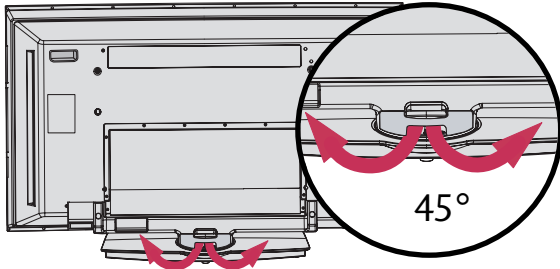

- 2 Connect the cables as necessary. To connect an additional equipment, see the **EXTERNAL EQUIPMENT SETUP** section.

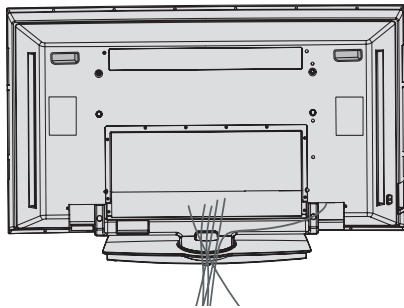

- 3 Install the **CABLE MANAGEMENT** as shown.

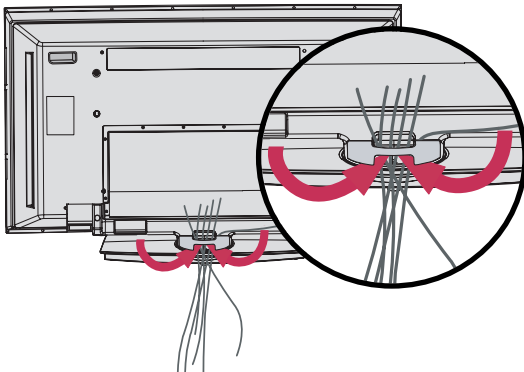

42PG60C, 42PG65C

- 1 Connect the cables as necessary. To connect additional equipment, see the **EXTERNAL EQUIPMENT SETUP** section.

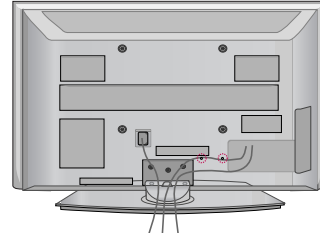

- 2 Install the **CABLE MANAGEMENT CLIP** as shown. (Except 42PG60C model) If your TV has **CABLE HOLDER**, fix it as shown and bundle the cables.

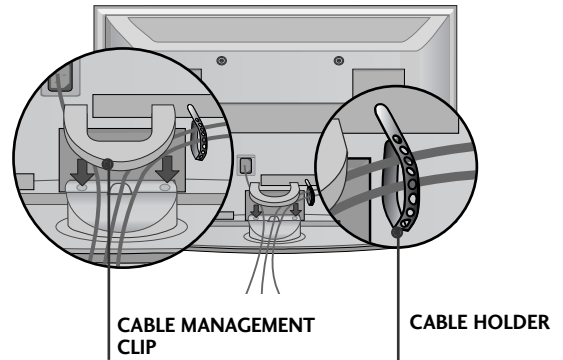

### How to remove the **CABLE MANAGEMENT CLIP**

(Except 42PG60C model)

- ▶ First, press the cable management. Hold the **CABLE MANAGEMENT CLIP** with both hands and pull it upward.

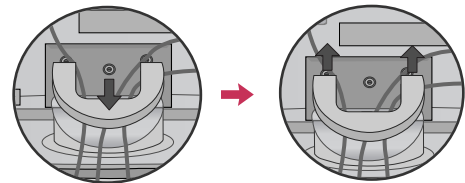

### ! NOTE

- ▶ Do not hold the **CABLE MANAGEMENT CLIP** when moving the TV.
  - If the TV is dropped, you may be injured or the product may be broken.

32/37/42LG500H

## BACK COVER FOR WIRE ARRANGEMENT

- 1 Connect the cables as necessary.  
To connect additional equipment, see the **EXTERNAL EQUIPMENT SETUP** section. Secure the power cable with the **PROTECTIVE BRACKET/Screw** or **PLUG IN TYPE HOLDER** for power code. It will help prevent the power cable from being removed by accident.

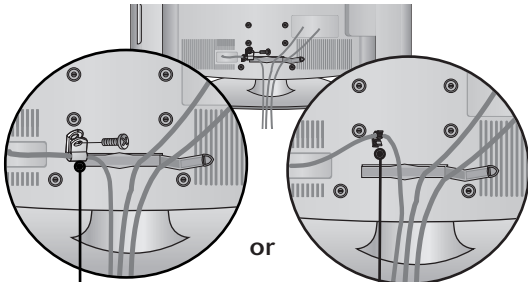

**PROTECTIVE BRACKET**  
(This feature is not available for all models.)

**PLUG IN TYPE HOLDER**

- 2 Install the **CABLE MANAGEMENT CLIP** as shown. If your TV has the **CABLE HOLDER**, install it as shown and bundle the cables.

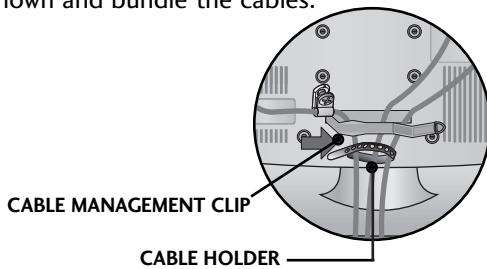

**CABLE MANAGEMENT CLIP**

**CABLE HOLDER**

- 3 Put the cables inside the **CABLE MANAGEMENT CLIP** and snap it closed.

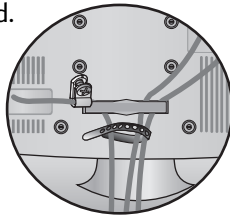

## PROTECTION COVER

After removing the stand, install the included **protection cover** over the hole for the stand.

Press the **PROTECTION COVER** into the TV until you hear it click.

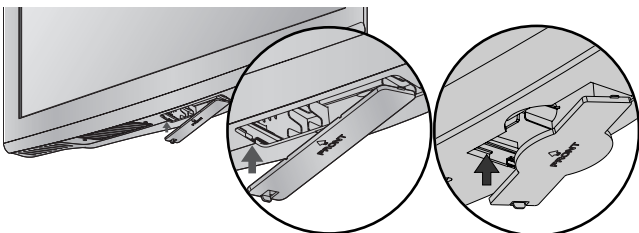

## STAND INSTALLATION

- 1 Carefully place the TV screen side down on a cushioned surface to protect the screen from damage.

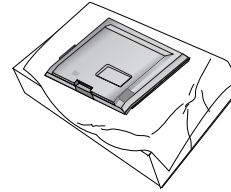

- 2 Assemble the parts of the **STAND BODY** with **COVER BASE** of the TV.

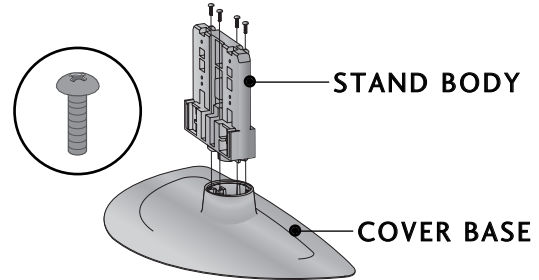

- 3 Assemble the TV as shown.

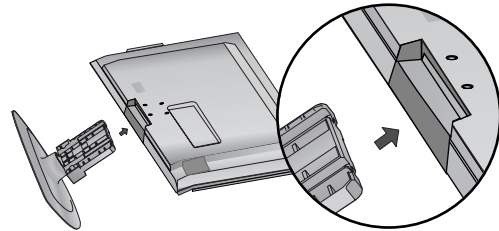

- 4 Tighten the stand with the four screws (provided as parts of the TV).

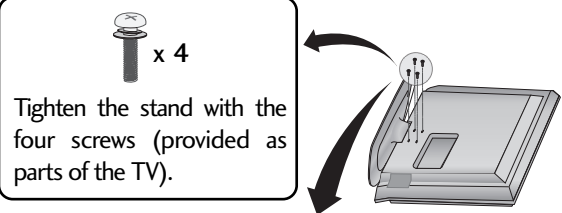

or

Tighten the two of these four screws and the two Torx plus star head screws (provided as parts of the TV) to secure the TV. Tighten the two Torx plus star head screws with a star head driver bit (not provided as parts of the TV).

### NOTE

- ▶ When assembling the desk type stand, make sure the bolt is fully tightened (If not tightened fully, the TV can tilt forward after the product installation). Do not over tighten.
- ▶ With some TVs, the **PLUG IN TYPE HOLDER** and the **CABLE HOLDER** are included. If these holders are inserted into the hole provided on back of the TV, they cannot be removed.

# PREPARATION

## STAND INSTALLATION

32/37LC5DC\*, 32/37LC50C\*

- 1 Carefully place the product screen side down on a cushioned surface that will protect product and screen from damage.

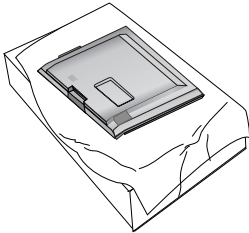

- 2 Assemble the product stand with the product as shown.

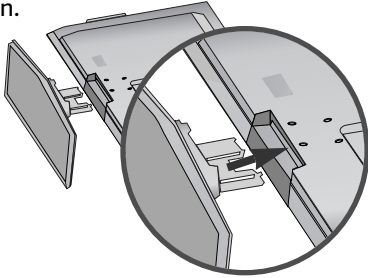

- 3 Securely install the 4 bolts provided as shown below.

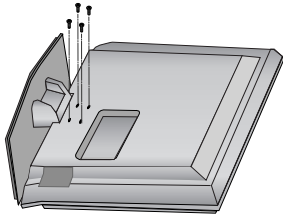

42PG65C

- 1 Carefully place the TV screen side down on a cushioned surface to protect the screen from damage.

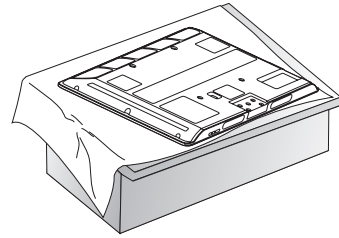

### ! NOTE

- ▶ After inserting the MPI slot/card, install the product stand.

- 2 Assemble the product stand with the product as shown.

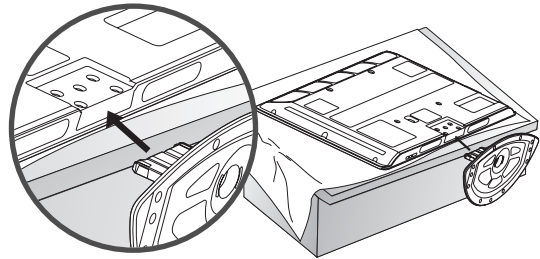

- 3 Tighten the 4 bolts securely using the holes in the back of the TV.

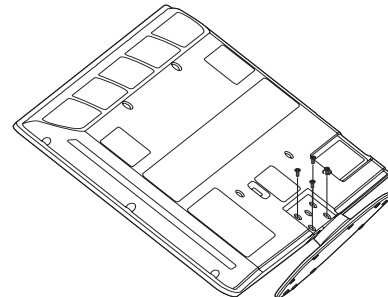

## ATTACHING THE TV TO A WALL

- This feature is not available for all models.

We recommend that you set up the TV close to a wall so it cannot fall over if pushed backwards. Additionally, we recommend that the TV be attached to a wall so it cannot be pulled in a forward direction, potentially causing injury or damaging the product.

Caution: Please make sure that children don't climb on or hang from the TV.

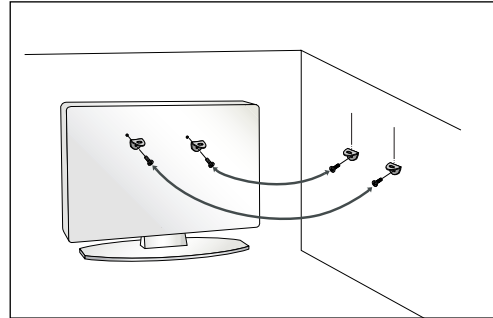
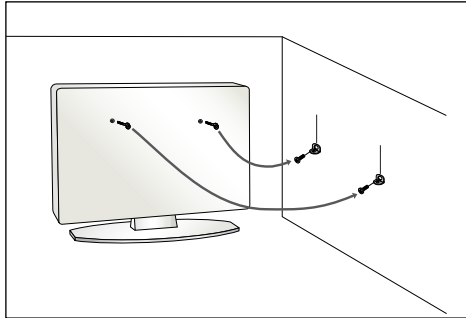

- Insert the TV brackets (or eye-bolts) and bolts to tighten the product to the wall as shown in the picture.
  - \* If your product has the bolts in the eye-bolts position before inserting the eye-bolts, loosen the bolts.
 Secure the wall brackets with the bolts (not provided as parts of the product, must purchase separately) on the wall. Match the height of the bracket that is mounted on the wall to the holes in the product. Ensure the eye-bolts or brackets are tightened securely.

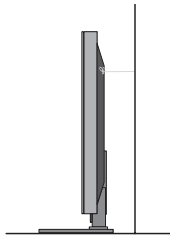

- Use a sturdy rope (not provided as parts of the product, must purchase separately) to tie the product. It is safer to tie the rope so it becomes horizontal between the wall and the product.

## SWIVEL STAND

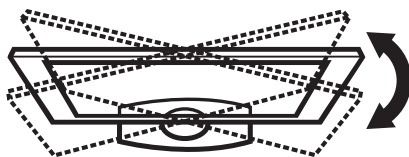

**20°** (37LC5DC1, 42LC5DC, 42LC50C, 42PX8DC, 42LB5DC, 42LB50C, 42PG65C models)

**90°** (32LX5DC/S, 32LX50C/S, 32LC5DC/S, 32LC50C/S, 37LC5DC, 37LC50C, 32/37/42LG500H models)

The TV can be conveniently swivelled on its stand 20° or 90° to the left or right to provide the optimum viewing angle.

# PREPARATION

## ATTACHING THE TV TO A DESK

■ Here shown may be somewhat different from your TV.

The TV must be attached to a desk so it cannot be pulled in a forward/backward direction, potentially causing injury or damaging the product.

\* Screws - M5 x L (table depth + 8~10 mm)  
ex) table depth-15mm: Bolts - M5 x 25

32/37/42LC5DC\*, 32/37/42LC50C\*, 42LB5DC, 42LB50C

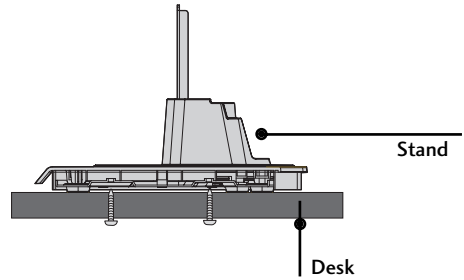
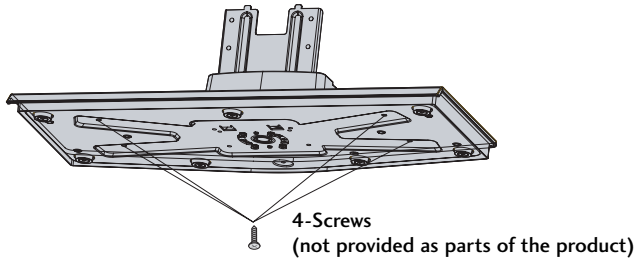

32LX5DC\*, 32LX50C\*

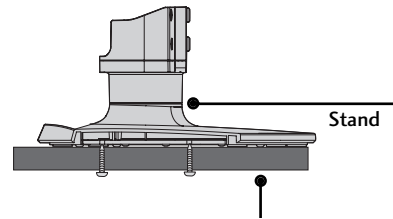
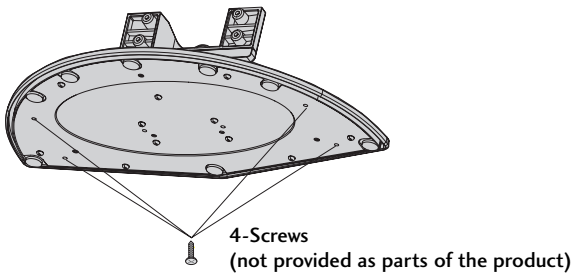

42PX8DC

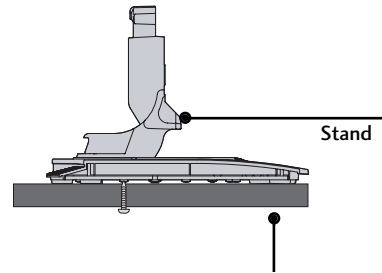
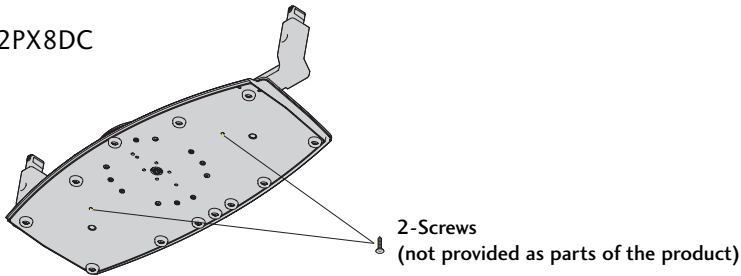

42PG65C

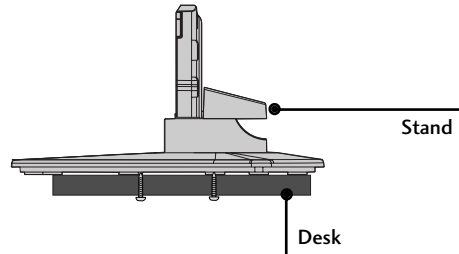
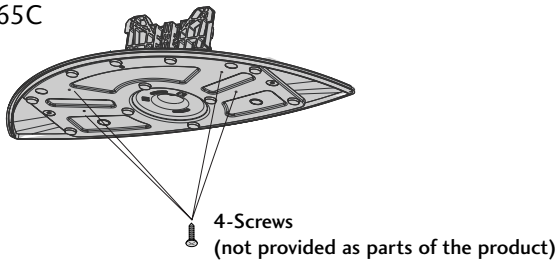

32/37/42LG500H

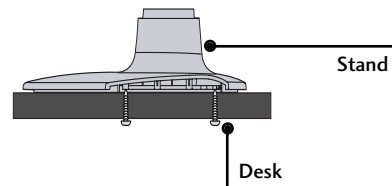
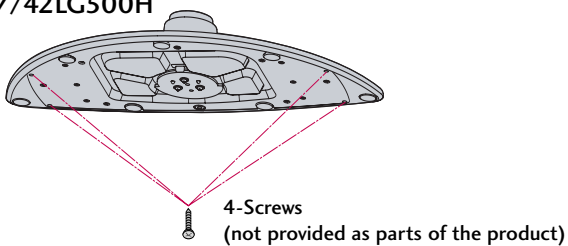

32/37/42LG500H

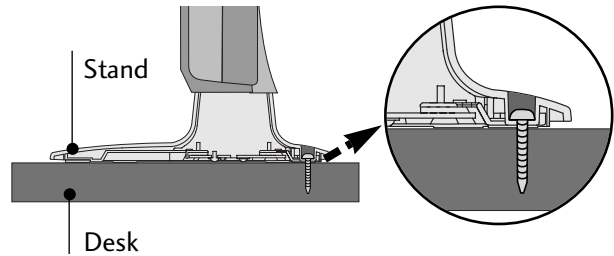
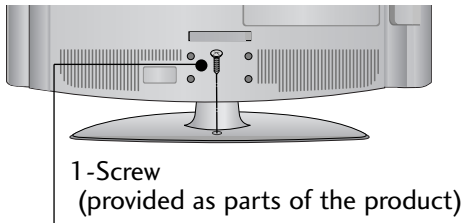

**! WARNING**

▶ To prevent TV from falling over, the TV should be securely attached to the floor/wall per installation instructions. Tipping, shaking, or rocking the machine may cause injury.

## VESA WALL MOUNTING

This product accepts a VESA-compliant mounting interface pad. (optional)

There 4 threaded holes are available for attaching the bracket.

- This feature is not available for all models.

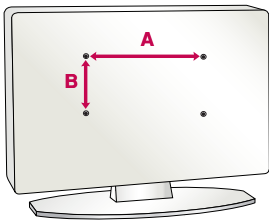

Product	Model	VESA (A * B)
LCD TV	32LC5DC*, 32LC50C*, 32LX5DC*, 32LX50C*, 32LG500H	200 * 100
	37LG500H, 42LG500H	200 * 200
PLASMA TV	32/37/42LC5DC*, 32/37/42LC50C*, 42LB5DC, 42LB50C	600 * 400
	42PG60C	400 * 400
	42PX8DC	600 * 400

**! NOTE**

▶ Screw length needed depends on the wall mount used. For further information, refer to the VESA Wall Mounting Instruction Guide.

## DESKTOP PEDESTAL INSTALLATION

For proper ventilation, allow a clearance of 4 inches on each side from the wall.

- Image shown may differ from your TV.
- This feature is not available for all models.

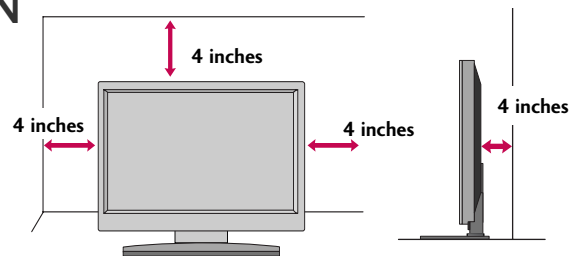

**! CAUTION**

▶ Ensure adequate ventilation by following the clearance recommendations.

# PREPARATION

## ANTENNA OR CABLE CONNECTION

### 1. Antenna (Analog or Digital)

Wall Antenna Socket or Outdoor Antenna without a Cable Box Connections.

For optimum picture quality, adjust antenna direction if needed.

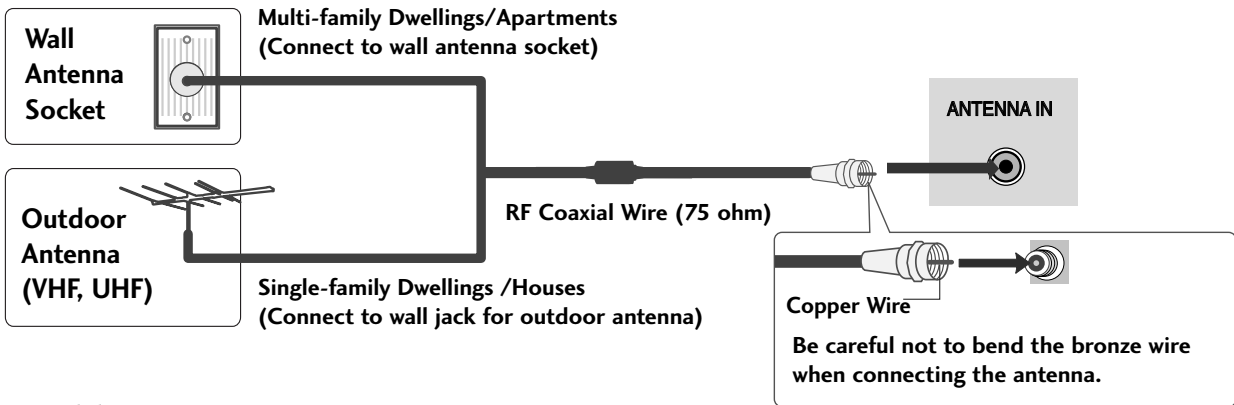

### 2. Cable

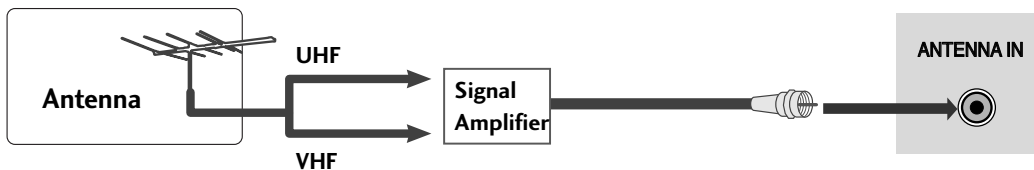
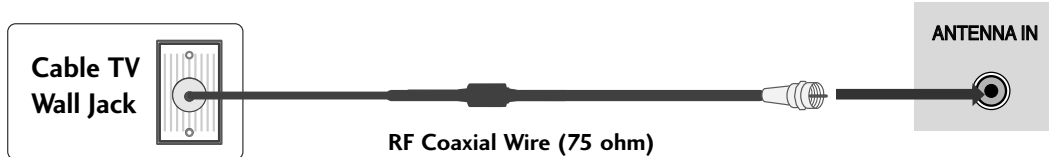

- To improve the picture quality in a poor signal area, please purchase a signal amplifier and install properly.
- If the antenna needs to be split for two TV's, install a 2-Way Signal Splitter.
- If the antenna is not installed properly, contact your dealer for assistance.

**NOTE** ▶ The TV will let you know when the analog, cable, and digital channel scans are complete.

# EXTERNAL EQUIPMENT SETUP

- To prevent the equipment damage, never plug in any power cords until you have finished connecting all equipment.
- This part of external equipment setup mainly use picture for LCD TV(Except 32/37/42LG500H) models.

## HD RECEIVER SETUP

This TV can receive Digital Over-the-air/Cable signals without an external digital set-top box. However, if you do receive digital signals from a digital set-top box or other digital external device, refer to the figure as shown below.

### When connecting Component cable

#### 1. How to connect

- 1 Connect the video outputs (Y, PB, PR) of the digital set top box to the **COMPONENT IN VIDEO** jacks on the set. Match the jack colors (Y = green, PB = blue, and PR = red).
- 2 Connect the audio output of the digital set-top box to the **COMPONENT IN AUDIO** jacks on the set.

#### 2. How to use

- Turn on the digital set-top box.  
(Refer to the owner's manual for the digital set-top box.)
- Select **Component** input source with using the **INPUT** button on the remote control.

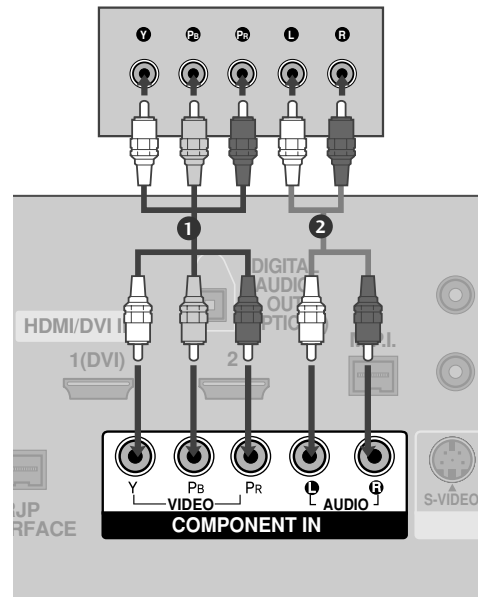

Signal	Component	HDMI1/DVI, HDMI2
480i	Yes	No
480p	Yes	Yes
720p	Yes	Yes
1080i	Yes	Yes
1080p	Yes	Yes

\* 42LB5DC, 42LB50C model only

# EXTERNAL EQUIPMENT SETUP

## When connecting HDMI cable

### 1. How to connect

- 1 Connect the digital set-top box to **HDMI/DVI IN 1 (DVI)** or **2** jack on the set.
- 2 No separated audio connection is necessary. HDMI supports both audio and video.

### 2. How to use

- Turn on the digital set-top box. (Refer to the owner's manual for the digital set-top box.)
- Select **HDMI1/DVI** or **HDMI2** input source with using the **INPUT** button on the remote control.

#### ! NOTE

- ▶ If the device does not support Auto HDMI, you need to set the output resolution appropriately.

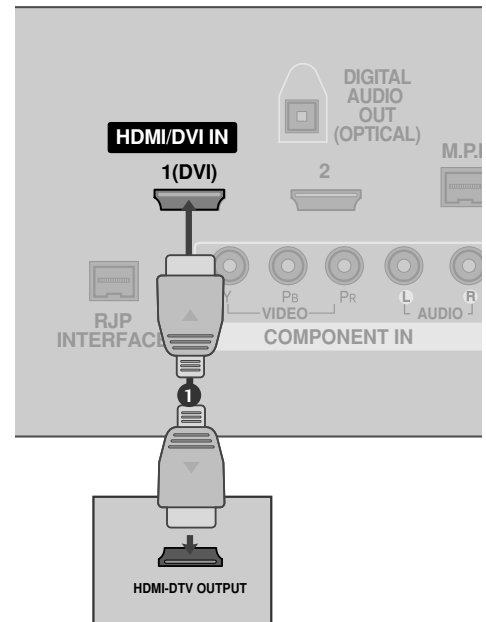

## When connecting HDMI to DVI cable

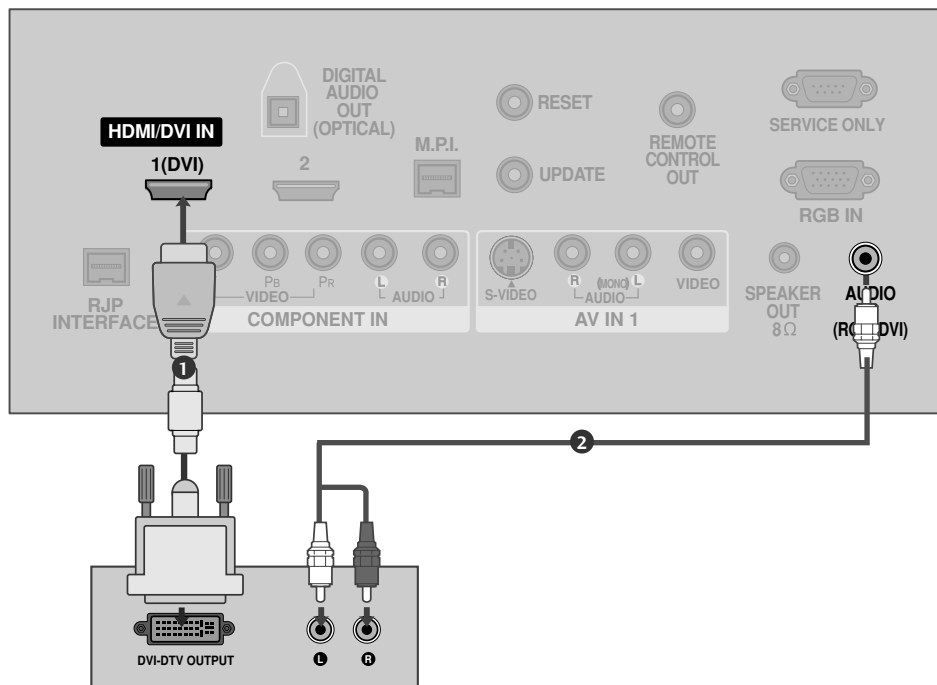

### 1. How to connect

- 1 Connect the DVI output of the digital set-top box to the **HDMI/DVI IN 1 (DVI)** or **2** jack on the set.
- 2 Connect the audio output of the digital set-top box to the **AUDIO IN (RGB, DVI)** jack on the set.

### 2. How to use

- Turn on the digital set-top box. (Refer to the owner's manual for the digital set-top box.)
- Select **HDMI1/DVI** or **HDMI2** input source with using the **INPUT** button on the remote control.

# EXTERNAL EQUIPMENT SETUP

## DVD SETUP

### When connecting Component cable

#### 1. How to connect

- 1 Connect the video outputs (Y, Pb, Pr) of the DVD to the **COMPONENT IN VIDEO** jacks on the set.  
Match the jack colors  
(Y = green, Pb = blue, and Pr = red).
- 2 Connect the audio outputs of the DVD to the **COMPONENT IN AUDIO** jacks on the set.

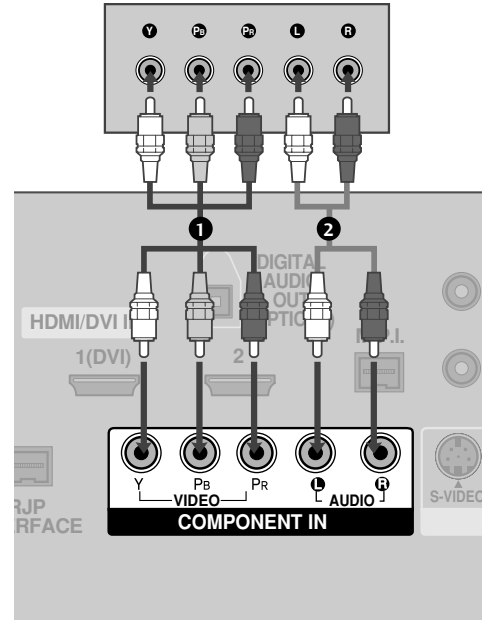

#### 2. How to use

- Turn on the DVD player, insert a DVD.
- Select **Component** input source with using the **INPUT** button on the remote control.
- Refer to the DVD player's manual for operating instructions.

#### Component Input ports

To get better picture quality, connect a DVD player to the component input ports as shown below.

Component ports on the TV	Y	P <sub>B</sub>	P <sub>R</sub>
Video output ports on DVD player	Y	P <sub>B</sub>	P <sub>R</sub>
	Y	B-Y	R-Y
	Y	C <sub>b</sub>	C <sub>r</sub>
	Y	P <sub>b</sub>	P <sub>r</sub>

## When connecting with an S-Video cable

### 1. How to connect

- 1 Connect the S-VIDEO output of the DVD to the S-VIDEO input on the set.
- 2 Connect the audio outputs of the DVD to the AUDIO input jacks on the set.

### 2. How to use

- Turn on the DVD player, insert a DVD.
- Select **AV1** input source with using the **INPUT** button on the remote control.
- If connected to **AV IN2**, select **AV2** input source.
- Refer to the DVD player's manual for operating instructions.

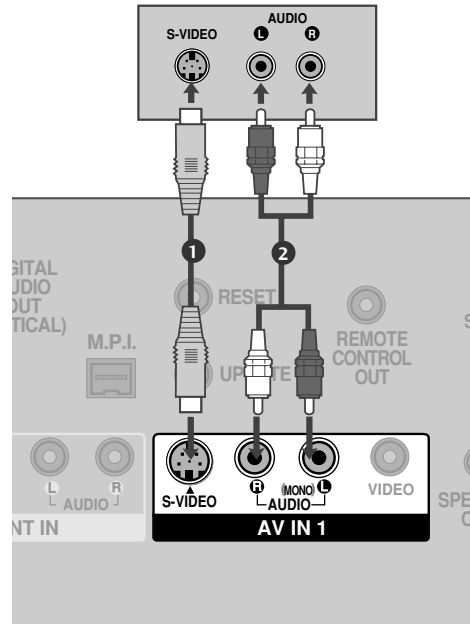

## When connecting HDMI cable

### 1. How to connect

- 1 Connect the HDMI output of the DVD to the HDMI/DVI IN 1 (DVI) or 2 jack on the set.
- 2 No separated audio connection is necessary. HDMI supports both audio and video.

### 2. How to use

- Select **HDMI1/DVI** or **HDMI2** input source with using the **INPUT** button on the remote control.
- Refer to the DVD player's manual for operating instructions.

#### ! NOTE

- ▶ If the device does not support Auto HDMI, you need to set the output resolution appropriately.

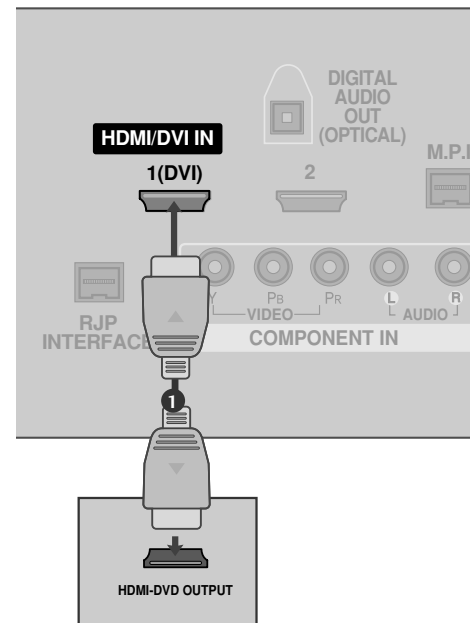

# EXTERNAL EQUIPMENT SETUP

## VCR SETUP

- To avoid picture noise (interference), leave an adequate distance between the VCR and TV.
- Use the ISM feature in the Option menu to avoid having a fixed image remain on the screen for a long period of time. (Only Plasma TV model). If the 4:3 picture format is used; the fixed images on the sides of the screen may remain visible on the screen. This phenomenon is common to all manufactures and in consequence the manufactures warranty does not cover the product bearing this phenomenon.

### When connecting with an antenna

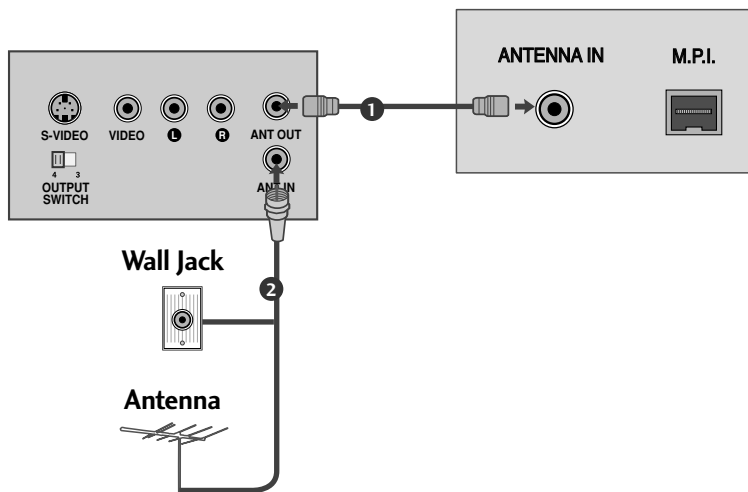

### 1. How to connect

- 1 Connect the RF antenna out socket of the VCR to the **Antenna** socket on the set.
- 2 Connect the antenna cable to the RF antenna in socket of the VCR.

### 2. How to use

- Set VCR output switch to 3 or 4 and then tune TV to the same channel number.
- Insert a video tape into the VCR and press PLAY on the VCR. (Refer to the VCR owner's manual.)

## When connecting with a RCA cable

### 1. How to connect

- 1 Connect the **AUDIO/VIDEO** jacks between TV and VCR. Match the jack colors (Video = yellow, Audio Left = white, and Audio Right = red)

### 2. How to use

- Insert a video tape into the VCR and press PLAY on the VCR. (Refer to the VCR owner's manual.)
- Select **AV1** input source with using the **INPUT** button on the remote control.
- If connected to **AV IN2**, select **AV2** input source.

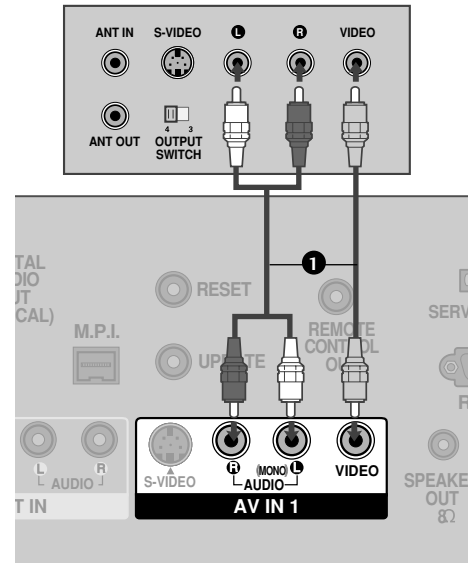

#### ! NOTE

- ▶ If you have a mono VCR, connect the audio cable from the VCR to the **AUDIO L/MONO** jack of the set.

## When connecting with an S-Video cable

### 1. How to connect

- 1 Connect the S-VIDEO output of the VCR to the **S-VIDEO** input on the set.
- 2 Connect the audio outputs of the VCR to the **AUDIO** input jacks on the set.

### 2. How to use

- Insert a video tape into the VCR and press PLAY on the VCR. (Refer to the VCR owner's manual.)
- Select **AV1** input source with using the **INPUT** button on the remote control.
- If connected to **AV IN2**, select **AV2** input source.

#### ! NOTE

- ▶ The picture quality is improved: compared to normal composite (RCA cable) input.

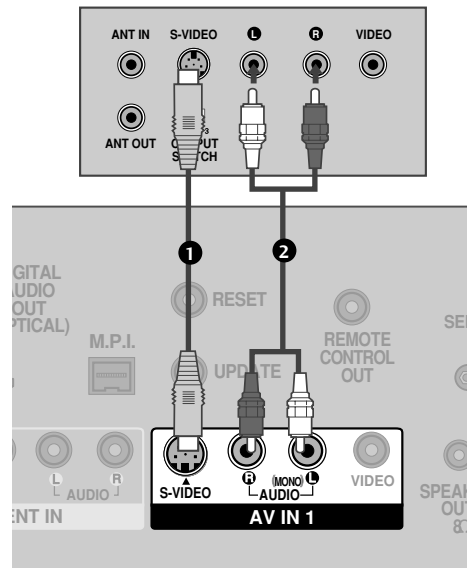

#### ! CAUTION

- ▶ Do not connect to both Video and S-Video at the same time. In the event that you connect both Video and the S-Video cables, only the S-Video will work.

# EXTERNAL EQUIPMENT SETUP

## OTHER A/V SOURCE SETUP

### 1. How to connect

- 1 Connect the **AUDIO/VIDEO** jacks between TV and external equipment. Match the jack colors. (Video = yellow, Audio Left = white, and Audio Right = red)

### 2. How to use

- Select **AV2** input source with using the **INPUT** button on the remote control.
- If connected to **AV IN1** input, select **AV1** input source.
- Operate the corresponding external equipment.

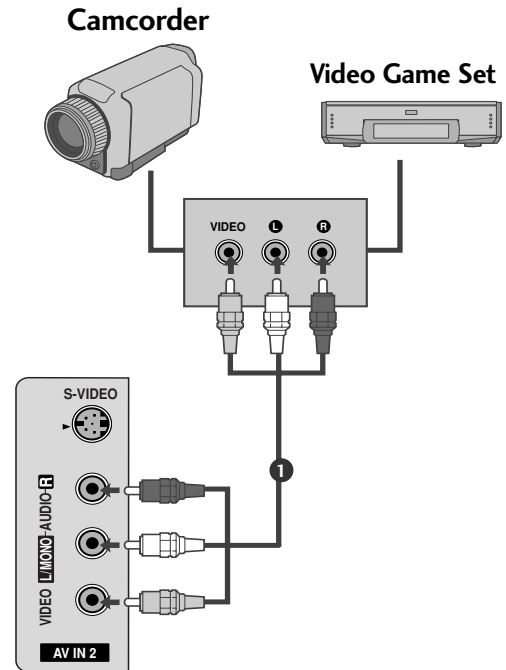

i.e) 32/37/42LC5DC\*, 32/37/42LC50C\*, 42LB5DC, 42LB50C

## DIGITAL AUDIO OUTPUT

Send the TV's audio to external audio equipment via the Digital Audio Output (Optical) port.

### 1. How to connect

- 1 Connect one end of an optical cable to the TV Digital Audio (Optical) Output port.
- 2 Connect the other end of the optical cable to the digital audio (optical) input on the audio equipment.
- 3 Set the "TV Speaker option - Off" in the AUDIO menu. (▶ p.58). See the external audio equipment instruction manual for operation.

#### ! NOTE

- ▶ When connecting with external audio equipments, such as amplifiers or speakers, please turn the TV speakers off. (▶ p.58)

#### ⚠ CAUTION

- ▶ Do not look into the optical output port. Looking at the laser beam may damage your vision.

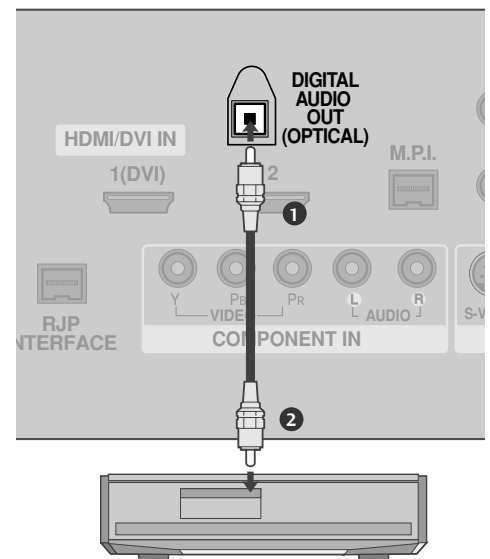

## PC SETUP

This TV provides Plug and Play capability, meaning that the PC adjusts automatically to the TV's settings.

### When connecting D-sub 15pin cable

#### 1. How to connect

- 1 Connect the RGB output of the PC to the **RGB IN** jack on the set.
- 2 Connect the PC audio output to the **AUDIO IN (RGB, DVI)** jack on the set.

#### 2. How to use

- Turn on the PC and the set.
- Select **RGB-PC** input source with using the **INPUT** button on the remote control.

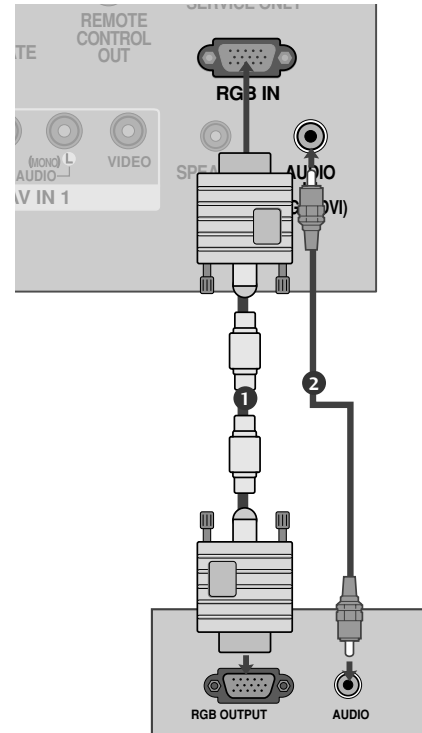

### When connecting HDMI to DVI cable

#### 1. How to connect

- 1 Connect the DVI output of the PC to the **HDMI/DVI IN 1 (DVI)** jack on the set.
- 2 Connect the PC audio output to the **AUDIO IN (RGB/DVI)** jack on the set.

#### 2. How to use

- Turn on the PC and the set
- Select **HDMI1/DVI** input source with using the **INPUT** button on the remote control.

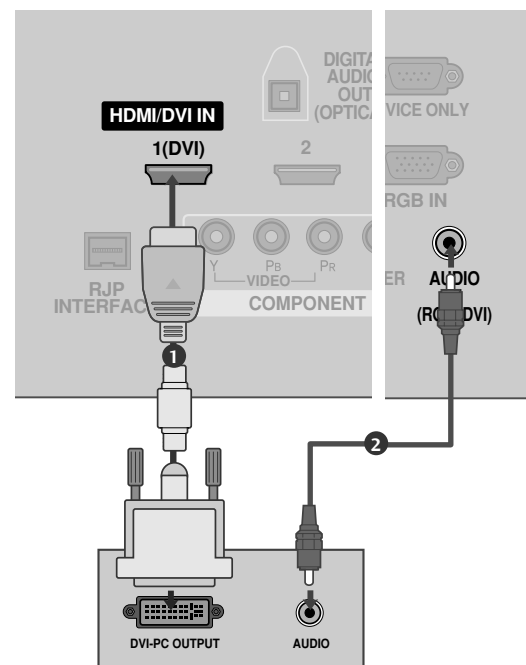

# EXTERNAL EQUIPMENT SETUP

## ! NOTES

- ▶ Depending on the graphics card, DOS mode may not work if a HDMI to DVI Cable is in use.
- ▶ Check the image on your TV. There may be noise associated with the resolution, vertical pattern, contrast or brightness in PC mode. If noise is present, change the PC output to another resolution, change the refresh rate to another rate or adjust the brightness and contrast on the VIDEO menu until the picture is clear. If the refresh rate of the PC graphic card can not be changed, change the PC graphic card or consult the manufacturer of the PC graphic card.
- ▶ Avoid keeping a fixed image on the screen for a long period of time. The fixed image may become permanently imprinted on the screen.
- ▶ The synchronization input form for Horizontal and Vertical frequencies is separate.

### Supported Display Specifications (RGB/HDMI1-PC)

Resolution	Horizontal Frequency(KHz)	Vertical Frequency(Hz)
640x350	31.469	70.08
640x480	31.469	59.94
	37.861	72.80
	37.500	75.00
800x600	35.156	56.25
	37.879	60.31
	48.077	72.18
	46.875	75.00
1024x768	48.363	60.00
	56.476	70.06
	60.023	75.02
1280x768	47.700	60.00
1360x768	47.720	59.799
1366x768	47.130	59.658

### Supported Display Specifications (RGB/HDMI1-DTV)

Resolution	Horizontal Frequency(KHz)	Vertical Frequency(Hz)
720x480	31.50	60.00
	31.47 (HDMI1-DTV:31.469)	59.94
1280x720	44.96	59.94
	45.00	60.00
1920x1080i	33.72	59.94
	33.75	60.00

### Supported Display Specifications (HDMI2-DTV)

Resolution	Horizontal Frequency(KHz)	Vertical Frequency(Hz)
720x480	31.500	60.00
	31.469	59.94
1280x720	44.960	59.94
	45.000	60.00
1920x1080i	33.720	59.94
	33.750	60.00

### Supported Display Specifications (Y, CB/PB, CR/PR)

Resolution	Horizontal Frequency(KHz)	Vertical Frequency(Hz)
720x480	15.73	59.94
	15.73	60.00
	31.47	59.94
1280x720	31.50	60.00
	44.96	59.94
	45.00	60.00
1920x1080i	33.72	59.94
	33.75	60.00

\* RGB-DOS mode only: 640x350

\* Except 42PG60C/65C models in HDMI1-PC mode.

\* 42LB5DC, 42LB50C

**Supported Display Specifications (RGB/HDMI1-PC)**

Resolution	Horizontal Frequency(KHz)	Vertical Frequency(Hz)
640x350 (RGB only)	31.469	70.08
640x480	31.469	59.94
	37.861	72.80
	37.500	75.00
800x600	35.156	56.25
	37.879	60.31
	48.077	72.18
	46.875	75.00
1024x768	48.363	60.00
	56.476	70.06
	60.023	75.02
1280x768	47.700	60.00
1360x768	47.720	59.799
1366x768	47.130	59.658
1280x1024 (RGB only)	63.668	59.895
1400x1050 (RGB only)	65.317	59.978
1600x1200	74.537	59.869
1920x1080	66.587	59.934
1920x1200	74.038	59.950

**Supported Display Specifications (RGB/HDMI1-DTV)**

Resolution	Horizontal Frequency(KHz)	Vertical Frequency(Hz)
720x480	31.50	60.00
	31.47 (HDMI1-DTV:31.469)	59.94
1280x720	44.96	59.94
	45.00	60.00
1920x1080	33.72	59.94
	33.75	60.00
	67.43 (HDMI1-DTV:67.5)	59.94

**Supported Display Specifications (HDMI2-DTV)**

Resolution	Horizontal Frequency(KHz)	Vertical Frequency(Hz)
720x480	31.500	60.00
	31.469	59.94
1280x720	44.960	59.94
	45.000	60.00
1920x1080	33.720	59.94
	33.750	60.00
	67.500	60.00

**Supported Display Specifications (Y, CB /PB, CR /PR)**

Resolution	Horizontal Frequency(KHz)	Vertical Frequency(Hz)
720x480	15.73	59.94
	15.73	60.00
	31.47	59.94
1280x720	31.50	60.00
	44.96	59.94
1920x1080	45.00	60.00
	33.72	59.94
1920x1080	33.75	60.00
	67.50	60.00

\* RGB-DOS mode only: 640x350

# WATCHING TV / CHANNEL CONTROL

## REMOTE CONTROL FUNCTIONS

When using the remote control, aim it at the remote control sensor on the TV.

<b>POWER</b>	Turns your TV or any other programmed equipment on or off, depending on mode.
<b>TV INPUT</b>	In AV 1-2, Component, RGB, HDMI1/DVI, and HDMI2 input sources, screen returns to the last TV channel.
<b>INPUT</b>	External input modes rotate in regular sequence: TV, AV1-2, Component, RGB, HDMI1/DVI and HDMI2.
<b>MULTI</b>	Selects: RGB, HDMI1/DVI, HDMI2 and Component input sources.
-  +	Adjusts brightness on screen.
<b>PIP</b>	Switches the sub picture Double Window or off mode. ▶ p.41-42
<b>PIP CH +/-</b>	Changes the PIP channel. ▶ p.42
<b>PIP INPUT</b>	Select the connected input source for the sub-picture. ▶ p.41
<b>EZ PIC</b>	Selects the factory preset picture depend on the viewing environment. ▶ p.45
<b>EZ SOUND</b>	Selects the factory preset sound for type of program. ▶ p.55
<b>SWAP(or PIP SWAP)</b>	Exchange the main/sub images. ▶ p.42
<b>VCR/DVD control buttons</b>	Control video cassette recorders or DVD players.
<b>NUMBER button</b>	
<b>— (DASH)</b>	Used to enter a program number for multiple program channels such as 2-1, 2-2, etc.
<b>FLASH BACK</b>	Tune to the last channel viewed.

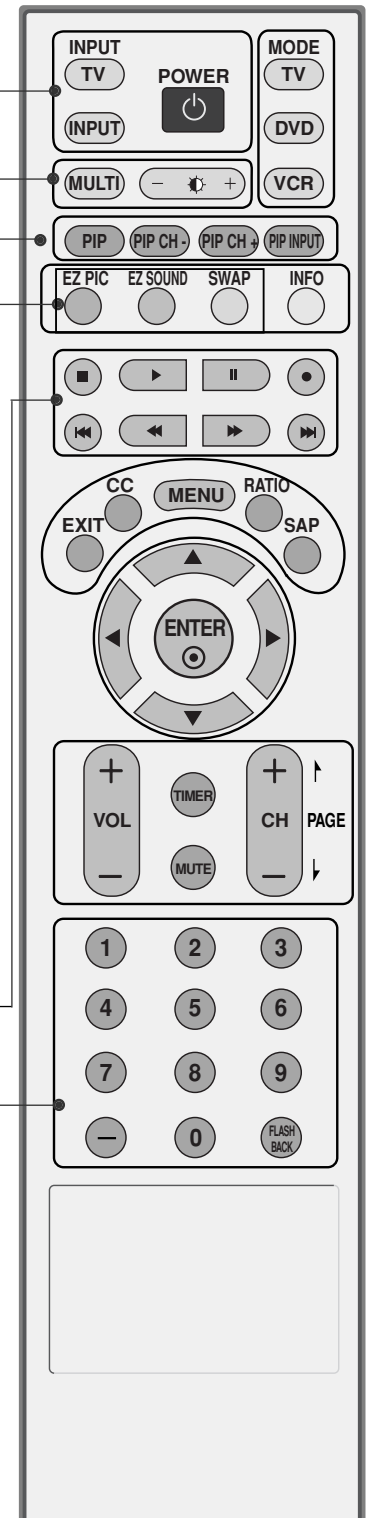

(Only 42PG60C, 42PG65C, 32/37/42LG500H models)

**MODE** Select the remote's operating mode: TV, DVD, VCR (or STB).

**RATIO** Change the aspect ratio. ▶ **p.43-44**

**CC** Select a closed caption. ▶ **p.62** (\*In DTV/CADTV mode ▶ **p.63**)

**THUMBSTICK** Navigate the on-screen menus and adjust the system settings to your preference.  
(Up/Down/Left/Right/ENTER)

**EXIT**(or **RETURN**) Clears all on-screen displays and returns to TV viewing from any menu.

**MENU** Displays the main menu.

**INFO** Display information at the top of the screen.

**VOLUME UP/DOWN** Increase/decrease the sound level.

**TIMER** Select the amount of time before your TV turns off automatically. ▶ **p.69**

**MUTE** Switch the sound on or off. ▶ **p.34**

**CHANNEL UP/DOWN** Select available channels.

**PAGE UP/DOWN** Move from one full set of screen information to the next one.

### Installing Batteries

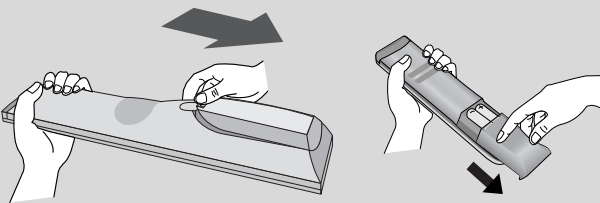

- Open the battery compartment cover on the back side and install the batteries matching correct polarity (+ with +, - with -).
- Install two 1.5V AA batteries(or 1.5V AAA)  
Don't mix old or used batteries with new ones.
- Close cover.

# WATCHING TV /CHANNEL CONTROL

## TURNING ON TV

---

- 1** First, connect power cord correctly.  
At this moment, the TV switches to standby mode.
    - In standby mode to turn TV on, press the  $\phi/I$  (or **ON/OFF**) button on the TV or press the **POWER** button on the remote control.
  - 2** Select the viewing source by using the **INPUT(or TV INPUT)** button on the remote control.
    - This TV is programmed to remember which power state it was last set to, even if the power cord is out.
  - 3** When finished using the TV, press the **POWER** button on the remote control. The TV reverts to standby mode.
- 

### ! NOTE

- ▶ If you intend to be away on vacation, disconnect the power plug from the wall power outlet.

## CHANNEL SELECTION

---

- 1** Press the **CH (+ or -)** or **CH (^ or v)** or **NUMBER** buttons to select a channel number.
- 

## VOLUME ADJUSTMENT

Adjust the volume to suit your personal preference.

---

- 1** Press the **VOL (+ or -)** button to adjust the volume.
  - 2** If you want to switch the sound off, press the **MUTE** button.
  - 3** You can cancel the Mute function by pressing the **MUTE** or **VOL (+ or -)** button.
-

# ON-SCREEN MENUS SELECTION

Your TV's OSD (On Screen Display) may differ slightly from what is shown in this manual.

- 1 Press the **MENU** button and then use **▲** or **▼** or **▲** or **▼** button to select the each menu.
- 2 Press the **▶** or **>** button and then use **▲** **▼** **◀▶** or **▲** **▼** **<** **>** button to display the available menus.

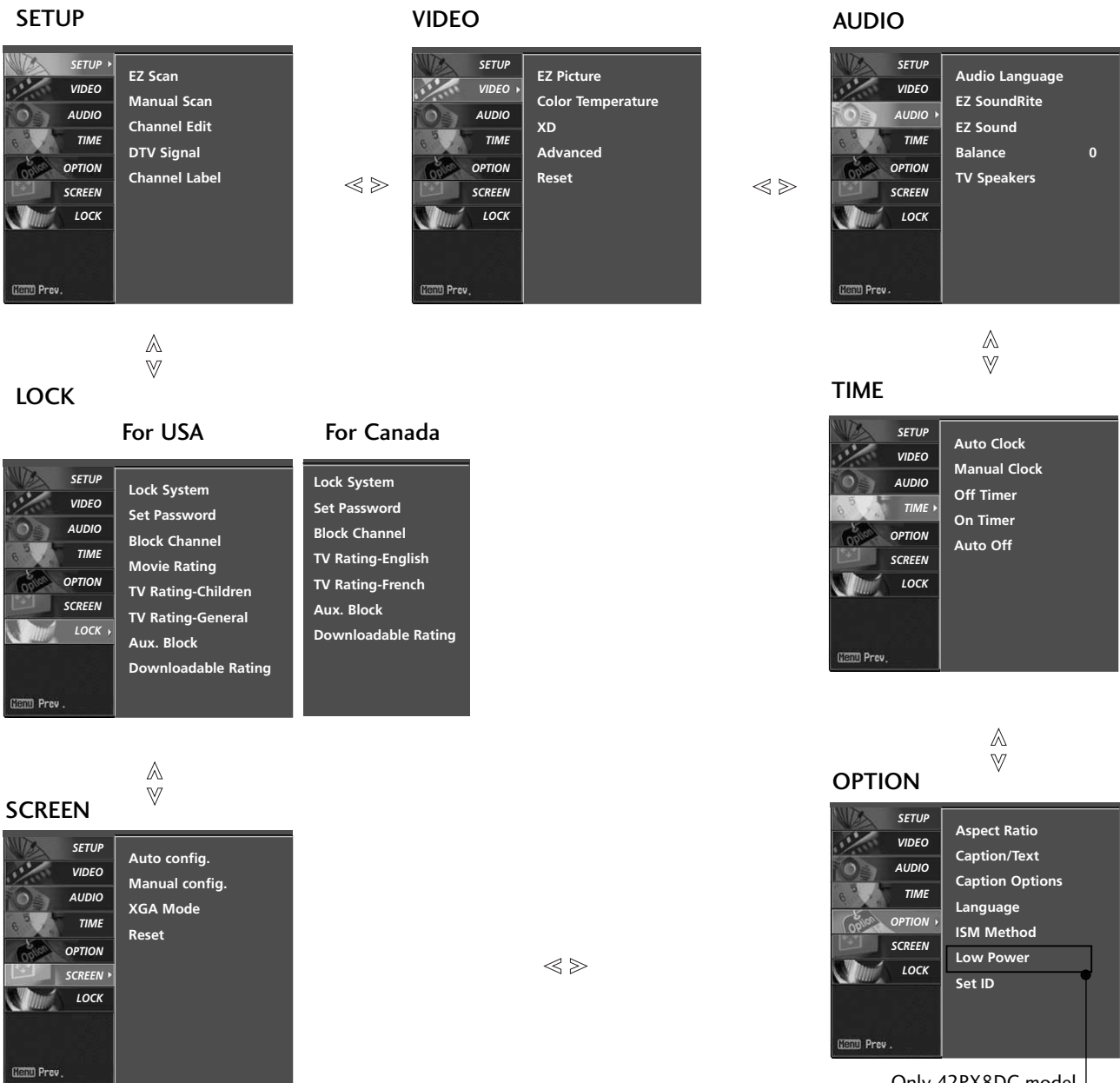

Only 42PX8DC model

# WATCHING TV /CHANNEL CONTROL

## CHANNEL SETUP

### Auto Scan (EZ Scan)

Automatically finds all channels available through antenna or cable inputs, and stores them in memory on the channel list.

Run EZ Scan again after any Antenna/Cable connection changes.

A password is required to gain access to EZ Scan menu if the Lock System is turned on.

- 1 Press the **MENU** button and then use **▲** or **▼** or **^** or **v** button to select the **SETUP** menu.
- 2 Press the **▶** or **>** button and then use **▲** or **▼** or **^** or **v** button to select **EZ Scan**.
- 3 Press the **ENTER** button to begin the channel search. Allow **EZ Scan** to complete the channel search cycle for **ANTENNA** and **CABLE**.

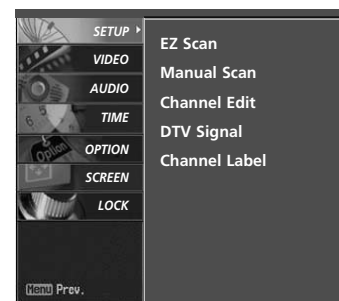

1

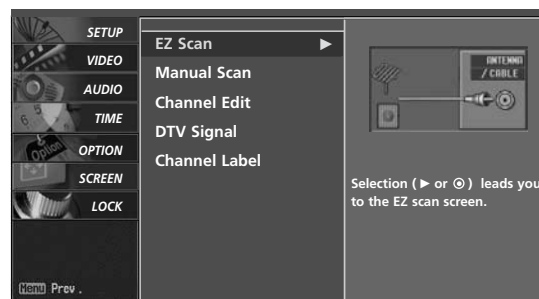

2

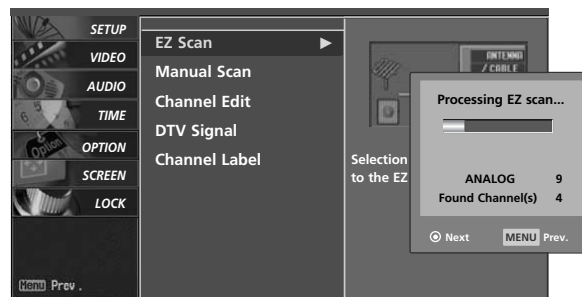

3

## Add/Delete Channel (Manual Scan)

A password is required to gain access to Manual Scan menu if the Lock System is turned on.

- 1 Press the **MENU** button and then use **▲** or **▼** or **^** or **v** button to select the **SETUP** menu.
- 2 Press the **▶** or **>** button and then use **▲** or **▼** or **^** or **v** button to select **Manual Scan**.
- 3 Press the **▶** or **>** button and then use **▲** or **▼** or **^** or **v** button to select Analog(**TV, CATV**), Digital(**DTV, CADTV**).
- 4 Press the **▶** or **>** button and then use **▲** or **▼** or **^** or **v** button to select channel you want to add or delete.
- 5 Press the **ENTER** button to add or delete the channel.
- 6 Press the **EXIT** or **RETURN** button to return to TV viewing or press **MENU** button to return to the previous menu.



1

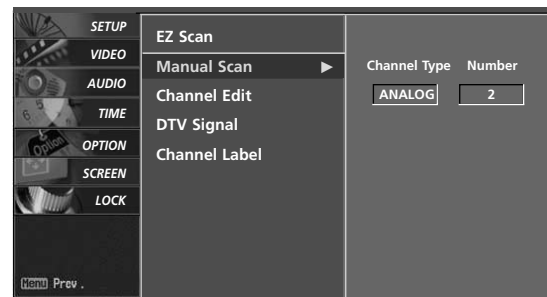

2

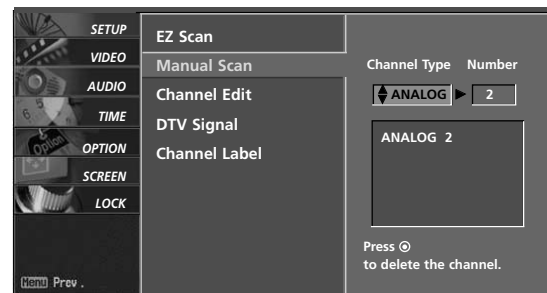

3 4 5

# WATCHING TV / CHANNEL CONTROL

## Channel Editing

A Custom List can be created by toggling each channel on or off with ENTER button. The channels in the Custom List are displayed in black, and the channels deleted from the Custom List are displayed in gray. Once a channel is highlighted you can add or delete the channel by referring to the small window at the top-left corner of the screen.

A password is required to gain access to Manual Scan menu if the Lock System is turned on.

1 Press the **MENU** button and then use ▲ or ▼ or ^ or v button to select the **SETUP** menu.

2 Press the ► or > button and then use ▲ or ▼ or ^ or v button to select **Channel Edit**.

3 Press the ► or > button and then use ▲ or ▼ or ^ or v button to select **ANALOG** or **DIGITAL**.

4 Press the ► or > button and then use ▲ or ▼ or ^ or v button to select channel and then use the **ENTER** button to add or delete it.

5 Press **EXIT** or **RETURN** button to return to TV viewing or press **MENU** button to return to the previous menu.



1

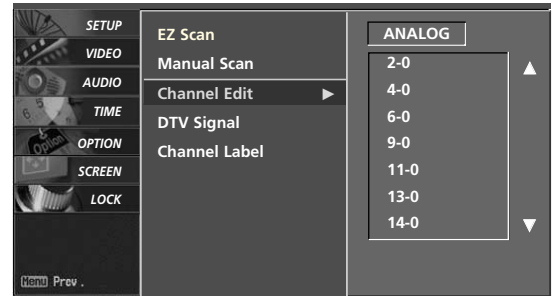

2

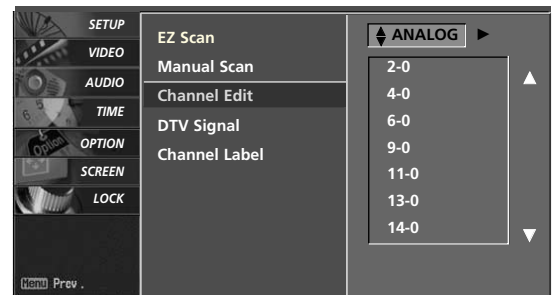

3 4

## DTV SIGNAL STRENGTH

This feature displays the DTV signal levels being received and indicates whether you need to adjust your antenna or digital cable input. The higher the signal strength, the less likely you are to experience picture degradation.

**DTV Signal:** This function is only available when the input signal is DTV or CADTV.

- 1 Press the **MENU** button and then use ▲ or ▼ or ^ or v button to select the **SETUP** menu.
- 2 Press the ► or > button and then use ▲ or ▼ or ^ or v button to select **DTV Signal**.
- 3 View the on-screen signal strength monitor to see the quality of the signal being received.
- 4 Press **EXIT** or **RETURN** button to return to TV viewing or press **MENU** button to return to the previous menu.



1



2 3

# WATCHING TV /CHANNEL CONTROL

## CHANNEL LABEL

Choose preset labels for your channels.

If a channel label is provided on the signal from the broadcasting station, the TV displays a short name for a channel even if you didn't preset a label for the channel.

- 1 Press the **MENU** button and then use ▲ or ▼ or ^ or v button to select the **SETUP** menu.
- 2 Press the ► or > button and then use ▲ or ▼ or ^ or v button to select **Channel Label**.
- 3 Press the ► or > button and then use ▲ or ▼ or ^ or v button to select a channel to label.
- 4 Press the ► or > button and then use ▲ or ▼ or ^ or v button to select the appropriate label for the channel.
- 5 Press **EXIT** or **RETURN** button to return to TV viewing or press **MENU** button to return to the previous menu.



1

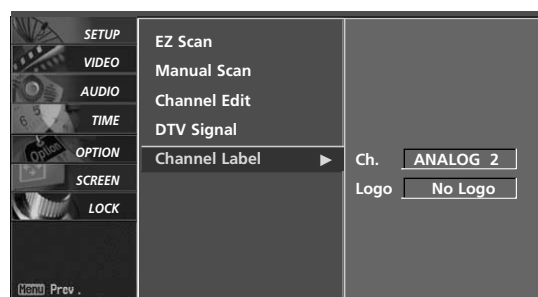

2 3

# PICTURE CONTROL

## WATCHING DW (DOUBLE WINDOW)

Double Window mode splits the screen into two images, allowing two picture sources to be shown on the TV screen at the same time. Each source is given half the screen.

### Watching Double Window

Press the **PIP** button to access the sub picture.



### Selecting an Input Signal Source for Double Window

Use the **PIP INPUT** button to select the input source for the sub picture. Each press of **PIP INPUT** button changes the PIP source.

Use the **PIP INPUT** button to select the input source for the sub picture. Each press of **PIP INPUT** button changes the PIP source.

Main Picture Source	Available Sub Picture Sources
TV	AV1, AV2
AV1	TV, AV2
AV2	TV, AV1
RGB, Component, HDMI1/DVI, HDMI2	TV, AV1, and AV2

# PICTURE CONTROL

## TV Program Selection for PIP

---

- 1 Use the **PIP CH +/-** button to select a channel for the sub picture.  
The selected channel number is displayed just below the input source of main picture.
- 

## Swapping the PIP / Double Window

---

- 1 Repeatedly, use the **SWAP** or **PIP SWAP** button to switch the main and sub pictures.
    - Component, RGB, HDMI1/DVI, HDMI2 input sources for the main picture can't be used to swap the main and sub pictures.
-

## PICTURE SIZE (ASPECT RATIO) CONTROL

This feature allows an analog picture with a 4:3 aspect ratio is displayed on your TV. When you receive an analog picture with a 4:3 aspect ratio on your 16:9 TV, you need to specify how the picture is to be displayed.

- RGB-PC/DVI-PC input source use 4:3 or 16:9 aspect ratio.

- 1 Press the **RATIO** button repeatedly to select the desired picture format.
  - You can also adjust **Aspect Ratio** in the **OPTION** menu.

### Set by program

Selects the proper picture proportion to match the source's image.

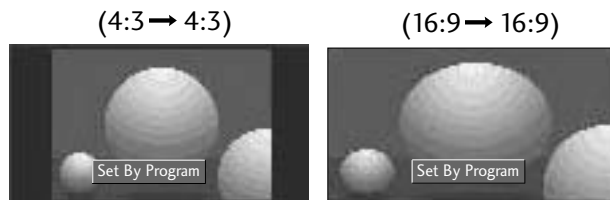

### 4:3

Choose 4:3 when you want to view a picture with an original 4:3 aspect ratio.

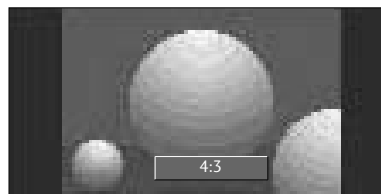

### 16:9

Adjust the picture horizontally, in a linear proportion to fill the entire screen.

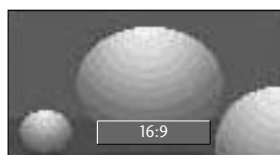

# PICTURE CONTROL

## Horizon

The screen size is, more enlarged at both sides, to create a spectacular view.



## Zoom 1

Choose Zoom 1 when you want to view the picture without any alteration. However, the top and bottom portions of the picture will be cropped.

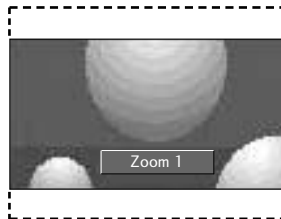

## Zoom 2

Choose Zoom 2 when you want the picture to be altered, both vertically extended and cropped. The picture taking a halfway trade off between alteration and screen coverage.

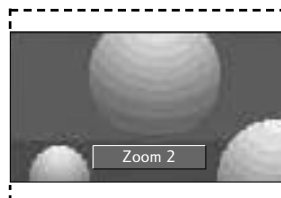

# PRESET PICTURE SETTINGS

## EZ Picture - Preset

EZ Picture adjusts the TV for the best picture appearance. Select the preset value in the EZ Picture menu based on the program category.

**Daylight, Normal, Night Time** Settings are preset for the optimum picture quality at the factory and are not adjustable.

In the **User1** and **User2** modes only, user can directly adjust the contrast, brightness, color, sharpness, tint.

- 1 Press the **EZ PIC** button repeatedly to select the picture appearance setup option as below(Except 42PG60C, 42PG65C models):  
**Daylight, Normal, Night Time, User1, and User2** (your own settings).

- 2 Press the **EXIT** or **RETURN** button to save and return to TV viewing.

■ You can also use the **VIDEO** menu to adjust **EZ Picture**.

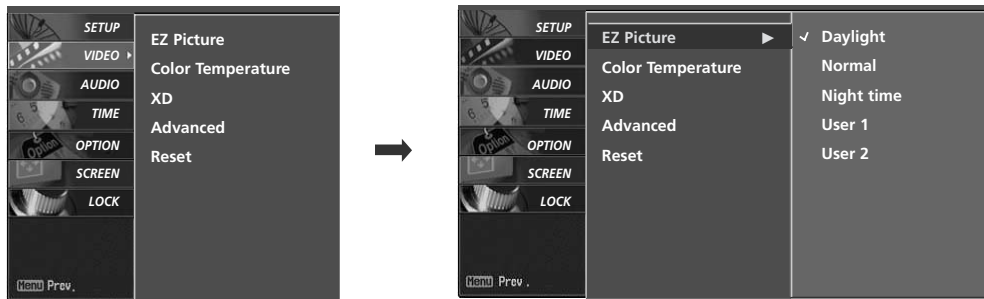

# PICTURE CONTROL

## Color Tone - Preset

Choose one of three automatic color adjustments. Set to warm to enhance hotter colors such as red, or set to cool to see less intense colors with more blue.

When selecting EZ Picture (User 1 and User 2), you can choose the Color Temperature.

**1** Press the **MENU** button and then use ▲ or ▼ or ^ or v button to select the **VIDEO** menu.

**2** Press the ► or > button and then use ▲ or ▼ or ^ or v button to select **Color Temperature**.

**3** Press the ► or > button and then use ▲ or ▼ or ^ or v button to select either **Cool**, **Normal**, **Warm** or **User**.

**4** Press **EXIT** or **RETURN** button to return to TV viewing or press **MENU** button to return to the previous menu.

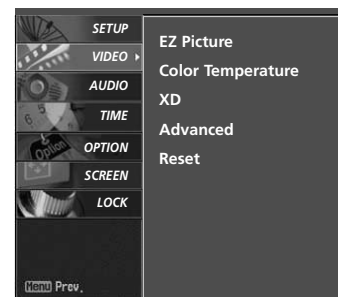

1

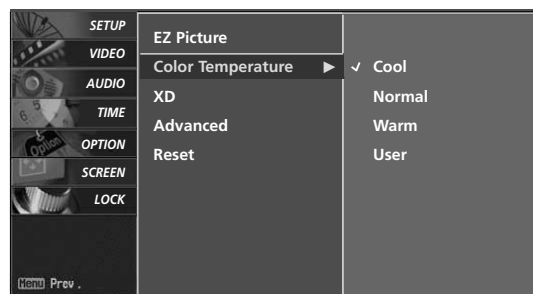

2 3

# MANUAL PICTURE ADJUSTMENT

## EZ Picture - User Mode

Adjust the picture appearance to suit your preference and viewing situations.

This feature operate only if the EZ Picture set **User 1** or **User 2**.

- 1 Press the **MENU** button and then use ▲ or ▼ or ^ or v button to select the **VIDEO** menu.
- 2 Press the ► or > button and then use ▲ or ▼ or ^ or v button to select **EZ Picture**.
- 3 Press the ► or > button and then use ▲ or ▼ or ^ or v button to select **User 1** or **User 2**.
- 4 Press the ► or > button and then use ▲ or ▼ or ^ or v button to select the desired picture option (**Contrast, Brightness, Color, Sharpness, or Tint**).
- 5 Press the ► or > button and then use ◀ or ▶ or < or > button to make appropriate adjustments.
- 6 Press **EXIT** or **RETURN** button to return to TV viewing or press **MENU** button to return to the previous menu.

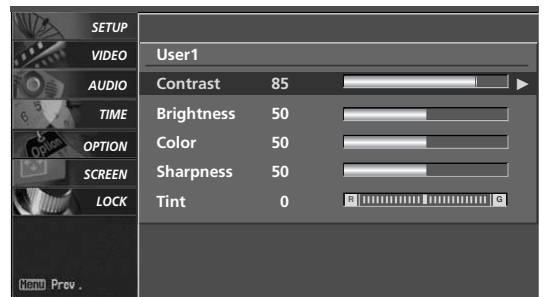
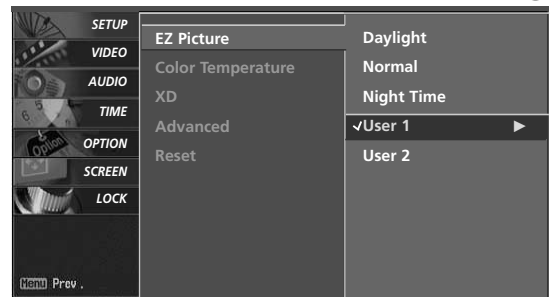
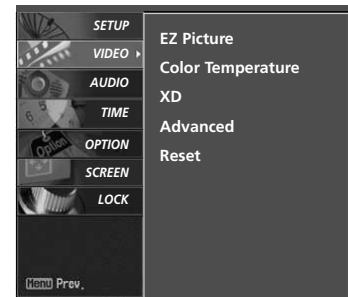

# PICTURE CONTROL

## Color Tone - User Mode

You can also adjust the detailed settings (Red, Green, Blue) by selecting the **Color Temperature-User** menu.

1 Press the **MENU** button and then use ▲ or ▼ or ^ or v button to select the **VIDEO** menu.

2 Press the ► or > button and then use ▲ or ▼ or ^ or v button to select **Color Temperature**.

3 Press the ► or > button and then use ▲ or ▼ or ^ or v button to select **User**.

4 Press the ► or > button and then use ▲ or ▼ or ^ or v button to select **Red, Green, or Blue**.

5 Press the ► or > button and then use ◀ or ▶ or < or > button to make appropriate adjustments.

- The adjustment range of **Red, Green, or Blue** is -40 ~ +40.

6 Press **EXIT** or **RETURN** button to return to TV viewing or press **MENU** button to return to the previous menu.

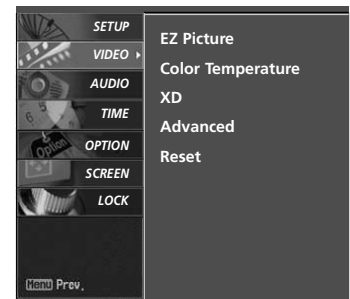

1

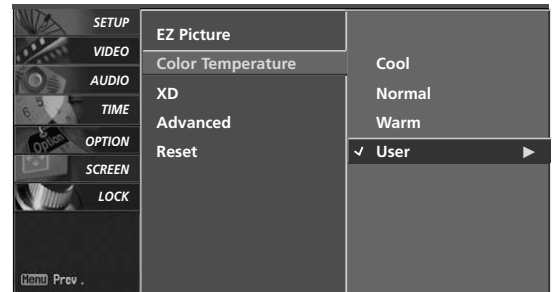

2 3

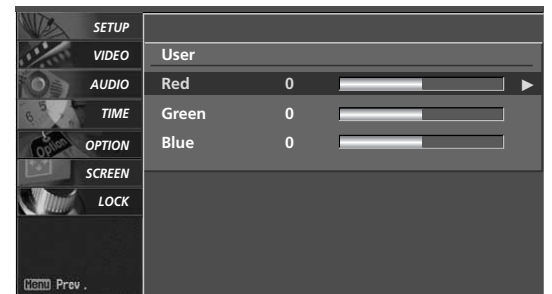

4



5

# XD - PICTURE IMPROVEMENT TECHNOLOGY

XD is LG Electronic's unique picture improving technology to display a real HD source through an advanced digital signal processing algorithm.

When selecting EZ Picture options (Daylight, Normal and Night time), XD is automatically changed to Auto.

When selecting EZ Picture options (User 1 and User 2), you can choose the Auto / Manual.

When selecting the Manual, you can adjust the XD Contrast, XD color and XD Noise.

**1** Press the **MENU** button and then use **▲** or **▼** or **^** or **v** button to select the **VIDEO** menu.

**2** Press the **▶** or **>** button and then use **▲** or **▼** or **^** or **v** button to select **XD**.

**3** Press the **▶** or **>** button and then use **▲** or **▼** or **^** or **v** button to select **Auto** or **Manual**.

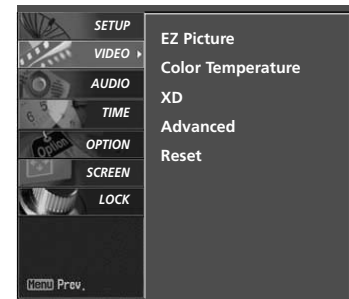

**1**

## Selecting the Manual Mode

- Press the **▶** or **>** button and then use **▲** or **▼** or **^** or **v** button to select **XD Contrast**, **XD Color** or **XD NR (Noise)**, **MPEG NR**.
  - **XD Contrast:** Optimizing the contrast automatically according to the brightness of the reflection.
  - **XD Color:** Adjusting the colors of the reflection automatically to reproduce as closely as possible to the natural colors.
  - **XD NR (Noise):** Removing the noise up to the point where it does not damage the original picture.
  - **MPEG NR:** To reduce the picture noise which may appear on the screen during watching the TV.
- Press the **◀** or **▶** or **<** or **>** button to select **On** or **Off**.

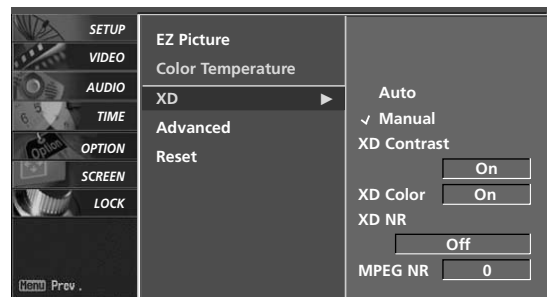

**2 3**

**4** Press **EXIT** or **RETURN** button to return to TV viewing or press **MENU** button to return to the previous menu.

# PICTURE CONTROL

## ADVANCED - CINEMA MODE

Set up the TV for the best picture appearance for viewing movies.

When you operate Cinema (3:2 Pull-Down Mode or Cinema Correction Mode), the TV will adjust 24 fps video from movies to 30 fps video for display.

This feature operates only in Analog, AV1, AV2, and Component 480i mode.

1 Press the **MENU** button and then use ▲ or ▼ or ^ or v button to select the **VIDEO** menu.

2 Press the ► or > button and then use ▲ or ▼ or ^ or v button to select **Advanced**.

3 Press the ► or > button and then use ▲ or ▼ or ^ or v button to select **Cinema**.

4 Press the ► or > button and then use ▲ or ▼ or ^ or v button to select **On** or **Off**.

5 Press **EXIT** or **RETURN** button to return to TV viewing or press **MENU** button to return to the previous menu.

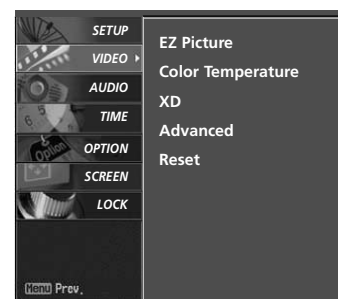

1

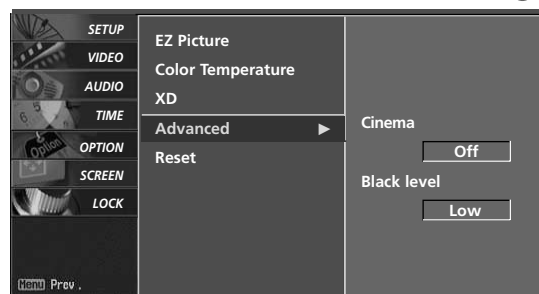

2 3 4

# ADVANCED - BLACK (DARKNESS) LEVEL

Adjusting the contrast and the brightness of the screen using the black level of the screen.

This feature operates only in AV1, AV2, HDMI1/DVI, or HDMI2mode.

1 Press the **MENU** button and then use ▲ or ▼ or ^ or v button to select the **VIDEO** menu.

2 Press the ► or > button and then use ▲ or ▼ or ^ or v button to select **Advanced**.

3 Press the ► or > button and then use ▲ or ▼ or ^ or v button to select **Black level**.

4 Press the ► or > button and then use ▲ or ▼ or ^ or v button to select **Low** or **High**.

- **Low**  
The screen gets darker.
- **High**  
The screen gets brighter.

5 Press **EXIT** or **RETURN** button to return to TV viewing or press **MENU** button to return to the previous menu.

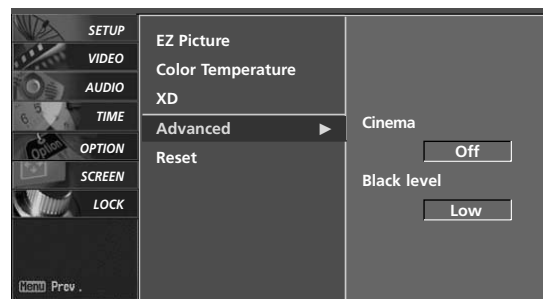
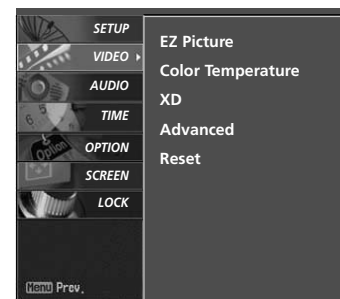

3 4

# PICTURE CONTROL

## PICTURE RESET

Use to quickly reset all the Video menu options to their original factory preset values.

- 1 Press the **MENU** button and then use ▲ or ▼ or ^ or v button to select the **VIDEO** menu.
- 2 Press the ► or > button and then use ▲ or ▼ or ^ or v button to select **Reset**.
- 3 Press the ► or > button to reset the Video menu options to original values.

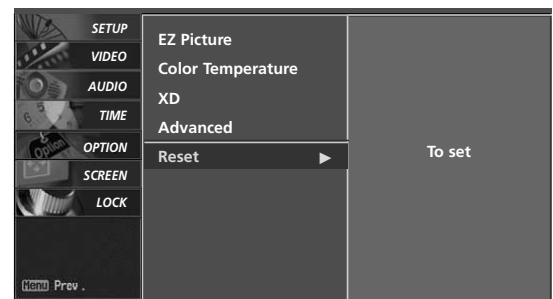
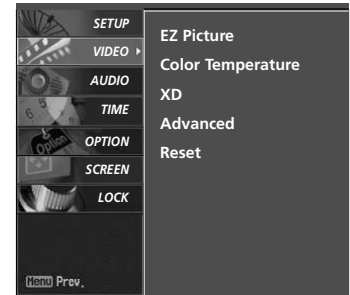

1  
2 3

## LOW-POWER PICTURE MODE (Only 42PX8DC model)

Low power reduces the plasma display power consumption.

- 1 Press the **MENU** button and then use ▲ or ▼ or ^ or v button to select the **OPTION** menu.
- 2 Press the ► or > button and then use ▲ or ▼ or ^ or v button to select **Low Power**.
- 3 Press the ► or > button and then use ▲ or ▼ or ^ or v button to select **On** or **Off**.
  - When you select On, the screen darkens.

- 4 Press **EXIT** or **RETURN** button to return to TV viewing or press **MENU** button to return to the previous menu.

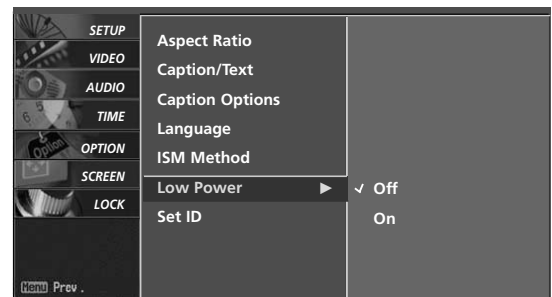
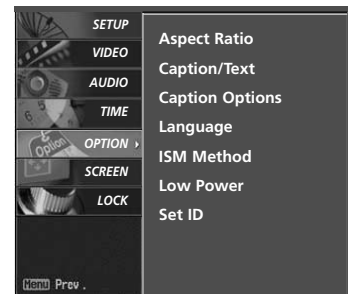

1  
2 3

# IMAGE STICKING MINIMIZATION(ISM) METHOD

A frozen still picture from a PC/video game displayed on the screen for prolonged periods will result in a ghost image. Use our unique method to minimize any fixed image on the screen.

**1** Press the **MENU** button and then use **▲** or **▼** or **^** or **∨** button to select the **OPTION** menu.

**2** Press the **▶** or **>** button and then use **▲** or **▼** or **^** or **∨** button to select **ISM Method**.

**3** Press the **▶** or **>** button and then use **▲** or **▼** or **^** or **∨** button to select either **Normal**, **White Wash**, **Orbiter** or **Inversion**.

■ **Normal**

If image sticking is never a problem, ISM is not necessary set to Normal.

■ **White wash**

White Wash removes permanent images from the screen.

**! NOTE**

▶ An excessive permanent image may be impossible to clear entirely with White Wash. To return to normal viewing, press any button.

■ **Orbiter**

Orbiter may help prevent ghost images. However, it is best not to allow any fixed image to remain on the screen. To avoid a permanent image on the screen, the image will move once per 2 minutes : Left → Right → Upside → Downside → Right → Left → Downside → Upside.

■ **Inversion**

Inversion will automatically invert the plasma display panel color every 30 minutes.

**4** Press **EXIT** or **RETURN** button to return to TV viewing or press **MENU** button to return to the previous menu.

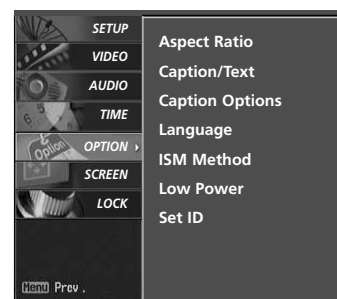

**1**

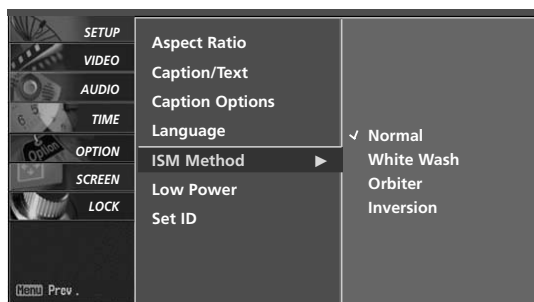

**2 3**

# SOUND & LANGUAGE CONTROL

## AUTO VOLUME LEVELER (EZ SOUNDRITE)

Scans for changes in sound levels during commercials, then adjusts the sound to match the specified audio level. SoundRite makes sure that the volume level remains consistent whether you are watching a commercial or a regular TV program.

---

**1** Press the **MENU** button and then use ▲ or ▼ or ^ or v button to select the **AUDIO** menu.

---

**2** Press the ► or > button and then use ▲ or ▼ or ^ or v button to select **EZ SoundRite**.

---

**3** Press the ► or > button and then use ▲ or ▼ or ^ or v button to select **On** or **Off**.

---

**4** Press **EXIT** or **RETURN** button to return to TV viewing or press **MENU** button to return to the previous menu.

---

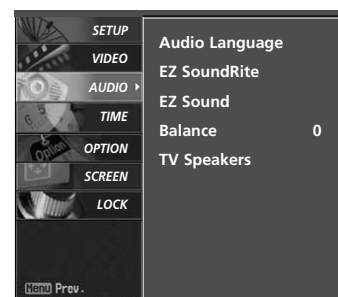

**1**

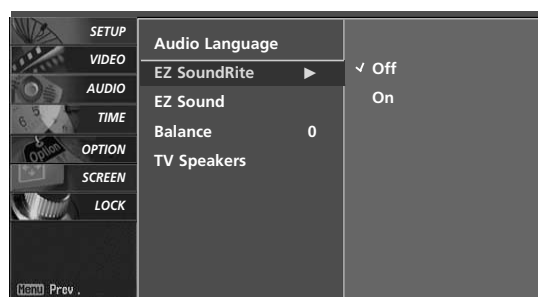

**2 3**

## PRESET SOUND SETTINGS (EZ SOUND)

EZ Sound lets you enjoy the best sound without any special adjustment because the TV sets the appropriate sound options based on the program content.

Normal, Stadium, News, Music and Theater are preset for good sound quality at the factory and are not adjustable.

- 1 Press the **EZ SOUND** button repeatedly to select the appropriate sound setup as below(Except 42PG60C, 42PG65C models):  
**Normal, Stadium, News, Music, Theater, and User** (your own settings).

- 2 Press **EXIT** or **RETURN** button to return to TV viewing.

- You can also adjust **EZ Sound** in the **AUDIO** menu.

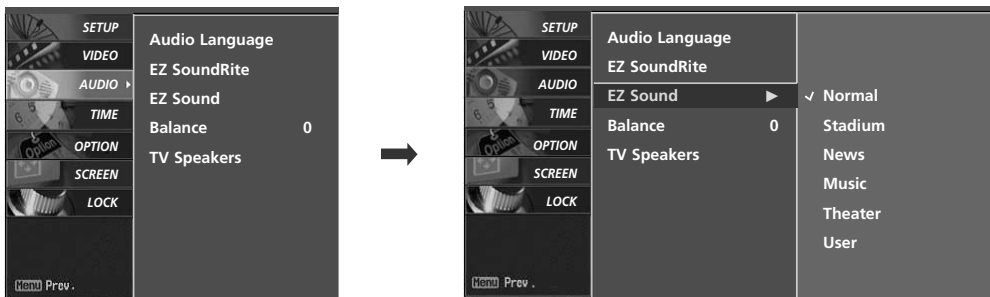

# SOUND & LANGUAGE CONTROL

## SOUND SETTING ADJUSTMENT - USER MODE

Adjust the sound to suit your taste and room situations.

**1** Press the **MENU** button and then use **▲** or **▼** or **^** or **v** button to select the **AUDIO** menu.

**2** Press the **▶** or **>** button and then use **▲** or **▼** or **^** or **v** button to select **EZ Sound**.

**3** Press the **▶** or **>** button and then use **▲** or **▼** or **^** or **v** button to select **User**.

**4** Press the **▶** or **>** button and then use **▲** or **▼** or **^** or **v** button to select the desired sound option (**Treble**, **Bass**, or **Front Surround**).

**5** Press the **▶** or **>** button and then use **◀** or **▶** or **<** or **>** button to make appropriate adjustments.

### Selecting the Front surround

Press the **▶** or **>** button and then use **◀** or **▶** or **<** or **>** button to select **Off** or **3D EchoSound System**.

**6** Press **EXIT** or **RETURN** button to return to TV viewing or press **MENU** button to return to the previous menu.

### 3D EchoSound System

Creates a stunning simulated stereo effect from any mono sound and a realistic three-dimensional sound with a very wide and deep sound stage.



1

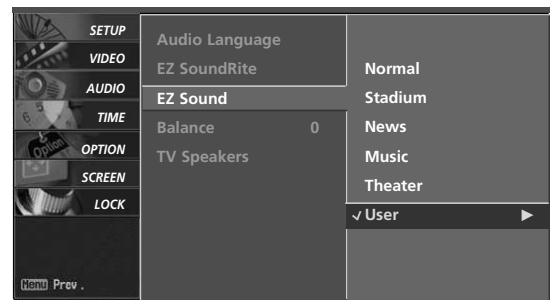

2 3

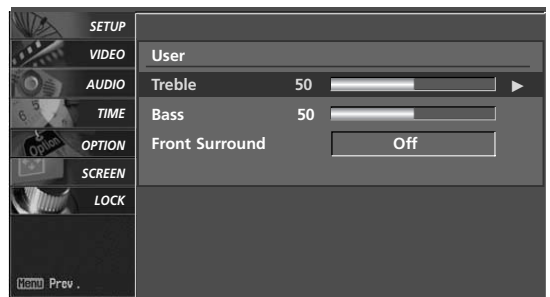

4

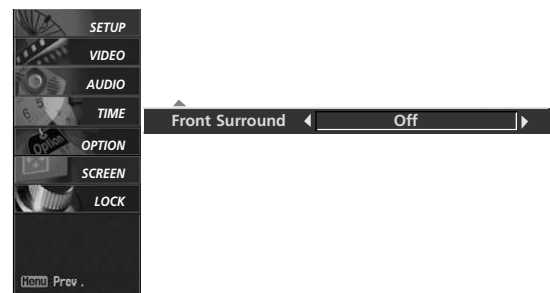

5

# BALANCE ADJUSTMENT

Adjust the left/right sound of speaker to suit your taste and room situations.

- 1 Press the **MENU** button and then use ▲ or ▼ or ^ or v button to select the **AUDIO** menu.
- 2 Press the ► or > button and then use ▲ or ▼ or ^ or v button to select **Balance**.
- 3 Press the ► or > button and then use ◀ or ▶ or < or > button to make appropriate adjustments.
- 4 Press **EXIT** or **RETURN** button to return to TV viewing or press **MENU** button to return to the previous menu.

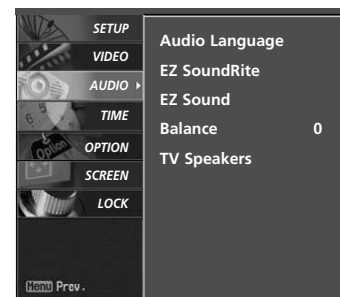

1

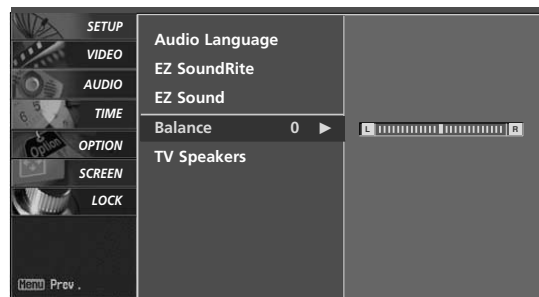

2

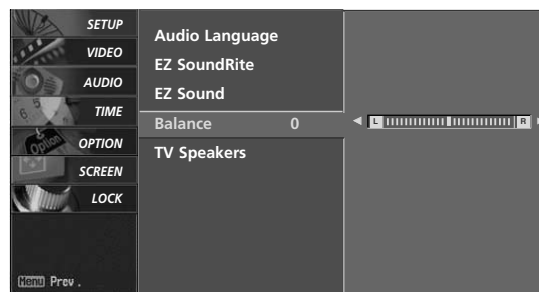

3

# SOUND & LANGUAGE CONTROL

## TV SPEAKERS ON/OFF SETUP

Turn the TV speakers off if using external audio equipment.

**1** Press the **MENU** button and then use ▲ or ▼ or ^ or v button to select the **AUDIO** menu.

**2** Press the ► or > button and then use ▲ or ▼ or ^ or v button to select **TV Speakers**.

**3** Press the ► or > button and then use ▲ or ▼ or ^ or v button to select **On** or **Off**.

**4** Press **EXIT** or **RETURN** button to return to TV viewing or press **MENU** button to return to the previous menu.

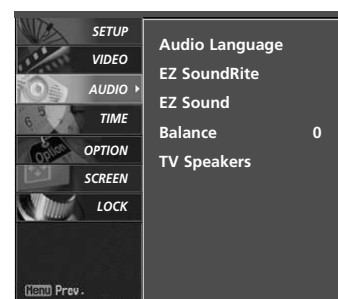

**1**

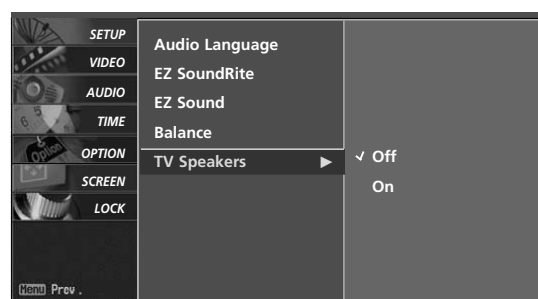

**2 3**

## STEREO/SAP BROADCAST SETUP

This TV can receive MTS stereo programs and any SAP (Secondary Audio Program) that accompanies the stereo program if the station transmits an additional sound signal as well as the original one and when you select Stereo or SAP on the remote control.

Mono sound is automatically received if the broadcast is only in Mono; even though Stereo or SAP has been selected.

Select Mono if you want to listen to the mono sound in remote areas during stereo/SAP broadcasting.

Stereo or SAP can be received in Analog channel.

- 
- 1 Use the **SAP** button to select your desired MTS mode in analog signal. Each time you press the **SAP** button, **Mono**, **Stereo**, or **SAP** appear in turn.
    - If other languages available on the digital signal, select them with the **SAP** button.

- 
- 2 Press **EXIT** or **RETURN** button to save and return to TV viewing.
-

# SOUND & LANGUAGE CONTROL

## AUDIO LANGUAGE

Other languages may be available if a digital signal is provided by the broadcasting station.

This feature operates only in DTV/CADTV mode.

**1** Press the **MENU** button and then use ▲ or ▼ or ^ or v button to select the **AUDIO** menu.

**2** Press the ► or > button and then use ▲ or ▼ or ^ or v button to select **Audio Language**.

**3** Press the ► or > button and then use ▲ or ▼ or ^ or v button to select: **English, Spanish, or French**.

**4** Press **EXIT** or **RETURN** button to return to TV viewing or press **MENU** button to return to the previous menu.

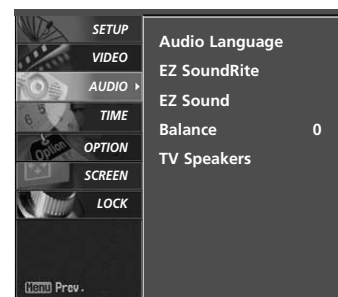

**1**

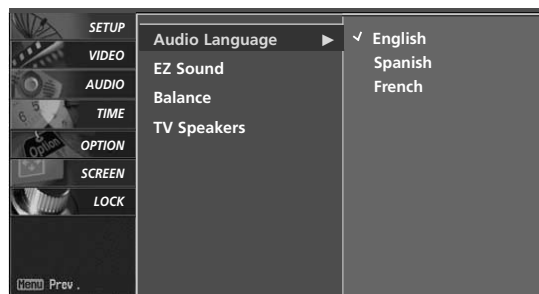

**2 3**

# ON-SCREEN MENUS LANGUAGE SELECTION

The menus can be shown on the screen in the selected language. First select your language.

- 1 Press the **MENU** button and then use ▲ or ▼ or ^ or v button to select the **OPTION** menu.
- 2 Press the ► or > button and then use ▲ or ▼ or ^ or v button to select **Language**.
- 3 Press the ► or > button and then use ▲ or ▼ or ^ or v button to select your desired language. From this point on, the on-screen menu will be shown in the selected language.
- 4 Press the **EXIT** or **RETURN** button to return to TV viewing or press **MENU** to return to the previous menu.

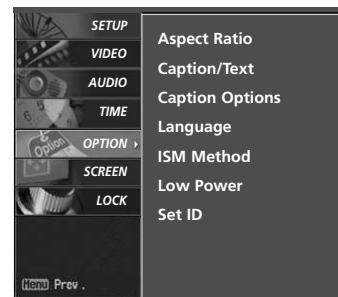

1

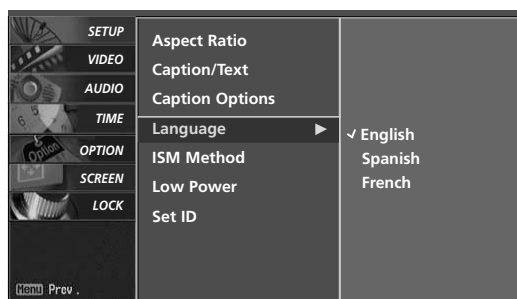

2 3

# SOUND & LANGUAGE CONTROL

## CAPTION / TEXT

### Analog Broadcasting System Captions

Select a caption mode for displaying captioning information if provided on a program. Analog caption displays information at any position on the screen and is usually the program's dialog.

Text displays information, usually at the bottom position and is used for a data service, generally not program related.

Caption/Text, if provided by the broadcaster, would be available for both digital and analog channels on the Antenna/Cable.

This TV is programmed to memorize the caption/text mode which was last set when you turn the power off.

When you select the CC1 ~ Text4, Caption options must be disabled.

- 1 Use the **CC** button repeatedly to select Caption **Off**, **CC1**, **CC2**, **CC3**, **CC4**, **Text1**, **Text2**, **Text3** or **Text4**.

- **CAPTION**

The term for the words that scroll across the bottom of the TV screen; usually the audio portion of the program provided for the hearing impaired.

- **TEXT**

The term for the words that appear in a large black frame and almost cover the entire screen; usually messages provided by the broadcaster.

- 2 Press **EXIT** or **RETURN** to save and return to TV viewing.

- You can also use the **OPTION** menu to select **Caption/Text**.

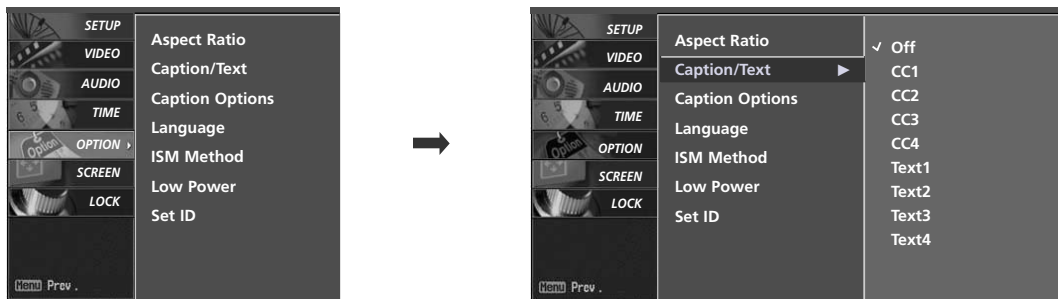

## Digital Broadcasting System Captions

Choose the language you want the DTV/CADTV Captions to appear in.

Other Languages can be chosen for digital sources only if they are included on the program.

- 1 Press the **MENU** button and then use ▲ or ▼ or ^ or v button to select the **OPTION** menu.
- 2 Press the ► or > button and then use ▲ or ▼ or ^ or v button to select **Caption/Text**.
- 3 Press the ► or > button and then use ▲ or ▼ or ^ or v button to select available caption languages: **English, Spanish, or French**.
- 4 Press **EXIT** or **RETURN** button to return to TV viewing or press **MENU** button to return to the previous menu.

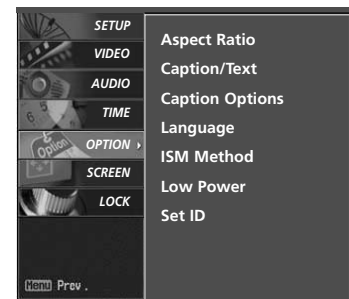

1

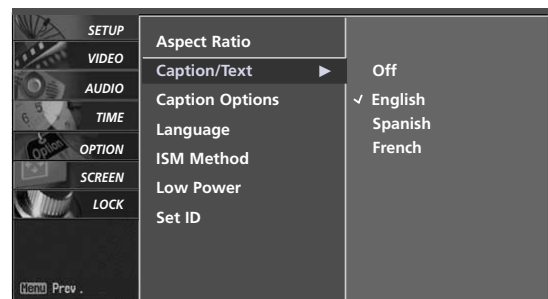

2 3

# SOUND & LANGUAGE CONTROL

## CAPTION OPTIONS

Customize the DTV/CADTV captions that appear on your screen.

1 Press the **MENU** button and then use ▲ or ▼ or ^ or v button to select the **OPTION** menu.

2 Press the ► or > button and then use ▲ or ▼ or ^ or v button to select **Caption Options**.

3 Press the ► or > button and then use ▲ or ▼ or ^ or v button to select **Custom**.

4 Press the ► or > button and then use ▲ or ▼ or ^ or v button to customize the **Style, Font, etc.**, to your preference.

A preview icon is provided at the bottom of the screen, use it to see the caption language.

- ▶ **Size:** Set the word size.
- ▶ **Font:** Select a typeface for the text.
- ▶ **Text Color:** Choose a color for the text.
- ▶ **Text Opacity:** Specify the opacity for the text color.
- ▶ **Bg (Background) Color:** Select a background color.
- ▶ **Bg (Background) Opacity:** Select the opacity for the background color.
- ▶ **Edge Type:** Select an edge type.
- ▶ **Edge Color:** Select a color for the edges.

5 Press **EXIT** or **RETURN** button to return to TV viewing or press **MENU** button to return to the previous menu.

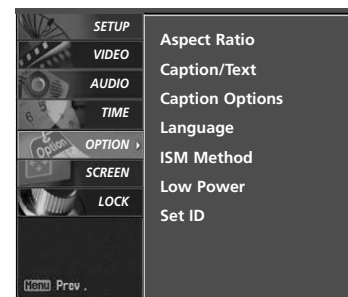

1

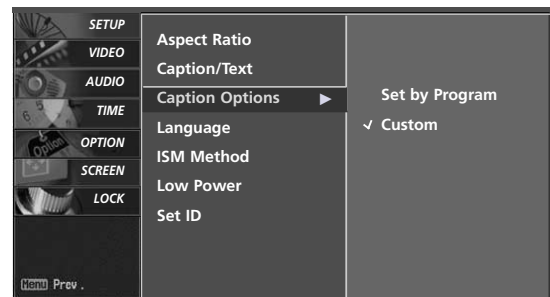

2 3

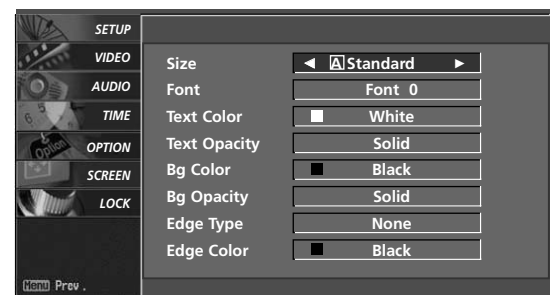

4

# TIME SETTING

## CLOCK SETTING

### Auto Clock Setup

The time is set automatically from a digital channel signal. The digital channel signal includes information for the current time provided by the broadcasting station.

Set the clock manually if the current time is set incorrectly by the auto clock function.

The factory default value of the Auto Clock is Off, because a clock information sent each broadcasting station is different.

---

**1** Press the **MENU** button and then use ▲ or ▼ or ^ or v button to select the **TIME** menu.

---

**2** Press the ► or > button and then use ▲ or ▼ or ^ or v button to select **Auto Clock**.

---

**3** Press the ► or > button and then use ▲ or ▼ or ^ or v button to select **On**.

---

**4** Press the ► or > button and then use ▲ or ▼ or ^ or v button to select your viewing area time zone  
U.S.A : **Eastern, Central, Mountain, Pacific, Alaska or Hawaii.**

Canada : **Eastern, Central, Mountain, Pacific, New F.land or Atlantic.**

---

**5** Press the ► or > button and then use ▲ or ▼ or ^ or v button to select **Auto, Off, On**, depending on whether or not your viewing area observes Daylight Saving time.

---

**6** Press **EXIT** or **RETURN** button to return to TV viewing or press **MENU** button to return to the previous menu.

---

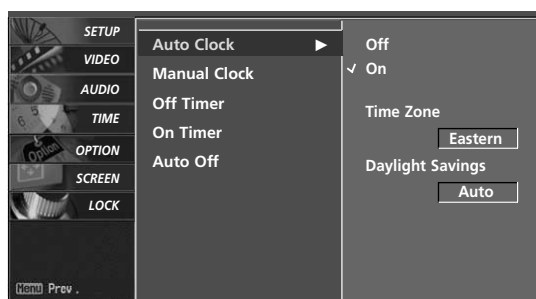

**3** **4** **5**

# TIME SETTING

## Manual Clock Setup

If the current time setting is wrong, reset the clock manually.

1 Press the **MENU** button and then use ▲ or ▼ or ^ or v button to select the **TIME** menu.

2 Press the ► or > button and then use ▲ or ▼ or ^ or v button to select **Manual Clock**.

3 Press the ► or > button and then use ◀ or ▶ or < or > to select either the year, date, or time option. Once selected, use the ▲ or ▼ or ^ or v button to set the year, date, and time option.

4 Press **EXIT** or **RETURN** button to return to TV viewing or press **MENU** button to return to the previous menu.



1

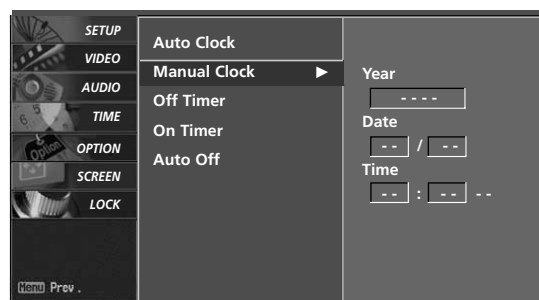

2 3

# AUTO ON/OFF TIMER SETTING

The timer function operates only if the current time has been set.

The Off-Timer function overrides the On-Timer function if they are both set to the same time.

The TV must be in standby mode for the On-Timer to work.

If you do not press any button within 2 hours after the TV turns on with the On Timer function, the TV will automatically revert to standby mode.

---

1 Press the **MENU** button and then use ▲ or ▼ or ^ or v button to select the **TIME** menu.

---

2 Press the ► or > button and then use ▲ or ▼ or ^ or v button to select **Off Timer** or **On Timer**.

---

3 Press the ► or > button and then use ▲ or ▼ or ^ or v button to select **On**.

- To cancel the **On/Off timer** function, select **Off**.

---

4 Press the ► or > button and then use ▲ or ▼ or ^ or v button to set the hour.

---

5 Press the ► or > button and then use ▲ or ▼ or ^ or v button to set the minutes.

---

6 Press **EXIT** or **RETURN** button to return to TV viewing or press **MENU** button to return to the previous menu.

---



1

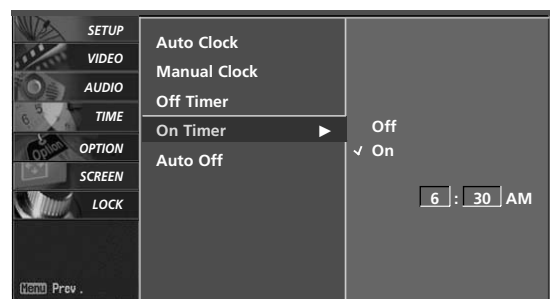

2 3 4 5

# TIME SETTING

## AUTO SHUT-OFF SETTING

If set to on and there is no input signal, the TV turns off automatically after 10 minutes.

**1** Press the **MENU** button and then use ▲ or ▼ or ^ or v button to select the **TIME** menu.

**2** Press the ► or > button and then use ▲ or ▼ or ^ or v button to select **Auto Off**.

**3** Press the ► or > button and then use ▲ or ▼ or ^ or v button to select **On** or **Off**.

**4** Press **EXIT** or **RETURN** button to return to TV viewing or press **MENU** button to return to the previous menu.



1

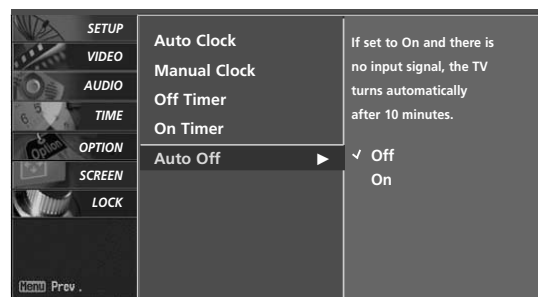

2 3

# SLEEP TIMER SETTING

The Sleep Timer turns the TV off at the preset time.

Note that this setting is cleared when the TV is turned off.

- 
- 1 Press the **TIMER** button repeatedly to select the number of minutes. First the **Off** option appears on the screen, followed by the following sleep timer options: 10, 20, 30, 60, 90, 120, 180, and 240 minutes.

---

  - 2 When the number of minutes you want is displayed on the screen, press the **ENTER** button. The timer begins to count down from the number of minutes selected.

---

  - 3 To check the remaining minutes before the TV turns off, press the **TIMER** button once.

---

  - 4 To cancel the Sleep Timer, press the **TIMER** button repeatedly to select **Off**.

---

# SCREEN ADJUSTMENT

## AUTO CONFIGURE (RGB [PC] MODE ONLY)

Automatically adjusts picture position and minimizes image shaking.

Although the image is still not correct, your set is functioning properly but needs further adjustment.

1 Press the **MENU** button and then use ▲ or ▼ or ^ or v button to select the **SCREEN** menu.

2 Press the ► or > button and then use ▲ or ▼ or ^ or v button to select **Auto config.**

3 Press the ► or > button to start **Auto config.**

- When **Auto config.** has finished, **OK** will be shown on screen.
- If the position of the image is still not correct, try Auto adjustment again.

4 If the picture needs to be adjusted more after Auto adjustment in RGB (PC), you can adjust the **Manual config.**

5 Press the **EXIT** or **RETURN** button to return to TV viewing or press the **MENU** button to return to the previous menu.



1

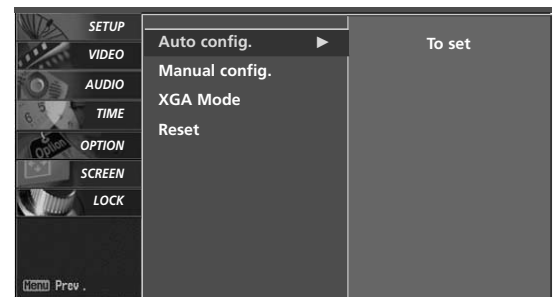

2 3

# MANUAL CONFIGURE

If the picture isn't clear after auto adjustment and especially if characters are still trembling, adjust the picture phase manually.

This function works in the following mode: RGB-PC, RGB-DTV, Component 480p/720p/1080i, HDMI 480p/720p/1080i.

The Phase, Clock functions work in the following mode: RGB-PC mode.

---

1 Press the **MENU** button and then use ▲ or ▼ or ^ or v button to select the **SCREEN** menu.

---

2 Press the ► or > button and then use ▲ or ▼ or ^ or v button to select **Manual config.**

---

3 Press the ► or > button and then use ▲ or ▼ or ^ or v button to select **Phase, Clock, H-position** or **V-position**.

### ■ Phase

This function allows you to remove any horizontal noise and clear or sharpen the image of characters.

### ■ Clock

This function is to minimize any vertical bars or stripes visible on the screen background. And the horizontal screen size will also change.

### ■ H-position / V-position

This function is to adjust picture to left/right and up/down as you prefer.

---

4 Press the ◀ or ▶ or < or > button to make appropriate adjustments.

---

5 Press the **EXIT** or **RETURN** button to return to TV viewing or press the **MENU** button to return to the previous menu.

---



1

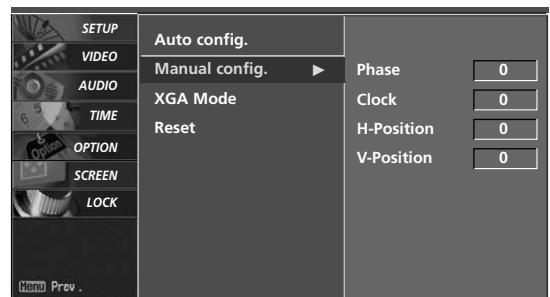

2 3 4

# SCREEN ADJUSTMENT

## SELECTING XGA MODE

To see a normal picture, match the resolution of RGB mode and selection of XGA mode.

This function works in the following mode: RGB-PC mode.

If you select the 1600x1200, 1920x1200 resolution, **uXGA mode** is displayed.

---

1 Press the **MENU** button and then use ▲ or ▼ or ^ or v button to select the **SCREEN** menu.

---

2 Press the ► or > button and then use ▲ or ▼ or ^ or v button to select **XGA mode**.

---

3 Press the ► or > button and then use ▲ or ▼ or ^ or v button to select the desired XGA resolution.

---

4 Press **EXIT** or **RETURN** button to return to TV viewing or press **MENU** button to return to the previous menu.

---



1

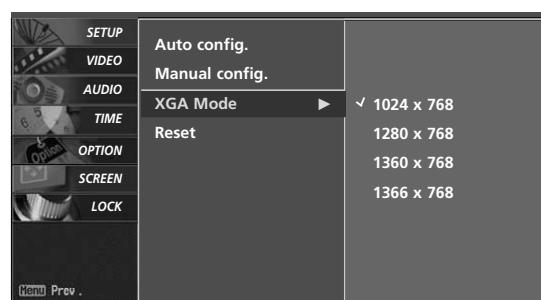

2 3

# INITIALIZING (RESET TO ORIGINAL FACTORY SETTINGS)

This function operates in current mode.  
To initialize the adjusted value.

---

1 Press the **MENU** button and then use ▲ or ▼ or ^ or v button to select the **SCREEN** menu.

---

2 Press the ► or > button and then use ▲ or ▼ or ^ or v button to select **Reset**.

---

3 Press the ► or > button.

---



1

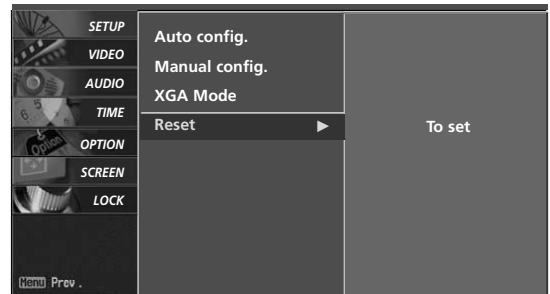

2 3

# PARENTAL CONTROL / RATINGS

Parental Control can be used to block specific channels, ratings and other viewing sources.

The Parental Control Function (V-Chip) is used to block program viewing based on the ratings sent by the broadcasting station. The default setting is to allow all programs to be viewed. Viewing can be blocked by choosing the type of the program and the categories. It is also possible to block all program viewing for a time period. To use this function, the following must be done:

1. Set ratings and categories to be blocked.
2. Specify a password
3. Enable the lock

## V-Chip rating and categories

Rating guidelines are provided by broadcasting stations. Most television programs and television movies can be blocked by TV Rating and/or Individual Categories. Movies that have been shown at the theaters or direct-to-video movies use the Movie Rating System (MPAA) only.

## Ratings for Television programs including made-for-TV movies:

- TV-G (General audience)
- TV-PG (Parental guidance suggested)
- TV-14 (Parents strongly cautioned)
- TV-MA (Mature audience only)
- TV-Y (All children)
- TV-Y7 (Children 7 years older)

## SET PASSWORD & LOCK SYSTEM

### Setting up your password

Set up blocking schemes to block specific channels, ratings, and external viewing sources.

A password is required to gain access to this menu.

- 1 Press the **MENU** button and then use the ▲ or ▼ or ^ or v button to select the **LOCK** menu. Then, press the ► or > button.

- Enter the password as requested.
- The TV is set up with the initial password "0-0-0-0".

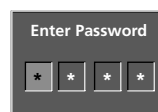

## Set Password

Change the password by inputting a new password twice.

- 1 After inputting the password, use the ▲ or ▼ or ^ or ∨ button to choose **Set password**.
- 2 Press the ► or > button and then choose any 4 digits for your new password.  
As soon as the 4 digits are entered, re-enter the same 4 digits on the **Confirm**.  
Then your changed password has been memorized.
- 3 Press **EXIT** or **RETURN** to return to TV viewing or press **MENU** to return to the previous menu.

### NOTE

- ▶ If you ever forget your password, key in '7', '7', '7', '7' on the remote control.

## Lock System

Enables or disables the blocking scheme you set up previously.

- 1 After inputting the password, use the ▲ or ▼ or ^ or ∨ button to choose **Lock System**.
- 2 Press the ► or > button and then use the ▲ or ▼ or ^ or ∨ button to select **On** or **Off**.
  - When you select **On**, the Lock System is enable.
- 3 Press **EXIT** or **RETURN** button to return to TV viewing or press **MENU** button to return to the previous menu.

For USA

For Canada

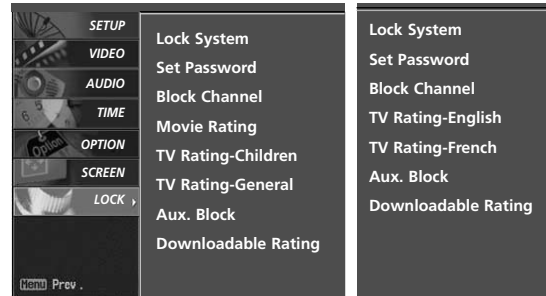

1

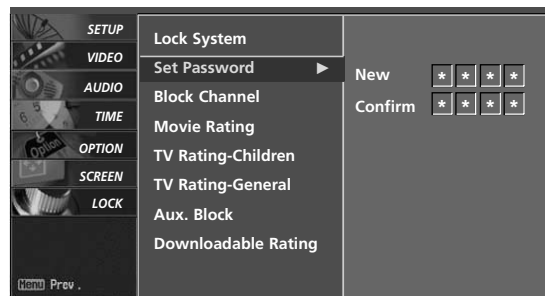

2

For USA

For Canada

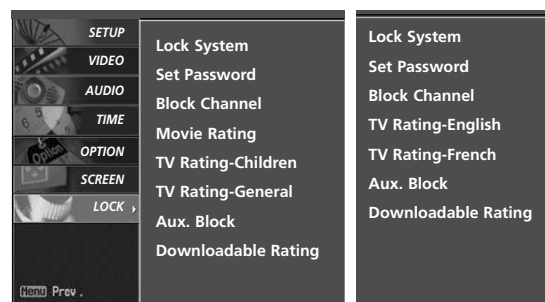

1

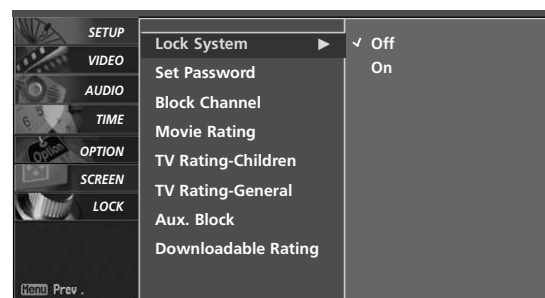

2

# PARENTAL CONTROL /RATINGS

## CHANNEL BLOCKING

Blocks any channels that you do not want to watch or that you do not want your children to watch.

- 1 After inputting the password, use the ▲ or ▼ or ^ or ∨ button to choose **Block Channel**.
- 2 Press the ► or > button. You will now see a screen filled with channel numbers and a preview picture.
- 3 Use ▲ ▼ ◀ ▶ or ^ ∨ < > button to select a channel and then use the **ENTER** button to block or unblock it.
- 4 Press **EXIT** or **RETURN** button to return to TV viewing or press **MENU** button to return to the previous menu.

For USA

For Canada

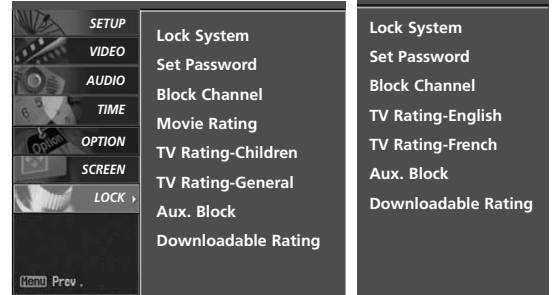

1

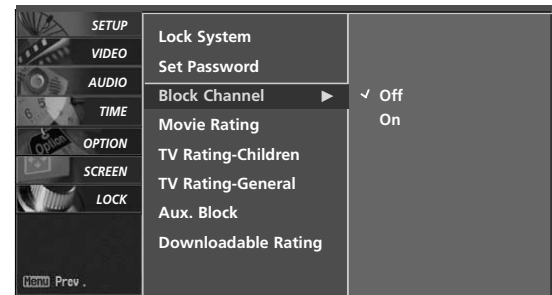

1 2

## EXTERNAL INPUT BLOCKING

Enables you to select a source to block from the external source devices you have hooked up.

- 1 After inputting the password, use the ▲ or ▼ or ^ or ∨ button to choose **Aux. Block**.
- 2 Press the ► or > button and then use the ◀ or ▶ or < or > button to select a source.
- 3 Press the ► or > button and then use the ▲ or ▼ or ^ or ∨ button to select **On** or **Off** on the each source.
- 4 Press **EXIT** or **RETURN** button to return to TV viewing or press **MENU** button to return to the previous menu.

For USA

For Canada

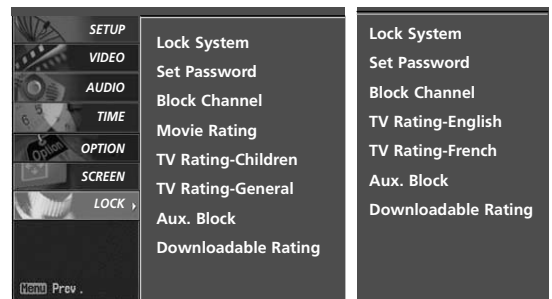

1

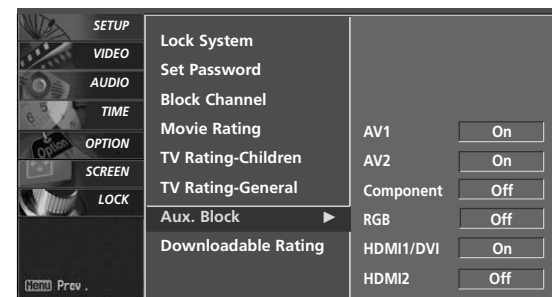

2 3

# MOVIE & TV RATING

## Movie Rating (MPAA) -for USA only

Blocks movies according to the movie ratings limits specified, so children cannot view certain movies. You can set the ratings limit by blocking out all the movies with the ratings above a specified level. Keep in mind that the movie ratings limit only applies to movies shown on TV, not TV programs, such as soap operas.

- 1 After inputting the password, use the ▲ or ▼ or ^ or v button to choose **Movie Rating**.
- 2 Press the ► or > button and then use the ▲ or ▼ or ^ or v button to select **G, PG, PG-13, R, NC-17** or **X**.
  - G (General audiences)
  - PG (Parental guidance suggested)
  - PG-13 (Parents strongly cautioned)
  - R (Restricted)
  - NC-17 (No one 17 and under admitted)
  - X (Adult only)
  - Blocking Off (Permits all programs)

► If you set PG-13: G and PG movies will be available, PG-13, R, NC-17 and X will be blocked.

- 3 Press **EXIT** or **RETURN** button to return to TV viewing or press **MENU** button to return to the previous menu.

## Downloadable Rating

- 1 After inputting the password, use the ▲ or ▼ or ^ or v button to choose **Downloadable Rating**.
- 2 Press the ► or > button and then use the ▲ or ▼ or ^ or v button to select **Dim0, Dim1, Dim2,** or **Dim3**.
- 3 Press the ► or > button and then use the ▲ or ▼ or ^ or v button to select **D1L1, D1L2,** or **D1L3**.
- 4 Press **EXIT** or **RETURN** button to return to TV viewing or press **MENU** button to return to the previous menu.

### ! NOTE

- This function may become available in the future and will be available only for digital channel signal.
- This function operates only when TV has received Region5 Rating data.

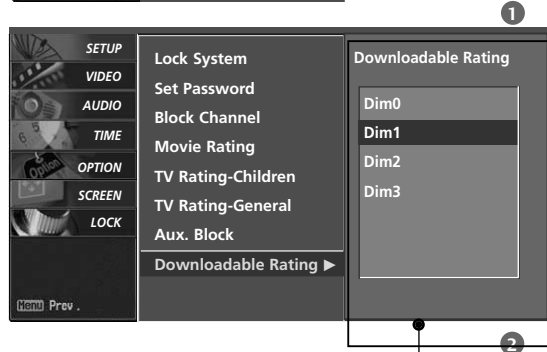
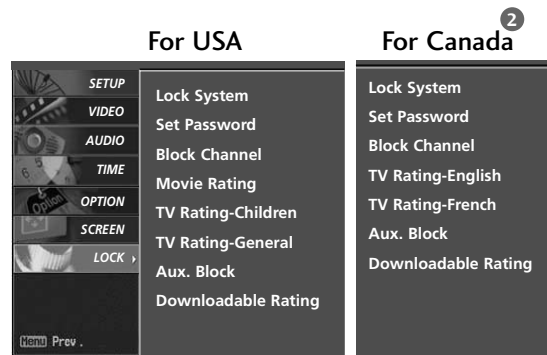
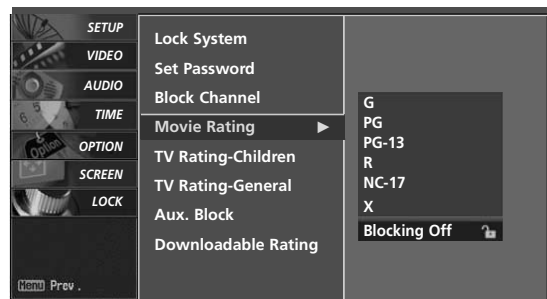

► Based on rating table, your TV's OSD (On Screen Display) may differ slightly from what is shown in this manual.

# PARENTAL CONTROL /RATINGS

## TV Rating Children -for USA only

Prevents children from watching certain children's TV programs, according to the ratings limit set. The children rating does not apply to other TV programs. Unless you block certain TV programs intended for mature audiences in the TV Rating - sub menu, your children can view those programs.

**1** After inputting the password, use the ▲ or ▼ or ^ or v button to choose **TV Rating-Children**.

**2** Press the ► or > button and then use the ▲ or ▼ or ^ or v button to select **Age**, or **Fantasy Violence**. Press the ► or > button and then use the ▲ or ▼ or ^ or v button to select block options.

- Age (applies to TV-Y, TV-Y7)
- Fantasy Violence (applies to TV-Y7)

**3** Press **EXIT** or **RETURN** button to return to TV viewing or press **MENU** button to return to the previous menu.

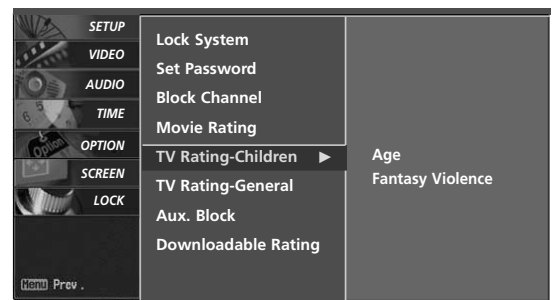
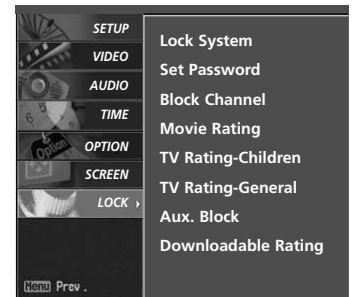

## TV Rating General -for USA only

Based on the ratings, blocks certain TV programs that you and your family do not want to view.

**1** After inputting the password, use the ▲ or ▼ or ^ or v button to choose **TV Rating-General**.

**2** Press the ► or > button and then use the ▲ or ▼ or ^ or v button to select **Age**, **Dialogue**, **Language**, **Sex** or **Violence**.

Press the ► or > button and then use the ▲ or ▼ or ^ or v button to select block options.

- Age (applies to TV-G,TV-PG,TV-14,TV-MA)
- Dialogue-sexual dialogue (applies to TV-PG,TV-14)
- Language-adult language (applies to TV-PG,TV-14,TV-MA)
- Sex-sexual situations (applies to TV-PG,TV-14,TV-MA)
- Violence (applies to TV-PG,TV-14,TV-MA)

**3** Press **EXIT** or **RETURN** button to return to TV viewing or press **MENU** button to return to the previous menu.

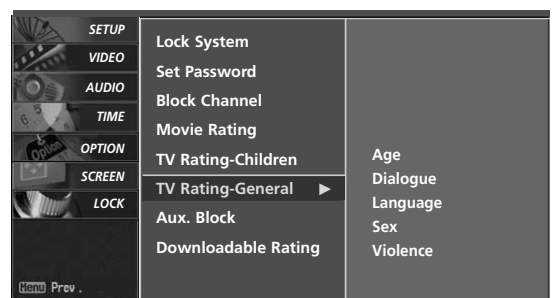

## TV Rating English - for CANADA only

Prevents children from watching certain children's TV programs, according to the ratings limit set. The children rating does not apply to other TV programs. Unless you block certain TV programs intended for mature audiences in the TV Rating - sub menu, your children can view those programs.

- 1 After inputting the password, use the ▲ or ▼ or ^ or v button to choose **TV Rating-English**.
- 2 Press the ► or > button and then use the ▲ or ▼ or ^ or v button to select **E, C, C8+, G, PG, 14+, 18+, or Blocking Off**.
  - E(Exempt)
  - C(Children)
  - C8+(Children eight years and older)
  - G(General programming, suitable for all audiences)
  - PG(Parental Guidance )
  - 14+(Viewers 14 years and older)
  - 18+(Adult programming)
  - Blocking Off(Permits all programs)

- 3 Press **EXIT** or **RETURN** button to return to TV viewing or press **MENU** button to return to the previous menu.

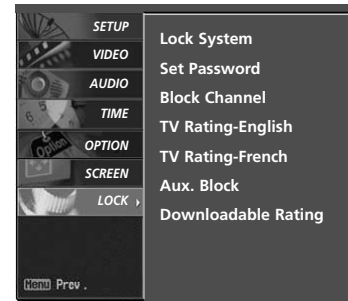

1

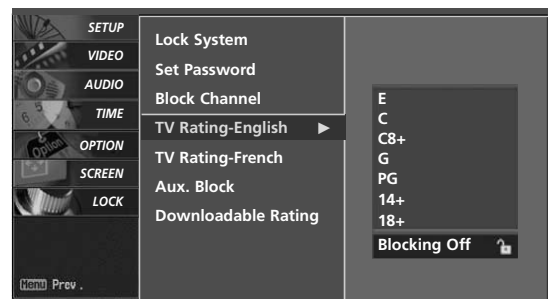

2

## TV Rating French - for CANADA only

Based on the ratings, blocks certain TV programs that you and your family do not want to view.

- 1 After inputting the password, use the ▲ or ▼ or ^ or v button to choose **TV Rating-French**.
- 2 Press the ► or > button and then use the ▲ or ▼ or ^ or v button to select **E, G, 8 ans+, 13 ans+, 16 ans+, 18 ans+, or Blocking Off**.
  - E(Exempt)
  - G(General)
  - 8 ans+(General-Not convenient for little children)
  - 13 ans+(Not convenient for children of 13 years and younger)
  - 16 ans+(Not convenient for children of 16 years and younger)
  - 18 ans+(This programs is only for adults)
  - Blocking Off(Permits all programs)

- 3 Press **EXIT** or **RETURN** button to return to TV viewing or press **MENU** button to return to the previous menu.

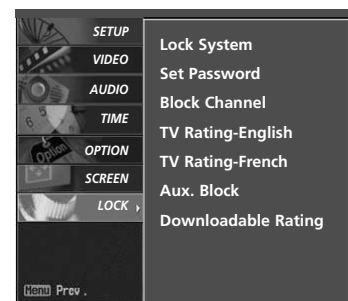

1

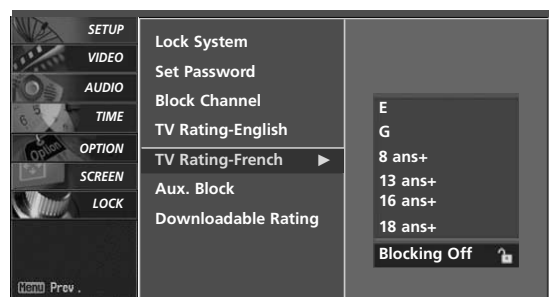

2

# APPENDIX

## TROUBLESHOOTING

The operation does not work normally.	
The remote control doesn't work	<ul style="list-style-type: none"><li>■ Check to see if there is any object between the product and the remote control causing obstruction. Ensure you are pointing the remote control directly at the TV.</li><li>■ Ensure that the batteries are installed with correct polarity (+ to +, - to -).</li><li>■ Ensure that the correct remote operating mode is set: TV, VCR etc.</li><li>■ Install new batteries.</li></ul>
Power is suddenly turned off	<ul style="list-style-type: none"><li>■ Is the sleep timer set?</li><li>■ Check the power control settings. Power interrupted.</li><li>■ No broadcast on station tuned with Auto off activated.</li></ul>

The video function does not work.	
No picture & No sound	<ul style="list-style-type: none"><li>■ Check whether the product is turned on.</li><li>■ Try another channel. The problem may be with the broadcast.</li><li>■ Is the power cord inserted into wall power outlet?</li><li>■ Check your antenna direction and/or location.</li><li>■ Test the wall power outlet, plug another product's power cord into the outlet where the product's power cord was plugged in.</li></ul>
Picture appears slowly after switching on	<ul style="list-style-type: none"><li>■ This is normal, the image is muted during the product startup process. Please contact your service center, if the picture has not appeared after five minutes.</li></ul>
No or poor color or poor picture	<ul style="list-style-type: none"><li>■ Adjust Color in menu option.</li><li>■ Keep a sufficient distance between the product and the VCR.</li><li>■ Try another channel. The problem may be with the broadcast.</li><li>■ Are the video cables installed properly?</li><li>■ Activate any function to restore the brightness of the picture.</li></ul>
Horizontal/vertical bars or picture shaking	<ul style="list-style-type: none"><li>■ Check for local interference such as an electrical appliance or power tool.</li></ul>
Poor reception on some channels	<ul style="list-style-type: none"><li>■ Station or cable product experiencing problems, tune to another station.</li><li>■ Station signal is weak, reorient antenna to receive weaker station.</li><li>■ Check for sources of possible interference.</li></ul>
Lines or streaks in pictures	<ul style="list-style-type: none"><li>■ Check antenna (Change the direction of the antenna).</li></ul>

### The audio function does not work.

Picture OK & No sound	<ul style="list-style-type: none"><li>■ Press the VOL or VOLUME button.</li><li>■ Sound muted? Press MUTE button.</li><li>■ Try another channel. The problem may be with the broadcast.</li><li>■ Are the audio cables installed properly?</li></ul>
No output from one of the speakers	<ul style="list-style-type: none"><li>■ Adjust Balance in menu option.</li></ul>
Unusual sound from inside the product	<ul style="list-style-type: none"><li>■ A change in ambient humidity or temperature may result in an unusual noise when the product is turned on or off and does not indicate a fault with the product.</li></ul>

### There is a problem in PC mode. (Only PC mode applied)

The signal is out of range	<ul style="list-style-type: none"><li>■ Adjust resolution, horizontal frequency, or vertical frequency.</li><li>■ Check the input source.</li></ul>
Vertical bar or stripe on background & Horizontal Noise & Incorrect position	<ul style="list-style-type: none"><li>■ Work the Auto configure or adjust clock, phase, or H/V position. (Option)</li></ul>
Screen color is unstable or single color	<ul style="list-style-type: none"><li>■ Check the signal cable.</li><li>■ Reinstall the PC video card.</li></ul>

## MAINTENANCE

Early malfunctions can be prevented. Careful and regular cleaning can extend the amount of time you can enjoy your new TV.

**Caution:** Be sure to turn the power off and unplug the power cord before you begin any cleaning.

### Cleaning the Screen

- 1 Here's a great way to keep the dust off your screen for a while. Wet a soft cloth in a mixture of lukewarm water and a little fabric softener or dish washing detergent. Wring the cloth until it's almost dry, and then use it to wipe the screen.
- 2 Make sure the excess water is off the screen, and then let it air-dry before you turn on your TV.

### Cleaning the Cabinet

- To remove dirt or dust, wipe the cabinet with a soft, dry, lint-free cloth.
- Please be sure not to use a wet cloth.

### Extended Absence

#### ⚠ CAUTION

- ▶ If you expect to leave your TV dormant for a long time (such as a vacation), it's a good idea to unplug the power cord to protect against possible damage from lightning or power surges.

## PRODUCT SPECIFICATIONS

MODELS		42PG60C (42PG60C-UA)	42PG65C (42PG65C-UA)		
Dimensions (Width x Height x Depth)	With stand (Only 42PG65C)		41.1 x 28.9 x 12.1 inches 1044.4 x 735.4 x 308.0 mm		
	Without stand	41.1 x 26.7 x 3.1 inches 1044.4 x 680.5 x 79.6mm	41.1 x 26.7 x 4.2 inches 1044.4 x 680.5 x 107.6mm		
Weight	With stand (Only 42PG65C)		61.2 pounds / 27.8 kg		
	Without stand	55.1 pounds / 25.0 kg	55.1 pounds / 25.0 kg		
MODELS		32LG500H (32LG500H-UA)	37LG500H (37LG500H-UA)	42LG500H (42LG500H-UA)	
Dimensions (Width x Height x Depth)	With stand	32.0 x 23.5 x 8.9 inches 813.8 x 598.8 x 227.3 mm	36.8 x 26.9 x 11.5 inches 936.4 x 685.4 x 293.4 mm	40.7 x 28.9 x 11.5 inches 1034.0 x 735.0 x 294.0 mm	
	Without stand	32.0 x 21.2 x 4.3 inches 813.8 x 540.4 x 111.5 mm	36.8 x 24.1 x 4.4 inches 936.4 x 612.8 x 112.1 mm	40.7 x 26.1 x 4.5 inches 1034.0 x 663.0 x 115.8 mm	
Weight	With stand	29.9 pounds / 13.6 kg	40.3 pounds / 18.3 kg	48.5 pounds / 22.0 kg	
	Without stand	26.6 pounds / 12.1 kg	34.3 pounds / 15.6 kg	42.9 pounds / 19.5 kg	

# PRODUCT SPECIFICATIONS

<b>32LC5DC/S/B</b> (32LC5DC/S/B-UA) <b>32LC50C/S/B</b> (32LC50C/S/B-UA)	Width x Height x Depth (inches/mm)	With Stand	31.8 x 23.9 x 9.8 inches 806.6 x 607.5 x 249.0 mm
		Without Stand	31.8 x 21.7 x 3.8 inches 806.6 x 552.3 x 97.2 mm
	Weight (pounds / kg)	With Stand	33.7 pounds / 15.3kg
		Without Stand	27.6 pounds / 12.5 kg
<b>37LC5DC/1/B</b> (37LC5DC/1/B-UA) <b>37LC50C/B</b> (37LC50C/B-UA)	Width x Height x Depth (inches/mm)	With Stand	36.5 x 27.4 x 10.4 inches 926.8 x 695.8 x 264.6 mm
		Without Stand	36.5 x 24.8 x 4.2 inches 926.8 x 629.8 x 107.4 mm
	Weight (pounds / kg)	With Stand	47.2 pounds / 21.4 kg
		Without Stand	36.8 pounds / 16.7 kg
<b>42LC5DC</b> (42LC5DC-UA) <b>42LC50C</b> (42LC50C-UA)	Width x Height x Depth (inches/mm)	With Stand	40.7 x 29.6 x 11.6 inches 1033.1 x 750.7 x 294.2 mm
		Without Stand	40.7 x 27.0 x 4.3 inches 1033.1 x 686.5 x 110.2 mm
	Weight (pounds / kg)	With Stand	61.3 pounds / 27.8 kg
		Without Stand	47.2 pounds / 21.4 kg
<b>32LX5DC/S</b> (32LX5DC/S-UA) <b>32LX50C/S</b> (32LX50C/S-UA)	Width x Height x Depth (inches/mm)	With Stand	36.3 x 24.2 x 11.3 inches 922.0 x 615.0 x 288.0 mm
		Without Stand	36.3 x 21.5 x 3.9 inches 922.0 x 546.0 x 98.0 mm
	Weight (pounds / kg)	With Stand	39.0 pounds / 17.7 kg
		Without Stand	30.4 pounds / 13.8 kg
<b>42PX8DC</b> (42PX8DC-UA)	Width x Height x Depth (inches/mm)	With Stand	46.7 x 28.1 x 10.6 inches 1186.0 x 714.0 x 270.0 mm
		Without Stand	46.7 x 25.7 x 3.9 inches 1186.0 x 654.0 x 99.0 mm
	Weight (pounds / kg)	With Stand	72.5 pounds / 32.9 kg
		Without Stand	55.6 pounds / 25.2 kg
<b>42LB5DC</b> (42LB5DC-UA) <b>42LB50C</b> (42LB50C-UA)	Width x Height x Depth (inches/mm)	With Stand	40.7 x 29.6 x 11.6 inches 1033.1 x 750.7 x 294.2 mm
		Without Stand	40.7 x 27.0 x 4.3 inches 1033.1 x 686.5 x 110.2 mm
	Weight (pounds / kg)	With Stand	61.3 pounds / 27.8 kg
		Without Stand	47.2 pounds / 21.4 kg
Power requirement Television System Program Coverage External Antenna Impedance Operating Temperature Range Operating Humidity Range Storage Temperature Range Storage Humidity Range	AC100-240V ~ 50/60Hz NTSC-M, ATSC, 64 & 256 QAM VHF 2-13, UHF 14-69, CATV 1-135, DTV 2-69, CADTV 1-135 75 ohm 32 ~ 104°F (0 ~ 40°C) Less than 80% -4 ~ 140°F (-20 ~ 60°C) Less than 85%		

■ The specifications shown above may be changed without prior notice for quality improvement.

## PROGRAMMING THE REMOTE CONTROL

The provided universal remote control can be programmed to operate most remote-controllable devices. Note that the remote may not control all models of other brands.

### Programming a code into a remote mode

- 1 To find out whether your remote control can operate each device without programming, turn on the device (such as a VCR) and press the corresponding mode button on the remote. After that, press the **POWER** button. If the device is turned off and it responds properly the remote control need not be programmed. If not, the remote should be programmed to operate the device. The programming procedures are explained below.
- 2 Press the **MENU** and **MUTE** button continuously at the same time for two seconds; the currently selected device button is illuminated. If you don't press any button for 20 seconds, the light on the mode button will be turned off. In that case, you have to repeat from step 2.
- 3 Enter the appropriate code from the code table on the following pages. When pressing the button, the light blinks at a time. If the device turned off, the programming is successful.
- 4 Press the **MENU** button to store the code. After blinking twice, this code is stored.
- 5 Test the remote control functions to see if the device responds properly. If not, steps 2-5.

### Remote Control Code

#### DVD

Brand	Codes	Brand	Codes	Brand	Codes
APEX DIGITAL	022	mitsubishi	002	RCA	005 006
DENON	020 014	NAD	023	SAMSUNG	011 015
GE	005 006	ONKYO	008 017	SONY	007
HARMAN KARDON	027	PANASONIC	003 009	THOMPSON	005 006
JVC	012	PHILIPS	013	TOSHIBA	019 008
LG	001 010 016 025	PIONEER	004 026	YAMAHA	009 018
MAGNAVOX	013	PROCEED	021	ZENITH	010 016 025
MARANTZ	024	PROSCAN	005 006		

# VCR

Brand	Codes	Brand	Codes	Brand	Codes
AIWA	034	MAGNAVOX	031 033 034 041	SAMSUNG	032 040 102 104
AKAI	016 043 046 124 125 146		067 068 012 031 033 067		105 107 109 112 113 115 120 122
AMPRO	072	MARANTZ	069		125
ANAM	031 033 103	MARTA	101	SANSUI	022 043 048 135
AUDIO DYNAMICS	012 023 039 043	MATSUI	027 030	SANYO	003 007 010 014
BROKSONIC	035 037 129	MEI	031 033		102 134
CANON	028 031 033	MEMOREX	003 010 014 031	SCOTT	017 037 112 129
CAPEHART	108		033 034 053 072		131
CRAIG	003 040 135		101 102 134 139	SEARS	003 008 009 010
CURTIS MATHES	031 033 041	MGA	045 046 059		013 014 017 020
DAEWOO	005 007 010 064 065 108 110 111 112 116 117 119	MINOLTA	013 020		031 042 073 081
DAYTRON	108	MITSUBISHI	013 020 045 046 049 051 059 061	SHARP	031 054 149
DBX	012 023 039 043		151	SHINTOM	024
DYNATECH	034 053	MTC	034 040	SONY	003 009 031 052
ELECTROHOME	059	MULTITECH	024 034		056 057 058 076
EMERSON	006 017 025 027 029 031 034 035 036 037 046 101 129 131 138 153	NEC	012 023 039 043 048	SOUNDESIGN	034
		NORDMENDE	043	STS	013
		OPTONICA	053 054	SYLVANIA	031 033 034 059
FISHER	003 008 009 010	PANASONIC	066 070 074 083 133 140 145		067
FUNAI	034			SYMPHONIC	034
GE	031 033 063 072 107 109 144 147	PENTAX	013 020 031 033 063	TANDY	010 034
GO VIDEO	132 136	PHILCO	031 034 067	TATUNG	039 043
HARMAN KARDON	012 045	PHILIPS	031 033 034 054 067 071 101	TEAC	034 039 043
HITACHI	004 018 026 034 043 063 137 150	PILOT	101	TECHNICS	031 033 070
INSTANTREPLAY	031 033	PIONEER	013 021 048	TEKNIKA	019 031 033 034
JCL	031 033	PORTLAND	108		101
JCPENNY	012 013 015 033 040 066 101	PULSAR	072	THOMAS	034
JENSEN	043	QUARTZ	011 014	TMK	006
JVC	012 031 033 043 048 050 055 060 130 150 152	QUASAR	033 066 075 145	TOSHIBA	008 013 042 047
KENWOOD	014 034 039 043 047 048	RCA	013 020 033 034 040 041 062 063 107 109 140 144 145 147		059 082 112 131
LG (GOLDSTAR)	001 012 013 020 101 106 114 123	REALISTIC	003 008 010 014 031 033 034 040 053 054 101	TOTEVISION	040 101
LLOYD	034			UNITECH	040
LXI	003 009 013 014 017 034 101 106	RICO	058	VECTOR RESEARCH	012
MAGIN	040	RUNCO	148	VICTOR	048
		SALORA	014	VIDEO CONCEPTS	012 034 046
				VIDEOSONIC	040
				WARDS	003 013 017 024 031 033 034 040 053 054 131
				YAMAHA	012 034 039 043
				ZENITH	034 048 056 058 072 080 101

# APPENDIX

## SET ID

Use this function to specify a TV ID number.

1 Press the **MENU** button and then use ▲ or ▼ or ^ or v button to select the **OPTION** menu.

2 Press the ► or > button and then use ▲ or ▼ or ^ or v button to select **Set ID**.

3 Press the ► or > button and then use ▲ or ▼ or ^ or v button to adjust **Set ID** to choose the desired TV ID number. The adjustment range of Set ID is 1~99.

4 Press **EXIT** or **RETURN** button to return to TV viewing or press **MENU** button to return to the previous menu.

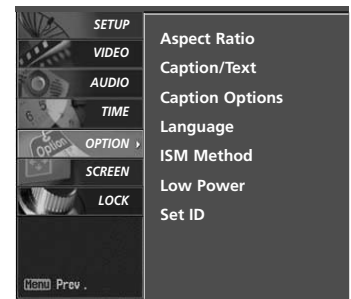

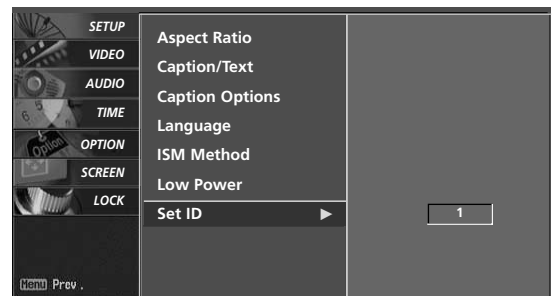

1



2 3

# IR CODES

Code (Hexa)	Function	Note	Code (Hexa)	Function	Note
0F	TV INPUT	Remote control Button (Some models)	D6	TV	Discrete IR Code
0B	INPUT	Remote control Button			(TV Input Selection)
08	POWER	Remote control Button (Power On/Off)	C4	POWER ON	Discrete IR Code
98	MULTI	Remote control Button (Some models)			(Only Power On)
79	RATIO	Remote control Button	C5	POWER OFF	Discrete IR Code
0E	TIMER	Remote control Button			(Only Power Off)
10-19	Number Key 0-9	Remote control Button	5A	AV1	Discrete IR Code
4C	- (Dash)	Remote control Button			(AV1 Input Selection)
1A	FLASH BACK	Remote control Button	D0	AV2	Discrete IR Code
09	MUTE	Remote control Button			(AV2 Input Selection)
02	VOL +	Remote control Button	BF	COMPONENT	Discrete IR Code
03	VOL -	Remote control Button			(Component Input Selection)
00	CH + , ^	Remote control Button	D5	RGB-PC	Discrete IR Code
01	CH - , v	Remote control Button			(RGB-PC Input Selection)
39	CC	Remote control Button	CE	HDMI1/DVI	Discrete IR Code
40	▲ , ^	Remote control Button			(HDMI1/DVI Input Selection)
41	▼ , v	Remote control Button	CC	HDMI2	Discrete IR Code
07	◀ , <	Remote control Button			(HDMI2 Input Selection)
06	▶ , >	Remote control Button	76	Ratio 4:3	Discrete IR Code
44	ENTER	Remote control Button			(Only 4:3 Mode)
43	MENU	Remote control Button	77	Ratio 16:9	Discrete IR Code
52	EZ SOUND	Remote control Button (Some models)			(Only 16:9 Mode)
4D	EZ PIC	Remote control Button (Some models)	AF	Ratio Zoom	Discrete IR Code
5B	EXIT, RETURN	Remote control Button			(Only Zoom1 Mode)
0A	SAP	Remote control Button			
E1	- 	Remote control Button (Some models)			
E0	 +	Remote control Button (Some models)			
AA	INFO	Remote control Button			
60	PIP	Remote control Button			
72	PIP CH -	Remote control Button			
71	PIP CH +	Remote control Button			
61	PIP INPUT	Remote control Button			
63	SWAP, PIP SWAP	Remote control Button			

 **NOTE**

**ENG**

Some video codecs listed in the manual may not be supported, depending on the region (country).

**POR**

Alguns codecs de vídeo listados no manual podem não ser suportados, dependendo da região (país).

**POL**

Niektóre kodeki wideo wymienione w instrukcji mogą nie być obsługiwane, w zależności od regionu (kraju).

**SPA**

Algunos códecs de vídeo que figuran en el manual pueden no ser compatibles, dependiendo de la región (país).

**THA**

ชนิดของไฟล์วิดีโอบางชนิดที่อยู่ในคู่มือเล่มนี้ อาจไม่รองรับการใช้งานในบางพื้นที่(ประเทศ)

**LG Electronics Inc.**