

# MICROWAVE OVEN

## OWNER'S MANUAL & COOKING GUIDE

PLEASE READ THIS OWNER'S MANUAL  
THOROUGHLY BEFORE OPERATING.

## MAB745W

## MAB745B

# PRECAUTIONS TO AVOID POSSIBLE EXPOSURE TO EXCESSIVE MICROWAVE ENERGY

- (a) Do not attempt to operate this oven with the door open since open-door operation can result in harmful exposure to microwave energy. It is important not to defeat or tamper with the safety interlocks.
- (b) Do not place any object between the oven front face and the door or allow soil or cleaner residue to accumulate on sealing surfaces.
- (c) Do not operate the oven if it is damaged. It is particularly important that the oven door close properly and that there is no damage to the:
  - (1) Door (bent),
  - (2) Hinges and latches (broken or loosened),
  - (3) Door seals and sealing surfaces.
- (d) The oven should not be adjusted or repaired by anyone except properly qualified service personnel.

## ***Thank you for purchasing a Goldstar microwave oven***

Please record the model number and serial number of this unit for future reference. We also suggest you record the details of your contact with Goldstar (LG Electronics U.S.A., Inc.) concerning this unit.

Model No: \_\_\_\_\_  
Serial No: \_\_\_\_\_  
Dealer: \_\_\_\_\_  
\_\_\_\_\_  
\_\_\_\_\_  
Dealer Phone No: \_\_\_\_\_

Staple your Receipt here to prove your retail purchase.

Customer Relations  
LG Electronics U.S.A., Inc.  
Service Division Bldg. #3  
201 James Record Rd.  
Huntsville, AL 35824-0126

# TABLE OF CONTENTS

<b>TECHNICAL SPECIFICATIONS</b> .....	<b>3</b>
<b>IMPORTANT SAFETY INSTRUCTIONS</b> .....	<b>4</b>
<b>INSTALLATION</b> .....	<b>5</b>
<b>INTRODUCTION</b> .....	<b>6</b>
<b>CONTROL PANEL</b> .....	<b>9</b>
<b>FEATURE DIAGRAM</b> .....	<b>9</b>
<b>OPERATING INSTRUCTIONS</b> .....	<b>10</b>
SETTING TIME OF DAY	
TIMED COOKING	
Ez On	
TIMER	
CHILD LOCK	
ONE TOUCH CONTROL	
ONE TOUCH CONTROL CHART	
MICROWAVE POWER LEVELS	
Q-DEFROST	
AUTO DEFROST	
<b>OTHER HELPFUL INSTRUCTIONS</b> .....	<b>15</b>
<b>CARE OF YOUR MICROWAVE OVEN</b> .....	<b>16</b>
<b>PRECAUTIONS</b> .....	<b>16</b>
<b>QUESTIONS AND ANSWERS</b> .....	<b>17</b>
<b>COOKING GUIDES</b> .....	<b>18</b>
<b>VEGETABLE COOKING CHART</b> .....	<b>20</b>
<b>REHEATING CHART</b> .....	<b>21</b>
<b>CLEANING</b> .....	<b>22</b>
<b>BEFORE CALLING FOR SERVICE</b> .....	<b>22</b>
<b>WARRANTY</b> .....	<b>Inside back cover</b>

## TECHNICAL SPECIFICATIONS

	<b>MAB745W / MAB745B</b>
Power Supply	120V AC, 60Hz
Rated Power Consumption	950W
Microwave Output	*700W
Frequency	2,450MHz
Rated Current	9.0A
Overall Dimensions (WXHxD)	17 <sup>7</sup> / <sub>8</sub> "X10 <sup>3</sup> / <sub>16</sub> "X13"
Oven Cavity Dimensions (WXHxD)	12 <sup>3</sup> / <sub>8</sub> "X7 <sup>15</sup> / <sub>16</sub> "X11 <sup>9</sup> / <sub>16</sub> "
Effective Capacity of Oven Cavity	0.7 Cu.ft.

\* IEC 60705 RATING STANDARD

Specifications subject to change without prior notice.

# IMPORTANT SAFETY INSTRUCTIONS

The safety instructions below will tell you how to use your oven to avoid harm to yourself or damage to your oven.

**WARNING** - To reduce the risk of burns, electric shock, fire, injury to persons, or exposure to excessive microwave energy:

1. Read all instructions before using the appliance.
2. Read and follow the specific **" PRECAUTIONS TO AVOID POSSIBLE EXPOSURE TO EXCESSIVE MICROWAVE ENERGY"** found on page 2 of this manual.
3. This appliance must be grounded. Connect only to properly grounded outlet.  
See **GROUNDING INSTRUCTIONS** found on page 5 of this manual .
4. Install or locate this appliance only in accordance with the provided installation instructions.
5. Some products, such as whole eggs and sealed containers – for example, closed glass jars are able to explode and should not be heated in this oven.
6. Use this appliance only for its intended use as described in the manual. Do not use corrosive chemicals or vapors in this appliance. This type of oven is specifically designed to heat, cook, or dry food. It is not designed for industrial or laboratory use.
7. As with any appliance, close supervision is necessary when used by children.
8. Do not operate this appliance if it has a damaged cord or plug, if it is not working properly, or if it has been damaged or dropped.
9. This appliance should be serviced only by qualified service personnel. Contact the nearest authorized service facility for examination, repair, or adjustment.
10. Do not cover or block any openings on the appliance.
11. Do not store this appliance outdoors. Do not use this product near water – for example, near a kitchen sink, in a wet basement, near a swimming pool, or similar location.
12. Do not immerse cord or plug in water.
13. Keep cord away from heated surfaces.
14. Do not let cord hang over the edge of a table or counter.
15. When cleaning surfaces of door and oven that come together on closing the door, use only mild, nonabrasive soaps or detergents applied with a sponge or soft cloth.
16. To reduce the risk of fire in the oven cavity:
  - a. Do not overcook food. Carefully attend appliance when paper, plastic, or other combustible materials are placed inside the oven to facilitate cooking.
  - b. Remove wire twist-ties from paper or plastic bags before placing bag in oven.
  - c. If materials inside the oven ignite, **KEEP OVEN DOOR CLOSED**, turn oven off, and disconnect the power cord or shut off power at the fuse or circuit breaker panel.
  - d. Do not use the cavity for storage purposes. Do not leave paper products, cooking utensils, or food in the cavity when not in use.
17. Liquids such as water, coffee, or tea are able to be overheated beyond the boiling point without appearing to be boiling. Visible bubbling or boiling when the container is removed from the microwave oven is not always present. **THIS COULD RESULT IN VERY HOT LIQUIDS SUDDENLY BOILING OVER WHEN THE CONTAINER IS DISTURBED OR A SPOON OR OTHER UTENSIL IS INSERTED INTO THE LIQUID.** To reduce the risk of injury to persons; 1) Do not overheat the liquid. 2) Stir the liquid both before and halfway through heating it. 3) Do not use straight-sided containers with narrow necks. 4) After heating, allow the container to stand in the microwave oven for a short time before removing the container. 5) Use extreme care when inserting a spoon or other utensil into the container.
18. Avoid heating small-necked containers such as syrup bottles.
19. Avoid using corrosive and vapors, such as sulfide and chloride.
20. Liquids heated in certain shaped containers (especially cylindrical-shaped containers) may become overheated. The liquid may splash out with a loud noise during or after heating or when adding ingredients (instant coffee, etc.), resulting in harm to the oven and possible injury. In all containers, for best results, stir the liquid several times before heating. Always stir liquid several times between reheatings.

**SAVE THESE INSTRUCTIONS**

# INSTALLATION

## A. GROUNDING INSTRUCTIONS

For personal safety, this appliance must be properly grounded. In the event of an electrical short circuit, grounding reduces the risk of electric shock by providing an escape route for the electric current. The power cord of this appliance is equipped with a three-prong (grounding) plug to minimize the possibility of electric shock hazard from this appliance. The plug must be plugged into an outlet that is properly installed and grounded.

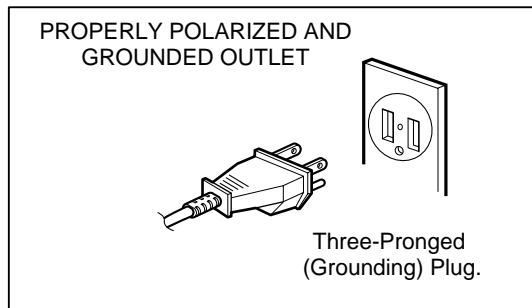

**WARNING** – Improper use of the grounding plug can result in a risk of electric shock. Do not, under any circumstances, cut or remove the third ground prong from the power cord plug.

The consumer should have it checked by a qualified electrician or serviceman if the grounding instructions are not completely understood, or if doubt exists as to whether the appliance is properly grounded. Where a standard two-prong wall receptacle is encountered, it is the responsibility and obligation of the consumer to have it replaced with a properly grounded three-prong wall receptacle.

- a) If customer has two-prong wall receptacle, he should replace it with a three-prong (grounding) receptacle by a qualified electrician before using the appliance.
- b) Use of extension cords: If it is necessary to use an extension cord, use only a 3-wire extension cord that has a 3-blade grounding plug, and a 3-slot receptacle that will accept the plug on the appliance. The marked rating of the extension cord should be equal to or greater than the electrical rating of the appliance.

### NOTE:

1. A short power-supply cord is provided to reduce the risks resulting from becoming entangled in or tripping over a longer cord.
2. Longer cord sets or extension cords are available and may be used if care is exercised in their use.
3. If a long cord or extension cord is used, (1) the

marked electrical rating of the cord set or extension cord should be at least as great as the electrical rating of the appliance, (2) the extension cord must be a grounding-type 3-wire cord, and (3) the longer cord should be arranged so that it will not drape over the countertop or tabletop where it can be pulled on by children or tripped over accidentally.

## B. CIRCUITS

For safety purposes this oven must be plugged into a 15 Amp circuit. No other electrical appliances or lighting circuits should be on this line. If in doubt, consult a licensed electrician.

## C. VOLTAGE WARNING

The voltage used at the wall receptacle must be the same as specified on the oven serial plate located on the back or on the side of the control panel of the oven. Use of a higher voltage is dangerous and may result in a fire or other type of accident causing oven damage. Low voltage will cause slow cooking. In case your microwave oven does not perform normal operation in accordance with AC power source and voltage, remove the power cord and then insert it again.

## D. PLACEMENT OF THE OVEN

Your microwave oven can easily be placed in your kitchen, family room or any other room in your home. Place the oven on a flat surface such as a kitchen counter top or a specially designed microwave oven cart. Do not place oven above a gas or electric range. Free air flow around the oven is important.

## E. DO NOT BLOCK AIR VENTS

All air vents should be kept clear during cooking. If air vents are covered during oven operation the oven may overheat. In this case, a sensitive thermal safety device automatically turns the oven off. The oven will be inoperable until it has cooled sufficiently.

## F. RADIO INTERFERENCE

1. Operation of the microwave oven can cause interference to your radio, TV or similar equipment.
2. When there is interference, it may be reduced or eliminated by taking the following measures:
  - a. Clean door and sealing surfaces of the oven
  - b. Reorient the receiving antenna of radio or television.
  - c. Relocate the microwave oven with respect to the receiver.
  - d. Move the microwave oven away from the receiver.
  - e. Plug the microwave oven into a different outlet so that microwave oven and receiver are on different branch circuits.

# INTRODUCTION

## HOW YOUR MICROWAVE OVEN WORKS

Microwaves are a form of energy similar to radio and television waves. Your microwave oven is constructed in such a way as to take advantage of microwave energy.

Electricity is converted into microwave energy by the magnetron tube, and microwaves are then directed into the cooking area through openings in the oven. Microwaves reflect off the metal walls of the oven. They can be transmitted through glass, paper, wicker and microwave-safe cooking dishes. Microwaves do not heat the cookware, though dishes will eventually feel hot from the heat generated by the food.

Microwaves are attracted to the moisture in foods and cause the water molecules to vibrate, 2,450 million times per second. This is called absorption. As the water molecules vibrate they rub against each other, producing friction. This friction, in turn, causes the food to get hot. If you have trouble imagining how this is possible, just think how hot your hands would get if you rubbed your palms together 2,450 million times per second!

### **A very safe appliance:**

Your microwave oven is one of the safest of all home appliances. When the door is opened, the oven automatically stops producing microwaves. By the time microwave energy has been converted into heat in the process of making food hot, the microwaves have completely dissipated.

## GETTING THE BEST RESULTS FROM YOUR MICROWAVE OVEN

### **Keeping an eye on things:**

The recipes in this book have been developed with great care, but your success in preparing them depends upon how much attention you pay to the food as it cooks. Your microwave oven is equipped with a light that turns on automatically when the oven is in operation. You can see inside the oven and check the progress of your food. Directions given in recipes to "elevate", "stir", "rotate", etc., should be thought of as the minimum steps recommended, for evenness and speed in microwave cooking.

### **Factors affecting cooking time:**

The cooking times given in the recipes in this book are approximate. Many factors affect cooking times. The temperature of ingredients used in a recipe, makes a big difference in the cooking time. For example, a cake made with cold butter, milk and eggs will take considerably longer to cook than one made with ingredients that are at room temperature.

On very cold or very hot days, a great deal of electricity is diverted for heating or cooling. Therefore, less electricity is available for your oven, and the food will cook more slowly than usual.

### **Range of cooking times:**

All of the recipes in this book give a range of cooking times. In general, you will find that the food remains undercooked at the lower end of the time range.

You may sometimes want to cook your food beyond the maximum time given. Personal preferences vary, as do the cooking speeds of different ovens under different conditions. While undercooked food may always be cooked a bit more, overcooked food can be ruined.

Some of the recipes, particularly those for breads, cakes and custards suggest that food be removed from the oven when it is still slightly undercooked. This is not a mistake. When allowed to stand, the food will continue to cook outside of the oven, as the heat trapped within the outer portions of the food gradually travels inward. If the food is left in the oven until it is cooked all the way through, the outer portions will become overcooked. As you gain experience in using your microwave oven, you will become increasingly skillful in estimating both cooking and standing times for various foods.

# INTRODUCTION

## HOW CHARACTERISTICS OF FOOD AFFECT MICROWAVE COOKING

### Quantity:

The greater the volume of food, the longer it takes to cook it. In general, cooking time is increased by about 50 percent, when doubling a recipe. Time is reduced by approximately 40 percent when cutting a recipe in half.

### Density:

Light, porous foods such as cakes and breads cook more quickly than heavy, dense food such as roasts, potatoes and casseroles.

### Height:

Whether conventional or microwave cooking methods are used, areas of food close to the energy source may need to be turned or shielded for even cooking.

### Shape and Size:

For more even cooking results, choose food pieces that are similar in size and shape. Arrange small, thin pieces toward the center of the dish and thicker pieces toward the outside of the dish.

### Sugar, Fat and Moisture:

Food with high sugar, fat and moisture content cooks faster than food low in these elements.

## SPECIAL TECHNIQUES IN MICROWAVE COOKING

### Browning:

Meat and poultry with high fat content that are cooked 10-15 minutes or longer, will brown lightly. Food that is cooked for a shorter period of time, may be brushed with a browning agent to achieve an appetizing color. The most commonly used browning sauces are Worcestershire sauce, soy sauce, barbecue sauce and bouquet sauce.

### Covering:

A cover traps heat and steam causing the food to cook more quickly. You may either use a lid or plastic wrap with a corner folded back, for excess steam to escape. Waxed paper effectively prevents food from spattering and helps food to retain some heat. Sandwiches and many other foods can be wrapped in paper towels to prevent them from drying out.

### Spacing:

Individual foods such as baked potatoes, cupcakes, and hors d'oeuvres will heat more evenly if placed in the oven an equal distance apart, preferably in a circular pattern.

### Stirring:

Stirring is an important microwaving technique. Microwaved foods are stirred in order to blend flavors and redistribute heat. Always stir from the outside toward the inside, since the outside of the food cooks first.

### Turning over:

Larger size food such as roasts and whole poultry should be turned, so that the top and bottom will cook evenly. It is also a good idea to turn chicken pieces and chops.

### Arrangement:

Since microwaves cook from the outside-in, it makes sense to place thicker portions of meat, poultry and fish to the outer edge of the baking dish. This way, thicker portions will receive the most microwave energy and the food will cook evenly.

### Shielding:

Strips of aluminum foil, which reflect microwaves, are sometimes placed over the corners or edges of square and rectangular shaped pans to prevent those portions from over cooking. Keep foil at least one inch away from the oven walls.

### Testing for doneness:

Because food cooks so quickly in a microwave oven, it is necessary to test for doneness frequently. Most foods are removed from the oven while still slightly undercooked, and finish cooking during standing time.

The internal temperature of food will rise from 5°F to 15°F during standing time.

### Piercing:

To prevent bursting, food enclosed in a shell, skin or membrane must be pierced prior to cooking. Such foods include both the yolks and whites of eggs, clams and oysters, and many whole vegetables, such as potatoes and squash.

# INTRODUCTION

## MICROWAVE-SAFE UTENSILS

Never use metal or metal-trimmed utensils in your microwave oven. Microwaves cannot penetrate metal. They will bounce off metal objects in the oven and cause "arcing", which resembles lightning. Most heat-resistant, nonmetallic cooking utensils are safe for use in your microwave oven. However, some may contain materials that render them unsuitable for microwave cooking. If you have any doubts about a particular utensil, there's a simple way to find out if it can be used in your microwave oven.

### Testing Utensils for Microwave Use:

Place the utensil in question next to a glass measure filled with water, in the microwave oven. Microwave at (Power Level 10) for 1-2 minutes. If the water heats up, but the utensil remains cool, the utensil is microwave-safe. However, if the utensil becomes warm, microwaves are being absorbed by the utensil and it should not be used in the microwave oven.

You probably have many items on hand in your kitchen right now that can be used as cooking equipment in your microwave oven. Read through the following checklist.

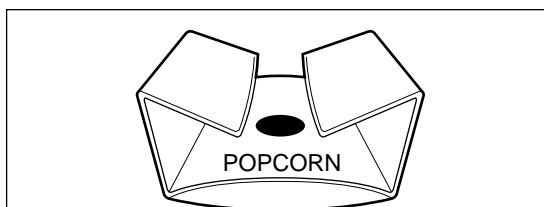

When popping a popcorn;  
Place carefully bag does not touch oven walls.  
Fold each end of the bag in half toward the center top of the bag.

### 1. Dinner Plates:

Many kinds of tableware are microwave safe. If in doubt, consult the manufacturer's literature or perform the microwave dish test.

### 2. Glassware:

Some glassware that is heatresistant is microwave-safe. This would include most brands of oven-tempered glass cookware. Do not, however, use delicate tumblers, wine glasses, etc. in the oven, as they are likely to shatter.

### 3. Paper:

Paper plates and containers without wax coatings are convenient and safe to use in your microwave oven, for short cooking times. Paper towels are also very useful for absorbing moisture and grease. In general, use white paper products.

### 4. Plastic Storage Containers:

These can be used to hold foods that are to be quickly reheated. However, they should not be used to heat foods that will need considerable time in the oven, as hot foods will eventually warp or melt the container.

### 5. Cooking Bags:

Cooking bags are microwave safe. However, be sure to make a slit in the bag so that steam can escape. Substitute string for metal twist ties.

### 6. Plastic Microwave Cookware:

A variety of cookware is available. Certain special items such as plastic ring molds, muffin pans, etc. are convenient. Check the manufacturer's instructions.

### 7. Pottery, Stoneware and Ceramic:

Containers made of these materials are usually fine for use in your microwave oven. They should be checked by using the dish test.

## CONTROL PANEL

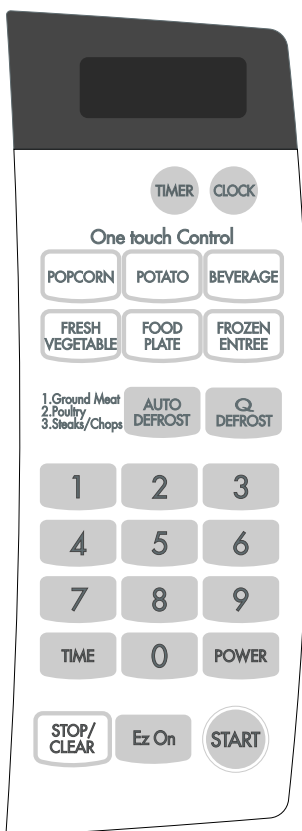

NOTE: A beep sounds when a pad on the control panel is touched to indicate a setting has been entered.

## FEATURE DIAGRAM

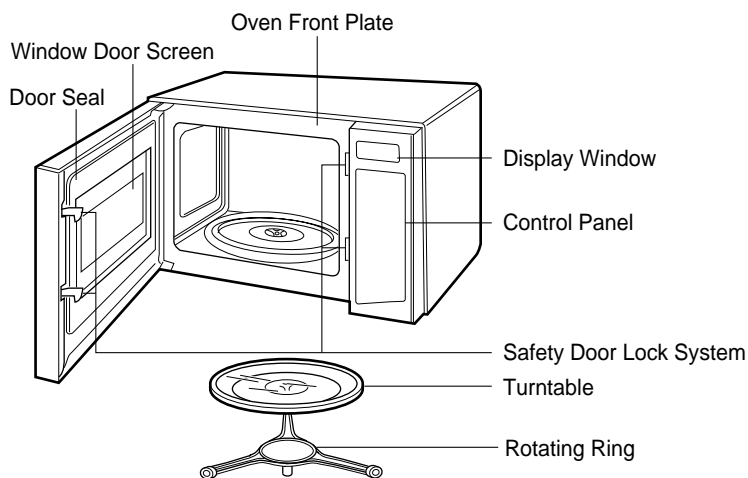

Remove your Microwave Oven and all material from the shipping carton.

Your oven will be packed with the following materials:

Glass Turntable ..... 1 each  
 Owner's Manual &  
 Cooking Guide..... 1 each  
 Rotating Ring..... 1 each

This microwave oven is designed for household use only. It is not recommended for commercial purposes.

# OPERATING INSTRUCTIONS

## SETTING TIME OF DAY

When your oven is plugged in for the first time or when power resumes after a power interruption, the numbers in the display reset to **0**.

### To set time of day:

1. Touch **STOP/CLEAR**.
2. Touch **CLOCK**.
3. Enter the time by using the number key pads.

**Example:** To set 3:15, touch number key pads **[3]**, **[1]**, and **[5]**.

4. Touch **CLOCK**.

The clock starts counting.

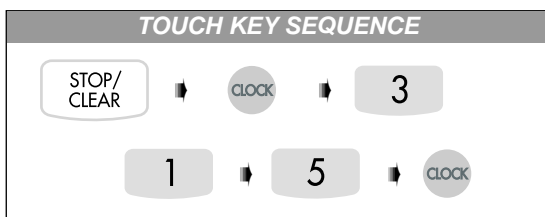

### NOTE:

If the clock (or display) shows any abnormality, unplug the oven from the AC outlet, plug it back in and then reset the clock.

## TIMED COOKING

Many foods need slower cooking (at less than HI power) in order to give you the best results. In addition to HI-POWER, there are 10 multi-power settings.

**EXAMPLE:** If you want to cook food on 80% Power(Power 8) for 5 minutes 30 seconds.

1. Touch **STOP/CLEAR**.
2. Touch **TIME**. Display shows **0**.
3. Enter 5 minutes 30 seconds by touching **[5]**, **[3]**, and **[0]**.
4. Touch **POWER**.

**P-HI** appears in the display.

This is to tell you that the oven is set on HI unless a different power setting is chosen.

5. Touch **[8]** to select power level 8.
6. Touch **START**.

Two short and one long tone sound and the word **End** shows in the display window when the cooking time is over. Then the oven shuts itself off.

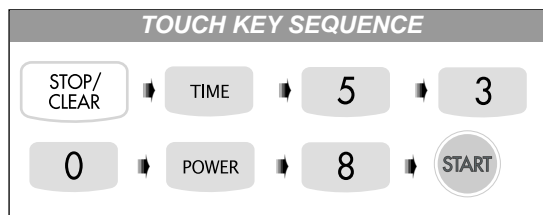

### NOTE :

If you do not select the power level, the oven will operate at power HIGH. To set HI-POWER cooking, skip steps 4, 5 above.

## 2 STAGE OR 3 STAGE TIMED COOKING

For Two or Three Stage cooking, repeat above step 2 through 5 before touching the START pad for every additional Time and Power program you want to add.

## Ez On

Ez On allows you to cook for 30 seconds at 100% power by simply touching the Ez On pad.

You can also extend cooking time in multiples of 30 seconds by repeatedly touching the Ez On pad during cooking.

**EXAMPLE:** To set cooking for 2 minutes with ADD 30 pad.

1. Touch **STOP/CLEAR**.
2. Touch **Ez On** 4 times. The oven begins cooking and display shows time counting down.

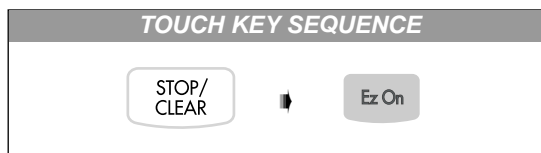

### NOTE:

Maximum available time is 99 minutes 59 seconds.

# OPERATING INSTRUCTIONS(CONT'D)

## TIMER

You can use the Timer of your oven for purposes other than food cooking.

### Example:

To count 3 minutes for an egg or telephone call.

1. Touch **STOP/CLEAR**.
2. Touch **TIMER**.
3. Touch numbers for time, [**3**], [**0**], [**0**].
4. Touch **START**.

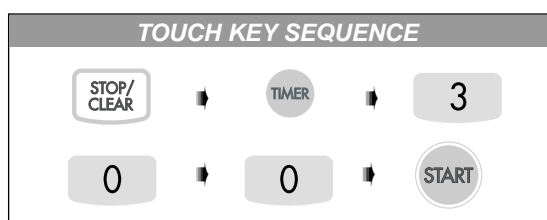

## CHILD LOCK

This is a unique safety feature that prevents accidental running of the oven. Once the child lock is set, no cooking can take place.

When the child lock is set, you can't input any key.

### To set the child lock:

1. Touch **STOP/CLEAR**.
2. Touch and hold 0 until **L** appears in the display.
2. **L** remains in the display.



### To cancel the child lock:

1. Touch and hold **0** until **L** disappears in the display.
2. The time of day returns to the display window.

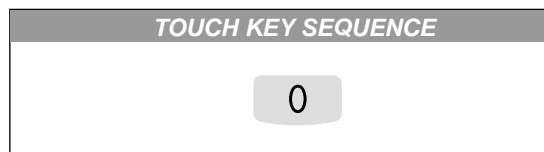

## ONE TOUCH CONTROL

This function allows you to cook popcorn, potato, beverage, fresh vegetable, food plate, and frozen entree by touching the One Touch key pad.

### Example:

To cook a 3.5 oz. bag of microwave popcorn.

1. Touch **STOP/CLEAR**.
2. Touch **POPCORN** once.

The oven begins the cooking you selected without the need to touch **START**.

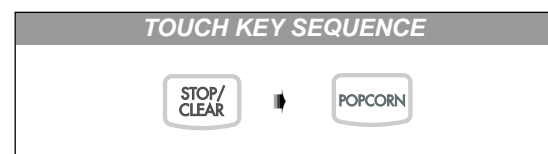

## **OPERATING INSTRUCTIONS(CONT'D)**

### **ONE TOUCH CONTROL CHART**

<b>Key</b>	<b>Touch</b>	<b>Serving size</b>	<b>Directions</b>
<b>POPCORN</b>	one Time two Times three Times	3.5 oz. 3.0 oz. 1.75 oz.	<ul style="list-style-type: none"> <li>• Follow package instructions.</li> <li>• Use popcorn package which is made especially for microwave cooking.(Refer to 8 page)</li> <li>• Do not try to pop unpopped kernels.</li> <li>• Heat only 1 package at a time.</li> <li>• Do not leave the microwave oven unattended while popping popcorn.</li> </ul>
<b>POTATO</b>	one Time two Times three Times four Times	1 2 3 4	<ul style="list-style-type: none"> <li>• 8-10 oz. per potato.</li> <li>• Place in center of the turntable tray on paper towel.</li> <li>• Pierce potato several times with fork.</li> <li>• After cooking, let stand for 5 minutes.</li> <li>• No cover.</li> </ul>
<b>BEVERAGE</b>	one Time two Times	1 cup 2 cups	<ul style="list-style-type: none"> <li>• 240ml per cup.</li> <li>• Use mug or microwave-safe cup.</li> <li>• Stir after reheating.</li> </ul>
<b>FRESH VEGETABLE</b>	one Time two Times three Times four Times	1 cup 2 cups 3 cups 4 cups	<ul style="list-style-type: none"> <li>• Prepare vegetable(wash and cut into 1/2-inch pieces).</li> <li>• Cover with plastic wrap and vent.</li> <li>• Most vegetables need 2 to 3 minutes standing time to finish cooking. 1 &amp; 2 cups - Add 2 tablespoon water. 3 &amp; 4 cups - Add 4 tablespoon water.</li> </ul>
<b>FOOD PLATE</b>	one Time two Times	1 serving 2 servings	<ul style="list-style-type: none"> <li>• Arrange food on turntable tray.</li> <li>• Place meaty portions and bulky vegetable to the outside of the plate.</li> <li>• Cover with plastic wrap and vent.</li> <li>• After cooking, let stand for 2 minutes.</li> </ul>
<b>FROZEN ENTREE</b>	one Time	10 oz.	<ul style="list-style-type: none"> <li>• Follow the package instructions.</li> <li>• Example of one frozen entree is Lasagna with Meat Sauce, Chicken with Rice, Sliced Turkey Breast with Rice and Vegetable.</li> </ul>

# OPERATING INSTRUCTIONS(CONT'D)

## MICROWAVE POWER LEVELS

Your microwave oven is equipped with ten power levels (11 steps including 0) to give you maximum flexibility and control over cooking. When your cooking program is completed, a beep automatically sounds. The table below will give you some idea of which foods are prepared at each of the various power levels.

### MICROWAVE POWER LEVEL CHART

Power Level	Output (of watts)	Use
10 (High)	100%	<ul style="list-style-type: none"> <li>● Boil water.</li> <li>● Brown ground beef.</li> <li>● Cook fresh fruits &amp; vegetables.</li> <li>● Make candy.</li> <li>● Cook fish, meat &amp; poultry.</li> <li>● Preheat browning dish.</li> </ul>
9	90%	<ul style="list-style-type: none"> <li>● Heat precooked food.</li> <li>● Saute onions, celery &amp; green pepper.</li> </ul>
8	80%	<ul style="list-style-type: none"> <li>● All reheating</li> </ul>
7	70%	<ul style="list-style-type: none"> <li>● Roast meat &amp; poultry.</li> <li>● Cook mushrooms &amp; shellfish.</li> <li>● Cook foods which contain cheese &amp; eggs.</li> </ul>
6	60%	<ul style="list-style-type: none"> <li>● Bake cakes, muffins.</li> <li>● Prepare eggs.</li> </ul>
5	50%	<ul style="list-style-type: none"> <li>● Cook meat, poultry.</li> <li>● Cook custard</li> <li>● Prepare rice, soup.</li> </ul>
4	40%	<ul style="list-style-type: none"> <li>● Melt butter &amp; chocolate.</li> <li>● Cook less tender cuts of meat.</li> </ul>
3	30%	<ul style="list-style-type: none"> <li>● All defrosting</li> </ul>
2	20%	<ul style="list-style-type: none"> <li>● Soften butter &amp; cheese.</li> </ul>
1	10%	<ul style="list-style-type: none"> <li>● Soften ice cream.</li> <li>● Raise yeast dough.</li> </ul>
0	0	<ul style="list-style-type: none"> <li>● Standing time.</li> <li>● Independent timer.</li> </ul>

## Q-DEFROST

The Q-DEFROST sequences are preset in the oven, Q-DEFROST feature provides you with the quick defrosting method for 1.0 lbs frozen food. The oven automatically sets the defrosting time. When the oven will sound-tone during time counting down, open the door and turn, separate or rearrange food.

# OPERATING INSTRUCTIONS(CONT'D)

## AUTO DEFROST

Three defrost sequences are preset in the oven. The defrost feature provides you with the best defrosting method for frozen foods. The auto defrost guide will show you which defrost sequence is recommended for the food you are defrosting.

The oven automatically determines required defrosting times for each food item according to the weight you enter.

For added convenience, the Auto Defrost Feature contains a built-in beep mechanism that lets you check, turn over, separate or rearrange as recommended in the AUTO DEFROST GUIDE.

Three different defrosting levels are provided.

**dEF1 GROUND MEAT**

**dEF2 POULTRY**

**dEF3 STEAKS/CHOPS**

**EXAMPLE:**

To defrost 1.2lbs of ground beef.

1. Touch **STOP/CLEAR**.
2. Touch **AUTO DEFROST** once. **dEF1** appears in the display.
3. Enter the weight by touching **[1]** and **[2]**. **1.2** appears in the display.
4. Touch **START**.

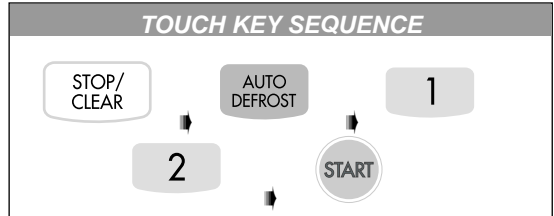

The display changes to defrost time count down. The oven will beep during the DEFROST cycle. At this time, open the door and turn, separate or rearrange the food.

Remove any portions that have thawed. Return frozen portions to the oven and touch **START** to resume the defrost cycle. The oven will not **STOP** during the **BEEP** unless the door is opened.

- For best results, remove fish, shellfish, meat, and poultry from its original closed paper or plastic package (wrapper). Otherwise, the wrap will hold steam and juice close to the foods, which can cause the outer surface of the foods to cook.
- Place foods in a shallow glass baking dish or microwave roasting rack to catch drippings.
- Food should still be somewhat icy in the center when removed from the oven.

## AUTO DEFROST GUIDE

SEQUENCE	TOUCH AUTO DEFROST	FOOD	MIN./MAX.
<b>GROUND MEAT</b>	<b>one time</b>	● <b>BEEF</b> .....Ground beef, Cubes for stew, Pot roast, Rib roast, Rump roast, Chuck roast, Hamburger patty.	0.1/6.0 lbs.
		● <b>LAMB</b> .....Rolled roast	
		● <b>PORK</b> .....Hot dogs, Spareribs, Country-style ribs, Rolled roast, Sausage.	
		● <b>VEAL</b> .....Cutlets (1lb., 1/2-inch thick)	
<b>POULTRY</b>	<b>two times</b>	● <b>POULTRY</b> .....Whole (under 4 lbs), Cut up Breasts (boneless)	0.1/6.0 lbs.
		● <b>CORNISH HENS</b> ...Whole	
		● <b>TURKEY</b> .....Breast (under 6 lbs.)	
<b>STEAKS/CHOPS</b>	<b>three times</b>	● <b>STEAKS</b> .....Round steak, Tenderloin steak.	0.1/6.0 lbs.
		● <b>CHOPS</b> .....Lamb chops (1-inch thick), Pork chops (1/2-inch thick).	
		● <b>FISH</b> .....Fillets, Steaks, Whole.	
		● <b>SHELLFISH</b> .....Crab meat, Lobster tails, Shrimp, Scallops	

## OTHER HELPFUL INSTRUCTIONS

### For Best Results:

1. When determining time for a particular food, begin by using the minimum time and check occasionally for desired doneness.
2. Small quantities of food or foods with low water content may burn, dry out, or become hard if cooked too long.
3. Do not cook eggs in the shell. They may burst.
4. Foods with non-porous skin or membrane (i.e. apples, potatoes, eggs) should be pierced when heated whole to prevent bursting.
5. Do not use narrow neck bottles in the microwave oven. They may shatter.

### Defrosting Frozen Foods:

1. Foods that have been frozen in non-metallic wrapping can be placed directly in the oven for thawing.
2. If some portions of the foods thaw faster than other areas, cover the thawed portions with small pieces of aluminum foil. This helps slow down or stop the defrosting process in the shielded areas.

### Browning:

There are some foods which are not cooked long enough in the microwave oven to brown and for more eye appeal may need additional color. Coating mixes such as SHAKE & BAKE<sup>®</sup>, paprika, steak sauce or browning sauce such as Kitchen Bouquet<sup>®</sup> or Worcestershire sauce may be used on chops, meat patties or chicken parts. Roasts and poultry (cooked for 15 minutes or longer) brown nicely without anything added.

### Browning Dish:

Micro Browning dishes may be used to achieve a brown surface on small items such as steaks, chops, pancakes, etc. Follow instructions provided with Micro browning dish. The Micro browning dishes are designed only for use in microwave ovens. Do not use in conventional oven or range top.

**NOTE:** DO NOT PREHEAT THE BROWNING DISH ON THE TURNABLE TRAY MORE THAN 8 MINUTES.

### Time Variations:

Foods available vary throughout the country and may cause cooking times to differ from those given in the Cooking Guide. For this reason, cooking times given are approximate. Factors that may affect cooking time include starting temperature, volume, size and shape of foods and utensils used. As you become more familiar with the oven, you will be able to adjust the timing to these factors.

### Cooking Utensils:

1. Most glass, glass ceramic, and heat resistant glassware utensils are excellent. Those with metallic trim should not be used in the microwave oven. (Check Cooking Guide for "DISH TEST".)
2. Paper napkins, towels, plates, cups, cartons, freezer wrap and cardboard are great convenient utensils. Some recycled paper products may contain impurities which when combined with hot fat could cause sparking (arcing) or fires when used for cooking in the microwave oven. Do not use. (CONSULT COOKING GUIDE FOR CORRECT USE OF THESE PRODUCTS.)
3. Plastic dishes, cups, freezer containers and plastic wraps may be used in the microwave oven. Follow Manufacturers' instructions of information given in Cooking Guide when using plastics in the microwave oven.
4. Meat utensils and utensils with metallic trim should not be used in the microwave oven. For more instructions on the proper use of metal in your oven, please read the Introduction section in the Cooking Guide. When using foil, skewers, or utensils made of metal in the oven allow at least one inch of space between metal material and interior oven walls. If arcing (sparking) appears, remove metal material (skewer, etc) and transfer to a non-metallic container.
5. Do not pop popcorn in your microwave oven unless in a special microwave popcorn accessory or unless you use popcorn labeled for use in microwave oven. Because of the heat generated, without these precautions, the container could catch fire.

## CARE OF YOUR MICROWAVE OVEN

### TO CLEAN YOUR OVEN:

1. Keep the inside of the oven clean.  
Food spatters or spilled liquids stick to oven walls and between seal and door surface. It is best to wipe up spillovers with a damp cloth right away. Crumbs and spillovers will absorb microwave energy and lengthen cooking times. Use a damp cloth to wipe out crumbs that fall between the door and the frame. It is important to keep this area clean to assure a tight seal. Remove greasy spatters with a sudsy cloth, then rinse and dry. Do not use harsh detergent or abrasive cleaners. The glass tray can be washed by hand or in the dishwasher.
2. Keep the outside of the oven clean.  
Clean the outside of your oven with soap and water then with clean water and dry with a soft cloth or paper towel. To prevent damage to the operating parts inside the oven, the water should not be allowed to seep into the ventilation openings.  
To clean the control panel, open the door to prevent the oven from accidentally starting, and wipe with a damp cloth followed immediately by a dry cloth. Press STOP/CLEAR after cleaning.
3. If steam accumulates inside or around the outside of the oven door, wipe the panels with a soft cloth. This may occur when the microwave oven is operated under high humidity conditions and in no way indicates a malfunction of the unit.

## PRECAUTIONS

- ⦿ Do not attempt to tamper with or make any adjustments or repairs to door control panel, safety interlock switches, or any other part of the oven. Repairs should be made by qualified service personnel only.
- ⦿ Be certain to place the front surface of the door three inches away or more from the countertop edge to avoid accidental tipping of the appliance in normal usage.
- ⦿ For the most accurate programming of the electronic units, touch the center of each pad securely. Do not touch several pads at one time or touch between pads. A beep sound should be heard with each touch when a pad is touched correctly.
- ⦿ Do not hit or strike the control with objects such as silverware, utensils, etc. Breakage may occur.
- ⦿ Be careful when taking the cooking utensils out of the oven. Some dishes absorb heat from the cooked food and may be hot.
- ⦿ Do not rinse cooking utensils by immediately placing them into water just after cooking. This may cause breakage. Allow the turntable to cool.
- ⦿ Use only specific glass utensils. See cooking utensils section in this manual.
- ⦿ Do not operate the oven empty. Either food or water should always be in the oven during operation to absorb microwave energy.
- ⦿ Do not heat unopened food containers in the oven. Pressure build-up can cause the container to burst, resulting in injury.
- ⦿ Do not use your microwave oven to dry newspapers or clothes. They can catch fire.
- ⦿ Only use thermometers approved for microwave oven cooking.
- ⦿ Be certain the turntable is in place when you operate the oven.
- ⦿ Pierce the skin of potatoes, whole squash, apples, or any fruit or vegetable which has a skin covering before cooking.
- ⦿ Never use your microwave oven to cook eggs in the shell. Pressure can build up inside the shell causing it to burst.
- ⦿ Do not pop popcorn, except in a microwave-safe container or commercial package designed especially for microwave ovens. Never try to pop popcorn in a paper bag not designed for microwave oven use. Overcooking may result in smoke and fire. Do not repop unpopped kernels. Do not reuse popcorn bags.

## QUESTIONS AND ANSWERS

**Q.** Why won't the oven light will glow?

**A.** There may be several reasons why the oven light will not glow.

■ Light bulb is burned out.

■ START has not been touched.

**Q.** Does microwave energy pass through the viewing screen in the door?

**A.** No. The holes, or ports, are made to allow light to pass; they do not let microwave energy through.

**Q.** Why does the beep tone sound when a pad on the Control Panel is touched?

**A.** The beep tone sounds to assure that the setting is being entered properly.

**Q.** Will the microwave oven be damaged if it operates while empty?

**A.** Yes. Never run it empty or without the glass tray.

**Q.** Why do eggs sometimes pop?

**A.** When baking, frying, or poaching eggs, the yolk may pop due to steam build up inside the yolk membrane. To prevent this, simply pierce the yolk before cooking. Never microwave eggs in the shell.

**Q.** Why is standing time recommended after microwave cooking is over?

**A.** After microwave cooking is finished, food keep on cooking during standing time. This standing time finishes cooking evenly throughout the food. The amount of standing time depends on the density of the food.

**Q.** Is it possible to pop popcorn in a microwave oven?

**A.** Yes, if using one of the two methods described below:

(1) Popcorn-popping utensils designed specifically for microwave cooking.

(2) Prepackaged commercial microwave popcorn that contains specific times and power outputs needed for an acceptable final product.

FOLLOW EXACT DIRECTIONS GIVEN BY EACH MANUFACTURER FOR ITS POPCORN PRODUCT. DO NOT LEAVE THE OVEN UNATTENDED WHILE THE CORN IS BEING POPPED. IF CORN FAILS TO POP AFTER THE SUGGESTED TIMES, DISCONTINUE COOKING. OVERCOOKING COULD RESULT IN AN OVEN FIRE.

**CAUTION:** NEVER USE A BROWN PAPER BAG FOR POPPING CORN. NEVER ATTEMPT TO POP LEFTOVER KERNELS.

**Q.** Why doesn't my oven always cook as fast as the cooking guide says it should?

**A.** Check your cooking guide again to make sure you've followed the directions correctly, and to see what might cause variations in cooking time. Cooking guide times and heat settings are suggestions, chosen to help prevent over-cooking, the most common problem in getting used to a microwave oven. Variations in the size, shape, weight and dimensions of the food could require a variation in cooking time. Use your own judgement along with the cooking guide suggestions to test for doneness, just as you would do with conventional cooking.

### FEDERAL COMMUNICATIONS COMMISSION RADIO FREQUENCY INTERFERENCE STATEMENT

## WARNING:

This equipment generates and uses ISM frequency energy and if not installed and used properly, that is in strict accordance with the manufacturer's instructions, may cause interference to radio and television reception. It has been type tested and found to comply with limits for ISM Equipment pursuant to part 18 of FCC Rules, which are designed to provide reasonable protection against such interference in a residential installation.

However, there is no guarantee that interference will not occur in a particular installation. If this equipment does cause interference to radio or television reception, which can be determined by turning the equipment off and on, the user is encouraged to try to correct the interference by one or more of the following:

- Reorient the receiving antenna of the radio or television.
- Relocate the microwave oven with respect to the receiver.
- Move the microwave oven away from the receiver
- Plug the microwave oven into a different outlet so that the microwave oven and the receiver are on different branch circuits.

**The manufacturer** is not responsible for any radio or TV interference caused by **unauthorized modification** to this microwave oven. It is the responsibility of the user to correct such interference.

# COOKING GUIDES

**WARNING :** Do not use aluminum foil during cooking cycle.

## GROUND MEAT

1. No special techniques are required. The roast should be prepared and seasoned (if desired) as for any other conventional method. Meat should be thoroughly defrosted before cooking.
2. Place the meat on a microwave roasting rack or ovenproof plate and place on the turntable.
3. Cook according to the cooking chart (below), using the longer time for large meats and the shorter time for smaller meats. For thicker chops, use the longer time.
4. Turn the meat once halfway through the cooking time.
5. STAND for 5-10 minutes wrapped in foil after cooking. The standing time is very important as it completes the cooking process.
6. Ensure meat, especially, pork is thoroughly cooked before eating.

## MEAT COOKING CHART

Cut	Microwave power	Cooking Time per pound
<b>Beef</b>		
Standing/Rolled Rib-Rare	8	9~11 minutes
-Medium	8	10~12 minutes
-Well done	8	12~14 minutes
Ground Beef(to brown for casserole)	HIGH	7~9 minutes
Hamburgers, Fresh or defrosted (4 oz. each)		
2 patties	HIGH(100%)	3~5 minutes
4 patties	HIGH(100%)	4~6 minutes
<b>Pork</b>		
Loin, Leg	8	13~16 minutes
Bacon		
4 slices	HIGH	3~4 minutes
6 slices	HIGH	4~6 minutes

**NOTE:** The above times should be regarded only as a guide. Allow for difference in individual tastes and preferences. The times may vary due to the shape, cut, and composition of the meat.

## POULTRY

1. No special techniques are required. The poultry should be prepared as for any other conventional method. Season if desired.
2. Poultry should be thoroughly defrosted, ensuring giblets and any metal clamps are removed.
3. Prick the skin and brush lightly with vegetable oil unless self basting.
4. All poultry should be placed on a microwave roasting rack or a microwave-proof plate and placed on the turntable.
5. Cook according to the instructions in the cooking chart (on the following page), turning the bird over halfway through the cooking time.  
Poultry, because of its shape, have a tendency to cook unevenly, especially in very bony parts. Turning the bird during roasting helps to cook these areas evenly.

**NOTE:** If whole birds are stuffed, the weight of the stuffed bird should be used when calculating the cooking time.

## COOKING GUIDES (CONT'D)

### **WARNING : Do not use aluminum foil during cooking cycle.**

6. STAND for 5-10 minutes wrapped in foil after cooking before carving. The standing time is very important, as it completes the cooking process.
7. Ensure poultry is thoroughly cooked before eating. Whole poultry is completely cooked when the juices run clear from the inside thigh when it is pierced with a sharp knife. Poultry portions should be pierced with a sharp knife through the thickest part to ensure that the juices are clear and the flesh is firm.

### POULTRY COOKING CHART

Poultry	Microwave power	Cooking Time per pound
<b>Chicken</b>		
Whole	8	12~14 minutes
Breast(boned)	8	10~12 minutes
Portions	8	11~13 minutes
<b>Turkey</b>		
Whole	8	13~15 minutes

**NOTE:** The above times should be regarded only as a guide. Allow for differences in individual tastes and preferences.  
The times may vary due to the shape and composition of the food.

### STEAKS/CHOPS

1. Arrange fish in a large shallow non-metallic dish or casserole.
2. Cover with pierced microwave plastic film or casserole lid.
3. Place the dish on the turntable.
4. Cook according to the instructions in the cooking chart (below). Flakes of butter can be added to the fish if desired.
5. Let STAND as directed in the cooking chart before serving.
6. After standing time, check to see that the fish is thoroughly cooked. The fish should be opaque and flake easily.

### FRESH FISH COOKING CHART

Fish	Microwave power	Cooking Time per pound	Method	Standing Time
Fish Fillets	HIGH	5~7 minutes	Add 15~30 ml (1-2 tbsp.) lemon juice.	2-3 minutes
Whole Mackerel, Cleaned and Prepared	HIGH	5~7 minutes	—	3-4 minutes
Whole Trout, Cleaned and Prepared	HIGH	6~8 minutes	—	3-4 minutes
Salmon Steaks	HIGH	6~8 minutes	Add 15~30 ml (1-2 tbsp.) lemon juice.	3-4 minutes

## VEGETABLE COOKING CHART

Vegetable	Preparation	Quantity	Cooking Time at power Level 10	Standing Time
artichokes, fresh	whole	4 (8-oz. each.)	12-14 minutes	5 minutes
artichoke, frozen	hearts	9-oz. package	10-11 minutes	5 minutes
asparagus, fresh	1½-in. pieces	1 lb.	9-10 minutes	3 minutes
asparagus, frozen	whole spears	10-oz. package	9-11 minutes	3 minutes
beans, green or wax, fresh	1½-in. pieces	1lb.	10-12 minutes	—
beans, green or wax, frozen	cut up	9-oz. package	8-10 minutes	3 minutes
beets, fresh	sliced	1½ - 2 lb.	16-18 minutes	5 minutes
broccoli, fresh	spears	1lb.	9-11 minutes	—
broccoli, frozen	whole or cut	10 oz. package	9-10 minutes	3 minutes
brussels sprouts, fresh	whole	10-oz. tub	8-10 minutes	—
brussels sprouts, frozen	whole	10-oz. package	9-10 minutes	3 minutes
cabbage, fresh	chopped	1 lb.	9-10 minutes	5 minutes
	wedges	1 lb.	9-11 minutes	5 minutes
carrots, fresh	½-in. slices	1 lb.	5-8 minutes	3 minutes
carrots, frozen	sliced	10-oz. package	8-10 minutes	3 minutes
cauliflower, fresh	florets	1 medium head	9-11 minutes	3 minutes
	whole	1 medium head	9-12 minutes	5 minutes
cauliflower, frozen	florets	10-oz. package	8-10 minutes	3 minutes
celery, fresh	½-in. slices	1lb.	9-11 minutes	5 minutes
corn, fresh	on cob, husked	4 ears	11-13 minutes	5 minutes
corn, frozen	on cob, husked	4 ears	13-15 minutes	5 minutes
	whole kernel	10-oz. package	9-10 minutes	3 minutes
eggplant, fresh	cubed	1 lb.	9-11 minutes	3 minutes
	whole, pierced	1-1½ lb.	10-12 minutes	5 minutes
leeks fresh	whole, ends	1 lb.	10-12 minutes	5 minutes
lima beans, frozen	whole	10 oz. package	8-10 minutes	3 minutes
mixed vegetables frozen	—	10 oz. package	8-10 minutes	3 minutes
mushrooms, fresh	sliced	1 lb.	7-9 minutes	3 minutes
okra, frozen	sliced	10 oz. package	8-10 minutes	5 minutes
onions, fresh	whole, peeled	8-10 small	13-17 minutes	5 minutes
peas, fresh	shelled	1 lb.	8-10 minutes	—
peas, frozen	shelled	10-oz. package	8-10 minutes	3 minutes
pea pods(snow peas),frozen	whole	6-oz. package	7-8 minutes	—
peas and carrots	—	10-oz. package	9-11 minutes	3 minutes
parsnips, fresh	cubed	1 lb.	9-10 minutes	5 minutes
potatoes, white or sweet,fresh	whole	4 (6 oz. each)	13-15 minutes	3 minutes
	whole	8 (6 oz. each)	18-20 minutes	5 minutes
rutabaga, fresh	cubed	4 cups	14-16 minutes	5 minutes
spinach, fresh	whole leaf	1 lb.	8-11 minutes	—
spinach, frozen	leaf or chopped	10-oz. package	9-10 minutes	3 minutes
squash, summer, fresh	½-in. slices	1 lb.	9-11 minutes	3 minutes
squash, summer, frozen	sliced	10-oz. package	8-10 minutes	3 minutes
squash, winter, fresh	whole, pierced	1½ lbs.	15-17 minutes	5 minutes
squash, winter, frozen	whipped	12-oz. package	10-12 minutes	3 minutes
succotash, frozen	—	10-oz. package	9-11 minutes	3 minutes
turnips	cubed	4 cups	14-16 minutes	3 minutes

## REHEATING CHART

Item	Quantity	Power Level	Heating Time (in minutes)	Special Instructions
Appetizers (bite size)	2 servings	10	4 to 6	Heat 12 at a time on paper towel lined paper plate or microwave oven roasting rack.
Breakfast entree	4 to 5 oz.	10	3 to 5	If container is $\frac{3}{4}$ -inch deep, remove foil cover and replace foil tray in original box. For containers more than $\frac{3}{4}$ inch deep, remove food to similar size glass container; heat, covered. If no top crust stir occasionally.
Entree	8 to 9 oz.	10	8 to 10	
	21 oz.	10	14 to 17	
Regular TV-style dinner	11 oz.	10	7 $\frac{1}{2}$ to 9	
Hearty TV-style dinner	17 oz.	10	9 to 12	
Fried chicken	2 pieces	10	5 to 7	Arrange, on paper towel lined paper plate, covered with paper towel.
	4 pieces	10	6 to 8	
	6 pieces	10	7 to 9	
Fried fresh fillets	2 fillets	10	3 to 4	
	4 fillets	10	4 to 6	
Pizzas	1	5	2 to 4	Arrange on microwave oven roasting rack.
	2	5	4 to 5	
	4	5	5 to 7	
Pouch dinners	5 to 6 oz.	10	5 to 6	Pierce pouch. Set on plate. Turn over halfway through cooking.
	10 to 11 oz.	10	9 to 11	
Bagels	2	4	1 $\frac{1}{2}$ to 2	Each individually wrapped in paper toweling (for 1 to 2) or arrange on paper plate, cover with paper toweling.
	4	4	2 to 4	
Danish	1	4	1 to 2	
	2	4	2 to 3	
	4 (6 oz. pkg)	4	3 to 4	
	6 (13 oz. pkg)	4	4 to 5	
Dinner rolls	6	4	2 to 3	
Hard rolls	1 (1 to 1 $\frac{1}{4}$ oz.)	4	1 to 2	
	2	4	1 $\frac{1}{2}$ to 2 $\frac{1}{2}$	
	4	4	2 to 3	
Frozen juice	6 oz.	10	1 to 2	Remove lid. If container is foil lined transfer to a pitcher or open carton. Let stand after defrosting.
Concentrates	12 oz.	10	2 to 5	
Non-Dairy creamer	16 oz.	4	10 to 12	
Pancake	10 oz	4	5 to 6	
Frozen vegetables	6 oz.	10	3 to 5	Pierce box, set on plate. If box is foil wrapped, remove foil. If vegetables are in pouch, pierce pouch. Let stand 5 minutes.
	10 oz.	10	5 to 6 $\frac{1}{2}$	
Cheese cake	17 oz.	4	4 to 5	Remove from original container. Arrange on a serving plate. Let stand 5 minutes after cooking (to defrost). Add an additional 1 to 2 minutes to serve warm.
Brownies	13 oz.	4	2 to 4	
Pound cake	10 $\frac{3}{4}$ oz.	4	1 $\frac{1}{2}$ to 3	
Coffee cake	11 to 12 oz.	4	3 to 5	

## CLEANING

Before cleaning the oven, unplug the power supply cord of the oven. If impossible, open the oven door to prevent an accidental oven start.

### INSIDE OF THE OVEN

Use a damp cloth to wipe out crumbs and spillovers. It is important to keep the area between door and cavity front clean to assure a tight seal. Remove greasy spatters with a sudsy cloth, then rinse and dry.

Do not use harsh detergent or abrasive cleaners.

### GLASS TRAY

The glass tray can be washed by hand or in dishwasher.

### CONTROL PANEL

Wipe with a damp cloth followed immediately by a dry cloth.

### DOOR

If steam accumulates inside or around the outside of the oven door, wipe the panel with a soft cloth.

This may occur when the microwave oven is operated under high humidity conditions and in no way indicates a malfunction of the unit.

### OUTSIDE OVEN SURFACE

Clean with damp cloth. To prevent damage to the operating parts inside the oven, the water should not be allowed to seep into the ventilation openings.

After cleaning the oven, be sure that the rotating ring and the glass tray are in the right position. Press the STOP/CLEAR pad twice to reset any accidental key setting.

## BEFORE CALLING FOR SERVICE

Please check your problem by using the guide below and try the solutions for each problem. If the microwave oven still does not work properly, contact the nearest authorized service center.

### OVEN WILL NOT START AT ALL

\*Electrical cord for oven is not plugged in.

-Plug into the outlet.

\*Door is open.

-Close the door open and try again.

\*Wrong operation is set.

-Check operation instructions.

### ARCING OR SPARKING

\*Materials to be avoided in microwave oven are used.

-Use microwave-safe cookware only.

\*The oven is operated when empty.

-Do not operate with oven empty.

\*Food refuse remains in the cavity or inside the cavity is uncleaned.

-Clean cavity with wet towel.

### UNEVEN COOKING OR POOR DEFROSTING

\*Materials to be avoided in microwave oven are used.

-Use microwave-safe cookware only.

\*Cooking time/Cooking power level is not suitable.

-Use correct time/Cooking power level.

\*Food is not turned or stirred.

-Turn or stir food.

### OVERCOOKED FOODS

\*Cooking time/Cooking power level is not suitable.

-Use correct time/cooking power level.

### UNDERCOOKED FOODS

\*Materials to be avoided in microwave oven are used.

-Use microwave-safe cookware only.

\*Food is not defrosted completely.

-Completely defrost food.

\*Oven ventilation ports are restricted.

-Check to see that oven ventilation ports are not restricted.

\*Cooking time/Cooking power level is not suitable.

-Use correct time/Cooking power level.

### ALL THESE THINGS ARE NORMAL

\*Dull thumping sound during oven operation.

\*Steam or vapor escaping from around the door.

\*Light reflection around door or outer wrapper.

\*Dimming oven light and change in blower sound during oven operation at power levels other than high.

\*Some radio and TV interference might occur during operations. It is similar to the interference caused by other small appliances such as mixers, blow dryer, etc.

# GOLDSTAR MICROWAVE OVEN LIMITED WARRANTY – USA

## Model MAB745W/B

LG Electronics, Inc. will repair or replace your product, at LG's option, if it proves to be defective in material or workmanship under normal use, during the warranty period set forth below, effective from the date of original consumer purchase of the product. This warranty is good only to the original purchaser of the product and effective only when used in the United States, including U.S. Territories.

<p><b><u>WARRANTY PERIOD:</u></b></p> <p><b>One Year</b> from the Date of Purchase.</p>	<p><b><u>HOW SERVICE IS HANDLED:</u></b></p> <p><b><u>Product Replacement</u></b></p> <p><b>Please call 1-800-243-0000 and choose the <i>Customer Service/Appliance</i> options.</b> (Phones are answered 24 hours a day, 365 days per year.) You will receive a certificate to purchase a replacement product from your local dealer.</p> <p>You will then send the purchase receipts for the original and the replacement microwave ovens, along with the purchase authorization certificate to us.</p> <p>We will send you a refund check for the purchase price of the original product. This gives you the opportunity to upgrade to another model or to receive the full purchase price of the original model even if you decide to purchase a less expensive model.</p> <p>Please visit our website at: <a href="http://us.lgservice.com">http://us.lgservice.com</a></p>
---	--

**THIS WARRANTY IS IN LIEU OF ANY OTHER WARRANTY, EXPRESS OR IMPLIED, INCLUDING WITHOUT LIMITATION, ANY WARRANTY OF MERCHANTABILITY OR FITNESS FOR A PARTICULAR PURPOSE. TO THE EXTENT ANY IMPLIED WARRANTY IS REQUIRED BY LAW, IT IS LIMITED IN DURATION TO THE EXPRESS WARRANTY PERIOD ABOVE. LG WILL NOT BE LIABLE FOR ANY INCIDENTAL, CONSEQUENTIAL, INDIRECT, SPECIAL, OR PUNITIVE DAMAGES OF ANY NATURE, INCLUDING WITHOUT LIMITATION, LOST REVENUES OR PROFITS, OR ANY OTHER DAMAGE WHETHER BASED IN CONTRACT, TORT, OR OTHERWISE.** Some states do not allow the exclusion or limitation of incidental or consequential damages or limitations on how long an implied warranty lasts, so the above exclusion or limitation may not apply to you. This warranty gives you specific legal rights and you may also have other rights that vary from state to state.

**THIS LIMITED WARRANTY DOES NOT APPLY TO:**

- Service trips to your home to deliver, pick up, and/or install the product, instruct, or replace house fuses or correct wiring, or correction of unauthorized repairs.
- Damages or operating problems that result from misuse, abuse, operation outside environmental specifications or contrary to the requirements of precautions in the Operating Guide, accident, vermin, fire, flood, improper installation, acts of God, unauthorized modification or alteration, incorrect electrical current or voltage, or commercial use, or use for other than intended purpose.

The cost of repair or replacement under these excluded circumstances shall be borne by the consumer.

**CUSTOMER INTERACTIVE CENTER NUMBERS**

<p><b>To obtain Customer Assistance, Product Information, or Dealer or Authorized Service Center location:</b></p>	<p><b>Call 1-800-243-0000</b> (24 hours a day, 365 days per year) and select the appropriate option from the menu.</p> <p><b>Or visit our website at: <a href="http://us.lgservice.com">http://us.lgservice.com</a></b></p>
--	---

**TO CONTACT LG ELECTRONICS BY MAIL:**

LG Customer Interactive Center  
P. O. Box 240007  
201 James Record Road  
Huntsville, Alabama 35824  
ATTN: CIC



**LG Electronics Inc.**

P/NO. 3828W5A8032

Printed in China