



LIGHT OVEN "SolarDOM"

OWNER'S MANUAL

PLEASE READ THIS OWNER'S MANUAL THOROUGHLY BEFORE OPERATING.

MP-9482S

P/No: MFL38195702

Precautions

Precautions to avoid possible exposure to excessive microwave energy.

You cannot operate your oven with the door open due to the safety interlocks built into the door mechanism. These safety interlocks automatically switch off any cooking activity when the door is opened; which in the operation of microwave function could result in harmful exposure to microwave energy.

It is important not to tamper with the safety interlocks.

Do not place any object between the oven front face and the door or allow food or cleaner residue to accumulate on sealing surfaces.

Do not operate your oven if it is damaged. It is particularly important that the oven door closes properly and that there is no damage to the: (1) door(bent), (2) hinges and latches (broken or loosened), (3) door seals and sealing surfaces.

Your oven should not be adjusted or repaired by anyone except qualified service personnel.

WARNING

Please ensure cooking times are correctly set as over cooking may result in the FOOD catching fire and subsequent damage to your oven.

When heating liquids, e.g. soups, sauces and beverages in your oven with microwave function, delayed eruptive boiling can occur without evidence of bubbling. This could result in a sudden boil over of the hot liquid. To prevent this possibility the following steps should be taken:

- 1 Avoid using straight sided containers with narrow necks.
- 2 Do not overheat.
- 3 Stir the liquid before placing the container in the oven and again halfway through the heating time.
- 4 After heating, allow to stand in the oven for a short time, stir or shake them(especially the contents of feeding bottles and baby food jars) again carefully and check the temperature of them before consumption to avoid burns (especially, contents of feeding bottles and baby food jars).
Be careful when handling the container.

WARNING

Always allow food to stand after being cooked by microwaves and check the temperature of them before consumption. Especially contents of feeding bottles and baby food jars.

How the Microwave Function Works

Microwaves are a form of energy similar to radio and television waves and ordinary daylight. Normally, microwaves spread outwards as they travel through the atmosphere and disappear without effect. This ovens, however, have a magnetron which is designed to make use of the energy in microwaves. Electricity, supplied to the magnetron tube, is used to created microwave energy.

These microwaves enter the cooking area through openings inside the oven. A turntable or tray is located at the bottom of the oven. Microwaves cannot pass through metal walls of the oven, but they can penetrate such materials as glass, porcelain and paper, the materials out of which microwave-safe cooking dishes are constructed.

Microwaves do not heat cookware, though cooking vessels will eventually get hot from the heat generated by the food.

A very safe appliance

Your oven, SolarDOM, is one of the safest of all home appliances. When the door is opened, the oven automatically stops producing microwaves. Microwave energy is converted completely to heat when it enters food, leaving no “left over” energy to harm you when you eat your food.

Precautions _____	2
Contents _____	3
Unpacking & Installing _____	4 ~ 5
Control Panel _____	6
Setting the Clock _____	7
Child Lock _____	8
Convection Cooking _____	9
Speed Combi Cooking _____	10 ~ 12
Speed Auto Cooking _____	13 ~ 17
Defrost _____	18 ~ 19
Grill Cooking _____	20
Micro Power Cooking _____	21
Micro Power Level _____	22
Two Stage Cooking _____	23
Favorite Cook _____	24 ~ 25
Quick Start _____	26
More/Less Cooking _____	27
Important safety instructions _____	28 ~ 29
Microwave - safe Utensils _____	30
Food characteristics & Microwave cooking _____	31 ~ 32
Questions & Answers _____	33
Plug Wiring Information/Technical Specifications _____	34

Unpacking & Installing

By following the basic steps on these two pages you will be able to quickly check that your oven is operating correctly. Please pay particular attention to the guidance on where to install your oven. When unpacking your oven make sure you remove all accessories and packing. Check to make sure that your oven has not been damaged during delivery.

- 1** Unpack your oven and place it on a flat level surface.

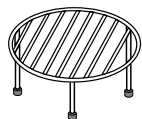
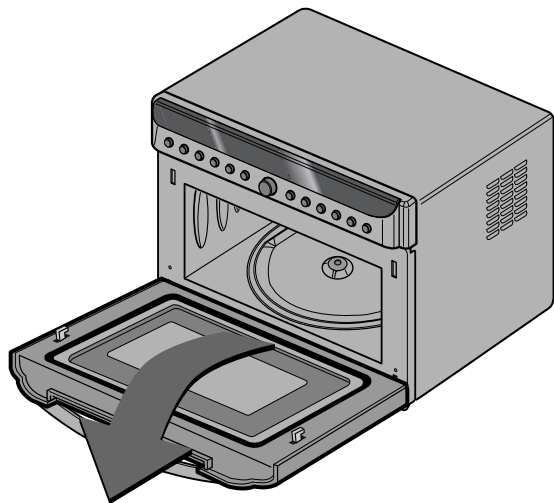

HIGH RACK
(For grill mode)

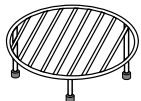

LOW RACK
(For microwave and convection mode)

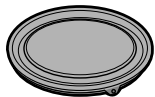

METAL TRAY
(For defrost)

- 2** Place the oven in the level location of your choice with more than 85cm height but make sure there is at least 20cm of space on the top and 10cm at the rear for proper ventilation. The front of the oven should be at least min. 8cm/max. 22cm from the edge of the surface to prevent tipping. An exhaust outlet is located on bottom or side of the oven. Blocking the outlet can damage the oven.

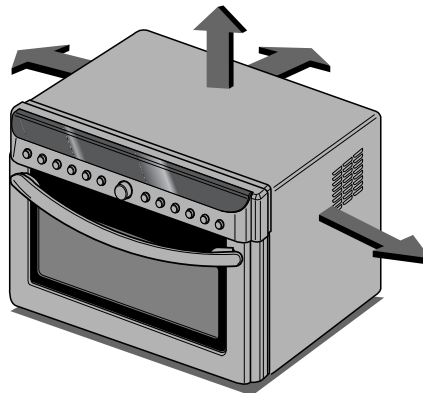

- * THIS OVEN SHOULD NOT BE USED FOR COMMERCIAL CATERING PURPOSES.
- * THIS OVEN CAN BE USED AS BUILT-IN TYPE .
- * MUST USE THE BUILT-IN KIT THAT IS MADE BY LG ELECTRONICS.

3 Plug your oven into a standard household socket. Make sure your oven is the only appliance connected to the socket. **If your oven does not operate properly, unplug it from the electrical socket and then plug it back in.**

4 Open your oven door by pulling the **DOOR HANDLE**. Place the **METAL TRAY** inside the oven.

5 Fill a **microwave safe container** with 300 ml (1/2 pint) of water. Place on the **METAL TRAY** and close the oven door. If you have any doubts about what type of container to use please refer to page 30.

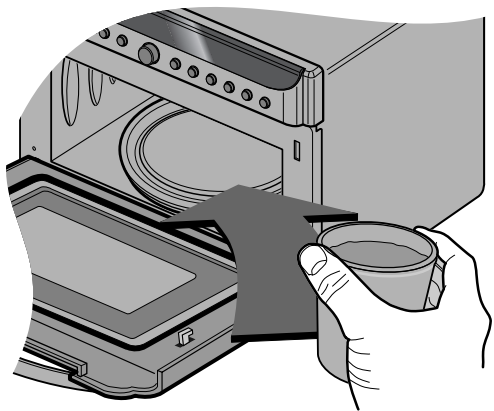

6 Press the **Stop/Clear** button, and press the **Start/Quick Start** button six times to set 30 seconds of cooking time.



7 The **DISPLAY** will count down from 30 seconds. When it reaches 0, it will sound BEEPS. Open the oven door and test the temperature of the water. If your oven is operating, the water should be warm. **Be careful when removing the container, it may be hot.**



YOUR OVEN IS NOW INSTALLED

8 The contents of feeding bottles and baby food jars shall be stirred or shaken and the temperature checked before consumption, in order to avoid burns.

Control Panel

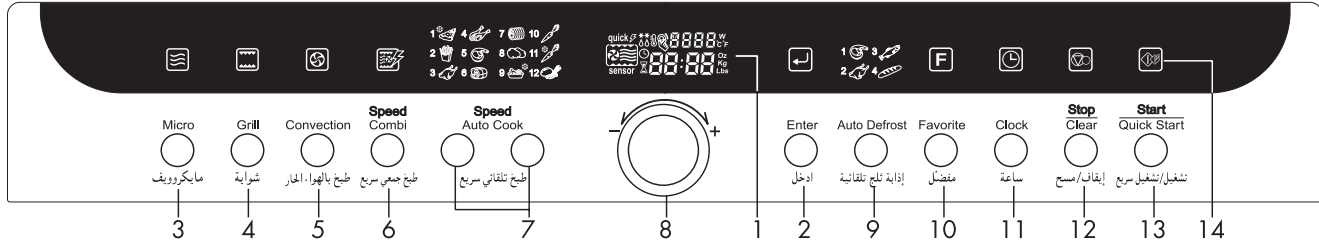

- 1. Display Window:** You can show time of day, cooking time, power level and cooking categories.
- 2. Enter:** You can determine the selected cooking category, microwave power level or temperature.
- 3. Micro:** You can select five power level settings.
- 4. Grill:** You can select the grill categories.
- 5. Conv.:** You can select temperature and time of convection.
- 6. Speed Combi:** You can select the combination categories.
- 7. Speed Auto Cook:** Speed auto cook allows you to cook most of your favorite food quickly by selecting the food type and the weight of the food.
- 8. Dial Knob:**
 - You can set cooking times, temperature, weight and cooking categories.
 - While cooking with auto and manual function, you can lengthen or shorten the cooking time at any point by turning the dial knob(except defrost mode).
- 9. Auto Defrost:** You can select the food type and the weight of the food.

- 10. Favorite:** The cooking program can be stored in the memory of your oven up to 9 modes(FA-1~FA-9).
- 11. Clock:** You can set the time of day.
- 12. Stop/Clear:** You can stop over and clear all entries except time of day.
 - Press Stop/Clear Button one time, all icons will be displayed on window in time of day or clear mode.
 - Press Stop/Clear Button one more time, all icons will be disappeared.
- 13. Start/Quick Start:**
 - In order to start cooking which is selected, press button one time.
 - The quick start feature allows you to set 30 seconds intervals of HIGH power cooking with a touch of the quick start button.
- 14. Icon:** You can see all icons by pressing "Stop/Clear" button one time and remove all icons by pressing one more time(all icons will disappear automatically after 15 seconds). Blink will guide to next step for setting while cooking, the icon of the selected cooking mode will be displayed on window.

Setting the Clock

You can set either 12 hour clock or 24 hour clock.

In the following example I will show you how to set the time for 14:35 when using the 24 clock.

Make sure that you have removed all packaging from your oven.



NOTE: Information Blink

For mode setting, blink will guide to next step.

When your oven is plugged in for the first time or when power resumes after a power cut, a '0' will be shown in the display; you will have to reset the clock.

If the clock (or display) shows any strange looking symbols, unplug your oven from the electrical socket and plug it back in and reset the clock.

Make sure that you have correctly installed your oven as described earlier in this book.

Press **Stop/Clear**.

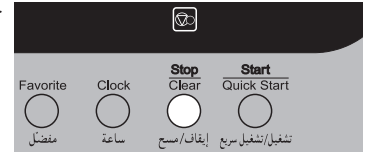

Press **Clock** once.

(If you want to use a 12 hour clock, Press **Clock** once more. If you want to change different option after setting clock, you have to unplug and plug it back in.)



Turn **Dial** knob until display shows "14:00".

Press **Enter** for hour confirmation

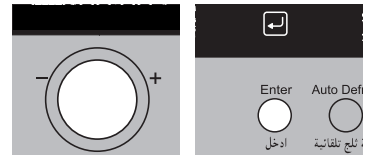

Turn **Dial** knob until display shows "14:35".

Press **Enter**.

The clock starts counting.

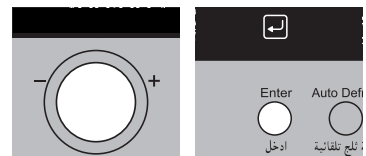

Child Lock



Your oven has a safety feature that prevents accidental running of the oven. Once the child lock is set, you will be unable to use any functions and no cooking can take place. However your child can still open the oven door.

Press **Stop/Clear**.

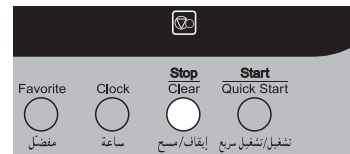

Press and hold **Stop/Clear** until “L” appears on the display and BEEP sounds.

The **CHILD LOCK** is now set.

The time will disappear on the display but will reappear on the display a few seconds later.



If any button is pressed, “L” will appear on the display



To cancel **CHILD LOCK** press and hold **Stop/Clear** until “L” disappears. You will hear BEEP when it's released.

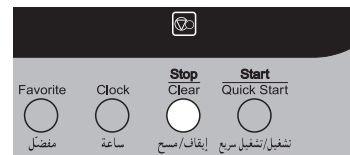

Convection Cooking

In the following example I will show you how to preheat the oven first, then cook some food at a temperature of 220 °C for 50 minutes.

The convection oven has a temperature range of 40°C and 100°C~250°C

The oven has a ferment function at the oven temperature of 40°C. You should wait until the oven is cool because you cannot use a ferment function if the oven temperature is over 40°C.

It is available to extend the cooking time up to 9 hours in the condition of 40°C at convection function for the operating mwo.

Your oven will take a few minutes to reach the selected temperature.

Once it has reached correct temperature, your oven will BEEP to let you know that it has reached the correct temperature. Then place your food in your oven: then tell your oven to start cooking.

The low rack must be used during convection cooking.



1. To Preheat

Press **Stop/Clear**.



2. To Cook

Press **Stop/Clear**.

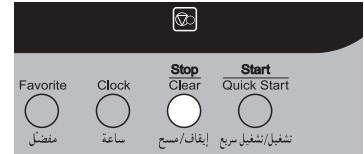

Press **Conv.** to select convection mode.



Press **Conv.** to select convection mode.



Turn **Dial** knob until display shows "220°C".

Turn **Dial** knob until display shows "220°C".



Press **Enter** for temp. confirmation.

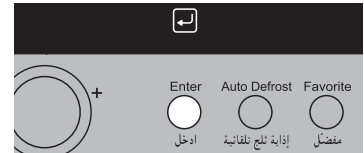

Turn **Dial** knob until display shows "50:00".



Press **Start**.
Display shows "Pr-H".



Press **Start**.
After cooking you must wear gloves and container to take metal tray out oven, because metal tray is very hot.



Speed combi

Cooking

In the following example I will show you how to programme your oven with micro power 360W and grill for a cooking time of 25 minutes.



Speed Combi
(Co-1, 2, 3)

Your oven has a combination cooking feature which allows you to cook food with **heater** and **microwave** at the same time or alternately. This generally means it takes less time to cook your food.

You can set three kinds of micro power level (180W, 360W and 600W) in speed combi mode.

* Speed combi Category

- | | | |
|-------------|----------|--|
| Co-1 | 1 | Grill-1 + Microwave power |
| Co-2 | 2 | Grill-2 + Microwave power |
| Co-3 | 3 | Grill-3 + Microwave power |
| Co-4 | 4 | (Upper + Lower heater) + Microwave power |
| Co-5 | 5 | Convection + Microwave power |

* Grill mode: Refer to page 20

Press **Stop/Clear**.

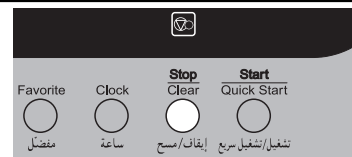

Press **Speed Combi** to select grill combination mode (Co-1, 2, 3).

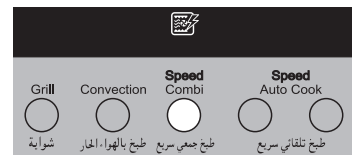

Turn **Dial** knob until display shows "Co-1".



Press **Enter** for grill-1 confirmation.

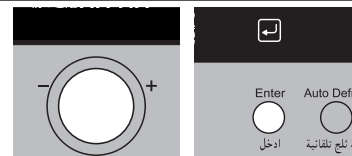

Turn **Dial** knob until display shows "360W".



Press **Enter** for power confirmation.

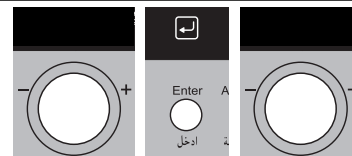

Turn **Dial** knob until display shows "25:00".

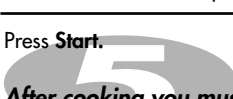

Press **Start**.

After cooking you must wear gloves and container to take metal tray out oven, because metal tray is very hot.



Speed combi Cooking

In the following example I will show you how to programme your oven with micro power 360W and at a temperature 200°C for a cooking time of 25 minutes.



Speed Combi (Co-4)

You can set four kinds of micro power level(0W, 180W, 360W, 600W) in speed combi mode(Co-4).

* Speed Combi Category

Co-1	1	Grill-1 + Microwave power
Co-2	2	Grill-2 + Microwave power
Co-3	3	Grill-3 + Microwave power
Co-4	4	(Upper + Lower heater) + Microwave power
Co-5	5	Convection + Microwave power

Press **Stop/Clear**.

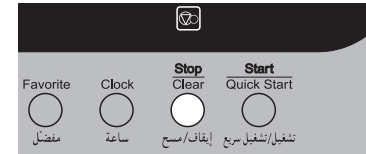

Press **Speed Combi** to select speed combination mode(Co-4).

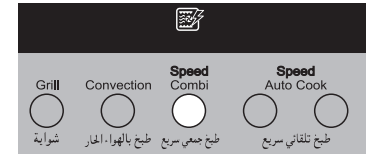

Turn **Dial** knob until display shows "Co-4".

Press **Enter** for speed combi confirmation.

Turn **Dial** knob until display shows "200°C".

Press **Enter** for temp. confirmation.

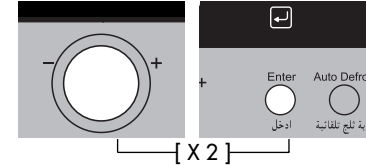

Turn **Dial** knob until display shows "360W".

Press **Enter** for power confirmation.

Turn **Dial** knob until display shows "25:00".

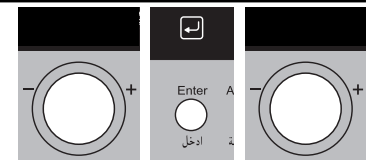

Press **Start**.



After cooking you must wear gloves and container to take metal tray out oven, because metal tray is very hot.



Speed combi Cooking

In the following example I will show you how to programme your oven with:- micro power 360W and at a convection temperature 200 °C for a cooking time of 25 minutes.



Speed Combi (Co-5)

Your oven has a combination cooking feature which allows you to cook food with **convection temp.** and **microwave** at the same time or alternately. This generally means it takes less time to cook your food.

You can set three kinds of micro power level(180W, 360W, 600W) in speed combi mode(Co-5).

* Speed Combi Category

- Co-1** **1** Grill-1 + Microwave power
- Co-2** **2** Grill-2 + Microwave power
- Co-3** **3** Grill-3 + Microwave power
- Co-4** **4** (Upper + Lower heater) + Microwave power
- Co-5** **5** Convection + Microwave power

Press **Stop/Clear**.

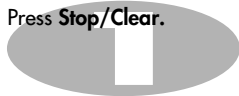

Press **Speed Combi** to select convection combination mode.

Turn **Dial** knob until display shows "Co-5".

Press **Enter** for convection confirmation.

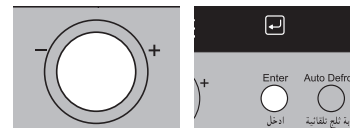
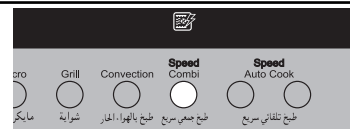

Turn **Dial** knob until display shows "200°C".

Press **Enter** for temp. confirmation.

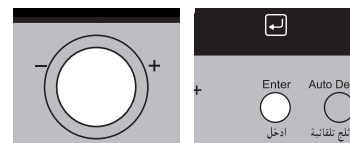

Turn **Dial** knob until display shows "360W".

Press **Enter** for power confirmation.

Turn **Dial** knob until display shows "25:00".

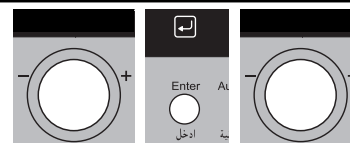

Press **Start**.

When cooking you can turn DIAL to increase or decrease cooking time.

After cooking you must wear gloves and container to take metal tray out oven, because metal tray is very hot.



Speed Auto Cooking

In the following example I will show you how to cook 0.4kg of frozen pizza(SC 1).



Speed auto cook menus are programmed.
Speed auto cook allows you to cook most of your favorite food quickly by selecting the food type and the weight of the food.

Press **Stop/Clear**.

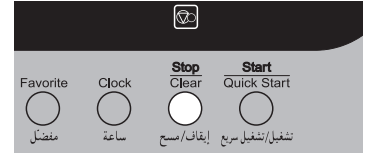

Press **Speed Auto Cook**.

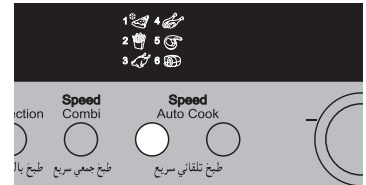

Turn **Dial** knob until display shows "SC 1".

Press **Enter** for category(frozen pizza) confirmation.

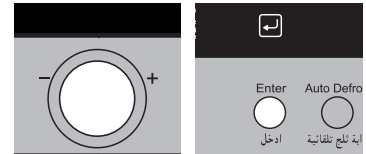

Turn **Dial** knob until display shows "0.40kg".

Press **Start**.

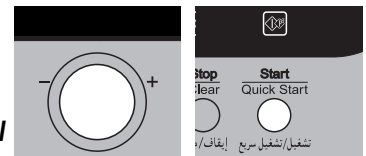

After cooking you must wear gloves and container to take metal tray out oven, because metal tray is very hot.

Speed Auto Cooking

In the following example I will show you how to cook 0.6kg of jacket potatoes(SC 8).



SPEED AUTO COOK allows you to cook most of your favorite food quickly by selecting the food type and the weight of the food.

Press **Stop/Clear**.



Press **Speed Auto Cook**.

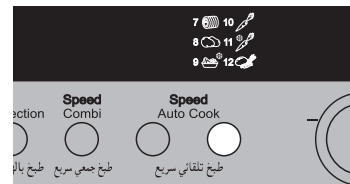

Turn **Dial** knob until display shows "SC 8".



Press **Enter** for category confirmation.

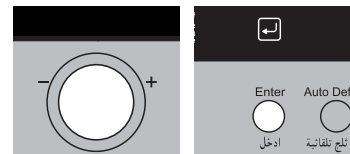

Turn **Dial** knob until display shows "0.60kg".



Press **Start**.



After cooking you must wear gloves and container to take metal tray out oven, because metal tray is very hot.

SPEED AUTO COOK GUIDE

Function	Category		Weight Limit	Utensil	Food Temp.	Instructions
Speed auto cook	SC 1	Frozen pizza	0.30~0.50kg	Metal tray	Frozen	This function is for cooking frozen pizza. Remove all package and place on the metal tray. After cooking, stand for 1~2 minutes.
	SC 2	French Fries	0.20~0.75kg	Metal tray	Frozen	Spread frozen potato products out on the metal tray. For the best results, cook in a single layer. After cooking, remove from the oven and stand for 1~2 minutes.
	SC 3	Whole Chicken	0.80~1.80kg	Low rack + Metal tray	Refrigerated	Brush whole chicken with melted margarine, butter or seasonings, if desired. Place the whole chicken breast-side down in an uncovered dish on the low rack on metal tray. When BEEP, drain the juices and turn food over immediately. After cooking, let stand covered with foil for 10 minutes.
	SC 4	Chicken Pieces	0.20~0.80kg	Metal tray	Refrigerated	Place the chicken pieces on the metal tray. When BEEP, turn food over. And then press start to continue cooking. After cooking, stand covered with foil for 2-5 minutes.
	SC 5	Beef Steaks	0.30~1.20kg	Low rack + Metal tray	Refrigerated	Place on the low rack. When BEEP, turn food over. And then press start to continue cooking. After cooking, serve immediately.
	SC 6	Roast Lamb	0.80~1.80kg	Low rack + Metal tray	Refrigerated	Trim excess fat from lamb. Brush the lamb with melted margarine or butter. Place on the low rack on the metal tray. When BEEP, turn food over. And then press start to continue cooking. After cooking, stand covered with foil for 10 minutes.

SPEED AUTO COOK GUIDE

Function	Category		Weight Limit	Utensil	Food Temp.	Instructions
Speed auto cook	SC 7	Roast Beef	0.80~1.80kg	Low rack + Metal tray	Refrigerated	Brush the beef with melted margarine or butter. Place on the low rack on the metal tray. When BEEP, turn food over. And then press start to continue cooking. After cooking, stand covered with foil for 10 minutes.
	SC 8	Jacket Potatoes	0.20~1.00kg	Metal tray	Room	Choose medium sized potatoes. (200 -220g per each) Wash and dry potatoes. Pierce the potatoes several times with a fork. Place the potatoes on the metal tray. Adjust weight and press start. After cooking, remove the potatoes from the oven. Let stand covered with foil for 5 minutes.
	SC 9	Frozen Dinners	0.40~1.00kg	Low rack + Metal tray	Frozen	Place frozen dinner uncovered on low rack.
	SC 10	Fresh Vegetables	0.20~1.00kg	Low rack + Microwave-safe bowl with cover	Room	Place vegetables in a microwave-safe bowl. Add water. Cover with wrap. When BEEP, stir once. After cooking, stir and allow to stand for 2 - 3 minutes. Add amount of water according to the quantity. ** 0.2kg - 0.5kg : 2 Tablespoons ** 0.55kg - 1.0kg : 4 Tablespoons
	SC 11	Frozen Vegetables	0.20~1.00kg	Low rack + Metal tray + Microwave-safe bowl with cover	Frozen	Place vegetables in a microwave-safe bowl. Add water. Cover with wrap. When BEEP, stir once. After cooking, stir and allow to stand for 2 - 3 minutes. Add amount of water according to the quantity. ** 0.2kg - 0.5kg : 2 Tablespoons ** 0.55kg - 1.0kg : 4 Tablespoons

SPEED AUTO COOK GUIDE

Function	Category		Weight Limit	Utensil	Food Temp.	Instructions											
Speed auto cook	SC 12	Rice / Pasta	0.10~0.30kg	Low rack + Metal tray + Microwave-safe bowl with cover	Room	Place rice and boiling water with 1/4 to 1 teaspoon salt in a deep and large bowl(3L). When BEEP, stir once.											
						<table border="1"> <thead> <tr> <th colspan="2">Weight</th> <th>100g</th> <th>200g</th> <th>300g</th> <th>Cover</th> </tr> </thead> <tbody> <tr> <td rowspan="2">Water</td> <td>Rice</td> <td>250ml</td> <td>350ml</td> <td>480ml</td> <td>Yes</td> </tr> <tr> <td>Pasta</td> <td>300ml</td> <td>600ml</td> <td>900ml</td> <td>No</td> </tr> </tbody> </table>	Weight		100g	200g	300g	Cover	Water	Rice	250ml	350ml	480ml
Weight		100g	200g	300g	Cover												
Water	Rice	250ml	350ml	480ml	Yes												
	Pasta	300ml	600ml	900ml	No												
						** Rice - After cooking, stand covered for 5 minutes or until water is absorbed.											
						** Pasta - During the cooking, stir several times if required. After cooking, stand 1-2 minutes. Rinse pasta with cold water.											

< Metal Tray >

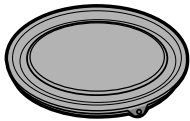

< Low Rack + Metal Tray >







Auto Defrost

* When defrosting, use metal tray only.



Your oven has four microwave defrost settings:- **MEAT, POULTRY, FISH** and **BREAD**; each defrost category has different power settings. Repeated presses of the **Defrost** button will select a different setting.

Category	Defrost No.
MEAT	dEF1 
POULTRY	dEF2 
FISH	dEF3 
BREAD	dEF4 

The temperature and density of food varies, I would recommend that the food is checked before cooking commences. Pay particular attention to large joints of meat and chicken, some foods should not be completely thawed before cooking. For example fish cooks so quickly that it is sometimes better to begin cooking while still slightly frozen. The BREAD programme is suitable for defrosting small items such as rolls or a small loaf. These will require a standing time to allow the centre to thaw. In the following example I will show you how to defrost 1.4Kg of frozen poultry.

Press **Stop/Clear**.

Weight the food that you are about to defrost. Be certain to remove any metallic ties or wraps; then place the food on microwave safe dish on metal tray in your oven and close the oven door.

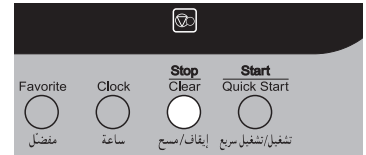

Press **Auto Defrost** once.

Turn **Dial** knob until display shows "dEF2".



Press **Enter** for category(poultry) confirmation.

Enter the weight of the frozen food that you are about to defrost.

Turn **Dial** knob until display shows "1.4kg" for the weight of frozen food.



Press **Start**.

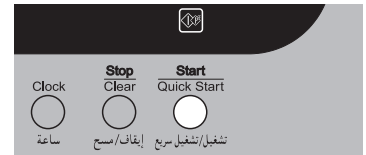

During defrosting your oven will "BEEP", at which point open the oven door, turn food over and separate to ensure even thawing. Remove any portions that have thawed or shield them to help slow down thawing. After checking, close the oven door and press **Start** to resume defrosting.

Your oven will not stop defrosting (even when the beep sounded) unless the door is opened.

DEFROSTING GUIDE

- * Food to be defrosted should be in a suitable microwave proof container and place uncovered on the metal tray.
- * If necessary, shield small areas of meat or poultry with flat pieces of aluminum foil. This will prevent thin areas becoming warm during defrosting. Ensure the foil does not touch the oven walls.
- * Separate items like minced meat, chops, sausages and bacon as soon as possible.
When BEEP, turn food over. Remove defrosted portions. Continue to defrost remaining pieces.
 After defrosting, allow to stand until completely thawed.
- * For example joints of meat and whole chickens should STAND for a minimum of 1 hour before cooking.

<i>Category</i>	<i>Weight Limit</i>	<i>Utensil</i>	<i>Food</i>
Meat (DEF1)	0.1 ~ 4.0 kg	Metal tray	Meat Minced beef, Fillet steak, Cubes for stew, Sirloin steak, Pot roast, Rump roast, Beef burger Pork chops, Lamb chops, Rolled roast, Sausage, Cutlets(2cm) Turn food over at beep. After defrosting, let stand for 5-15 minutes.
Poultry (DEF2)			Poultry Whole chicken, Legs, Breasts, Turkey breasts(under 2.0kg) Turn food over at beep. After defrosting, let stand for 20-30 minutes.
Fish (DEF3)			Fish Fillets, Steaks, Whole fish, Sea foods Turn food over at beep. After defrosting, let stand for 10-20 minutes.
Bread (DEF4)			0.1 ~ 0.5 kg

Grill Cooking

In the following example I will show you how to use the Grill-1 to cook some food for 12 minutes and 30 seconds.



This feature will allow you to brown and crisp food quickly.

The grill rack is placed on the metal tray at the grill mode.

The high rack must be used during grill cooking.



Press **Stop/Clear**.



Press **Grill** to select grill mode.



Turn **Dial** knob until display shows "gr-1".

Press **Enter** for grill confirmation.

Category	Display	Heater Operating
Grill-1	gr-1	Upper Heater(2000W)
Grill-2	gr-2	Upper Heater(1100W)
Grill-3	gr-3	Lower Heater(700W)

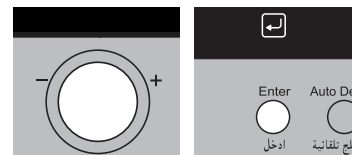

Turn **Dial** knob until display shows "12:30".

Press **Start**.



After cooking you must wear gloves and container to take metal tray out oven, because metal tray is very hot.

Microwave Power Cooking

In the following example I will show you how to cook some food on 600W power for 5 minutes and 30 seconds.



Your oven has five microwave Power settings. High power is automatically selected and turning of dial will select a different power level.

POWER	
HIGH	900 W
MEDIUM HIGH	600 W
MEDIUM	360 W
DEFROST MEDIUM LOW	180 W
LOW	90 W

Make sure that you have correctly installed your oven as described earlier in this book.

Press **Stop/Clear**.

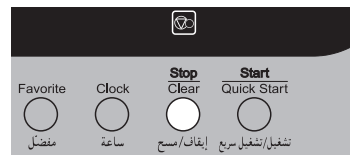

Press **Microwave** once to select microwave mode.

Turn **Dial** knob until display shows "600W".

Press **Enter** for power confirmation.

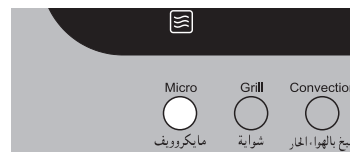

Turn **Dial** knob until display shows "5:30".

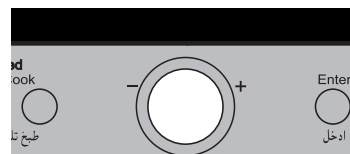

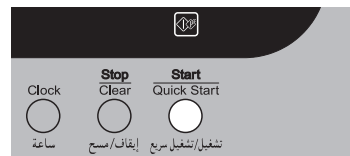

Press **Start**.

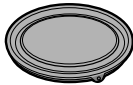

Micro Power Level

This oven is equipped with 5 power levels to give you maximum flexibility and control over cooking. The table below shows the examples of food and their recommended cooking power levels for use with this oven.

POWER LEVEL	OUTPUT	USE	ACCESSORY
HIGH	900W	<ul style="list-style-type: none"> * Boil Water * Brown minced beef * Cook poultry pieces, fish, vegetables * Cook tender cuts of meat 	Low Rack + Metal Tray 
MEDIUM HIGH	600W	<ul style="list-style-type: none"> * All reheating * Roast meat and poultry * Cook mushrooms and shellfish * Cook foods containing cheese and eggs 	
MEDIUM	360W	<ul style="list-style-type: none"> * Bake cakes and scones * Prepare eggs * Cook custard * Prepare rice, soup 	
DEFROST/ MEDIUM LOW	180W	<ul style="list-style-type: none"> * All thawing * Melt butter and chocolate * Cook less tender cuts of meat 	Metal Tray 
LOW	90W	<ul style="list-style-type: none"> * Soften butter & cheese * Soften ice cream * Raise yeast dough 	Low Rack + Metal Tray 



Two stage Cooking

In the following example I will show you how to cook some food in two stages. The first stages will cook your food for 11 minutes on HIGH(900W); the second will cook for 35 minutes on 360W.



During two stage cooking the oven door can be opened and food checked. Close the oven door and press **Start** and the cooking stage will continue.

At the end of stage1 , BEEP sounds and stage 2 commences.

Should you wish to clear the programme press **Stop/Clear** twice.

Press **Stop/Clear** .

Set the power and the cooking time for **stage 1**.

Press **Micro** once to select microwave mode.

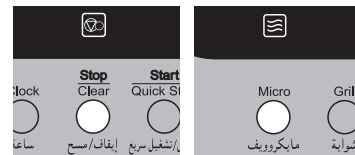

Turn **Dial** knob until display shows "900W".

Press **Enter** for power confirmation.

Turn **Dial** knob until display shows "11:00".

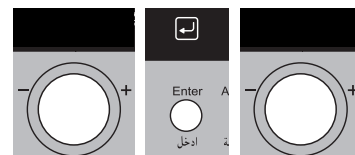

Set the power and the cooking time for **stage2**.

Press **Micro** once to select microwave mode.



Turn **Dial** knob until display shows "360W".

Press **Enter** for power confirmation.

Turn **Dial** knob until display shows "35:00".

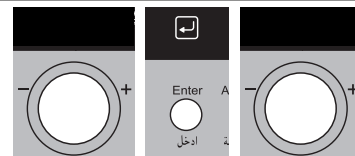

Press **Start**.



Favorite Cook

This feature allows you to set and execute a frequently used single stage programme. Once the cooking programme is set, you can use it by pressing the favorite cook key. In the following example I will show you how to set the cooking programme for 10 minutes 30 seconds on 600W power.



1. To Set

The cooking programme can be stored in the memory of your oven. If you wish to change your FAVORITE COOK, simply enter a new cooking programme.

You can store up to 9 mode. (FA-1~FA-9)

Press **Stop/Clear**.

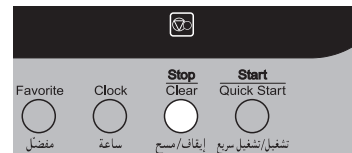

Press **Favorite** button, FA-1 appears on the display.

Press **Micro**.

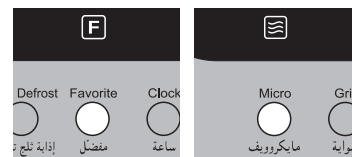

Turn **Dial** knob until display shows "600W"

Press **Enter**.



Turn **Dial** knob until display shows "10:30"

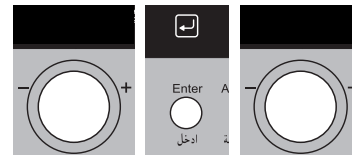

Press **Favorite**.

(Press **Start**, the cooking programme will be stored in the memory of your oven and cooking start)

Successfully finished setting the favorite cook.

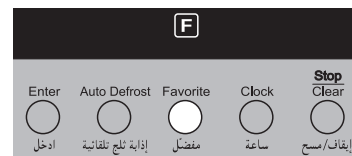

Favorite Cook



2. To Cook

When you cook, use it by pressing the favorite button.
Press **Favorite** until display shows "FA-1".

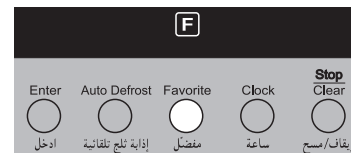

Press **Start**.



3. To replace programme (if any cooking is programmed at FA-1)

Press **Favorite** button, FA-1 and cooking data appears on the display.

Press one of **Function** buttons you want to programme.
Set a new cooking programme.

Press **Favorite**.

(Press **Start**, the cooking programme will be stored in the memory of your oven and cooking start)

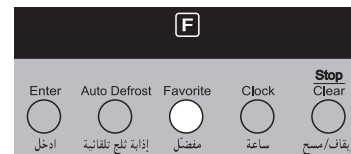

Quick Start

In the following example I will show you how to set 2 minutes of cooking on high power(900W).



The **Quick Start** feature allows you to set 30 seconds intervals of HIGH power(900W) cooking with pressing of the **Quick Start** button.

Press **Stop/Clear**.

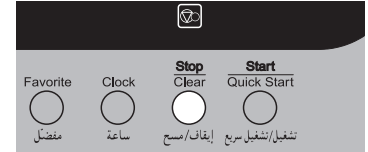

Press **Quick Start** four times to select 2 minutes on HIGH power(900W). Your oven will start before you have finished the fourth press.

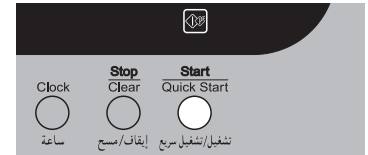

During **Quick Start** cooking, you can extend the cooking time up to 99 minutes 59 seconds by repeatedly pressing the **Quick Start** button.



More or Less Cooking

In the following example I will show you how to change the preset SPEED AUTO COOK programmes for a longer or shorter cooking time.



If you find that your food is over or undercooked when using the SPEED AUTO COOK programme, you can increase or decrease cooking time by turning the DIAL knob.

You can lengthen or shorten the cooking time(except defrost mode) at any point by turning the DIAL knob.

Cooking time	Increases or Decrease time
0~3 min.	10 Sec.
3~20 min.	30 Sec.
20~30 min.	1 Min.
30~90 min.	5 Min.

Press **Stop/Clear**.

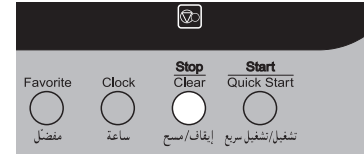

Set the required **SPEED AUTO COOK** programme.

Select weight of food.

Press **Start**.

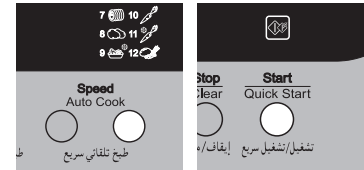

Turn **Dial** knob.

The cooking time will increase or decrease.

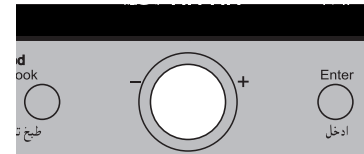

Important safety instructions

Read carefully and keep for future reference

WARNING

Please ensure cooking times are correctly set as over cooking may result in FIRE and subsequent DAMAGE to the OVEN.

- 1 Do not attempt to tamper with, or make any adjustments or repairs to the door, control panel, safety interlock switches or any other part of the oven. It is hazardous for anyone to carry out any service or repair operation which involves the removal of any cover which gives protection against exposure to microwave energy. Repairs should only be undertaken by a qualified service technician.
- 2 Do not operate the oven when empty. It is best to leave a glass of water in the oven when not in use. The water will safely absorb all microwave energy, if the oven is accidentally started.
- 3 Do not use the oven for the purpose of dehumidification. It can be the cause of serious damage of safety. (ex. Operating the microwave oven with the wet newspapers, clothes, toys, pet or portable electric devices, etc.)
- 4 Do not cook food wrapped in paper towels, unless your cook book contains instructions, for the food you are cooking.
- 5 Do not use newspaper in place of paper towels for cooking.
- 6 Do not use wooden containers. They may heat-up and char. Do not use ceramic containers which have metallic (e.g. gold or silver) inlays. Always remove metal twist ties. Metal objects in the oven may arc, which can cause serious damage.
- 7 Do not operate the oven with a kitchen towel, a napkin or any other obstruction between the door and the front edges of the oven, which may cause microwave energy leakage.
- 8 Do not use recycled paper products since they may contain impurities which may cause sparks and/or fires when used in cooking.
- 9 After cooking you must wear gloves and container to take metal tray out oven, because metal tray is very hot.
- 10 Small amounts of food require shorter cooking or heating time. If normal times are allowed they may overheat and burn.
- 11 Be certain to place the oven so the front of the door is min. 8 cm/max. 22 cm or more behind the edge of the surface on which it is placed, to avoid accidental tipping of the appliance.
- 12 Before cooking, pierce the skin of potatoes, apples or any such fruit or vegetable.
- 13 Do not cook eggs in their shell. Pressure will build up inside the egg which will burst.
- 14 Do not attempt deep fat frying in your oven.
- 15 Remove the plastic wrapping from food before cooking or defrosting. Note though that in some cases food should be covered with plastic film, for heating or cooking.
- 16 If the oven door or door seals are damaged, the oven must not be operated until it has been repaired by a qualified service technician.
- 17 If smoke is observed, switch off or disconnect the oven from the power supply and keep the oven door closed in order to stifle any flames.
- 18 When food is heated or cooked in disposable containers of plastic, paper or other combustible materials, check the oven frequently due to the possibility of ignition.
- 19 Only allow children to use the oven without supervision when adequate instructions have been given so that the child is able to use the oven in a safe way and understands the hazards of improper use.
- 20 Liquids or other foods must not be heated in sealed containers since they are liable to explode.
- 21 After the cook is finished, if the oven is hot the oven is cooling down by the operation of fans.

Important safety instructions

Read carefully and keep for future reference

- 22 Only use utensils that are suitable for use in microwave ovens.
- 23 When heating food in plastic or paper containers, keep an eye on the oven due to the possibility of ignition.
- 24 If smoke is observed, switch off or unplug the appliance and keep the door closed in order to stifle any flames.
- 25 Microwave heating of beverages can result in delayed eruptive boiling, therefore care must be taken when handling the container.
- 26 The contents of feeding bottles and baby food jars shall be stirred or shaken and the temperature checked before consumption, in order to avoid burns.
- 27 Eggs in their shell and whole hard-boiled eggs should not be heated in microwave ovens since they may explode, even after microwave heating has ended.
- 28 Details for cleaning door seals, cavities and adjacent parts.
- 29 The oven should be cleaned regularly and any food deposits removed.
- 30 Failure to maintain the oven in a clean condition could lead to deterioration of the surface that could adversely affect the life of the appliance and possibly result in a hazardous situation.
- 31 Only use the temperature probe recommended for this oven (for appliances having a facility to use a temperature-sensing probe).
- 32 If heating elements are provided, during use the appliance becomes hot. Care should be taken to avoid touching heating elements inside the oven.
- 33 The appliance is not intended for use by young children or infirm persons without supervision.

- 34 The microwave oven must be operated with the decorative door open.
- 35 This connection may be achieved by having the plug accessible or by incorporation a switch in the fixed wiring in accordance with the wiring rules.
- 36 Do not use harsh abrasive cleaners or sharp metal scrapers to clean the oven door glass since they can scratch the surface, which may result in shattering of the glass.

⚠ WARNING: If the door or door seals are damaged, the oven must not be operated until it has been repaired by a competent person.

⚠ WARNING: It is hazardous for anyone other than a competent person to carry out any service or repair operation that involves the removal of a cover which gives protection against exposure to microwave energy.

⚠ WARNING: Liquids and other foods must not be heated in sealed containers since they are liable to explode.

⚠ WARNING: Only allow children to use the oven without supervision when adequate instructions have been given so that the child is able to use the oven in a safe way and understands the hazards of improper use.

⚠ WARNING: Accessible parts may become hot during use. Young children should be kept away.

Microwave-safe Utensils

Never use metal or metal trimmed utensils in using microwave function

Microwaves cannot penetrate metal. They will bounce off any metal object in the oven and cause arcing, an alarming phenomenon that resembles lightning. Most heat resistant non metallic cooking utensils are safe for use in your oven. However, some may contain materials that render them unsuitable as microwave cookware. If you have any doubts about a particular utensil, there's a simple way to find out if it can be used in using microwave function.

Place the utensil in question next to a glass bowl filled with water in using microwave function. Microwave at power HIGH for 1 minute. If the water heats up but the utensil remains cool to the touch, the utensil is microwave-safe. However, if the water does not change temperature but the utensil becomes warm, microwaves are being absorbed by the utensil and it is not safe for use in using microwave function. You probably have many items on hand in your kitchen right now that can be used as cooking equipment in using microwave function. Just read through the following checklist.

Dinner plates

Many kinds of dinner-ware are microwave-safe. If in doubt consult the manufacturer's literature or perform the microwave test.

Glassware

Glassware that is heat-resistant is microwave-safe. This would include all brands of oven tempered glass cookware. However, do not use delicate glassware, such as tumblers or wine glasses, as these might shatter as the food warms.

Plastic storage containers

These can be used to hold foods that are to be quickly reheated. However, they should not be used to hold foods that will need considerable time in the oven as hot foods will eventually warp or melt plastic containers.

Paper

Paper plates and containers are convenient and safe to use in using microwave function, provided that the cooking time is short and foods to be cooked are low in fat and moisture. Paper towels are also very useful for wrapping foods and for lining baking trays in which greasy foods such as bacon are cooked. In general, avoid coloured paper products as the colour may run. Some recycled paper products may contain impurities which could cause arcing or fires when used in using microwave function.

Plastic cooking bags

Provided they are made specially for cooking, cooking bags are microwave safe. However, be sure to make a slit in the bag so that steam can escape. Never use ordinary plastic bags for cooking in using microwave function, as they will melt and rupture.

Plastic microwave cookware

A variety of shapes and sizes of microwave cookware are available. For the most part, you can probably use items you already have on hand rather than investing in new kitchen equipment.

Pottery, stoneware and ceramic

Containers made of these materials are usually fine for use in using microwave function, but they should be tested to be sure.

⚠ CAUTION

Some items with high lead or iron content are not suitable for cooking utensils.

Utensils should be checked to ensure that they are suitable for use in using microwave function.

Food characteristics & Microwave cooking

Keeping an eye on things

The recipes in the book have been formulated with great care, but your success in preparing them depends on how much attention you pay to the food as it cooks. Always watch your food while it cooks. Your microwave function is equipped with a light that turns on automatically when the oven is in operation so that you can see inside and check the progress of your food. Directions given in recipes to elevate, stir, and the like should be thought of as the minimum steps recommended. If the food seems to be cooking unevenly, simply make the necessary adjustments you think appropriate to correct the problem.

Factors affecting microwave cooking times

Many factors affect cooking times. The temperature of ingredients used in a recipe makes a big difference in cooking times. For example, a cake made with ice-cold butter, milk, and eggs will take considerably longer to bake than one made with ingredients that are at room temperature. All of the recipes in this book give a range of cooking times. In general, you will find that the food remains undercooked at the lower end of the time range, and you may sometimes want to cook your food beyond the maximum time given, according to personal preference. The governing philosophy of this book is that it is best for a recipe to be conservative in giving cooking times. While overcooked food is ruined for good. Some of the recipes, particularly those for bread, cake, and custards, recommend that food be removed from the oven when they are slightly undercooked. This is not a mistake. When allowed to stand, usually covered, these foods will continue to cook outside of the oven as the heat trapped within the outer portions of the food gradually travels inward. If the food is left in the oven until it is cooked all the way through, the outer portions will become overcooked or even burnt. You will become increasingly skilful in estimating both cooking and standing times for various foods.

Density of food

Light, porous food such as cakes and breads cook more quickly than heavy, dense foods such as roasts and casseroles. You must take care when microwaving porous food that the outer edges do not become dry and brittle.

Height of food

The upper portion of tall food, particularly roasts, will cook more quickly than the lower portion. Therefore, it is wise to turn tall food during cooking, sometimes several times.

Moisture content of food

Since the heat generated from microwaves tends to evaporate moisture, relatively dry food such as roasts and some vegetables should either be sprinkled with water prior to cooking or covered to retain moisture.

Bone and fat content of food

Bones conduct heat and fat cooks more quickly than meat. Care must be taken when cooking bony or fatty cuts of meat that they do not cook unevenly and do not become overcooked.

Quantity of food

The number of microwaves in your oven remains constant regardless of how much food is being cooked. Therefore, the more food you place in the oven, the longer the cooking time. Remember to decrease cooking times by at least one third when halving a recipe.

Shape of food

Microwaves penetrate only about 2 cm into food, the interior portion of thick foods are cooked as the heat generated on the outside travels inward. Only the outer edge of food is cooked by microwave energy; the rest is cooked by conduction. The worst possible shape for a food that is to be microwaved is a thick square. The corners will burn long before the centre is even warm. Round thin foods and ring shaped foods cook successfully in the microwave.

Covering

A cover traps heat and steam which causes food to cook more quickly. Use a lid or microwave cling film with a corner folded back to prevent spitting.

Browning

Meats and poultry that are cooked fifteen minutes or longer will brown lightly in their own fat. Food that are cooked for a shorter period of time may be brushed with a browning sauce such as worcestershire sauce, soy sauce or barbecue sauce to achieve an appetizing colour. Since relatively small amounts of browning sauces are added to food the original flavour of the recipe is not altered.

Covering with greaseproof paper

Greaseproofing effectively prevents spattering and helps food retain some heat. But because it makes a looser cover than a lid or clingfilm, it allows the food to dry out slightly.

Arranging and spacing

Individual foods such as baked potatoes, small cakes and hors d'oeuvres will heat more evenly if placed in the oven an equal distance apart, preferably in a circular pattern. Never stack foods on top of one another.

Food characteristics & Microwave cooking

Stirring

Stirring is one of the most important of all microwaving techniques. In conventional cooking, food is stirred for the purpose of blending. Microwaved food, however, is stirred in order to spread and redistribute heat. Always stir from the outside towards the centre as the outside of the food heats first.

Turning over

Large, tall foods such as roasts and whole chickens should be turned so that the top and bottom will cook evenly. It is also a good idea to turn cut up chicken and chops.

Placing thicker portions facing outwards

Since microwaves are attracted to the outside portion of food, it makes sense to place thicker portions of meat, poultry and fish to the outer edge of the baking dish. This way, thicker portions will receive the most microwave energy and the food will cook evenly.

Shielding

Strips of aluminium foil (which block microwaves) can be placed over the corners or edges of square and rectangular foods to prevent those portions from overcooking. Never use too much foil and make sure the foil is secured to the dish or it may cause 'arcing' in the oven.

Elevating

Thick or dense foods can be elevated so that microwaves can be absorbed by the underside and centre of the foods.

Piercing

Foods enclosed in a shell, skin or membrane are likely to burst in the oven unless they are pierced prior to cooking. Such foods include yolks and whites of eggs, clams and oysters and whole vegetables and fruits.

Testing if cooked

Food cooks so quickly in a oven, it is necessary to test it frequently. Some foods are left in the microwave until completely cooked, but most foods, including meats and poultry, are removed from the oven while still slightly undercooked and allowed to finish cooking during standing time. The internal temperature of foods will rise between 5°F (3°C) and 15°F (8°C) during standing time.

Standing time

Foods are often allowed to stand for 3 to 10 minutes after being removed from the oven. Usually the foods are covered during standing time to retain heat unless they are supposed to be dry in texture (some cakes and biscuits, for example). Standing allows foods to finish cooking and also helps flavour blend and develop.

To Clean Your Oven

1 Keep the inside of the oven clean

Food spatters or spilled liquids stick to oven walls and between seal and door surface. It is best to wipe up spillovers with a damp cloth right away. Crumbs and spillovers will absorb microwave energy and lengthen cooking times. Use a damp cloth to wipe out crumbs that fall between the door and the frame. It is important to keep this area clean to assure a tight seal. Remove greasy spatters with a soapy cloth then rinse and dry. Do not use harsh detergent or abrasive cleaners. The metal tray can be washed by hand or in the dishwasher.

2 Keep the outside of the oven clean

Clean the outside of your oven with soap and water then with clean water and dry with a soft cloth or paper towel. To prevent damage to the operating parts inside the oven, the water should not be allowed to seep into the ventilation openings. To clean control panel, open the door to prevent oven from accidentally starting, and wipe a damp cloth followed immediately by a dry cloth. Press Stop/Clear after cleaning.

- 3 If steam accumulates inside or around the outside of the oven door, wipe the panels with a soft cloth. This may occur when the oven is operated under high humidity conditions and in no way indicates a malfunction of the unit.
- 4 The door and door seals should be kept clean. Use only warm, soapy water, rinse then dry thoroughly.
DO NOT USE ABRASIVE MATERIALS, SUCH AS CLEANING POWDERS OR STEEL AND PLASTIC PADS.
Metal parts will be easier to maintain if wiped frequently with a damp cloth.
- 5 Do not use any steam cleaner.

Questions & Answers

Q What's wrong when the oven light will not glow?

- A There may be several reasons why the oven light will not glow.
Light bulb has blown
Relay is failed

Q Does microwave energy pass through the viewing screen in the door?

- A No. The holes, or ports, are made to allow light to pass; they do not let microwave energy through.

Q Why does the beep tone sound when a button on the Control Panel is touched?

- A The beep tone sounds to assure that the setting is being properly entered.

Q Will the microwave function be damaged if it operates empty?

- A Yes Never run it empty or without the metal tray.

Q Why do eggs sometimes pop?

- A When baking, frying, or poaching eggs, the yolk may pop due to steam build up inside the yolk membrane. To prevent this, simply pierce the yolk before cooking. Never microwave eggs in the shell.

Q Why is standing time recommended after microwave cooking is over?

- A After microwave cooking is finished, food keeps on cooking during standing time. This standing time finishes cooking evenly throughout the food. The amount of standing time depends on the density of the food.

Q Is it possible to cook popcorn in this oven?

- A Yes, if using one of the two methods described below
1 Popcorn-popping utensils designed specifically for microwave cooking.
2 Prepackaged commercial microwave popcorn that contains specific times and power outputs needed for an acceptable final product.

FOLLOW EXACT DIRECTIONS GIVEN BY EACH MANUFACTURER FOR THEIR POPCORN PRODUCT. DO NOT LEAVE THE OVEN UNATTENDED WHILE THE CORN IS BEING POPPED. IF CORN FAILS TO POP AFTER THE SUGGESTED TIMES, DISCONTINUE COOKING. OVERCOOKING COULD RESULT IN THE CORN CATCHING FIRE.

CAUTION

NEVER USE A BROWN PAPER BAG FOR POPPING CORN. NEVER ATTEMPT TO POP LEFTOVER KERNELS.

Q Why doesn't my oven always cook as fast as the cooking guide says?

- A Check your cooking guide again to make sure you've followed directions correctly, and to see what might cause variations in cooking time. Cooking guide times and heat settings are suggestions, chosen to help prevent overcooking, the most common problem in getting used to a this oven. Variations in the size, shape, weight and dimensions of the food require longer cooking time. Use your own judgement along with the cooking guide suggestions to test food condition, just as you would do with a conventional cooker.

Plug wiring information/ Technical Specifications

⚠ WARNING

This appliance must be earthed

The wires in this mains lead are colored in accordance with the following codes
 BLUE ~ Neutral
 BROWN ~ Live
 GREEN & YELLOW ~ Earth

As the colours of the wires in the mains lead of this appliance may not correspond with the coloured markings identifying the terminals in your plug proceed as follows:

The wire which is colored BLUE must be connected to the terminal which is marked with the letter N or Colored BLACK.

The wire which is colored BROWN must be connected to the terminal which is marked with the letter L or colored RED.

The wire which is colored GREEN & YELLOW or GREEN must be connected to the terminal which is marked with the letter E or .

If the supply cord is damaged, it must be replaced by the manufacturer or its service agent or a similarly qualified person in order to avoid a hazard;

Technical Specification

		MP-9482S
Power Input		230 V~ 50 Hz
Output		900 W (IEC60705 rating standard)
Microwave Frequency		2450 MHz
Outside Dimension		527 mm(W) X 392mm(H) X 480 mm(D)
Power	Microwave	1650 watt
	Grill	max. 2100 watt
Consumption	Combination	max. 2800 watt
	Convection	1900 watt