



LIGHT OVEN "SolarDOM"

OWNER'S MANUAL

PLEASE READ THIS OWNER'S MANUAL THOROUGHLY BEFORE OPERATING.



MP-9482SR

P/No: 3828W5A4528

Precautions

Precautions to avoid possible exposure to excessive microwave energy.

You cannot operate your oven with the door open due to the safety interlocks built into the door mechanism. These safety interlocks automatically switch off any cooking activity when the door is opened; which in the operation of microwave function could result in harmful exposure to microwave energy. **It is important not to tamper with the safety interlocks.**

Do not place any object between the oven front face and the door or allow food or cleaner residue to accumulate on sealing surfaces.

Do not operate your oven if it was damaged. It is particularly important that the oven door closes properly and that there is no damage to the: (1) door(bent), (2) hinges and latches (broken or loosened), (3) door seals and sealing surfaces.

Your oven should not be adjusted or repaired by anyone except qualified service personnel.

Warning

Please ensure cooking times are correctly set as over cooking may result in the FOOD catching fire and subsequent damage to your oven.

When heating liquids, e.g. soups, sauces and beverages in your oven with microwave function, delayed eruptive boiling can occur without evidence of bubbling. This could result in a sudden boil over of the hot liquid. To prevent this possibility the following steps should be taken:

- 1 Avoid using straight sided containers with narrow necks.
- 2 Do not overheat.
- 3 Stir the liquid before placing the container in the oven and again halfway through the heating time.
- 4 After heating, allow to stand in the oven for a short time, stir or shake them(especially the contents of feeding bottles and baby food jars) again carefully and check the temperature of them before consumption to avoid burns (especially, contents of feeding bottles and baby food jars). Be careful when handling the container.

Warning

Always allow food to stand after being cooked by waves and check the temperature of them before consumption. Especially contents of feeding bottles and baby food jars.

How the Microwave Function Works

Microwaves are a form of energy similar to radio and television waves and ordinary daylight. Normally, microwaves spread outwards as they travel through the atmosphere and disappear without effect. This oven, however, has a magnetron which is designed to make use of the energy in microwaves. Electricity, supplied to the magnetron tube, is used to create microwave energy.

These microwaves enter the cooking area through openings inside the oven. A turntable or tray is located at the bottom of the oven. Microwaves cannot pass through metal walls of the oven, but they can penetrate such materials as glass, porcelain and paper, the materials out of which microwave-safe cooking dishes are constructed.

Microwaves do not heat cookware, though cooking vessels will eventually get hot from the heat generated by the food.

A very safe appliance

Your oven, SolarDOM, is one of the safest of all home appliances. When the door is opened, the oven automatically stops producing microwaves. Microwave energy is converted completely to heat when it enters food, leaving no "left over" energy to harm you when you eat your food.

Precautions	2
Contents	3
Unpacking & Installing	4 ~ 5
Control Panel	6
Setting the Clock	7
Child Lock	8
Convection Cooking	9
Speed Combi Cooking	10 ~ 12
Speed Auto Cooking	13 ~ 19
Auto Defrost	20 ~ 21
Grill Cooking	22
Micro Power Cooking	23
Micro Power Level	24
Two Stage Cooking	25
Favorite Cook	26 ~ 27
Quick Start	28
More or Less Cooking	29
Rotisserie Installation & Cooking	30 ~ 33
Rotisserie Assembly	34
Important safety instructions	
Read carefully and keep for future reference	35 ~ 36
Microwave - safe Utensils	37
Food characteristics & Microwave cooking	38 ~ 39
Questions & Answers	40
Plug Wiring Information/Technical Specifications	41

Unpacking & Installing

By following the basic steps on these two pages you will be able to quickly check that your oven is operating correctly. Please pay particular attention to the guidance on where to install your oven. When unpacking your oven make sure you remove all accessories and packing. Check to make sure that your oven has not been damaged during delivery.

1 Unpack your oven and place it on a flat level surface.

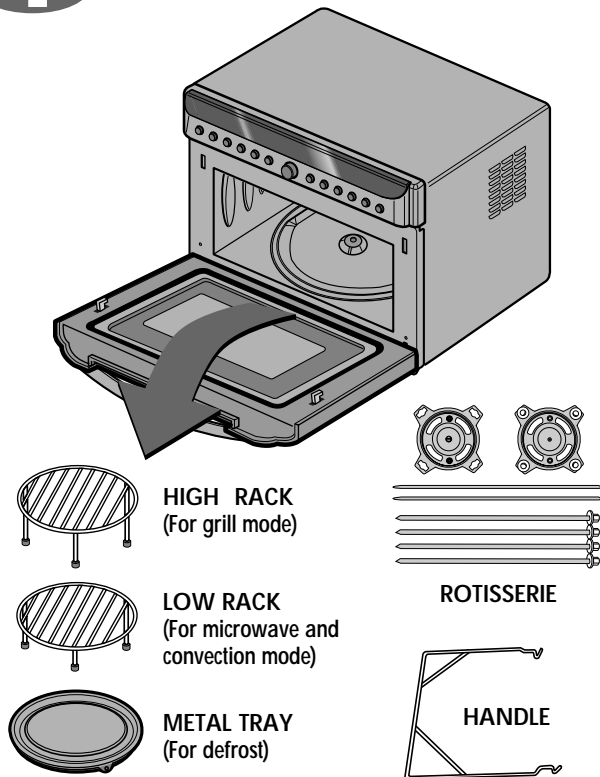

2 Place the oven in the level location of your choice with more than 85cm height but make sure there is at least 20cm of space on the top and 10cm at the rear for proper ventilation. The front of the oven should be at least min. 8cm/max. 22cm from the edge of the surface to prevent tipping. An exhaust outlet is located on bottom or side of the oven. Blocking the outlet can damage the oven.

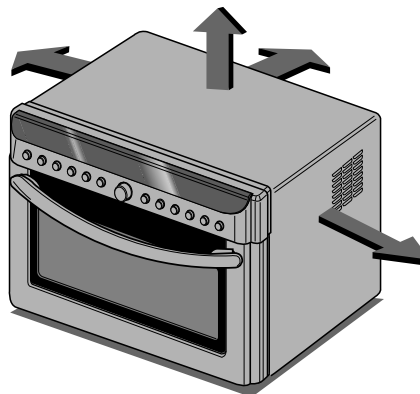

- * THIS OVEN SHOULD NOT BE USED FOR COMMERCIAL CATERING PURPOSES.
- * THIS OVEN CAN BE USED AS BUILT-IN TYPE .
- * MUST USE THE BUILT-IN KIT THAT IS MADE BY LG ELECTRONICS.

3 Plug your oven into a standard household socket. Make sure your oven is the only appliance connected to the socket. **If your oven does not operate properly, unplug it from the electrical socket and then plug it back in.**

4 Open your oven door by pulling the **DOOR HANDLE**. Place the **METAL TRAY** inside the oven.

5 Fill a **microwave safe container** with 300 ml (1/2 pint) of water. Place on the **METAL TRAY** and close the oven door. If you have any doubts about what type of container to use please refer to page 37.

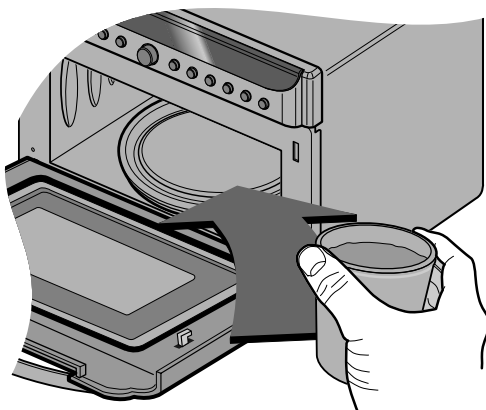

6 Press the **STOP/CLEAR** button, and press the **START** button one time to set 30 seconds of cooking time.



7 The **DISPLAY** will count down from 30 seconds. When it reaches 0 it will sound BEEPS. Open the oven door and test the temperature of the water. If your oven is operating the water should be warm. **Be careful when removing the container it may be hot.**

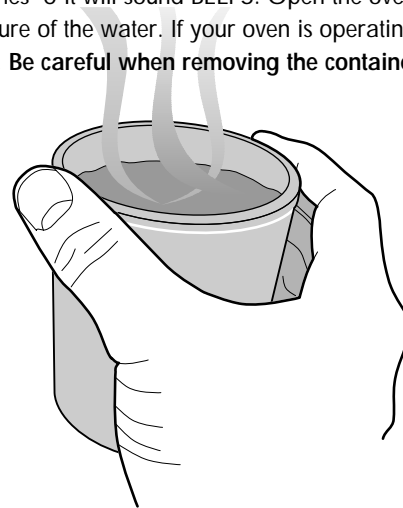

YOUR OVEN IS NOW INSTALLED

8 The contents of feeding bottles and baby food jars shall be stirred or shaken and the temperature checked before consumption, in order to avoid burns.

Control Panel

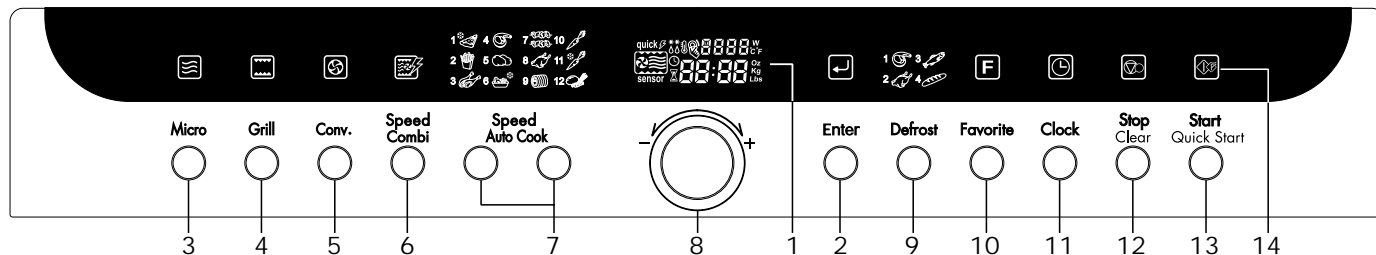

- 1. Display Window:** You can show time of day, cooking time, power level and cooking categories.
- 2. Enter:** You can determine the selected cooking category, microwave power level or temperature.
- 3. Micro:** You can select five power level settings.
- 4. Grill:** You can select the grill categories.
- 5. Conv.:** You can select temperature and time of convection.
- 6. Speed Combi:** You can select the combination categories.
- 7. Speed Auto Cook:** Speed auto cook allows you to cook most of your favorite food quickly by selecting the food type and the weight of the food.
- 8. Dial Knob:**
 - You can set cooking times, temperature, weight and cooking categories.
 - While cooking with auto and manual function, you can lengthen or shorten the cooking time at any point by turning the dial knob(except defrost mode).
- 9. Defrost:** You can select the food type and the weight of the food.
- 10. Favorite:** The cooking program can be stored in the memory of your oven up to 9 modes(FA-1~FA-9).
- 11. Clock:** You can set the time of day.
- 12. Stop/Clear:** You can stop over and clear all entries except time of day.
 - Press Stop/Clear Button one time, all icons will be displayed on window in time of day or clear mode.
 - Press Stop/Clear Button one more time, all icons will be disappeared.
- 13. Start/Quick Start:**
 - In order to start cooking which is selected, press button one time.
 - The quick start feature allows you to set 30 seconds intervals of HIGH power cooking with a touch of the quick start button.
- 14. Icon:** You can see all icons by pressing “Stop/Clear” button one time and remove all icons by pressing one more time(all icons will disappear automatically after 15 seconds).
Blink will guide to next step for setting while cooking, the icon of the selected cooking mode will be displayed on window.

Setting the Clock

You can set either 12 hour clock or 24 hour clock.

In the following example I will show you how to set the time for 14:35 when using the 24 clock.

Make sure that you have removed all packaging from your oven.



NOTE: Information Blink

For mode setting, blink will guide to next step.

When your oven is plugged in for the first time or when power resumes after a power cut, a '0' will be shown in the display; you will have to reset the clock.

If the clock (or display) shows any strange looking symbols, unplug your oven from the electrical socket and plug it back in and reset the clock.

Make sure that you have correctly installed your oven as described earlier in this book.

Press **Stop/Clear**.

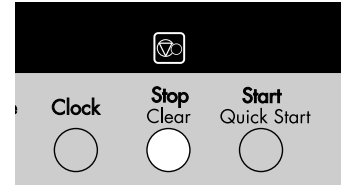

Press **Clock** once.

(If you want to use a 12 hour clock, Press **Clock** once more. If you want to change different option after setting clock, you have to unplug and plug it back in.)

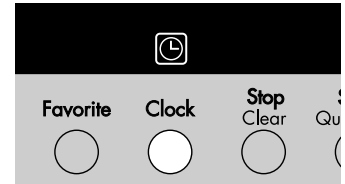

Turn **Dial** knob until display shows "14:00".

Press **Enter** for hour confirmation

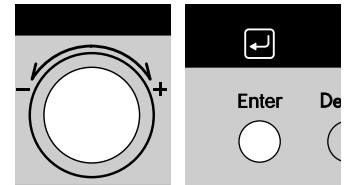

Turn **Dial** knob until display shows "14:35".

Press **Enter**.

The clock starts counting.

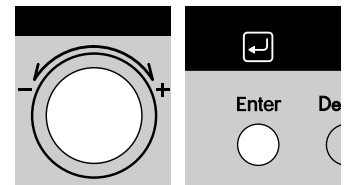

Child Lock



Your oven has a safety feature that prevents accidental running of the oven. Once the child lock is set, you will be unable to use any functions and no cooking can take place. However your child can still open the oven door.

Press **Stop/Clear**.

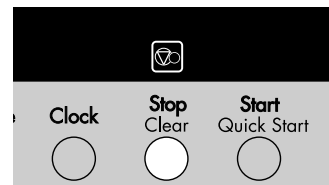

Press and hold **Stop/Clear** until "L" appears on the display and BEEP sounds.

The **CHILD LOCK** is now set.

The time will disappear on the display but will reappear on the display a few seconds later.

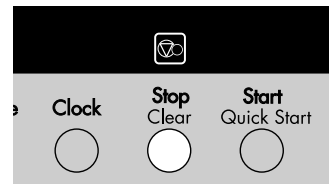

If any button is pressed, "L" will appear on the display

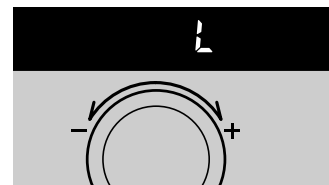
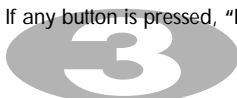

To cancel **CHILD LOCK** press and hold **Stop/Clear** until "L" disappears. You will hear BEEP when it's released.

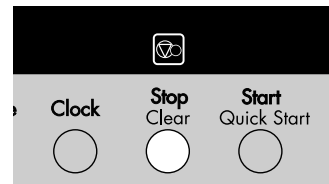

Convection Cooking

In the following example I will show you how to use the convection to cook some food for 50 minutes for 220°C temp.

The convection oven has a temperature range of 40°C and 100°C~250°C

The oven has a ferment function at the oven temperature of 40°C. You should wait until the oven is cool because you cannot use a ferment function if the oven temperature is over 40°C.

It is available to extend the cooking time up to 9 hours in the condition of 40°C at convection function for the operating mwo.

Your oven will take a few minutes to reach the selected temperature.

Once it has reached correct temperature, your oven will BEEP to let you know that it has reached the correct temperature. Then place your food in your oven: then tell your oven to start cooking.

The low rack must be used during convection cooking.



1. To Preheat

Press **Stop/Clear**.



2. To Cook

Press **Stop/Clear**.

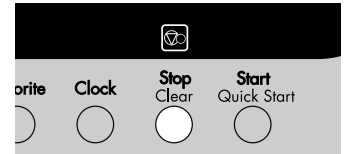

Press **Conv.** to select convection mode.

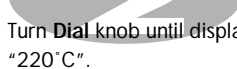

Press **Conv.** to select convection mode.

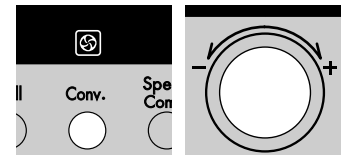

Turn **Dial** knob until display shows "220°C".

Turn **Dial** knob until display shows "220°C".

Press **Enter** for temp. confirmation.

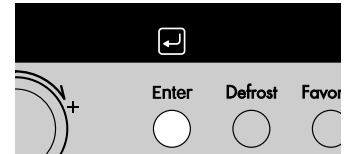

Turn **Dial** knob until display shows "50:00".

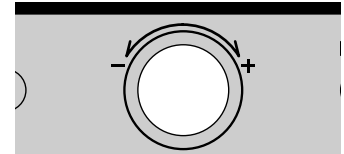

Press **Start**.
Display shows "Pr-H".



Press **Start**.
After cooking you must wear gloves and container to take metal tray out oven, because metal tray is very hot.

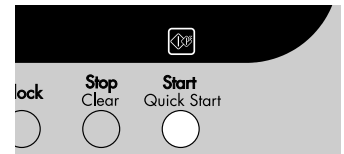
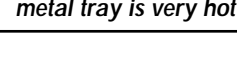

Speed combi

Cooking

In the following example I will show you how to programme your oven with micro power 360W and grill for a cooking time of 25 minutes.



Speed Combi
(Co-1, 2, 3)

Your oven has a combination cooking feature which allows you to cook food with heater and microwave at the same time or alternately. This generally means it takes less time to cook your food.

You can set three kinds of micro power level(180W, 360W and 600W) in speed combi mode.

* Speed combi Category

- | | | |
|------|----------|------------------------------------------|
| Co-1 | 1 | Grill-1 + Microwave power |
| Co-2 | 2 | Grill-2 + Microwave power |
| Co-3 | 3 | Grill-3 + Microwave power |
| Co-4 | 4 | (Upper + Lower heater) + Microwave power |
| Co-5 | 5 | Convection + Microwave power |

* Grill mode: Refer to page 22

Press **Stop/Clear**.

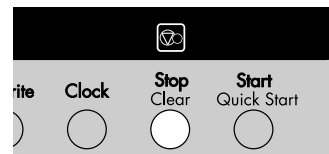

Press **Speed Combi** to select grill combination mode(Co-1, 2, 3).

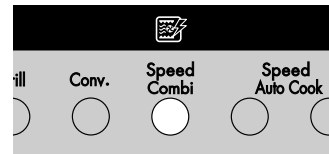

Turn **Dial knob** until display shows "Co-1".

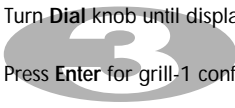

Press **Enter** for grill-1 confirmation.

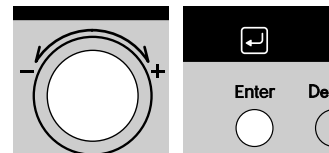

Turn **Dial knob** until display shows "360W".

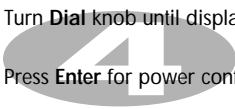

Press **Enter** for power confirmation.

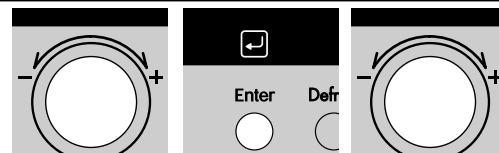

Turn **Dial knob** until display shows "25:00".

Press **Start**.

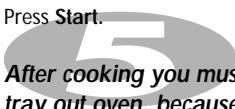

After cooking you must wear gloves and container to take metal tray out oven, because metal tray is very hot.

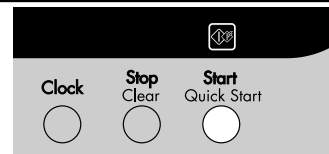

Speed combi

Cooking

In the following example I will show you how to programme your oven with micro power 360W and at a temperature 200°C for a cooking time of 25 minutes.



Speed Combi (Co-4)

You can set four kinds of micro power level(0W, 180W, 360W, 600W) in speed combi mode(Co-4).

* Speed Combi Category

- | | | |
|------|----------|---------------------------------------------|
| Co-1 | 1 | Grill-1 + Microwave power |
| Co-2 | 2 | Grill-2 + Microwave power |
| Co-3 | 3 | Grill-3 + Microwave power |
| Co-4 | 4 | (Upper + Lower heater)
+ Microwave power |
| Co-5 | 5 | Convection + Microwave power |

Press **Stop/Clear**.

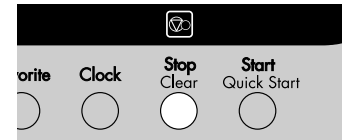

Press **Speed Combi** to select speed combination mode(Co-4).

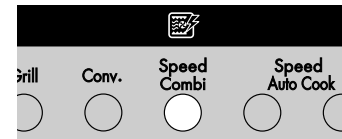

Turn **Dial** knob until display shows "Co-4".

Press **Enter** for speed combi confirmation.

Turn **Dial** knob until display shows "200°C".

Press **Enter** for temp. confirmation.

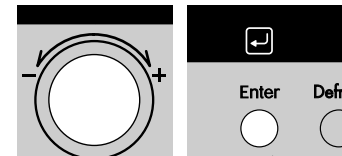

(X 2)

Turn **Dial** knob until display shows "360W".

Press **Enter** for power confirmation.

Turn **Dial** knob until display shows "25:00".

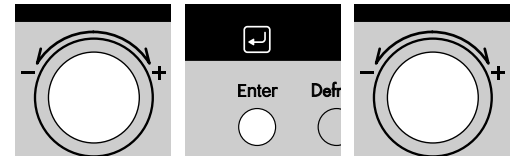

Press **Start**.



After cooking you must wear gloves and container to take metal tray out oven, because metal tray is very hot.

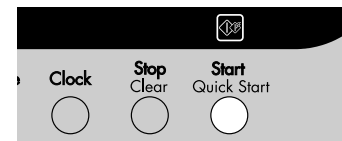

Speed combi

Cooking

In the following example I will show you how to programme your oven with:- micro power 360W and at a convection temperature 200 °C for a cooking time of 25 minutes.



Speed Combi
(Co-5)

Your oven has a combination cooking feature which allows you to cook food with **convection temp.** and **microwave** at the same time or alternately. This generally means it takes less time to cook your food.

You can set three kinds of micro power level(180W, 360W, 600W) in speed combi mode(Co-5).

* Speed Combi Category

- | | | |
|------|----------|------------------------------------------|
| Co-1 | 1 | Grill-1 + Microwave power |
| Co-2 | 2 | Grill-2 + Microwave power |
| Co-3 | 3 | Grill-3 + Microwave power |
| Co-4 | 4 | (Upper + Lower heater) + Microwave power |
| Co-5 | 5 | Convection + Microwave power |

Press **Stop/Clear**.

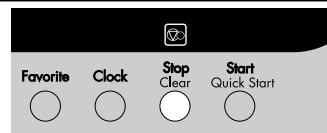

Press **Speed Combi** to select convection combination mode.

Turn **Dial** knob until display shows "Co-5".

Press **Enter** for convection confirmation.

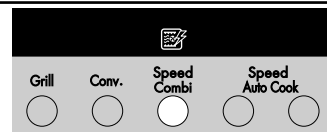
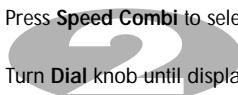

Turn **Dial** knob until display shows "200°C".

Press **Enter** for temp. confirmation.

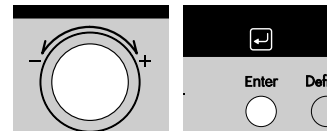
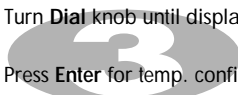

Turn **Dial** knob until display shows "360W".

Press **Enter** for power confirmation.

Turn **Dial** knob until display shows "25:00".

Press **Start**.

When cooking you can turn DIAL to increase or decrease cooking time.

After cooking you must wear gloves and container to take metal tray out oven, because metal tray is very hot.

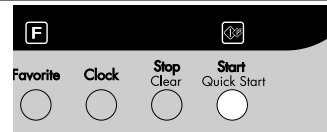
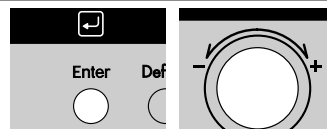
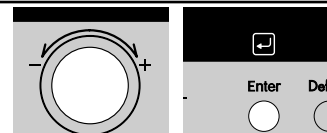
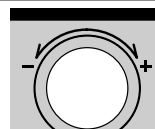
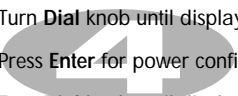

Speed Auto Cooking

In the following example I will show you how to cook 0.4kg of Frozen Pizza (SC 1).



Speed auto cook menus are programmed.
Speed auto cook allows you to cook most of your favorite food quickly by selecting the food type and the weight of the food.

* Speed auto cook Category

SC 1	1	Frozen Pizza
SC 2	2	French Fries
SC 3	3	Chicken Pieces
SC 4	4	Beef Steaks
SC 5	5	Jacket Potatoes
SC 6	6	Frozen Dinners

Press **Stop/Clear**.

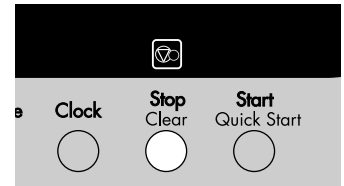

Press **Speed Auto Cook**.

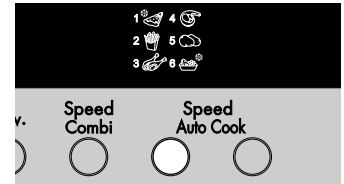

Turn **Dial** knob until display shows "SC 1".



Press **Enter** for category (Frozen Pizza) confirmation.

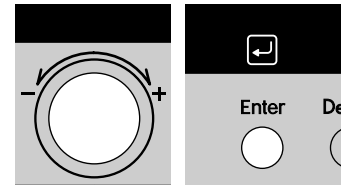

Turn **Dial** knob until display shows "0.40kg".



Press **Start**.

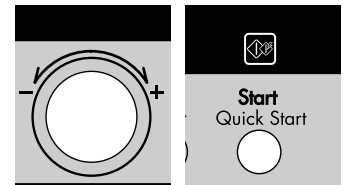

After cooking you must wear gloves and container to take metal tray out oven, because metal tray is very hot.

Speed Auto Cooking

In the following example I will show you how to cook 0.3kg of Fresh Vegetables (SC 10).



SPEED AUTO COOK allows you to cook most of your favorite food quickly by selecting the food type and the weight of the food.

* Speed auto cook Category

SC 7	7	Kebab
SC 8	8	Whole Chicken
SC 9	9	Roast Beef
SC 10	10	Fresh Vegetables
SC 11	11	Frozen Vegetables
SC 12	12	Rice/Pasta

Press **Stop/Clear**.

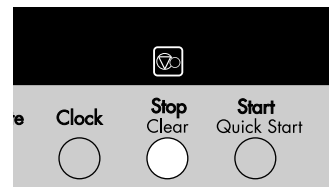

Press **Speed Auto Cook**.

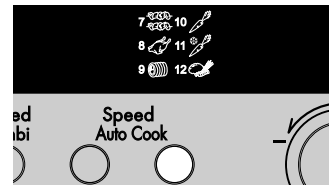

Turn **Dial** knob until display shows "SC 10".

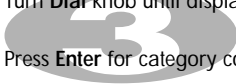

Press **Enter** for category confirmation.

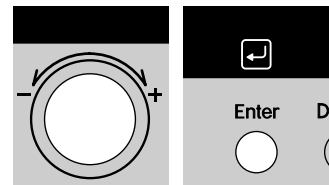

Turn **Dial** knob until display shows "0.30kg".

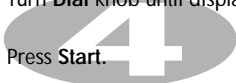

Press **Start**.

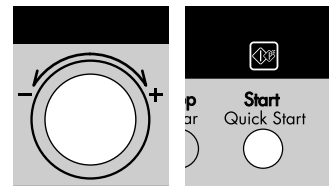

After cooking you must wear gloves and container to take metal tray out oven, because metal tray is very hot.

SPEED AUTO COOK GUIDE

Function	Category		Weight Limit	Utensil	Food Temp.	Instructions
Speed auto cook	SC 1	Frozen pizza	0.3~0.5kg	Metal tray	Frozen	This function is for cooking frozen pizza. Remove all package and place on the metal tray. After cooking, stand for 1~2 minutes.
	SC 2	French Fries	0.2~0.75kg	Metal tray	Frozen	Spread frozen potato products out on the metal tray. For the best results, cook in a single layer. After cooking, remove from the oven and stand for 1~2 minutes.
	SC 3	Chicken Pieces	0.2~0.8kg	Metal tray	Refrigerated	Place the chicken pieces on the metal tray. When the oven beeps, turn food over. And then press start to continue cooking. After cooking, stand covered with foil for 2-5 minutes.
	SC 4	Beef Steaks	0.3~1.2kg	Low rack + Metal tray	Refrigerated	New York Cut Steak 1/2 inch thick. Place on the low rack. When the oven beeps, turn food over. And then press start to continue cooking. After cooking, serve immediately.

Note: The cooking time may be adjusted by using the dial while the meal is cooking.

SPEED AUTO COOK GUIDE

<i>Function</i>	<i>Category</i>		<i>Weight Limit</i>	<i>Utensil</i>	<i>Food Temp.</i>	<i>Instructions</i>
Speed auto cook	SC 5	Jacket Potatoes	0.2~1.0kg	Metal tray	Room	Choose medium sized potatoes. (200 -220g per each) Wash and dry potatoes. Pierce the potatoes several times with a fork. Place the potatoes on the metal tray. Adjust weight and press start. After cooking, remove the potatoes from the oven. Let stand covered with foil for 5 minutes.
	SC 6	Frozen Dinners	0.4~1.0kg	Low rack + Metal tray	Frozen	REMOVE CARTON & PROTECTIVE FILM ON DINNER. (e.g. Lasagna, Macaroni and cheese, etc.) Place on the low rack. After cooking, remove from the oven and let stand for 1-2 minutes. Note: For the best result, the cooking time may be adjusted by using the dial while the meal is cooking.

Note: The cooking time may be adjusted by using the dial while the meal is cooking.

SPEED AUTO COOK GUIDE

Function	Category		Weight Limit	Utensil	Food Temp.	Instructions
Speed auto cook	SC 7	Kebab	0.2-0.8kg	Rotisserie +Metal tray	Refrigerated	Kebab Barg 600g Fillet on top round 1 Big onion 2 Spoonfuls of olive oil Salt 1. Cut the meat into the small and equal pieces. Grate the onion and separate its juice. Mix the onion juice and olive oil. Then cover the pieces of meat with the olive oil and onion juice for 3-4 hours. (You should add the salt after cooking the meat). 2. Fix the meat pieces into the skewers. Note that the skewers pass the meat center. Insert the bar into the Roti-holder over the metal tray in the oven. 3. After cooking, remove from the oven.
						Chicken Kebab 600g Pieces of chicken 1 Big onion 2 Spoonfuls olive oil 2 Spoonfuls saffron Salt 1. Cover the pieces of chicken with onion juice, saffron, salt and olive oil about 3-4 hours. 2. Fix the pieces of chicken upon the skewers. Note that the skewers pass the center of pieces. 3. Insert the bar into the roti-holder. 4. After cooking, remove from the oven. Regarding the weight of chicken or meat, the weight of ingredients will be changed.

Note: The cooking time may be adjusted by using the dial while the meal is cooking.

SPEED AUTO COOK GUIDE

Function	Category		Weight Limit	Utensil	Food Temp.	Instructions
Speed auto cook	SC 8	Whole chicken	0.8-1.5kg	Rotisserie +Metal tray	Refrigerated	<p>A complete chicken approx. 1.2kg (with skin) 2 Big onions 3 Spoonfuls of olive oil 3 Spoonfuls of saffron (Dissolved in water) Salt</p> <ol style="list-style-type: none"> Cover the chicken with the onion juice, saffron, salt and oil(or butter) for 1/2~1 hour. Pierce the chicken with the roti-bar. Note that the bar pass through the chicken completely. Tie its feet, wings and body with a cotton thread and insert the bar into the roti-holder over the metal tray in the oven. After cooking, remove from the oven. Stand covered with aluminium foil for 5 minutes before serving.
	SC 9	Roast Beef	0.8~1.8kg	Rotisserie +Metal tray	Refrigerated	<ol style="list-style-type: none"> Brush the beef with melted margarine or butter. Pierce the beef with the roti-bar. Note that the bar pass through the beef completely. Tie the beef with a cotton thread and insert the bar into the roti-holder over the metal tray in the oven. After cooking, remove from the oven. Stand covered with aluminium foil for 10 minutes before serving.
	SC 10	Fresh Vegetables	0.2~1.0kg	Low rack + Metal tray + Microwave-safe bowl with cover	Room	<p>Place vegetables in a microwave-safe bowl. Add water. Cover with wrap. When the oven beeps, stir once. After cooking, stir and allow to stand for 2 - 3 minutes. Add amount of water according to the quantity.</p> <p>** 0.2kg - 0.5kg : 2 Tablespoons ** 0.55kg - 1.0kg : 4 Tablespoons</p>

Note: The cooking time may be adjusted by using the dial while the meal is cooking.

SPEED AUTO COOK GUIDE

Function	Category		Weight Limit	Utensil	Food Temp.	Instructions																	
Speed auto cook	SC 11	Frozen Vegetables	0.2~1.0kg	Low rack + Metal tray + Microwave-safe bowl with cover	Frozen	Place vegetables in a microwave-safe bowl. Add water. Cover with wrap. When the oven beeps, stir once. After cooking, stir and allow to stand for 2 - 3 minutes. Add amount of water according to the quantity. ** 0.2kg - 0.5kg : 2 Tablespoons ** 0.55kg - 1.0kg : 4 Tablespoons																	
	SC 12	Rice / Pasta	0.1~0.3kg	Low rack + Metal tray + Microwave-safe bowl with cover	Rice/Pasta : Room Water : Boiling	Place rice/pasta into boiling water with $\frac{1}{4}$ to 1 teaspoon salt in a deep and large bowl(3L). When the oven beeps, stir once. <table border="1" data-bbox="833 439 1347 538"> <thead> <tr> <th colspan="2">Weight</th> <th>100g</th> <th>200g</th> <th>300g</th> <th>Cover</th> </tr> </thead> <tbody> <tr> <td>Boiling</td> <td>Rice</td> <td>280ml</td> <td>380ml</td> <td>500ml</td> <td>Yes</td> </tr> <tr> <td>Water</td> <td>Pasta</td> <td>400ml</td> <td>800ml</td> <td>1200ml</td> <td>No</td> </tr> </tbody> </table> ** Rice-After cooking, stir and let stand covered for 5 minutes or until water is absorbed. ** Pasta - After cooking, stand 1-2 minutes. Rinse pasta with cold water.	Weight		100g	200g	300g	Cover	Boiling	Rice	280ml	380ml	500ml	Yes	Water	Pasta	400ml	800ml	1200ml
Weight		100g	200g	300g	Cover																		
Boiling	Rice	280ml	380ml	500ml	Yes																		
Water	Pasta	400ml	800ml	1200ml	No																		

Note: The cooking time may be adjusted by using the dial while the meal is cooking.

< Metal Tray >



< Low Rack + Metal Tray >



< High Rack + Metal Tray >

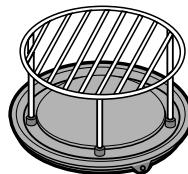

< Rotisserie >

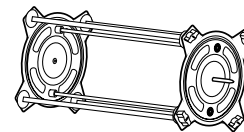





Auto Defrost

* When defrosting, use metal tray only.



Your oven has four microwave defrost settings:- **MEAT, POULTRY, FISH** and **BREAD**; each defrost category has different power settings. Repeated presses of the **Defrost** button will select a different setting.

Category	Defrost No.
MEAT	dEF1 
POULTRY	dEF2 
FISH	dEF3 
BREAD	dEF4 

Don't Use

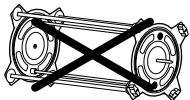

ROTISSERIE

The temperature and density of food vary, I would recommend that the food be checked before cooking commences. Pay particular attention to large joints of meat and chicken, some foods should not be completely thawed before cooking. For example fish is cooked so quickly that it is sometimes better to begin cooking while still slightly frozen. The BREAD programme is suitable for defrosting small items such as rolls or a small loaf. These will require a standing time to allow the centre to thaw. In the following example I will show you how to defrost 1.4kg of frozen poultry.

Press **Stop/Clear**.

Weigh the food that you are about to defrost. Be certain to remove any metallic ties or wraps; then place the food on microwave safe dish on the metal tray in your oven and close the oven door.

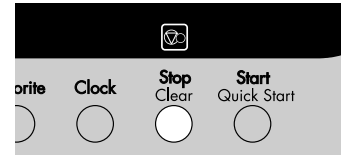

Press **Defrost** once.

Turn **Dial** knob until display shows "dEF2".

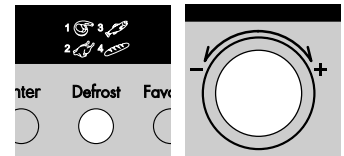

Press **Enter** for category(poultry) confirmation.

Enter the weight of the frozen food that you are about to defrost.

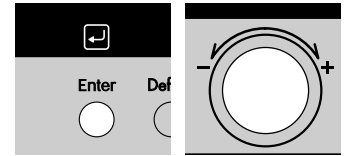

Turn **Dial** knob until display shows "1.4kg" for the weight of frozen food.

Press **Start**.

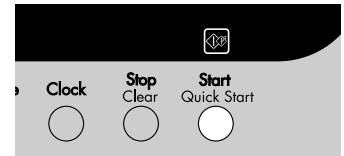

During defrosting your oven will "BEEP", at which point open the oven door, turn food over and separate to ensure even thawing. Remove any portions that have thawed or shield them to help slow down thawing. After checking, close the oven door and press **Start** to resume defrosting.

Your oven will not stop defrosting (even when the beep sounded) unless the door is opened.

DEFROSTING GUIDE

- * Food to be defrosted should be in a suitable microwave proof container and should be placed uncovered on the metal tray.
- * If necessary, shield small areas of meat or poultry with flat pieces of aluminum foil. This will prevent thin areas becoming warm during defrosting. Ensure the foil does not touch the oven walls.
- * Separate items like minced meat, chops, sausages and bacon as soon as possible. **When BEEP, turn food over.** Continue to defrost remaining pieces. Allow to stand until completely thawed.
- * For example, joints of meat and whole chickens should be standed for a minimum 1 hour before cooking.

<i>Category</i>	<i>Weight Limit</i>	<i>Utensil</i>	<i>Food</i>
Meat (dEF1)	0.1 ~ 4.0 kg	Microwave ware (Flat plate), Metal tray	Meat Minced beef, Fillet steak, Cubes for stew, Sirloin steak, Pot roast, Rump roast, Beef burger Lamb chops, Rolled roast, Sausage, Cutlets(2cm) When beep, turn food over. After defrosting, let stand for 5-15 minutes.
Poultry (dEF2)			Poultry Whole chicken, Legs, Breasts, Turkey breasts(under 2.0kg) When beep, turn food over. After defrosting, let stand for 20-30 minutes.
Fish (dEF3)			Fish Fillets, Steaks, Whole fish, Sea foods When beep, turn food over. After defrosting, let stand for 10-20 minutes.
Bread (dEF4)	0.1 ~ 0.5 kg	Paper towel or flat plate, Metal tray	Sliced bread, Buns, Baguette, etc

Grill Cooking

In the following example I will show you how to use the Grill-1 to cook some food for 12 minutes and 30 seconds.



This feature will allow you to brown and crisp food quickly.

The grill rack is placed on the metal tray at the grill mode.

The high rack must be used during grill cooking.



Press **Stop/Clear**.

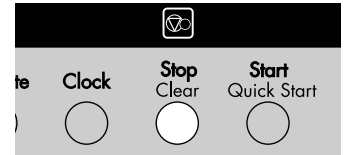

Press **Grill** to select grill mode.

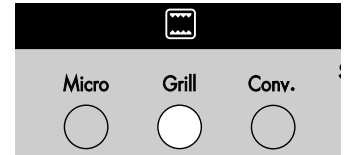

Turn **Dial** knob until display shows "gr-1".
Press **Enter** for grill confirmation.

Category	Display	Heater Operating
Grill-1	gr-1	Upper Heater(1950W)
Grill-2	gr-2	Upper Heater(1100W)
Grill-3	gr-3	Lower Heater(650W)

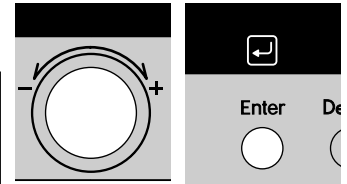

Turn **Dial** knob until display shows "12:30".



Press **Start**.

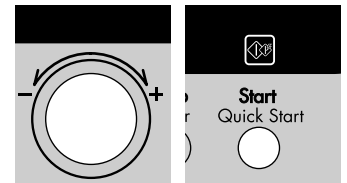

After cooking you must wear gloves and container to take metal tray out oven, because metal tray is very hot.

Micro Power Cooking

In the following example I will show you how to cook some food on 600W power for 5 minutes and 30 seconds.



Your oven has five microwave Power settings. High power is automatically selected and turning of the dial will select a different power level.

POWER	
HIGH	900 W
MEDIUM HIGH	600 W
MEDIUM	360 W
DEFROST MEDIUM LOW	180 W
LOW	90 W

Don't Use

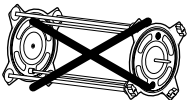

ROTISSERIE

Make sure that you have correctly installed your oven as described earlier in this book.

Press **Stop/Clear**.

Press **Micro** once to select microwave mode.

Turn **Dial** knob until display shows "600W".

Press **Enter** for power confirmation.

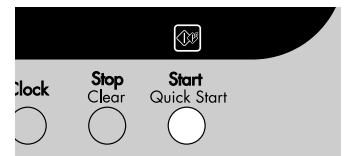
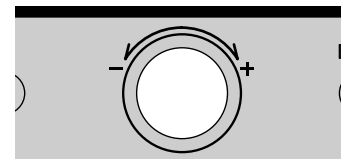
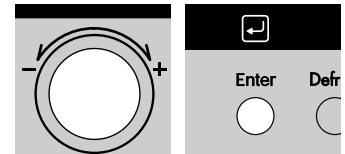
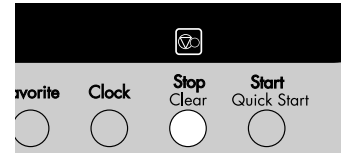

Turn **Dial** knob until display shows "5:30".

Press **Start**.



Micro Power Level

This oven is equipped with 5 power levels to give you maximum flexibility and control over cooking. The table below shows the examples of food and their recommended cooking power levels for use with this oven.

POWER LEVEL	OUTPUT	USE	ACCESSORY
HIGH	900W	<ul style="list-style-type: none"> * Boil Water * Brown minced beef * Cook poultry pieces, fish, vegetables * Cook tender cuts of meat 	Low Rack + Metal Tray 
MEDIUM HIGH	600W	<ul style="list-style-type: none"> * All reheating * Roast meat and poultry * Cook mushrooms and shellfish * Cook foods containing cheese and eggs 	
MEDIUM	360W	<ul style="list-style-type: none"> * Bake cakes and scones * Prepare eggs * Cook custard * Prepare rice, soup 	
DEFROST/ MEDIUM LOW	180W	<ul style="list-style-type: none"> * All thawing * Melt butter and chocolate * Cook less tender cuts of meat 	Metal Tray 
LOW	90W	<ul style="list-style-type: none"> * Soften butter & cheese * Soften ice cream * Raise yeast dough 	Low Rack + Metal Tray 



Two stage Cooking

In the following example I will show you how to cook some food in two stages. The first stages will cook your food for 11 minutes on HIGH(900W); the second will cook for 35 minutes on 360W.



During two stage cooking the oven door can be opened and food can be checked. Close the oven door and press **Start** and the cooking stage will continue.

At the end of stage1, BEEP sounds and stage 2 commences.

Should you wish to clear the programme, press **Stop/Clear** twice.

Don't Use

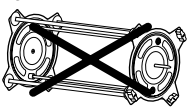

ROTISSERIE

1 Press **Stop/Clear** .

Set the power and the cooking time for **stage1**.

Press **Micro** once to select microwave mode.

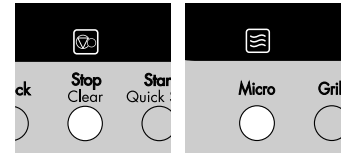

2 Turn **Dial** knob until display shows "900W".

Press **Enter** for power confirmation.

Turn **Dial** knob until display shows "11:00".

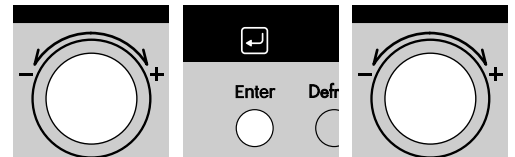

3 Set the **power** and the cooking time for **stage2**.

Press **Micro** once to select microwave mode.

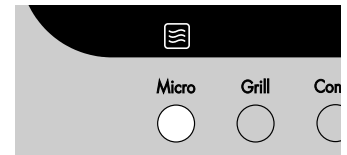

4 Turn **Dial** knob until display shows "360W".

Press **Enter** for power confirmation.

Turn **Dial** knob until display shows "35:00".

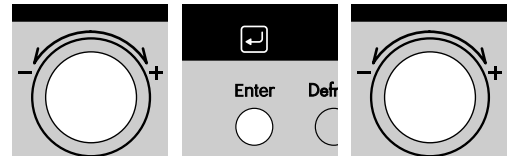

5 Press **Start**.

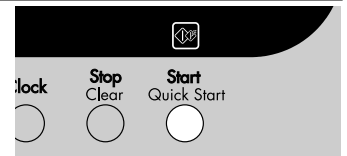

Favorite Cook

This feature allows you to set and execute a frequently used single stage programme. Once the cooking programme is set, you can use it by pressing the favorite cook key. In the following example I will show you how to set the cooking programme for 10 minutes 30 seconds on 600W power.



1. To Set

The cooking programme can be stored in the memory of your oven. If you wish to change your FAVORITE COOK, simply enter a new cooking programme.

You can store up to 9 mode. (FA-1~FA-9)

Press **Stop/Clear**.

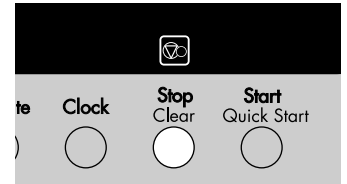

Press **Favorite** button, FA-1 appears on the display.

Press **Micro**.

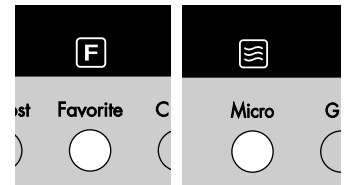
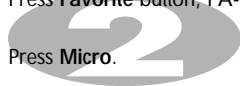

Turn **Dial** knob until display shows "600W"

Press **Enter**.

Turn **Dial** knob until display shows "10:30"

Press **Favorite**.

(Press **Start**, the cooking programme will be stored in the memory of your oven and cooking start)

Successfully finished setting the favorite cook.

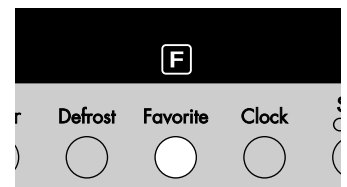
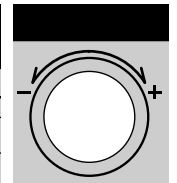
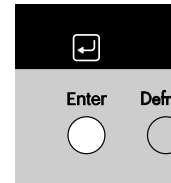
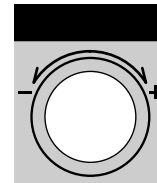

Favorite Cook



2. To Cook

When you cook, use it by pressing the favorite button.
Press **Favorite** until display shows "FA-1".

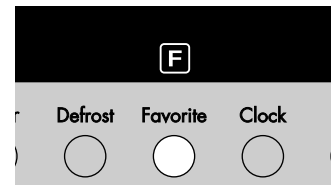
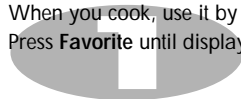

Press **Start**.

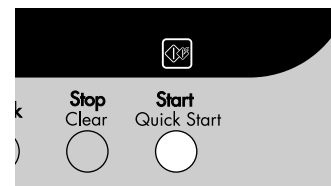

3. To replace programme (if any cooking is programmed at FA-1)

Press **Favorite** button, FA-1 and cooking data appears on the display.

Press one of **Favorite** buttons you want to programme.
Set a new cooking programme.

Press **Favorite**.

(Press **Start**, the cooking programme will be stored in the memory of your oven and cooking start)

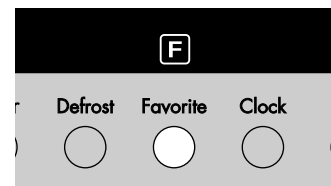
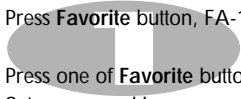

Quick Start

In the following example I will show you how to set 2 minutes of cooking on high power(900W).



The **Quick Start** feature allows you to set 30 seconds intervals of HIGH power(900W) cooking with pressing of the **Quick Start** button.

Don't Use

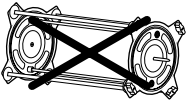

ROTISSERIE

Press **Stop/Clear**.

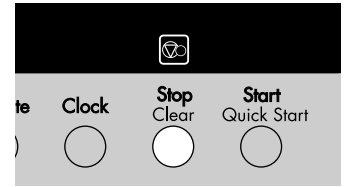
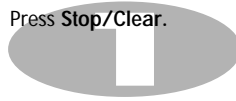

Press **Quick Start** four times to select 2 minutes on HIGH power(900W). Your oven will start before you have finished the fourth press.

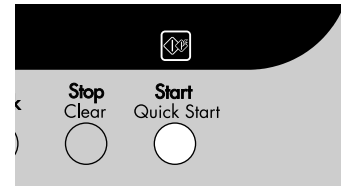

During **Quick Start** cooking, you can extend the cooking time up to 10 minutes by repeatedly pressing the **Quick Start** key.



More or Less Cooking

In the following example I will show you how to change the preset **SPEED AUTO COOK** programmes for a longer or shorter cooking time.



If you find that your food is over or undercooked when using the **SPEED AUTO COOK** programme, you can increase or decrease cooking time by turning the **DIAL** knob.

You can lengthen or shorten the cooking time(except defrost mode) at any point by turning the **DIAL** knob.

Cooking time	Increase or Decrease time
0-3 min.	10 Sec.
3-20 min.	30 Sec.
20-30 min.	1 Min.
30-90 min.	5 Min.

Press **Stop/Clear**.

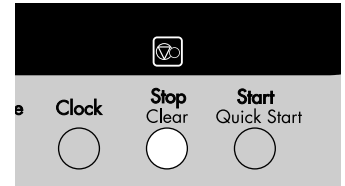

Set the required **SPEED AUTO COOK** programme.
*See **SPEED AUTO COOK** (page14).

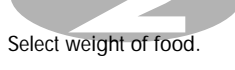

Select weight of food.

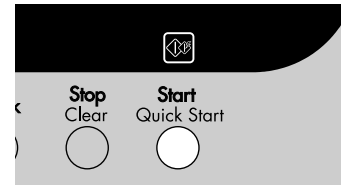

Press **Start**.

Turn **DIAL** knob.



The cooking time will increase or decrease.

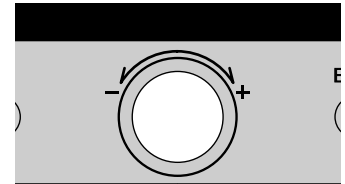

Rotisserie

Installation & Cooking

In the following example I will show you how to cook 1kg of whole chicken(SC 8).



Don't hold the chicken vertically while blacing it inside the rotisserie. (as show in the picture)

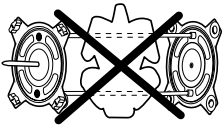

Tie chicken's feet, wings and body with a cotton thread before cooking whole chicken as show in the picture.

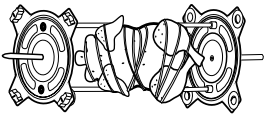

Press **Stop/Clear**.

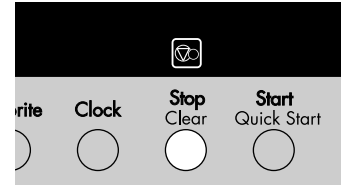

Press **Speed Auto Cook**.

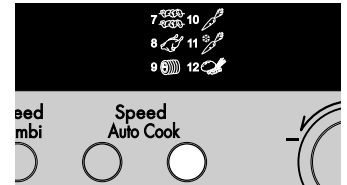

Turn **Dial knob** until display shows "SC 8".

Press **Enter** for category(whole chicken) confirmation.

Turn **Dial knob** until display shows "1.00kg".

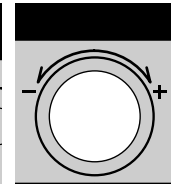
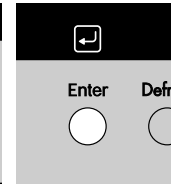
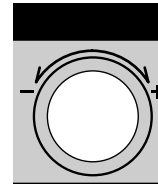

Prepare foods with the rotisserie.

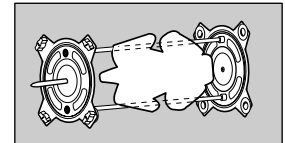
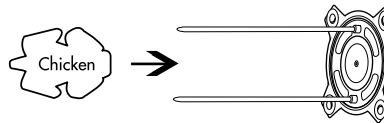

Rotisserie

Installation & Cooking



To Clean ROTISSERIE & METAL TRAY

When cooking is completed, separate the ROTISSERIE from the food. Take care when handling ROTISSERIE, metal tray and food stuff as it is very hot. During cooking it is normal for the ROTISSERIE & metal tray to be stained from the food. Simply clean the ROTISSERIE & metal tray with a warm soapy water and a soft cloth. If the ROTISSERIE & metal tray remain stained after washing, soak utensils in hot soapy water for a few minutes. Do not use metal scouring pads. They will scratch the surface .

Insert the shaft of right plate into the shaft of motor.

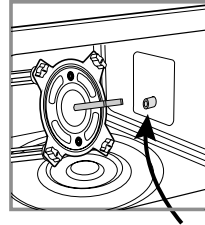

The shaft of motor

Put the shaft of left plate on the holder of rotisserie.

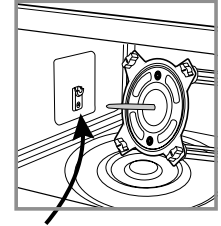

The holder of rotisserie

Press **START**.

After cooking hold the rotisserie bar of both side with the handle and lift up the left end lightly and pull out from the right end.

NOTE:

1. The rotisserie cooking is convenient for grilling of meat and poultry. All the surface of the food will become even brown without overturning.
2. The rotisserie cooking can be used in Grill mode, Convection mode and Speed Auto Cook mode.
3. The rotisserie bar is used for rotisserie cooking only. After rotisserie cooking is finished remove the rotisserie bar and store with other accessories.

CAUTION

1. **DO NOT USE THE ROTISSERIE WITH NO LOAD, IT WILL DAMAGE THE OVEN.**
2. **AFTER COOKING, THE METAL TRAY WILL BECOME EXTREMELY HOT.**
3. It is recommended to remove the grease from the turntable every time before cooking. Hot grease on the turntable may cause smoke.

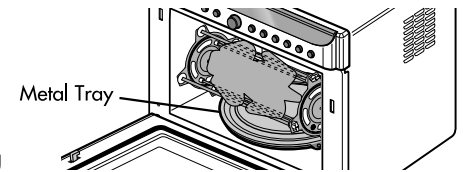
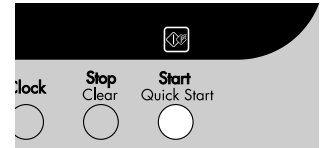

Metal Tray

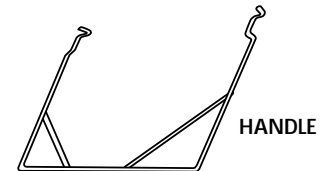

HANDLE

Rotisserie

Installation & Cooking

In the following example I will show you how to cook 0.8kg of kebab(SC 7).



Press **Stop/Clear**.

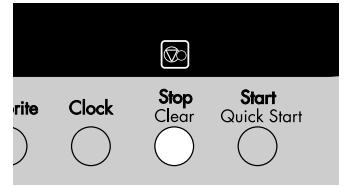

Press **Speed Auto Cook**.

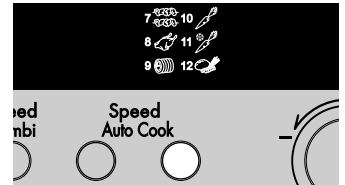

Turn **Dial** knob until display shows "SC 7".

Press **Enter** for category(kebab) confirmation.

Turn **Dial** knob until display shows "0.8kg".

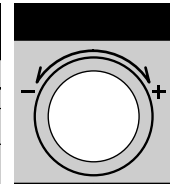
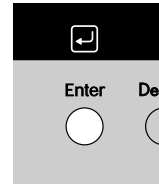
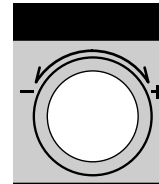

Prepare foods with the rotisserie.

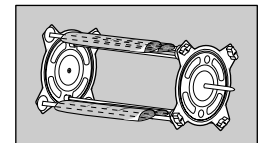
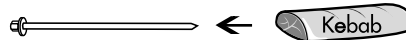
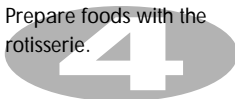

Rotisserie

Installation & Cooking



To Clean ROTISSERIE & METAL TRAY

When cooking is completed, separate the ROTISSERIE from the food. Take care when handling ROTISSERIE, metal tray and food stuff as it is very hot. During cooking it is normal for the ROTISSERIE & metal tray to be stained from the food. Simply clean the ROTISSERIE & metal tray with a warm soapy water and a soft cloth. If the ROTISSERIE & metal tray remain stained after washing, soak utensils in hot soapy water for a few minutes. Do not use metal scouring pads. They will scratch the surface .

Insert the shaft of right plate into the shaft of motor.

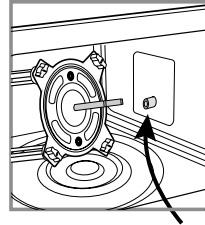

The shaft of motor

Put the shaft of left plate on the holder of rotisserie.

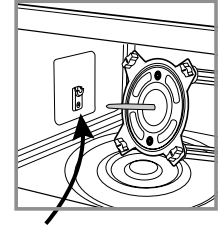

The holder of rotisserie

Press **START**.

After cooking, hold the rotisserie bar of both side with the handle and lift up the left end lightly and pull out from the right end.

NOTE:

1. The rotisserie cooking is convenient for grilling of meat and poultry. All the surface of the food will become even brown without overturning.
2. The rotisserie cooking can be used in Grill mode, Convection mode and Speed Auto Cook mode.
3. The rotisserie bar is used for rotisserie cooking only. After rotisserie cooking is finished remove the rotisserie bar and store with other accessories.

CAUTION

1. **DO NOT USE THE ROTISSERIE WITH NO LOAD, IT WILL DAMAGE THE OVEN.**
2. **AFTER COOKING, THE METAL TRAY WILL BECOME EXTREMELY HOT.**
3. It is recommended to remove the grease from the turntable every time before cooking. Hot grease on the turntable may cause smoke.

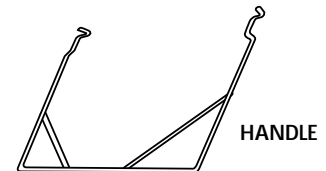
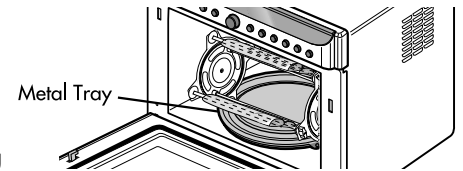
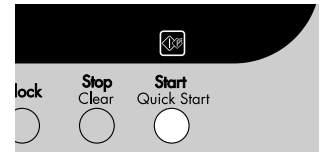

Rotisserie

Assembly



CAUTION

Rotisserie is not a toy.
Keep the Rotisserie away
from the child.

Screw the barbecue bars into the right plate.

1

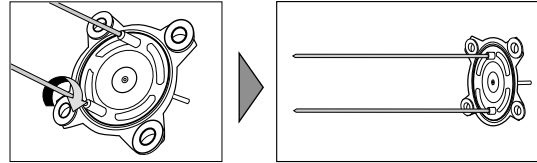

Screw the barbecue bar clockwise
into the right plate

Assemble the left plate

2

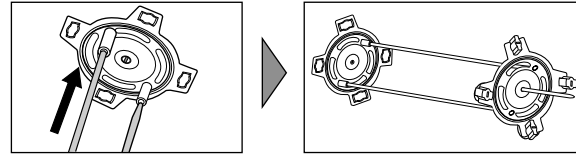

Push barbecue bars into left plate.

Assemble skewers

3

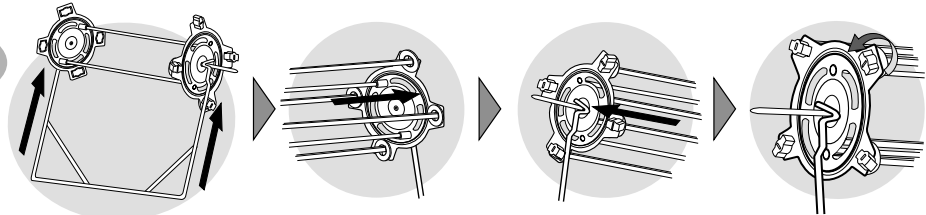

Install the handle on the
rotisserie.

Insert the pointed edge of
the skewer into hole on
the right plate.

Insert the other edge
of the skewer into a
hole on the left plate.

Turn it counterclockwise until
it's fixed. Repeat 4 times until
rotisserie is assembled.

WARNING

Please ensure cooking times are correctly set as over cooking may result in FIRE and subsequent DAMAGE to the OVEN.

Important safety instructions

Read carefully and keep for future reference

- 1 Do not attempt to tamper with, or make any adjustments or repairs to the door, control panel, safety interlock switches or any other part of the oven. It is hazardous for anyone to carry out any service or repair operation which involves the removal of any cover which gives protection against exposure to microwave energy. Repairs should only be undertaken by a qualified service technician.
- 2 Do not operate the oven when empty. It is best to leave a glass of water in the oven when not in use. The water will safely absorb all microwave energy, if the oven is accidentally started.
- 3 Do not use the oven for the purpose of dehumidification. It can be the cause of serious damage of safety. (ex. Operating the microwave oven with the wet newspapers, clothes, toys, pet or portable electric devices, etc.)
- 4 Do not cook food wrapped in paper towels, unless your cook book contains instructions, for the food you are cooking.
- 5 Do not use newspaper in place of paper towels for cooking.
- 6 Do not use wooden containers. They may heat-up and char. Do not use ceramic containers which have metallic (e.g. gold or silver) inlays. Always remove metal twist ties. Metal objects in the oven may arc, which can cause serious damage.
- 7 Do not operate the oven with a kitchen towel, a napkin or any other obstruction between the door and the front edges of the oven, which may cause microwave energy leakage.
- 8 Do not use recycled paper products since they may contain impurities which may cause sparks and/or fires when used in cooking.
- 9 Do not rinse the turntable by placing it in water just after cooking. This may cause breakage or damage.
- 10 Small amounts of food require shorter cooking or heating time. If normal times are allowed they may overheat and burn.
- 11 Be certain to place the oven so the front of the door is 8 cm or more behind the edge of the surface on which it is placed, to avoid accidental tipping of the appliance.
- 12 Before cooking, pierce the skin of potatoes, apples or any such fruit or vegetable.
- 13 Do not cook eggs in their shell. Pressure will build up inside the egg which will burst.
- 14 Do not attempt deep fat frying in your oven.
- 15 Remove the plastic wrapping from food before cooking or defrosting. Note though that in some cases food should be covered with plastic film, for heating or cooking.
- 16 If the oven door or door seals are damaged, the oven must not be operated until it has been repaired by a qualified service technician.
- 17 If smoke is observed, switch off or disconnect the oven from the power supply and keep the oven door closed in order to stifle any flames.
- 18 When food is heated or cooked in disposable containers of plastic, paper or other combustible materials, check the oven frequently due to the possibility of the food container is deteriorating.
- 19 Only allow children to use the oven without supervision when adequate instructions have been given so that the child is able to use the oven in a safe way and understands the hazards of improper use.
- 20 Liquids or other foods must not be heated in sealed containers since they are liable to explode.
- 21 Do not operate the oven, if the door seals and adjacent parts of the microwave oven are faulty, until the oven has been repaired by a qualified service technician.
- 22 Check the utensils are suitable for use in microwave ovens before use.
- 23 Do not touch the oven door, outer cabinet, rear cabinet, oven cavity, accessories and dishes during grill mode, convection mode and auto cook operations, unless wearing thick oven gloves, as they will become hot. Before clearing make sure they are not hot.

Important safety instructions

Read carefully and keep for future reference

- 24 Only use utensils that are suitable for use in microwave ovens.
- 25 When heating food in plastic or paper containers, keep an eye on the oven due to the possibility of ignition.
- 26 If smoke is observed, switch off or unplug the appliance and keep the door closed in order to stifle any flames.
- 27 Microwave heating of beverages can result in delayed eruptive boiling, therefore care must be taken when handling the container.
- 28 The contents of feeding bottles and baby food jars shall be stirred or shaken and the temperature checked before consumption, in order to avoid burns.
- 29 Eggs in their shell and whole hard-boiled eggs should not be heated in microwave ovens since they may explode, even after microwave heating has ended.
- 30 Details for cleaning door seals, cavities and adjacent parts.
- 31 The oven should be cleaned regularly and any food deposits removed.
- 32 Failure to maintain the oven in a clean condition could lead to deterioration of the surface that could adversely affect the life of the appliance and possibly result in a hazardous situation.
- 33 Only use the temperature probe recommended for this oven (for appliances having a facility to use a temperature-sensing probe).
- 34 If heating elements are provided, during use the appliance becomes hot. Care should be taken to avoid touching heating elements inside the oven.
- 35 The appliance is not intended for use by young children or infirm persons without supervision.

WARNING: If the door or door seals are damaged, the oven must not be operated until it has been repaired by a competent person.

WARNING: It is hazardous for anyone other than a competent person to carry out any service or repair operation that involves the removal of a cover which gives protection against exposure to microwave energy.

WARNING: Liquids and other foods must not be heated in sealed containers since they are liable to explode.

WARNING: Only allow children to use the oven without supervision when adequate instructions have been given so that the child is able to use the oven in a safe way and understands the hazards of improper use.

WARNING: This appliance is not intended for use by persons (including children) with reduced physical, sensory or mental capabilities, or lack of experience and knowledge, unless they have been given supervision or instruction concerning use of the appliance by a person responsible for their safety.

Microwave-safe Utensils

Never use metal or metal trimmed utensils in using microwave function

Microwaves cannot penetrate metal. They will bounce off any metal object in the oven and cause arcing, an alarming phenomenon that resembles lightning. Most heat resistant non metallic cooking utensils are safe for use in your oven. However, some may contain materials that render them unsuitable as microwave cookware. If you have any doubts about a particular utensil, there's a simple way to find out if it can be used in using microwave function. Place the utensil in question next to a glass bowl filled with water in using microwave function. Microwave at power HIGH for 1 minute. If the water heats up but the utensil remains cool to the touch, the utensil is microwave-safe. However, if the water does not change temperature but the utensil becomes warm, microwaves are being absorbed by the utensil and it is not safe for use in using microwave function. You probably have many items on hand in your kitchen right now that can be used as cooking equipment in using microwave function. Just read through the following checklist.

Dinner plates

Many kinds of dinner-ware are microwave-safe. If in doubt consult the manufacturer's literature or perform the microwave test.

Glassware

Glassware that is heat-resistant is microwave-safe. This would include all brands of oven tempered glass cookware. However, do not use delicate glassware, such as tumblers or wine glasses, as these might shatter as the food warms.

Plastic storage containers

These can be used to hold foods that are to be quickly reheated. However, they should not be used to hold foods that will need considerable time in the oven as hot foods will eventually warp or melt plastic containers.

Paper

Paper plates and containers are convenient and safe to use in using microwave function, provided that the cooking time is short and foods to be cooked are low in fat and moisture. Paper towels are also very useful for wrapping foods and for lining baking trays in which greasy foods such as bacon are cooked. In general, avoid coloured paper products as the colour may run. Some recycled paper products may contain impurities which could cause arcing or fires when used in using microwave function.

Plastic cooking bags

Provided they are made specially for cooking, cooking bags are microwave safe. However, be sure to make a slit in the bag so that steam can escape. Never use ordinary plastic bags for cooking in using microwave function, as they will melt and rupture.

Plastic microwave cookware

A variety of shapes and sizes of microwave cookware are available. For the most part, you can probably use items you already have on hand rather than investing in new kitchen equipment.

Pottery, stoneware and ceramic

Containers made of these materials are usually fine for use in using microwave function, but they should be tested to be sure.

CAUTION

Some items with high lead or iron content are not suitable for cooking utensils.

Utensils should be checked to ensure that they are suitable for use in using microwave function.

Food characteristics & Microwave cooking

Keeping an eye on things

The recipes in the book have been formulated with great care, but your success in preparing them depends on how much attention you pay to the food as it cooks. Always watch your food while it cooks. Your microwave function is equipped with a light that turns on automatically when the oven is in operation so that you can see inside and check the progress of your food. Directions given in recipes to elevate, stir, and the like should be thought of as the minimum steps recommended. If the food seems to be cooking unevenly, simply make the necessary adjustments you think appropriate to correct the problem.

Factors affecting microwave cooking times

Many factors affect cooking times. The temperature of ingredients used in a recipe makes a big difference in cooking times. For example, a cake made with ice-cold butter, milk, and eggs will take considerably longer to bake than one made with ingredients that are at room temperature. All of the recipes in this book give a range of cooking times. In general, you will find that the food remains undercooked at the lower end of the time range, and you may sometimes want to cook your food beyond the maximum time given, according to personal preference. The governing philosophy of this book is that it is best for a recipe to be conservative in giving cooking times. While overcooked food is ruined for good. Some of the recipes, particularly those for bread, cake, and custards, recommend that food be removed from the oven when they are slightly undercooked. This is not a mistake. When allowed to stand, usually covered, these foods will continue to cook outside of the oven as the heat trapped within the outer portions of the food gradually travels inward. If the food is left in the oven until it is cooked all the way through, the outer portions will become overcooked or even burnt. You will become increasingly skilful in estimating both cooking and standing times for various foods.

Density of food

Light, porous food such as cakes and breads cook more quickly than heavy, dense foods such as roasts and casseroles. You must take care when microwaving porous food that the outer edges do not become dry and brittle.

Height of food

The upper portion of tall food, particularly roasts, will cook more quickly than the lower portion. Therefore, it is wise to turn tall food during cooking, sometimes several times.

Moisture content of food

Since the heat generated from microwaves tends to evaporate moisture, relatively dry food such as roasts and some vegetables should either be sprinkled with water prior to cooking or covered to retain moisture.

Bone and fat content of food

Bones conduct heat and fat cooks more quickly than meat. Care must be taken when cooking bony or fatty cuts of meat that they do not cook unevenly and do not become overcooked.

Quantity of food

The number of microwaves in your oven remains constant regardless of how much food is being cooked. Therefore, the more food you place in the oven, the longer the cooking time. Remember to decrease cooking times by at least one third when halving a recipe.

Shape of food

Microwaves penetrate only about 2 cm into food, the interior portion of thick foods are cooked as the heat generated on the outside travels inward. Only the outer edge of food is cooked by microwave energy; the rest is cooked by conduction. The worst possible shape for a food that is to be microwaved is a thick square. The corners will burn long before the centre is even warm. Round thin foods and ring shaped foods cook successfully in the microwave.

Covering

A cover traps heat and steam which causes food to cook more quickly. Use a lid or microwave cling film with a corner folded back to prevent splitting.

Browning

Meats and poultry that are cooked fifteen minutes or longer will brown lightly in their own fat. Food that are cooked for a shorter period of time may be brushed with a browning sauce such as worcestershire sauce, soy sauce or barbecue sauce to achieve an appetizing colour. Since relatively small amounts of browning sauces are added to food the original flavour of the recipe is not altered.

Covering with greaseproof paper

Greaseproofing effectively prevents spattering and helps food retain some heat. But because it makes a looser cover than a lid or clingfilm, it allows the food to dry out slightly.

Arranging and spacing

Individual foods such as baked potatoes, small cakes and hors d'oeuvres will heat more evenly if placed in the oven an equal distance apart, preferably in a circular pattern. Never stack foods on top of one another.

Food characteristics & Microwave cooking.

Stirring

Stirring is one of the most important of all microwaving techniques. In conventional cooking, food is stirred for the purpose of blending. Microwaved food, however, is stirred in order to spread and redistribute heat. Always stir from the outside towards the centre as the outside of the food heats first.

Turning over

Large, tall foods such as roasts and whole chickens should be turned so that the top and bottom will cook evenly. It is also a good idea to turn cut up chicken and chops.

Placing thicker portions facing outwards

Since microwaves are attracted to the outside portion of food, it makes sense to place thicker portions of meat, poultry and fish to the outer edge of the baking dish. This way, thicker portions will receive the most microwave energy and the food will cook evenly.

Shielding

Strips of aluminium foil (which block microwaves) can be placed over the corners or edges of square and rectangular foods to prevent those portions from overcooking. Never use too much foil and make sure the foil is secured to the dish or it may cause 'arcing' in the oven.

Elevating

Thick or dense foods can be elevated so that microwaves can be absorbed by the underside and centre of the foods.

Piercing

Foods enclosed in a shell, skin or membrane are likely to burst in the oven unless they are pierced prior to cooking. Such foods include yolks and whites of eggs, clams and oysters and whole vegetables and fruits.

Testing if cooked

Food cooks so quickly in a oven, it is necessary to test it frequently. Some foods are left in the microwave until completely cooked, but most foods, including meats and poultry, are removed from the oven while still slightly undercooked and allowed to finish cooking during standing time. The internal temperature of foods will rise between 5°F (3°C) and 15°F (8°C) during standing time.

Standing time

Foods are often allowed to stand for 3 to 10 minutes after being removed from the oven. Usually the foods are covered during standing time to retain heat unless they are supposed to be dry in texture (some cakes and biscuits, for example). Standing allows foods to finish cooking and also helps flavour blend and develop.

To Clean Your Oven

1 Keep the inside of the oven clean

Food spatters or spilled liquids stick to oven walls and between seal and door surface. It is best to wipe up spillovers with a damp cloth right away. Crumbs and spillovers will absorb microwave energy and lengthen cooking times. Use a damp cloth to wipe out crumbs that fall between the door and the frame. It is important to keep this area clean to assure a tight seal. Remove greasy spatters with a soapy cloth then rinse and dry. Do not use harsh detergent or abrasive cleaners. The metal tray can be washed by hand or in the dishwasher.

2 Keep the outside of the oven clean

Clean the outside of your oven with soap and water then with clean water and dry with a soft cloth or paper towel. To prevent damage to the operating parts inside the oven, the water should not be allowed to seep into the ventilation openings. To clean control panel, open the door to prevent oven from accidentally starting, and wipe a damp cloth followed immediately by a dry cloth. Press Stop/Clear after cleaning.

3 If steam accumulates inside or around the outside of the oven door, wipe the panels with a soft cloth. This may occur when the oven is operated under high humidity conditions and in no way indicates a malfunction of the unit.

4 The door and door seals should be kept clean. Use only warm, soapy water, rinse then dry thoroughly.
DO NOT USE ABRASIVE MATERIALS, SUCH AS CLEANING POWDERS OR STEEL AND PLASTIC PADS.

Metal parts will be easier to maintain if wiped frequently with a damp cloth.

Questions & Answers

Q What's wrong when the oven light will not glow?

- A There may be several reasons why the oven light will not glow.
Light bulb has blown
Relay is failed

Q Does microwave energy pass through the viewing screen in the door?

- A No. The holes, or ports, are made to allow light to pass; they do not let microwave energy through.

Q Why does the beep tone sound when a button on the Control Panel is touched?

- A The beep tone sounds to assure that the setting is being properly entered.

Q Will the microwave function be damaged if it operates empty?

- A Yes Never run it empty or without the metal tray.

Q Why do eggs sometimes pop?

- A When baking, frying, or poaching eggs, the yolk may pop due to steam build up inside the yolk membrane. To prevent this, simply pierce the yolk before cooking. Never microwave eggs in the shell.

Q Why is standing time recommended after microwave cooking is over?

- A After microwave cooking is finished, food keeps on cooking during standing time. This standing time finishes cooking evenly throughout the food. The amount of standing time depends on the density of the food.

Q Is it possible to cook popcorn in this oven?

- A Yes, if using one of the two methods described below
1 Popcorn-popping utensils designed specifically for microwave cooking.
2 Prepackaged commercial microwave popcorn that contains specific times and power outputs needed for an acceptable final product.

FOLLOW EXACT DIRECTIONS GIVEN BY EACH MANUFACTURER FOR THEIR POPCORN PRODUCT. DO NOT LEAVE THE OVEN UNATTENDED WHILE THE CORN IS BEING POPPED. IF CORN FAILS TO POP AFTER THE SUGGESTED TIMES, DISCONTINUE COOKING. OVERCOOKING COULD RESULT IN THE CORN CATCHING FIRE.

CAUTION

NEVER USE A BROWN PAPER BAG FOR POPPING CORN. NEVER ATTEMPT TO POP LEFTOVER KERNELS.

Q Why doesn't my oven always cook as fast as the cooking guide says?

- A Check your cooking guide again to make sure you've followed directions correctly, and to see what might cause variations in cooking time. Cooking guide times and heat settings are suggestions, chosen to help prevent overcooking, the most common problem in getting used to a this oven. Variations in the size, shape, weight and dimensions of the food require longer cooking time. Use your own judgement along with the cooking guide suggestions to test food condition, just as you would do with a conventional cooker.

Plug wiring information/ Technical Specifications

Warning

This appliance must be earthed

The wires in this mains lead are colored in accordance with the following codes
 BLUE - Neutral
 BROWN - Live
 GREEN & YELLOW - Earth

As the colours of the wires in the mains lead of this appliance may not correspond with the coloured markings identifying the terminals in your plug proceed as follows:

The wire which is colored BLUE must be connected to the terminal which is marked with the letter N or Colored BLACK.

The wire which is colored BROWN must be connected to the terminal which is marked with the letter L or colored RED.

The wire which is colored GREEN & YELLOW or GREEN must be connected to the terminal which is marked with the letter E or .

If the supply cord is damaged, it must be replaced by the manufacturer or its service agent or a similarly qualified person in order to avoid a hazard;

Technical Specification

		MP-9482SR
Power Input		220 V AC / 50Hz
Output		900 W (IEC60705 rating standard)
Microwave Frequency		2450 MHz
Outside Dimension		527 mm(W) X 392mm(H) X 480 mm(D)
Power	Microwave	1600 Watts
	Grill	Max. 2040 Watts
Consumption	Combination	Max. 2700 Watts
	Convection	1750 Watts