



**LG**  
Life's Good

## LCD TV OWNER'S MANUAL

22LG3DCH  
26LG3DCH  
32LG3DCH  
32LG3DC

Please read this manual carefully before operating your set.

Retain it for future reference.

Record model number and serial number of the set. See the label attached on the back cover and quote this information to your dealer when you require service.

(Only 32LG3DC model)



This product qualifies for ENERGY STAR in the "factory default (Home mode)" setting and this is the setting in which power savings will be achieved.

Changing the factory default picture setting or enabling other features will increase power consumption that could exceed the limits necessary to qualify for Energy Star rating.

P/NO : SAC30708026 (0905-REV09)



# WARNING / CAUTION



**WARNING / CAUTION**  
RISK OF ELECTRIC SHOCK  
DO NOT OPEN



**TO REDUCE THE RISK OF ELECTRIC SHOCK  
DO NOT REMOVE COVER (OR BACK). NO  
USER SERVICEABLE PARTS INSIDE. REFER TO  
QUALIFIED SERVICE PERSONNEL.**



The lightning flash with arrowhead symbol, within an equilateral triangle, is intended to alert the user to the presence of uninsulated “dangerous voltage” within the product’s enclosure that may be of sufficient magnitude to constitute a risk of electric shock to persons.



The exclamation point within an equilateral triangle is intended to alert the user to the presence of important operating and maintenance (servicing) instructions in the literature accompanying the appliance.

## WARNING/CAUTION

**TO REDUCE THE RISK OF FIRE AND ELECTRIC SHOCK, DO NOT EXPOSE THIS PRODUCT TO RAIN OR MOISTURE.**

## NOTE TO CABLE/TV INSTALLER

This reminder is provided to call the CATV system installer’s attention to Article 820-40 of the National Electric Code (U.S.A.). The code provides guidelines for proper grounding and, in particular, specifies that the cable ground shall be connected to the grounding system of the building, as close to the point of the cable entry as practical.

## WARNING / CAUTION

To prevent fire or shock hazards, do not expose this product to rain or moisture.

## FCC NOTICE

### Class B digital device

This equipment has been tested and found to comply with the limits for a Class B digital device, pursuant to Part 15 of the FCC Rules. These limits are designed to provide reasonable protection against harmful interference in a residential installation. This equipment generates, uses and can radiate radio frequency energy and, if not installed and used in accordance with the instructions, may cause harmful interference to radio communications. However, there is no guarantee that interference will not occur in a particular installation. If this equipment does cause harmful interference to radio or television reception, which can be determined by turning the equipment off and on, the user is encouraged to try to correct the interference by one or more of the following measures:

- Reorient or relocate the receiving antenna.
- Increase the separation between the equipment and receiver.
- Connect the equipment to an outlet on a circuit different from that to which the receiver is connected.
- Consult the dealer or an experienced radio/TV technician for help.

**Any changes or modifications not expressly approved by the party responsible for compliance could void the user’s authority to operate the equipment.**

## CAUTION

Do not attempt to modify this product in any way without written authorization from LG Electronics. Unauthorized modification could void the user’s authority to operate this product

# SAFETY INSTRUCTIONS

## IMPORTANT SAFETY INSTRUCTIONS

Read these instructions.

Keep these instructions.

Heed all warnings.

Follow all instructions.



- 1 Do not use this apparatus near water.

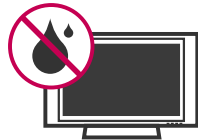

- 2 Clean only with dry cloth.



- 3 Do not block any ventilation openings. Install in accordance with the manufacturer's instructions.



- 4 Do not install near any heat sources such as radiators, heat registers, stoves, or other apparatus (including amplifiers) that produce heat.



- 5 Do not defeat the safety purpose of the polarized or grounding-type plug. A polarized plug has two blades with one wider than the other. A grounding type plug has two blades and a third grounding prong. The wide blade or the third prong are provided for your safety. If the provided plug does not fit into your outlet, consult an electrician for replacement of the obsolete outlet.



- 6 Protect the power cord from being walked on or pinched particularly at plugs, convenience receptacles, and the point where they exit from the apparatus.



- 7 Only use attachments/accessories specified by the manufacturer.



- 8 Use only with the cart, stand, tripod, bracket, or table specified by the manufacturer, or sold with the apparatus. When a cart is used, use caution when moving the cart/apparatus combination to avoid injury from tip-over.



- 9 Unplug this apparatus during lightning storms or when unused for long periods of time.

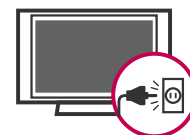

- 10 Refer all servicing to qualified service personnel. Servicing is required when the apparatus has been damaged in any way, such as power-supply cord or plug is damaged, liquid has been spilled or objects have fallen into the apparatus, the apparatus has been exposed to rain or moisture, does not operate normally, or has been dropped.

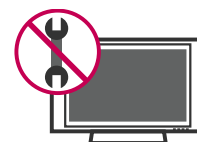

**11** Never touch this apparatus or antenna during a thunder or lighting storm.

**12** When mounting a TV on the wall, make sure not to install the TV by the hanging power and signal cables on the back of the TV.

**13** Do not allow an impact shock or any objects to fall into the product, and do not drop onto the screen with something.

**14** **CAUTION** concerning the Power Cord :  
It is recommend that appliances be placed upon a dedicated circuit; that is, a single outlet circuit which powers only that appliance and has no additional outlets or branch circuits. Check the specification page of this owner's manual to be certain. Do not connect too many appliances to the same AC power outlet as this could result in fire or electric shock.

Do not overload wall outlets. Overloaded wall outlets, loose or damaged wall outlets, extension cords, frayed power cords, or damaged or cracked wire insulation are dangerous. Any of these conditions could result in electric shock or fire. Periodically examine the cord of your appliance, and if its appearance indicates damage or deterioration, unplug it, discontinue use of the appliance, and have the cord replaced with an exact replacement part by an authorized servicer. Protect the power cord from physical or mechanical abuse, such as being twisted, kinked, pinched, closed in a door, or walked upon. Pay particular attention to plugs, wall outlets, and the point where the cord exits the appliance.

Do not make the TV with the power cord plugged in. Do not use a damaged or loose power cord. Be sure do grasp the plug when unplugging the power cord. Do not pull on the power cord to unplug the TV.

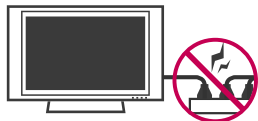

**15** **WARNING** - To reduce the risk of fire or electrical shock, do not expose this product to rain, moisture or other liquids. Do not touch the TV with wet hands. Do not install this product near flammable objects such as gasoline or candles or expose the TV to direct air conditioning.



**16** Do not expose to dripping or splashing and do not place objects filled with liquids, such as vases, cups, etc. on or over the apparatus (e.g. on shelves above the unit).



## **17** **GROUNDING**

Ensure that you connect the earth ground wire to prevent possible electric shock. (i.e. a TV with a three-prong grounded AC plug must be connected to a three-prong grounded AC outlet) If grounding methods are not possible, have a qualified electrician install a separate circuit breaker.

Do not try to ground the unit by connecting it to telephone wires, lightening rods, or gas pipes.

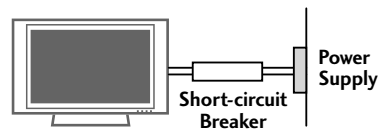

## **18** **DISCONNECTING DEVICE FROM MAINS**

Mains plug is the disconnecting device. The plug must remain readily operable.

**19** Keep the product away from direct sunlight.

## 20 ANTENNAS

### Outdoor antenna grounding

If an outdoor antenna is installed, follow the precautions below. An outdoor antenna system should not be located in the vicinity of overhead power lines or other electric light or power circuits, or where it can come in contact with such power lines or circuits as death or serious injury can occur.

Be sure the antenna system is grounded so as to provide some protection against voltage surges and built-up static charges.

Section 810 of the National Electrical Code (NEC) in the U.S.A. provides information with respect to proper grounding of the mast and supporting structure, grounding of the lead-in wire to an antenna discharge unit, size of grounding conductors, location of antenna discharge unit, connection to grounding electrodes and requirements for the grounding electrode.

### Antenna grounding according to the National Electrical Code, ANSI/NFPA 70

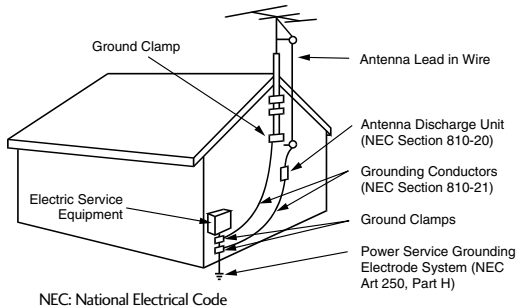

## 21 Cleaning

When cleaning, unplug the power cord and scrub gently with a soft cloth to prevent scratching. Do not spray water or other liquids directly on the TV as electric shock may occur. Do not clean with chemicals such as alcohol, thinners or benzene.

## 22 Moving

Make sure the product is turned off, unplugged and all cables have been removed. It may take 2 or more people to carry larger TVs. Do not press against or put stress on the front panel of the TV.

## 23 Ventilation

Install your TV where there is proper ventilation. Do not install in a confined space such as a bookcase. Do not cover the product with cloth or other materials (e.g.) plastic while plugged in. Do not install in excessively dusty places.

## 24

If you smell smoke or other odors coming from the TV or hear strange sounds, unplug the power cord contact an authorized service center.

## 25

Do not press strongly upon the panel with a hand or sharp object such as nail, pencil or pen, or make a scratch on it.

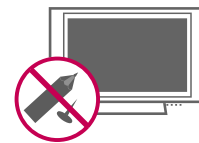

# CONTENTS

<b>WARNING / CAUTION</b> .....	1
<b>SAFETY INSTRUCTIONS</b> .....	2
<b>FEATURES OF THIS TV</b> .....	6

## PREPARATION

Accessories .....	7
Front Panel Information .....	8
Back Panel Information .....	9
Stand Instruction .....	11
Cable Management .....	12
Desktop Pedestal Installation .....	13
Swivel Stand .....	13
Attaching the TV to a desk .....	13
VESA Wall Mounting .....	14
Securing the TV to the wall to prevent falling When the TV is used on a stand .....	15
Antenna or Cable Connection .....	16

## EXTERNAL EQUIPMENT SETUP

HD Receiver Setup .....	17
DVD Setup .....	20
VCR Setup .....	22
Other A/V Source Setup .....	24
Pillow Speaker Setup .....	25
PC Setup .....	26

## WATCHING TV / CHANNEL CONTROL

Remote Control Functions .....	32
Turning On TV .....	34
Channel Selection .....	35
Volume Adjustment .....	35
On-Screen Menus Selection .....	36
Channel Setup	
- Auto Scan (Auto Tuning) .....	37
- Add / Delete Channel (Manual Tuning) .....	38
- Channel Editing .....	39
Channel Label .....	40
Input List .....	41

## PICTURE CONTROL

Picture Size (Aspect Ratio) Control .....	42
Preset Picture Settings	
- Picture Mode - Preset .....	45
- Color Tone - Preset .....	46

Manual Picture Adjustment	
- Picture Mode - User Mode .....	47
- Picture Mode - Expert Control .....	48
Picture Improvement Settings .....	49
Advanced Control - Black (Darkness) Level .....	50
Advanced Control - Real Cinema .....	51
Picture Reset .....	52

## SOUND & LANGUAGE CONTROL

Auto Volume Leveler (Auto Volume) .....	53
Clear Voice .....	54
Preset Sound Settings (Sound Mode) .....	55
Sound Setting Adjustment - User Mode .....	56
Balance .....	58
TV Speakers On/Off Setup .....	59
Audio Reset .....	60
Stereo/SAP Broadcast Setup .....	61
Audio Language .....	62
On-Screen Menus Language Selection .....	63
Caption Mode	
- Analog Broadcasting System Captions .....	64
- Digital Broadcasting System Captions .....	65
- Caption Option .....	66

## TIME SETTING

Clock Setting	
- Auto Clock Setup .....	67
- Manual Clock Setup .....	68
Auto On/Off Time Setting .....	69
Sleep Timer Setting .....	70
Auto Shut-off Setting .....	71

## PARENTAL CONTROL / RATINGS

Set Password & Lock System .....	72
Channel Blocking .....	75
Movie & TV Rating .....	76
Downloadable Rating .....	79
External Input Blocking .....	80

## APPENDIX

Troubleshooting .....	81
Maintenance .....	83
Product Specifications .....	83
IR Codes .....	84

# FEATURES OF THIS TV



HDMI™, the HDMI logo and High-Definition Multimedia Interface are trademarks or registered trademarks of HDMI Licensing.”



Manufactured under license from Dolby Laboratories. “Dolby” and the double-D symbol are trademarks of Dolby Laboratories.



USB port shall be used for software update by service personnel only.



is a trademark of SRS Labs, Inc.

TruSurround XT technology is incorporated under license from SRS Labs, Inc.

## FOR LCD TV

- If the TV feels cold to the touch, there may be a small “flicker” when it is turned on. This is normal, there is nothing wrong with TV.
- Some minute dot defects may be visible on the screen, appearing as tiny red, green, or blue spots. However, they have no adverse effect on the monitor’s performance.
- Avoid touching the LCD screen or holding your finger(s) against it for long periods of time. Doing so may produce some temporary distortion effects on the screen.

## On Disposal

The fluorescent lamp used in this product contains a small amount of mercury. Do not dispose of this product with general household waste. Disposal of this product must be carried out in accordance to the regulations of your local authority.

# PREPERATION

## ACCESSORIES

Ensure that the following accessories are included with your TV. If an accessory is missing, please contact the dealer where you purchased the TV.

The accessories included may differ from the images below.

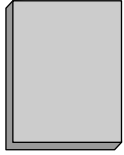

Owner's Manual

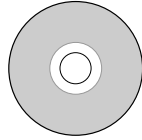

CD Manual



Power Cord

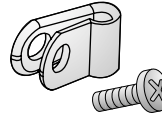

Protective Bracket and Bolt for Power Cord  
(Refer to P.12)

(This feature is not available for all models.)

26/32LG3DCH, 32LG3DC only

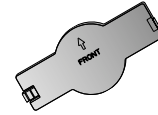

Protection Cover  
(Refer to P.11)

22LG3DCH only



Cable Management Clip  
(Refer to P.12)

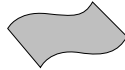

Polishing Cloth

(This feature is not available for all models.)

\* Wipe spots on the exterior only with the polishing cloth.

\* Do not wipe roughly when removing stains. Excessive pressure may cause scratches or discoloration.

32LG3DC only

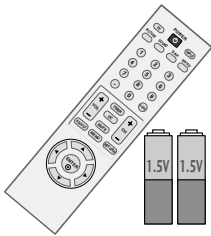

Remote Control, Batteries



x 4

M4xL26

(Machine Screw)



x 4

Ø4xL20

(Plastic Screw)

Bolts for stand assembly  
(Refer to P.11)



x 2

M4xL22

(Machine Screw)

Torx plus Star head screw  
(Refer to P.11)

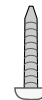

Ø4xL20

(Plastic Screw)

Screw for stand fixing  
(Refer to P.13)

Optional Installer Remote Control for Model No. Series 22/26/32LG3DCH

There is an optional Installer remote control available for the 22/26/32LG3DCH models. The installer remote control is NOT included with the TV.

Option Extras

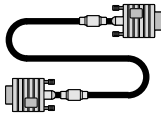

D-sub 15 pin Cable

When using the VGA (D-sub 15 pin cable) PC connection, the user must use shielded signal interface cables with ferrite cores to maintain standards compliance.

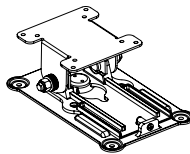

Wall Mounting Bracket  
(RW120)  
(Only 22LG3DCH)

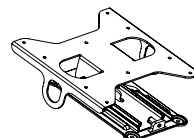

Wall Mounting Bracket  
(RW230)  
(Only 26LG3DCH)

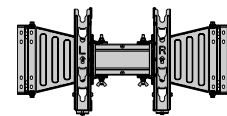

Tilt Wall Mounting Bracket  
(AW-47LG30M)  
(Only 32LG3DCH)

# PREPARATION

PREPARATION

## FRONT PANEL INFORMATION

- Image shown may differ from your TV.
- NOTE:** If your TV has a protection tape attached, remove the tape. And then wipe the TV with a cloth (If a polishing cloth is included with your TV, use it).

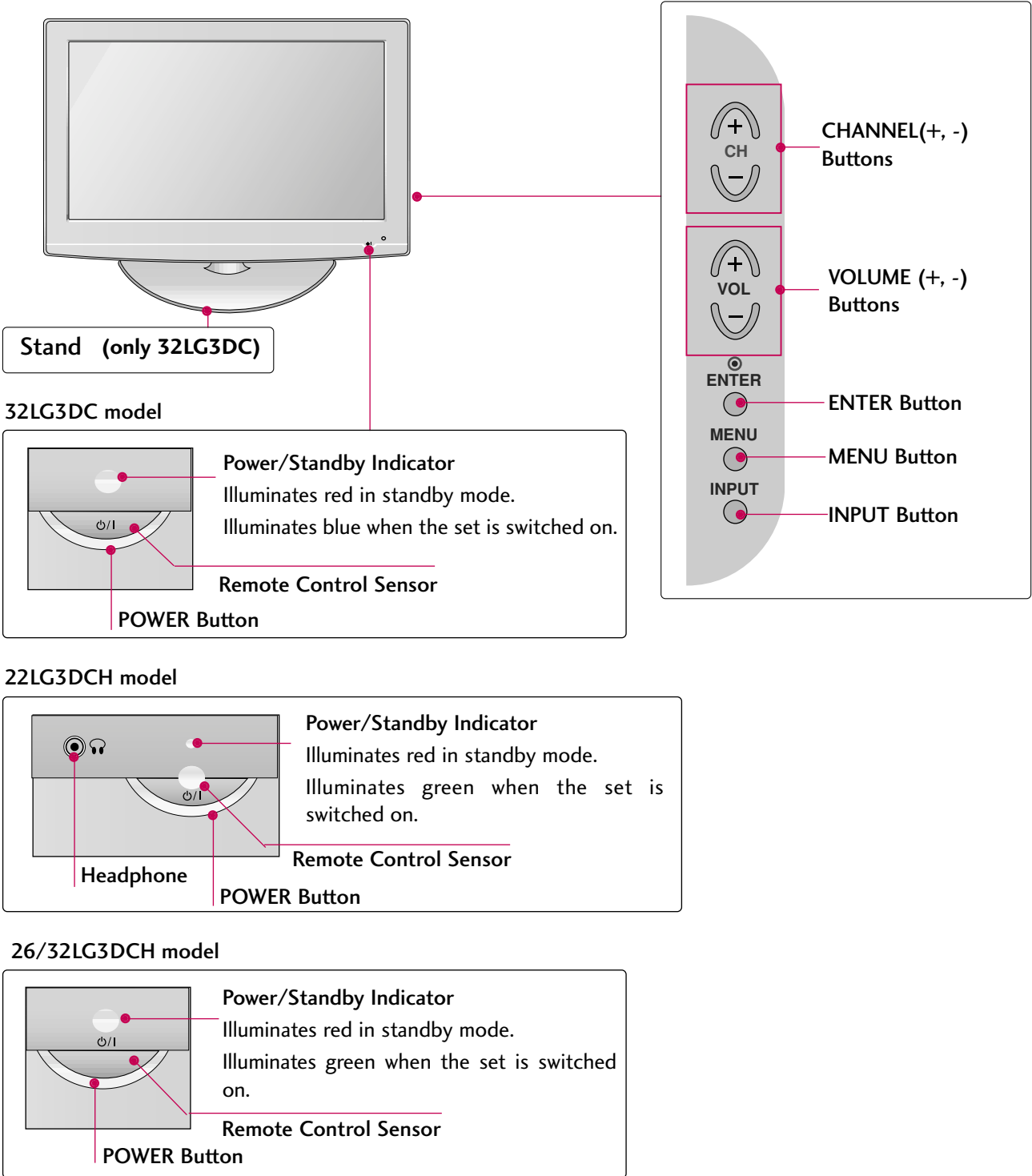

# BACK PANEL INFORMATION

■ Image shown may differ from your TV.

For 32LG3DC  
26/32LG3DCH

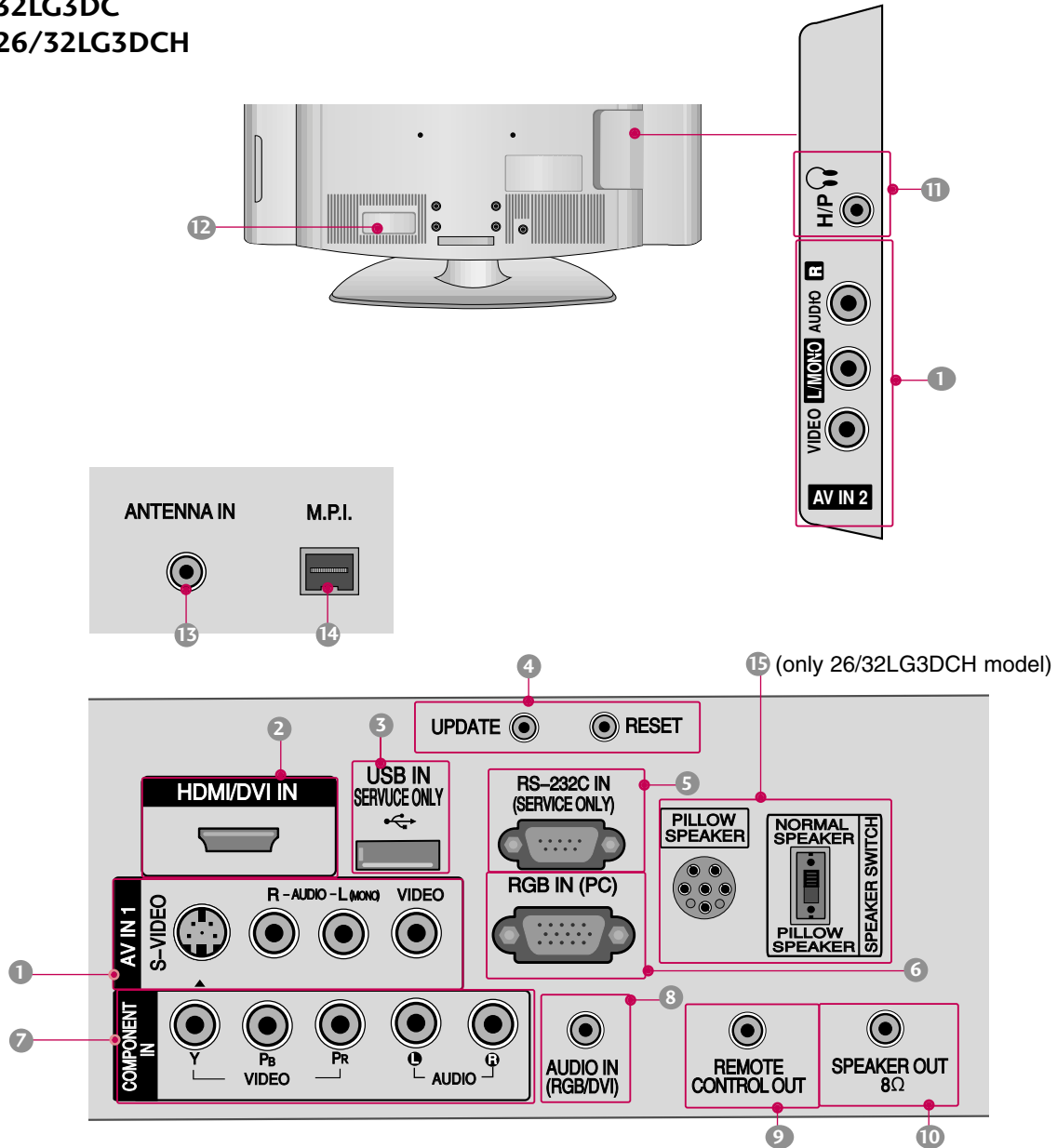

# PREPARATION

## For 22LG3DCH

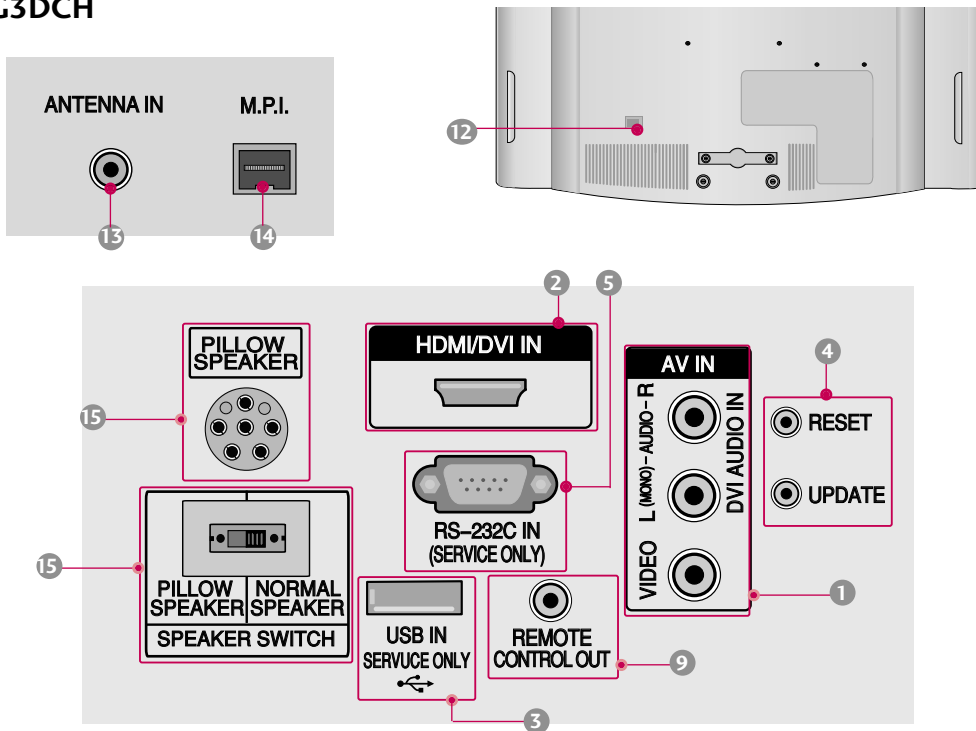

- 1 AV (Audio/Video) IN**  
Analog composite connection. Supports standard definition video only (480i).  
Used for PC/DTV audio input jack (Only 22LG3DCH-UA model).  
**S-VIDEO (Except 22LG3DCH model)**  
Better quality than standard composite (yellow RCA cable). Supports standard definition video only (480i).
- 2 HDMI/DVI IN**  
Digital Connection. Supports HD video and Digital audio.  
Accepts DVI video using an adapter or HDMI to DVI cable (not included).
- 3 USB IN SERVICE ONLY**  
Used for software updates.
- 4 UPDATE**  
Software downloads and debug mode enable/disable.  
**RESET**  
Hardware reset to PTC microcontroller.
- 5 RS-232C IN (SERVICE ONLY)**  
Used for software updates.
- 6 RGB IN (PC) (Except 22LG3DCH model)**  
Analog PC Connection. Uses a D-sub 15 pin cable (VGA cable).
- 7 COMPONENT IN (Except 22LG3DCH model)**  
Analog Connection.  
Supports HD.  
Uses a red, green, and blue cable for video & a red and white cable for audio.
- 8 AUDIO IN (RGB/DVI) (Except 22LG3DCH model)**  
1/8" headphone jack for analog PC audio input.
- 9 REMOTE CONTROL OUT**  
IR output for controlling an auxiliary device.
- 10 SPEAKER OUT 8Ω (Except 22LG3DCH model)**
- 11 H/P**  
Plug the headphone into the headphone socket.
- 12 Power Cord Socket**  
For operation with AC power.  
Caution: Never attempt to operate the TV on DC power.
- 13 ANTENNA IN**  
Connect over-the air signals to this jack.
- 14 M.P. I.**
- 15 PILLOW SPEAKER (Except 32LG3DC model)**  
Used to connect to pillow speaker.  
**SPEAKER SWITCH (Except 32LG3DC model)**  
Used to select the speaker output switch.  
Note: If Pillow Speaker is selected, no Sound will be heard from TV speakers.  
(NORMAL SPEAKER or PILLOW SPEAKER)

## STAND INSTRUCTION

▪ Image shown may differ from your TV.

### INSTALLATION (Only 32LG3DC)

- 1 Carefully place the TV screen side down on a cushioned surface to protect the screen from damage.

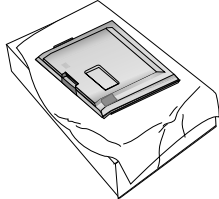

- 2 Assemble the parts of the **STAND BODY** with **COVER BASE** of the TV.

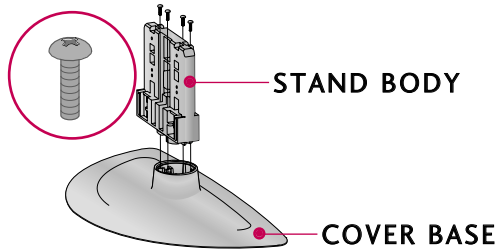

- 3 Insert the stand as shown.

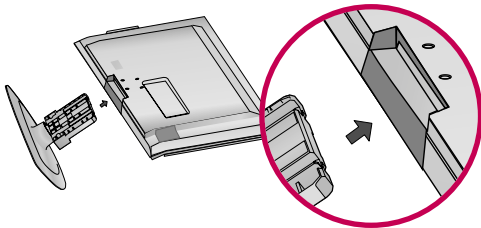

- 4 Tighten the stand with the four screws (provided as parts of the TV).

or

Tighten the two of these four screws and the two Torx plus star head screws (provided as parts of the TV) to secure the TV. Tighten the two Torx plus star head screws with a star head driver (not provided as parts of the TV).

### ! NOTE

- ▶ Make sure the screws in the stand are fully tightened. (If not tightened fully, the product could tilt forward and fall). But do not over tighten, over-tightening can damage the threads on the screws.

### DETACHMENT (Only 32LG3DC)

- 1 Carefully place the TV screen side down on a cushioned surface to protect the screen from damage.

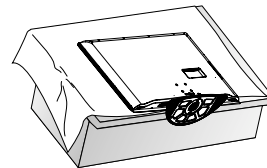

- 2 Remove the four screws that hold the base on.

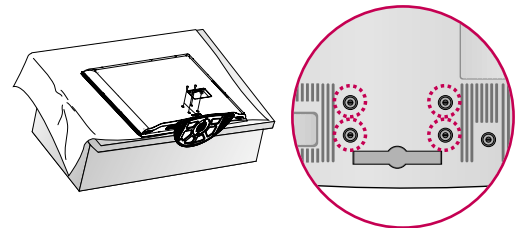

- 3 Detach the stand from TV.

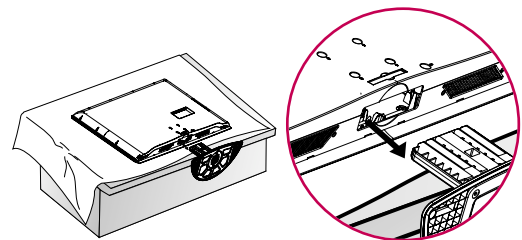

### PROTECTION COVER (Except 22LG3DCH)

After removing the stand, install the included **protection cover** over the hole for the stand.

Press the **PROTECTION COVER** into the TV until you hear it click.

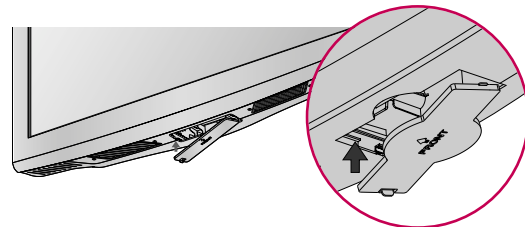

# PREPARATION

## CABLE MANAGEMENT

■ Image shown may differ from your TV.

For 26/32LG3DCH, 32LG3DC

- 1 Connect the cables as necessary.  
To connect additional equipment, see the **EXTERNAL EQUIPMENT SETUP** section. Secure the power cable with the **PROTECTIVE BRACKET** and the screw as shown. It will help prevent the power cable from being removed by accident.

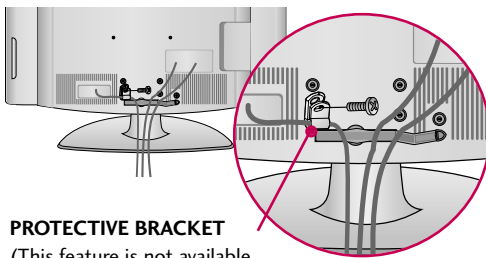

**PROTECTIVE BRACKET**  
(This feature is not available for all models.)

- 2 Install the **CABLE MANAGEMENT CLIP** as shown.

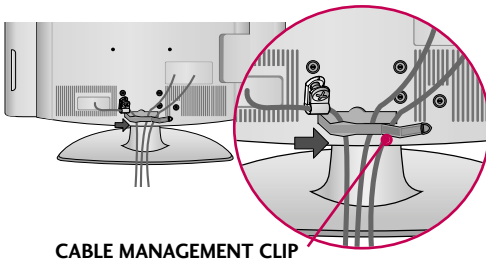

**CABLE MANAGEMENT CLIP**

- 3 Put the cables inside the **CABLE MANAGEMENT CLIP** and snap it closed.

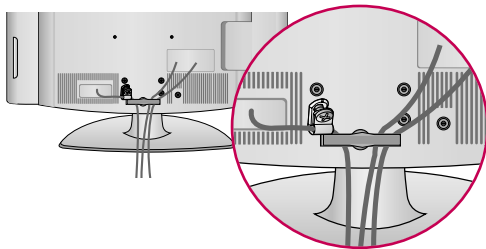

For 22LG3DCH

- 1 Connect the cables as necessary.  
To connect additional equipment, see the **EXTERNAL EQUIPMENT SETUP** section. Secure the power cable with the **PROTECTIVE BRACKET** and the screw as shown. It will help prevent the power cable from being removed by accident.

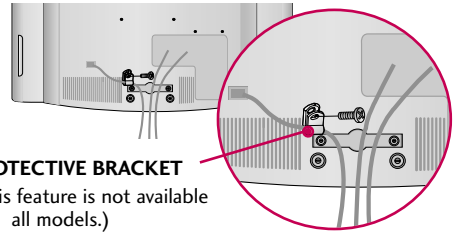

**PROTECTIVE BRACKET**  
(This feature is not available for all models.)

- 2 Install the **CABLE MANAGEMENT CLIP** as shown.

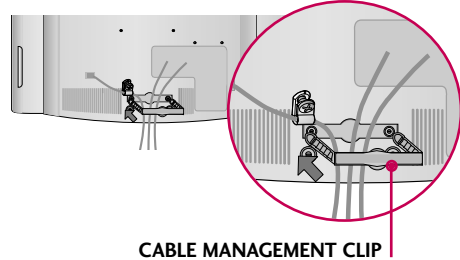

**CABLE MANAGEMENT CLIP**

- 3 Fit the **CABLE MANAGEMENT CLIP** as shown.

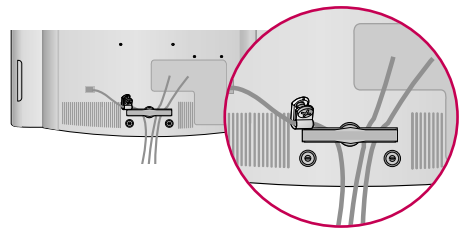

### How to remove the **CABLE MANAGEMENT CLIP**

- ▶ Hold the **CABLE MANAGEMENT CLIP** with both hands and pull it backward.

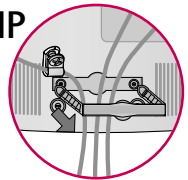

### ! NOTE

- ▶ Do not hold the **CABLE MANAGEMENT CLIP** when moving the TV.  
- If the TV is dropped, you may be injured or the product may be broken.

## DESKTOP PEDESTAL INSTALLATION

- Image shown may differ from your TV.
- \* This feature is not available for all models.

For proper ventilation, allow a clearance of 4 inches on all four sides.

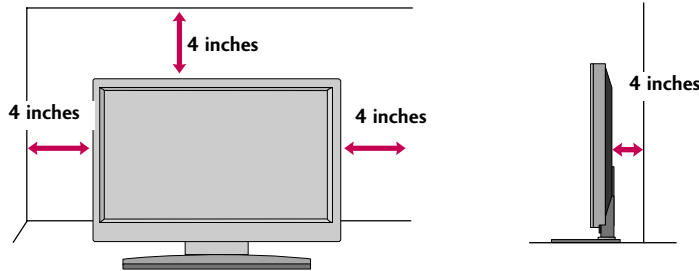

- ⚠ CAUTION**
- ▶ Ensure adequate ventilation by following the clearance recommendations.
  - ▶ Do not mount near or above any type of heat source.

## SWIVEL STAND (Only 32LG3DC)

The TV can be conveniently swivelled on its stand 90° to the left or right to provide the optimum viewing angle.

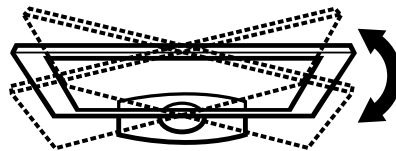

## ATTACHING THE TV TO A DESK (Only 32LG3DC)

The TV must be attached to a desk so it cannot be pulled in a forward/backward direction, potentially causing injury or damaging the product. Use only the included screw.

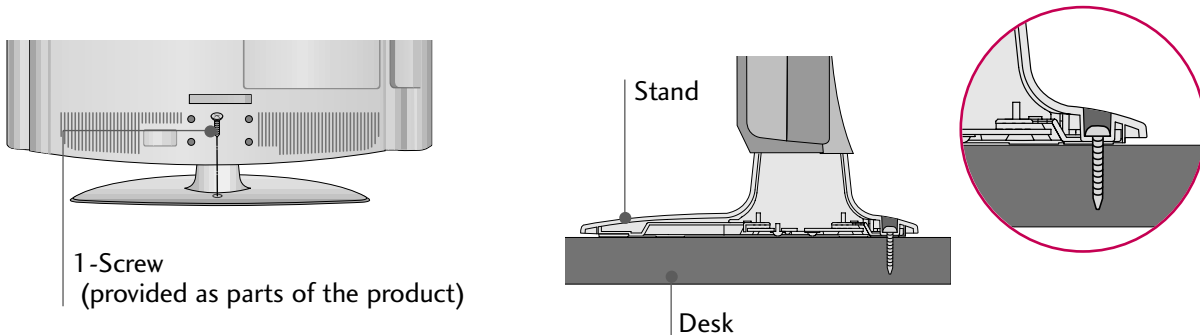

- ⚠ WARNING**
- ▶ To prevent TV from falling over, the TV should be securely attached to the floor/wall per installation instructions. Tipping, shaking, or rocking the TV may cause injury.

# PREPARATION

## VESA WALL MOUNTING

Install your wall mount on a solid wall perpendicular to the floor. When attaching to other building materials, please contact your nearest dealer.

If installed on a ceiling or slanted wall, it may fall and result in severe personal injury.

We recommend that you use an LG brand wall mount when mounting the TV to a wall.

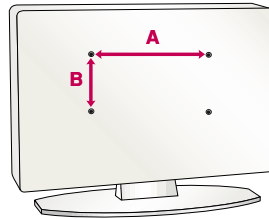

Product	Model	VESA (A * B)	Standard Screw	Quantity
LCD TV	26LG3DCH, 32LG3DCH 32LG3DC	200 * 100	M4	4
	22LG3DCH	100 * 100	M4	4

### NOTE

- ▶ Screw length needed depends on the wall mount used. For further information, refer to the instructions included with the mount.
- ▶ Standard dimensions for wall mount kits are shown in the table.
- ▶ When purchasing our wall mount kit, a detailed installation manual and all parts necessary for assembly are provided.
- ▶ Do not use screws longer than the standard dimension, as they may cause damage to the inside to the TV.
- ▶ For wall mounts that do not comply with the VESA standard screw specifications, the length of the screws may differ depending on their specifications.
- ▶ Do not use screws that do not comply with the VESA standard screw specifications.
- ▶ Do not tighten the screws too much. It may damage the TV or allow the TV to fall and cause personal injury. LG is not liable for these kinds of accidents.
- ▶ LG is not liable for TV damage or personal injury when a non-VESA or non specified wall mount is used or the consumer fails to follow the TV installation instructions.

### CAUTION

- ▶ Do not install your wall mount kit while the TV is plugged in. It may result in personal injury due to electric shock.

### WARNING

- ▶ To prevent injury, this apparatus must be securely attached to the wall in accordance with the installation instructions.

## SECURING THE TV TO THE WALL TO PREVENT FALLING WHEN THE TV IS USED ON A STAND

- You should purchase necessary components to prevent TV from falling off of the stand.
- Image shown may differ from your TV.
- \* This feature is not available for all models.

We recommend that you set the TV close to a wall so it cannot fall over if pushed backwards.

Additionally, we recommend that the TV be attached to a wall so it cannot be pulled in a forward direction, potentially causing injury or damaging the product.

Caution: Please make sure that children don't climb on or hang from the TV.

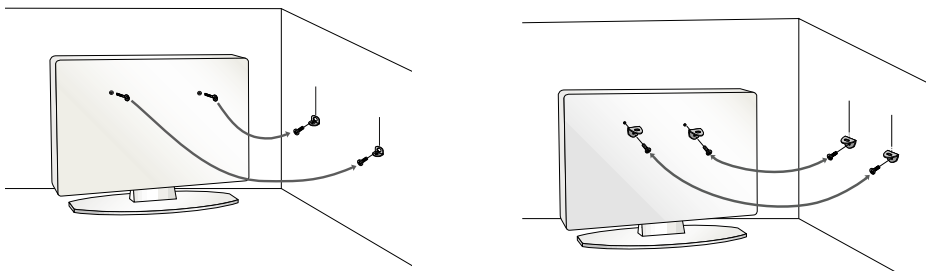

- Insert eye-bolts (or TV brackets and bolts) to attach the product to the wall as shown in the picture.
    - \* If your product has the bolts in the eye-bolts position before inserting the eye-bolts, loosen the bolts.
    - \* Insert the eye-bolts or TV brackets/bolts and tighten them securely in the upper holes.
- Secure the wall brackets with screws (sold separately) to the wall. Match the height of the bracket that is mounted on the wall to the holes in the product.
- Ensure the eye-bolts or brackets are tightened securely.

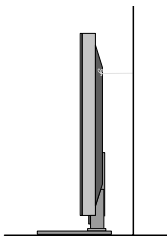

- Use a sturdy rope or cord (sold separately) to tie the product. It is safer to tie the rope so it becomes horizontal between the wall and the product (the less slack in the rope, the better).

### ! NOTE

- ▶ Use a platform or cabinet strong enough and large enough to support the size and weight of the TV.
- ▶ To use the TV safely, make sure that the height of the bracket on the wall and the one on the TV are the same.

# PREPARATION

- To prevent damage do not connect to the power outlet until all connections are made between the devices.

## ANTENNA OR CABLE CONNECTION

PREPARATION

### 1. Antenna (Analog or Digital)

Wall Antenna Socket or Outdoor Antenna without a Cable Box Connection.

For optimum picture quality, adjust the direction if needed.

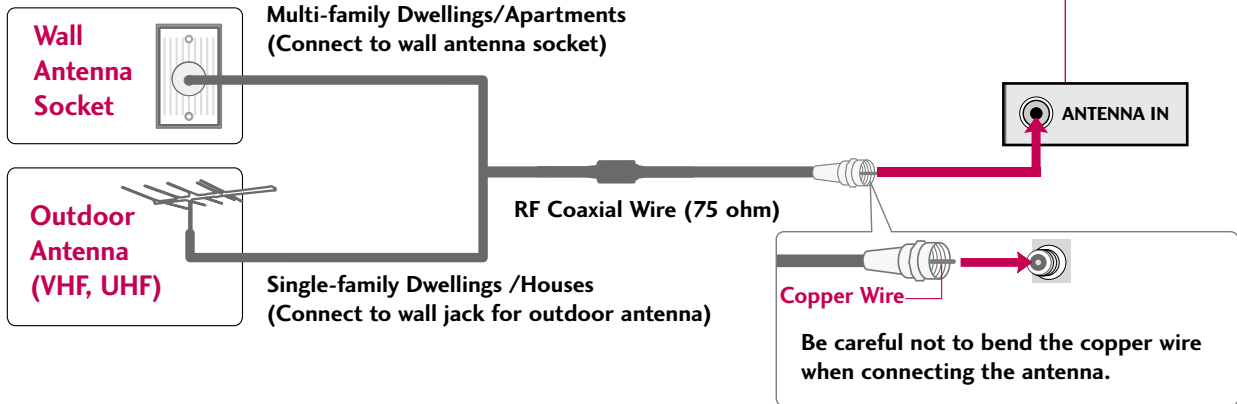

### 2. Cable

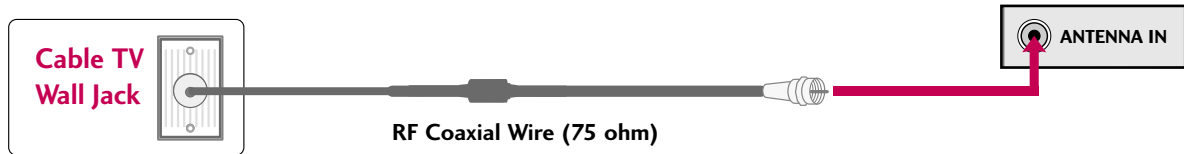

- To improve the picture quality in a poor signal area, please purchase a signal amplifier and install properly.
- If the antenna needs to be split for two TV's, install a 2-Way Signal Splitter.
- If the antenna is not installed properly, contact your dealer for assistance.

# EXTERNAL EQUIPMENT SETUP

- To prevent the equipment damage, never plug in any power cords until you have finished connecting all equipment.
- This part of EXTERNAL EQUIPMENT SETUP mainly uses the picture for 32LG3DC model.

## HD RECEIVER SETUP

This TV can receive Digital Over-the-air or Digital Cable signals without an external digital set-top box. However, if you do receive digital signals from a digital set-top box or other digital external device, refer to the figure as shown below.

### Component Connection (Except 22LG3DCH)

#### 1. How to connect

- 1 Connect the video outputs (Y, PB, PR) of the digital set-top box to the **COMPONENT IN VIDEO** jacks on the TV. Match the jack colors (Y = green, PB = blue, and PR = red).
- 2 Connect the audio output of the digital set-top box to the **COMPONENT IN AUDIO** jacks on the TV.

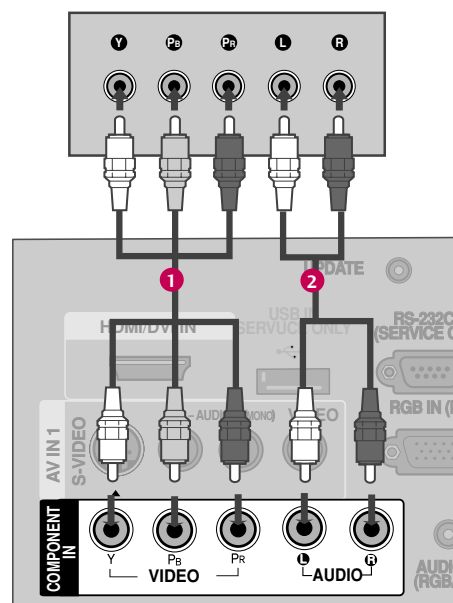

#### 2. How to use

- Turn on the digital set-top box.  
(Refer to the owner's manual for the digital set-top box.)
- Select **Component** input source using the **INPUT** button on the remote control.

#### Supported Resolutions

Signal	Component	HDMI
480i	Yes	Yes
480p	Yes	Yes
720p	Yes	Yes
1080i	Yes	Yes
1080p	No	Yes

#### Y, CB/PB, CR/PR

Resolution	Horizontal Frequency(KHz)	Vertical Frequency(Hz)
720x480i	15.73	59.94
	15.73	60.00
720x480p	31.47	59.94
	31.50	60.00
1280x720p	44.96	59.94
	45.00	60.00
1920x1080i	33.72	59.94
	33.75	60.00

# EXTERNAL EQUIPMENT SETUP

## HDMI Connection

### 1. How to connect

- 1 Connect the digital set-top box to **HDMI/DVI IN** jack on the TV.
- 2 No separate audio connection is necessary. HDMI supports both audio and video.

### 2. How to use

- Turn on the digital set-top box. (Refer to the owner's manual for the digital set-top box.)
- Select **HDMI** input source with using the **INPUT** button on the remote control.

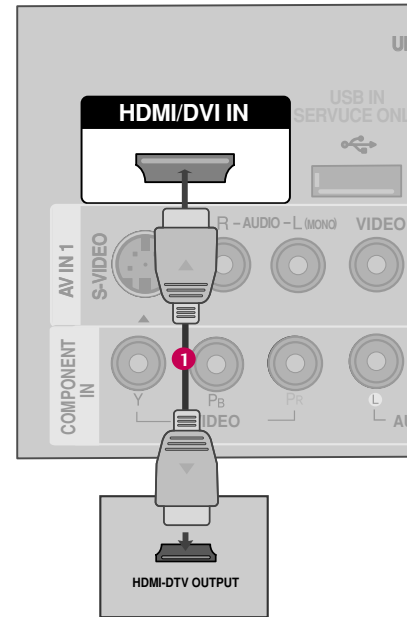

### HDMI-DTV

Resolution	Horizontal Frequency(KHz)	Vertical Frequency(Hz)
720x480i	15.73	59.94
	15.73	60.00
720x480p	31.469	59.94
	31.500	60.00
1280x720p	44.96	59.94
	45.00	60.00
1920x1080i	33.72	59.94
	33.75	60.00
1920x1080p	67.50	60.00

## DVI to HDMI Connection

### 1. How to connect

- 1 Connect the DVI output of the digital set-top box to the **HDMI/DVI IN** jack on the TV.
- 2 Connect the audio output of the digital set-top box to the **AUDIO IN (RGB/DVI)** or **AV IN AUDIO** jack on the TV.

### 2. How to use

- Turn on the digital set-top box. (Refer to the owner's manual for the digital set-top box.)
- Select the **HDMI** input source on the TV using the **INPUT** button on the remote control.

#### NOTE

- ▶ A DVI to HDMI cable or adapter is required for this connection. DVI doesn't support audio, so a separate audio connection is necessary.

#### 26/32LG3DCH, 32LG3DC model

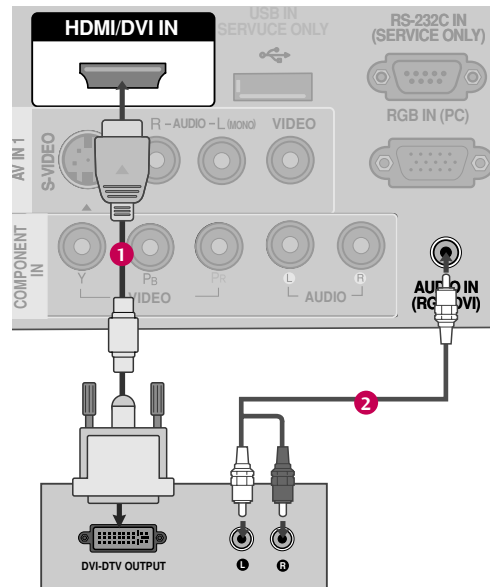

#### 22LG3DCH model

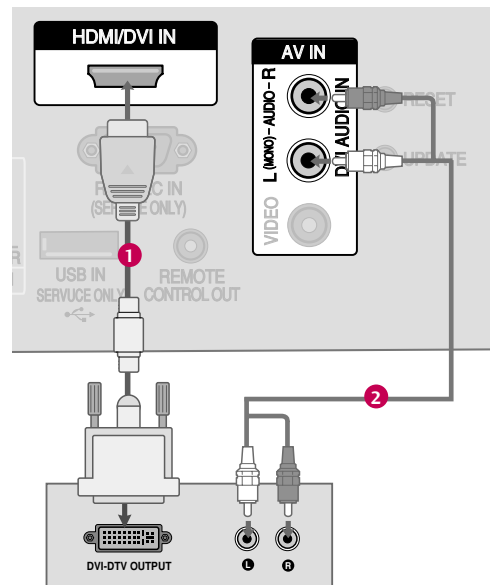

# EXTERNAL EQUIPMENT SETUP

## DVD SETUP

### Component Connection (Except 22LG3DCH)

#### 1. How to connect

- 1
 Connect the video outputs (Y, PB, PR) of the DVD to the **COMPONENT IN VIDEO** jacks on the TV. Match the jack colors (Y = green, PB = blue, and PR = red).
  
- 2
 Connect the audio outputs of the DVD to the **COMPONENT IN AUDIO** jacks on the TV.

#### 2. How to use

- Turn on the DVD player, insert a DVD.
- Select the **Component** input source on the TV using the **INPUT** button on the remote control.
- Refer to the DVD player's manual for operating instructions.

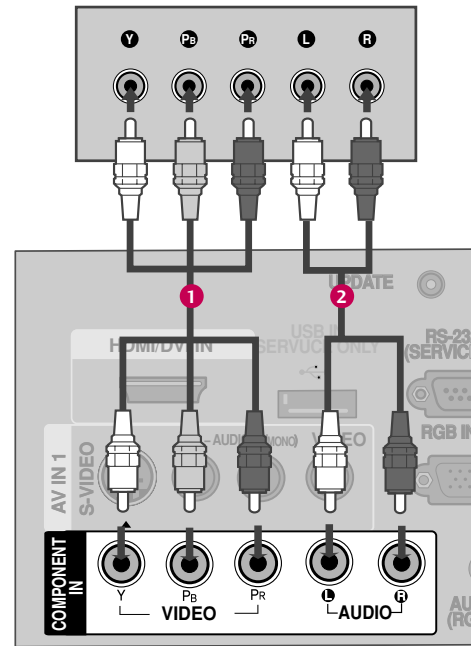

#### Component Input ports

To get better picture quality, connect a DVD player to the component input ports as shown below.

Component ports on the TV	Y	P <sub>B</sub>	P <sub>R</sub>
Video output ports on DVD player	Y	P <sub>B</sub>	P <sub>R</sub>
	Y	B-Y	R-Y
	Y	C <sub>b</sub>	C <sub>r</sub>
	Y	P <sub>b</sub>	P <sub>r</sub>

## S-Video Connection (Except 22LG3DCH)

### 1. How to connect

- 1 Connect the S-VIDEO output of the DVD to the **S-VIDEO** input on the TV.
- 2 Connect the audio outputs of the DVD to the **AUDIO** input jacks on the TV.

### 2. How to use

- Turn on the DVD player, insert a DVD.
- Select the **AV1** input source on the TV using the **INPUT** button on the remote control.
- Refer to the DVD player's manual for operating instructions.

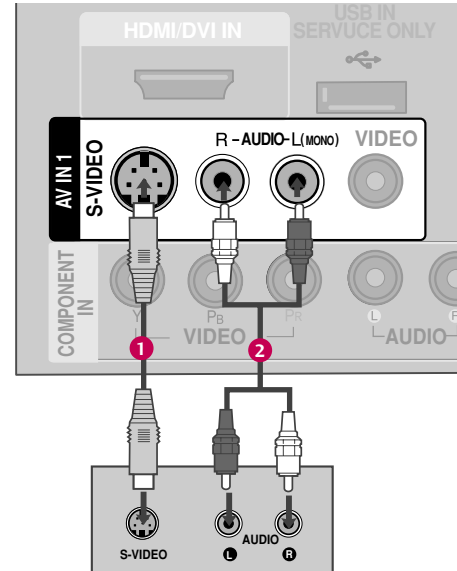

## HDMI Connection

### 1. How to connect

- 1 Connect the HDMI output of the DVD to the **HDMI/DVI IN** jack on the TV.
- 2 No separate audio connection is necessary. HDMI supports both audio and video.

### 2. How to use

- Select the **HDMI** input source on the TV using the **INPUT** button on the remote control.
- Refer to the DVD player's manual for operating instructions.

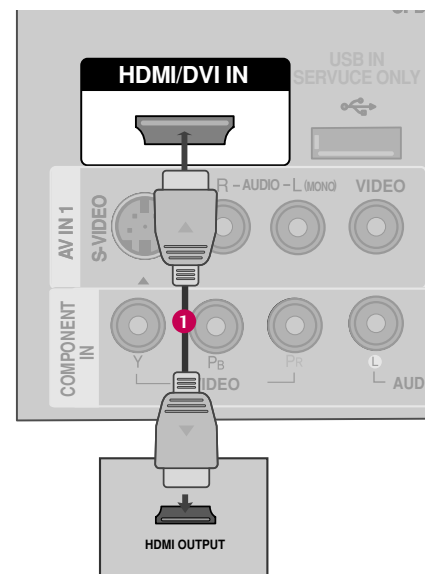

# EXTERNAL EQUIPMENT SETUP

## VCR SETUP

- To avoid picture noise (interference), leave an adequate distance between the VCR and TV.
- If the 4:3 picture format is used; the fixed images on the sides of the screen may remain visible on the screen. This phenomenon is common to all TVs and is not covered by warranty.

### Antenna Connection

#### 1. How to connect

- 1** Connect the RF antenna out socket of the VCR to the **ANTENNA IN** socket on the TV.
- 2** Connect the antenna cable to the RF antenna in socket of the VCR.

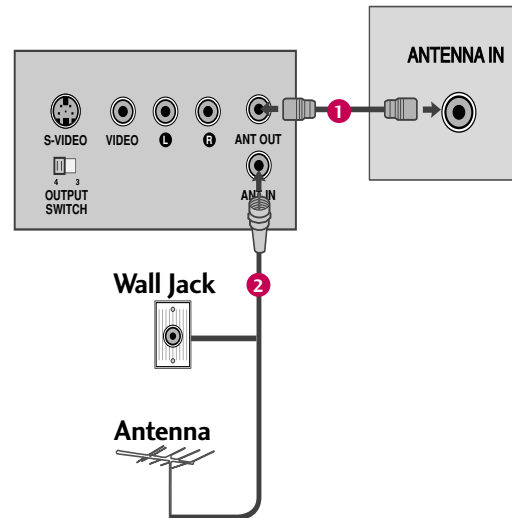

#### 2. How to use

- Set VCR output switch to 3 or 4 and then tune TV to the same channel number.
- Insert a video tape into the VCR and press PLAY on the VCR. (Refer to the VCR owner's manual.)

## Composite (RCA) Connection

### 1. How to connect

- 1 Connect the **AUDIO/VIDEO** jacks between TV and VCR. Match the jack colors (Video = yellow, Audio Left = white, and Audio Right = red)

### 2. How to use

- Insert a video tape into the VCR and press PLAY on the VCR. (Refer to the VCR owner's manual.)
- Select the **AV** or **AV1** input source on the TV using the **INPUT** button on the remote control.
- If connected to **AV IN2**, select **AV2** input source on the TV (Except 22LG3DCH).

#### ! NOTE

- ▶ If you have a mono VCR, connect the audio cable from the VCR to the **AUDIO L(MONO)** jack of the TV.

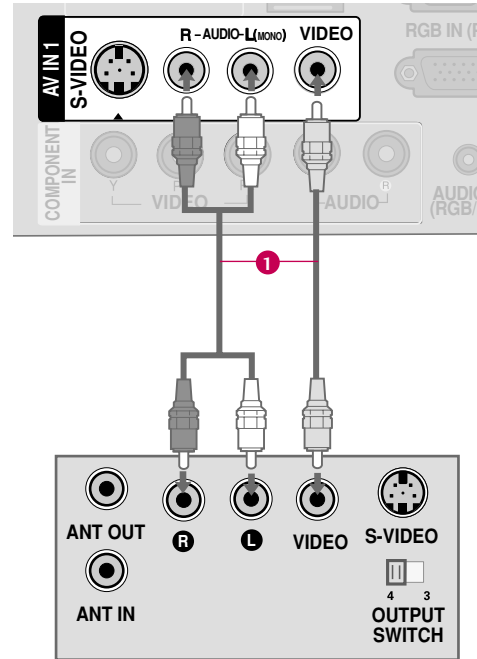

## S-Video Connection (Except 22LG3DCH)

### 1. How to connect

- 1 Connect the **S-VIDEO** output of the VCR to the **S-VIDEO** input on the TV.
- 2 Connect the audio outputs of the VCR to the **AUDIO** input jacks on the TV.

### 2. How to use

- Insert a video tape into the VCR and press PLAY on the VCR. (Refer to the VCR owner's manual.)
- Select the **AV1** input source on the TV using the **INPUT** button on the remote control.

#### ! NOTE

- ▶ S-Video provides better quality than composite. Use it when available.

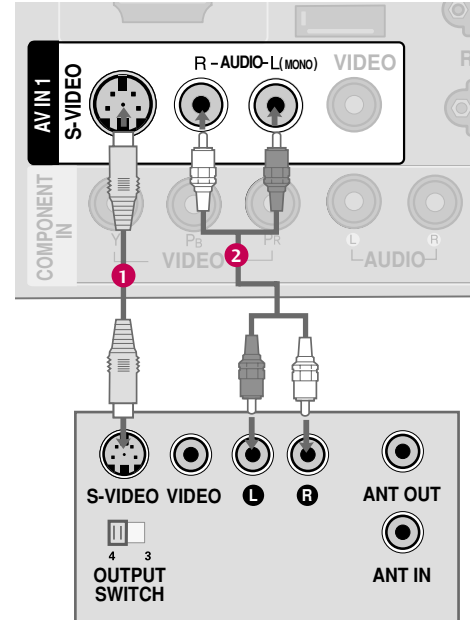

#### ! CAUTION

- ▶ Do not connect to both Video and S-Video at the same time. In the event that you connect both Video and the S-Video cables, only the S-Video will work.

# EXTERNAL EQUIPMENT SETUP

## OTHER A/V SOURCE SETUP

### 1. How to connect

- 1 Connect the **AUDIO/VIDEO** jacks between TV and external equipment. Match the jack colors. (Video = yellow, Audio Left = white, and Audio Right = red)

### 2. How to use

- Select the **AV2** input source on the TV using the **INPUT** button on the remote control. (Except 22LG3DCH)
- If connected to **AV IN** or **AV IN1** input, select the **AV** or **AV1** input source on the TV.
- Operate the corresponding external equipment.

26/32LG3DCH,  
32LG3DC model

Camcorder

Video Game Set

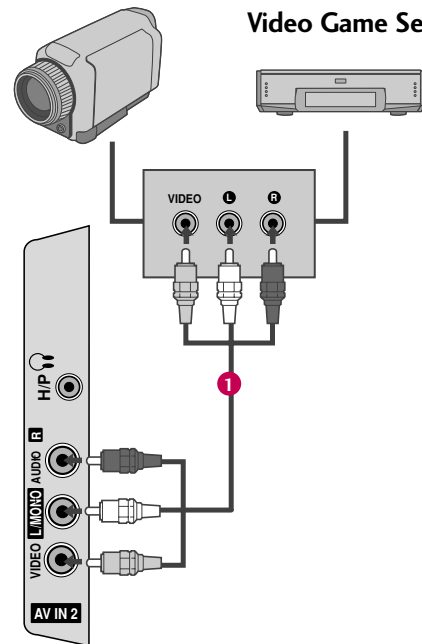

22LG3DCH model

Camcorder

Video Game Set

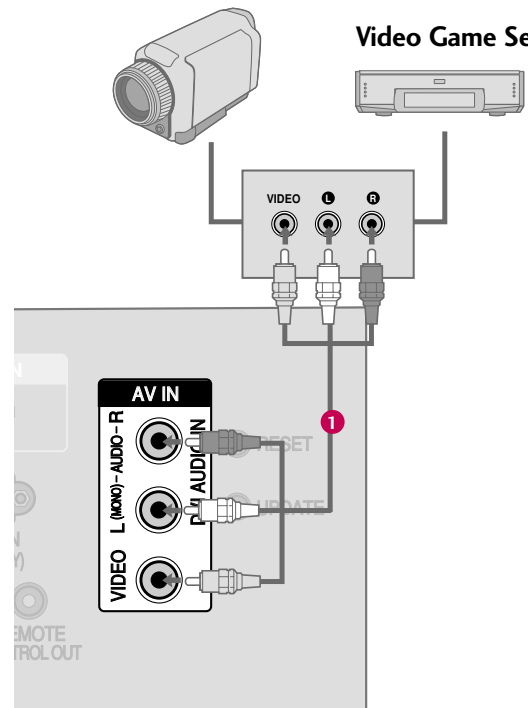

# PILLOW SPEAKER SETUP (Except 32LG3DC)

■ Connect a pillow speaker to the LCD TV/Monitor.

## 1. How to connect

- 1 Connect the **PILLOW SPEAKER** output jack on the back of the TV.
- 2 Connect an accessory pillow speaker or wired remote control unit to this 6-pin jack.
- 3 Select **PILLOW SPEAKER** on the rear panel of the TV.

■ NOTE: If the pillow speaker switch is set to Pillow Speaker, no sound will be heard from the TV speakers. Also, Auto Volume will be grayed out and not accessible on the Sound menu.

Use a pillow speaker that is a UL recognized pendant control bearing the warning:

“Risk of fire if used in oxygen enriched atmosphere. Keep pendant control away from oxygen equipment.”

### Controlling the TV with Serial Data

The TV is capable of being controlled by a single-wire, serial data signal. This is a LG patented technology and is being implemented by certain brands of “smart” pillow speakers.

### Pillow Speaker Interface

This connector furnishes three control lines and an audio output. A patient-pendant remote control, or entertainment audio and nurse call system may be connected here. All lines are isolated from the AC power line and earth ground. (Optoisolators isolate the control lines, and a transformer isolates the audio. There are no relays or inductive components in the control lines.)

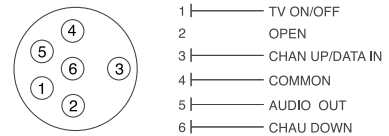
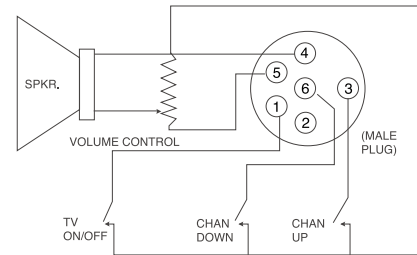
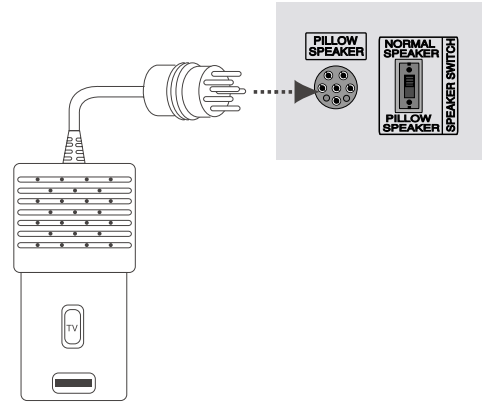

pin No.	Purpose
1	External TV On/Off switch.
2	(Not used.)
3	External Channel Up switch or Data in.
4	Common connection for control, data, and audio output. Impedance to earth ground is a 10-meg resistor in parallel with a 1100 pf capacitor.
5	Isolated audio output. Nominal 14-ohm source impedance with short circuit protection. Intended for a pillow speaker with a low-impedance pad-type volume control.
6	External Channel Down switch.

### Controlling the TV with Mechanical Switches

Pin 4 (common) is momentarily connected to pin 1, 3, or 6 via push-action switches to control On/Off and Channel Up/Down. These pins are at +13volts DC (when measured from pin 4) with the switches open. Current draw is 8 mA when a switch is closed. (This operation is identical to previous LG models using the 5-Wire Interface except that only +7 volts DC was supplied and current draw was only 2.5 mA.)

# EXTERNAL EQUIPMENT SETUP

## PC SETUP

This TV provides Plug and Play capability, meaning that the PC adjusts automatically to the TV's settings.

### VGA (D-Sub 15 pin) Connection (Except 22LG3DCH)

#### 1. How to connect

- 1 Connect the VGA output of the PC to the **RGB IN(PC)** jack on the TV.
- 2 Connect the PC audio output to the **AUDIO IN (RGB/DVI)** jack on the TV.

#### 2. How to use

- Turn on the PC and the TV.
- Select the **RGB** input source on the TV using the **INPUT** button on the remote control.

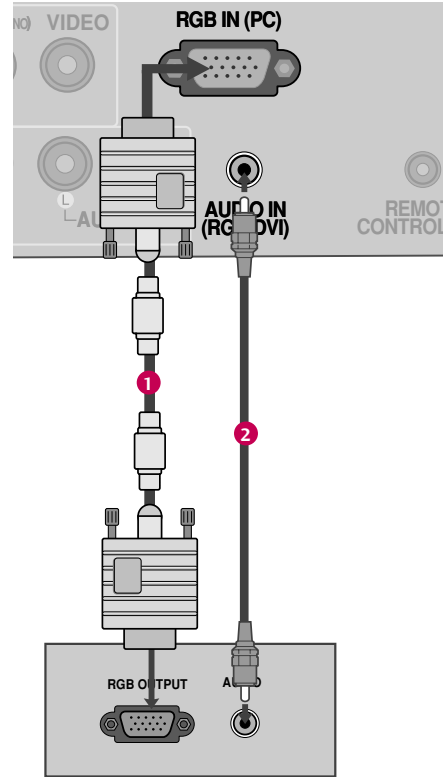

### Supported Display Specifications (RGB-PC, HDMI-PC)

Resolution	Horizontal Frequency(KHz)	Vertical Frequency(Hz)
640x350	31.469	70.08 ●
720x400	31.469	70.08 ●
640x480	31.469	59.94
800x600	37.879	60.31
1024x768	48.363	60.00
1280x768	47.776	59.87
1360x768	47.712	60.01
	47.720	59.799
1366x768	47.130	59.65

\* Only RGB-PC mode

#### ! NOTES

- ▶ To get the the best picture quality, adjust the PC graphics card to 1360x768.
- ▶ Depending on the graphics card, DOS mode may not work if a HDMI to DVI Cable is in use.
- ▶ In PC mode, there may be noise associated with the resolution, vertical pattern, contrast or brightness. If noise is present, change the PC output to another resolution, change the refresh rate to another rate or adjust the brightness and contrast on the PICTURE menu until the picture is clear.
- ▶ Avoid keeping a fixed image on the screen for a long period of time. The fixed image could become permanently imprinted on the screen.
- ▶ The synchronization input form for Horizontal and Vertical frequencies is separate.
- ▶ Depending on the graphics card, some resolution settings may not allow the image to be positioned on the screen properly.

## DVI to HDMI Connection

### 1. How to connect

- 1 Connect the DVI output of the PC to the **HDMI/DVI IN** jack on the TV.
- 2 Connect the PC audio output to the **AUDIO IN (RGB/DVI)** or **AV IN AUDIO** jack on the TV.

### 2. How to use

- Turn on the PC and the TV.
- Select the **HDMI** input source on the TV using the **INPUT** button on the remote control.

#### 26/32LG3DCH, 32LG3DC model

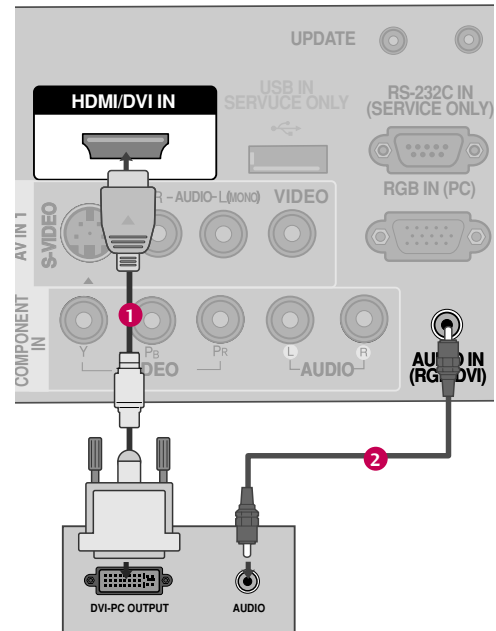

#### 22LG3DCH model

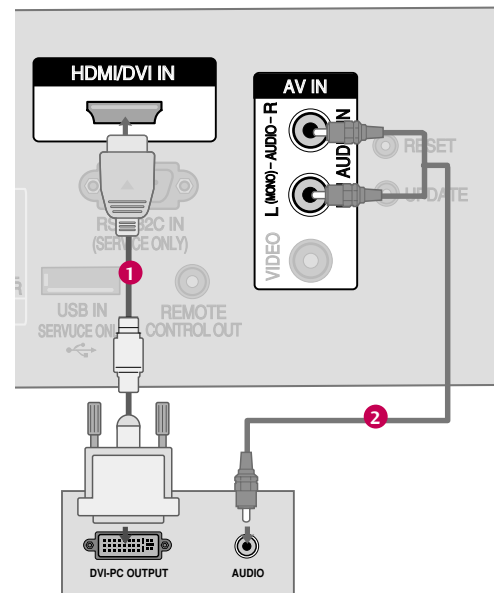

# EXTERNAL EQUIPMENT SETUP





## Screen Setup for PC mode (Except 22LG3DCH)

### Selecting Resolution

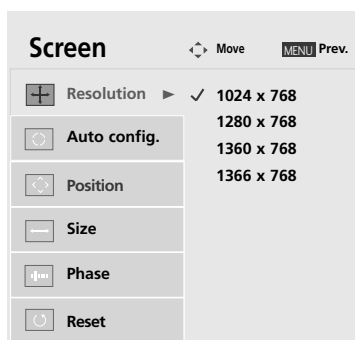
You can choose the resolution in RGB mode.

The **Position**, **Phase**, and **Size** can also be adjusted.





-  Press the **ADJUST** button.
-  Select **Resolution**.
-  Select the desired resolution.
-  Return to TV viewing.

■ You can also adjust **Screen(RGB-PC)** in the **PICTURE** menu.

## Auto Configure

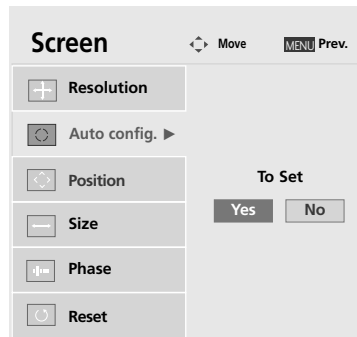
Automatically adjusts picture position and minimizes image instability. After adjustment, if the image is still not correct, try using the manual settings or a different resolution or refresh rate on the PC.



1  Press the **ADJUST** button.

2  Select **Auto config.**

3   Select **Yes**.

4  Start Auto Configuration.

- If the position of the image is still not correct, try Auto adjustment again.
- If picture needs to be adjusted again after Auto adjustment in RGB, you can adjust the **Position**, **Size** or **Phase**.





# EXTERNAL EQUIPMENT SETUP

## Adjustment for screen Position, Size, and Phase

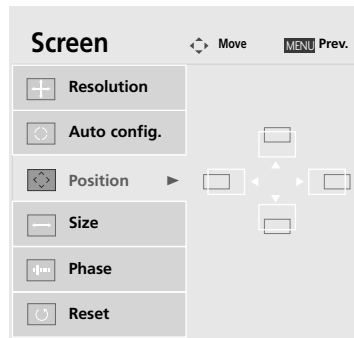
If the picture is not clear after auto adjustment and especially if characters are still trembling, adjust the picture phase manually.

This feature operates only in RGB mode.

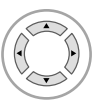



-  Press the **ADJUST** button.
-  Select **Position**, **Size**, or **Phase**.
-   Make appropriate adjustments.
-  Return to TV viewing.

- **Position:** This function is to adjust picture to left/right and up/down as you prefer.
- **Size:** This function is to minimize any vertical bars or stripes visible on the screen background. And the horizontal screen size will also change. The **Size** adjustment range is **-30 ~ 30**.
- **Phase:** This function allows you to remove any horizontal noise and clear or sharpen the image of characters. The **Phase** adjustment range is **-32 ~ 31**.

## Screen Reset (Reset to original factory values)

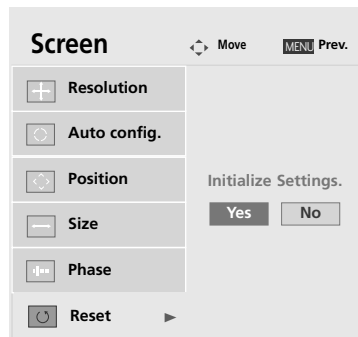
Returns **Position**, **Size**, and **Phase** to the default factory settings.  
This feature operates only in RGB mode.



1  Press the **ADJUST** button.

2  Select **Reset**.

3   Select **Yes**.

4 

# WATCHING TV / CHANNEL CONTROL

## REMOTE CONTROL FUNCTIONS (Only 32LG3DC)

When using the remote control, aim it at the remote control sensor on the TV.

**POWER** Turns your TV on or off.

**TV** In AV1-2, Component, RGB, and HDMI input sources, screen returns to the last TV channel.

**INPUT** External input modes rotate in regular sequence: TV, AV1-2, Component, RGB, and HDMI.

**PICTURE** Selects the factory preset picture depend on the viewing environment. ▶ p.45

**SOUND** Selects the factory preset sound for type of program.  
▶ p.55

- SAP**
- Analog mode: Selects MTS sound (Mono, Stereo, or a SAP) ▶ p.61
  - DTV mode: Changes the audio language.

**RATIO** Change the aspect ratio. ▶ p.42

**THUMBSTICK** (Up/Down/Left Right/ENTER) Navigate the on-screen menus and adjust the system settings to your preference.

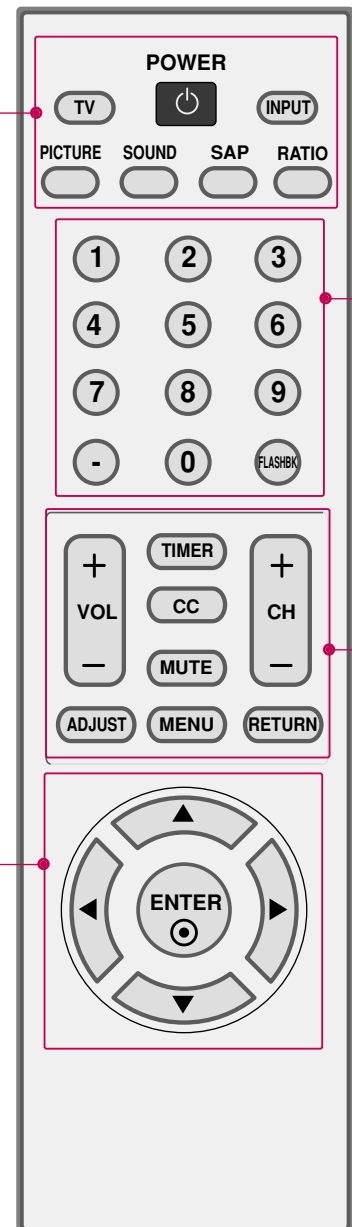

**NUMBER button**

**— (DASH)** Used to enter a program number for multiple program channels such as 2-1, 2-2, etc.

**FLASHBK** Tune to the last channel viewed.

**VOLUME UP /DOWN** Increase/decrease the sound level.

**TIMER** Select the amount of time before your TV turns off automatically. ► **p.70**

**CC** Select a closed caption. ► **p.64**

**MUTE** Switch the sound on or off. ► **p.35**

**CHANNEL UP/DOWN** Select available channels.

**ADJUST** Adjust the screen resolution, position, size and phase. ► **p.28 - p.31**

**MENU** Displays the main menu.

**RETURN** Allows the user to move return one step in an interactive application or other user interaction function.

## Installing Batteries

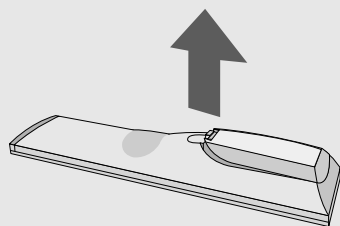

- Open the battery compartment cover on the back side and install the batteries matching correct polarity (+with +,-with -).
- Install two 1.5V AAA batteries. Don't mix old or used batteries with new ones.
- Close cover.

# WATCHING TV / CHANNEL CONTROL

## TURNING ON TV

---

- 1** First, connect power cord correctly.  
At this moment, the TV switches to standby mode.
    - In standby mode to turn TV on, press the  $\phi$ /I button on the TV or press the **POWER** button on the remote control.
    - Note: Only for 32LG3DCH the TV also turn on with **CH (+ or -)** button on the remote.

---
  - 2** Select the viewing source by using the **INPUT** button on the remote control.
    - This TV is programmed to remember which power state it was last set to, even if the power cord is out.

---
  - 3** When finished using the TV, press the **POWER** button on the remote control. The TV reverts to standby mode.
- 

### ! NOTE

- ▶ If you intend to be away on vacation, disconnect the power plug from the wall power outlet.

## CHANNEL SELECTION

---

- 1 Press the **CH (+ or -)** or **NUMBER** buttons to select a channel number.
- 

## VOLUME ADJUSTMENT

Adjust the volume to suit your personal preference.

---

- 1 Press the **VOL (+ or -)** button to adjust the volume.  
.....
  - 2 If you want to switch the sound off, press the **MUTE** button.  
.....
  - 3 You can cancel the Mute function by pressing the **MUTE** or **VOL (+ or -)** button.
-





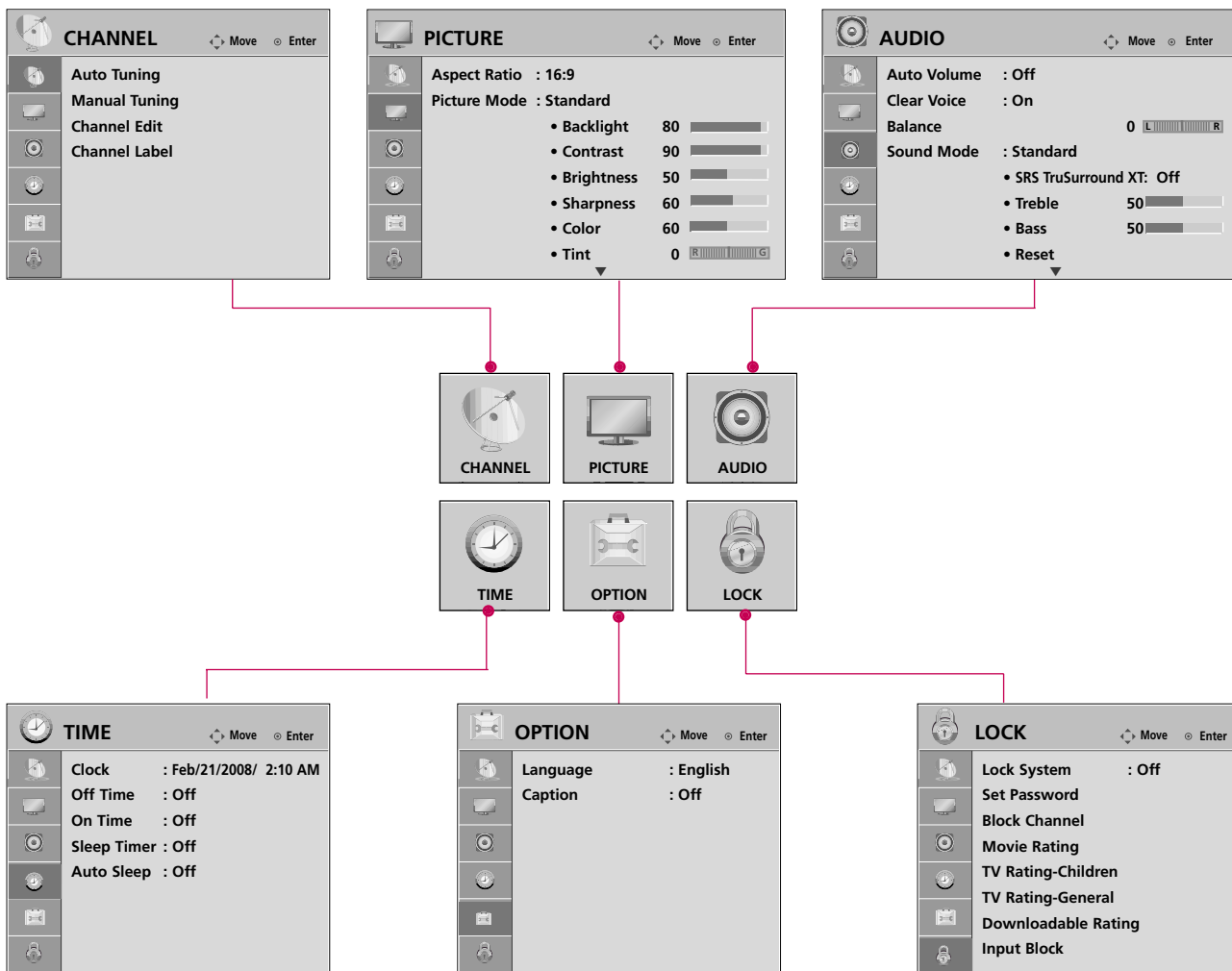

# WATCHING TV / CHANNEL CONTROL

## ON-SCREEN MENUS SELECTION

Your TV's OSD (On Screen Display) may differ slightly from that shown in this manual.



WATCHING TV / CHANNEL CONTROL

-   Display each menu.
-   Select a menu item.
-  Enter to the pop up menu.
-  Return to TV viewing.







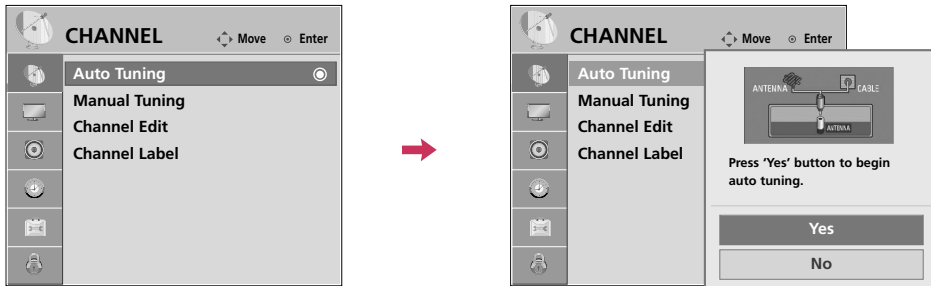

# CHANNEL SETUP

## Auto Scan (Auto Tuning)

Automatically finds all channels available through antenna or cable inputs, and stores them in memory on the channel list.

Run Auto Tuning again after any Antenna/Cable connection changes.



- 1   Select **CHANNEL**.
- 2   Select **Auto Tuning**.
- 3   Select **Yes**.
- 4  Run **Auto tuning**.
- 5  Return to the previous menu.
-  Return to TV viewing.









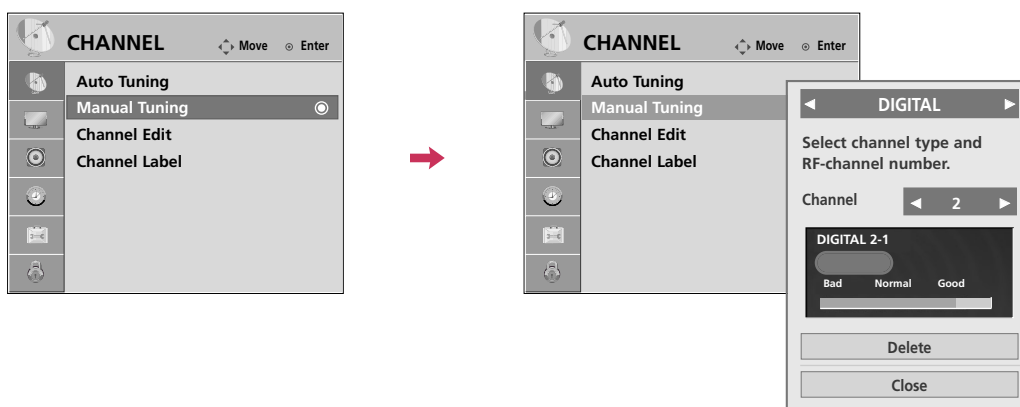

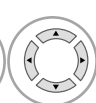
■ A password is required to gain access to Auto Tuning menu if the Lock System is turned on.

# WATCHING TV / CHANNEL CONTROL

## Add/Delete Channel (Manual Tuning)

If selecting DTV or CADTV input signal, you can view the on-screen signal strength monitor to see the quality of the signal being received.



-   Select **CHANNEL**.
-   Select **Manual Tuning**.
-   Select **DIGITAL** or **ANALOG**.
-   Select channel you want to add or delete.
-   Select **Add** or **Delete**.
-  Return to the previous menu.
-  Return to TV viewing.



■ A password is required to gain access to Manual Tuning menu if the Lock System is turned on.

## Channel Editing

A custom list can be created by toggling each channel on or off with **ENTER** button. The channels in the Custom List are displayed in black and the channels deleted from the Custom List are displayed in gray.

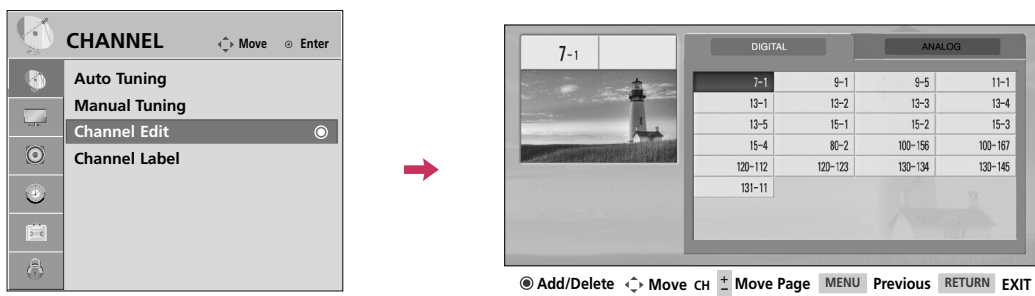
Once a channel is highlighted you can add or delete the channel by referring to the small window at the top-right corner of the screen.



- 1   Select **CHANNEL**.
- 2   Select **Channel Edit**.
- 3   Select a channel.
- 4  Select channel you want to add or delete.
- 5  Return to the previous menu.
-  Return to TV viewing.









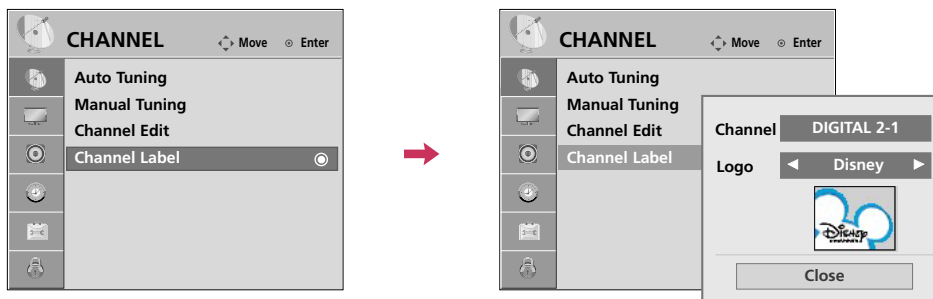

# WATCHING TV / CHANNEL CONTROL

## CHANNEL LABEL

Choose preset labels for your channels.

If a channel label is provided on the signal from the broadcasting station, the TV displays a short name for a channel even if you didn't preset a label for the channel.



-   Select **CHANNEL**.
-   Select **Channel Label**.
-   Select Channel.
-  Select a channel to set logo.
-   Select the appropriate logo for the channel.
-  Return to the previous menu.
-  Return to TV viewing.

# INPUT LIST

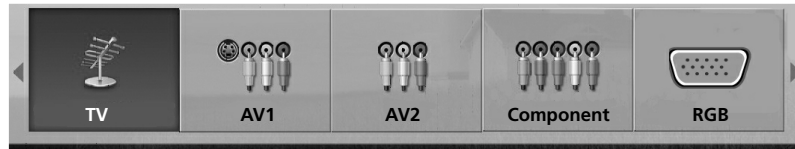

Select the desired input source.

For 26/32LG3DCH  
32LG3DC

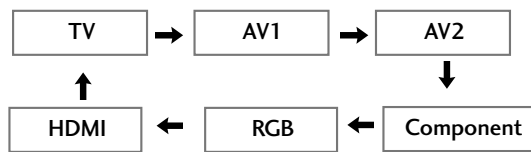

For 22LG3DCH

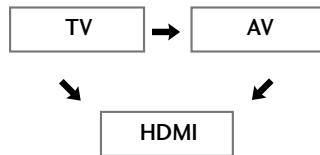

- **TV:** Select it to watch over-the-air, cable and digital cable broadcasts.
- **AV1 -2:** Select them to watch a VCR or other external equipment.
- **Component:** Select them to watch DVD or a Digital set-top box.
- **RGB:** Select it to view PC input.
- **HDMI:** Select them to watch high definition devices.

# PICTURE CONTROL

## PICTURE SIZE (ASPECT RATIO) CONTROL

This feature lets you choose the way an analog picture with a 4:3 aspect ratio is displayed on your TV.

- RGB input source use 4:3 or 16:9 aspect ratio.

### ! NOTE

- ▶ If a fixed image is displayed on the screen for a long time, the image could become imprinted on the screen and remain visible. This phenomenon is rare on LCDs, but is possible when the image is on the screen for a very long time. This phenomenon is common to all manufacturers and is not covered by warranty. When watching video that does not fill the screen, any after-image from the black bars will normally dissipate after a few minutes.

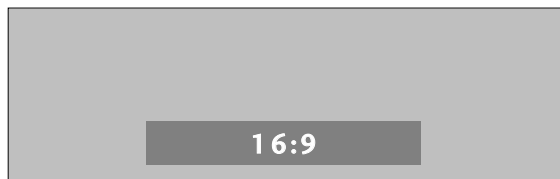

Press the **RATIO** button repeatedly to select the picture options : **Set By Program**, **4:3**, **16:9**, **Full**(Only 22LG3DCH), **Zoom1**, **Zoom2**, **Just Scan**.



Return to TV viewing.

- You can also adjust **Aspect Ratio** in the **PICTURE** menu.

### Set by program

Selects the proper picture proportion to match the source's image.

(4:3 → 4:3)



(16:9 → 16:9)



### 4:3

Choose 4:3 when you want to view a picture with an original 4:3 aspect ratio.



### 16:9

Adjust the picture horizontally, in a linear proportion to fill the entire screen.



### Full (Only 22LG3DCH)

When TV receives the wide screen signal, it will lead you to adjust the picture horizontally or vertically, in a linear proportion, to fill the entire screen fully.

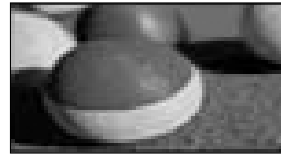

# PICTURE CONTROL

## Zoom 1

Choose Zoom 1 when you want to view the picture without any alteration. However, the top and bottom portions of the picture will be cropped.

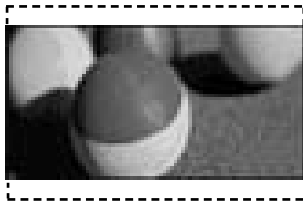

## Zoom 2

Choose Zoom 2 when you want the picture to be altered, both vertically extended and cropped. The picture taking a halfway trade off between alteration and screen coverage.

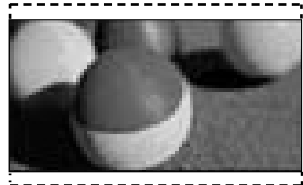

## Just Scan

Normally the edges of video signals are cropped 1-2%. Just Scan turns off this cropping and shows the complete video.

Notes: If there is noise on the edges of the original signal, it will be visible when Just Scan is activated.

**Just Scan** operates only with DTV/CADTV/HDMI-DTV/DVI-DTV (720p/1080i/1080p), Component(720p/1080i) input sources.





# PRESET PICTURE SETTINGS

## Picture Mode - Preset

There are factory presets for picture settings available in the user menus. You can use a preset, change each setting manually.



**1**  Press the **PICTURE** button repeatedly to select the picture options : **Vivid, Standard, Cinema, Sport, Game** and **Expert1-2**.

**2**  Return to TV viewing.







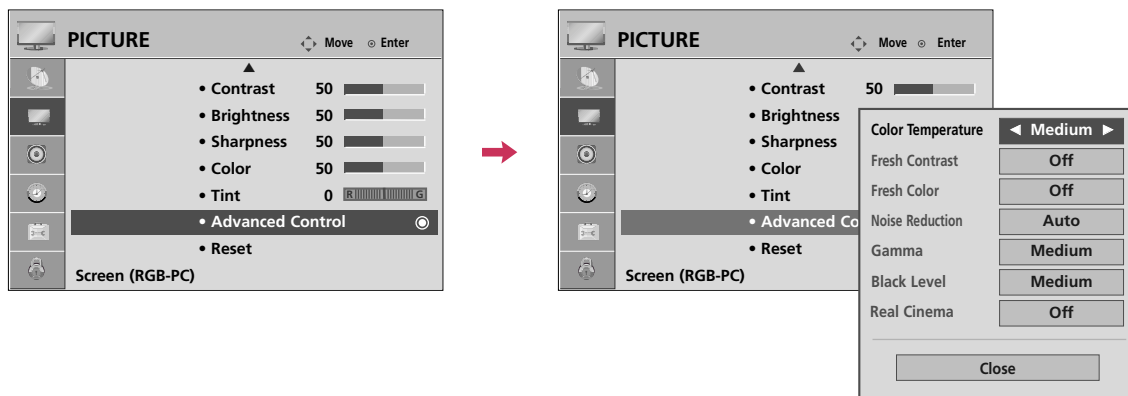

■ You can also adjust **Picture Mode** in the **PICTURE** menu.

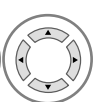
# PICTURE CONTROL

## Color Tone - Preset

Choose one of three automatic color adjustments. Set to warm to enhance hotter colors such as red, or set to cool to see less intense colors with more blue.

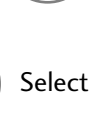













-   Select **PICTURE**.
-   Select **Advanced Control**.
-   Select **Color Temperature**.
-   Select **Cool, Medium, or Warm**.
-  Return to the previous menu.
-  Return to TV viewing.

# MANUAL PICTURE ADJUSTMENT

## Picture Mode - User Mode

Adjust the picture appearance to suit your preference and viewing situations.











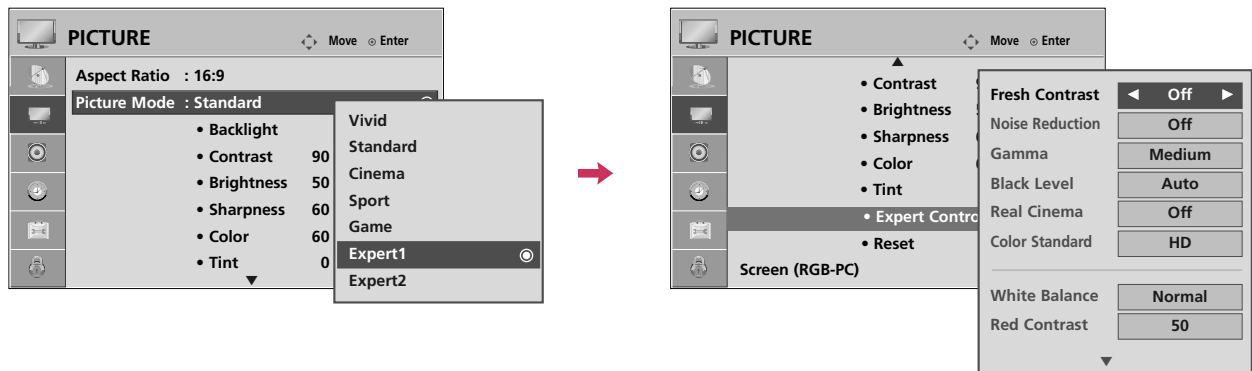





- 1   Select **PICTURE**.
- 2   Select **Picture Mode**.
- 3   Select **Vivid, Standard, Cinema, Sport, or Game**.
- 4   Select **Backlight, Contrast, Brightness, Sharpness, Color, or Tint**.
- 5   Make appropriate adjustments.
- 6  Return to the previous menu.
-  Return to TV viewing.

# PICTURE CONTROL

## Picture Mode - Expert Control

Expert1 and Expert2 allow you set you own custom settings.



-   Select **PICTURE**.
-   Select **Picture Mode**.
-   Select **Expert1** or **Expert2**.
-   Select **Expert Control**.
-   Select your desired menu option.
-  Make appropriate adjustments.
-  Return to the previous menu.
-  Return to TV viewing.

# PICTURE IMPROVEMENT SETTINGS







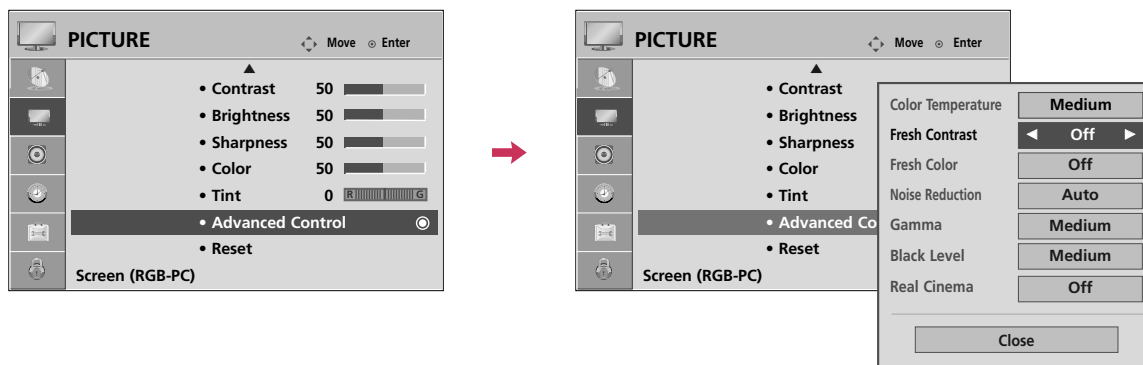

**Fresh Contrast:** Optimizes the contrast automatically according to the brightness of the reflection.

**Fresh Color:** Adjusts the color of the reflection automatically to reproduce as close as possible natural colors.

**Noise Reduction:** Removes interference up to the point where it does not damage the original picture.

**Gamma:** High gamma values display whitish images and low gamma values display high contrast images.



-   Select **PICTURE**.
-   Select **Advanced Control**.
-   Select **Fresh Contrast, Fresh Color, Noise Reduction, or Gamma**.
-  Select your desired options.
-  Return to the previous menu.
-  Return to TV viewing.









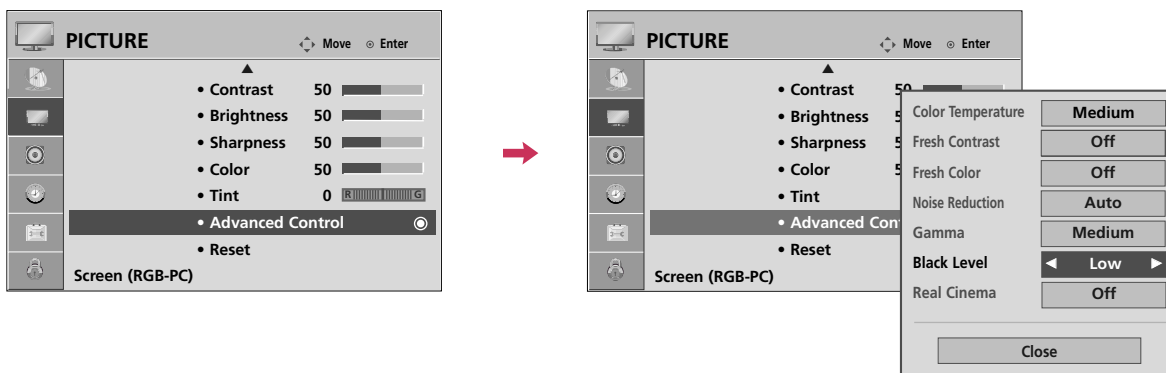

# PICTURE CONTROL

## ADVANCED CONTROL - BLACK (DARKNESS) LEVEL

Adjusting the contrast and the brightness of the screen using the black level of the screen.

This feature is disabled in DTV and RGB mode.



-   Select **PICTURE**.
-   Select **Advanced Control**.
-   Select **Black Level**.
-   Select **Low** or **High**.
-  Return to the previous menu.
-  Return to TV viewing.

- **Low:** The reflection of the screen gets darker.
- **High:** The reflection of the screen gets brighter.
- **Auto:** Realizing the black level of the screen and set it to High or Low automatically.









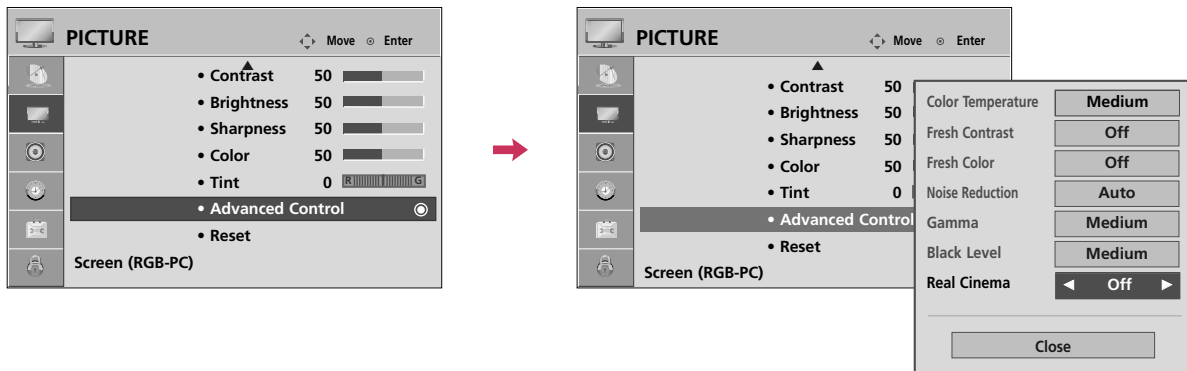

# ADVANCED CONTROL - REAL CINEMA

Set up the TV for the best picture appearance for viewing movies.

When you operate Real Cinema (3:2 Pull-Down Mode or Cinema Correction Mode), the TV will adjust 24 fps video from movies to 30 fps video for display.

This feature operates only in TV (Analog TV/CATV, Digital DTV/CADTV), AV/AV1-2, Component 480i/1080i, and HDMI 480i/1080i mode.







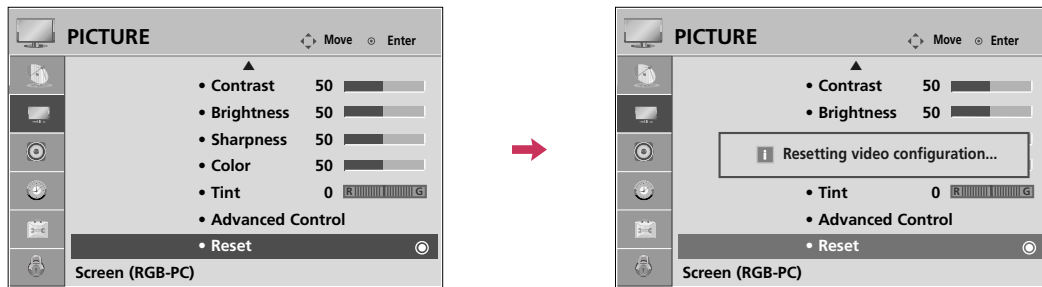

-   Select **PICTURE**.
-   Select **Advanced Control**.
-   Select **Real Cinema**.
-   Select **On** or **Off**.
-  Return to the previous menu.
-  Return to TV viewing.

# PICTURE CONTROL

## PICTURE RESET

Settings of the selected picture modes return to the default factory settings.









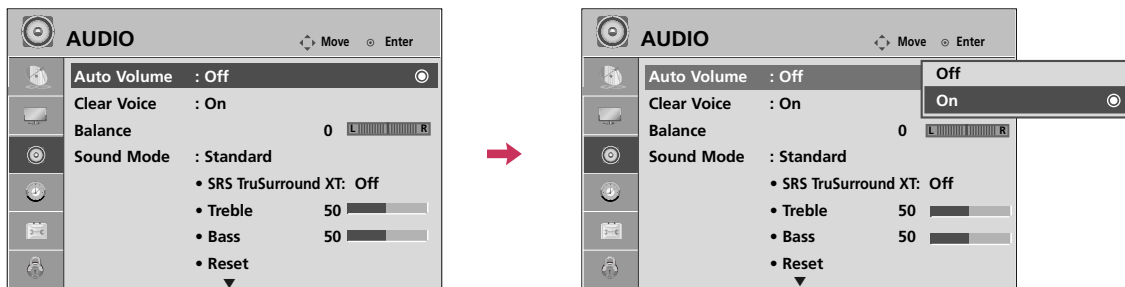

-   Select **PICTURE**.
-   Select **Reset**.
-  Initialize the adjusted value.
-  Return to TV viewing.

# SOUND & LANGUAGE CONTROL

## AUTO VOLUME LEVELER (AUTO VOLUME)

Auto Volume makes sure that the volume level remains consistent whether you are watching a commercial or a regular TV program.







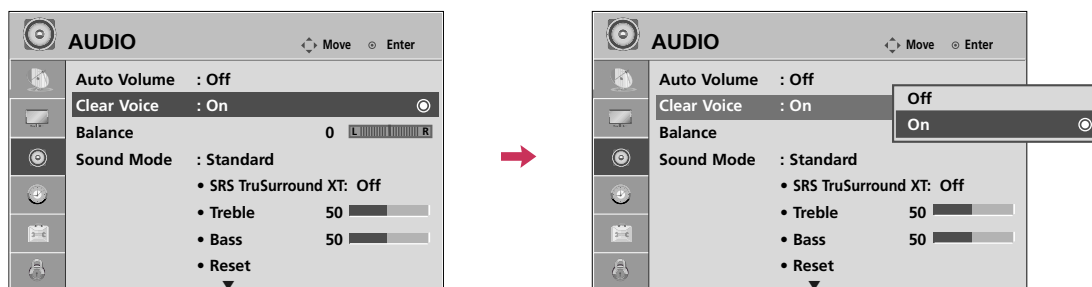

-   Select **AUDIO**.
-   Select **Auto Volume**.
-   Select **On** or **Off**.
-  Return to the previous menu.
-  Return to TV viewing.

# SOUND & LANGUAGE CONTROL

## CLEAR VOICE

By differentiating the human sound range from others, it improves the sound quality of voices.



- 1   Select **AUDIO**.
- 2   Select **Clear Voice**.
- 3   Select **On** or **Off**.
- 4  Return to the previous menu.
-  Return to TV viewing.

■ If you select “Clear Voice-On”, SRS TruSurround XT feature will not work.

## PRESET SOUND SETTINGS (SOUND MODE)

Sound Mode lets you enjoy the best sound without any special adjustment as the TV sets the appropriate sound options based on the program content.

**Standard, Music, Cinema, Sport, and Game** are preset for optimum sound quality at the factory and are not adjustable.

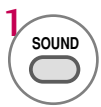
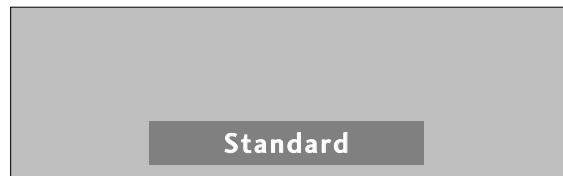

1 Press the **SOUND** button repeatedly to select the sound options : **Standard, Music, Cinema, Sport, and Game**.



2 Return to TV viewing.









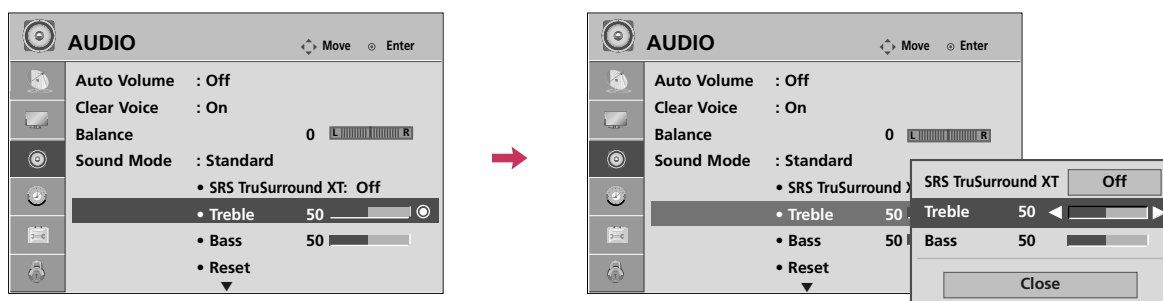



■ You can also adjust **Sound Mode** in the **AUDIO** menu.

# SOUND & LANGUAGE CONTROL

## SOUND SETTING ADJUSTMENT - USER MODE

Adjust the sound to suit your taste and room situations.









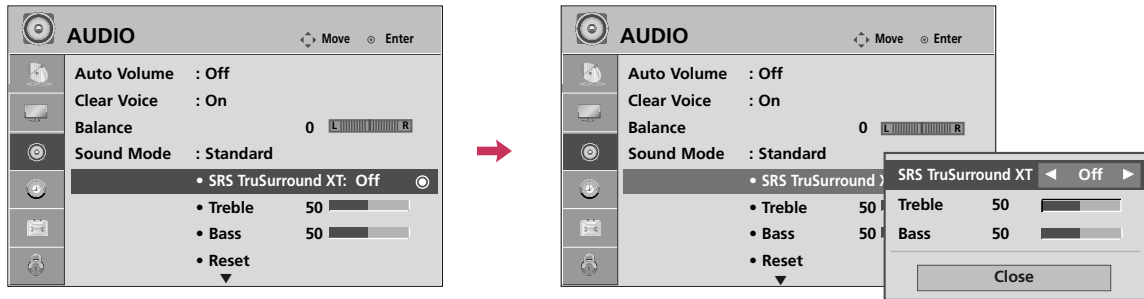

-   Select **AUDIO**.
-   Select **Sound Mode**.
-   Select **Standard, Music, Cinema, Sport, or Game**.
-   Select **Treble** or **Bass**.
-   Make appropriate adjustments.
-  Return to the previous menu.
-  Return to TV viewing.

## SRS TRUSURROUND XT

Takes advantage of any multi-channel format without needing to add extra speakers or equipment. Dialog clarity, bass enrichment, and the addition of stereo audio enhancement produces an immersive sound experience from standard stereo material.









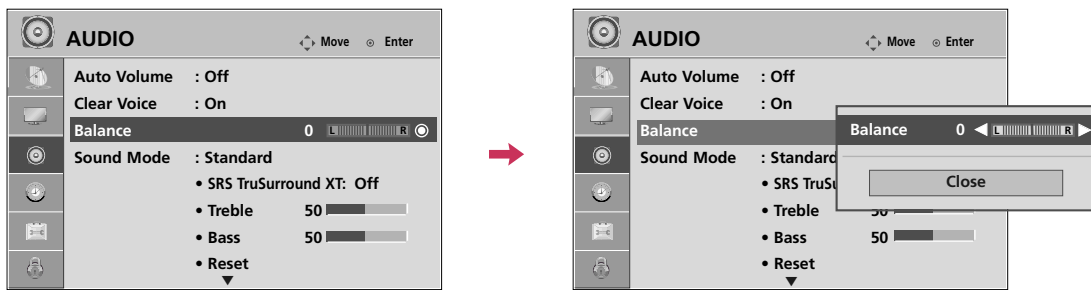

-   Select **AUDIO**.
-   Select **SRS TruSurround XT**.
-   Select **On** or **Off**.
-  Return to the previous menu.
-  Return to TV viewing.

# SOUND & LANGUAGE CONTROL

## BALANCE

Adjust the left/right sound of speaker to suit your taste and room situations.







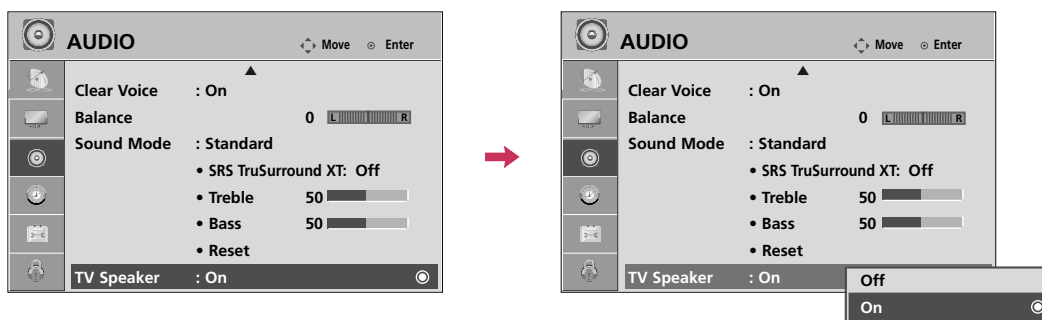

-   Select **AUDIO**.
-   Select **Balance**.
-   Make appropriate adjustments.
-  Return to the previous menu.
-  Return to TV viewing.

## TV SPEAKERS ON/OFF SETUP

Turn the TV speakers off if using external audio equipment.







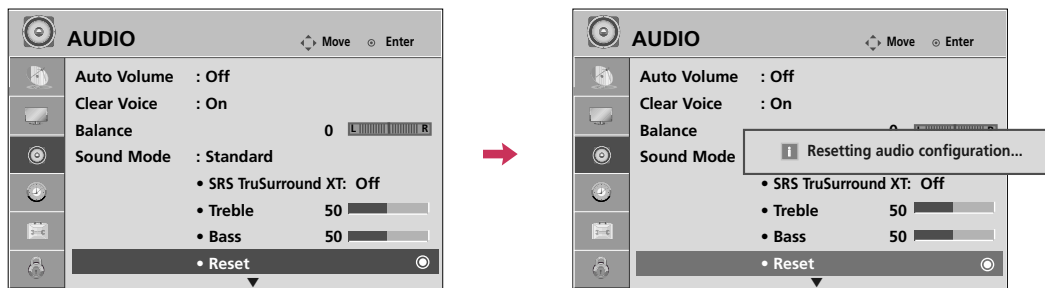

-   Select **AUDIO**.
-   Select **TV Speaker**.
-   Select **On** or **Off**.
-  Return to the previous menu.
-  Return to TV viewing.

# SOUND & LANGUAGE CONTROL

## AUDIO RESET

Settings of the selected Sound Mode return to the default factory settings.





- 1   Select **AUDIO**.
- 2   Select **Reset**.
- 3  Initialize the adjusted value.

## STEREO/SAP BROADCAST SETUP

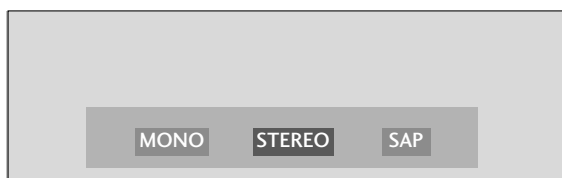
For Analog only: This TV can receive MTS stereo programs and any SAP (Secondary Audio Program) that accompanies the stereo program if the station transmits an additional sound signal. Mono sound is automatically used if the broadcast is only in Mono.



**1**  Each time you press the **SAP** button, **Mono**, **Stereo**, or **SAP** appear in turn.

**2**  Return to TV viewing.

■ If other languages available on the digital signal, select them with the **SAP** button.

# SOUND & LANGUAGE CONTROL

## AUDIO LANGUAGE

Other languages may be available if a digital signal is provided by the broadcasting station.  
This feature operates only in DTV/CADTV mode.

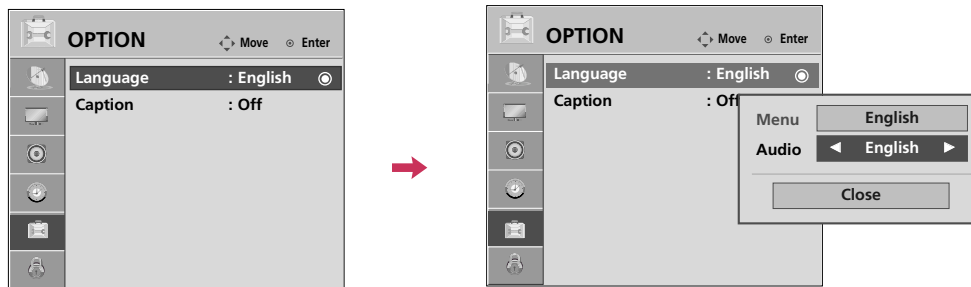







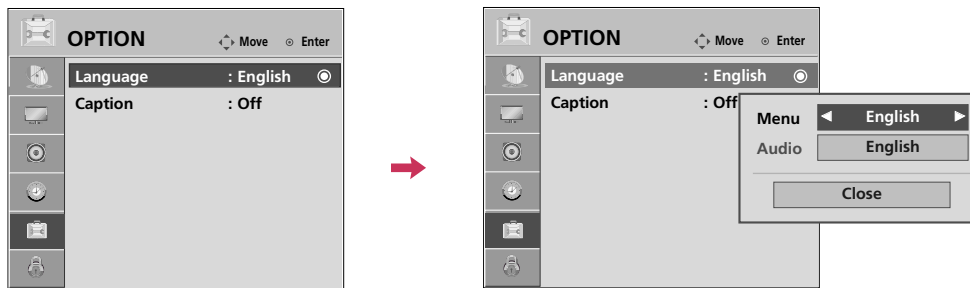

- 1   Select **OPTION**.
- 2   Select **Language**.
- 3   Select **Audio**.
- 4  Select your desired language:  
**English, Spanish, or French**
- 5  Return to the previous menu.
-  Return to TV viewing.

## ON-SCREEN MENUS LANGUAGE SELECTION

The menus can be shown on the screen in the selected language.



- 1   Select **OPTION**.
- 2   Select **Language**.
- 3   Select **Menu**.
- 4  Select your desired language.  
From this point on, the on-screen menus will be shown in the selected language.
- 5  Return to the previous menu.
-  Return to TV viewing.

# SOUND & LANGUAGE CONTROL

## CAPTION MODE

Caption must be provided to help people with hearing loss watch TV. This feature operates only in TV, AV/AV1-2 mode.







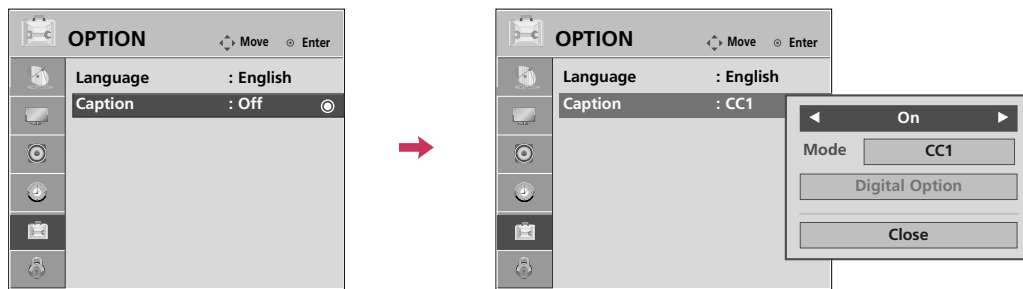

- 1  Select Caption **On** or **Off**.

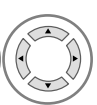
- When selecting **Off**, Sub-menus for Analog, DTV, and Digital Option become disabled.

## Analog Broadcasting System Captions

Caption must be provided to help people with hearing loss watch TV. Select a caption mode for displaying captioning information if provided on a program. Analog caption displays information at any position on the screen and is usually the program's dialog. Caption/Text, if provided by the broadcaster, would be available for both digital and analog channels on the Antenna/Cable.



- 1   Select **OPTION**.
- 2   Select **Caption**.
- 3   Select **On**.
- 4   Select **CC1-4** or **Text1-4**.
- 5  Return to the previous menu.
-  Return to TV viewing.

- **CAPTION**  
The term for the words that scroll across the bottom of the TV screen; usually the audio portion of the program provided for the hearing impaired.
- **TEXT**  
The term for the words that appear in a large black frame and almost cover the entire screen; usually messages provided by the broadcaster.









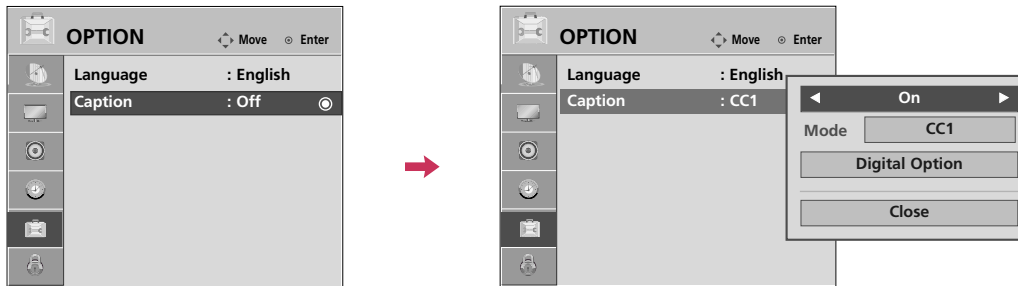

## Digital Broadcasting System Captions

Choose the language you want the DTV/CADTV Captions to appear in.

Other Languages can be chosen for digital sources only if they are included on the program.

This function is only available when Caption Mode is set On.



-   Select **OPTION**.
-   Select **Caption**.
-   Select **On**.
-   Select **CC1-4, Text1-4, or Service1 - 6**.
-  Return to the previous menu.
-  Return to TV viewing.

# SOUND & LANGUAGE CONTROL

## Caption Option

Customize the DTV/CADTV captions that appear on your screen.

This function is only available when **Caption Mode** is set **On**.

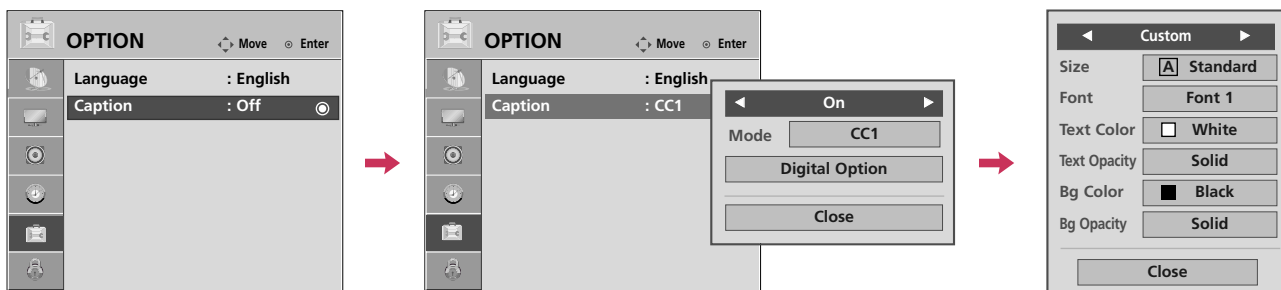



1   Select **OPTION**.

2   Select **Caption**.

3   Select **On**.

4   Select **Digital Option**.

5   Select **Custom**.

6   Customize the **Style, Font**, etc., to your preference. A preview icon is provided at the bottom of the screen, use it to see the caption language.

7  Return to the previous menu.

 Return to TV viewing.

- **Size:** Set the word size.
- **Font:** Select a typeface for the text.
- **Text Color:** Choose a color for the text.
- **Text Opacity:** Specify the opacity for the text color.
- **Bg (Background) Color:** Select a background color.
- **Bg (Background) Opacity:** Select the opacity for the background color.

# TIME SETTING

## CLOCK SETTING









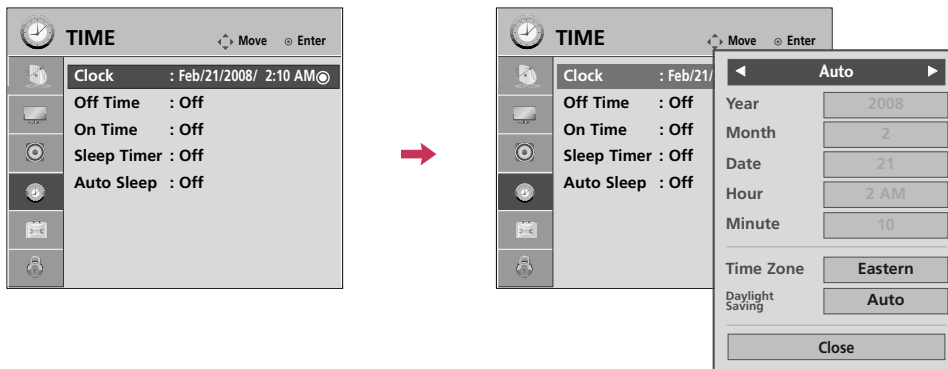



### Auto Clock Setup

The time is set automatically from a digital channel signal.

The digital channel signal includes information for the current time provided by the broadcasting station.

Set the clock manually if the current time is set incorrectly by the auto clock function.







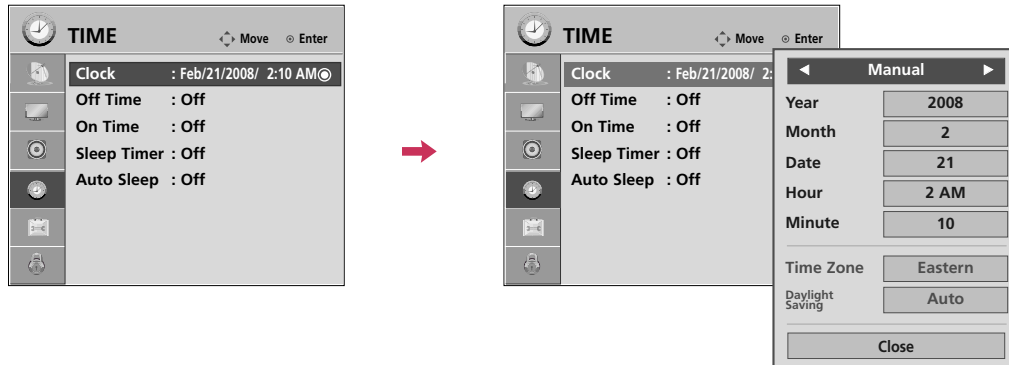

- 1   Select **TIME**.
- 2   Select **Clock**.
- 3   Select **Auto**.
- 4   Select your viewing area time zone.  
: **Eastern, Central, Mountain, Pacific, Alaska, or Hawaii.**
- 5   Select **Auto, On, or Off** (depending on whether or not your viewing area observes Daylight Saving time).
- 6  Return to the previous menu.
-  Return to TV viewing.

# TIME SETTING

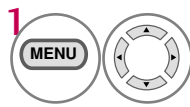
## Manual Clock Setup

If the current time setting is wrong, set the clock manually.

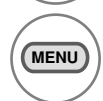

-  Select **TIME**.
-  Select **Clock**.
-  Select **Manual**.
-  Select the Year, Month, Date, Hour, or Minute option.
-  Set the Year, Month, Date, Hour, or Minute option.
-  Return to the previous menu.
-  Return to TV viewing.

## AUTO ON/OFF TIME SETTING

This function operates only if the current time has been set.

The **Off Time** function overrides the **On Time** function if they are both set to the same time.

The TV must be in standby mode for the **On Time** to work.

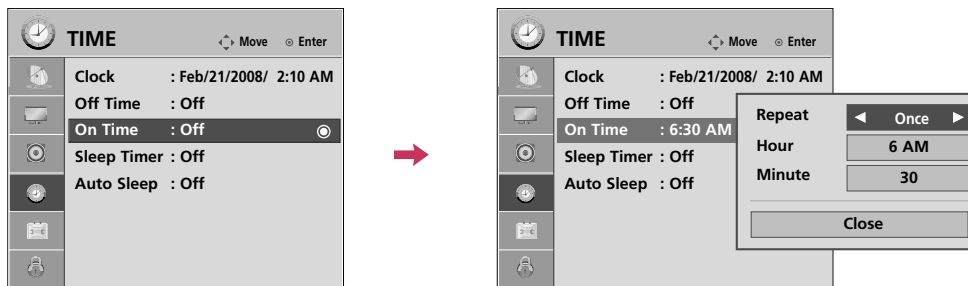

-   Select **TIME**.
-   Select **Off Time** or **On Time**.
-   Select **Repeat**.
-  Select **Off**, **Once**, **Everyday**, **Mon~Fri**, **Mon~Sat**, **Weekend**, or **Sunday**.
-   Select and set **Hour** or **Minute**.
-  Return to the previous menu.
-  Return to TV viewing.

# TIME SETTING

## SLEEP TIMER SETTING

The Sleep Time turns the TV off at the preset time.

Note that this setting is cleared when the TV is turned off.

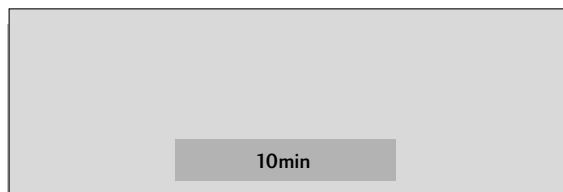

Press the **TIMER** button repeatedly to select the number of minutes.  
Sleep timer options: Off, 10, 20, 30, 60, 90, 120, 180, and 240 minutes.









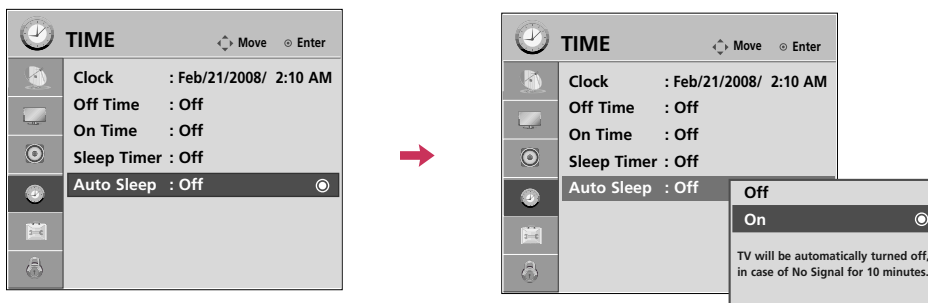

Return to TV viewing.

■ You can also adjust **Sleep Timer** in the **TIME** menu.

# AUTO SHUT-OFF SETTING

TV will be automatically turned off, in case of no signal for 10 minutes.



- 1   Select **TIME**.
- 2   Select **Auto Sleep**.
- 3   Select **On** or **Off**.
- 4  Return to the previous menu.
-  Return to TV viewing.

# PARENTAL CONTROL / RATINGS

Parental Control can be used to block specific channels, ratings and other viewing sources.

The Parental Control Function (V-Chip) is used to block program viewing based on the ratings sent by the broadcasting station. The default setting is to allow all programs to be viewed. Viewing can be blocked by choosing the type of the program and the categories. It is also possible to block all program viewing for a time period. To use this function, the following must be done :

1. Set ratings and categories to be blocked.
2. Specify a password
3. Enable the lock

## V-Chip rating and categories

Rating guidelines are provided by broadcasting stations. Most television programs and television movies can be blocked by TV Rating and/or Individual Categories. Movies that have been shown at the theaters or direct-to-video movies use the Movie Rating System (MPAA) only.

## Ratings for Television programs including made-for-TV movies :

- TV-G (General audience)
- TV-PG (Parental guidance suggested)
- TV-14 (Parents strongly cautioned)
- TV-MA (Mature audience only)
- TV-Y (All children)
- TV-Y7 (Children 7 years older)

## SET PASSWORD & LOCK SYSTEM

### Setting up Your Password

Set up blocking schemes to block specific channels, ratings, and external viewing sources. A password is required to gain access to this menu.

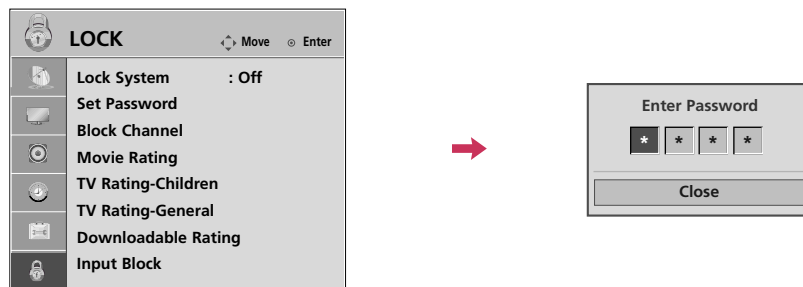

1    Select **LOCK**.

2  Input the password.

- Enter the password as requested.
- The TV is set up with the initial password "0-0-0-0".

## Lock System

Enables or disables the blocking scheme you set up previously.

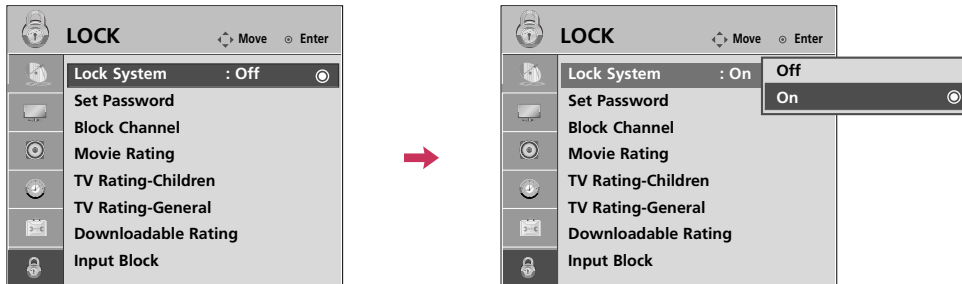



1    Select **LOCK**.

2  Input the password.

3  Select **Lock System**.

4   Select **On** or **Off**.

5  Return to the previous menu.

 Return to TV viewing.

- When you select **On**, the Lock System is enable.

# PARENTAL CONTROL /RATINGS

## Set Password

Change the password by inputting a new password twice.

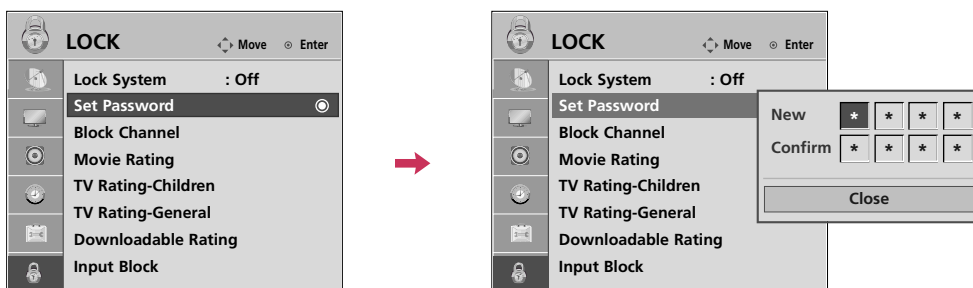



1    Select **LOCK**.

2  Input the password.

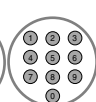
3  Select **Set password**.

4   Choose any 4 digits for your new password.  
As soon as the 4 digits are entered, re-enter the same 4 digits on the **Confirm**.









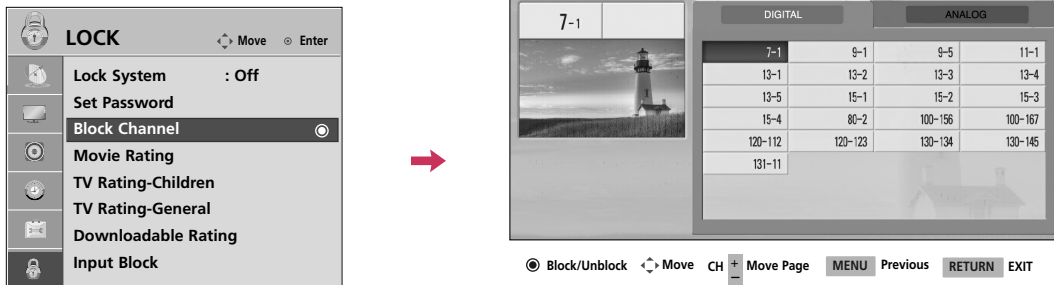

5  Return to the previous menu.

 Return to TV viewing.

# CHANNEL BLOCKING

Blocks any channels that you do not want to watch or that you do not want your children to watch.



- 1    Select **LOCK**.
- 2  Input the password.
- 3  Select **Block Channel**.
- 4   Select a channel to block or unblock.
- 5  Block or unblock a channel.
- 6  Return to the previous menu.
-  Return to TV viewing.

# PARENTAL CONTROL /RATINGS

## MOVIE & TV RATING

### Movie Rating (MPAA)

Blocks movies according to the movie ratings limits specified, so children cannot view certain movies. You can set the ratings limit by blocking out all the movies with the ratings above a specified level. Keep in mind that the movie ratings limit only applies to movies shown on TV, not TV programs, such as soap operas.

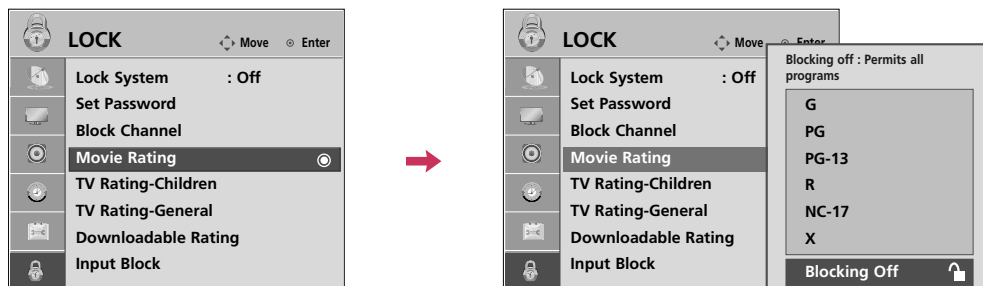



1    Select **LOCK**.

2  Input the password.

3  Select **Movie Rating**.

4   Select **G, PG, PG-13, R, NC-17, X, or Blocking Off**.

5  Return to the previous menu.



 Return to TV viewing.

- G (General audience)
- PG (Parental guidance suggested)
- PG-13 (Parents strongly cautioned)
- R (Restricted)
- NC-17 (No one 17 and under admitted)
- X (Adult only)
- Blocking Off (Permits all programs)
- ▶ If you set PG-13: G and PG movies will be available, PG-13, R, NC-17 and X will be blocked.

## TV Rating Children

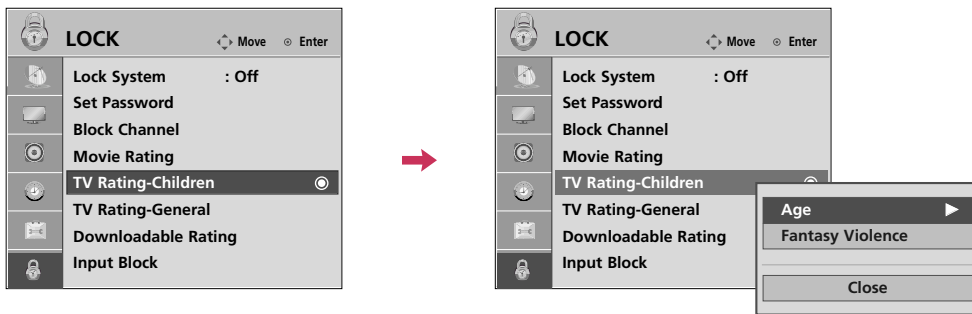
Prevents children from watching certain children's TV programs, according to the ratings limit set. The children rating does not apply to other TV programs. Unless you block certain TV programs intended for mature audiences in the TV Rating - sub menu, your children can view those programs.



1    Select **LOCK**.

2  Input the password.

3  Select **TV Rating-Children**.

4   Select **Age** or **Fantasy Violence**.

5   Select block options.

- Age (applies to TV-Y, TV-Y7)
- Fantasy Violence (applies to TV-Y7)

# PARENTAL CONTROL / RATINGS

## TV Rating General

Based on the ratings, blocks certain TV programs that you and your family do not want to view.

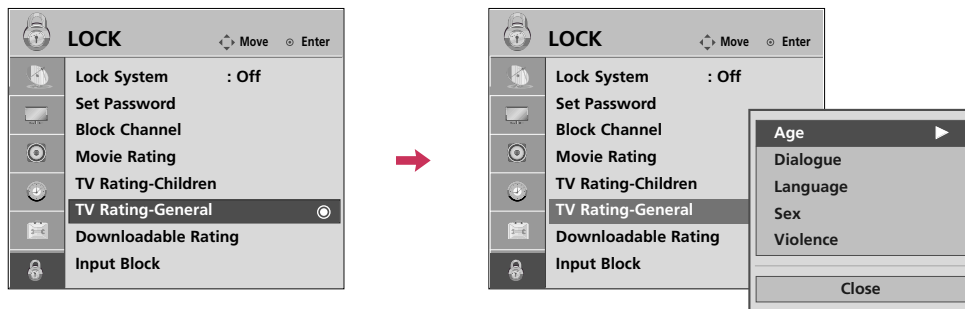

1    Select **LOCK**.

2  Input the password.

3  Select **TV Rating-General**.

4   Select **Age, Dialogue, Language, Sex or Violence**.

5   Select block options.

6  Return to the previous menu.

 Return to TV viewing.







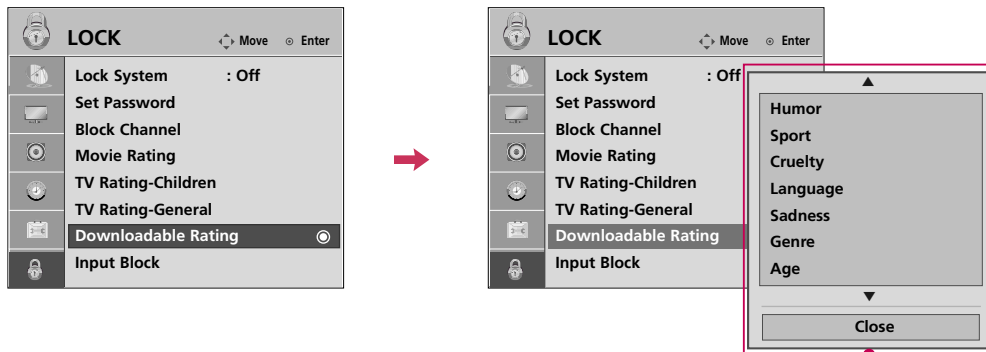



- Age (applies to TV-G,TV-PG,TV-14,TV-MA).
- Dialogue-sexual dialogue (applies to TV-PG,TV-14).
- Language-adult language (applies to TV-PG, TV-14, TV-MA).
- Sex-sexual situations (applies to TV-PG, TV-14, TV-MA).
- Violence (applies to TV-PG, TV-14, TV-MA).

# DOWNLOADABLE RATING

This function may become available in the future and will be available only for digital channels. This function operates only when TV has received Region5 Rating data.



■ Based on rating table, your TV's OSD (On Screen Display) may differ slightly from what is shown in this manual.







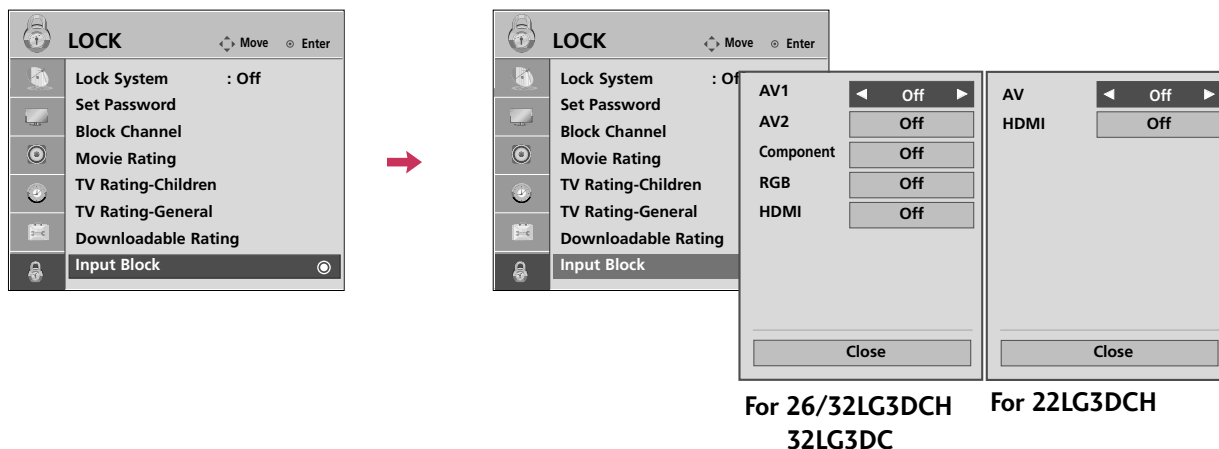

- 1    Select **LOCK**.
- 2  Input the password.
- 3  Select **Downloadable Rating**.
- 4   Select desired **Downloadable Rating** option.
- 5   Select desired option and block it.
- 6  Return to the previous menu.
-  Return to TV viewing.

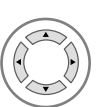
# PARENTAL CONTROL /RATINGS

## EXTERNAL INPUT BLOCKING

Enables you to block an input.



-    Select **LOCK**.
-  Input the password.
-  Select **Input Block**.
-   Select input source.
-  Select **On** or **Off**.
-  Return to the previous menu.
-  Return to TV viewing.

# APPENDIX

## TROUBLESHOOTING

### The operation does not work normally.

<p>The remote control doesn't work</p>	<ul style="list-style-type: none"> <li>■ Check to see if there is any object between the product and the remote control causing obstruction. Ensure you are pointing the remote control directly at the TV.</li> <li>■ Ensure that the batteries are installed with correct polarity (+ to +, - to -).</li> <li>■ Ensure that the correct remote operating mode is set: TV, VCR etc.</li> <li>■ Install new batteries.</li> </ul>
<p>Power is suddenly turned off</p>	<ul style="list-style-type: none"> <li>■ Is the sleep timer set?</li> <li>■ Check the power control settings. Power interrupted.</li> </ul>

### The video function does not work.

<p>No picture &amp; No sound</p>	<ul style="list-style-type: none"> <li>■ Check whether the product is turned on.</li> <li>■ Try another channel. The problem may be with the broadcast.</li> <li>■ Is the power cord inserted into wall power outlet?</li> <li>■ Check your antenna direction and/or location.</li> <li>■ Test the wall power outlet, plug another product's power cord into the outlet where the product's power cord was plugged in.</li> </ul>
<p>Picture appears slowly after switching on</p>	<ul style="list-style-type: none"> <li>■ This is normal, the image is muted during the product startup process. Please contact your service center, if the picture has not appeared after five minutes.</li> </ul>
<p>No or poor color or poor picture</p>	<ul style="list-style-type: none"> <li>■ Adjust Color in menu option.</li> <li>■ Try unplugging any others electronics that are near by to see if interference is causing the problem.</li> <li>■ Try another channel. The problem may be with the broadcast.</li> <li>■ Are the video cables installed properly?</li> <li>■ Activate any function to restore the brightness of the picture.</li> </ul>
<p>Horizontal/vertical bars or picture shaking</p>	<ul style="list-style-type: none"> <li>■ Check for local interference such as an electrical appliance or power tool.</li> </ul>
<p>Poor reception on some channels</p>	<ul style="list-style-type: none"> <li>■ Station or cable product experiencing problems, tune to another station.</li> <li>■ Station signal is weak, reorient antenna.</li> <li>■ Check for sources of possible interference.</li> </ul>
<p>Lines or streaks in pictures</p>	<ul style="list-style-type: none"> <li>■ Check antenna (Change the direction of the antenna).</li> </ul>
<p>No picture when connecting HDMI</p>	<ul style="list-style-type: none"> <li>■ Check HDMI cable over version 1.3. If the HDMI cables don't support HDMI version 1.3, it can cause flickers or no screen display. In this case use the latest cables that support HDMI version 1.3.</li> </ul>

# APPENDIX

The audio function does not work.	
Picture OK but No sound	<ul style="list-style-type: none"> <li>■ Press the VOL or VOLUME button.</li> <li>■ Sound muted? Press the MUTE button.</li> <li>■ Try another channel. The problem may be with the broadcast.</li> <li>■ Are the audio cables installed properly?</li> </ul>
No output from one of the speakers	<ul style="list-style-type: none"> <li>■ Adjust Balance in menu option.</li> </ul>
Unusual sound from inside the product	<ul style="list-style-type: none"> <li>■ A change in ambient humidity or temperature may result in an unusual noise when the product is turned on or off and does not indicate a fault with the product.</li> </ul>
No sound when connecting HDMI or USB	<ul style="list-style-type: none"> <li>■ Check HDMI cable over version 1.3.</li> <li>■ Check USB cable over version 2.0.</li> </ul> <p style="text-align: right;">*This feature is not available for all models.</p>

There is a problem in PC mode. (Only PC mode applied)	
The signal is out of range	<ul style="list-style-type: none"> <li>■ Adjust resolution, horizontal frequency, or vertical frequency.</li> <li>■ Check the input source.</li> </ul>
Vertical bar or stripe on background & Horizontal Noise & Incorrect position	<ul style="list-style-type: none"> <li>■ Run the Auto configure or adjust clock, phase, or H/V position. (Option)</li> </ul>
Screen color is unstable or single color	<ul style="list-style-type: none"> <li>■ Check the signal cable.</li> <li>■ Update video card drivers.</li> </ul>

## MAINTENANCE

Early malfunctions can be prevented. Careful and regular cleaning can extend the amount of time you can enjoy your new TV.

Caution: Be sure to turn the power off and unplug the power cord before you begin any cleaning.

### Cleaning the Screen

- 1 Here's a great way to keep the dust off your screen for a while. Wet a soft cloth in a mixture of lukewarm water and a little fabric softener or dish washing detergent. Wring the cloth until it's almost dry, and then use it to wipe the screen.
- 2 Make sure the excess water is off the screen, and then let it air-dry before you turn on your TV.

#### ⚠ WARNING

- ▶ Do not use window/glass cleaner or anything with ammonia to clean the screen.

### Cleaning the Cabinet

- To remove dirt or dust, wipe the cabinet with a soft, dry, lint-free cloth.
- Please be sure not to use a wet cloth.

### Extended Absence

#### ⚠ CAUTION

- ▶ If you expect to leave your TV dormant for a long time (such as a vacation), it's a good idea to unplug the power cord to protect against possible damage from lightning or power surges.

## PRODUCT SPECIFICATIONS

MODEL		22LG3DCH (22LG3DCH-UA)	26LG3DCH (26LG3DCH-UA)	32LG3DCH (32LG3DCH-UA)	32LG3DC (32LG3DC-UA)
Dimensions (Width x Height x Depth)	With stand				31.5 x 23.7 x 9.1 inches 801.8 x 604.2 x 232 mm
	Without stand	20.7 x 15.2 x 3.2 inches 528 x 387.3 x 82.7 mm	26.1 x 17.6 x 3.1 inches 663.3 x 449.8 x 80.0 mm	31.5 x 21.4 x 4.2 inches 801.8 x 544.4 x 109 mm	31.5 x 21.4 x 4.2 inches 801.8 x 544.4 x 109 mm
Weight	With stand				29.5 pounds / 13.4 kg
	Without stand	13.6 pounds / 6.2kg	18.9 pounds / 8.6 kg	26.2 pounds / 11.9 kg	26.2 pounds / 11.9 kg
Power requirement		AC120V ~ 50/60Hz	AC120V ~ 50/60Hz	AC120V ~ 50/60Hz	AC100-240V ~ 50/60Hz
Television System		NTSC-M, VSB, 64 & 256 QAM			
Program Coverage		VHF 2-13, UHF 14-69, CATV 1-135, DTV 2-69, CADTV 1-135			
External Antenna Impedance		75 ohm			
Environment condition	Operating Temperature	32 ~ 104°F (0 ~ 40°C)			
	Operating Humidity	Less than 80%			
	Storage Temperature	-4 ~ 140°F (-20 ~ 60°C)			
	Storage Humidity	Less than 85%			

- The specifications shown above may be changed without prior notice for quality improvement.

## IR CODES

### 1. How to Connect

- Connect your wired remote control to the Remote Control port on the TV.

### 2. Remote Control IR Codes

#### ■ Output waveform

Single pulse, modulated with 37.917KHz signal at 455KHz

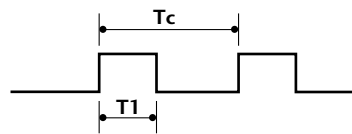

Carrier frequency  
 $FCAR = 1/TC = fOSC/12$   
 Duty ratio =  $T1/TC = 1/3$

#### ■ Configuration of frame

1st frame

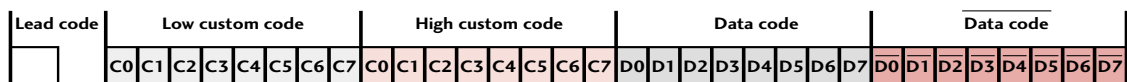

Repeat frame

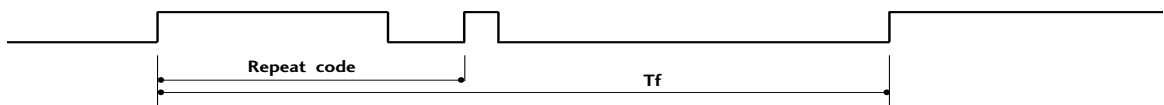

#### ■ Lead code

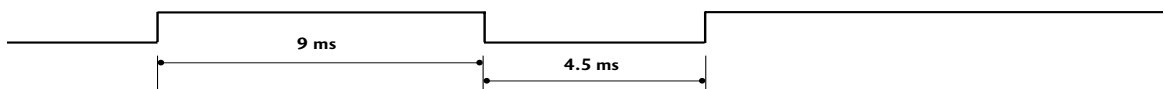

#### ■ Repeat code

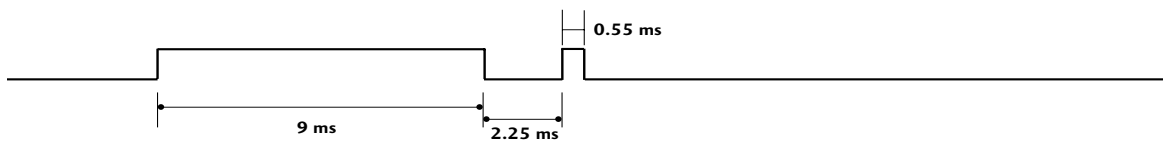

#### ■ Bit description



#### ■ Frame interval: Tf

The waveform is transmitted as long as a key is depressed.

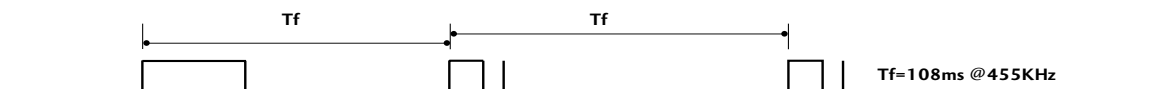

Code (Hexa)	Function	Note	Code (Hexa)	Function	Note
08	POWER	Remote control Button (Power On/Off)	D6	TV	Discrete IR Code (TV Input Selection)
0F	TV	Remote control Button			
0B	INPUT	Remote control Button	5A	AV1	Discrete IR Code (AV1 Input Selection)
4D	PICTURE	Remote control Button			
52	SOUND	Remote control Button	BF	COMPONENT	Discrete IR Code (COMPONENT Input Selection)
0A	SAP	Remote control Button			
79	RATIO	Remote control Button	D5	RGB	Discrete IR Code (RGB Input Selection)
10-19	Number Key 0-9	Remote control Button			
4C	- (Dash)	Remote control Button	CE	HDMI1	Discrete IR Code (HDMI1 Input Selection)
1A	FLASHBK	Remote control Button			
02	VOL +	Remote control Button	76	Ratio 4:3	Discrete IR Code (Only 4:3 Mode)
03	VOL -	Remote control Button			
00	CH +	Remote control Button	77	Ratio 16:9	Discrete IR Code (Only 16:9 Mode)
01	CH -	Remote control Button			
0E	TIMER	Remote control Button	AF	Ratio Zoom	Discrete IR Code (Only Zoom1 Mode)
39	CC	Remote control Button			
09	MUTE	Remote control Button	C4	POWER ON	Discrete IR Code (Only Power On)
CB	ADJUST	Remote control Button			
43	MENU	Remote control Button	C5	POWER OFF	Discrete IR Code (Only Power Off)
5B	RETURN	Remote control Button			
40	▲	Remote control Button			
41	▼	Remote control Button			
07	◀	Remote control Button			
06	▶	Remote control Button			
44	ENTER	Remote control Button			

**LG Electronics Inc.**