

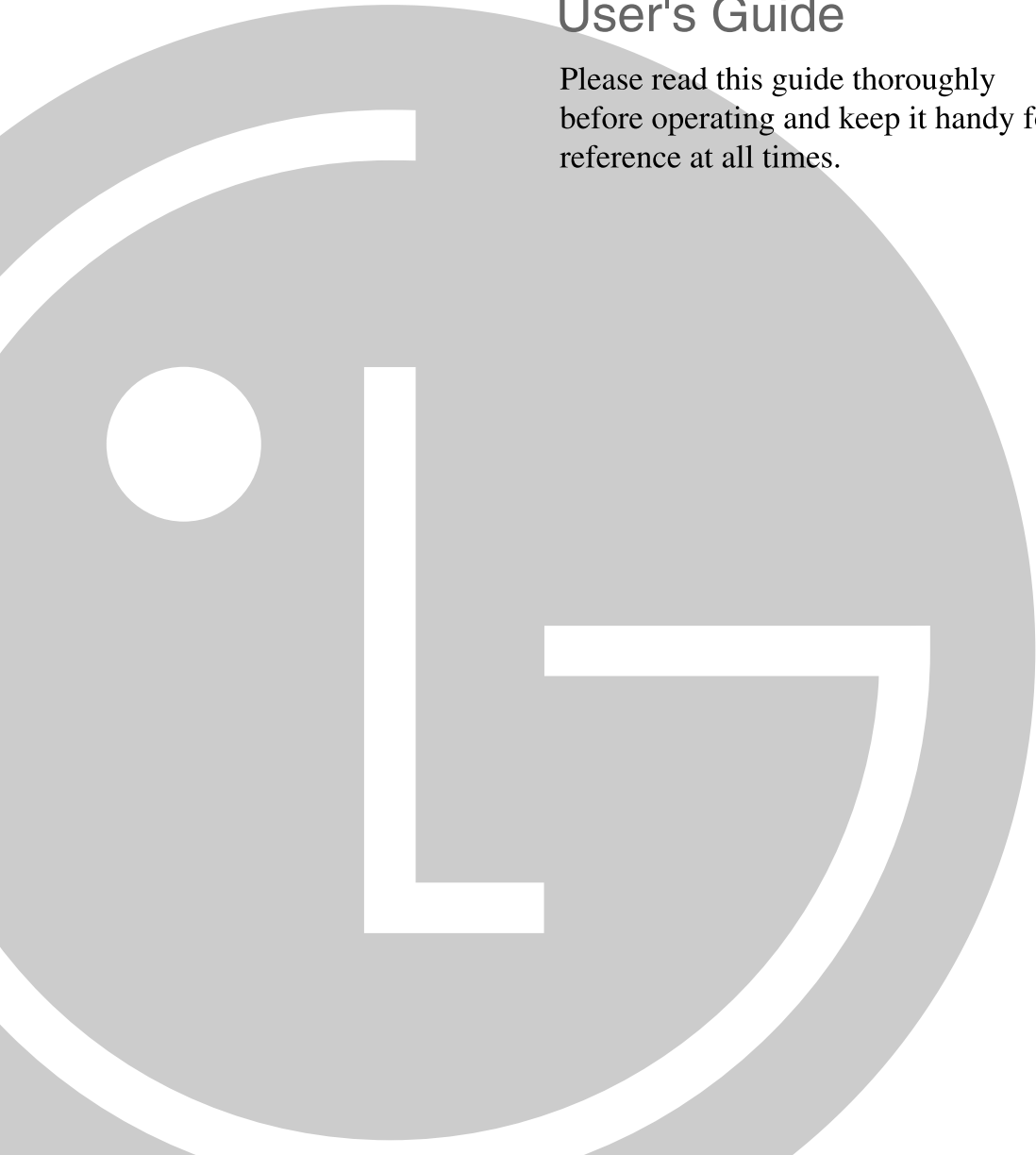

## **SXS** REFRIGERATOR

### User's Guide

Please read this guide thoroughly before operating and keep it handy for reference at all times.





## Table of contents

<b>Introduction</b>	Entry	3
	Basic safety precautions	3
	Identification of parts	11
<b>Installation</b>	Where to install	12
	Door removal	13
	Door replacement	14
	Feed water pipe installation	14
	Height adjustment	15
<b>Operation</b>	Starting	16
	Adjusting the temperatures and functions	16
	Refreshment center	22
	Shelf	23
	Egg box	23
	Nano charcoal deodorizer	24
	LED lamp (Freezer/Fridge)	24
	Fresh compartment	25
	Vacuum fresh compartment	26
	Freezer/Fridge basket	27
	Dairy corner	27
How to exchange the water purifier filter	28	
<b>Suggestion on food storage</b>	Location of foods	29
	Storing foods	30
<b>Care and maintenance</b>	General information	31
	Cleaning	31
	Trouble shooting	32
	It is normal...	37
	When replacing PANEL.....	38



- This product is exclusive use at 230V/50Hz.
- You should purchase transformer of more than 2.0KVA when you want to use it at the 110V area.

## Entry

**The model and serial numbers are found on the inner case or back of refrigerator compartment of this unit. These numbers are unique to this unit and not available to others. You should record requested information here and retain this guide as a permanent record of your purchase. Staple your receipt here.**

Date of purchase : \_\_\_\_\_  
 Dealer purchased from : \_\_\_\_\_  
 Dealer address : \_\_\_\_\_  
 Dealer phone no. : \_\_\_\_\_  
 Model no. : \_\_\_\_\_  
 Serial no. : \_\_\_\_\_

## Basic safety precautions

**This guide contains many important safety messages. Always read and obey all safety messages.**



This is the safety alert symbol. It alerts you to safety messages that inform you of hazards that can kill or hurt you or others or cause damage to the product. All safety messages will be preceded by the safety alert symbol and the hazard signal word DANGER, WARNING, or CAUTION. These words mean:



### **DANGER**

You will be killed or seriously injured if you don't follow instructions.



### **WARNING**

You can be killed or seriously injured if you don't follow instructions.



### **CAUTION**

Indicates an imminently hazardous situation which, if not avoided, may result in minor or moderate injury, or product damage only.

All safety messages will identify the hazard, tell you how to reduce the chance of injury, and tell you what can happen if the instructions are not followed.

## **WARNING**

To reduce the risk of fire, electric shock, or injury to persons when using your product, basic safety precautions should be followed, including the following. Read all instructions before using this appliance.

### 1. When connecting the power

#### The dedicated outlet should be used.

- Using several devices at one outlet may cause fire.
- The electric leakage breaker may damage food and the dispenser may be leaked.

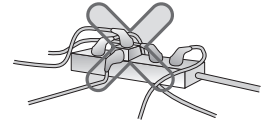

#### Do not allow the power plug to face upward or to be squeezed at the back of the refrigerator.

Water may be flown into or the plug may be damaged, which causes fire or electric shock.

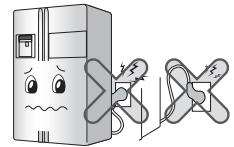

#### Prevent the power cord from being squeezed or imprinted if the refrigerator is pushed in after the power plug is extracted during the installation.

#### When moving your appliance away from the wall, be careful not to roll over the power cord or to damage it in any way.

It becomes the cause of fire or electric shock.

#### Do not allow the power cord bent or pressed by the heavy object to be damaged.

It may damage the power cord to cause fire or electric shock.

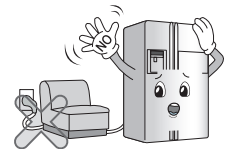

#### Do not extend or modify the length of the power plug.

It causes electric shock or fire by the electric damage of the power cord or others.

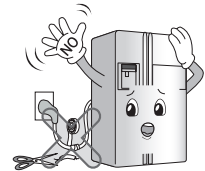

#### Unplug the power plug when cleaning, handling or replacing the interior lamp of the refrigerator.

- It may cause electric shock or injury.
- When replacing the interior lamp of the refrigerator, make sure that the rubber ring for preventing the electric spark within the socket is not taken off.

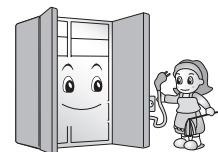

**Do not pull out the cord or touch the power plug with wet hands.**

It may cause electric shock or injury.

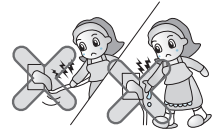

**Remove water or dust from the power plug and insert it with the ends of the pins securely connected.**

Dust, water or unstable connection may fire or electric shock.

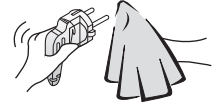

**Unplug the power cord from the power outlet for cleaning or other requirements.**

It may cause electric shock or injury.

**Pull out the power plug not by grasping the cord but the plug of its end.**

It may cause electric shock or short circuit to fire.



**Make sure of grounding.**

**Consult a qualified electrician or service person if the grounding instructions are not completely understood, or if you have doubts on whether the appliance is properly grounded.**

The incorrect grounding may cause breakdown and electric shock.

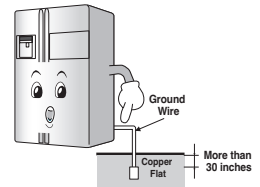

**Be sure to use grounded exclusive proper voltage consent for the power plug. Be sure to use grounded extension consents when extension consents are used.**

It becomes the cause of fire.

**When the power cord or the power plug is damaged or the holes of the outlet are loosed, do not use them.**

It may cause electric shock or short circuit to make fire.

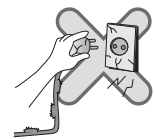

**Wait for 5 minutes or longer when reconnecting the plug.**

It may cause the operation of the freezer to fail.



## 2. When using the refrigerator

### Do not place the heavy object or the dangerous object (container with liquid) on the refrigerator.

It may be dropped to cause injury, fire or electric shock when opening or closing the door.



### Do not install the refrigerator in the wet place or the place which water or rain splashes.

Deterioration of insulation of electric parts may cause electric leakage.

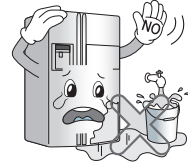

### Do not cling to the door or the shelves of the door or the home bar of the freezer or the cool chamber.

It may make the refrigerator fallen down or damage the hands. Especially, do not allow the children to do the above.

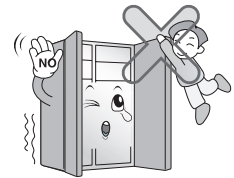

### Prevent children from entering the product.

It may endanger the life of a child if the child enters the refrigerator.

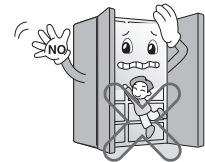

**Opening and closing the door of the refrigerator vigorously may cause the stored food in the refrigerator basket to fall by shock and hurt the foot, so take precautions.**

### Do not use or store inflammable materials ether, benzene, alcohol, medicine, LP gas, spray or cosmetics near or in the refrigerator.

It may cause explosion or fire.

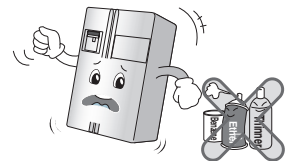

### Do not use drier to dry the inside, nor light a candle to remove odor.

It may cause explosion or fire.

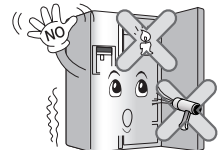

### Do not store the medicine or the academic materials at the refrigerator.

When the material with the strict temperature control is stored, it may be deteriorated or it may make an unexpected reaction to cause any risk.

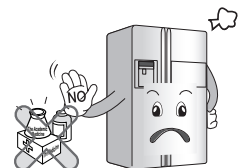

**Do not use the combustible spray near the refrigerator.**

It may cause fire.

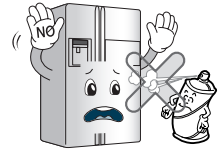
**Install in places away from the fire such as the place where flammable gas is leaked.**

It may cause fire.

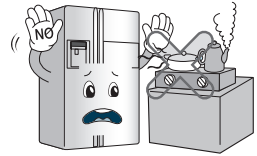
**Do not place flower vase, cup, cosmetics, medicine or any container with water on the refrigerator.**

It may cause fire, electric shock or injury by dropping down.

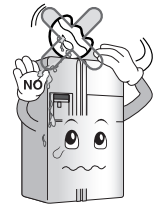
**Do not put heavy things on the Home Bar. (Only for the models with the Home Bar)**

Falling objects may hurt people.

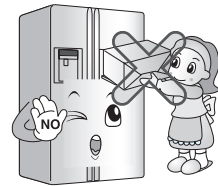
**In case of thunder and lightning, or not in use for a long period of time, detach the power plug.**

There is a danger of electric shock or fire.

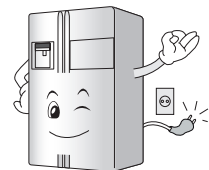
**Use the submerged refrigerator after checking it.**

It may cause electric shock or fire.

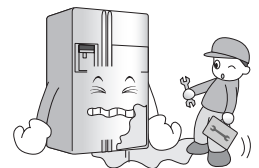
**When gas is leaked, do not touch the refrigerator or the outlet and ventilate the room immediately.**

- The explosion by spark may cause fire or burn.
- Because this refrigerator uses natural gas (isobutene, R600a) as the environment-friendly refrigerant, even a small amount (80~90g) is combustible. When the gas is leaked by the severe damage during delivering, installing or using the refrigerator, any spark may cause fire or burn.

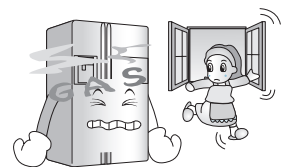

**Do not spray water at the outside or the inside of the refrigerator or do not clean it with benzene or thinner.**

Deterioration of insulation of electric parts may cause electric shock or fire.

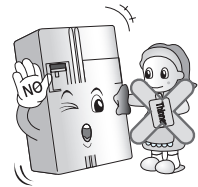

**When any strange smell or smoke is detected from the refrigerator, disconnect the power plug immediately and contact to the service center.**

It may cause fire.

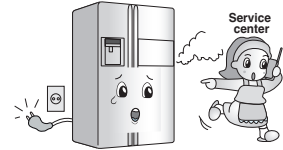

**Do not allow any person except the qualified engineer to disassemble, repair or alter the refrigerator.**

It may cause injury, electric shock or fire.

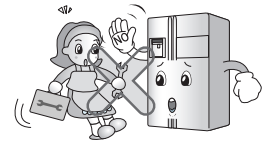

**Do not use the refrigerator for non-domestic purpose (storing medicine or testing material, using at the ship, etc.).**

It may cause an unexpected risk such as fire, electric shock, deterioration of stored material or chemical reaction.

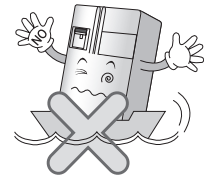

**When disposing the refrigerator, remove the packing materials from the door or take off the doors but leave the shelves in place so that children may not easily climb inside.**

It may cause to lock out the child.



**This appliance is not intended for use by persons (including children) with reduced physical, sensory or mental capabilities, or lack of experience and knowledge, unless they have been given supervision or instruction concerning use of the appliance by a person responsible for their safety.**

**Children should be supervised to ensure that they do not play with the appliance.**

**Install the refrigerator on the solid and level floor.**

Installing it on the unstable place may cause death by falling down the refrigerator when opening or closing the door.

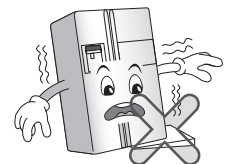

**Do not insert the hands or the metal stick into the exit of cool air, the cover, the bottom of the refrigerator, the heatproof grill (exhaust hole) at the backside.**

It may cause electric shock or injury.

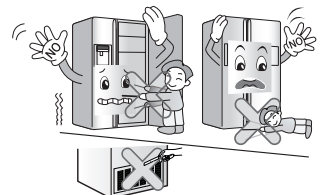

**Keep ventilation openings, in the appliance enclosure or in the built-in structure, clear of obstruction.**

**Do not use mechanical devices or other means to accelerate the defrosting process, other than those recommended by the manufacturer.**

**Do not damage the refrigerant circuit.**

**Do not use electrical appliances inside the food storage compartments of the appliance, unless they are of the type recommended by the manufacturer.**

**The refrigerant and insulation blowing gas used in the appliance require special disposal procedures. When disposal, please consult with service agent or a similarly qualified person.**



**This appliance contains a small amount of isobutane refrigerant (R600a), natural gas with high environmental compatibility, but it is also combustible. When transporting and installing the appliance, care should be taken to ensure that no parts of the refrigerating circuit are damaged. Refrigerant squirting out of the pipes could ignite or cause an eye injury. If a leak is detected, avoid any naked flames or potential sources of ignition and air the room in which the appliance is standing for several minutes.**

In order to avoid the creation of a flammable gas air mixture if a leak in the refrigerating circuit occurs, the size of the room in which the appliance may be sited depends on the amount of refrigerant used. The room must be 1m<sup>2</sup> in size for every 8g of R600a refrigerant inside the appliance. The amount of refrigerant in your particular appliance is shown on the identification plate inside the appliance. Never start up an appliance showing any signs of damage. If in doubt, consult your dealer.

## **CAUTION**

**Violating this direction may cause injury or damage house or furniture. Always be careful, please.**

**Do not insert the hands into the ice bucket or the ice dispenser.**

Operating the ice maker may cause injury.



**Do not touch food or containers at the freezer with wet hands.**

It may cause frostbite.

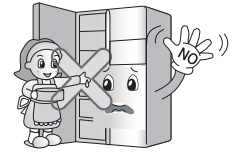

**Do not put ice in thin crystal cup or ceramic ware.**

It may break cup or ceramic ware to cause injury.

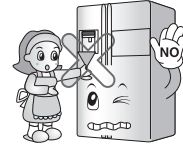

**When the electricity is off, remove ice from the ice bucket (only for the model with the dispenser).**

The long-time power failure may thaw ice to damage the floor. When the long-time power failure is expected, remove ice from the ice bucket.

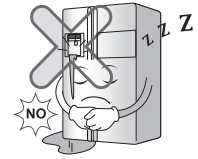

**Supply the automatic ice maker with drinkable water (only for the model with the dispenser).**

Otherwise, it may cause any risk.

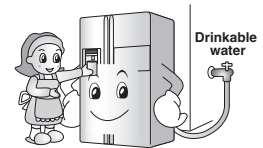

**Do not remove the cover of the automatic ice maker. (Only for the models with automatic ice maker)**

The operation mechanic parts of the ice maker may hurt people.

**Do not place the food in disorder inside the refrigerator.**

The food may fall during opening and closing the door of the refrigerator and hurt people.

**Do not put bottle in the freezer.**

It may freeze the contents to break the bottle to cause injury.



**Do not insert the hands into the bottom of the refrigerator.**

The iron plate of the bottom may cause injury.

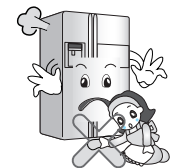

**Carry the refrigerator with the handle bar at the bottom of the front and the top of the rear.**

Otherwise, your hands may be slipped to cause injury. Because the product is heavy, carrying it alone may hurt people or accidents may occur.

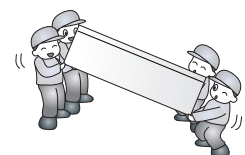

**Because opening or closing the door or the home bar of the refrigerator may cause injury to the person around it, be careful, please.**

Opening or closing the door may cause feet or hands to be caught in the chink in door or the child to be get hurt by the corner.

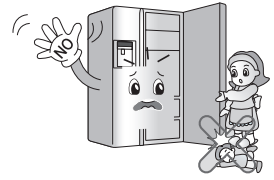

**Do not put any living animal in the refrigerator.**

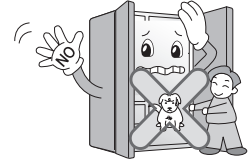

## Identification of parts

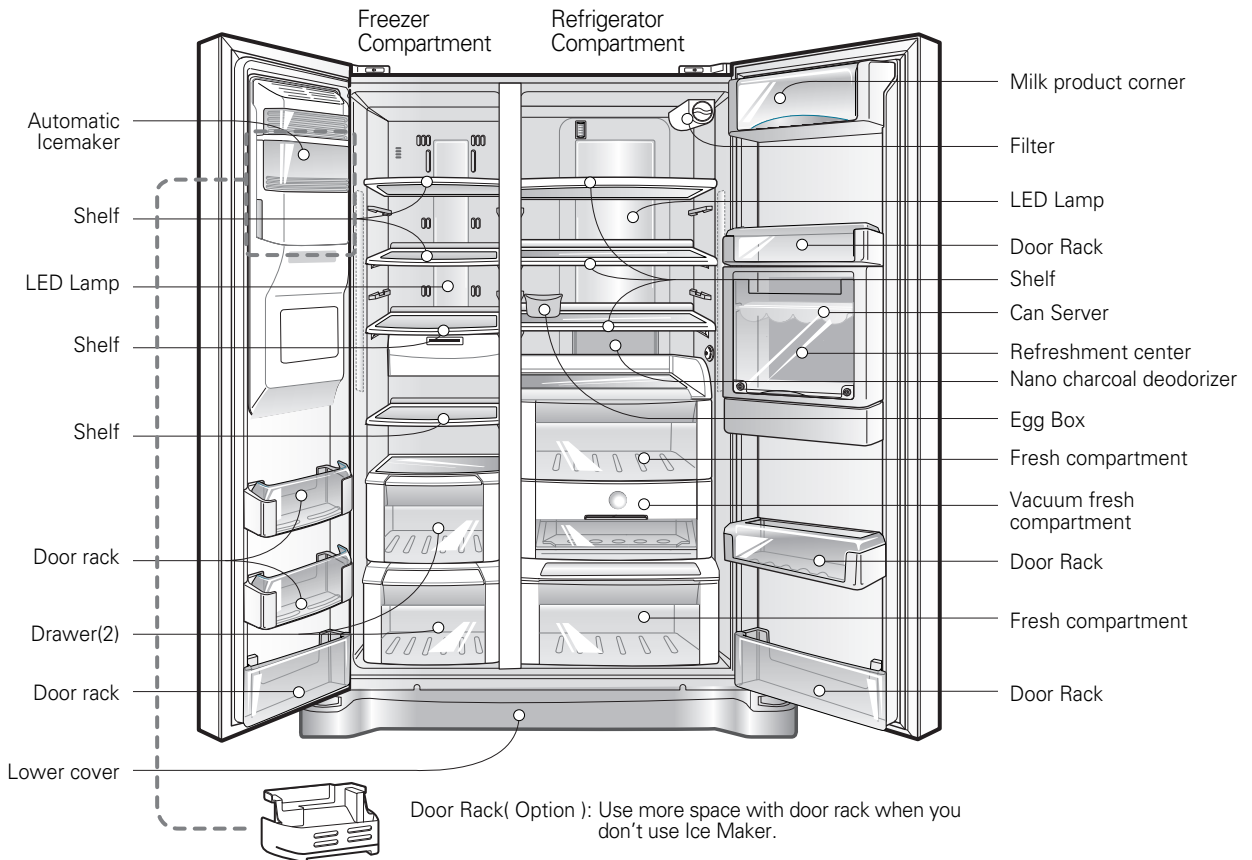

### NOTE

- Parts, features, and options vary by model. Your model may not include every option.

### Usage of door rack

- Disassemble and empty the automatic icemaker.
- Turn off the ice maker ( ① ).
- Assemble the Door rack with care.

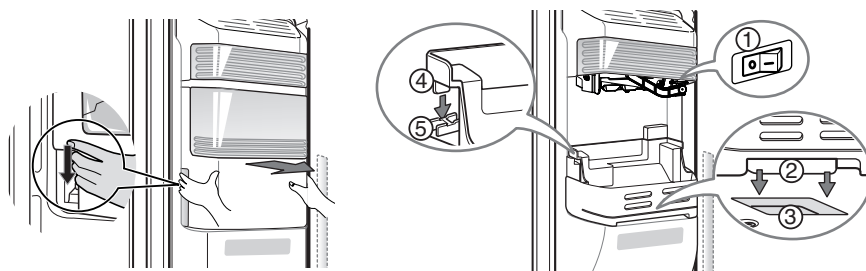

- ▶ Insert ② into bottom hole ( ③ ).
- ▶ Both hooks ( ④ ) should be assembled behind ⑤.
- ▶ Don't store any food easily fallen. It might fall to the floor when you open the door.

## Where to Install

### Select a good location

1. Place your appliance where it is easy to use.
2. Avoid placing the unit near heat sources, direct sunlight or moisture.
3. To ensure proper air circulation around the fridge -freezer, please maintain sufficient space on both the sides as well as top and maintain at least 2 inches (5 cm) from the rear wall.
4. To avoid vibrations, the appliance must be leveled.
5. Don't install the appliance below 5°C. It may cause affect the performance.

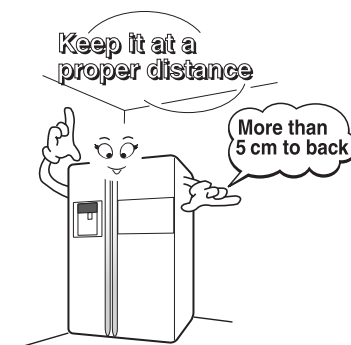

### Disposal of the old appliance

This appliance contains fluid (refrigerant, lubricant) and is made of parts and materials which are reusable and/or recyclable.

All the important materials should be sent to the collection center of waste material and can be reused after rework (recycling). For take back, please contact with the local agency.

**WARNING**

**Door removal**

**Electric Shock Hazard**

Disconnect electrical supply to refrigerator before installing. Failure to do so could result in death or serious injury.

**If your access door is too narrow for the refrigerator to pass through, remove the refrigerator door and pass the refrigerator laterally.**

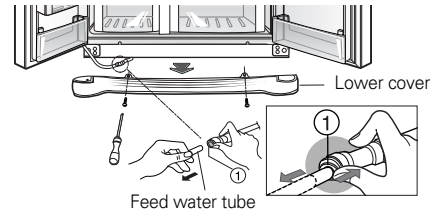

**Remove lower cover and then feed water tube**

Remove the lower cover by lifting upward and then pull up the feed water tube while pressing area ① shown in the figure to the right.

**NOTE**

- If a tube end is deformed or abraded, cut the part away.

**Remove the freezer compartment door**

1) Removing the hinge cover by loosening the screws. Separate all connection wires except for the earth line after.

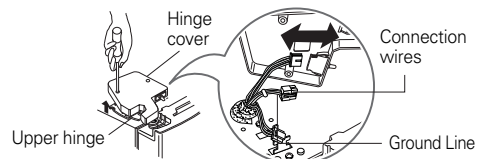

2) Remove the keeper by rotating it counter clockwise (①) and then lifting the upper hinge up (②).

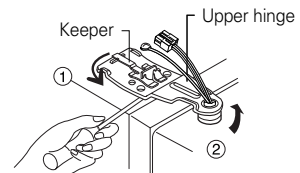

**NOTE**

- When removing the upper hinge, be careful that the door does not fall forwards .

3) Remove the freezer compartment door by lifting it upward. This time, the door should be lifted enough for the feed water pipe tube to be completely pulled out.

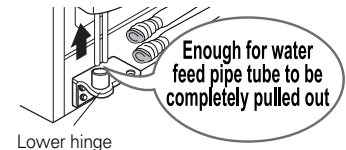

**NOTE**

- Move the refrigerator compartment door passing through the access door and lay it down, but be careful not to damage the feed water pipe tube.

**Remove the refrigerator door**

1) Loosen the hinge cover screws and remove the cover. Remove connection wire, if any, except for the earth line.

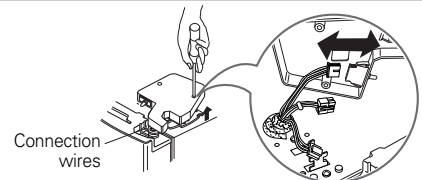

2) Remove keeper by rotating it clockwise (①) and then remove the upper hinge by lifting it up (②).

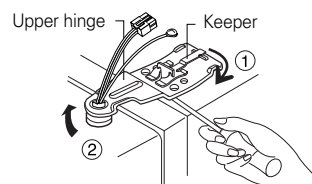

3) Remove the refrigerator compartment door by lifting it up.

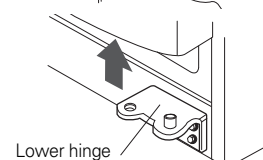

**Pass the refrigerator**

Pass the refrigerator laterally through the access door as shown in the right figure.

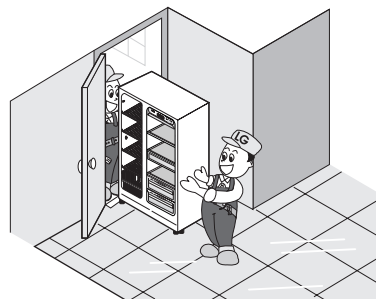
**Door replacement**

Mount them in the reverse sequence of removal after they pass through the access door.

**Feed water pipe installation****Before installation**

- Automatic ice maker operation needs water pressure of 147~834 kPa (1.5~8.5 kgf/cm<sup>2</sup>) (That is, an instant paper cup (180 cc) will be fully filled within 3 sec.).
- If water pressure does not reach the rating 147 kPa (1.5 kgf/cm<sup>2</sup>) or below, it is necessary to purchase a separate pressure pump for normal automatic icing and cool water feed.
- Keep the total length of the feed water pipe tube within 8 m and be careful for the tube not be bent. If the tube is 8 m or longer it may cause trouble in water feed owing to the drain water pressure.
- Install the feed water pipe tube at a place free from heat.

**! WARNING**

- Connect to potable water supply only.
- Refer to instructions with water filter kit for installation.

## Height adjustment

### When the floor is not leveled

- When the height of the door may not be leveled when the floor is not leveled.

#### ► When the freezer door is lower – ①

Use the (-) driver or spanner to turn the groove or nut of the height adjustment screw on the left to the counterclockwise direction to level the door.

#### ► When the fridge door is lower – ②

Use the (-) driver or spanner to turn the groove or nut of the height adjustment screw on the right to the clockwise direction to level the door.

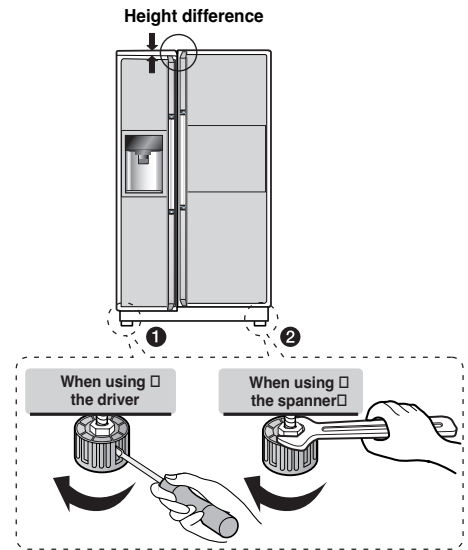

### When the fridge door is lower than the freezer door

#### ► When the fridge door is lower than the freezer door while using the refrigerator, level the doors.

1. Use the ③ tool for adjustment on the wide side to turn nut ① (↻) in the clockwise direction to loosen the keeper nut.
2. Use the ③ tool for adjustment on the narrow side to turn the adjustment hinge pin ② in (↻) clockwise direction or (↺) counterclockwise direction to adjust the height of the fridge and freezer doors.

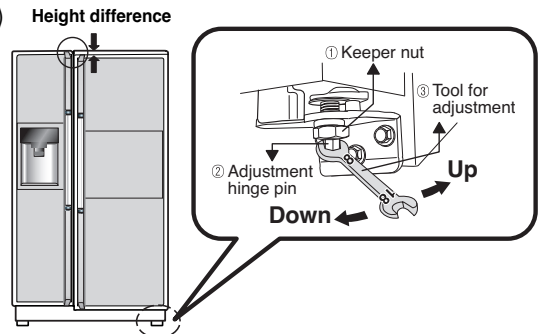

3. After aligning the height of the door, turn the keeper nut in counterclockwise direction tightly.

## ⚠ CAUTION

Do not force too hard to level the height. The hinge pin can be pulled out. (Adjustable range of height is a maximum of 2" (5 cm))

### After leveling the door height

The refrigerator doors will close smoothly by heightening the front side by adjusting the height adjusting screw. If the doors do not close correctly, performance may be affected.

#### Next

1. Wipe off all dust accumulated during shipping and clean your appliance thoroughly.
2. Install accessories such as the ice cube box, cover evaporating tray, etc., in their proper places. They are packed together to prevent possible damage during shipping.
3. Connect the power supply cord (or plug) to the outlet. Don't double up with other appliances on the same outlet.

## Starting

When your refrigerator is first installed, allow it to stabilize at normal operating temperatures for 2-3 hours prior to filling it with fresh or frozen foods. If operation is interrupted, wait 5 minutes before restarting.

## Adjusting the temperatures and functions

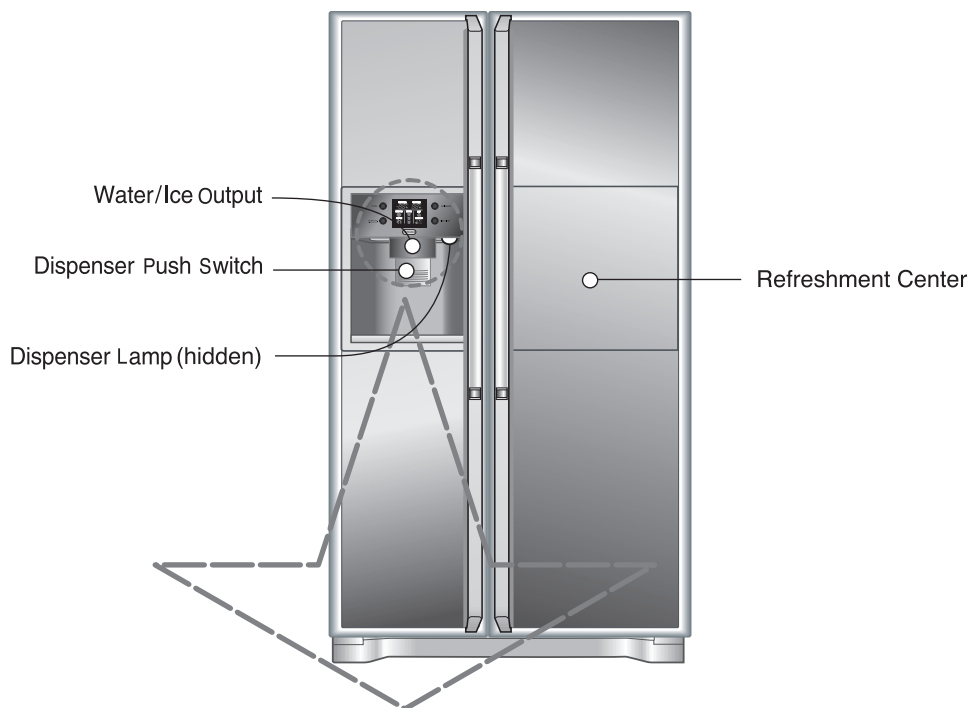

Function display board

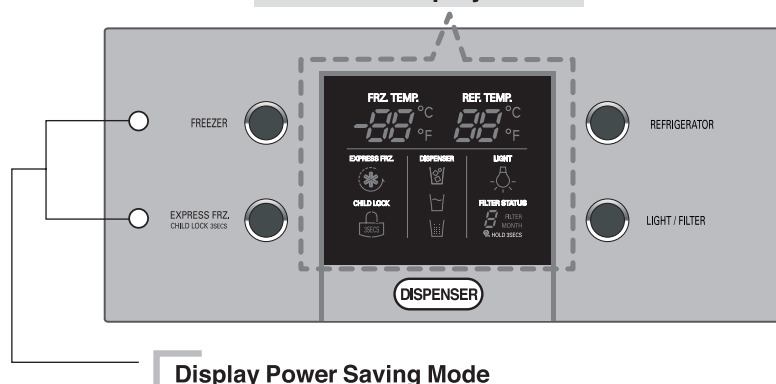





### NOTE

- Your model may not include every option.

**Display power saving**

***This function save the display power***

Press the  and  buttons simultaneously and hold them for 5 seconds until the Ding sounds. All LED/LCDs will then turn ON, then OFF. When the power saving mode is activated, the display will remain off until the next time the door is opened. Then, it will come on whenever a door is opened or a button is pressed and remain on for 20 seconds after the last door opening or button selection. To deactivate the power saving mode, press the  and  buttons simultaneously and hold them for 5 seconds until the Ding sounds.

***You can adjust temperature of and freezer room and refrigerator room.***

**Freezer control**

**Freezer Compartment temperature adjustment**

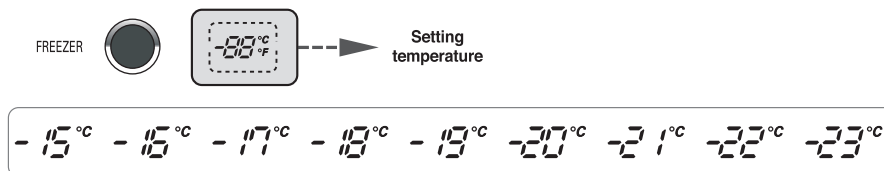

**Refrigerator control**

**Refrigerator Compartment temperature adjustment**

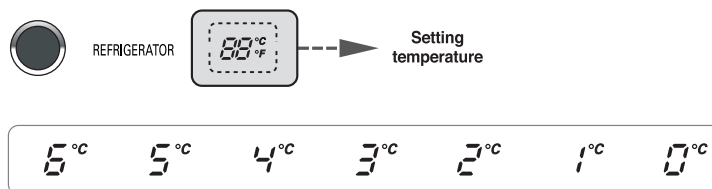

- The actual inner temperature varies depending on the food status, as the indicated setting temperature is a target temperature, not actual temperature within refrigerator.
- Refrigeration function is weak in the initial time. Please adjust temperature as above after using refrigerator for minimum 2~3 days.

**Dispenser use**

- Select among crushed ice, water, and cubed ice and press the push switch with a glass or other container.

**Crushed Ice**

Light the crushed ice lamp by pressing the selection button.



**Water**

Light the water lamp by pressing the selection button.



**Cubed Ice**

Light the cubed ice lamp by pressing the selection button.

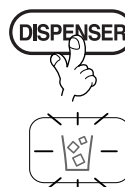

- **Reference** : Hold your cup in place for a couple of seconds after dispensing ice or water so the last few drops go in to your cup instead of the floor.

**After dispenser is used**

The water collector has no self-drainage function, so it should be cleaned regularly. Remove the cover by pulling the front of the water collector cover and dry it with a cloth.

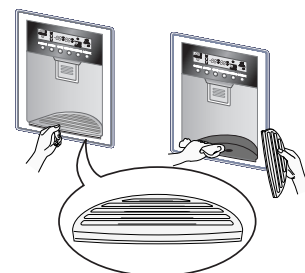

**Automatic icemaker**

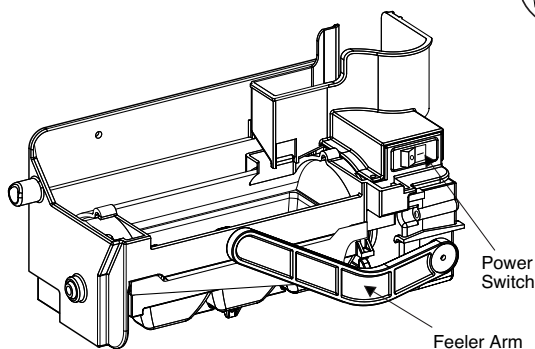

- The automatic icemaker can automatically make 6 cubes at a time, 25~35 pieces per day. This quantity may vary by circumstance, including ambient temperature, door opening, freezer load. etc.
- Icemaking stops when the ice storage bin is full.
- If you don't want to use the automatic icemaker, turn the icemaker switch to OFF. If you want to use automatic icemaker again, change the switch to ON.

**NOTE**

- It is normal that a noise is produced when ice drops into the ice storage bin.

**WARNING**

- Do not insert your hands in to the Icemaker in operation. It may cause to injure you.

**How to disassemble the automatic icemaker**

Hold the ice maker cover with both hands and pull it toward you while pressing the button on part (1).

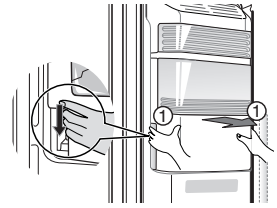

**WARNING**

- Do not disassemble the ice maker unless it is necessary.
- Hold the ice storage bin using both hands so that it does not fall.
- Do not touch the ice dispenser with your hand or tool.
- Because the ice maker can operate by opening the freezer door, please take precaution.
- When you want to use the ice bucket space as the storage space, make sure to use it by turning off the ice maker after removing the ice bucket.

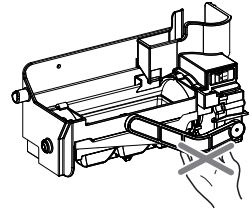

**When ice maker does not operate smoothly**

**Ice is lumped together**

- When ice is lumped together, take the ice lumps out of the ice storage bin, break them into small pieces, and then place them into the ice storage bin again.
- When the ice maker produces too small or lumped together ice, the amount of water supplied to the ice maker need to adjusted. Contact the service center.
- ※ If ice is not used frequently, it may lump together.

**Power failure**

- Ice may drop into the freezer compartment. Take the ice storage bin out and discard all the ice then dry it and place it back. After the machine is powered again, crushed ice will be automatically selected.

**The unit is newly installed**

- It takes about 12 hours for a newly installed refrigerator to make ice in the freezer compartment.

**Express freezer**

**Please select this function for prompt freezer.**

- OFF → ON → OFF is repeated whenever pressing  button.
- The arrow mark graphic remains at the On status after flickering 4 times when selecting Special Refrigeration On.
- Prompt freezer function automatically turns off after a fixed time passes.

EXPRESS FRZ.  
CHILD LOCK 3SECS

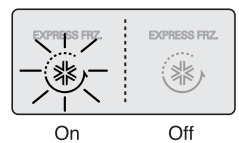

**Lock**

***This button stops operation of different button.***

- Locking or Release is repeated whenever the  is pressed more than 3 seconds.
- If you use the  button, none of the other buttons will work until you unlock them.

EXPRESS FRZ.  
CHILD LOCK 3SECS

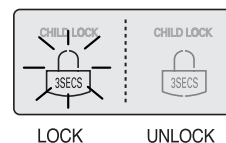

**Filter condition  
(filter replacement  
cycle) display  
function**

- There is a replacement indicator light for the water filter cartridge on the dispenser.
- The water filter should be replaced every six months.
- The filter light comes on to let you know when to replace filter.
- After replacing the filter, press and hold the filter button more than 3 seconds to reset the indicator.



LIGHT / FILTER

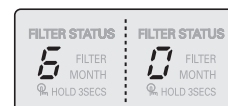

**Dispenser light**

***This button turn the dispenser light in the dispenser on an off.***

- The dispenser light function is turned ON or OFF by pressing  button.



LIGHT / FILTER

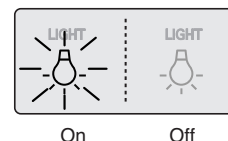

**The other  
functions**

***Door open warning***

- 3 times of warning sounds at the interval of 30 seconds if a minute passes with the door of refrigerator and the hombar door opened or completely closed.
- Please contact with the local service center if warning continue to sound even after closing the door.

***Diagnosis (failure detection) function***

- Diagnosis function automatically detects failure when failure is found in product during the use of refrigerator.
- If failure occurs at product, it does not operate though pressing any button and normal indication is not done. In this case, do not turn power off but immediately contact with the local service center. A lot of time are need for service engineer to detect the failed part if turning it off.

## How ice/cold water is supplied

Water is cooled while stored in the water tank in the refrigerator compartment, and then sent to the dispenser. Ice is made in the automatic ice maker and sent to the dispenser divided into crushed or cubed form ice.

### NOTE

- It is normal that the water is not very cold at first. If you want colder water, add ice into the glass.

## CAUTION

### **Throw away the ice (about 20 pieces) and water (about 7 glasses) first made after refrigerator installation.**

The first ice and water may include particles or odor from the feed water pipe or feed water box. This is necessary in case that the refrigerator has not been used for a long time.

### **Keep children away from the dispenser.**

Children may push switch incorrectly and damage lamps.

### **Be careful that food is not block the ice passage.**

If foods are placed at the entrance of ice passage, ice may not be dispensed. The ice passage may also be covered with ice powder if splinter ice is used only. This time, remove the ice powder accumulated.

### **Never store beverage cans or other foods in ice storage bin for the purpose of rapid cooling.**

Such actions may damage the automatic ice maker.

### **Never use thin crystal glass or crockery to collect ice.**

Such glasses or containers may be broken.

### **Put ice first into a glass before filling water or other beverages.**

Water may be splashed if ice is added to existing liquid in a glass.

### **Never touch a hand or other tools on ice outlet.**

Touch may cause a part breakage or hand injury.

### **Never remove the ice maker cover.**

### **Sometimes level the surface so that the ice storage bin is fully filled with ice.**

Ice is piled up just near the ice maker. So, such status may be considered, by the ice maker, that the ice storage bin is fully filled and ice making operation may stop.

### **If discolored ice is dispensed, immediately contact service center, stopping use.**

### **Never use too narrow or deep glass.**

Ice may be jammed in ice passage and, thus, the refrigerator may be failed.

### **Keep the glass at a proper distance from ice outlet.**

A glass too close to the outlet may hinder ice from coming out.

## Refreshment center

### How to use the Home Bar

1. Press the top central part of the Home Bar until you hear the "Click" sound.
  - You can save electricity because you do not have to open the refrigerator door.
  - Because the indoor lamps of the fridge and freezer are turned on even when you open only the Home Bar door, you can easily take out the food you want.
  - When closing the Home Bar, press until you hear the "Click" sound.
2. Open the door and use the door as the support board.
  - Put the beverage or food on the support board for convenience of use.

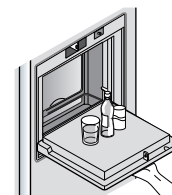
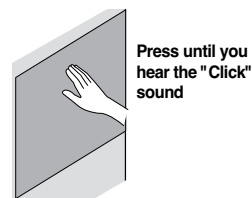

### How to use the can server

#### You can use the can server on the top and side to arrange and store the cans.

1. Pull down the handle when you want to store the cans.
  2. If you do not want to use the can server, fixate the can server on the top so that you can utilize the space of Home Bar more effectively.
- \* When you press both sides of the bottom part of the cover on the main unit of the fridge and freezer Home Bar, it will be fixated to prevent the food inside the Home Bar from falling into the fridge or freezer.

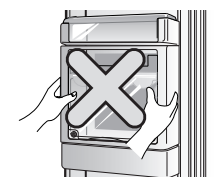
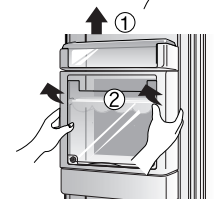
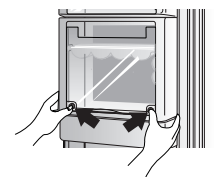
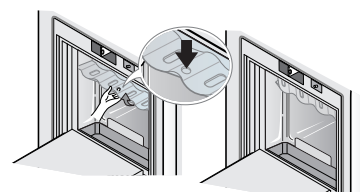

### How to disassemble the fridge Home Bar cover

First separate the upper door basket of the Home Bar (1) and then pull up the Home Bar cover(2).

### Precaution

1. Do not use the refrigerator with the internal Home Bar cover taken out.
  - If the cover is taken out, the Home Bar function cannot work.
2. Be careful not to press or damage the Home Bar support board.
  - If you lean or press the support board with your arm, it can be damaged.
  - Do not use the support board as a cutting board or use sharp tools on the support board to prevent any scratches.
  - When the support board is wet with alien fluid such as juice, it may not operate properly.
  - When the packing part is wet with alien fluid such as juice, periodically wipe the part.

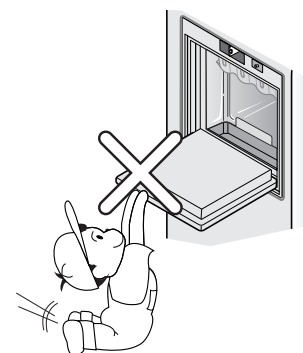

## Shelf

### How to use

You can store side dish or refrigerated food on the shelf with sufficient space in between the containers.

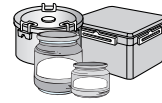

### How to disassemble

1. Hold the front part of the shelf and pull it out until it gets blocked by the hooking part.

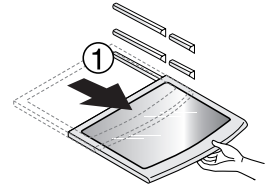

2. When you cannot pull out the shelf any more, lift it up slightly.

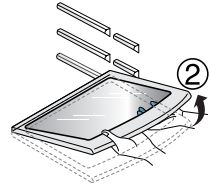

3. While holding the shelf slightly, tilt the shelf to pull it out.

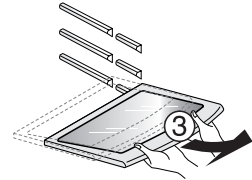

## Egg box

You can move the egg box to wherever you want.

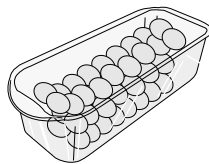

[Type-1]

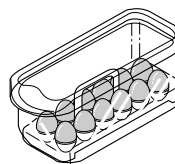

[Type-2]

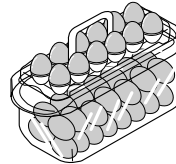

### NOTE

- Never use the egg box as an ice storage bin. It can be broken.
- Never store the egg box in the freezer compartment or fresh compartment.

## Nano charcoal deodorizer

### How to use

With the Nano charcoal deodorizer system, you can deodorize the refrigerator and the deodorizer can be reused.

### How to disassemble

Use the (-) driver on the bottom grooved part of the deodorizer cover to separate it while pushing to the front side.

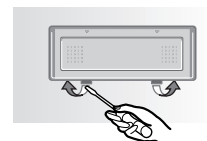

#### ► How to reuse the deodorizer

You can reuse the deodorizer continuously by drying it well with the hair dryer.

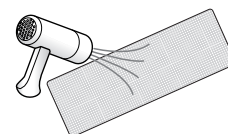

## LED lamp (Freezer/Fridge)

### How to use

1. LED operation within the fridge

- The indoor LED lamp inside the refrigerator will be turned on when you open the freezer/fridge door.
- \* The LED lamp will be turned on when you open the freezer/fridge or Home Bar door.
- \* The LED lamp can be used semi-permanently.

2. LED operation on the refrigerator door

(Applicable to model with external LED lamp)

- The ON/OFF switch of the door LED lamp is located on the top part of the refrigerator and you can see the switch when you open the refrigerator door.
- When the door LED lamp is turned ON (Fig. 1), the LED on the front door will stay on. (There is no issue with the life span of the LED lamp even when it is kept on continuously.)
- When the door LED lamp is turned OFF (Fig. 2), the LED will be turned on only when the door is opened (Including H/Bar door), and will automatically be turned off 1 minute after the door is closed.
- \* If the part where door LED lamp is installed is impacted, it may cause a problem to the door LED lamp.
- \* The door LED will be completely turned on 8 seconds after the power is initially supplied, and will immediately be turned off when the power supply is disconnected during this time.

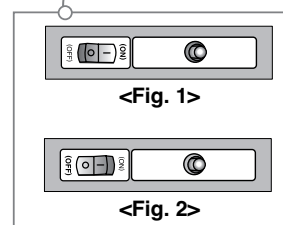
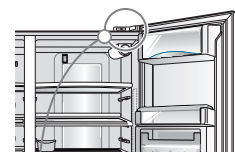

## Fresh compartment

### How to use

You can store fruits or vegetables.

### How to disassemble the upper fresh compartment

1. Hold the front handle of the fresh compartment and pull it out until it gets blocked by the hooking part.
  2. When you cannot pull out the fresh compartment any more, lift it up slightly to pull it out completely to the front side (outer side).
- \* The fresh compartment can be reassembled in the reverse order.

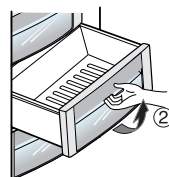
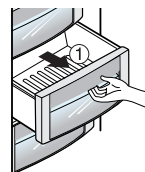

### How to disassemble the lower fresh compartment

#### ► When pulling out the lower fresh compartment

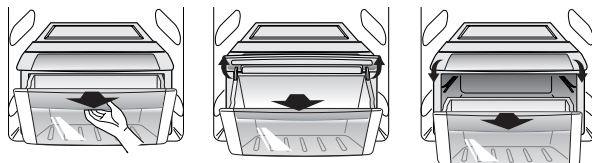

1. Hold the front handle of the fresh compartment and pull it forward.
2. When you cannot pull out the fresh compartment any more, lift it up slightly to pull it out to the front side.

#### ► When inserting the lower fresh compartment



- \* When inserting the fresh compartment, always lift the cover up to push it in.

## WARNING

- Always disassemble the fresh compartment using two hands. You can be injured from the weight of the compartment when filled with food.
- When disassembling/reassembling the fresh compartment of the fridge, open the refrigerator door fully.

### How to disassemble upper/lower fresh compartment cover

Hold the cover with both hands and pull it out.

- \* When disassembling the cover, always disassemble the fresh compartment first.

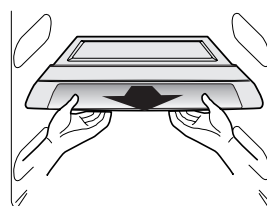

## Vacuum fresh compartment

### How to use

You can store vegetables or fruits freshly for a long period of time.

- In the middle vacuum fresh compartment, you can store the vegetable or fruit for a longer period of time with the improved seal and vacuum effect.

### How to disassemble the vacuum fresh compartment

1. Hold the front handle of the vacuum fresh compartment and pull it out until it gets blocked by the hooking part.
2. When you cannot pull out the vacuum fresh compartment any more, lift it up slightly to pull it out completely to the front side (outer side).

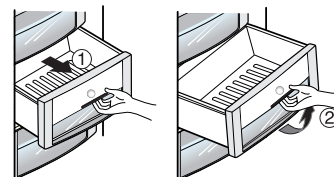

### NOTE

- You can disassemble/reassemble the freezer drawer in the same method.
- Always disassemble the fresh compartment using two hands. (You can be injured from the weight of the compartment when filled with food.)
- When disassembling/reassembling the fresh compartment or vacuum fresh compartment of the fridge, open the refrigerator door fully.

### How to disassemble the vacuum fresh compartment

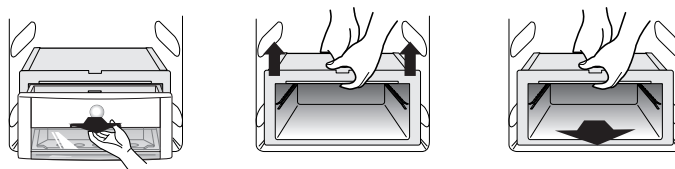

1. Pull the vacuum fresh compartment to the front and slightly lift it up to pull it out.
2. Hold the vacuum fresh compartment with both hands and slightly lift it up.  
\* To disassemble the case, you must first disassemble the upper fresh compartment.
3. Pull it out to the front.

### How to reassemble the vacuum fresh compartment

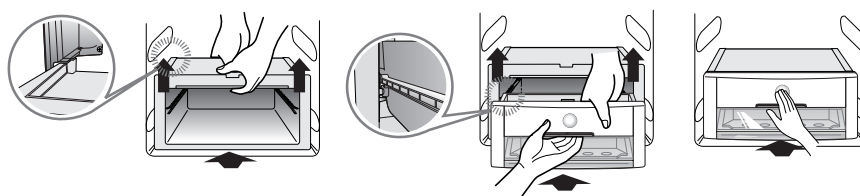

1. Align the top of the case to the side rails and push while slightly holding it up.
2. Align the bottom of the case on top of the rails and push while slightly holding it up.
3. Push the case until you hear the "Click" sound.

## WARNING

- Always disassemble the fresh compartment using two hands. You can be injured from the weight of the compartment when filled with food.
- When disassembling/reassembling the fresh compartment of the fridge, open the refrigerator door fully.

## Freezer/Fridge basket

### How to use

You can store small packaged frozen food (Freezer basket), small packaged refrigerated food or beverages (Fridge basket) such as milk, beer etc.

But, do not store ice cream or food to store for a long period of time (Freezer basket) etc.

### How to disassemble

Hold the basket with both hands and slightly lift up the front part to pull it out.

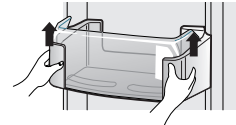

### How to reassemble

Hold the basket with both hands and reassemble one side at a time by pushing it in.

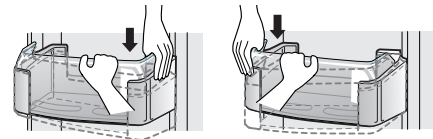

## Two stars section \*\* (Applicable to some models only)

### Freezer basket (two stars section)

- Two stars section means the space stored at  $-12^{\circ}\text{C}\sim-18^{\circ}\text{C}$
- Freezer foods for short-terms storage.

## Dairy corner

### How to use

You can store dairy goods such as butter, cheese etc.

### How to disassemble

Hold the basket with both hands and pull it out by pulling it up(1).

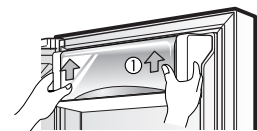

- ▶ If you close the refrigerator door with the dairy corner left open on the door side, the refrigerator door may not be closed properly. Therefore you must be careful.



## How to exchange the water purifier filter

Because the filter is assembled on the top right side of the refrigerator lamp case and it removes the residual chlorine or odor, exchange a filter once every 6 months.

### How to disassemble the filter

### How to exchange

#### 1. Disassemble the water purifier filter.

- Turn the filter to exchange in counterclockwise direction by 90 degrees. (1) Pull out the filter to the front side (2).

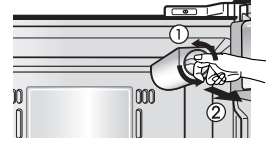

- Because water collected in the filter may drip, put a bowl slightly larger than the size of the filter underneath the filter when disassembling the filter.

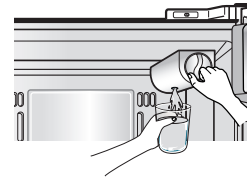

#### 2. Insert the new filter.

- Align the filter on the indicated line on the control box (1) and then push it in. After checking whether the indicated line and the indicated locking line are aligned, turn the filter in clockwise direction (2).

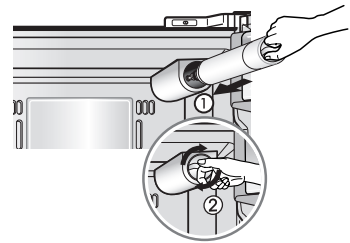

- When you have install the filter for the first time or when you have exchanged the filter, press the dispenser button once again to dispense the water for about 3 minutes (or about 1 liter) to remove any air or residual charcoal. (Charcoal is not hazardous to the human body.)

### When LED lamp doesn't light up

Is LED lamp turned on?

- LED lamp is quasi-perpetual product. Also, as it is difficult for customer to exchange directly, please contact to LG Electronics service center unless the lamp light up.

## Location of foods

(Refer to identification of parts)

### Freezer compartment shelf

Store various frozen foods such as meat, fish, ice cream, frozen snacks, etc..

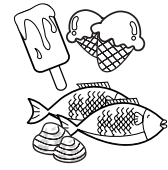

### Freezer compartment door rack

- Store small packed frozen food.
- Temperature is likely to increase as door opens. So, do not store long-term food such as ice cream, etc..

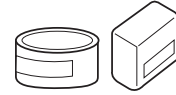

### Freezer compartment drawer

- Store meat, fish, chicken, etc.. after wrapping them with thin foil.
- Store dry.

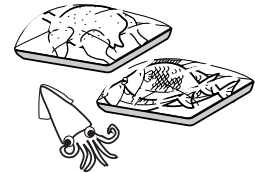

### Milk product corner

Store milk products such as butter, cheese, etc..



### Egg box

Place this egg box in the proper location.



### Refreshment center

Store foods of frequent use such as beverage, etc..



### Refrigerator compartment shelf

Store side dishes or other foods at a proper distance.

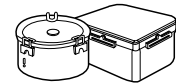

### Refrigerator compartment door rack

Store small packed food or beverages such as milk, juice, beer, etc..

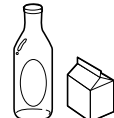

### Vegetable drawer

Store vegetables or fruits.

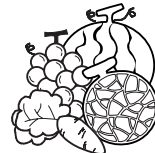

### Vegetable drawer /meat drawer conversion corner

Store vegetable, fruits, meat to thaw, raw fish, etc.. setting the conversion switch as necessary.



Be sure to check the conversion switch setting before storing foods.



## Storing foods

- Store fresh food in the refrigerator compartment. How food is frozen and thawed is an important factor in maintaining its freshness and flavor.
- Do not store food which goes bad easily at low temperatures, such as bananas, and melons.
- Allow hot food to cool prior to storing, placing hot food in the refrigerator could spoil other food, and lead to higher energy consumption.
- When storing the food, cover it with vinyl wrap or store in a container with a lid. This prevents moisture from evaporating, and helps food to keep its taste and nutrients.
- Do not block air vents with food. Smooth circulation of chilled air keeps refrigerator temperatures even.
- Do not open the door frequently. Opening the door lets warm air enter the refrigerator, and cause temperatures to rise.
- Never keep too much food in door rack because they may push against by inner racks so that the door cannot be fully closed.

### Freezer compartment

- Do not store bottles in the freezer compartment - they may break when frozen.
- Do not refreeze food that has been thawed. This causes loss of taste and nutrient.
- When storing frozen food like ice cream for a long period, place it on the freezer shelf, not in the door rack.
- Do not touch the cold foods or containers- especially made of metallic -, with wet hands and place glass products in the freezer compartment.
- That's why you may have chilblains and they may be broken when their inner matters are frozen, causing personal injury.

### Refrigerator compartment

- Always clean food prior to refrigeration. Vegetables and fruits should be washed and wiped, and packed food should be wiped, to prevent adjacent food from spoiling.
- When storing eggs in their storage rack or box, ensure that they are fresh, and always store them in an upright position, which keeps them fresh longer.

#### NOTE

- If you keep the refrigerator in a hot and humid place, frequent opening of the door or storing a lot of vegetables in it may cause dew to form which has no effect on its performance. Remove the dew with dust cloth free from care.

## General information

### Vacation time

During average length vacations, you will probably find it best to leave the refrigerator in operation. Place freezable items in freezer for longer life. When you plan not to operate, remove all food, disconnect the power cord, clean the interior thoroughly, and leave each door OPEN to prevent odor formation.

### Power failure

Most power failures that are corrected in an hour or two will not affect your refrigerator temperatures. However, you should minimize the number of door openings while the power is off.

### If you move

Remove or securely fasten down all loose items inside the refrigerator. To avoid damaging the height adjusting screws, turn them all the way into the base.

### Anti condensation pipe

The outside wall of the refrigerator cabinet may sometimes get warm, especially just after installation. Don't be alarmed. This is due to the anti-condensation pipe, which pumps hot refrigerator to prevent "sweating" on the outer cabinet wall.

## CAUTION

- You must check the O-RING, which is made by rubber and prevent electric spark.
- Don't touch lamp, in case of light on the long time.

## Cleaning

It is important that your refrigerator be kept clean to prevent undesirable odors. Spilled food should be wiped up immediately, since it may acidify and stain plastic surfaces if allowed to settle.

### Exterior

Use a lukewarm solution of mild soap or detergent to clean the durable finish of your refrigerator. Wipe with a clean damp cloth and then dry.

### Interior

Regular cleaning is recommended. Wash all compartments a baking soda solution or a mild detergent and warm water. Rinse and dry.

## NOTE

- Please do not use a dishwasher to clean the lower drawers; the high temperature may cause damage to the baskets which make them unusable.

### After cleaning

Please verify that the power cord is not damaged, power plug is not overheated, or power plug is well inserted into the power consent.

## WARNING

Always remove power cord from the wall outlet prior to cleaning in the vicinity of electrical parts (lamps, switches, controls, etc.).

Wipe up excess moisture with a sponge or cloth to prevent water or liquid from getting into any electrical part and causing an electric shock.

Never use metallic scouring pads, brushes, coarse abrasive cleaners, strong alkaline solutions, flammable or toxic cleaning liquids on any surface.

Do not touch frozen surfaces with wet or damp hands, because damp object will stick or adhere to extremely cold surfaces.

## Trouble shooting

Before calling for service, review this list. It may save you both time and expense. This list includes common occurrences that are not the result of defective workmanship or materials in this appliance.

Occurrence	Possible cause	Solution
<b>Runing of refrigerator</b>		
<b>Refrigerator compressor does not run.</b>	Refrigerator control is off.	Set refrigerator control. See setting the controls.
	Refrigerator is in defrost cycle.	This is normal for a fully automatic defrosting refrigerator. The defrost cycle occurs periodically.
	Plug at wall outlet is disconnected.	Make sure plug is tightly pushed into outlet.
	Power outage. Check house lights.	Call local electric company.
<b>Refrigerator runs too much or too long</b>	Refrigerator is larger than the previous one you owned.	This is normal. Larger, more efficient units run longer in these conditions.
	Room or outside weather is hot.	It is normal for the refrigerator to work longer under these conditions.
	Refrigerator has recently been disconnected for a period of time.	It takes some hours for the refrigerator to cool down completely.
	Large amounts of warm or hot food may have been stored recently.	Warm food will cause the refrigerator to run longer until the desired temperature is reached.
	Doors are opened too frequently or too long.	Warm air entering the refrigerator causes it to run longer. Open the door less often.
	Refrigerator or freezer door may be slightly open.	Make sure the refrigerator is level. Keep food and containers from blocking door. See problem section. OPENING/CLOSING of doors.
	Refrigerator control is set too cold.	Set the refrigerator control to a warmer setting until the refrigerator temperature is satisfactory.
	Refrigerator or freezer gasket is dirty, worn, cracked, or poorly fitted.	Clean or change gasket. Leaks in the door seal will cause refrigerator to run longer in order to maintain desired temperatures.
	Thermostat is keeping the refrigerator at a constant temperature.	This is normal. Refrigerator goes on and off to keep the temperature constant.

Occurrence	Possible cause	Solution
<b>Refrigerator compressor does not run.</b>	Thermostat is keeping the refrigerator at a constant temperature.	This is normal. The refrigerator goes on and off to keep the temperature constant.
<b>Temperatures are too cold</b>		
<b>Temperature in the freezer is too cold but the refrigerator temperature is satisfactory.</b>	Freezer control is set too cold	Set the freezer control to a warmer setting until the freezer temperature is satisfactory.
<b>Temperature in the refrigerator is too cold and the freezer temperature is satisfactory.</b>	Refrigerator control is set too cold.	Set the refrigerator control to a warmer setting
<b>Food stored in drawers freezes.</b>	Refrigerator control is set too cold.	See above solution.
<b>Meat stored in fresh meat drawer freezes.</b>	Meat should be stored at a temperature just below the freezing point of water (32°F, 0°C) for maximum fresh storage time.	It is normal for ice crystals to form due to the moisture content of meat.
<b>Temperatures are too warm</b>		
<b>Temperatures in the refrigerator or freezer are too warm.</b>	Freezer control is set too warm.	Set the freezer or refrigerator control to a colder setting until the freezer or refrigerator temperature is satisfactory.
	Refrigerator control is set too warm. Refrigerator control has some effect on freezer temperature.	Set the freezer or refrigerator control to a colder setting until the freezer or refrigerator temperature is satisfactory.
	Doors are opened too frequently or too long.	Warm air enters the refrigerator/ freezer whenever the door is opened. Open the door less often.
	Door is slightly open.	Close the door completely.
	Large amounts of warm or hot food may have been stored recently.	Wait until the refrigerator or freezer has a chance to reach its selected temperature.
	Refrigerator has recently been disconnected for a period of time.	A refrigerator requires some hours to cool down completely.
<b>Temperature in the refrigerator is too warm but the freezer temperature is satisfactory.</b>	Refrigerator control is set too warm.	Set the refrigerator control to a colder setting.

Occurrence	Possible cause	Solution
<b>Sound and noise</b>		
<b>Louder sound levels when refrigerator is on.</b>	Today's refrigerators have increased storage capacity and maintain more even temperatures.	It is normal for sound levels to be higher.
<b>Louder sound levels when compressor comes on.</b>	Refrigerator operates at higher pressures during the start of the ON cycle.	This is normal. The sound will level off as the refrigerator continues to run.
<b>Vibrating or rattling noise.</b>	Floor is uneven or weak. Refrigerator rocks on the floor when it is moved slightly.	Be sure floor is level and solid and can adequately support refrigerator.
	Items placed on the top of the refrigerator are vibrating.	Remove items.
	Dishes are vibrating on the shelves in the refrigerator.	It is normal for dishes to vibrate slightly. Move dishes slightly. Make sure refrigerator is level and firmly set on floor.
	Refrigerator is touching wall or cabinets.	Move refrigerator so that it does not touch the wall or refrigerator.
<b>Water/Moisture /Ice inside refrigerator</b>		
<b>Moisture collects on the inside walls of the refrigerator.</b>	The weather is hot and humid which increases the rate of frost buildup and internal sweating.	This is normal.
	Door is slightly open.	See problem section opening/closing of doors.
	Door is opened too often or too long.	Open the door less often.
<b>Water/Moisture /Ice outside refrigerator</b>		
<b>Moisture forms on the outside of the refrigerator or between doors.</b>	Weather is humid.	This is normal in humid weather. When humidity is lower, the moisture should disappear.
	Door is slightly open, causing cold air from the inside the refrigerator to meet warm air from the outside.	This time, close the door completely.

Occurrence	Possible cause	Solution
<b>Odors in refrigerator</b>		
	Interior needs to be cleaned.	Clean interior with sponge,warm water and baking soda.
	Food with strong odor is in the refrigerator.	Cover food completely.
	Some containers and wrapping materials produce odors.	Use a different container or brand of wrapping materials.
<b>Opening/Closing of doors/Drawers</b>		
<b>Door(s) will not close.</b>	Food package is keeping door open.	Move packages that keep door from closing.
<b>Door(s) will not close.</b>	Door was closed too hard, causing other door to open slightly.	Close both doors gently.
	Refrigerator is not level. It rocks on the floor when it is moved slightly.	Adjust the height adjusting screw.
	Floor is uneven or weak. Refrigerator rocks on the floor when it is moved slightly.	Be sure floor is level and can adequately support refrigerator. Contact carpenter to correct sagging or sloping floor.
	Refrigerator is touching wall or cabinets.	Move refrigerator..
<b>Drawers are difficult to move.</b>	Food is touching shelf on top of the drawer	Keep less food in drawer.
	Track that drawer slides on is dirty.	Clean drawer and track.
<b>Dispenser</b>		
<b>Dispenser will not dispense ice</b>	Ice storage bin is empty.	When the first supply of ice is dropped into the bin, the dispenser should operate.
	Freezer temperature is set too warm.	Turn the freezer control to a higher setting so that ice cubes will be made. When the first supply of ice is made, the dispenser should operate.
	Household water line valve is not open.	Open household water line valve and allow sufficient time for ice to be made. When ice is made, dispenser should operate.
	Refrigerator or freezer door is not closed.	Be sure both doors are closed.

Occurrence	Possible cause	Solution
<b>Dispenser will not dispense ice.</b>	Ice has melted and frozen around auger due to infrequent use, temperature fluctuations and/or power outages.	Remove ice storage bin, and thaw and the contents. Clean bin, wipe dry and replace in proper position. When new ice is made, dispenser should operate.
<b>Ice dispenser is jammed.</b>	Ice cubes are jammed between the ice maker arm and back of the bin.	Remove the ice cubes that are jamming the dispenser.
	Ice cubes are frozen together.	Use the dispenser often so that cubes do not freeze together.
	Ice cubes that have been purchased or made in some other way have been used in the dispenser.	Only the ice cubes made by the ice maker should be used with the dispenser.
<b>Dispenser will not dispense water.</b>	Household water line valve is not open. See problem "Ice maker is not making any ice."	Open household water line valve.
	Refrigerator or freezer door is not closed.	Be sure both doors are closed.
<b>Water has an odd taste and/or odor.</b>	Water has been in the tank for too long.	Draw and discard 7 glasses of water to freshen the supply. Draw and discard an additional 7 glasses to completely rinse out tank.
	Unit not properly connected to cold water line.	Connect unit to cold water line which supplies water to kitchen faucet.
<b>Sound of ice dropping</b>	This sound is normally made when automatically made ice is dropped into ice storage bin. Volume may vary according to refrigerator's location.	
<b>Sound of water supply</b>	This sound is normally made when ice maker is supplied with water after dropping the automatically made ice.	
<b>Other</b>	Please thoroughly read 'Automatic ice maker and dispenser' in this manual.	

## It is Normal...

The following occurrences are normal.

	Occurrence	Solution
<b>Noise</b>	When you hear "Tak" or "Took" sound	This is the sound of various parts expanding/contracting or various control devices operating depending on the temperature change within the refrigerator.
	When you hear "Deureureuk~", "Dulkuk" or "Woong" sound	This is the count of compressor or fan operating when the operation of the refrigerator is starting or ending. This is the same phenomenon of the sound generated when starting or turning off the engine of a car.
	When you hear "Kureureuk" sound of water flowing	This is the sound of refrigerant changing the condition in the freezer/fridge. When the liquid changes to gas, you will hear the sound of water flowing and when gas changes to liquid, you will hear the "Kureureuk" sound.
	When you hear the sound of wind such as "Shoo~" or "Shik" right after you close the door	This is the sound generated when the internal pressure is temporarily lowered when the warm air entered through the fridge or freezer is cooled fast.
	When you hear the vibrating sound	If the refrigerator is installed on wooden floor or wooden wall, or if the refrigerator is not leveled properly, the sound can be loud from the vibration.
	When you hear a loud sound after installing the product for the first time	When you operate the refrigerator for the first time, the refrigerator will operate at high speed to cool fast and the sound can seem louder. When the internal temperature falls below a certain level, the noise will subside.
<b>Door open</b>	When the door is slightly opened after closing the door	Depending on the force or speed of closing the fridge or freezer door, the door can open slightly and then get closed. Be careful not to close the door too hard.
<b>Icing/ Dew drops</b>	When there is icing or dew drops formed on the inner or outer side of the refrigerator	When external air flows into the cool inner surface of the refrigerator, icing/dew drops can be formed. Especially, this will happen more easily when you open and close the refrigerator door more frequently. Also if the humidity of the installed location is high or during the rainy season or on a rainy day, dew drops can form on the outer side of the refrigerator. This is a natural phenomenon that occurs during the humid weather. Wipe the water drops with a dry cloth.
<b>Temperature</b>	When the front side of the refrigerator is warm	Heat pipes are installed around the front part of the refrigerator and on the divider of the freezer and fridge to prevent the dew drops from forming. The refrigerator may feel warmer after the installation or during the hot summer, but this is not a problem and you can be rest assured.

## When replacing PANEL.....

(Be sure to read before replacing Panel.)

When replacing Panels (A, B, C, D), contact a qualified service representative to perform this operation, and follow these important steps.

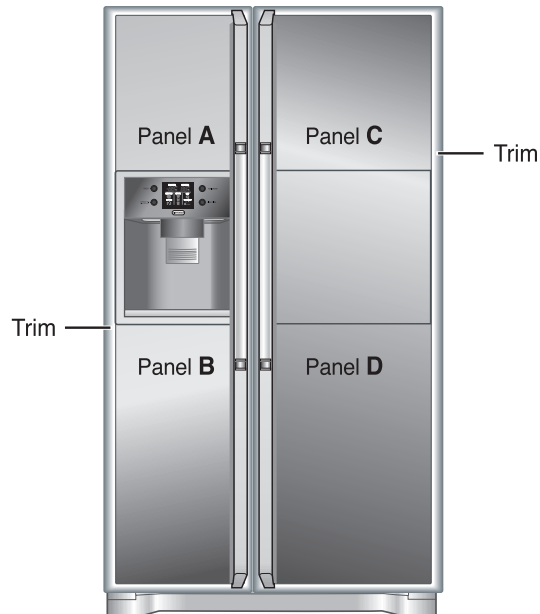

1. Avoid damaging the Panel. If damaged, it may cause personal injury.
2. When using glass as a material for panel, tempered glass must be used. Ordinary glass may cause personal injury if broken.
3. The total weight of the Panels (a, b, c, d) to be replaced should not weigh more than 15kg. If overweight, the hinge strength may be decreased, resulting in door Sagging etc.

4. The thickness of the Panel in the Trim assembly is 3.2~3.5 mm.

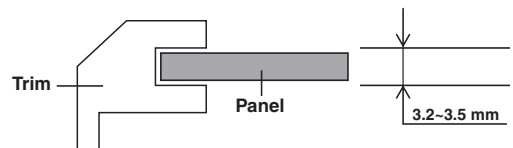

5. Size of Panel (Width x Height)
  - Panel (A) : 380 mm x 502.5 mm
  - Panel (B) : 380 mm x 806 mm
  - Panel (C) : 504 mm x 502.5 mm
  - Panel (D) : 504 mm x 806 mm

**Caution to use refrigerator**

In changing glass of the door, glass on the front door can be broken, resulting personal injury. So handle with care.



## **LG Electronics Inc.**

---

LG Twin Tower, 20, Yoido-Dong,  
Youngdungpo-Gu, Seoul, 150-721, Korea.  
<http://www.lge.com>