



ENGLISH

OWNER'S MANUAL

DVB-T HDD/DVD RECORDER

Please read this manual carefully before operating your set and retain it for future reference.

MODEL

RHT497H/RHT498H/RHT499H

P/NO : MFL42689438



CAUTION: TO REDUCE THE RISK OF ELECTRIC SHOCK DO NOT REMOVE COVER (OR BACK) NO USER-SERVICEABLE PARTS INSIDE REFER SERVICING TO QUALIFIED SERVICE PERSONNEL.

 This lightning flash with arrowhead symbol within an equilateral triangle is intended to alert the user to the presence of uninsulated dangerous voltage within the product's enclosure that may be of sufficient magnitude to constitute a risk of electric shock to persons.

 The exclamation point within an equilateral triangle is intended to alert the user to the presence of important operating and maintenance (servicing) instructions in the literature accompanying the product.

WARNING: TO PREVENT FIRE OR ELECTRIC SHOCK HAZARD, DO NOT EXPOSE THIS PRODUCT TO RAIN OR MOISTURE.

WARNING: Do not install this equipment in a confined space such as a book case or similar unit.

CAUTION: Do not block any ventilation openings. Install in accordance with the manufacturer's instructions.

Slots and openings in the cabinet are provided for ventilation and to ensure reliable operation of the product and to protect it from over heating. The openings should be never be blocked by placing the product on a bed, sofa, rug or other similar surface. This product should not be placed in a built-in installation such as a bookcase or rack unless proper ventilation is provided or the manufacturer's instruction has been adhered to.

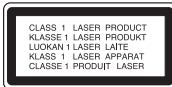

CAUTION: CLASS 3B VISIBLE AND INVISIBLE LASER RADIATION WHEN OPEN AND INTERLOCKS DEFEATED AVOID EXPOSURE TO THE BEAM.

CAUTION: This product employs a Laser System.

To ensure proper use of this product, please read this owner's manual carefully and retain it for future reference. Should the unit require maintenance, contact an authorized service center.

Use of controls, adjustments or the performance of procedures other than those specified herein may result in hazardous radiation exposure.

To prevent direct exposure to laser beam, do not try to open the enclosure.

Visible laser radiation when open. DO NOT STARE INTO BEAM.

CAUTION: The apparatus should not be exposed to water (dripping or splashing) and no objects filled with liquids, such as vases, should be placed on the apparatus.

CAUTION concerning the Power Cord

Most appliances recommend they be placed upon a dedicated circuit;

That is, a single outlet circuit which powers only that appliance and has no additional outlets or branch circuits. Check the specification page of this owner's manual to be certain. Do not overload wall outlets. Overloaded wall outlets, loose or damaged wall outlets, extension cords, frayed power cords, or damaged or cracked wire insulation are dangerous. Any of these conditions could result in electric shock or fire. Periodically examine the cord of your appliance, and if its appearance indicates damage or deterioration, unplug it, discontinue use of the appliance, and have the cord replaced with an exact replacement part by an authorized service center. Protect the power cord from physical or mechanical abuse, such as being twisted, kinked, pinched, closed in a door, or walked upon. Pay particular attention to plugs, wall outlets, and the point where the cord exits the appliance. To disconnect power from the mains, pull out the mains cord plug. When installing the product, ensure that the plug is easily accessible.

This device is equipped with a portable battery or accumulator.

Safety way to remove the battery or the battery from the equipment:

Remove the old battery or battery pack, follow the steps in reverse order than the assembly. To prevent contamination of the environment and bring on possible threat to human and animal health, the old battery or the battery put it in the appropriate container at designated collection points. Do not dispose of batteries or battery together with other waste. It is recommended that you use local, free reimbursement systems batteries and accumulators.

The battery shall not be exposed to excessive heat such as sunshine, fire or the like.

Disposal of your old appliance



1. When this crossed-out wheeled bin symbol is attached to a product it means the product is covered by the European Directive 2002/96/EC.
2. All electrical and electronic products should be disposed of separately from the municipal waste stream via designated collection facilities appointed by the government or the local authorities.
3. The correct disposal of your old appliance will help prevent potential negative consequences for the environment and human health.
4. For more detailed information about disposal of your old appliance, please contact your city office, waste disposal service or the shop where you purchased the product.

CE LG Electronics hereby declares that this/these product(s) is/are in compliance with the essential requirements and other relevant provisions of Directive 2004/108/EC, 2006/95/EC and 2009/125/EC.

European representative:
LG Electronics Service Europe B.V.
Veluwezoom 15, 1327 AE Almere, The Netherlands
(Tel : +31-(0)36-547-8888)

Copyrights

- Recording equipment should be used only for lawful copying and you are advised to check carefully what is lawful copying in the area in which you are making a copy. Copying of copyright material such as films or music is unlawful unless permitted by a legal exception or consented to by the rights owner.
- This product incorporates copyright protection technology that is protected by U.S. patents and other intellectual property rights. Use of this copyright protection technology must be authorized by Macrovision, and is intended for home and other limited viewing uses only unless otherwise authorized by Macrovision. Reverse engineering or disassembly is prohibited.
- CONSUMERS SHOULD NOTE THAT NOT ALL HIGH DEFINITION TELEVISION SETS ARE FULLY COMPATIBLE WITH THIS PRODUCT AND MAY CAUSE ARTIFACTS TO BE DISPLAYED IN THE PICTURE. IN CASE OF 625 PROGRESSIVE SCAN PICTURE PROBLEMS, IT IS RECOMMENDED THAT THE USER SWITCH THE CONNECTION TO THE 'STANDARD DEFINITION' OUTPUT. IF THERE ARE QUESTIONS REGARDING OUR TV SET COMPATIBILITY WITH THIS MODEL 625p HDD/DVD RECORDER, PLEASE CONTACT OUR CUSTOMER SERVICE CENTER.

Manufactured under license from Dolby Laboratories. Dolby and the double-D symbol are trademarks of Dolby Laboratories.

"DVD Logo" is a trademark of DVD Format/Logo Licensing Corporation.

Open source software notice

This product includes

- Freetype library : copyright © 2003 The FreeType Project (www.freetype.org).
- Zlib compression library developed by Jean-loup Gailly and Mark Adler. Copyright (C) 1995-2005 Jean-loup Gailly and Mark Adler
- Doubly Linked List licensed by Artistic license. You can download this software from <http://freshmeat.net/projects/linklist/>

Contents

Before you start	5-6
Remote control	7
Main Unit	8
Hooking up the unit	9-14
Operating USB Flash Drive	14
Auto setup	15-16
Using the Home Menu	16-17
Adjust the SETUP settings	17-22
Displaying disc Information	23-24
Using the digital EPG	25-26
Play a disc	26-27
Playing DivX® movie files	28-29
Listening to a music	30
Viewing a photo	31
Recording	32-34
Editing a title	34-37
Dubbing a title	38
Language Codes	39
Area Codes	39
Troubleshooting	40-41
Specifications	42















Before connecting, operating or adjusting this product, please read this instruction booklet carefully and completely.



Before you start







Recordable and Playable discs

This unit can play and record all widely-used DVD types. The table below shows some specific compatibility differences depending on the disc types.

	HDD	DVD-R	DVD-RW	DVD-RAM	DVD+R	DVD+R(DL)	DVD+RW
Symbol used in this manual							
Logos							
Re-Writable	Yes	No	Yes	Yes	No	No	Yes
Formatting Mode (new discs)	–	Video mode	Video mode	VR mode	Auto	Auto	Auto
Editing	Yes	Limited	Yes	Yes	Limited	Limited	Yes
Play on other players	–	The player must be compatible with corresponding media and the media has to be finalized.					
Recommended discs	–	Mitsubishi(8x,16x) Verbatim(8x,16x)	Mitsubishi(4x) Verbatim(4x) JVC(4x) Maxell(4x)	Mitsubishi(3x) Maxell(5x)	Mitsubishi(8, 16x) Verbatim(8x,16x)	Mitsubishi(2.4x, 8x)	Mitsubishi(4x) HP(4x) Verbatim(4x) Ricoh(4x)

Playable discs

The table below shows the file formats and media types that this unit can playback.

	DVD	Audio CD	Data disc (DivX, JPEG, MP3 or WMA)
Symbol used in this manual			
Logos			 
Characteristics	Discs such as movies that can be purchased or rented.	Music CDs or CD-R/RWs in music CD format that can be purchased	Discs that contain DivX, JPEG, MP3 or WMA files.

Notes on discs

- Depending on the conditions of the recording equipment or the CD-R/RW (or DVD±R/RW) disc itself, some CD-R/RW (or DVD±R/RW) discs cannot be played on the unit.
- Do not attach any seal or label to either side (the labeled side or the recorded side) of a disc.
- Do not use irregularly shaped CDs (e.g., heart-shaped or octagonal). Doing so may result in malfunctions.
- Depending on the recording software & the finalization, some recorded discs (CD-R/RW or DVD±R/RW) may not be playable.
- DVD-R/RW, DVD+R/RW and CD-R/RW discs recorded using a personal computer or a DVD or CD Recorder may not play if the disc is damaged or dirty, or if there is dirt or condensation on the Unit's lens.
- If you record a disc using a personal computer, even if it is recorded in a compatible format, there are cases in which it may not play because of the settings of the application software used to create the disc. (Check with the software publisher for more detailed information.)
- This unit requires discs and recordings to meet certain technical standards in order to achieve optimal playback quality. Pre-recorded DVDs are automatically set to these standards. There are many different types of recordable disc formats (including CD-R containing MP3 or WMA files) and these require certain pre-existing conditions (see above) to ensure compatible playback.
- Customers should note that permission is required in order to download MP3 / WMA files and music from the Internet. Our company has no right to grant such permission. Permission should always be sought from the copyright owner.

Availability of copying or moving feature

From	To	MP3/WMA	JPEG	DivX	Title*1
HDD	DISC	-	-	-	Yes
DISC	HDD	Yes	Yes	Yes	Yes
USB drive	HDD	Yes	Yes	Yes	-

*1 The title is recorded from this unit.

Restrictions on copying

Some video material is copy-once protected: Such material cannot be copied to HDD or DVD. You can identify copy-once protected material during playback by displaying disc information on-screen.

- NTSC format signals from the analog or the DV inputs is not recorded correctly with this unit.
- Video signals in SECAM format (from the built-in TV tuner or from the analog inputs) are recorded in PAL format.

About the Symbol Display

"  " may appear on your TV display during operation and indicates that the function explained in this owner's manual is not available on that specific media.

Regional Codes



This unit has a regional code printed on the rear of the unit. This unit can play only DVD discs labeled same as the rear of the unit or "ALL".

- Most DVD discs have a globe with one or more numbers in it clearly visible on the cover. This number must match your unit's regional code or the disc cannot play.
- If you try to play a DVD with a different regional code from the unit, the message "Incorrect region code. Can't play back" appears on the TV screen.

Remote Control Operation

Point the Remote Control at the remote sensor and press the buttons.

Remote Control Battery Installation

Remove the battery cover on the rear of the Remote Control, and insert R03 (size AAA) battery with  and  matched correctly.

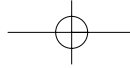

Remote control

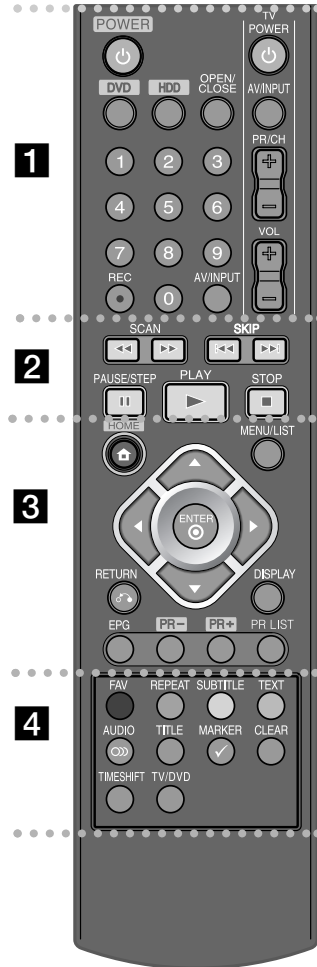

• • • • • **1** • • • • •

- POWER:** Switches the unit ON or OFF.
- DVD:** Selects the unit's mode to DVD.
- HDD:** Selects the unit's mode to HDD.
- OPEN/CLOSE:** Opens and closes the disc tray.
- 0-9 numerical buttons:** Selects numbered options in a menu.
- REC(●):** Starts recording. Press repeatedly to set the recording time.
- AV/INPUT:** Changes the input source (Tuner, AV1-3, or DV IN).

• • • • • **2** • • • • •

- TV Control Buttons:** You can control the sound level, input source, and power switch of your TV.
- SCAN (◀▶):** Search backward or forward.
- SKIP (◀◀▶▶):** Go to next or previous chapter/track/file.
- PAUSE/STEP (||):** Pause playback or recording temporarily.
- PLAY (▶):** Starts playback.
- STOP (■):** Stops playback or recording.

• • • • • **3** • • • • •

- HOME:** Accesses or removes the HOME menu.
- MENU/LIST:** Accesses menu on a DVD disc. Switches between Title List-Original and Title List-Playlist menu.
- ◀ / ▶ / ▲ / ▼ (left/right/up/down):** Used to navigate on-screen displays.

• • • • • **4** • • • • •

- ⊙ (ENTER):** Acknowledges menu selection or displays the program list.
- RETURN (↵):** Removes the on-screen displays.
- DISPLAY:** Accesses On-Screen Display.

- EPG:** Displays the EPG menu.
- PR+/PR-:** Scans up or down through memorized channels.
- PR LIST:** Displays the program list menu.

• • • • • **4** • • • • •

- Color buttons:** Use when an EPG screen is displayed or when tuned to a teletext program of a digital broadcast. The function of each button will be described on-screen, and changes depending on the screen being displayed.
- FAV:** Displays the favorite program list.
- REPEAT:** Repeat sequence, chapter, track, title, all.
- SUBTITLE:** Selects a subtitle language.
- TEXT:** Switches between teletext mode and normal TV viewing.
- AUDIO (⦿):** Selects an audio language or audio channel.
- TITLE:** Displays the disc's Title menu, if available.
- MARKER:** Selects multiple files/titles on the list.
- CLEAR:** Removes a track number on the Program List.
- TIMESHIFT:** Activates pause live TV/playback (timeshift) for a live TV program.
- TV/DVD:** Press to switch between 'TV mode', in which you get the picture and sound from the TV's tuner, and 'DVD mode', in which you get picture and sound from this unit.

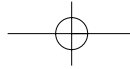

Main Unit

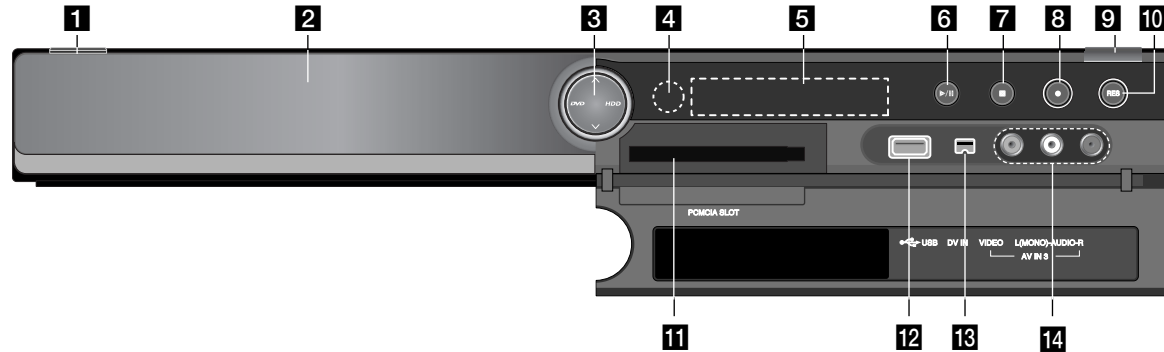

- 1** **⏻ / I (POWER button)**
Switches the unit ON or OFF.
- 2** **Disc Tray**
Insert a disc here.
- 3** **DVD**
Set the recorder's mode to DVD.
HDD
Set the recorder's mode to HDD.
▲ / ▼: Scans up or down through memorized channels.
- 4** **Remote Sensor**
Point the remote control here.
- 5** **Display window**
Shows the current status of the unit.
T/S: Indicates the timeshift mode.
REC: The unit is recording.
HDD: The unit is in HDD mode.
DVD: The unit is in DVD mode.
HDD ◀▶ DVD: The unit is dubbing.

⌚ : Indicates when the unit is in timer recording or a timer recording is programmed.

18:88:88 : Indicates clock, total playing time, elapsed time, title number, chapter/track number, channel, etc.

- 6** **▶ / II (PLAY / PAUSE)**
Starts playback.
Pause playback or recording temporarily, press again to exit pause mode.
- 7** **■ (STOP)**
Stops playback or recording.
- 8** **● (REC)**
Starts recording. Press repeatedly to set the recording time.
- 9** **⏪ / ⏩ (OPEN/CLOSE)**
Opens or closes the disc tray.
- 10** **RESOLUTION**
Sets the output resolution for HDMI and COMPONENT OUTPUT jacks.
- HDMI: 576i, 576p, 720p, 1080i, 1080p
- COMPONENT: 576i, 576p

- 11** **COMMON INTERFACE(CI) SLOT**
Slot for external Conditional Access (CA)-module and smart card used to decode scrambled channels. (page 10)
- 12** **USB Port**
Connect an USB Flash memory.
- 13** **DV IN**
Connect the DV output of a digital camcorder.
- 14** **AV IN 3 (VIDEO IN/AUDIO IN (Left/Right))**
Connect the audio/video output of an external source (Audio system, TV/ Monitor, VCR, Camcorder, etc.).

Hooking up the unit

1 Antenna connection

Connect the Terrestrial TV antenna to the ANTENNA IN jack on the unit.
If you want to use an indoor antenna, use one with a signal amplifier rated at 5V, 100mA and set [Antenna Feed 5V] to [ON] in the setup menu.

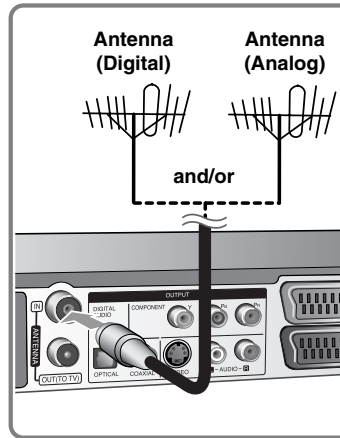

3 SCART connection

Connect one end of the scart cable into the AV1 SCART jack on the unit and other end to the corresponding in jack on your TV.
You can get Audio and Video signals together with this connection.

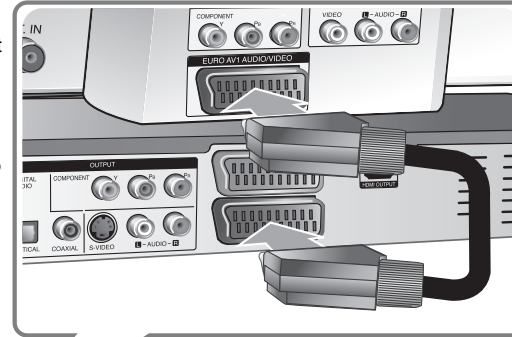

2 Antenna connection to your TV

Connect one end of the RF cable to ANTENNA OUT jack on the unit and other end to ANTENNA IN jack on your TV.
Passes the signal from the ANTENNA IN jack to your TV/monitor.

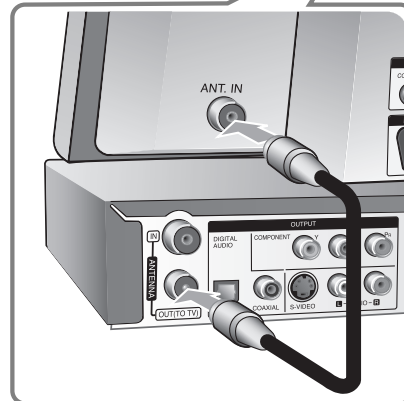

4 Power cord connection

Connect the mains lead to the AC IN terminal on the unit. Then plug the power cord into the mains.

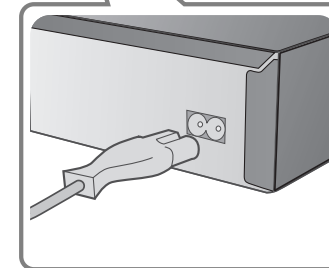

Hooking up the unit - more you can do

General about connection

Picture and sound

Digital TV is a transmission technology that replaces the traditional analogue technique.

This means that several TV channels, radio channels and other digital services can be transmitted on the same space as just one channel took up before. As a consumer you get access to many more channels and services than before at the same time as they are received with perfect picture and audio quality.

The recorder converts the digital signal into a format that is suitable for your TV and sound system.

Connecting your recorder is just as simple as connecting for example a video recorder. You get the best picture quality by using a HDMI cable for connection to your TV-set. The best audio experience is obtained by connecting an optical cable to your sound system.

Scrambled transmissions

The content or some parts of the content transmitted in the terrestrial network may be scrambled. Your recorder is equipped with one slot to connect a de-scrambling modules (Conditional Access Modules) and smart card for receiving scrambled channel.

The Module, smart-card and subscription may be obtained from your local dealer or directly from the service provider.

Coverage

Before buying this product it is anticipated that you have made sure that there are digital transmissions covering your region.

Antenna / Signal source

Depending on the reception your recorder may be connected to a simple indoor antenna or to an existing outdoor antenna system. If you live in a flat you should make sure that the digital terrestrial signals are distributed to your wall antenna outlet. If you have your own antenna system you must make sure that it is equipped with antennas, filter and/or amplifier that can handle those frequencies that the digital channels are transmitted on.

Cable-TV

Please observe that this recorder is not designed for the reception of regular digital cable-TV signals (QAM-signal). Despite this, operators of smaller cable networks may have chosen to distribute the digital terrestrial signals (COFDM-signal) in the network. In this case this recorder may well be used.

Check with your landlord if you are insecure about what type of TV-signal that is provided in the wall antenna outlet.

Component connection

Connect one end of the component(Y PB PR) cable to the COMPONENT OUTPUT jack on the unit and other end to the COMPONENT INPUT jack on your TV.

Connect one ends of the audio cables (red and white) to the analog AUDIO OUTPUT jack on the unit and other ends to the AUDIO INPUT jack on your TV.

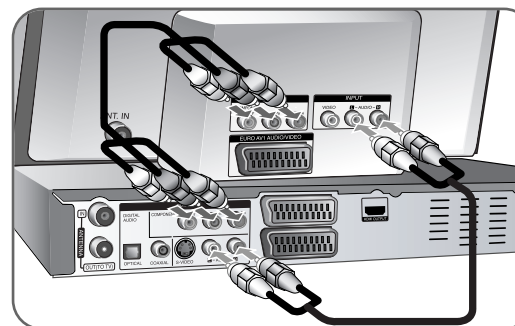

If your television is a high-definition or "digital ready" television, you may take advantage of the unit's progressive scan output for the highest video resolution possible. If your TV does not accept the Progressive Scan format, the picture will appear scrambled with the progressive signal.

Set the resolution to 576p using RES. button on the front panel to obtain the progressive signal.

S-Video connection

Connect one end of the S-Video cable to the S-VIDEO OUTPUT jack on the unit and the other end to the S-Video INPUT jack on your TV.
Connect one ends of the audio cables (red and white) to the analog AUDIO OUTPUT jack on the unit and the other ends to the AUDIO INPUT jack on your TV.

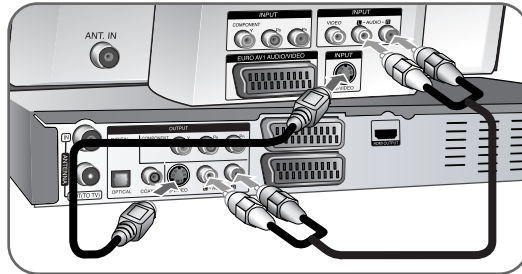

Digital audio connection

Connecting to an amplifier/receiver, Dolby Digital/MPEG/DTS decoder or other equipment with a digital input.

Connect one end of the digital audio cables (COAXIAL or OPTICAL) to the digital audio output jack (COAXIAL or OPTICAL) on the unit and other end to the digital audio input jack (COAXIAL or OPTICAL) on your amplifier.

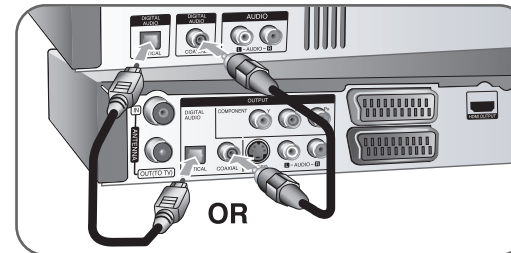

This recorder does not perform internal (2 channel) decoding of a DTS sound track. To enjoy DTS multi channel surround, you must connect this recorder to a DTS compatible receiver via one of this recorder's digital audio outputs.

HDMI connection

Connect one end of the HDMI cable to the HDMI OUTPUT jack on the unit and other end to the HDMI INPUT jack on your TV.

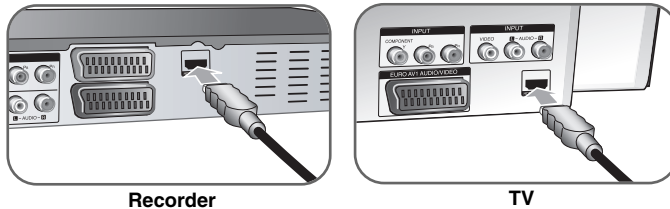

When you use the HDMI connection, you can change the resolution (576i, 576p, 720p, 1080i or 1080p) for the HDMI output by pressing RES. button repeatedly.

About HDMI

HDMI (High Definition Multimedia Interface) supports both video and audio on a single digital connection for use with DVD Players, Set-Top Boxes, and other AV devices.

HDMI was developed to provide the technologies of HDCP (High-bandwidth Digital Contents Protection). HDCP is used to protect digital content transmitted and received.

HDMI has the capability to support standard, enhanced, or high-definition video plus standard to multi-channel surround-sound audio. HDMI features include uncompressed digital video, a bandwidth of up to 5 gigabytes per second, one connector (instead of several cables and connectors), and communication between the AV source and AV devices such as DTVs.

HDMI, the HDMI logo and High-Definition Multimedia Interface are trademarks or registered trademarks of HDMI licensing LLC.

Note on HDMI connection

- If your TV is NOT capable of handling 96 kHz sampling frequency, set the [Sampling Freq.] option to [48 kHz] on the setup menu (See page 19). When this choice is made, this unit will automatically convert any 96 kHz signals to 48 kHz so your system can decode them.
- If your TV is not equipped with Dolby Digital and MPEG decoder, set the [Dolby Digital] and [MPEG] options to [PCM] on the setup menu (See page 19).

- If your TV is not equipped with DTS decoder, set the [DTS] options to [OFF] on the setup menu (See page 19). To enjoy DTS multi channel surround, you must connect this unit to a DTS compatible receiver via one of this unit's digital audio outputs.
- If there is noise or lines on the screen, please check the HDMI cable.
- Changing the resolution when the unit is connected with HDMI connector may result in malfunctions. To solve the problem, turn off the unit and then turn it on again.
- When you connect an HDMI or DVI compatible device make sure of the followings:
 - Try switching off the HDMI/DVI device and this unit. Next, switch on the HDMI/DVI device and leave it for around 30 seconds, then switch on this unit.
 - The connected device's video input is set correctly for this unit.
 - The connected device is compatible with 720(1440)x576i, 720x576p, 1280x720p, 1920x1080i or 1920x1080p video input.
- Not all HDCP-compatible DVI devices will work with this unit.
 - The picture will not be displayed properly with non-HDCP device.

What is SIMPLINK?



Some functions of this unit are controlled by TV's remote control when this unit and LG TV with SIMPLINK are connected through HDMI connection.

- Controllable functions by LG TV's remote control; Play, Pause, Scan, Skip, Stop, Power Off, etc.
- Refer to the TV owner's manual for the details of SIMPLINK function.
- LG TV with SIMPLINK function has the logo as shown above.

Connecting a PAY-TV/Canal Plus Decoder

You can watch or record PAY-TV/Canal Plus programmes if you connect a decoder (not supplied) to the unit. Disconnect the unit's mains lead from the mains when connecting the decoder. You do not need to turn on the unit to view the signals from the connected tuner on your TV.

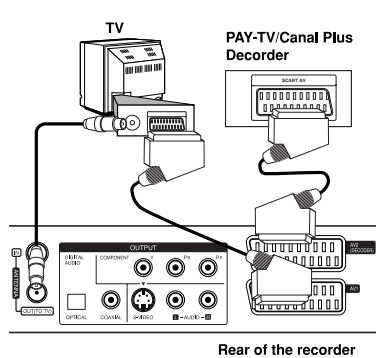

To watch or record PAY-TV/Canal Plus programmes, set [AV2 Connection] option to [Decoder] (see page 18) and set the program's [CANAL] option to [On] on the Setup menu (page 15).

If you disconnect the unit's mains lead, you will not be able to view the signals from the connected decoder.

- Pictures containing copy protection signals that prohibit any copying cannot be recorded.
- If you pass the unit signals via the VCR, you may not receive a clear image on your TV screen.
Be sure to connect your VCR to the unit and your TV in the order shown below. To watch video tapes, watch the tapes through a second line input on your TV.

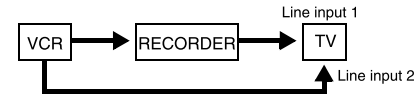

- When you record to a VCR from this unit, do not switch the input source to TV by pressing the TV/DVD button on the remote.
- If you are using a B Sky B tuner, be sure to connect the tuner's VCR SCART jack to the AV2 DECODER jack.
- If you disconnect the unit's mains lead, you will not be able to view the signals from the connected VCR or tuner.

Connecting to the AV2 DECODER jack

Connect a VCR or similar recording device to the AV2 DECODER jack of this unit. You do not need to turn on the unit to view the signals from the connected tuner on your TV.

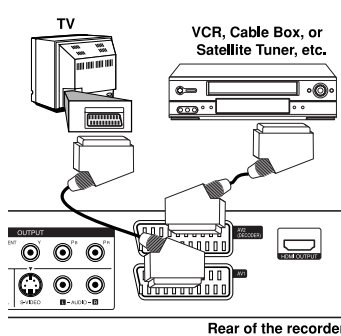

To watch or record the source from AV2 DECODER jack, set [AV2 Connection] option to [Others] (see page 18) and set [AV2 Recording] option to [Auto], [CVBS], [RGB] or [S-Video] as required (see page 21).

Connecting to the AV IN 3 Jacks

Connect the input jacks (AV IN 3) on the unit to the audio/video out jacks on your accessory component using audio/video cables.

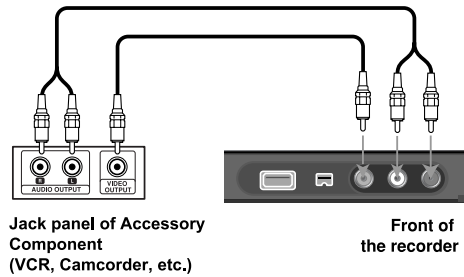

Connecting a Digital Camcorder

Using the front panel DV IN jack, it is possible to connect a DV digital camcorder and digitally transfer DV tapes to DVD.

Use a DV cable (not supplied) to connect the DV in/out jack of your DV camcorder to the front panel DV IN jack of this unit.

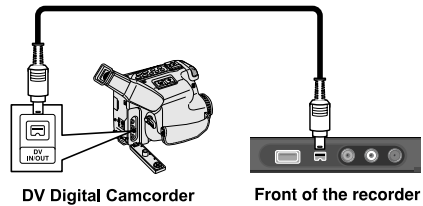

The DV IN jack is for connection to DV digital camcorder only. It is not compatible with digital satellite tuners or D-VHS video decks. Disconnecting the DV cable while recording a contents of the connected digital camcorder may result in malfunction.

Operating USB Flash Drive

	ON REMOTE
1. Insert an USB Flash Drive to the USB port:	—
2. Displays the HOME menu:	HOME
3. Select a main option: [MUSIC], [PHOTO] or [MOVIE] option	◀▶
4. Select the [USB] option:	▲▼
5. Displays corresponding menu list: For details of operations on each files, refer to relevant pages.	ENTER

Using USB Flash Drive - more you can do

Using an USB Flash Drive

This unit can play the MP3/WMA/JPEG/DivX files contained in the USB Flash Drive.

Inserting the USB Flash Drive – Insert straight-in until it fits into place.

Removing the USB Flash Drive – Withdraw the USB Flash Drive carefully when the connected USB Flash Drive is in use.

Notes on USB Flash Drive

- The contents on the disc or HDD cannot be moved or copied to a USB Flash Drive.
- Keep the USB Flash Drive out of reach of children. If swallowed, seek medical advice immediately.
- This unit supports only USB Flash Drive with FAT16 or FAT32 format.
- The USB Flash Drives which require additional software will not be supported.
- This unit is compatible with the Flash type USB device that supports USB 1.1.
- This unit may not supports some USB Flash Drive.
- **Do not extract the USB Flash Drive in operating (play, copy, etc.). It may cause a malfunction on this unit.**

Auto setup

When the first time to turn on the unit, the initial setup wizard sets the language, clock and channels automatically.

ON REMOTE

1 Turn on the unit: The initial setup wizard appears on the screen.	POWER
2 Choose a language:	▲ ▼
3 Select the chosen language:	ENTER
4 Check the antenna and go to the next step:	ENTER
5 Choose a clock setting mode:	▲ ▼
6 Select the chosen clock setting mode:	ENTER
7 Set the clock: This step is not available for Auto mode	▲ ▼ ◀ ▶ , ENTER
8 Choose a country you are using the unit:	▲ ▼
9 Choose a broadcasting type: All or Analog	▶ ▲ ▼
10 Select the [Start] and starts channel scan:	▶ ENTER
11 Close the initial setup:	ENTER

Auto setup - more you can do

Adjust the programmed channels

Press HOME, then use ◀▶ to select [Easy Menu] option. Press ENTER while [SETUP] is selected. The SETUP menu appears on the screen. Select the [Program Edit] on the second level options then press ▶ to move to the third level. Press ENTER while [Edit] option is selected. The channel editing screen appears on the screen.

Select which channel you would like to edit and press ENTER. An option menu on the left side of the screen will be highlighted.

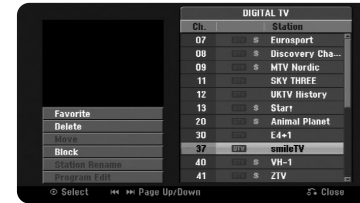

[Favorite] Set the program to favorite channel.

[Delete]: Delete the selected channel from programmed channel list.

[Move] (Analog channel only): Change the order of the channels and which numerical button they correspond to.

[Block] Blocks the program.

[Station Rename] (Analog channel only): change a name of the selected channel.

[Program Edit] (Analog channel only): Change the settings of a channel manually.

Editing a channel (Analog channel only)

You can change the settings of programmed channel by selecting [Program Edit] option on the left side of the channel editing screen.



[PR]: Indicates the selected channel position.

[Seek]: Searches for a channel automatically. Searching stops when the unit tunes in a channel.

[Ch.] Changes the channel number.

[MFT] Fine tunes the channel to obtain a clearer picture.

[CANAL]: Sets the channels for the decoder. You need this setting to watch or record PAY-TV/Canal plus programs.

[NICAM]: Sets the channels for the NICAM broadcast.

[OK]: Confirm the settings and return to the channel list menu.

Switching the program list on the channel editing screen

You can switch the program list on the channel editing screen.

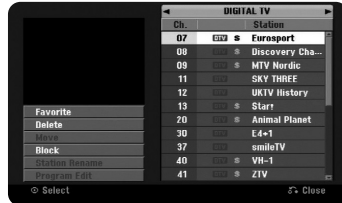

Press ▲▼ to move the highlight position to top of the program list.
Press ◀▶ to select [DIGITAL TV], [ANALOG TV] or [RADIO] then press ▲▼ to select a program on the list.

Setting a favorite program

You can set a program to favorite channel.

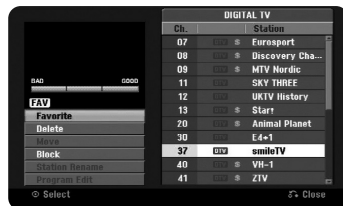

Press ▲▼ to select a program on the program list then press ENTER to highlight the option menu on the left side of the screen. Press ▲▼ to select [Favorite] option then press ENTER. The program is set to the favorite program and [FAV] appears on the TV screen.

Setting the AV1 Decoder

Sets the AV1 scart jack for inputting encoded video signals. This option sets the unit to output the encoded signal from AV1 scart jack to AV2 (DECODER) scart jack for decoding. The decoded signal is then input back through the AV2 (DECODER) jack so you can record or watch PAY-TV/Canal Plus programs.

Press AV/INPUT once while the channel editing screen appears. The [Decoder On/Off] option on the option menu. Press ENTER to turn on the option and press ENTER again to turn off. The [Canal+] appears on the screen when this option is turned on.

Using the Home Menu

	ON REMOTE
1 Displays the HOME menu:	HOME
2 Select a main option:	◀▶
3 Select a sub option:	▲▼
4 Execute the selected option:	ENTER
5 Exit the HOME menu:	HOME



Using the Home Menu - more you can do

MOVIE

HDD – Displays the [Title List] menu, which shows recorded titles on HDD. (page 34)

HDD DivX – Displays [Movie List] menu, which shows DivX® movie files on HDD. (page 28)

DISC

– Displays [Title List] menu, which shows recorded titles on the disc. (page 34)

– Displays [Movie List] menu, which shows DivX® movie files on the disc. (page 28)

– Plays DVD-Video disc (page 26).

USB – Displays [Movie List] menu, which shows DivX® movie files on the USB Flash Drive. (page 28)

PHOTO

HDD – Displays [Photo List] menu, which shows photo files on HDD. (page 31)
 DISC – Displays [Photo List] menu, which shows photo files on the disc. (page 31)
 USB – Displays [Photo List] menu, which shows photo files on the USB Flash Drive. (page 31)

MUSIC

HDD – Displays [Music List] menu, which shows music files on HDD. (page 30)
 DISC – Displays [Music List] menu, which shows music files or audio tracks on the disc. (page 30)
 USB – Displays [Music List] menu, which shows music files on the USB Flash Drive. (page 30)

Easy Menu

SETUP – Displays SETUP menu. (page 17)
 Rec Mode – Displays [Record Mode Set] option in the SETUP Menu. (page 20)
 Dubbing – Dubs a currently playing title from a finalized DVD±R or a DVD-ROM title without copy protection. (page 38)

TV

HDD – Returns to live TV viewing in HDD mode. Pressing the HDD button on the remote control will also allow you to directly choose this option.
 DVD – Returns to live TV viewing in DVD mode. Pressing the DVD button on the remote control will also allow you to directly choose this option.
 Timer Record – Displays [Timer Record] menu. (page 32)

Adjust the SETUP settings

	ON REMOTE
1 Displays the HOME menu:	HOME
2 Select the [Easy Menu] option:	◀▶
3 Select the [SETUP] option:	ENTER
4 Select a desired option on the first level:	▲▼
5 Move to second level:	▶
6 Select a desired option on the second level:	▲▼
7 Move to third level:	▶
8 Adjust or confirm the setting:	▲▼, ENTER
9 Go back to the previous level:	◀

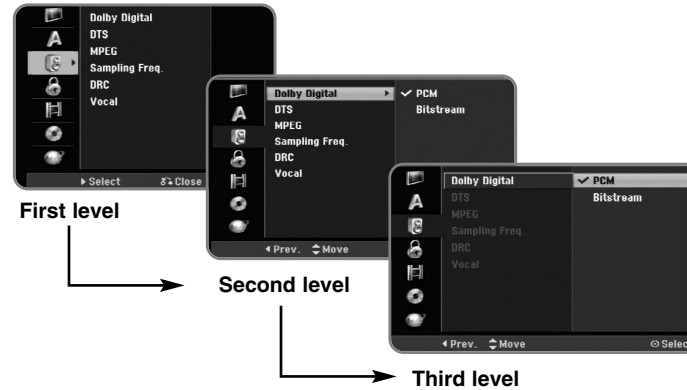

Adjust the SETUP settings - more you can do

Adjust the general settings

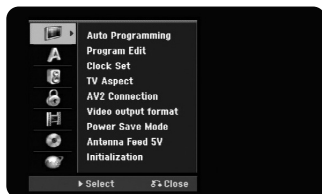

Auto Programming – This option automatically scans and sets the available channels. Password is needed to access this option, if [Lock System] option is set to [On]. (page 20)

[Country]: Select a country where you operate this unit. If the country that you want to set is not listed, select [Others].

[All, Digital or Analog]: Select a broadcasting type which you want to scan automatically.

[Start]: Start the channel scanning.

Program Edit– This option allows you to add channels and edit preset channels. Password is needed to access this option, if [Lock System] option is set to [On]. (page 20)

[Add Channel]: Select the broadcasting type between [Digital] and [Analog] and then press ▲ ▼ to select the channel and press ENTER to add the selected channel.

[Edit]: Displays the screen which show preset channel list and channel editing options. (page 15)

Clock Set– The clock must be set in order to use [Timer record].

[Auto]: Set the channel that broadcasts a clock signal and the clock will be set automatically. If the clock that has automatically set is different with your local clock, you can add more time using [Time Offset] option. (For example, when summer time is started in local area.) Press ► to select [Time Offset] option. Press ▲ ▼ to select a value then press ENTER (0, 30, 60, 90, 120). Select "0" if the clock that has automatically set is identified with your local clock.

[Manual]: If there is no channel that broadcasts a clock signal in your area, you can set the time and date manually.

TV Aspect – Selects the aspects ratio of the connected TV.

[4:3 Letter Box]: Select this when connecting to a standard 4:3 screen TV and prefer the wide picture with bands on the upper and lower portions of the screen.

[4:3 Pan Scan]: Select this when connecting to a standard 4:3 screen TV and prefer the wide picture on the entire screen cuts off the portions that do not fit.

[16:9 Wide]: Select this when connecting to a wide-screen TV.

AV2 Connection – You can connect a decoder or the other device to the AV2(DECODER) jack on the rear panel.

[Decoder]: Select this when you connect a PAY-TV or Canal Plus decoder to the AV2(DECODER) jack on the unit.

[Others]: Select this when you connect a VCR or similar recording device to the AV2(DECODER) jack on the unit.

Video output format – Select an option according to the TV connection type.

[YPbPr]: When your TV is connected to the COMPONENT OUTPUT jacks on the unit.

[RGB]: When your TV is connected to the SCART jack on the unit.

Power Save mode – Selects whether this unit is in power save mode when the power is turned off. This option is not available when a timer recording is set.

[ON]*1: The front panel display is off and only signals arriving at the antenna input are passed through when the unit is turned off.

[OFF]: Turns off the [Power Save Mode].

*1 If you turns off the unit while receiving encoded signals, the power save mode does not work

Antenna Feed 5V – If you are using an indoor antenna, use one with a signal amplifier rated at DC 5V, 100mA and set this option to [ON].

[ON]: Power is supplied to the connected antenna.

[OFF]: The unit does not supply power to the connected antenna.

Initialization – You can reset the unit to its original factory settings and format the HDD.

[Factory Set]: You can reset the unit to all its factory settings. Some options cannot be reset (Rating, Password, and Area Code). The auto setup menu appears on the screen after the factory settings.

[HDD format]: Everything recorded on the HDD will be erased.

Adjust the language settings

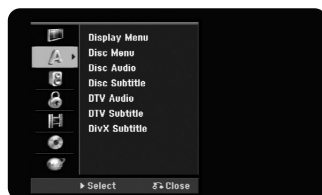

Display Menu – Select a language for the Setup menu and on-screen display.

Disc Menu/Audio/Subtitle – Select a language for the Menu/Audio/Subtitle.

[Original]: Refers to the original language in which the disc was recorded.
 [Others]: To select another language, press number buttons then ENTER to enter the corresponding 4-digit number according to the language code list on page 39. If you make a mistake while entering number, press CLEAR to delete numbers.

[OFF] (for Disc Subtitle): Turn off Subtitle.

DTV Audio – Digital channels sometimes provide multiple audio tracks, often in a different language. You can set a default audio language with this setting. If provided by the broadcaster, you can also select a different audio language while viewing TV by pressing AUDIO repeatedly.

DTV Subtitle – Digital channels sometimes provide subtitle, often in a different language. You can set a default subtitle language with this setting, if DTV subtitle is provided by the broadcaster.

Press SUBTITLE repeatedly to select a subtitle language while viewing digital TV viewing.

DivX Subtitle – Select a language code for the DivX® subtitle.

Adjust the audio settings



Dolby Digital / DTS / MPEG – Selects the type of digital audio signal when using the DIGITAL AUDIO OUTPUT jack.

[Bitstream] – Select this when you connect this unit's DIGITAL AUDIO OUTPUT jack to an audio component with a built-in Dolby Digital, DTS or MPEG decoder.

[PCM] (for Dolby Digital / MPEG) – Select this when you connect this unit's DIGITAL AUDIO OUTPUT jack to an audio component without a built-in Dolby Digital or MPEG decoder.

[Off] (for DTS) – Select this when you connect this unit's DIGITAL AUDIO OUTPUT jack to an audio component without a built-in DTS decoder.

Sample Freq. (Frequency) – Selects the sampling frequency of the audio signal.

[48 kHz]: In case of DVD with 96KHz sampling, the output is converted to 48KHz. If your receiver or amplifier is NOT capable of handling 96KHz signal, select [48KHz].

[96 kHz]: The audio signals are output in their original format.

DRC (Dynamic Range Control) – Make the sound clear when the volume is turned down (Dolby Digital only). Set to [On] for this effect.

Vocal – Select [On] to mix karaoke channels into normal stereo. This function is effective for multi-channel karaoke DVDs only.

Adjust the lock settings



To access the Lock System, DVD Rating, DTV Rating, Set Password or Area Code options, you must enter the 4-digit password. If you have not yet entered a password you are prompted to do so. Enter a 4-digit password. Enter it again to verify. If you make a mistake while entering number, press CLEAR to delete numbers.

If you forget your password, you can reset it. Displays the SETUP menu. Input '210499' and press ENTER. The password has now been cleared.

Lock System – Allows you to set up specific programs and ratings through blocking schemes. Also allows you to activate or disable all of the lock schemes previously set up. A password is required to gain access to the lock menu options. When the Lock System is set to [OFF], the [DTV Rating] is not effective.

DVD Rating – Select a DVD rating level. The lower the level, the stricter the rating. Select [No Limit] to deactivate the rating.

DTV Rating – You can set the ratings to block out all the programs with ratings above a specified level.

[No Control]: You can view all programs.

[04 Years] – [18 Years]: Rating [04 Years] has the most restrictions and [18 Years] is the least restrictive.

[Lock All]: All programs are locked. To view a program, you must input the 4-digit password you have created.

Set Password – Changes or deletes the password.

[Change]: Enter the new password twice after entering the current password.

[Delete]: Delete the current password after entering the current password.

Area code – Select a code for a geographic area as the playback rating level. This determines which area's standards are used to rate DVDs controlled by the parental lock. See the Area Codes on page 39.

DivX Reg. Code– We provide you with the DivX® VOD (Video On Demand) registration code that allows you to rent and purchase videos using the DivX® VOD service. For more information, visit www.divx.com/vod.

Press ENTER when [View] icon is highlighted and you can view the registration code of the unit.

Adjust the recording settings



Record Mode Set – Select the picture quality for recording from XP, SP, LP, EP or MLP. See recording time of each mode on page 42.

[XP]: Highest picture quality.

[SP]: Standard picture quality.

[LP]: Slightly lower picture quality than [SP] mode.

[EP]: Low picture quality.

[MLP]: The longest recording time with the lowest picture quality.

Record Aspect – This option sets the recording aspect ratio to suit the material you are recording on DVD.

DV Record Audio – You need to set this if you have a camcorder using 32kHz/12-bit sound connected to the front panel DV IN jack.

Some digital camcorders have two stereo tracks for audio. One is recorded at the time of shooting; the other is for overdubbing after shooting.

On the Audio 1 setting, the sound that was recorded while shooting is used.

On the Audio 2 setting, the overdubbed sound is used.

TV Record Audio – Select an audio channel to record when recording a bilingual program.

[Main+Sub]: Main language and sub language

[Main]: Main language only

[Sub]: Sub language only

Auto Chapter – When DVD recording, chapter markers are added automatically in every specified interval (5, 10 or 15 min.).

AV2 Recording – Selects a method of inputting video signals for the AV2(DECODER) jack. The picture will not be clear if this setting does not match the type of the video input signal.

[Auto]: The video input signal will automatically follow the video signal received.

[CVBS]: Inputs CVBS(composite) video signals.

[RGB]: Inputs RGB signals.

[S-VIDEO]: Inputs S-Video signals.

Time Shift – Set this option to [ON] make this unit to use the Time Shift function automatically without pressing TIMESHIFT button. The timeshift will start in 5 seconds after TV tuner mode is started.

Adjust the disc settings



Disc Format – You can Initialize a DVD by pressing ENTER while [Start] is selected. The [Disc Format] menu appears. The unit starts formatting after confirmation. You can select a mode between VR and Video for DVD-RW discs. The everything recorded on the DVD will be erased after formatting.

If you load a completely blank disc, the unit will initialize the disc automatically. See "Formatting mode (new disc)" on page 5 for more information.

Finalize – Finalizing is necessary when you play disc recorded with this unit on other DVD equipment. How long finalization takes depends on the disc condition, recorded length and number of titles.

[Finalize]: The [Finalize] menu appears. The unit starts finalizing after confirmation.

[Unfinalize]: The finalized DVD-RW discs can be unfinalized after confirming on the [Unfinalize] menu. After unfinalizing, the disc can be edited and re-record.

Before finalizing, check the characteristics between the disc type in the table below.

-RW	The finalized DVD-RW discs can be unfinalized so that the disc can edit or record again.
+R -R	Once you finalize a disc, you can not edit or record anything on the disc.
+RW	Discs are automatically finalized when removed from the unit.
RAM	The finalization does not needed.

Disc Label – This function allow you to change the default disc name to something more descriptive. This name appears when you load a disc and when you display disc information on-screen. The keyboard menu appears by pressing ENTER while [Edit] is selected.

Disc Protect – This function allow you to protect discs from accidental record, erasure and editing by setting this option to [ON]. The DVD-R and Video mode formatted DVD-RW are not available to protect.

Adjust the network settings

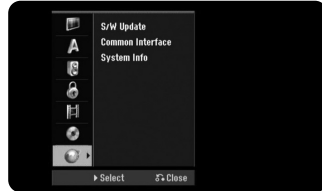

Software Update – Your recorder is able to keep the built-in digital tuner up to date with the latest software. You can either check for updates manually, or have the unit do it automatically at regular interval. While the unit is in updating, there may have a disruption in reception for a few hours. The reception should return to normal after the update is complete. This unit must be plugged into AC power to receive updates. Do not unplug your recorder while an update is in progress. The update is not available during recording, Timeshift, viewing teletext or EPG menu.

- [Standby mode] Updates the software when this unit is turned off. The check mark appears when this option is selected.
- [Operation Mode] Update the software when this unit is turned on. The check mark appears when this option is selected.
- [Time] Set the time to update the software.
- [Freq] Selects the updates interval. (Weekly or Daily)
- [Start] Updates the software immediately.

Common Interface – You can enjoy not only scrambled services using the Conditional Access Module (CAM), but also Free-To-Air services. Different CAM supports different encryption system. Contact your service provider or distributor to obtain the right kind of CAM. This unit currently supports six kinds of CAM (VIACCESS™, Nagravision, CONAX, CryptoWorks™, Irdeto or Mediaguard, etc). Only Free-To-Air services are available without CAM.

System Information – Shows system information. (software version, DTV Signal Quality and DTV Signal Strength)

Displaying disc information

	ON REMOTE
1 Play the disc loaded on the unit:	PLAY
2 Displays current status of playback:	DISPLAY
3 Displays the playback menu:	DISPLAY
4 Select an item:	▲▼
5 Adjust the playback menu settings:	◀▶
6 Exit the disc playback menu:	DISPLAY

Displaying disc Information - more you can do

Adjusting playback menu item

You can select an item by pressing ▲▼ and change or select the setting by pressing ◀▶.

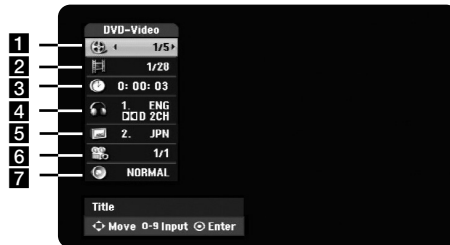

- 1 Current title/track/file / Total number of titles/tracks/files
- 2 Current chapter / total number of chapters
- 3 Elapsed playing time
- 4 Selected audio language or audio channel
- 5 Selected subtitle
- 6 Selected angle / Total number of angles
- 7 Selected sound mode

Moving to another title **HDD DVD ALL**

When a disc has more than one title, you can move to another title. Press DISPLAY twice during playback then use ▲ / ▼ to select the title icon. Then, press the appropriate numbered button (0-9) or ◀ / ▶ to select a title number.

Starting playback from selected time **HDD DVD ALL DivX**

Press DISPLAY twice during playback. The time search box shows the elapsed playing time. Select the time search box and then input the required start time in hours, minutes, and seconds from left to right. For example, to find a scene at 2 hours, 10 minutes, and 20 seconds, enter "21020" and press ENTER.

If you enter the wrong numbers, press ◀ / ▶ to move the under bar (|) to the wrong number. Then enter the correct numbers.

Selecting a subtitle language **DVD DivX**

During playback, press DISPLAY twice to display the playback menu. Use ▲▼ to select the subtitle option then use ◀▶ to select desired subtitle language.

OR

During playback, press SUBTITLE then press ◀▶ repeatedly to select a desired subtitle language.

Watching from a different angle **DVD**

If the disc contains scenes recorded at different camera angles, you can change to a different camera angle during playback.

During playback, press DISPLAY twice to display the playback menu. Use ▲▼ to select the angle option then use ◀▶ to select desired angle.

Selecting a sound mode **DVD ALL DivX**





This unit can produce a 3D Surround effect, which simulates multi-channel audio playback from two conventional stereo speakers, instead of the five or more speakers normally required to listen to multi-channel audio from a home theater system.

During playback, press DISPLAY twice to display the playback menu. Use ▲▼ to select the sound option then use ◀▶ to select desired sound mode (3D SUR. or NORMAL).

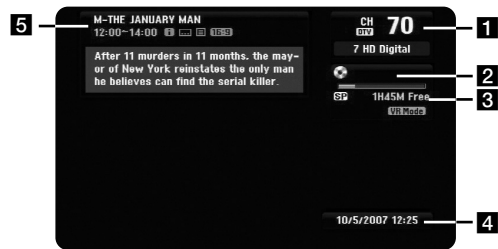
Displaying information while watching TV

During viewing the TV, Press DISPLAY to display the information displayed on-screen.



- 1** Indicates channel number, station name, and audio signal (Stereo, Bilingual, Mono) received by the tuner. (The audio signal indication is available only for the analog channels.)
- 2** Indicates media name and format.
- 3** Indicates the record mode, free space, and elapsed time progress bar.
- 4** Indicates current date and time.
- 5** Indicates program title, start time, end time, etc.
 -  (Extended Text Message Icon): Indicates that there is an Extended Text Message available to provide detailed descriptions of the program (see page 25).
 -  (DTV Subtitle Icon): Indicates that the current program contains the subtitle.
 -  (Wide Picture Icon): Indicates that the current program is shown in wide picture format.
 -  (Teletext Icon): Indicates that there is a Teletext available (see page 26).

Changing TV program

Use PR+/PR- on the remote control to change the programs in memory or use numbered (0-9) buttons to select a program directly.

Changing TV program with program list

You can display TV program list using the PR LIST button and switch into other TV program on the channel list.

While watching a program, press PR LIST to display the TV program list. Select your desired channel using the ▲ / ▼ and press ENTER to change the TV program.

Switching the program list

You can switch the program list to DIGITAL TV, ANALOG TV or RADIO.

Press ▲ to move the highlight position to top of the program list. Press ◀ ▶ to select a [DIGITAL TV], [ANALOG TV], or [RADIO]. Selected program list appears.

Displaying the favorite program list

You can display favorite channel list that organized by your private taste. To set a favorite program, use [Program Edit] option in the Setup menu. (page 18.)



Press Red colored button while watching a TV. The favorite options appears. Press ▲ ▼ to select a desired program then press ENTER to watch the selected program.

Using the digital EPG

	ON REMOTE
1 Displays the EPG menu:	EPG
2 Select a TV program:	▲▼
3 Displays the next/previous menu list:	◀▶▶▶
4 Shows the selected program currently on air:	ENTER
5 Exit the EPG menu:	EPG or RETURN

Using the digital EPG - more you can do

About the digital EPG

The digital EPG shows a table of scheduled digital TV programs and detailed information about individual program. The digital EPG screen consist of program information, channel list and general program list. Note that the unit's clock must be set to the correct time and date to ensure all relevant EPG information is displayed.

Displaying the detailed Information window

You can view detailed information for the highlighted program. Press blue color button to display detailed information window. To exit the detail information window, press blue color button again.

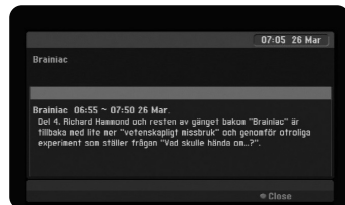

Switching the EPG menu

The EPG screen provides two search menus. Press yellow color button when the EPG menu is displayed.

- Now/Next: The screen shows now and next programs.



- 8 Days: The screen shows programs within 8 days. When the EPG menu with 8 days is displayed, you can also change the date of the EPG menu by pressing the green color button then use ◀ / ▶ to select a date.

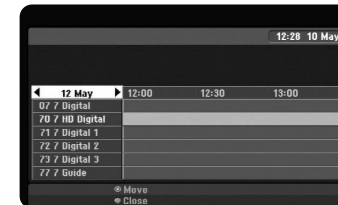

You can set a timer record using EPG menu with 8 days. Select a program then press red color button. The red timer icon will be displayed and the program will be memorized by the recorder. You can check the programming on the [Timer Record List] menu (see page 32). To cancel the timer recording, select the program then press red color button. The red timer icon disappears.

Viewing a Teletext service

Teletext is a free broadcasting service by some TV stations which gives up-to-the-minute information on news, weather, television programs, share prices and many other topics.

The recorder gives you access to teletext which is greatly improved in various aspects such as text and graphics. This teletext can be accessed by special teletext services and specific services which broadcast teletext.

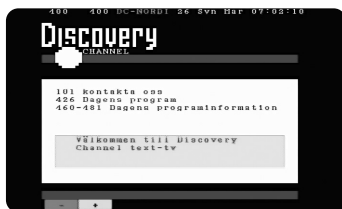

Use numbered (0-9) buttons or PR/CH on the remote control to change the program which broadcast teletext. Press TEXT to access on the teletext. Follow the indications on teletext and move onto the next or previous step by pressing color (RED or GREEN) or SKIP (◀◀ / ▶▶) buttons. Press (TEXT) or RETURN (↵) to turn the teletext off and return to TV viewing.

Selecting teletext page

Enter the desired page number as a three digit number with the numbered buttons. If during selection you press a wrong number, you must complete the three digit number and then enter the correct page number again. Use RED/GREEN buttons to move up and down pages.

Play a disc

	ON REMOTE
1 Open the disc tray:	OPEN/CLOSE (▲)
2 Insert a disc:	-
3 Close the disc tray:	OPEN/CLOSE (▲)
4 Adjust the disc menu settings: A disc menu may not appears on the screen depending on the disc.	▲ ▼ ◀ ▶, ENTER
5 Starts playback:	PLAY (▶)
6 Stops playback:	STOP (■)

Play a disc - more you can do

Playing a disc that contains a menu **DVD**

The menu screen may be displayed first after loading a DVD which contains a menu.

Use the ◀ / ▶ / ▲ / ▼ buttons to select the title/chapter you want to view, then press ENTER to start playback. Press TITLE or MENU/LIST to return to the menu screen.

Skip to the next/previous chapter/track/file

HDD DVD ALL ACD MP3 WMA DivX

Press SKIP (▶▶) to move to the next chapter/track/file.

Press SKIP (◀◀) to return to the beginning of the current chapter/track/file.

Press SKIP (◀◀) twice briefly to step back to the previous chapter/track/file.

Pause a playback

Press PAUSE/STEP (II) to pause playback. Press PLAY (▶) to continue playback.

Frame-by-Frame playback **HDD DVD ALL**

Press PAUSE/STEP (II) repeatedly to play Frame-by-Frame playback. You can advance or back up the picture frame-by-frame by pressing ◀ / ▶ repeatedly during PAUSE mode.

Fast forward or fast reverse **HDD DVD ALL ACD DivX**

Press SCAN (◀◀ or ▶▶) to play fast forward or fast reverse during playback. You can change the various playback speed by pressing SCAN (◀◀ or ▶▶) repeatedly. Press PLAY (▶) to continue play at normal speed.

Hearing a different audio **HDD DVD ALL DivX**

Press AUDIO then press ◀ or ▶ repeatedly to hear a different audio language, audio track or encoding method.

Slow down the playing speed **HDD DVD ALL**

While playback is paused, press SCAN(◀◀ or ▶▶) to slow down forward or reverse playback. You can change the various playback speed by pressing SCAN (◀◀ or ▶▶) repeatedly. Press PLAY (▶) to continue play at normal speed.

Viewing the Title menu **DVD**

Press TITLE to displays the title menu or disc menu. If the current DVD title has a menu, the title menu appears on the screen. Otherwise, the disc menu may appears.

Playing repeatedly **HDD DVD ALL ACD MP3 WMA**

Press REPEAT repeatedly to select an item to be repeated. The current title, chapter, folder or track will be played back repeatedly. To return to normal playback, press REPEAT repeatedly to select [OFF].

Repeating a specific portion (A-B) **HDD DVD ALL ACD**

Press REPEAT to select [A-] at the beginning of the portion you wish to repeat and press ENTER at the end of the portion. Your selected portion will be repeated continually. You cannot select a portion less than 3 seconds. To return to normal playback, press REPEAT repeatedly to select [OFF].

Last Scene Memory **DVD**

This unit memorizes last scene from the last disc that is viewed. The last scene remains in memory even if you remove the disc from the player or switch off the unit. If you load a disc that has the scene memorized, the scene is automatically recalled.

Playing DivX® movie files

	ON REMOTE
1 Displays the HOME menu:	HOME
2 Selects a [MOVIE] option:	◀ ▶
3 Selects an option that contains DivX file:	▲ ▼, ENTER
4 Selects a movie file from the menu:	▲ ▼
5 Plays the selected movie file:	PLAY
6 Stops the playback:	STOP

Playing a DivX® movie files - more you can do

Movie List menu options

Select which file you would like to show from the menu and press ENTER. An options menu appear on the left side of the screen.



[Play]: Starts playback the selected file.

[Open]: Opens the folder and a list of files in the folder appears.

[Delete]: Deletes the file(s) of folder (s) from the hard disk drive.

[Rename]: Edits the file name in the HDD.

[Move]: Moves selected file(s) to another folder in the HDD.

[Copy]: Copies a file(s) to another folder in the HDD.

Displaying movie file information

Press DISPLAY to show file information on the highlighted file in the movie list.

Divx file requirement

Available resolution size: 720x576 (W x H) pixel

DivX file extensions: ".avi", ".divx"

Playable DivX subtitle: ".smi", ".srt", ".sub (Micro DVD format only)", ".txt (Micro DVD format only)"

Playable Codec format: "DIV3", "MP43", "DIVX", "DX50"

Playable Audio format: "AC3", "PCM", "MP2", "MP3", "WMA"
 Sampling frequency: within 8-48 kHz (MP3), within 32-48kHz (WMA)
 Bit rate: within 8 - 320kbps (MP3), within 32 - 192kbps (WMA)

CD-R Format: ISO 9660 and JOLIET.

DVD±R/RW Format: ISO 9660 (UDF Bridge format)

Maximum Files/Disc: Less than 1999 (total number of files and folders)

Notes on DivX format

- The DivX subtitle file name has to be identified with the DivX file name to be display on the unit.
- If the subtitle file does not display properly, change the language code in the [DivX Subtitle] option. (page 19)
- If the number of the screen frame is over 29.97 frames per second, this unit may not operate normally.
- If the video and audio structure of DivX file is not interleaved, the audio and video output may not be matched properly.
- If there is impossible code to express in the DivX file name, it may be displayed as " " mark.
- If a bitrate of DivX file on the USB is over 4Mbps, the file may not be played properly.

Selecting multiple files or folders on the list

You can select not only single file but also multiple files using MARKER button. Press MARKER at the desired files to select multiple files.

Selecting all files and folders on the current list

If you want to select all files and folders on the list, press CLEAR at any file or folder on the list. Press CLEAR again to deselect files and folders. This function is not available for Audio CD.

Naming a file or folder on the HDD

You can name a file or folder on the HDD. The length of a name can be up to 32 characters long.



Select a file or folder you would like to rename then press ENTER. Select [Edit] option then press ENTER to show sub options. The keyboard menu appears by pressing ENTER while [Rename] option is selected.

Copying file(s) or folder(s) to the HDD

You can copy file(s) or folder(s) to the HDD.



Select file(s) or folder(s) you would like to copy then press ENTER. Select [Edit] option then press ENTER to show sub options. The [Copy] menu appears by pressing ENTER while [Copy] option is selected. Select a directory that you would like to copy to. Select the [Copy] option then press ENTER to begin copying.

Moving file(s) or folder(s) to the other folder on the HDD

You can move file(s) or folder(s) to the other folder on the HDD.



Select file(s) or folder(s) you would like to move then press ENTER. Select [Edit] option then press ENTER to show sub options. The [Move] menu appears by pressing ENTER while [Move] option is selected. Select a directory that you would like to move to. Select the [Move] option then press ENTER to begin moving.

Listening to a music

	ON REMOTE
1 Displays the HOME menu:	HOME
2 Select a [MUSIC] option:	◀ ▶
3 Selects an option that contains music:	▲ ▼, ENTER
4 Selects a music from the menu:	▲ ▼
5 Plays the selected music:	PLAY
6 Stops the playback:	STOP

Listening to a music - more you can do

Music List menu options

Select which file/track you would like to show from the menu and press ENTER. A menu appears on the left side of the screen.



Audio CD



MP3/WMA

[Play]: Starts playback the selected file/track.

[Random]: Starts or stops random playback.

[Open]: Opens the folder and a list of files in the folder appears.

[Delete]: Deletes the file(s) or folder(s) from the hard disk drive.

[Rename]: Edits the file name in the HDD.

[Move]: Moves selected file(s) to another folder in the HDD.

[Copy]: Copies a file(s) to another folder in the HDD.

[Program Add]: Adds a file(s)/track(s) to [Program List].

[Save]: Saves a [Program List] that you have arranged in the HDD.

[Load]: Loads a saved [Program List] in the HDD.

Displaying MP3/WMA file information

Press DISPLAY while the file you want to show the file information is selected. The unit shows the ID3-Tag information of the file. If the file does not have ID3-Tag information, [ID3-Tag: None] appears on the screen.

MP3/WMA audio file requirement

File extensions: ".mp3", ".wma".

Sampling frequency: within 8 - 48 kHz (MP3), within 32 - 48kHz (WMA)

Bit rate: within 8 - 320kbps (MP3), within 32 - 192kbps (WMA)

CD-R Format: ISO 9660 and JOLIET.

DVD±R/RW Format: ISO 9660 (UDF Bridge format)

Maximum Files/Disc: Less than 1999 (total number of files and folders)

Creating your own program

You can play the contents in the order you want by arranging the order of the musics. The program is cleared when exit the [Music List] screen.

To add or erase a music(s) on the program list, press MENU/LIST to display the [Program List].

Select a desired music from the [Music List] then press ENTER. If you want to select multiple files/tracks, press MARKER at the every desired files/tracks.

Select the [Program Add] option then press ENTER to add the selected files/tracks to the [Program List]. Select a music from the [Program List] then press PLAY to start programmed playback.

You can change the playing order using [Move] option on the program list menu.

Erasing tracks/files from Program List

To delete a music from the program list, select the music you want to delete then press ENTER. An option menu appear on the left side of the screen. Select the [Delete] option then press ENTER to erase the music from the list.

Save your Program List (HDD only)

This unit memorizes the [Program List] that you have programmed. Select a file on the [Program List] then press ENTER. Select the [Save] option then press ENTER to save the [Program List].

Viewing a photo

	ON REMOTE
1 Displays the HOME menu:	HOME
2 Selects a [PHOTO] option:	◀ ▶
3 Selects an option that contains photo file:	▲ ▼, ENTER
4 Selects a photo from the list:	▲ ▼ ◀ ▶
5 Displays the selected photo in full screen:	PLAY
6 Returns to the Photo List:	STOP

Viewing a photo - more you can do

Photo List menu options

Select which file you would like to show from the menu and press ENTER. A menu appears on the left side of the screen.



- [Full Screen]: Shows the selected file in full screen.
- [Open]: Opens the folder and a list of files in the folder appears.
- [Delete]: Deletes the file(s) or folder(s) from the hard disk drive.
- [Rename]: Edits the file name in the HDD.
- [Move]: Moves selected file(s) to another folder in the HDD.
- [Copy]: Copies a file(s) to another folder in the HDD.
- [Slide Show]: Displays the [Slide Show] menu.

Skip to the next/previous photo

Press SKIP (◀◀ or ▶▶) to view the previous/next photo while displayed in full screen.

Rotate a photo

Use ▲▼ to rotate the photo while displayed in full screen.

Viewing photo files as a slide show

To slide show photos in the [Photo list], select the [Slide Show] option on the left side of the screen then press ENTER. The [Slide Show] menu appears on the screen. Set the [Object] and [Speed] options then press ENTER while [Start] option is selected. The unit starts slide show as you set on the menu.

[Object] option:

- [Selected] Views slide show only selected files.
Use the MARKER button to select multiple files.
- [All] Views slide show all files.

[Speed] option:

Sets the Slide Show speed to [Slow], [Normal], or [Fast].

Listening to music during slide show

You can slide show photo files while listening to MP3/WMA music files on HDD. Press ENTER while [Simultaneous Music play] option is selected on the [Slide Show] menu. The music file selection menu appears on the screen. Press MARKER at the desired files to play then press ENTER while [Start] option is selected. The unit starts slide show with music playing.

[Select All]: Select all files in current directory.

[Deselect All]: Deselect all files.

Pause a slide show

Press PAUSE/STEP to pause a slide show. Press PLAY to continue the slide show.

Photo file requirement

File extension: ".jpg"

Photo size: Less than 4MB recommended

CD-R Format: ISO 9660 and JOLIET.

DVD±R/RW Format: ISO 9660 (UDF Bridge format)

Maximum Files/Disc: Less than 1999 (total number of files and folders)

Notes on JPEG file

- Progressive and lossless compression JPEG image files are not supported.
- Depending on the size and number of the JPEG files, it may take several minutes to read the contents of the media.

Recording

Follow the instruction below to record a TV channel or other source. The recording continues until the media is full, you stop the recording or the progress of recording is more than 12 hours.

ON REMOTE

1 Selects a recording mode: You can select a recording mode on the SETUP menu. (XP, SP, LP, EP or MLP)	HOME, ▲▼◀▶, ENTER
2 Selects a recording media:	HDD or DVD
3 Selects a channel or source you want to record:	PR/CH, AV/INPUT
4 Starts recording:	REC
5 Stops recording:	STOP

Recording - more you can do

Changing TV audio channel

Before recording, you can change the TV audio channel for stereo and bilingual broadcast. Press AUDIO repeatedly to change the audio channel. The current audio channel is displayed on-screen. Set the [TV Rec Audio] option in the SETUP menu when recording a bilingual broadcast.

Instant timer recording

Instant timer recording allow you to make a recording of preset length easily.

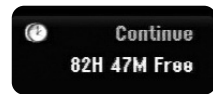

When the REC is first pressed, recording starts. Press REC repeatedly to select a certain amount of time. Each press of REC to displays the increased recording time on-screen. You can set the instant timer recording up to 240 minutes on HDD or up to 720 minutes on DVD, depending on the free space available.

Setting a timer record

This unit can be programmed to record up to 16 timer recordings within a month. The clock must be set correctly before setting a timer.



Press HOME and select TV option. Press ▲▼ to select the [Timer Record] and press ENTER to display [Timer record List] menu. Use ▲▼ to select [New] and press ENTER to display [Timer Record] menu. Adjust the each field as described below using ▲▼◀▶.

[Media]: Choose a media to record (HDD or DVD).

[CH/PR]: Choose a memorized program number, or one of the external inputs from which to record. (You cannot select DV input and radio channel.)

[Date]: Choose a date up to 1 month in advance.

[Start Time]: Set the start time.

[End Time]: Set the end time.

[Repeat] Choose a desired repeat (Once, Daily (Mon-Fri), or Weekly).

Recordings from EPG menu will always be set to [Once].

Press REC repeatedly to set the recording mode (XP, SP, LP, EP or MLP) then press ENTER to set a timer recording. The "Rec OK" or "OK" on the [Check] field on the [Timer Record List] menu indicates the timer recording is programmed correctly.



Canceling a timer recording

You can cancel a timer record before the timer recording actually starts. Select a timer recording that you want to cancel on the [Timer Record List] menu and press CLEAR.

Timer Recording Troubleshooting

Even though the timer is set, the unit will not record when:

- There is no disc loaded and there is not free space on the HDD.
- A non-recordable disc is loaded and there is not free space on the HDD.
- [Disc Protect] option is set to [ON] in the Setup menu and there is not free space on the HDD (see page 21).
- The unit is in operating (recording, copying, deleting etc.).
- There are already 99 titles (DVD-RW, DVD-R), 49 titles (DVD+R, DVD+RW) recorded on the disc and there are already 255 titles recorded on the HDD.

You cannot enter a timer program when:

- A recording is already underway.
- The time you're trying to set has already passed.
- There are already 16 timer programs set.

If two or more timer programs overlap:

- The earlier program takes priority.
- When the earlier program finishes, the later program starts.
- If two programs are set to start at exactly the same time, the program entered first takes priority.

Simultaneous playback and record

You can play other contents while you are recording. Simply press HOME and select the playable contents you want to play while recording. You cannot playback other contents while copying or dubbing. The DivX file cannot be played while recording. When you recording on a DVD, the contents on the DVD cannot be played.

Time Slip

You can watch the title that you are currently recording to HDD with this function. After the recording is progressed over 15 seconds, press PLAY to playback the title that you are currently recoding. If you stop playback the title, returns to the current recording position.

Record from a camcorder

You can record from a DV-equipped camcorder to the HDD by connecting it with a DV cable. You can also record from a digital camcorder connected to the DV in jack on the front of the unit. Press AV/INPUT repeatedly to select the DV input. Find the place on the camcorder recording that you want to begin recording from and press REC to start recording. Depending on your camcorder, you can use this recorder's remote to control the camcorder using the STOP, PLAY and PAUSE functions. Press STOP to end recording.

Recording From an external inputs

You can record from an external component, such as a camcorder or VCR, connected to any of the recorder's external inputs. Each press of the AV/INPUT changes the input source as described below. Make sure that the component you want to record from is connected properly to the unit before recording an external source.

- Tuner: Built-in tuner
- AV1: AV1 scart jack mounted on back panel
- AV2: AV2 DECODER scart jack mounted on back panel
- AV3: AV IN 3 (VIDEO, AUDIO (L/R)) mounted on the front panel
- DV: DV IN mounted on front panel

Using time shift function

This feature allow you to pause or rewind live TV, so you do not miss a thing if you were interrupted.

Press TIMESHIFT then press PAUSE/STEP while watching live broadcast before answering the phone. The timeshift function will record the broadcast of later viewing. Before using this function, make sure that the unit is in HDD mode.

If no button is pressed for 6 hours, the timeshift will stop automatically. You can use trick play functions (slow, scan, etc.) during timeshift. Refer to playback operation on page 26-27.

Stop timeshift by pressing STOP and confirm by pressing ENTER. You will returned to watch a broadcast in real time.

Jump to start or end during timeshift

Press ENTER to show progress bar during timeshift. Press ◀ to jump to the beginning and ▶ to jump to the end of the timeshift.

Clip recording

If you want to record a timeshifted program as a title, press REC at the starting point and ending point you want to record. The timeshift progress bar indicates a clip that you select with red bar. You can make more clips by repeating this instruction. The clips will be recorded when you exit the timeshift function.

Using time shift function automatically

If the [Time Shift] option in the SETUP menu is set to [ON], timeshift starts automatically without pressing TIMESHIFT button in HDD mode.

If you want to quit timeshift function, set the [Time Shift] function to [OFF].

Editing a title

Using the Title list menu, you can edit video contents.

ON REMOTE

1 Selects a recording media:	HDD or DVD
2 Displays a [Title List] menu:	MENU/LIST
3 Selects a title you want to edit:	▲▼◀▶
4 Displays an editing menu: The options are differ depending on the media type.	ENTER
5 Selects a menu option:	▲▼◀▶, ENTER
6 Exit the [Title List] menu:	RETURN

Editing a title - more you can do

About title list menu

Press MENU/LIST to display the Title List menu. Playback should be stopped when you do this. You can also access it using HOME menu, select [MOVIE] option then select [HDD] or [DISC] option and press ENTER. If you are editing a VR mode disc, press MENU/LIST to switch between Original and Playlist menu.



- 1 Current media
- 2 Indicates the record mode, free space, and elapsed time progress bar.
- 3 Menu options: To display menu option, select a title or chapter then press ENTER. The options displayed differ depending on the disc type.
- 4 Currently selected title.
- 5 Thumbnail
- 6 Shows the title name, recorded date, and recording length.

Before editing

This unit offers various edit options for various disc types. Before you edit, check the disc type, and select the option available for your disc.

You can enjoy advanced edit functions with VR mode formatted DVD (DVD-RW or DVD-RAM). Editing either the original recording (called the "original"), or the playback information created from the original (called a "Playlist").

Edits made to the original titles are final. If you plan to edit a title without editing the original title, you can create a Playlist title for editing.

A Playlist is a group of Playlist titles created from the original title for editing purpose.

Titles in the disc's original content contain one or more chapters. When you insert a disc's title into the Playlist, all the chapters within that title also appear. In other words, chapters in the Playlist behave exactly as chapters on a DVD-Video disc do. Parts are sections of Original or Playlist titles. From the Original and Playlist menu you can add or delete parts. Adding a chapter or title to the Playlist creates a new title made up of a section (i.e., chapter) of an Original title. Deleting a part removes part of a title from the Original or Playlist menu.

Adding chapter markers **HDD -RW_{VR} +RW +R RAM**

You can create chapters within a title by inserting chapter marks at the desired point. Press MARKER at the desired point while playback or recording. A chapter marker icon appears on the screen.

The chapter markers can be added at regular interval automatically by setting the [Auto Chapter] option in the SETUP menu.

Deleting a title or chapter

When you delete a title or chapter from the Playlist, the title or chapter in the Original still remains. However, if you delete a chapter or title from Original, the title or chapter deleted from the Original are also removed from Playlist.

Select a title or chapter that you want to delete and press ENTER. Select [Delete] option from the menu on the left of the screen and press ENTER to confirm.

HDD – You can delete multiple files using MARKER button. Press MARKER at the desired files to select multiple files and then follow the instruction above.

Chapter search **HDD -RW_{VR} -RW_{Video} +RW +R -R RAM**

You can select the start of a title by searching a chapter. Select a title that you want to search and press ENTER. Select [Chapter] in the [Search] option from the menu on the left of the screen, and press ENTER to display the [Chapter List] menu.

Use ▲▼◀▶ to find the chapter you want to start playback, and press PLAY to start playback.

Making a new Playlist **-RW_{VR} RAM**

The Playlist allow you to edit or re-edit a title or chapter without changing the Original recordings. Use this function to add an Original title or chapter to a new Playlist or the registered Playlist.



Select an Original title or chapter that you want to put into the Playlist then press ENTER. Select the [Playlist Add] option and then press ENTER to display the [Select Playlist] menu. Choose a Playlist-title that you want to put the selected Original title or chapter to, or select the [New Playlist] to create a new Playlist.

Moving a Playlist chapter **-RW_{VR} RAM**

Use this function to re-arrange the playing order of a Playlist title on the [Chapter List-Playlist] menu. Select [Move] option from the menu on the left of the [Chapter List-Playlist] screen and press ENTER. Use ▲▼◀▶ to choose the place you want to move the chapter then press ENTER. The updated menu is displayed.

Time search **HDD** **-RWvR** **-RWVideo** **+RW** **+R** **-R** **RAM**

You can select the start of a title by searching through the time duration. Select a title that you want to search and press ENTER. Select [Time] in the [Search] option from the menu on the left of the screen and press ENTER to display the [Search] menu.

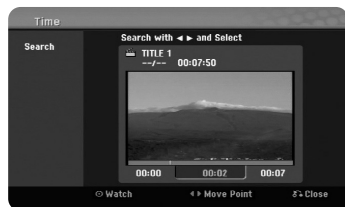

Use ◀▶ to find the time you want to start. Each press of ◀▶ to moves 1 minute and press and hold ◀▶ to moves 5 minutes. Press ENTER to watch a title from a selected time.

Sorting the titles **HDD**

Press ENTER to bring up the options menu. Select [Sort] option and press ENTER to view the further options. Here you can choose to sort titles according to [Date] (when they were recorded), [Title] (alphabetical order) or by [Category] (sort by genre).

Combining titles **HDD**

Use this function to merge the selected title with another title. Select a title and press ENTER. Select [Combine] in the [Edit] option then press ENTER. Select a title you want to combine with current title and press ENTER to confirm.

Hiding a chapter or title **+RW** **+R**

You can skip through playing chapters or titles without actually deleting them. Select a chapter or title you want to hide and press ENTER. Select [Hide] in the [Edit] option then press ENTER.

If you want to recover the hidden title or chapter, select the hidden title or chapter and press ENTER. Select [Show] in the [Edit] option then press ENTER to recover it.

Dividing a title **HDD** **+RW**

Use this function to split a title up into two titles. Select a title that you want to divide and press ENTER. Select [Divide] in the [Edit] option from the menu on the left of the screen and press ENTER to display the [Divide] menu. Find the point you want to divide a title using PLAY, SCAN, PAUSE/STEP buttons and press ENTER while [Divide] option is selected. The playback screen shows the divided point. Select [Done] option and press ENTER to divide. You cannot select dividing point less than 3 seconds.

Protect a title **-RWvR** **+RW** **+R** **RAM**

Use this function to protect a title against accidental recording, editing or deleting. Select a title you want to protect and press ENTER. Select [Protect] option from the menu on the left and press ENTER. The lock mark will appear on the title thumbnail.

If you want to unprotect the title, select the protected title and press ENTER. Select [Unprotect] option from the menu on the left and press ENTER to unprotect it.

Deleting a part **HDD** **-RWvR** **RAM**

You can delete a part which you do not want in the title.

Select a title that you want to delete part and press ENTER. Select [Delete Part] in the [Edit] option from the menu on the left of the screen and press ENTER to display the [Delete part] menu. You can find the point using PLAY, SCAN, PAUSE/STEP buttons.

[Start Point]: Select starting point of a part that you want to delete then press ENTER.

[End Point]: Select ending point of a part that you want to delete then press ENTER.

[Next Part]: Press ENTER to delete a additional part (HDD only).

[Cancel]: Press ENTER to cancel the selected part.

[Done]: Press ENTER to delete the selected part.

Naming a title

When a title is recorded by this unit, the title name will be named by a number. You can change a title name by using this function.



Select a title that you want to change a name and press ENTER. Select [Rename] or [Title Name] option from the menu on the left of the screen and press ENTER to display the keyboard menu. Use ▲▼◀▶ to select a character then press ENTER to confirm your selection on the keyboard menu.

[OK]: Finish the naming.

[Cancel]: Cancels all entered characters.

[Space]: Inserts a space at the cursor position.

[Delete]: Deletes the previous character at the cursor position.

You can use remote control buttons for entering a name

PLAY (▶): Inserts a space at the cursor position.

⏏ (PAUSE/STEP): Deletes the after character at the cursor position.

■ (STOP), CLEAR: Deletes the previous character at the cursor position.

◀ / ▶: Moves cursor to left or right.

MENU/LIST, DISPLAY: Changes the character set on the keyboard menu.

Numbers (0-9): Enters the corresponding character at the cursor position.

You can apply a genre for a selected title on HDD. When a character is highlighted on the keyboard menu, keep pressing ◀ until the cursor jumps across to the Genre field. Choose desired genre and press ENTER to select it. The chosen genre name will appear at the lower right corner of the title thumbnail.

Combining chapters **HDD -RWvr +RW +R RAM**

Use this function to merge the selected chapter with adjacent chapter. Select a chapter and press ENTER. Select [Combine] option to views combine indicator between chapter thumbnails. Press ENTER to combine indicated two chapters.

This function is not available in conditions as listed below.

- There is only one chapter within the title.
- The first chapter is selected.

- The chapters that you want to combine are created by deleting a part from an Original title.
- The chapters that you want to combine are created from different titles.
- One of the playlist chapter that you want to combine has been moved.

Using the Disc menu

Using the title list menu in DVD mode, you can use the disc setting functions without entering the SETUP menu.



Use ▲▼◀▶ to select the [Disc] option on the DVD title list menu and then press ENTER to show further options.

[Disc Format]: Format the inserted disc. (page 21)

[Finalize]: Finalize the inserted disc. (page 21)

[Unfinalize]: Unfinalize the inserted disc. (page 21)

[Disc Label]: Use this to enter a name for the disc. This name appears when you load the disc and disc information on-screen. (page 21)

[Protect]: Use this to prevent accidental recording, editing, deleting of the inserted disc. (page 21)

[Unprotect]: Release the protect function.

Overwriting **-RW**

You can overwrite a new video recording on a recorded title that is not protected. Select the TV channel or input source you want to record. Press MENU/LIST to display the Title List menu. Use ▲▼◀▶ to highlights a title you want to overwrite and then press REC to start overwrite. To stop the recording, press STOP.

If you overwrite the longer recording than the current title on the fully recorded disc, the next title is overwritten. If next title is protected, the overwriting stops at the starting point of the title.

Dubbing a title

Using the title list menu, you can dub video contents.

ON REMOTE

1 Selects a recording media:	HDD or DVD
2 Displays a [Title List] menu:	MENU/LIST
3 Selects a title you want to dub:	▲▼◀▶
4 Displays an editing menu:	ENTER
5 Selects the [Dubbing] option:	▲▼
6 Displays the [Dubbing] menu:	ENTER
7 Sets the [Rec mode] option: XP, SP, LP, EP, MLP, AUTO or Fast modes	▲▼◀▶
8 Highlights the [Start] icon:	▲▼
9 Starts dubbing:	ENTER



Dubbing a title - more you can do

Before dubbing

Use the copying features of this recorder to:

- Back up important recordings stored on the HDD to a DVD.
- Make a DVD copy of a recording on the HDD to play in another player.
- Transfer video from a DVD to the HDD for editing.
- Transfer edited video from the HDD to DVD.

About 'Fast' copying

Copying between DVD and HDD is a complete digital process and therefore involves no loss of quality in the audio or video. This allow for high speed copying for ease and convenience.

When copying from HDD to DVD, the speed of copying depends on the recording mode and the kind of DVD disc you're using. The Fast copying is available for unedited original video titles, and may not be possible when using disc initialized on another recorder.

When you dubs a title from the DVD to HDD, only a VR mode formatted disc can use [Fast] mode.

When you dubs a title from the HDD to VR mode DVD-RW or DVD-RAM, the [Fast] mode is not available for edited HDD title and Clip Recording title. And dub a edited title from VR mode DVD-RW or DVD-RAM to HDD also cannot use [Fast] mode.

Dub multiple titles from HDD to DVD **HDD**

You can select not only a single title but also multiple titles using MARKER button. Press MARKER at the desired titles to select multiple titles, and press ENTER to display the menu on the left of the screen. Select [Dubbing] option from the menu on the left of the screen and press ENTER to display the [Dubbing] menu. Use ▲▼◀▶ to select [Start] icon then press ENTER to confirm.

Dubs a currently playing title **+R -R**

This feature copies a single title to the HDD in real time. When you start copying, playback jumps back to the start of the title, then continues through to the end of the title, when recording automatically stops. The copy will be made in the recording mode (XP, SP, LP, EP or MLP) that is currently set in the SETUP menu.

During DVD playback, press HOME to display the HOME menu. Select the [Dubbing] in the [Easy Menu] option, and press ENTER to start dubbing. The [Dubbing] option in the HOME menu will activated only for a title from finalized DVD±R or DVD-ROM title without copy protection.

Language Codes

Use this list to input your desired language for the following initial settings: Disc Audio, Disc Subtitle, Disc Menu.

Language	Code	Language	Code	Language	Code	Language	Code	Language	Code	Language	Code
Afar	6565	Croatian	7282	Hausa	7265	Lingala	7678	Quechua	8185	Tajik	8471
Afrikaans	6570	Czech	6783	Hebrew	7387	Lithuanian	7684	Rhaeto-Romance	8277	Tamil	8465
Albanian	8381	Danish	6865	Hindi	7273	Macedonian	7775	Rumanian	8279	Telugu	8469
Ameharic	6577	Dutch	7876	Hungarian	7285	Malagasy	7771	Russian	8285	Thai	8472
Arabic	6582	English	6978	Icelandic	7383	Malay	7783	Samoan	8377	Tonga	8479
Armenian	7289	Esperanto	6979	Indonesian	7378	Malayalam	7776	Sanskrit	8365	Turkish	8482
Assamese	6583	Estonian	6984	Interlingua	7365	Maori	7773	Scots Gaelic	7168	Turkmen	8475
Aymara	6588	Faroese	7079	Irish	7165	Marathi	7782	Serbian	8382	Twì	8487
Azerbaijani	6590	Fiji	7074	Italian	7384	Moldavian	7779	Serbo-Croatian	8372	Ukrainian	8575
Bashkir	6665	Finnish	7073	Javanese	7487	Mongolian	7778	Shona	8378	Urdu	8582
Basque	6985	French	7082	Kannada	7578	Nauru	7865	Sindhi	8368	Uzbek	8590
Bengali; Bangla	6678	Frisian	7089	Kashmiri	7583	Nepali	7869	Singhalese	8373	Vietnamese	8673
Bhutani	6890	Galician	7176	Kazakh	7575	Norwegian	7879	Slovak	8375	Volapük	8679
Bihari	6672	Georgian	7565	Kirghiz	7589	Oriya	7982	Slovenian	8376	Welsh	6789
Breton	6682	German	6869	Korean	7579	Panjabi	8065	Spanish	6983	Wolof	8779
Bulgarian	6671	Greek	6976	Kurdish	7585	Pashto, Pushto	8083	Sudanese	8385	Xhosa	8872
Burmese	7789	Greenlandic	7576	Laotian	7679	Persian	7065	Swahili	8387	Yiddish	7473
Byelorussian	6669	Guarani	7178	Latin	7665	Polish	8076	Swedish	8386	Yoruba	8979
Chinese	9072	Gujarati	7185	Latvian, Lettish	7686	Portuguese	8084	Tagalog	8476	Zulu	9085

Area Codes

Choose an area code from this list.

Area	Code	Area	Code	Area	Code	Area	Code	Area	Code
Afghanistan	AF	Costa Rica	CR	Greenland	GL	Maldives	MV	Paraguay	PY
Argentina	AR	Croatia	HR	Hong Kong	HK	Mexico	MX	Philippines	PH
Australia	AU	Czech Republic	CZ	Hungary	HU	Monaco	MC	Poland	PL
Austria	AT	Denmark	DK	India	IN	Mongolia	MN	Portugal	PT
Belgium	BE	Ecuador	EC	Indonesia	ID	Morocco	MA	Romania	RO
Bhutan	BT	Egypt	EG	Israel	IL	Nepal	NP	Russian Federation	RU
Bolivia	BO	El Salvador	SV	Italy	IT	Netherlands	NL	Saudi Arabia	SA
Brazil	BR	Ethiopia	ET	Jamaica	JM	Netherlands Antilles	AN	Senegal	SN
Cambodia	KH	Fiji	FJ	Japan	JP	New Zealand	NZ	Singapore	SG
Canada	CA	Finland	FI	Kenya	KE	Nigeria	NG	Slovak Republic	SK
Chile	CL	France	FR	Kuwait	KW	Norway	NO	Slovenia	SI
China	CN	Germany	DE	Libya	LY	Oman	OM	South Africa	ZA
Colombia	CO	Great Britain	GB	Luxembourg	LU	Pakistan	PK	South Korea	KR
Congo	CG	Greece	GR	Malaysia	MY	Panama	PA	Spain	ES

Troubleshooting

General

The power does not turned on.

- ➔ Plug the power cord into the wall outlet securely.

There is no picture.

- ➔ Select the appropriate video input mode on the TV so the picture from the unit appears on the TV screen.
- ➔ Connect the video connection securely.
- ➔ Check the [Video Output Format] in SETUP menu is set to the appropriate item that conforms to your video connection.

Picture noise appears.

- ➔ You are playing a disc recorded in a color system that is different from your TV.
- ➔ The video signal from the external component is copy-protected.
- ➔ Set the resolution that your TV can accept.

The channel is not found or stored.

- ➔ Check your antenna connection.

There is no sound.

- ➔ Connect the audio connection securely.
- ➔ The input source setting on the amplifier or the connection to the amplifier is incorrect.
- ➔ The unit is in scan, slow motion, or pause mode.

The remote control does not work properly.

- ➔ The remote control is not pointed at the remote sensor of the unit.
- ➔ The remote control is too far from the unit.
- ➔ There is an obstacle in the path of the remote control and the unit.
- ➔ The batteries in the remote control are exhausted.

Playback

The unit does not start playback.

- ➔ Insert a playable disc. (Check the disc type, color system, and regional code.)
- ➔ Place the disc with the playback side down.
- ➔ Place the disc on the disc tray correctly inside the guide.
- ➔ Clean the disc.
- ➔ Cancel the Rating function or change the rating level.

Cannot play a disc recorded using this unit on other player.

- ➔ Finalize the disc.
- ➔ Check the disc compatibility of the player.
- ➔ Place the disc on the disc tray correctly inside the guide.
- ➔ Discs recorded with copy-once material cannot be played on other players.

The angle cannot be changed.

- ➔ Multi-angles are not recorded on the DVD Video being played.
- ➔ The angle cannot be changed for the titles recorded on this unit.

The subtitle language cannot be changed or turned off.

- ➔ Subtitles are not recorded on the DVD Video being played.
- ➔ The subtitle cannot be changed for the titles recorded on this unit.

Cannot play MP3/WMA/JPEG/DivX files.

- ➔ The files are not recorded in a format that the unit can play.
- ➔ The unit does not support the codec of the DivX movie file.
- ➔ The resolution is higher than the unit can support.

Recording

Cannot record or does not record successfully.

- ➔ Check the remaining space on the disc.
- ➔ Check that the source you are trying to record is not copy protected.
- ➔ The power may have failed during recording.
- ➔ Use a VR mode formatted disc for copy-once material.

Timer record does not record successfully.

- ➔ Clock is not set to correct time.
- ➔ The start time of the timer recording is past.
- ➔ Two timer recordings may have overlapped, in which case only the earlier one will record completely.
- ➔ When setting the recording channel, make sure you set the unit's built-in tuner, not the TV's built-in tuner.

Stereo Audio Record and/or Playback is not present.

- ➔ TV is not Stereo-compatible.
- ➔ Broadcast program is not in stereo format.
- ➔ The A/V Output jacks on the unit are not connected to TV A/V In jacks.

HDMI

The connected HDMI device does not display any picture.

- ➔ Try disconnecting then reconnecting the HDMI cable.
- ➔ Try switching the power of the HDMI device off then back on.
- ➔ The video input of the connected device is set correctly for this unit.
- ➔ The HDMI cable you are using is fully HDMI-compliant. Using a non-standard cable may result in no picture being output.
- ➔ Not all HDCP-compatible DVI devices will work with this unit.

The connected HDMI device does not output sounds.

- ➔ Some HDMI-compatible devices do not output sounds (check the manual that came with the connected device).
- ➔ If your TV is not capable of handling 96 kHz sampling frequency, set the [Sampling Freq.] option to [48 kHz] on the setup menu. When this choice is made, this unit will automatically convert any 96 kHz signals to 48 kHz so your system can decode them.
- ➔ If your TV is not equipped with Dolby Digital and MPEG decoder, set the [Dolby Digital] and [MPEG] options to [PCM] on the setup menu.

- ➔ If your TV is not equipped with DTS decoder, set the [DTS] options to [OFF] on the setup menu. To enjoy DTS multi channel surround, you must connect this unit to a DTS compatible receiver via one of this unit's digital audio outputs.

Resetting the unit

If you observe any of the following symptoms.

- The unit is plugged in, but the power will not turn on or off.
- The front panel display is not working.
- The unit is not operating normally.

You can reset the unit as follows.

- Press and hold the POWER button for at least five seconds. This will force the unit to power off then turn the unit back on.
- Unplug the power cord, wait at least five seconds, and then plug it in again.

Setting up the remote to control your TV

You can operate your TV with the supplied remote control. If your TV is listed in the table below, set the appropriate manufacturer code.

While holding down TV POWER button, and press the manufacturer code for your TV with the numerical buttons (see the table below). Release the TV POWER button to complete setting.

Manufacturer	Code Number
LG / GoldStar	1 (Default), 2
Zenith	1, 3, 4
Samsung	6, 7
Sony	8, 9
Hitachi	4

Depending on your TV, some or all buttons may not function on the TV, even after entering the correct manufacturer code. When you replace the batteries of the remote, the code number you have set may be reset to the default setting. Set the appropriate code number again.

Specifications

General

Power requirements	AC 200-240V, 50/60 Hz
Power consumption	30W
Dimensions (approx.)	430 X 49 X 275 mm (w x h x d) without foot
Net weight (approx.)	4 kg
Operating temperature	5°C to 35°C
Operating humidity	5 % to 65 %
Television system	Analog: PAL I, B/G, I/I, SECAM D/K, K1 color system Digital: DVB-T Standard Compliant
Recording format	PAL

Recording

Recording format	DVD Video Recording, DVD-VIDEO
Recordable media	HDD (RHT497H: 160GB, RHT498H: 250GB, RHT499H: 320GB), DVD-RW, DVD-R, DVD+RW, DVD+R, DVD+R(Double Layer), DVD-RAM DVD (4.7GB): Approx. 1 hour (XP mode), 2 hours (SP mode), 4 hours (LP mode), 6 hours (EP mode), 14 hours (MLP mode) DVD+R DL (8.5GB): Approx. 3 hours (XP mode), 3.8 hours (SP mode), 7.3 hours (LP mode), 9.1 hours (EP mode), 21 hours (MLP mode) HDD (160/250/320GB, MPEG2 Recording): Approx. 43/66/85 hours (XP mode), 84/129/165 hours (SP mode), 164/251/323 hours (LP mode), 233/356/456 hours (EP mode), 477/729/935 hours (MLP mode)
Recordable time	

Video recording format

Sampling frequency	27MHz
Compression format	MPEG2

Audio recording format

Sampling frequency	48kHz
Compression format	Dolby Digital

Playback

Frequency response	DVD (PCM 48 kHz): 8 Hz to 22 kHz, CD: 8 Hz to 20 kHz DVD (PCM 96 kHz): 8 Hz to 44 kHz
Signal-to-noise ratio	More than 90 dB (AUDIO OUT connector)
Harmonic distortion	Less than 0.02% (AUDIO OUT connector)

Inputs

ANTENNA IN	Antenna input, 75 ohms
VIDEO IN	1.0 Vp-p 75 ohms, sync negative, RCA jack x 1 / SCART x 2
AUDIO IN	2.0 Vrms more than 47 kohms, RCA jack (L, R) x 1 / SCART x 2
DV IN	4 pin (IEEE 1394 standard)
USB IN	4 pin (USB 1.1 standard)

Outputs

VIDEO OUT	1 Vp-p 75 Ω, sync negative, SCART x 2
S-VIDEO OUT	(Y) 1.0 V (p-p), 75 Ω, sync negative, Mini DIN 4-pin x 1 (C) 0.3 V (p-p) 75 Ω
COMPONENT VIDEO OUT	(Y) 1.0 V (p-p), 75 Ω, sync negative, RCA jack x 1, (PB)/(PR) 0.7 V (p-p), 75 Ω, RCA jack x 2
HDMI video/audio output	19 pin (HDMI standard, Type A)
Audio output (digital audio)	0.5 V (p-p), 75 Ω, RCA jack x 1
Audio output (optical audio)	3 V (p-p), Optical connector x 1
Audio output (analog audio)	2 Vrms (1 kHz, 0 dB), 600 Ω, RCA jack (L, R) x 2 / SCART x 2

Accessories

RF cable (1), Remote control (1), Battery (1),

- Design and specifications are subject to change without notice.

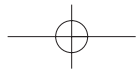
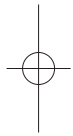
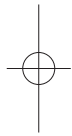
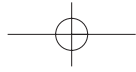



As an ENERGY STAR® Partner, LG has determined that this product or product models meet the ENERGY STAR® guidelines for energy efficiency.

ENERGY STAR® is a U.S. registered mark.

