



# DVD KARAOKE SYSTEM

## OWNER'S MANUAL

MODEL : DKS-6100



Please read this manual carefully before operating your set.  
Retain it for future reference.

Designs and specifications are subject to change without  
notice for improvement.

## Safety Precautions



**CAUTION**  
RISK OF ELECTRIC SHOCK  
DO NOT OPEN



**WARNING: TO REDUCE THE RISK OF ELECTRIC SHOCK DO NOT REMOVE COVER (OR BACK) NO USER-SERVICEABLE PARTS INSIDE REFER SERVICING TO QUALIFIED SERVICE PERSONNEL.**



This lightning flash with arrowhead symbol within an equilateral triangle is intended to alert the user to the presence of uninsulated dangerous voltage within the product's enclosure that may be of sufficient magnitude to constitute a risk of electric shock to persons.



The exclamation point within an equilateral triangle is intended to alert the user to the presence of important operating and maintenance (servicing) instructions in the literature accompanying the appliance.

**WARNING: TO REDUCE THE RISK OF FIRE OR ELECTRIC SHOCK, DO NOT EXPOSE THIS PRODUCT TO RAIN OR MOISTURE.**

CLASS 1 LASER PRODUCT  
KLASSE 1 LASER PRODUKT  
LUOKAN 1 LASER LAITE  
KLASS 1 LASER APPARAT  
CLASSE 1 PRODUIT LASER

### CAUTION:

This Digital Video Disc Player employs a Laser System.

To ensure proper use of this product, please read this owner's manual carefully and retain for future reference, should the unit require maintenance, contact an authorized service location—see service procedure.

Use of controls, adjustments or the performance of procedures other than those specified herein may result in hazardous radiation exposure.

To prevent direct exposure to laser beam, do not try to open the enclosure. Visible laser radiation when open. **DO NOT STARE INTO BEAM.**

**CAUTION:** The apparatus shall not be exposed to water, dripping or splashing and that no objects filled with liquids, such as vases, shall be placed on the apparatus.

### CAUTION concerning the Power Cord

**Most appliances recommend they be placed upon a dedicated circuit;**

That is, a single outlet circuit which powers only that appliance and has no additional outlets or branch circuits. Check the specification page of this owner's manual to be certain.

Do not overload wall outlets. Overloaded wall outlets, loose or damaged wall outlets, extension cords, frayed power cords, or damaged or cracked wire insulation are dangerous. Any of these conditions could result in electric shock or fire.

Periodically examine the cord of your appliance, and if its appearance indicates damage or deterioration, unplug it, discontinue use of the appliance, and have the cord replaced with an exact replacement part by an authorized servicer.

Protect the power cord from physical or mechanical abuse, such as being twisted, kinked, pinched, closed in a door, or walked upon. Pay particular attention to plugs, wall outlets, and the point where the cord exits the appliance.

# Table of Contents

## Introduction

<b>Safety Precautions</b> .....	2
<b>Table of Contents</b> .....	3
<b>Before Use</b> .....	4-5
Playable Discs .....	4
Notes on Discs .....	4-5
Precautions .....	5
About Symbols .....	5
Features .....	5
<b>Front Panel and Rear Panel</b> .....	6
<b>Remote Control</b> .....	7

## Preparation

<b>Connections</b> .....	8-9
Connecting to a TV .....	8
Connecting to Optional Equipment .....	9
<b>Before Operation</b> .....	10-15
Mini Glossary for Audio Stream & Surround Mode .....	10
Sound Mode .....	10
General Explanation .....	11
On-Screen Display .....	11
Initial Settings .....	12-15
• General Operation .....	12
• LANGUAGE .....	12
• DISPLAY .....	12
• AUDIO .....	13
• LOCK (Parental Control) .....	14
• OTHERS .....	15

## Operation

<b>Operation with DVD and Video CD</b> .....	15-17
Playing a DVD and Video CD .....	15
General Features .....	16-17
• Moving to another TITLE .....	16
• Moving to another CHAPTER/TRACK .....	16
• Search .....	16
• Still Picture and Frame-by-Frame Playback .....	16
• Slow Motion .....	16
• Repeat .....	16
• Repeat A-B .....	16
• Time Search .....	16
Special DVD Features .....	17
• Title Menu .....	17
• Disc Menu .....	17
• Camera Angle .....	17
• Changing the Audio Language .....	17
• Changing the Audio Channel .....	17
• Subtitle .....	17

## Operation with Audio CD and MP3/WMA Disc

Playing an Audio CD and MP3/WMA Disc .....	18
• Pause .....	18
• Moving to another Track .....	18
• Repeat Track/ All/ Off .....	18
• Search .....	18

## Operation with JPEG Disc

Viewing a JPEG disc .....	19
• Slide Show .....	19
• Moving to another File .....	19
• Still Picture .....	19

## Programmed Playback

Repeat Programmed Tracks .....	20
Erasing a Track from Program List .....	20
Erasing the Complete Program List .....	20

## Operation with DivX Disc

## Operation with KARAOKE

Karaoke Basic Playback .....	22
Karaoke Advanced Playback .....	22-23
Karaoke MENU Playback .....	23-26
• SETUP .....	23
• MUSIC LIST .....	24
• RANDOM .....	25
• CHALLENGE .....	25

## Reference

Language Code List .....	26
Country Code List .....	26
Troubleshooting / Specifications .....	27

## About the symbols for instructions



Indicates hazards likely to cause harm to the unit itself or other material damage.





Indicates special operating features of this unit.



Indicates tips and hints for making the task easier.

## Before Use

### Playable Discs

	DVD (8 cm / 12 cm disc)
	Video CD (VCD) (8 cm / 12 cm disc)
	Audio CD (8 cm / 12 cm disc)

In addition, this unit can play a DVD±R, DVD±RW, SVCD, and CD-R or CD-RW that contains audio titles, MP3, WMA, JPEG or DivX files.

#### Notes

- Depending on the conditions of the recording equipment or the CD-R/RW (or DVD±R/RW) disc itself, some CD-R/RW (or DVD±R/RW) discs cannot be played on the unit.
- Do not attach any seal or label to either side (the labeled side or the recorded side) of a disc.
- Do not use irregularly shaped CDs (e.g., heart-shaped or octagonal). It may result in malfunctions.

#### Notes on DVDs and Video CDs

Some playback operations of DVDs and Video CDs may be intentionally fixed by software manufacturers. As this unit plays DVDs and Video CDs according to disc content designed by the software manufacturer, some playback features of the unit may not be available or other functions may be added.

Refer also to the instructions supplied with the DVDs and Video CDs. Some DVDs made for business purposes may not be played on the unit.

#### Regional code of the DVD player and DVDs

This DVD player is designed and manufactured for playback of region “3” encoded DVD software. The region code on the labels of some DVD discs indicates which type of player can play those discs. This unit can play only DVD discs labeled “3” or “ALL”. If you try to play any other discs, the message “Check Regional Code” will appear on the TV screen. Some DVD discs may not have a region code label even though their playback is prohibited by area limits.



#### Note on DTS-encoded CDs

When playing DTS-encoded CDs, excessive audio level may be heard from the analog stereo output. To avoid possible damage to the audio system, turn down the volume before playing back such discs, adjust the volume gradually, and keep the volume level low. To enjoy DTS Digital Surround™ playback, an external 5.1 channel DTS Digital Surround™ decoder system must be connected to the digital output of the unit.

### Disc-related terms

#### Title (DVD only)

The main film content or accompanying feature content or additional feature content, or music album.

Each title is assigned a title reference number enabling you to locate it easily.

#### Chapter (DVD only)

Sections of a picture or a musical piece that are smaller than titles. A title is composed of one or several chapters. Each chapter is assigned a chapter number, enabling you to locate the chapter you want. Depending on the disc, chapters may not be recorded.

#### Track (Video CD and audio CD only)

Sections of a picture or a musical piece on a video CD or an audio CD. Each track is assigned a track number, enabling you to locate the track you want.

#### Scene

On a video CD with PBC (Playback control) functions, moving pictures and still pictures are divided into sections called “Scenes”. Each scene is displayed in the menu screen and assigned a scene number, enabling you to locate the scene you want.

A scene is composed of one or several tracks.

### Types of video CDs

There are two types of video CDs:

#### Video CDs equipped with PBC (Version 2.0)

PBC (Playback control) functions allow you to interact with the system via menus, search functions, or other typical computer-like operations. Moreover, still pictures of high resolution can be played if they are included in the disc.

#### Video CDs not equipped with PBC (Version 1.1)

Operated in the same way as audio CDs, these discs allow playback of video pictures as well as sound, but they are not equipped with PBC.

### Notes on Discs

#### Handling discs

- Do not touch the playback side of the disc.
- Hold the disc by the edges so that fingerprints will not get on the surface.
- Do not stick paper or tape on the disc.

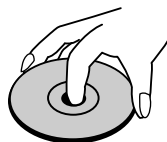

#### Storing discs

- After playing, store the disc in its case.
- Do not expose the disc to direct sunlight or sources of heat, or leave it in a parked car exposed to direct sunlight, as there may be a considerable temperature increase inside the car.

## Before Use (Cont'd)

### Cleaning discs

Fingerprints and dust on the disc can cause poor picture quality and sound distortion. Before playing, clean the disc with a clean cloth. Wipe the disc from the center out.

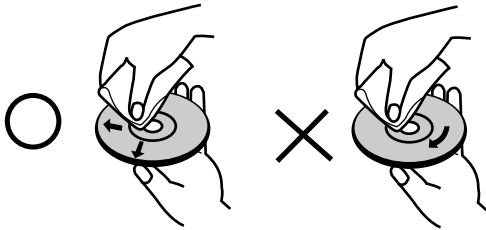

Do not use strong solvents such as alcohol, benzene, thinner, commercially available cleaners, or anti-static spray intended for older vinyl records.

### Precautions

#### Handling the unit

##### **When shipping the unit**

The original shipping carton and packing materials come in handy. For maximum protection, re-pack the unit as it was originally packed at the factory.

##### **When setting up the unit**

The picture and sound of a nearby TV, VCR, or radio may be distorted during playback. In this case, position the unit away from the TV, VCR, or radio, or turn off the unit after removing the disc.

##### **To keep the exterior surfaces clean**

Do not use volatile liquids, such as insecticide spray, near the unit. Do not leave rubber or plastic products in contact with the unit for a long period of time. They will leave marks on the surface.

### Cleaning the unit

#### **To clean the cabinet**

Use a soft, dry cloth. If the surfaces are extremely dirty, use a soft cloth lightly moistened with a mild detergent solution. Do not use strong solvents such as alcohol, benzene, or thinner, as these might damage the surface of the unit.

#### **To obtain a clear picture**

The DVD player is a high-tech, precision device. If the optical pick-up lens and disc drive parts are dirty or worn, the picture quality will be poor. Regular inspection and maintenance are recommended after every 1,000 hours of use. (This depends on the operating environment.) For details, please contact your nearest dealer.

### About Symbols

#### About the symbol display

“” may appear on the TV screen during operation. This icon means the function explained in this owner's manual is not available on that specific DVD video disc.

#### About the disc symbols for instructions

A section whose title has one of the following symbol is applicable only to the disc represented by the symbol.

-  DVD
-  Video CDs
-  Audio CDs
-  MP3 disc
-  WMA disc
-  JPEG disc
-  DivX disc

### Features

#### Last Scene Memory

This player memorizes the user settings for the last disc that you have viewed. Settings remain in memory even if you remove the disc from the player or switch off the player. If you load a disc that has its settings memorized, the latest stop position is automatically recalled.

#### **Notes**

- Settings are stored in memory for use any time.
- This player does not memorize settings of a disc if you switch off the player before commencing to play it.

## Front Panel and Rear Panel

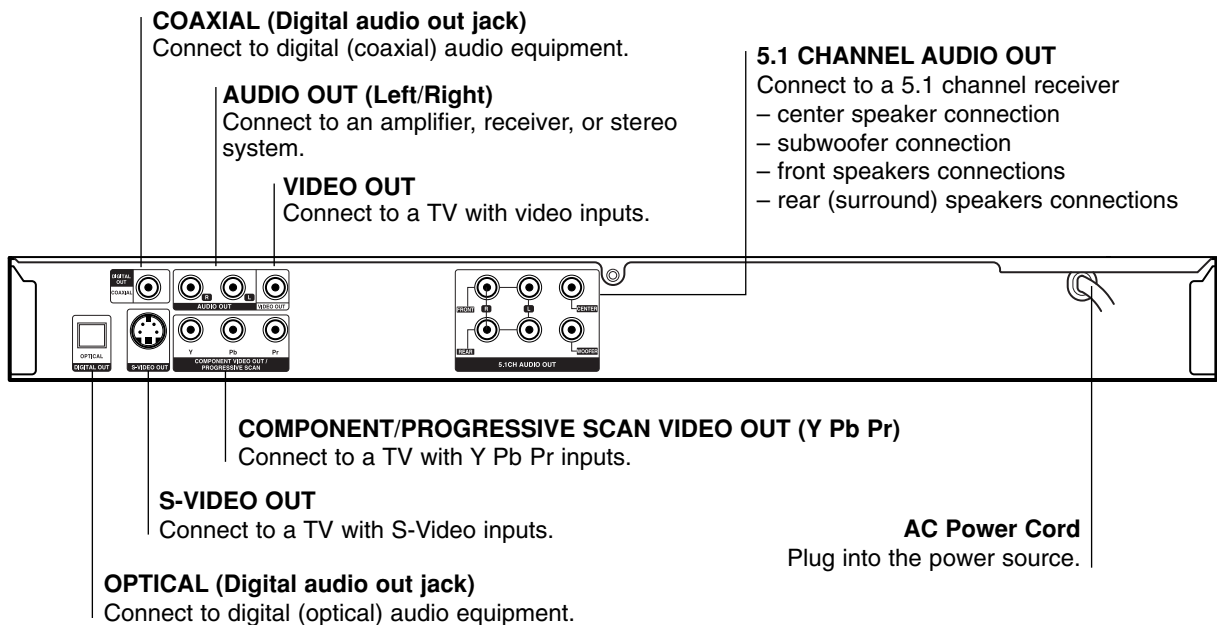
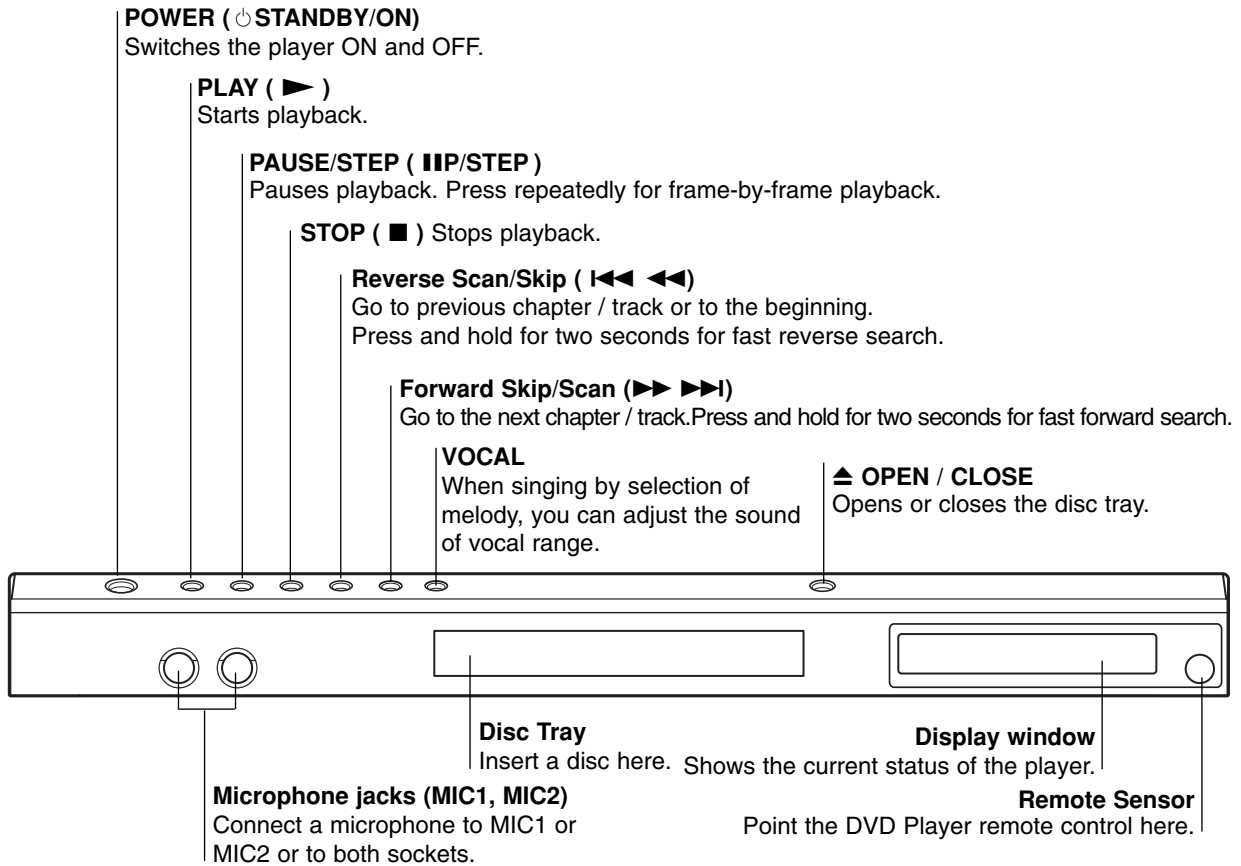

**Do not touch the inner pins of the jacks on the rear panel. Electrostatic discharge may cause permanent damage to the unit.**

# Remote Control

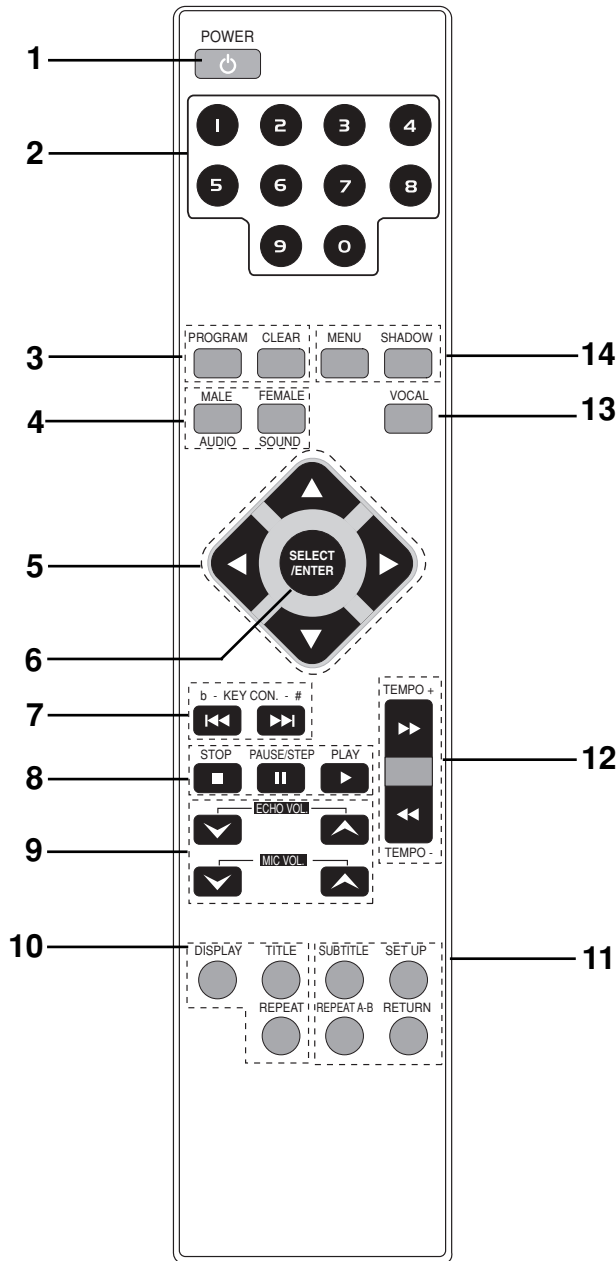

1. POWER button
2. NUMERIC buttons (0-9)
3. • PROGRAM button  
• CLEAR button
4. • AUDIO button  
• MALE button  
• SOUND button  
• FEMALE button
5. ARROW buttons (▲/▼/◀/▶)  
(For use in highlighting a selection on a GUI menu screen, TITLE and MENU screen.)
6. SELECT/ENTER button
7. KEY CONTROL (b/#) buttons
8. • STOP (■) button  
• PAUSE(II)/ STEP button  
• PLAY (▶) button
9. • ECHO volume control (ECHO VOL. ▼/▲) button  
• Microphone volume control (MIC VOL. ▼/▲) button
10. • DISPLAY button  
• TITLE button  
• REPEAT button
11. • SUBTITLE button  
• SET UP button  
• REPEAT A-B button  
• RETURN button
12. TEMPO(-/+ ) buttons
13. VOCAL button  
(When singing by selection of melody, you can adjust the sound of vocal range.)
14. • MENU button  
• SHADOW button

## Remote Control Operation Range

Point the remote control at the remote sensor and press the buttons.

- **Distance:** About 23 ft (7 m) from the front of the remote sensor
- **Angle:** About 30° in each direction of the front of the remote sensor

## Remote control battery installation

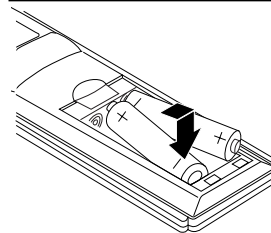

Detach the battery cover on the rear of the remote control, and insert two R03 (size AAA) batteries with + and - aligned correctly.

### ⚠ Caution

Do not mix old and new batteries. Never mix different types of batteries (standard, alkaline, etc.).

## Connections

### Tips

- Depending on your TV and other equipment you wish to connect, there are various ways you could connect the player. Use only one of the connections described below.
- Please refer to the manuals of your TV, VCR, Stereo System or other devices as necessary to make the best connections.
- For better sound reproduction, connect the player's AUDIO OUT jacks to the audio in jacks of your amplifier, receiver, stereo or audio/video equipment. See "Connecting to Optional Equipment" on page 9.

### Caution

- Make sure the DVD Player is connected directly to the TV. Tune the TV to the correct video input channel.
- Do not connect the DVD Player's AUDIO OUT jack to the phono in jack (record deck) of your audio system.
- Do not connect your DVD Player via your VCR. The DVD image could be distorted by the copy protection system.

## Connecting to a TV

- Make one of the following connections, depending on the capabilities of your existing equipment.

### Video connection

- 1 Connect the VIDEO OUT jack on the DVD Player to the video in jack on the TV using the video cable (V).
- 2 Connect the Left and Right AUDIO OUT jacks of the DVD Player to the audio left/right in jacks on the TV (A) using the audio cables.

### S-Video connection

- 1 Connect the S-VIDEO OUT jack on the DVD Player to the S-Video in jack on the TV using the S-Video cable (S).
- 2 Connect the Left and Right AUDIO OUT jacks of the DVD Player to the audio left/right in jacks on the TV (A) using the audio cables.

### Component Video (Color Stream®) connection

- 1 Connect the COMPONENT VIDEO OUT/ PROGRESSIVE SCAN jacks on the DVD Player to the corresponding in jacks on the TV using an Y Pb Pr cable (C).
- 2 Connect the Left and Right AUDIO OUT jacks of the DVD Player to the audio left/right in jacks on the TV (A) using the audio cables.

### Progressive Scan (ColorStream® pro) connection

- If your television is a high-definition or "digital ready" television, you may take advantage of the DVD Player's progressive scan output for the highest video resolution possible.
- If your TV does not accept the Progressive Scan format, the picture will appear scrambled if you try Progressive Scan on the DVD Player.

**1** Connect the COMPONENT VIDEO OUT/ PROGRESSIVE SCAN jacks on the DVD Player to the corresponding in jacks on the TV using an optional Y Pb Pr cable (C).

**2** Connect the Left and Right AUDIO OUT jacks of the DVD Player to the audio left/right in jacks on the TV (A) using the supplied audio cables.

### Notes

- Set the Progressive to "On" on the setup menu for progressive signal, see page 12.
- Progressive scan does not work with the analog video connections (yellow VIDEO OUT jack).

### Rear of TV

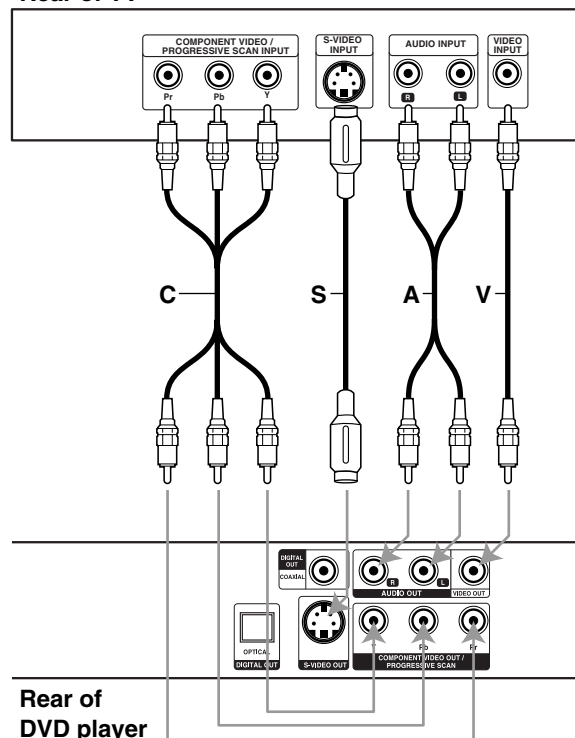

### Rear of DVD player

## Connections

### Connecting to Optional Equipment

#### Connecting to an amplifier equipped with two channel analog stereo or Dolby Pro Logic II/ Pro Logic

Connect the Left and Right AUDIO OUT jacks on the DVD Player to the audio left and right in jacks on your amplifier, receiver, or stereo system, using the audio cables (A).

#### Connecting to an amplifier equipped with two channel digital stereo (PCM) or to an Audio/ Video receiver equipped with a multi-channel decoder (Dolby Digital™, MPEG 2, or DTS)

Connect one of the DVD Player's DIGITAL AUDIO OUT jacks (OPTICAL O or COAXIAL X) to the corresponding in jack on your amplifier. Use an optional digital (optical O or coaxial X) audio cable.

#### Digital Multi-channel sound

A digital multi-channel connection provides the best sound quality. For this you need a multi-channel Audio/Video receiver that supports one or more of the audio formats supported by your DVD Player (MPEG 2, Dolby Digital and DTS). Check the receiver manual and the logos on the front of the receiver.



#### Caution:

Due to the DTS Licensing agreement, the digital output will be in DTS digital out when DTS audio stream is selected.

#### Rear of DVD player

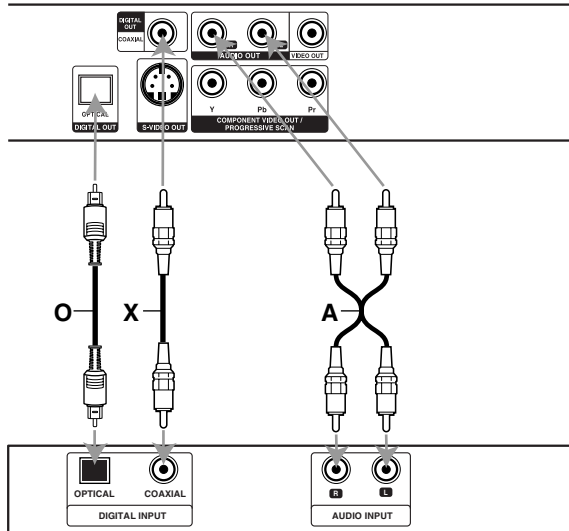

Amplifier (Receiver)

#### Notes

- If the audio format of the digital output does not match the capabilities of your receiver, the receiver will produce a strong, distorted sound or no sound at all.
- Six Channel Digital Surround Sound via digital connection can only be obtained if your receiver is equipped with a Digital Multi-channel decoder.
- To see the audio format of the current DVD in the on-screen display, press AUDIO.

#### Analog connection to a multi-channel A/V receiver with 6 Channel connectors (Dolby Digital, DTS)

This DVD Player contains a multi-channel decoder. This enables playback of DVDs recorded in Multi-channel Surround without the need for an optional decoder.

- 1** Connect the CENTER and WOOFER jacks for the Center speaker and the Subwoofer (C) to the corresponding in jacks on your receiver.
- 2** Connect the Left and Right FRONT speaker jacks (F) to the corresponding in jacks on your receiver.
- 3** Connect the Left and Right REAR speaker jacks (R) to the corresponding in jacks on your receiver.
- 4** Make the appropriate Sound settings for Analog Output and Speaker Settings in the setup menu. See page 13.

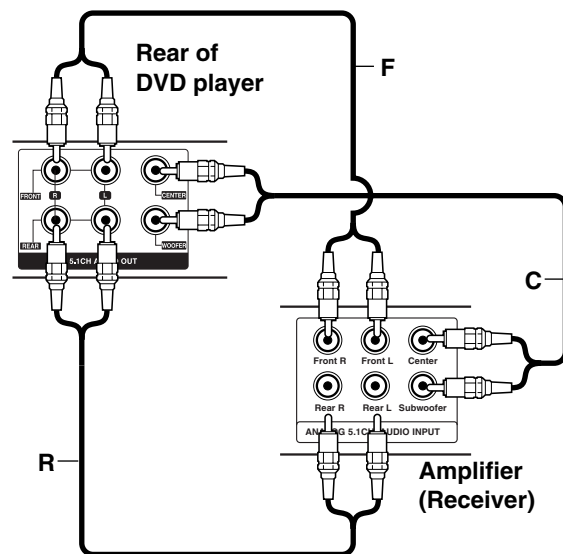

## Before Operation

### Mini Glossary for Audio Stream & Surround mode

#### dts

Allows you to enjoy 5.1(or 6) discrete channels of high quality digital audio from DTS program sources such as discs, DVD and compact discs, etc.bearing the trademark. DTS Digital Surround delivers up to 6 channels of transparent audio(which means identical to the original masters) and results in exceptional clarity throughout a true 360 degree sound field. "DTS" and "DTS Digital Surround" are registered trademarks of Digital Theater Systems, Inc.

#### DIGITAL

The Dolby Digital surround format lets you enjoy up to 5.1 channels of digital surround sound from a Dolby Digital program source. If you play DVDs with "" mark, you can enjoy even better sound quality, greater spatial accuracy, and improved dynamic range. Manufactured under license from Dolby Laboratories. "Dolby", "Pro Logic" and double-D symbol are trademarks of Dolby Laboratories.

#### PRO LOGIC II

Dolby Pro Logic II creates five full-bandwidth output channels from two-channel sources. This is done using an advanced, high-purity matrix surround decoder that extracts the spatial properties of the original recording without adding any new sounds or tonal colorations.

#### **MOVIE mode:**

The Movie mode is for use with stereo television shows and all programs encoded in Dolby Surround. The result is enhanced soundfield directionality that approaches the quality of discrete 5.1-channel sound.

#### **BYPASS**



Outputs the sound from the front left and right speakers and subwoofer.

### Sound Mode



You can enjoy surround sound simply by selecting one of the pre-programmed sound fields according to the program you want to listen to.

#### **When DVD is inserted**

You can change the Digital Audio Output mode by pressing the **AUDIO** button on the remote control during playback. Although the DVD contents differ from disc to disc, the following explains the basic operation when this feature is used.

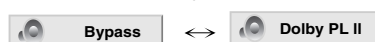
- a) After you select 2 channel (For example  or ) by pressing AUDIO button, press SOUND button repeatedly.



- b) After you select 5.1 channel (For example  or ) by pressing AUDIO button, press SOUND button.
- "" indicator will be displayed on the TV screen.
  - "BYPASS" indicator will be only displayed on the display window.

#### **When Video CD is inserted**

Each time you press SOUND button, the sound mode of Video CD is changed on the display window as the following order.

BYPASS → STUDIO → CLUB → HALL → THEATER 1 → CHURCH → PL II MOVIE → BYPASS...

#### **ote**



After you select the "Bypass" of sound mode by pressing SOUND button, press AUDIO button. The Left, Right and Stereo of audio channel will be displayed on the TV screen.

#### **When CD is inserted**

Each time you press SOUND button, the sound mode of Audio CD is changed on the display window as the following order.

BYPASS → STUDIO → CLUB → HALL → THEATER 1 → CHURCH → PL II MOVIE → BYPASS...

#### **For your reference**

- Initial sound of DVD function is **BYPASS**.
- You can identify the encoding format of program software by looking at its packaging.
  - Dolby Digital discs are labelled with the  logo.
  - Dolby Surround encoded programs are labelled with the  logo.
  - DTS Digital Surround discs are marked with DTS.

#### **ote**

When you play sound tracks with 96kHz sampling frequency, the output signals will be converted to 48kHz (sampling frequency).

## Before Operation

### General Explanation





This manual gives basic instructions for operating the DVD Karaoke. Some DVDs require specific operation or allow only limited operation during playback.

When this occurs, the symbol  appears on the TV screen, indicating that the operation is not permitted by the DVD Karaoke or is not available on the disc.





### On-Screen Display

General playback status can be displayed on the TV screen. Some items can be changed on the menu.

#### On-screen display operation

- 1** Press **DISPLAY** during playback.
- 2** Press  /  to select an item.  
The selected item will be highlighted.
- 3** Press  or  to change the setting of an item.  
The number buttons can be also be used for setting numbers (e.g., title number). For some functions, press **SELECT/ENTER** to execute the setting.













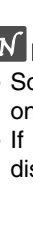

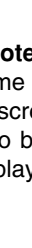
#### Temporary Feedback Field Icons

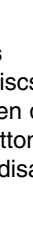
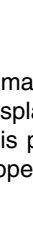
-  **Title** Repeat title
-  **A - B** Repeat sequence
-  **||** Resume play from this point
-  **Hand** Action prohibited or not available

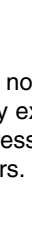

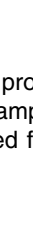

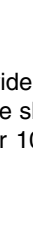





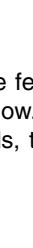

#### Notes

- Some discs may not provide all of the features on the on-screen display example shown below.
- If no button is pressed for 10 seconds, the on-screen display disappears.

#### Example: On-Screen Display during playing DVD

Items	Function / Action using  /  to select item	Selection Method	
Title Number	 1 / 3	Shows the current title number and total number of titles / skips to the desired title number.	 /  , Numbers, or <b>SELECT/ENTER</b>
Chapter Number	 1 / 12	Shows the current chapter number and total number of chapters / skips to the desired chapter number.	 /  , Numbers, or <b>SELECT/ENTER</b>
Time search	 0:20:09	Shows the elapsed playing time / searches by elapsed time.	Numbers, <b>SELECT/ENTER</b>
Audio language and Digital Audio Output mode	 1 ENG D DD 5.1 CH	Shows the current audio soundtrack language, encoding method, and channel number / changes the setting.	 /  or <b>AUDIO</b>
Subtitle language	 1 ENG	Shows the current subtitle language / changes the setting.	 /  or <b>SUBTITLE</b>
Angle	 1 / 3	Shows the current angle number and total number of angles / changes the angle.	 / 
Sound	 Bypass	Shows the current sound mode / changes the setting.	 /  or <b>SOUND</b>

#### Example: On-Screen Display during playing VCD

Items	Function / Action using  /  to select item	Selection Method	
Track Number	 1 / 3	Shows the current track number, total number of tracks and PBC On mode / skips to the desired track number.	 /  , Numbers, or <b>SELECT/ENTER</b>
Time	 0:20:09	Shows the elapsed playing time (display only).	-
Audio Channel	 Stereo	Shows the audio channel / changes the audio channel.	 /  or <b>AUDIO</b>
Sound	 Bypass	Shows the current sound mode / changes the setting.	 /  or <b>SOUND</b>

## Before Operation

### Initial Settings

By using the Setup menu, you can make various adjustments to items such as picture and sound. You can also set a language for the subtitles and the Setup menu, among other things. For details on each Setup menu item, see pages 12 to 15.

#### To display and exit the Menu:

Press **SETUP** to display the menu. A second press of **SETUP** will take you back to initial screen.

#### To go to the next level:

Press **▶** on the remote control.

#### To go back to the previous level:

Press **◀** on the remote control.

### General Operation

- 1 Press SETUP.**  
The setup menu appears.
- 2 Use ▲ / ▼ to select the desired option then press ▶ to move to the second level.**  
The screen will be shown the current setting for the selected item, as well as alternate setting(s).
- 3 Use ▲ / ▼ to select the second desired option then press ▶ to move to the third level.**
- 4 Use ▲ / ▼ to select the desired setting then press SELECT/ENTER to confirm your selection.**  
Some items require additional steps.
- 5 Press SETUP or PLAY to exit the setup menu.**

### LANGUAGE

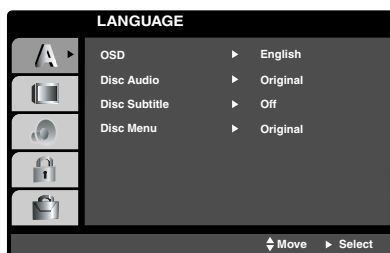

#### OSD

Select a language for the Setup menu and on-screen display.

#### Disc Audio / Subtitle / Menu **DVD**

Select the language you prefer for the audio track (disc audio), subtitles, and the disc menu.

**Original:** Refers to the original language in which the disc was recorded.

**Other:** To select another language, press number buttons to enter the corresponding 4-digit number according to the language code list on page 26. If you enter the wrong language code, press **CLEAR** on the remote control.

### DISPLAY

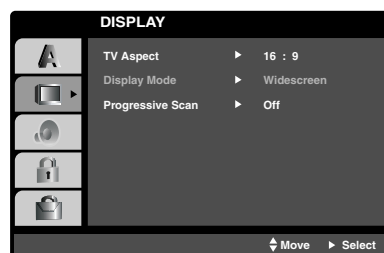

#### TV Aspect **DVD**

**4:3:** Select when a standard 4:3 TV is connected.

**16:9:** Select when a 16:9 wide TV is connected.

#### Display Mode **DVD**

Display Mode setting works only when the TV Aspect mode is set to "4:3".

**Letterbox:** Displays a wide picture with bands on the upper and lower portions of the screen.

**Panscan:** Automatically displays the wide picture on the entire screen and cuts off the portions that do not fit.

#### Progressive Scan **DVD**

Progressive Scan Video provides the highest quality pictures with less flickering.

If you are using the Component Video jacks for connection to a TV or monitor that is compatible with a progressive scan signal, set Progressive Scan to On.

#### To Turn ON progressive scan:

Connect component out of the DVD to the input of your monitor/television, set your television or monitor to Component Input.

- Select "Progressive Scan" on the DISPLAY menu then press **▶**.
- Select "On" using the **▲ / ▼** buttons.
- Press **SELECT/ENTER** to confirm your selection. The confirm menu will appear.
- When the confirm menu appears on your screen **Cancel** is highlighted as default. Use the **◀ / ▶** buttons to highlight **Enter**.
- Pressing "Enter" will set the player to Progressive scan mode.

#### **⚠ Caution**

Once the setting for progressive scan output is entered, an image will only be visible on a progressive scan compatible TV or monitor. If you set Progressive Scan to On in error, you must reset the unit.

- Remove any disc from the unit and close the disc tray. See that "NO DISC" is displayed on the display window
- Press **STOP** (■) and hold it for five seconds before releasing it. The video output will be restored to the standard setting, and a picture will once again be visible on a conventional analog TV or monitor.

## Before Operation

### AUDIO

Each DVD disc has a variety of audio output options. Set the player's AUDIO options according to the type of audio system you use.

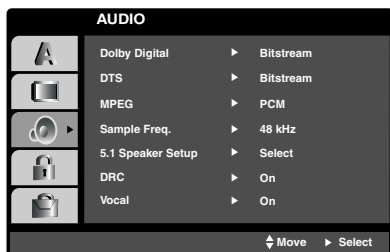

#### Dolby Digital / DTS / MPEG **DVD**

**Bitstream:** Select "Bitstream" if you connect the DVD Player's DIGITAL OUT jack to an amplifier or other equipment with a Dolby Digital, DTS or MPEG decoder.

**PCM :** Select when connected to a two-channel digital stereo amplifier. DVDs encoded in Dolby Digital or MPEG will be automatically downmixed to two-channel PCM audio.

#### Sample Freq. (Frequency) **DVD**

If your receiver or amplifier is NOT capable of handling 96 kHz signals, select 48 kHz. When this choice is made, this unit automatically converts any 96 kHz signals to 48 kHz so your system can decode them.

If your receiver or amplifier is capable of handling 96 kHz signals, select 96 kHz. When this choice is made, this unit passes each type of signal through without any further processing.

Check the documentation for your amplifier to verify its capabilities.

#### 5.1 Speaker Setup **DVD**

Select speaker settings, including volume balance and distance, or test the speaker settings.

Speaker settings are only active on the Analog Multi-Channel Output.

#### Speaker Setup

Make the following settings for the built-in 5.1 channel surround decoder.

1. Press SETUP. The setup menu appears.
2. Use / to select the AUDIO option then press to move to the second level.
3. Use / to select the Speaker Setup option then press to move to the third level. "Select" is highlighted.
4. Press SELECT/ENTER and 5.1 Speaker Setup menu appears.

5. Use / to select the desired speaker.
6. Adjust options using / / / buttons.
7. Press SELECT/ENTER to confirm your selection. Returns to the previous menu.

#### Speaker selection

Select a speaker that you want to adjust. [Front speaker (Front L), Front speaker (Front R), Center Speaker (Center), Subwoofer (Woofer), Rear speaker (Rear L) or Rear speaker (Rear R)]

#### Size

Since the speaker settings are fixed, you cannot change the setting.

#### Volume

Press / to adjust the output level of the selected speaker. (-5dB ~ 5dB)

#### Distance

If you have connected speakers to your DVD Player, setting the Distance lets the speakers know how far the sound has to travel to reach your set listening point. This allows the sound from each speaker to reach the listener at the same time.

Press / to adjust the Distance of the selected speaker.

#### Test

Select "All" to test the signals of each speaker.

Adjust the volume to match the volume of test signals memorized in the system.

(When the size of the Front L/R speaker is selected to "Large", the subwoofer (Woofer) is not available.)

Front L → Center → Front R → Rear R → Rear L → Woofer

You can adjust the volume during operating the test tone, first use / to select Volume or Speaker option then use / buttons to select volume or speaker, so that all speaker's volume is same from the listener's position.

#### Dynamic Range Control (DRC) **DVD**

With the DVD format, you can hear a program's soundtrack in the most accurate and realistic presentation possible, thanks to digital audio technology. However, you may wish to compress the dynamic range of the audio output (the difference between the loudest sounds and the quietest ones). This allows you to listen to a movie at a lower volume without losing clarity of sound. Set DRC to On for this effect.

#### Vocal **DVD**

Set Vocal to On only when a multi-channel Karaoke DVD is playing. The karaoke channels on the disc will mix into a normal stereo sound.

## Before Operation

### LOCK (Parental Control)



#### Rating **DVD**

Some movies contain scenes that may not be suitable for children to view. Many of these discs contain parental control information that applies to the complete disc or to certain scenes on the disc. Movies and scenes are rated from 1 to 8, depending on the country. Some discs offer more suitable scenes as an alternative.

The parental control feature allows you to block access to scenes below the rating you input, thereby preventing your children from being able to view material you believe is unsuitable.

**1** Select “Rating” on the LOCK menu then press **▶**.

**2** To access the Rating, Password and Country Code features, you must input the 4-digit security code you created.

If you have not yet entered a security code you are prompted to do so.

Input a 4-digit code and press SELECT/ENTER. Enter it again and press SELECT/ENTER to verify. If you make a mistake before pressing SELECT/ENTER, press CLEAR.

**3** Select a rating from 1 to 8 using the **▲** / **▼** buttons.

**Rating 1-8:** Rating one (1) has the most restrictions and rating eight (8) is the least restrictive.

#### Unlock

If you select unlock, parental control is not active and the disc plays in full.

#### **N**ote

If you set a rating for the player, all disc scenes with the same rating or lower are played. Higher rated scenes are not played unless an alternate scene is available on the disc. The alternative must have the same rating or a lower one. If no suitable alternative is found, playback stops. You must enter the 4-digit password or change the rating level in order to play the disc.

**4** Press SELECT/ENTER to confirm your rating selection, then press SETUP to exit the menu.

### Password (Security Code)

You can enter or change password.

- 1 Select Password on the LOCK menu then press **▶**.
- 2 Follow step 2 as shown left (Rating). “Change” or “New” is highlighted.
- 3 Enter the new 4-digit code, then press SELECT/ENTER. Input it again to verify.
- 4 Press SETUP to exit the menu.

#### *If you forget your Security Code*

If you forget your security code you can clear it using the following steps:

- 1 Input the 6-digit number “210499” on the setup menu and the security code is cleared.
- 2 Enter a new code as described above.

#### **N**ote

When “INPUT PASSWD ■■■■■■” appears on the TV screen, press STOP (**■**) and then press SETUP to move to the setup menu.

#### Country Code **DVD**

Enter the code of the country/area whose standards were used to rate the DVD video disc, based on the list in the reference chapter.

**1** Select “Country Code” on the LOCK menu then press **▶**.

**2** Follow step 2 as shown left (Rating).

**3** Select the first character using **▲** / **▼** buttons.

**4** Shift the cursor using **▶** button and select the second character using **▲** / **▼** buttons.

**5** Press SELECT/ENTER to confirm your country code selection.

## Before Operation

### OTHERS

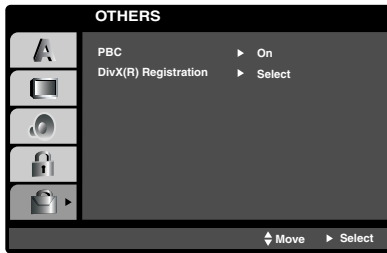

#### PBC **VCD**

Set Playback Control (PBC) to On or Off.

**On:** Video CDs with PBC are played according to the PBC.

**Off:** Video CDs with PBC are played the same way as Audio CDs.

#### DivX(R) Registration **DivX**

You can show the DivX DRM (Digital Right Management) Registration code for your unit only.

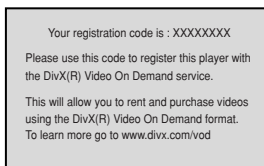

The Registration code is used for VOD (Video-On-Demand) service agent. You can purchase or rental an encrypt movie file.

#### **N** Notes

If you rent the DivX VOD file, it has several options of viewing limits as show below.

- Display the number which you can watch the file.

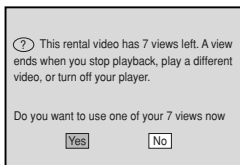

- The rental has been expired.

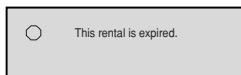

- Display the authorization error.

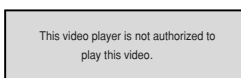

## Operation with DVD and Video CD

### Playing a DVD and Video CD

#### Playback Setup

- Turn on the TV and select the video input source connected to the unit.
- Audio system: Turn on the audio system and select the input source connected to the unit.

**1** Press **▲** OPEN/CLOSE button to open the disc tray.

**2** Load your chosen disc in the tray, with the playback side facing down.

**3** Press **▲** OPEN/CLOSE button to close the tray. Playback starts automatically. If playback does not start, press PLAY. In some cases, the disc menu might appear instead.

#### **T** If a menu screen is displayed

The menu screen may be displayed first after loading a DVD or Video CD which contains a menu.

#### **DVD**

Use the **▲** / **▼** / **◀** / **▶** buttons to select the title/chapter you want to view, then press SELECT/ENTER to start. Press TITLE or MENU to return to the menu screen.

#### **VCD**

Use the number buttons to select the track you want to view and press RETURN to return to the menu screen. Menu settings and operating procedures may differ. Follow the instructions on the each menu screen. You also may set PBC to Off (See "PBC" on page 15).

#### **N** Notes

- If parental control is set and the disc is not within the rating settings you must input the password. (See "LOCK" menu on page 14.)
- DVDs may have a region code. Your player will not play discs that have a region code different from your player. The region code for this player is 3 (three).

## Operation with DVD and Video CD

### General Features

#### Note

Unless stated otherwise, all operations described use the remote control. Some features may also be available on the Setup menu.

### Moving to another TITLE **DVD**

When a disc has more than one title, you can move to another title. Press DISPLAY while playback is stopped then the appropriate number (0-9) or use ◀/▶ to move to another title.

You can play any title by inputting its number while playback is stopped.

### Moving to another CHAPTER/TRACK

#### **DVD** **VCD** **DivX**

When a title on a disc has more than one chapter or a disc has more than one track, you can move to another chapter/track as follows:

- Press ◀◀ or ▶▶ briefly during playback to select the next chapter/track or to return to the beginning of the current chapter/track.
- Press ◀◀ twice briefly to step back to the previous chapter/track.
- To go directly to any chapter during DVD playback, press DISPLAY and press ▲/▼ to select the chapter/track icon. Then, input the chapter/track number or use ◀/▶.

### Search **DVD** **VCD** **DivX**

- 1 Press ◀◀ or ▶▶ during playback.  
The player will now go into SEARCH mode.
- 2 Press ◀◀ or ▶▶ repeatedly to select the required speed.  
DVD; X2, X4, X8, X16, X100  
DivX/Video CD; X2, X4, X8, X16
- 3 To exit SEARCH mode, press PLAY.

### Still Picture and Frame-by-frame playback

#### **DVD** **VCD** **DivX**

- 1 Press PAUSE/STEP on the remote control during playback.  
The player will now go into PAUSE mode.
- 2 You can advance the picture frame-by-frame by pressing PAUSE/STEP repeatedly on the remote control.
- 3 To exit still motion mode, press PLAY.

### Slow Motion **DVD** **VCD**

- 1 Press PAUSE/STEP on the remote control during playback.  
The player will enter PAUSE mode.
- 2 Use the ◀◀/▶▶ to select the required speed: ◀◀ 1/2, ◀◀ 1/4, ◀◀ 1/8 or ◀◀ 1/16 [(backward) - DVD only] or ▶▶ 1/2, ▶▶ 1/4, ▶▶ 1/8 or ▶▶ 1/16 (forward).
- 3 To return to normal PLAY, press PLAY.

### Repeat **DVD** **VCD** **DivX**

You can play a title/chapter/all/track on a disc. Press REPEAT during playback to select a desired repeat mode.

#### DVD Video Discs - Repeat Chapter/Title/Off

- Chapter: repeats the current chapter.
- Title: repeats the current title.
- Off : does not play repeatedly.

#### DivX/Video CDs - Repeat Track/All/Off

- Track : repeats the current track
- All : repeats all the tracks on a disc.
- Off : does not play repeatedly.

#### Note

- On a Video CD with PBC, you must set PBC to Off on the setup menu to use the repeat function (See "PBC" on page 15).

### Repeat A-B **DVD** **VCD**

To repeat a sequence in a title:

- 1 Press A-B at your chosen starting point.  
"A -" appears briefly on the TV screen.
- 2 Press A-B again at your chosen end point.  
"A - B" appears briefly on the TV screen, and the repeat sequence begins.
- 3 To cancel the sequence, press A-B.

### Time Search **DVD** **VCD**





The Time Search function allows you to start playing at any chosen time on the disc.

- 1 Press DISPLAY during playback. The on-screen display appears on the screen.  
The Time Search box shows the elapsed playing time of the current disc.
- 2 Within 10 seconds, press ▲/▼ to select the Time Search icon in the on-screen display.  
The "--:--:--" appears in the Time Search box.
- 3 Within 10 seconds, use the number buttons to enter the required start time. Enter hours, minutes, and seconds from left to right in the box.  
If you enter the wrong numbers, press CLEAR to remove the numbers you entered. Then enter the correct numbers.
- 4 Within 10 seconds, press SELECT/ENTER to confirm the start time.  
Playback starts from the selected time on the disc. If you enter an invalid time, playback will continue from the current point.

## Operation with DVD and Video CD

### Special DVD Features **DVD**

#### Checking the contents of DVD Video discs: Menus

DVDs may offer menus that allow you to access special features. To use the disc menu, press MENU. Then, press the appropriate number button to select an option. Or, use the  /  /  /  buttons to highlight your selection, then press SELECT/ENTER.

#### Title Menu **DVD**

- 1 Press TITLE.  
If the current title has a menu, the menu will appear on the screen. Otherwise, the disc menu may appear.
- 2 The menu can list camera angles, spoken language and subtitle options, and chapters for the title.
- 3 To remove the title menu, press TITLE again.

#### Disc Menu **DVD**

Press MENU.  
The disc menu is displayed.

#### Changing the Audio Language **DVD**

Press AUDIO repeatedly during playback to hear a different audio language or audio track.

#### Changing the Audio Channel **VCD**

Press AUDIO repeatedly during playback to hear a different audio channel (Stereo, Left or Right).

#### Subtitle **DVD**

Press SUBTITLE repeatedly during playback to see the different subtitle languages.

#### Note

If  appears, the feature is not available on the disc.

## Operation with Audio CD and MP3/WMA Disc

### Playing an Audio CD and MP3/WMA

#### Disc **CD** **MP3** **WMA**

The DVD Karaoke can play MP3/WMA formatted recordings on CD-ROM, CD-R, or CD-RW discs.

#### Audio CD

Once you insert an audio CD a menu appears on the TV screen. Press **▲** / **▼** to select a track then press **PLAY** or **SELECT/ENTER** and playback starts.

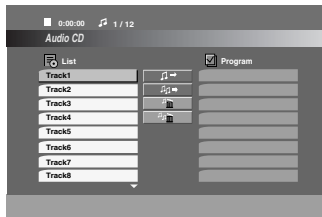

#### MP3 / WMA

1. Press **▲** / **▼** to select a folder, and press **SELECT/ENTER** to see the folder contents.
2. Press **▲** / **▼** to select a track then press **PLAY** or **SELECT/ENTER**. Playback starts.



#### Notes

- If you are in a file list on the MP3/WMA menu and want to return to the Folder list, use the **▲** / **▼** to highlight **List** and press **SELECT/ENTER**.
- Press **MENU** to go to the next page.
- On a CD with MP3/WMA file and JPEG file, you can switch MP3/WMA and JPEG menu. Press **TITLE** and MP3/WMA or JPEG word on top of the menu is highlighted. Then, use **◀** / **▶** to select MP3/WMA or JPEG then press **SELECT/ENTER**.

#### Pause **CD** **MP3** **WMA**

- 1 Press **PAUSE/STEP** during playback.
- 2 To return to playback, press **PLAY** or press **PAUSE/STEP** again.

#### Moving to another Track **CD** **MP3** **WMA**

- Press **▶▶** or **◀◀** briefly during playback to go to the next track or to return to the beginning of the current track.
- Press **◀◀** twice briefly to step back to the previous track.
- In case of audio CD, to go directly to any track, enter the track number using the numbered buttons (0-9) during playback.

#### Repeat Track/All/Off **CD** **MP3** **WMA**

You can play a title/chapter/all/track on a disc.

- 1 Press **REPEAT** when playing a disc. The repeat icon appears.
- 2 Press **REPEAT** to select a desired repeat mode.
  - Track: repeats the current track
  - All: repeats all the tracks on a disc.
  - Off(No display): does not play repeatedly.

#### Search **CD** **MP3** **WMA**

- 1 Press **◀◀** or **▶▶** during playback.  
The player will now go into **SEARCH** mode.
- 2 To exit **SEARCH** mode, press **PLAY**.

#### MP3 / WMA disc compatibility with this player is limited as follows:

- Sampling frequency: within 32 - 48 kHz (MP3), within 24 - 48kHz (WMA)
- Bit rate: within 32 - 320kbps (MP3), 40 - 192kbps (WMA)
- The player cannot read an MP3/WMA file that has a file extension other than ".mp3" / ".wma".
- CD-R physical format should be ISO 9660
- If you record MP3 / WMA files using software that cannot create a file system (eg. Direct-CD) it is impossible to playback MP3 / WMA files. We recommend that you use Easy-CD Creator, which creates an ISO 9660 file system.
- File names should have a maximum of 8 letters and must incorporate an .mp3 or .wma extension.
- They should not contain special letters such as / ? \* : " < > | etc.
- The total number of files on the disc should be less than 999.

This DVD player requires discs and recordings to meet certain technical standards in order to achieve optimal playback quality. Pre-recorded DVDs are automatically set to these standards. There are many different types of recordable disc formats (including CD-R containing MP3 or WMA files) and these require certain pre-existing conditions (see above) to ensure compatible playback.

**Customers should note that permission is required in order to download MP3 / WMA files and music from the Internet. Our company has no right to grant such permission. Permission should always be sought from the copyright owner.**

## Operation with JPEG Disc

### Viewing a JPEG disc **JPEG**

This unit can play discs with JPEG files. Before playing JPEG recordings, read the notes on JPEG Recordings on right.

- 1 Insert a disc and close the tray.**  
The JPEG menu appears on the TV screen.

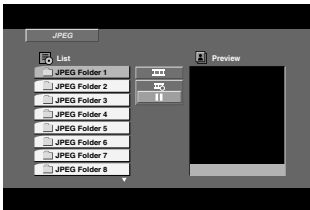

- 2 Press  $\blacktriangle$  /  $\blacktriangledown$  to select a folder, and press SELECT/ENTER. A list of files in the folder appears.**

#### Tip

If you are in a file list and want to return to the Folder list, use the  $\blacktriangle$  /  $\blacktriangledown$  buttons on the remote to highlight “ $\blacktriangle$ ” and press SELECT/ENTER to return to the previous menu screen.

- 3 If you want to view a particular file, press  $\blacktriangle$  /  $\blacktriangledown$  to highlight a file and press SELECT/ENTER or PLAY.**

Slide Show starts from the selected file if Speed option is not Off.

While viewing a file, you can press STOP (■) to move to the previous menu (JPEG menu).

#### Tip

- Press MENU to move to the next page.
- There are four Slide Speed options: >>> (Fast), >> (Normal), > (Slow) and off.  
Use  $\blacktriangle$  /  $\blacktriangledown$  /  $\blacktriangleleft$  /  $\blacktriangleright$  to highlight the Speed. Then, use  $\blacktriangleleft$  /  $\blacktriangleright$  to select the option you want to use then press SELECT/ENTER.
- If you set Speed option to Off, Slide Show is not active.

### Slide Show

Use  $\blacktriangle$  /  $\blacktriangledown$  /  $\blacktriangleleft$  /  $\blacktriangleright$  to highlight the Slide Show then press SELECT/ENTER.

### Moving to another File

Press  $\blacktriangleleft$  or  $\blacktriangleright$  once during viewing a picture to advance to the next file or to the previous file.

### Still Picture

- 1 Press PAUSE/STEP during slide show.  
The player will now go into PAUSE mode.
- 2 To return to the slide show, press PLAY or press PAUSE/STEP again.

#### JPEG disc compatibility with this player is limited as follows:

- Depending upon the size and number of JPEG files, it could take a long time for the DVD player to read the disc's contents. If you don't see an on-screen display after several minutes, some of the files may be too large — reduce the resolution of the JPEG files to less than 3760 x 3840 pixels and burn another disc.
- The total number of files and folders on the disc should be less than 999.
- Some discs may be incompatible due to a different recording format or the condition of disc.
- Ensure that all the selected files have the “.jpg” extensions when copying into the CD layout.
- If the files have “.jpe” or “.jpeg” extensions, please rename them as “.jpg” file.
- File names without “.jpg” extension will not be able to be read by this DVD player. Even though the files are shown as JPEG image files in Windows Explorer.

## Programmed Playback **CD** **MP3** **WMA**

The Program function enables you to store your favorite tracks from any disc in the player memory. A program can contain 99 tracks (Audio CD) or 300 tracks (MP3/WMA).

### 1 Insert a disc.

#### Audio CD and MP3/WMA Discs:

Audio CD or MP3/WMA menu appears as below.

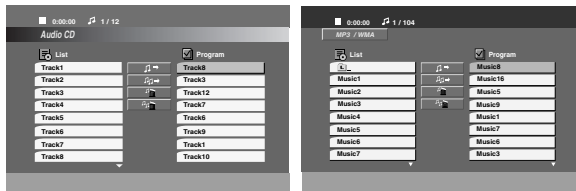

Audio CD Menu

MP3/WMA Menu

### 2 Select a track on the List.

3 Press PROGRAM. Or, select “ (Add)” icon then SELECT/ENTER to place the selected track on the Program list. Repeat to place additional tracks on the list.

#### Note

You can add all tracks in the disc. Select “ (Add All)” icon then press SELECT/ENTER.

4 Select the track you want to start playing on the Program list. Press and hold / to move to the next / previous page.

5 Press PLAY or SELECT/ENTER to start. Playback begins in the order in which you programmed the tracks and “PROG.” appears on the display window. Playback stops after all of the tracks on the Program list have played once.

### Repeat Programmed Tracks

You can play a title/chapter/all/track on a disc.

- 1 Press REPEAT when playing a disc. The repeat icon appears.
- 2 Press REPEAT to select a desired repeat mode.
  - Track: repeats the current track
  - All: repeats all the tracks on a disc.
  - Off(No display): does not play repeatedly.

### Erasing a Track from Program List

- 1 Use / / / to select the track that you wish to erase from the Program list.
- 2 Press CLEAR. Or, select “ (Delete)” icon then Press SELECT/ENTER to place the selected track on the Program list. Repeat to erase additional tracks on the list.

### Erasing the Complete Program List

Select “ (Del all)”, then press SELECT/ENTER. The complete Program for the disc is erased.

#### Note

The programs are also cleared when the disc is removed.

*To resume normal playback from programmed playback*

Select a track on the List then press SELECT/ENTER. “PROG.” disappears from the display window.

## Operation with DivX Disc

The unit can play the DivX files.

- 1 Insert a disc and close the tray.**  
The DivX menu appears on the TV screen.

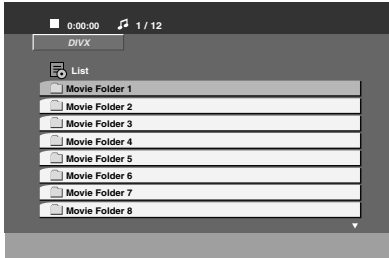

- 2 Press ▲ / ▼ to select a folder, and press SELECT/ENTER to see the folder contents.**

### Tip

If you are in a file list and want to return to the Folder list, use the ▲ / ▼ buttons on the remote control to highlight "⏪" and press SELECT/ENTER to return to the previous menu screen.

- 3 If you want to view a particular file, press ▲ / ▼ to highlight a file and press SELECT/ENTER or PLAY.**  
Playback starts.

### Notes

- Be sure to select "SUBTITLE ON" mode by pressing the subtitle file every time before playing a DivX file .
- When the subtitle has more than two languages in the file, original subtitle is only available.

## Display **DivX**

Press DISPLAY during playback.

General playback status can be displayed on the TV screen.

### DivX disc compatibility with this player is limited as follows:

- Available resolution size of the DivX file is under 720x576 (W x H) pixel.
- The file name of the DivX subtitle is available by 20-40 characters (differs from language).
- If there is impossible code to express in the DivX file, it may be displayed as " \_ " mark on the display.
- **If the number of the screen frame is over 30 per 1 second, this unit may not operate normally.**
- **If the video and audio structure of recorded file is not interleaved, either video or audio is outputted.**
- **If the file is recorded with GMC, the unit supports some of 1-point of the record level.**  
\* GMC?  
GMC is the acronym for Global Motion Compensation. It is an encoding tool specified in MPEG4 standard. Some MPEG4 encoder, like DivX or Xvid, have this option. There are different levels of GMC encoding, usually called 1-point, 2-point, or 3-point GMC.

### Playable DivX subtitle file

- ".srt ", ".smi ", ".sub "

### Playable DivX file

- ".avi ", ".mpg ", ".mpeg "

### Playable Codec format

- "DIVX3.xx ", "DIVX4.xx ", "DIVX5.xx ", "XVID ", "MP43 ", "3IVX ", "MP42 "

### Playable Audio format

- "AC3 ", "DTS ", "PCM ", "MP3 ", "WMA ".
  - Sampling frequency: within 32 - 48 kHz (MP3), within 24 - 48kHz (WMA)
  - Bit rate: within 32 - 320kbps (MP3), 40 - 192kbps (WMA)

## Operation with KARAOKE

You can play KARAOKE(singing along) with CD by connecting a microphone to the unit.  
You can enjoy KARAOKE with a stereo-recorded disc, even if it is a non-karaoke disc, by reducing the singer's voice.

### Karaoke Basic Playback

- 1** Check if the system is connected.  
(Refer to the page 8-9.)
- 2** Turn on the powers of TV (or Amplifier) and DVD Karaoke and enter to the video mode on TV.
- 3** Press **▲ OPEN/CLOSE** to open the disc tray and load supplied karaoke disc in the tray with the label facing up.
- 4** Press **▲ OPEN/CLOSE** to close the tray.

[TV Screen]

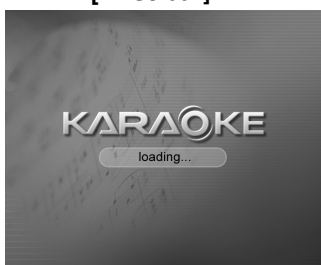

- 5** Connect the microphone to the MIC 1 or MIC 2 jack.
- 6** Select the melody number you want by pressing **NUMERIC** buttons.  
If you cancel the selected melody number, press the **CLEAR**.
- 7** Press **PLAY**.  
The selected melody number is played.  
Sing in tone with microphone.  
After melody ends, it is stopped automatically and score appears.

#### **N**ote

Don't connect the microphone during playing DivX disc.

### Karaoke Advanced Playback

#### Return Function



This is a function that returns to the preceding MENU.

Press the **RETURN** .

#### **N**ote



If there is no preceding menu (in case of the first menu), this function may not be executed.

#### To Adjust MIC Volume

Press the Microphone volume control (**MIC VOL.**  /  ) button on the remote control clockwise to increase the volume, or counterclockwise to decrease it. (0~15 steps)

#### To Adjust ECHO Volume

You can give an echo effect to the sound from the microphones.

Press the ECHO volume control (**ECHO VOL.**  /  ) button on the remote control clockwise to increase the echo, or counterclockwise to decrease it. (0~15 steps)

#### Key Control

You can change the key to suit your vocal range.  
You can adjust the key to 13 steps (6steps higher, 6steps lower and the original key).  
- The setting appears on the screen.

**Press KEY CONTROL (b/#) repeatedly on the remote control or turn KEY CONTROL (b/#) on the front panel to find the key that suits your vocal range.**

- To flatten the key one by one, press the **KEY CONTROL (b)** repeatedly during playback.
- To sharp the key one by one, press the **KEY CONTROL (#)** repeatedly during playback.
- To return to the original key, press the **KEY CONTROL (b/#)** repeatedly to appear the original key.

## Operation with KARAOKE

### Reserving the Songs

When you want to make a reservation of next melody, you can enjoy the most 8 melodies reservation Without waiting.

**1** Press the **NUMERIC** buttons to reserve melody number you want in the karaoke disc play mode.

Melody number appears on the TV screen.

**2** Press **PROGRAM**.  
The melody number is made a reservation.

**3** Repeat steps 1-2.  
You can reserve 8 songs.



After the one song finishes its playback, the next song will be playback automatically.

#### To cancel the reserved song

Each time you press **CLEAR**, the reserved song will be cancelled one by one.

#### To cancel or change the wrong reserved song

Press the **PROGRAM** to move to the desired position, then press the **CLEAR** to cancel the reserved song.

### Male/Female Function

If you want to sing a song of **MAN's** or **WOMEN's** key, press **MALE**(♂)/**FEMALE**(♀) button repeatedly to change **MAN's** or **WOMEN's** key.

### Tempo Change

You can use this function when you want to play fast or slow.

- Press **TEMPO +** repeatedly during singing to play faster.
- Press **TEMPO -** repeatedly during singing slower.

### Shadow Function

If Video CD caption and the song's subtitle are mixed up, the song's subtitle may be invisible. In this case, to highlight the song's subtitle, press **SHADOW**.

- It will be highlighted by background shadow image.

### Karaoke MENU Playback

#### Preparation

Press **MENU** on the karaoke mode.

The main MENU appears on the screen.

#### Main MENU (On the TV screen)



#### SETUP

**1** Select "1. SET UP" by pressing **▲** / **▼** on the main menu.

**2** Use **◀** / **▶** to select the desired option, and press **SELECT/ENTER**.

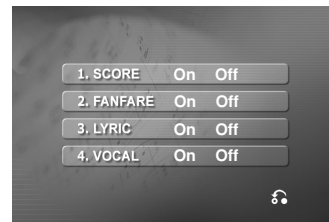

#### SCORE On/Off

**On**: When singing by selection of melody, song score comes out after one piece of song is ended.

To cancel it, select the **Off**.

#### FANFARE On/Off

**On**: In condition of **POWER ON**, scoring fanfare operates. The fanfare sound comes out after singing finished.

To cancel it, select the **Off**.

#### LYRIC On/Off

**On**: When singing by selection of melody, song lyric appears on the TV screen.

To cancel it, select the **Off**.

#### VOCAL On/Off

**On**: When singing by selection of melody, vocal range is adjusted a sound.

To cancel it, select the **Off**.



To move to the main menu, press **MENU** or **RETURN**.

# Operation with KARAOKE

## MUSIC LIST

### LOCAL SONG and POP SONG

**1** Select "2. MUSIC LIST" by pressing the / on the main menu.

The LOCAL SONG and POP SONG menu will be shown on the TV screen.

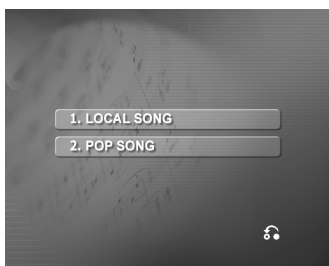

**2** Select "1. LOCAL SONG" or "2. POP SONG" by pressing the / , and press SELECT/ ENTER. SONG LIST and SINGER LIST menu will be shown on the TV screen.

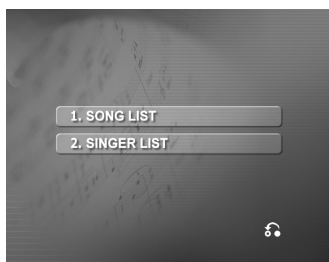

### SONG LIST

**1** Select "1. SONG LIST" and select the initial of the song title you want by pressing the / , then press SELECT/ ENTER.

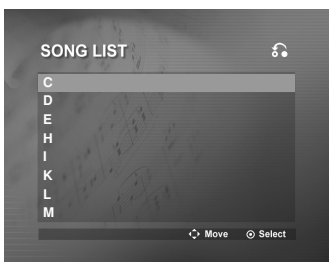

**2** Select the song title you want by pressing the / , and press SELECT/ ENTER.

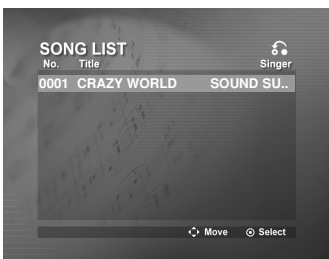

### SINGER LIST

**1** Select "2. SINGER LIST" and select the initial of the singer you want by pressing the / in the SONG LIST and SINGER LIST menu, and press SELECT/ ENTER.

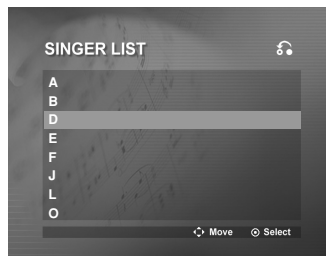

**2** Select the singer you want by pressing the / , and press SELECT/ ENTER.

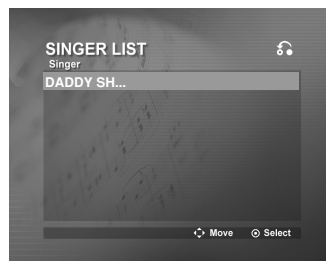

**3** Select the song title of the singer you want by pressing the / , and press SELECT/ ENTER.

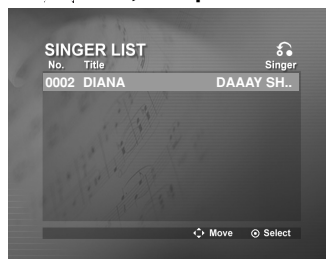

### Note

To move the previous mode, select the by pressing the / , then press SELECT/ ENTER.

## Operation with KARAOKE

### RANDOM

- 1 Select "3. RANDOM" by pressing / on the main menu.



- 2 Press SELECT/ENTER to begin randomly.

### CHALLENGE

It has a function which enjoy a song game dividing by two teams of red team & blue team.

- 1 Select "4. CHALLENGE" by pressing / on the main menu.  
It appears as below.

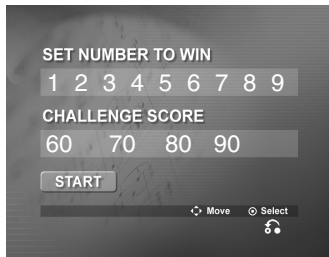

- 2 Select "SET NUMBER TO WIN" by pressing / , and select one of NUMERIC buttons 1~9 by pressing / to select winner's number, then press SELECT/ ENTER.
- 3 Select "CHALLENGE SCORE" by pressing / , and select one of 60,70,80 or 90 by pressing / to select success score, then press SELECT/ ENTER.
- 4 Select "START" by pressing / , then press SELECT/ ENTER.  
It appears as below.

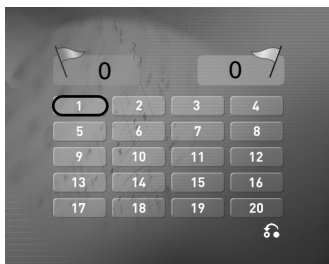

- 5 Select number you want by pressing / and press SELECT/ ENTER.  
Sing along with the accompaniment.

- 6 Repeat step 4~5.  
Change the team of red team or blue team alternately.

- 7 When reaching the targeted winning number, the "CONGRATULATION!" will be shown on the TV screen.  
It appears as below.



- 8 Whether you keep going the song game or not, select "YES" or "NO" by pressing / as below.

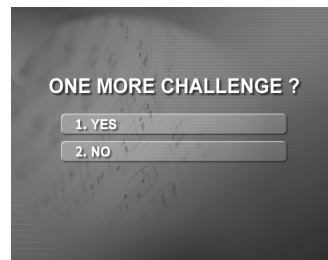

## Language Code List

Use this list to input your desired language for the following initial settings:  
Disc Audio, Disc Subtitle, Disc Menu.

Language	Code	Language	Code	Language	Code	Language	Code
Abkhazian	6566	Finnish	7073	Macedonian	7775	Slovenian	8376
Afar	6565	French	7082	Malagasy	7771	Somali	8379
Afrikaans	6570	Galician	7176	Malay	7783	Spanish	6983
Albanian	8381	Georgian	7565	Malayalam	7776	Sudanese	8385
Ameharic	6577	German	6869	Maltese	7784	Swahili	8387
Arabic	6582	Greek	6976	Maori	7773	Swedish	8386
Armenian	7289	Greenlandic	7576	Marathi	7782	Tagalog	8476
Assamese	6583	Guarani	7178	Moldavian	7779	Tajik	8471
Azerbaijani	6590	Gujarati	7185	Mongolian	7778	Tamil	8465
Bashkir	6665	Hausa	7265	Nauru	7865	Tatar	8484
Basque	6985	Hebrew	7387	Nepali	7869	Telugu	8469
Bengali; Bangla	6678	Hindi	7273	Norwegian	7879	Thai	8472
Bhutani	6890	Hungarian	7285	Oriya	7982	Tibetan	6679
Bihari	6672	Icelandic	7383	Panjabi	8065	Tigrinya	8473
Breton	6682	Indonesian	7378	Pashto, Pushto	8083	Tonga	8479
Bulgarian	6671	Interlingua	7365	Persian	7065	Turkish	8482
Burmese	7789	Irish	7165	Polish	8076	Turkmen	8475
Byelorussian	6669	Italian	7384	Portuguese	8084	Twi	8487
Cambodian	7577	Japanese	7465	Quechua	8185	Ukrainian	8575
Catalan	6765	Javanese	7487	Rhaeto-Romance	8277	Urdu	8582
Chinese	9072	Kannada	7578	Rumanian	8279	Uzbek	8590
Corsican	6779	Kashmiri	7583	Russian	8285	Vietnamese	8673
Croatian	7282	Kazakh	7575	Samoan	8377	Volapük	8679
Czech	6783	Kirghiz	7589	Sanskrit	8365	Welsh	6789
Danish	6865	Korean	7579	Scots Gaelic	7168	Wolof	8779
Dutch	7876	Kurdish	7585	Serbian	8382	Xhosa	8872
English	6978	Laothian	7679	Serbo-Croatian	8372	Yiddish	7473
Esperanto	6979	Latin	7665	Shona	8378	Yoruba	8979
Estonian	6984	Latvian, Lettish	7686	Sindhi	8368	Zulu	9085
Faroese	7079	Lingala	7678	Singhalese	8373		
Fiji	7074	Lithuanian	7684	Slovak	8375		

## Country Code List

Choose a country code from this list.

Country	Code	Country	Code	Country	Code	Country	Code
Afghanistan	AF	Ethiopia	ET	Malaysia	MY	Saudi Arabia	SA
Argentina	AR	Fiji	FJ	Maldives	MV	Senegal	SN
Australia	AU	Finland	FI	Mexico	MX	Singapore	SG
Austria	AT	France	FR	Monaco	MC	Slovak Republic	SK
Belgium	BE	Germany	DE	Mongolia	MN	Slovenia	SI
Bhutan	BT	Great Britain	GB	Morocco	MA	South Africa	ZA
Bolivia	BO	Greece	GR	Nepal	NP	South Korea	KR
Brazil	BR	Greenland	GL	Netherlands	NL	Spain	ES
Cambodia	KH	Islands	HM	Dutch Antilles	AN	Sri Lanka	LK
Canada	CA	Hong Kong	HK	New Zealand	NZ	Sweden	SE
Chile	CL	Hungary	HU	Nigeria	NG	Switzerland	CH
China	CN	India	IN	Norway	NO	Taiwan	TW
Colombia	CO	Indonesia	ID	Oman	OM	Thailand	TH
Congo	CG	Israel	IL	Pakistan	PK	Turkey	TR
Costa Rica	CR	Italy	IT	Panama	PA	Uganda	UG
Croatia	HR	Jamaica	JM	Paraguay	PY	Ukraine	UA
Czech Republic	CZ	Japan	JP	Philippines	PH	United States	US
Denmark	DK	Kenya	KE	Poland	PL	Uruguay	UY
Ecuador	EC	Kuwait	KW	Portugal	PT	Uzbekistan	UZ
Egypt	EG	Libya	LY	Romania	RO	Vietnam	VN
El Salvador	SV	Luxembourg	LU	Russian Federation	RU	Zimbabwe	ZW





P/NO : 3834RH0131K