



LG

Life's Good

OWNER'S MANUAL DLP PROJECTOR

Please read this manual carefully before operating your set and retain it for future reference.

HX300G
HX301G

DLP PROJECTOR

Warning

This is a class B product. In a domestic environment this product may cause radio interference, in which case the user may be required to take adequate measures.

CE 0983 ⚠

This projector complies with EMC Directive and R&TTE Directive.

DE	DK	ES	FI	FR
GB	GR	HU	IT	NL
NO	PL	PT	SE	

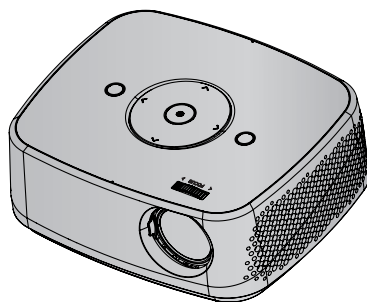

Contents

Safety Instructions	4	Adjusting Treble.....	25
Names of parts		TIME Menu Options	
Main Body	7	Sleep time Function	26
Control Panel.....	7	Auto Off Function	26
Connecting Part	8	OPTION Menu Options	
Remote Control	9	Selecting Language	27
Installing Batteries.....	9	Using Blank Function	27
Accessories	10	Selecting Blank image.....	27
Optional Extras	10	Screen Capture Function.....	28
Installing and Composition		To adjust the brightness of the screen	28
Installation Precautions.....	11	To make the power of the projector turn on automatically when power is in.....	28
Basic Operation of the Projector.....	12	Demo Mode Function	29
How to install the projector using the tripod.....	13	Initial Setting Function.....	29
Kensington Security System.....	13	INFORMATION Menu Options	
Turning on the Projector	14	To See The Projector Information.....	29
Turning off the Projector	14	USB	
Focus and Position of the Screen Image.....	14	To use the USB device	
Selecting input mode	14	Connecting the USB device.....	30
Connection		Eject USB	30
Connecting to a Desktop PC.....	15	Precautions when using the USB device	31
Connecting to a Video Source	15	PHOTO LIST	
Connecting to a DVD Player	16	Screen Components	32
Connecting to a D-TV Set-Top Box	16	Photo Selection and Popup Menu	32
Function		Full Screen Menu	33
PICTURE Menu Options		MUSIC LIST	
Picture mode.....	17	Screen Components	34
Adjusting Picture Mode.....	17	Music Selection and Popup Menu	34
Advanced Control Function.....	18	MOVIE LIST	
Color Temperature Function.....	19	Supported Movie File.....	35
Picture Reset Function.....	19	Precautions when playing the DivX	36
SCREEN Menu Options		Screen Components	37
To Change PJT Mode.....	20	Movie Selection and Popup Menu.....	37
Using Aspect Ratio Function	20	Playing the Movie.....	38
Using Keystone Function	20	Option Menu Selection.....	38
Auto Configure Function.....	21	To See The DivX Registration Code.....	39
RGB Config. Function.....	21	Deactivation Function.....	39
Using the Still Function	21	FILE VIEWER	
AUDIO Menu Options		Screen Components	40
What is FM Wireless Audio? (HX300G only)	22	View File.....	40
Installing Instructions (HX300G only).....	23	Information	
What do I do if the FM receiving signal is not good? (HX300G only).....	23	Supported Monitor Display.....	41
To listen through the FM receiver speaker (HX300G only).....	24	Maintenance	41
Adjusting Volume.....	24	Specifications	42
Function Audio.....	24	Open Source Software Notice.....	43
Adjusting Speaker Balance	25		

Disposal of your old appliance



- When this crossed-out wheeled bin symbol is attached to a product it means the product is covered by the European Directive 2002/96/EC.
- All electrical and electronic products should be disposed of separately from the municipal waste stream through designated collection facilities appointed by your government or your local authorities.
- The correct disposal of your old appliance will help prevent potential negative consequences for the environment and human health.
- For more detailed information about disposal of your old appliance, please contact your city office, waste disposal service or the shop where you purchased the product.
- The fluorescent lamp used in this product contains a small amount of mercury. Do not dispose of this product with general household waste. Disposal of this product must be carried out in accordance to the regulations of your local authority.

Safety Instructions

Please take note of the safety instructions to prevent any potential accident or misuse of the projector.

- Safety Instructions are given in two forms as detailed below.

 **WARNING** : The violation of this instruction may cause serious injuries and even death.

 **NOTES** : The violation of this instruction may cause injuries or damage to the projector.

- After reading this manual, keep it in the place that you can access easily.

Indoor Installation WARNING

<p>Do not place the Projector in direct sunlight or near heat sources such as radiators, fires, stove etc.</p> <p>This may cause a fire hazard!</p>	<p>Do not place flammable materials in, on or near the projector.</p> <p>This may cause a fire hazard!</p>	<p>Do not hang on the installed projector.</p> <p>It may cause the projector to fall, causing injury or death.</p>
<p>Do not block the vents of the projector or restrict air-flow in any way.</p> <p>This would cause the internal temperature to increase and could cause a fire hazard or damage to the unit!</p>	<p>Do not place the projector close to sources of steam or oil such as a humidifier.</p> <p>This may create a fire hazard or an electric shock hazard!</p>	<p>Do not place the projector where it might be exposed to dust.</p> <p>This may cause a fire hazard or damage to the unit!</p>
<p>Do not use the projector in a damp place such as a bathroom where it is likely to get wet.</p> <p>This may cause a fire or an electric shock hazard!</p>	<p>Do not place the projector directly on a carpet, rug or place where ventilation is restricted.</p> <p>This would cause its internal temperature to increase and might create a fire hazard or damage the unit.</p>	<p>Ensure good ventilation around the projector. The distance between the projector and the wall should be more than 30 cm.</p> <p>An excessive increase in its internal temperature may cause a fire hazard or damage to the unit!</p>

Indoor Installation NOTES

<p>When installing the projector on a table, be careful not to place it near the edge.</p> <p>The projector could fall causing injury and damage to the projector. Only use a suitable stand.</p>	<p>Disconnect from the power supply and remove all connections before moving, or cleaning.</p>	<p>Only use the projector on a level and stable surface.</p> <p>It may fall and cause injury and/or damage to the unit.</p>
--	--	---

Power WARNING

<p>Earth wire should be connected.</p> <p>Ensure that you connect the earth ground wire to prevent possible electric shock (That is a Projector with a three-prong grounded AC plug must be connected to a three-prong grounded AC outlet). If grounding methods are not possible, have a qualified electrician install a separate circuit breaker. Do not try to ground the unit by connecting it to telephone wires, lightning rods, or gas pipes.</p>	<p>The power cord should be inserted fully into the power outlet to avoid a fire hazard!</p> <p>This may cause a fire hazard or damage the unit.</p>	<p>Do not place heavy objects on the power cord.</p> <p>This may cause a fire or an electric shock hazard!</p>
--	--	--

Power		 WARNING
<p>Never touch the power plug with a wet hand.</p> <p>This may cause an electric shock hazard!</p>	<p>Do not plug-in too many items into one power outlet.</p> <p>It may result in overheating of the outlet and create a fire hazard!</p>	<p>Prevent dust from collecting on the power plug pins or outlet.</p> <p>This may cause a fire hazard!</p>

Power		 NOTES
<p>Hold the plug firmly when unplugging. If you pull the cord, it may be damaged.</p> <p>This may cause a fire hazard!</p>	<p>Do not use if the power cord or the plug is damaged or any part of the power outlet is loose.</p> <p>This may cause a fire or an electric shock hazard or damage to the unit!</p>	<p>Ensure the power cord does not come into contact with sharp or hot objects.</p> <p>This may cause a fire or an electric shock hazard or damage to the unit!</p>

<p>Place the projector where people will not trip or tread on the power cord.</p> <p>This may cause a fire or an electric shock hazard or damage to the unit!</p>	<p>Do not turn the projector On/Off by plugging-in or unplugging the power plug to the wall outlet. (Allow the unit to cool before removing power.)</p> <p>It may cause mechanical failure or could cause an electric shock.</p>
---	--

Using		 WARNING
<p>Do not place anything containing liquid on top of the projector such as flowerpot, cup, cosmetics or candle.</p> <p>This may cause a fire hazard or damage to the unit!</p>	<p>In case of impact shock or damage to the projector switch it off and unplug it from the power outlet and contact an authorized service center.</p> <p>This may cause a fire or an electric shock hazard or damage to the unit!</p>	<p>Do not allow any objects to fall into the projector.</p> <p>This may cause an electric shock hazard or damage to the unit!</p>

<p>If water is spilt into the projector unplug it from the power supply immediately and consult your Service Agent.</p> <p>This may cause an electric shock hazard or damage to the unit!</p>	<p>Dispose of used batteries carefully and safely.</p> <p>In the case of a battery being swallowed by a child please consult a doctor immediately.</p>
---	--

<p>Do not remove any covers. High risk of Electric Shock!</p>	<p>Don't look directly into the lens when the projector is in use. Eye damage may occur!</p>	<p>Do not touch metal parts during or soon after operation since the vents will remain very hot!</p>
---	--	--

CAUTION concerning the Power Cord

It is recommend that most appliances be placed on a dedicated circuit; that is, a single outlet circuit which powers only that appliance and has no additional outlets or branch circuits. Check the specification page of this owner's manual to be certain.

Do not overload wall outlets. Overloaded wall outlets, loose or damaged wall outlets, extension cords, frayed power cords, or damaged or cracked wire insulation are dangerous. Any of these conditions could result in electric shock or fire. Periodically examine the cord of your appliance, and if its appearance indicates damage or deterioration, unplug it, discontinue use of the appliance, and have the cord replaced with an exact replacement part by authorized service personnel.

Protect the power cord from physical or mechanical abuse, such as being twisted, kinked, pinched, closed in a door, or walked upon. Pay particular attention to plugs, wall outlets, and the point where the cord exits the appliance.

Using	 WARNING	
<p>If the projector is in a room that experiences a gas leak, do not touch the projector.</p> <p>It can cause a fire or a burn by a spark.</p>	<p>Always open the lens door or remove the lens cap when the projector lamp is on.</p>	

Using	 NOTES	
<p>Do not place heavy objects on top of projector.</p> <p>This may cause mechanical failure or personal injury!</p>	<p>Take care not to impact the lens particularly when moving the projector.</p>	<p>Do not touch the lens of the projector. It is delicate and easily damaged.</p>
<p>Do not use any sharp tools on the projector as this will damage the casing.</p>	<p>In the event that an image does not appear on the screen please switch it off and unplug it from the power outlet and contact your Service Agent.</p> <p>This may cause a fire or an electric shock hazard or damage to the unit!</p>	<p>Do not drop the projector or allow impact shock.</p> <p>This may cause mechanical failure or personal injury!</p>

Cleaning	 WARNING	
<p>Do not use water while cleaning the projector.</p> <p>This may cause damage to the projector or an electric shock hazard.</p>	<p>In the unlikely event of smoke or a strange smell from the projector, switch it off, unplug it from the wall outlet and contact your dealer or service center.</p> <p>This may cause a fire or an electric shock hazard or damage to the unit!</p>	<p>Use an air spray or soft cloth that is moist with a neutral detergent and water for removing dust or stains on the projection lens.</p>

Cleaning	 NOTES	
<p>Contact the Service Center once a year to clean the internal parts of the projector.</p> <p>Accumulated dust can cause mechanical failure.</p>	<p>When cleaning the plastic parts such as projector case, unplug the power and wipe it with a soft cloth. Do not use cleanser, spray water or wipe with a wet cloth. Especially, never use cleanser (glass cleaner), automobile or industrial shiner, abrasive or wax, benzene, alcohol etc., which can damage the product. Use an air spray or soft cloth that is moist with a neutral detergent and water for removing dust or stains on the projection lens.</p> <p>It can cause fire, electric shock or product damage (deformation, corrosion and damage).</p>	

Others	 WARNING	
<p>Do not attempt to service the projector yourself. Contact your dealer or service center.</p> <p>This may cause damage to the projector and could give an electric Shock as well as invalidating the warranty!</p>		

Others	 NOTES	
<p>Do not mix new batteries with old batteries.</p> <p>This may cause the batteries to over-heat and leak.</p>	<p>Be sure to unplug if the projector is not to be used for a long period.</p> <p>Accumulated dust may cause a fire hazard or damage to the unit!</p>	<p>Only use the specified type of battery.</p> <p>This could cause damage to the remote control.</p>

Names of parts

Main Body

* The projector is manufactured using high-precision technology. You may, however, see on the Projector screen tiny black points and/or bright points (red, blue, or green). This can be a normal result of the manufacturing process and does not always indicate a malfunction.

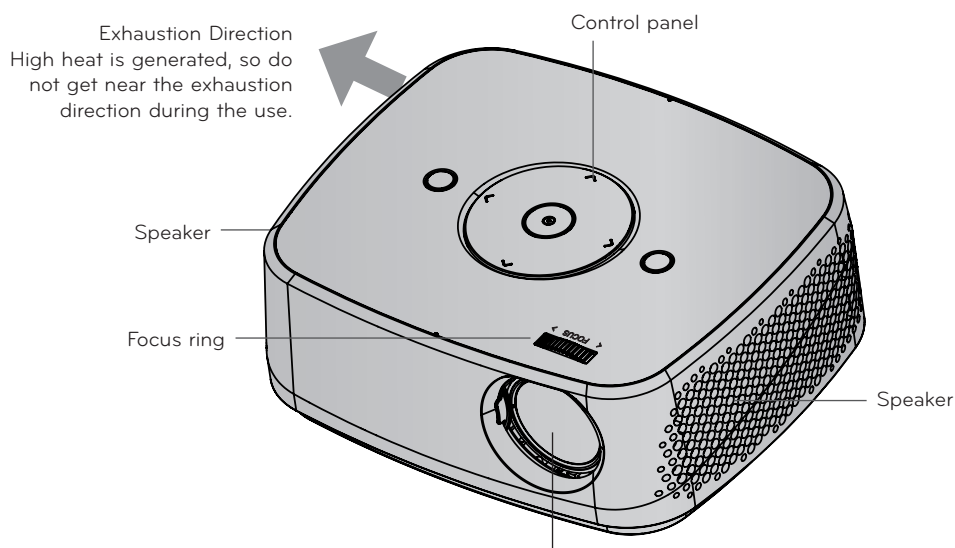

* Do not touch the lens when using the projector or opening the lens door.

Control Panel

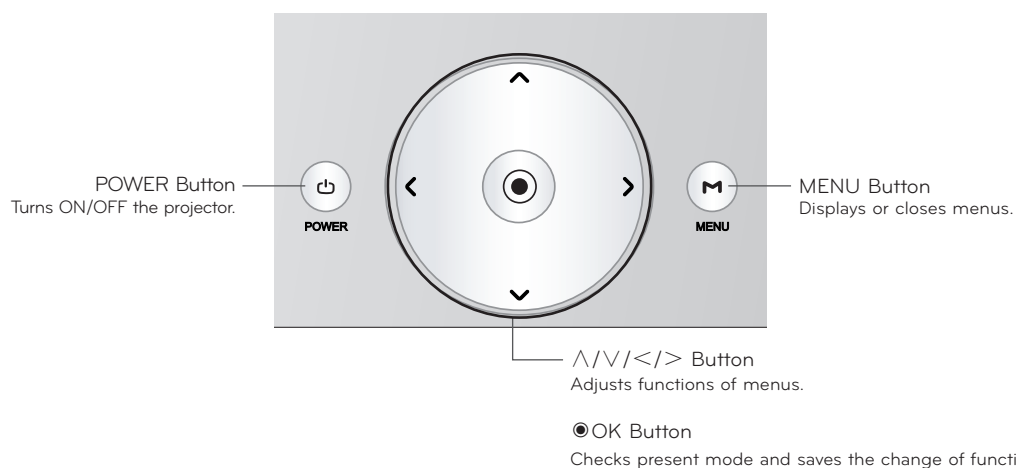

Connecting Part

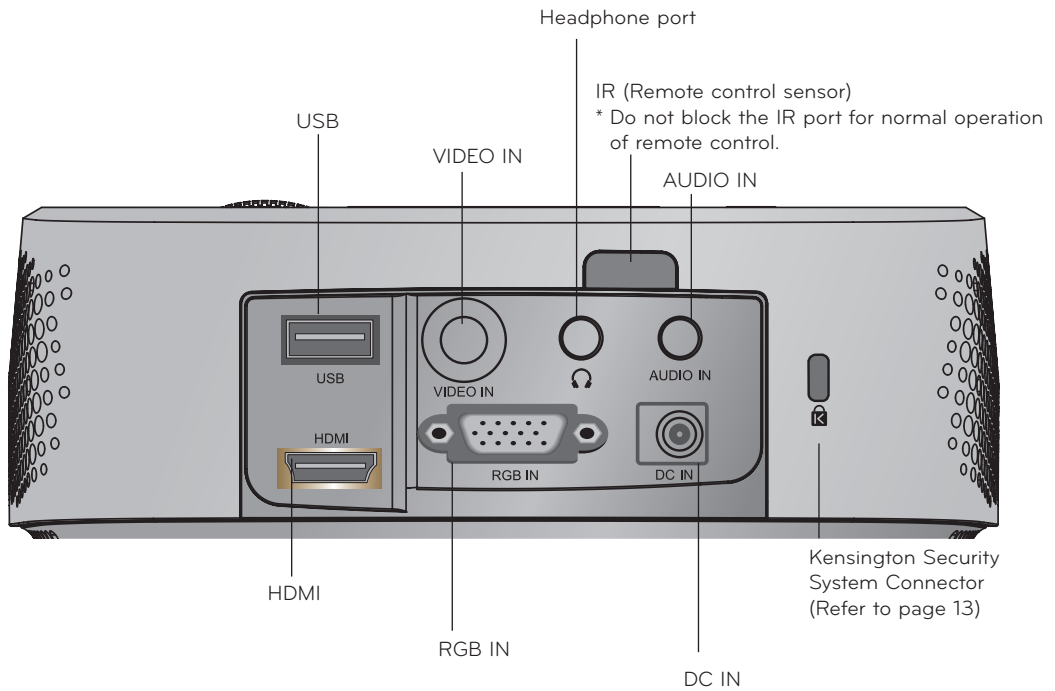

*When using HDMI/USB connector, if the size of the jack connecting to the connector is too big, they may not be connected. Please use standard size jack.

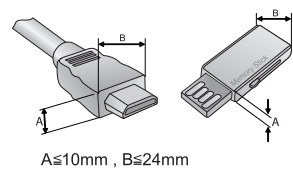

Remote Control

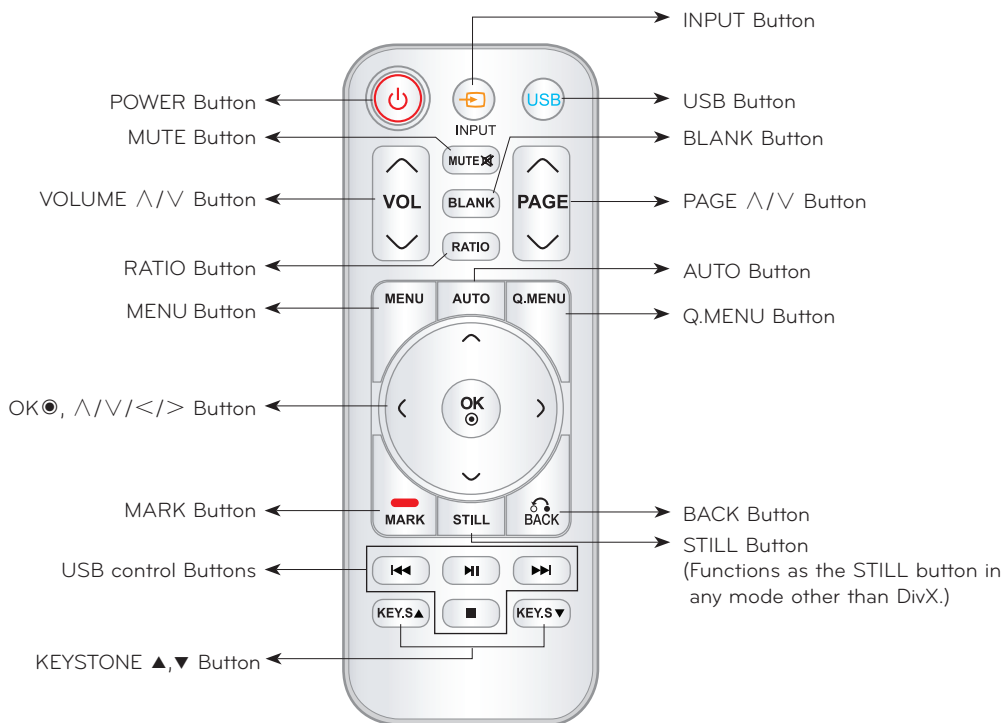

Installing Batteries

CAUTION

RISK OF EXPLOSION IF BATTERY IS REPLACED WITH AN INCORRECT TYPE.
DISPOSE OF USED BATTERIES ACCORDING TO THE INSTRUCTIONS.

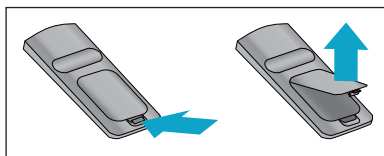

- Open the battery compartment cover on the back of the remote control.
- Insert the specified type of batteries with correct polarity, match "+" with "+", and match "-" with "-".
- Install two 1.5V AAA batteries. Don't mix used batteries with new batteries.

Accessories



Remote Control



AAA Battery

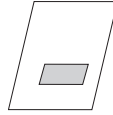

Owner's manual

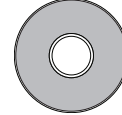

CD Owner's manual



Power Cord



Computer Cable



AC-DC Adapter



RGB to Component Cable

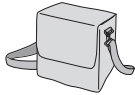

Portable bag



Polishing Cloth

Note!

- Use a remote control up to 6 m distance and 30° (left/right) within the receiving unit scope.
- We recommend you to use the remote control under 3 m distance and 30° (left/right) when the cables are connected in the back outputs.
- When you carry the remote control in the portable bag, make sure that the buttons on the remote control are not pressed by the projector, cables, documents or any other accessories in the bag. Otherwise, it may reduce the battery life significantly.

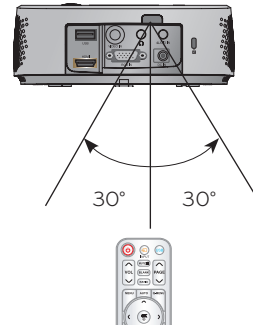

Optional Extras

* Contact your dealer to purchase these items.

* Optional parts can be changed without notice to improve the quality of the product, and new optional parts can be added.

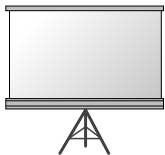

Projection Screen



Tripod



HDMI Cable

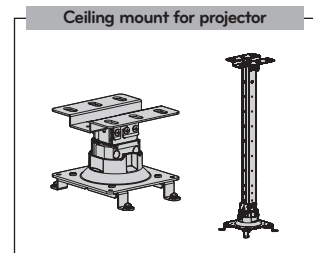

Video Cable



Audio Cable



Component Cable

Installing and Composition

Installation Precautions

Provide proper ventilation for this projector.

- The projector is equipped with ventilation holes(intake) on the bottom and ventilation holes(exhaust) on the front. Do not block or place anything near these holes. Internal heat build-up may occur, causing picture degradation or damage to the projector.
- Do not place the projector on a carpet, rug or other similar surface. It may prevent a adequate ventilation of the projector bottom. This product should be mounted to a wall or ceiling only.

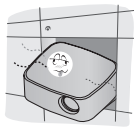

- Never push projector or spill any kind of liquid into the projector.
- Leave an adequate distance (30 cm or more) around the projector.



Place this projector in adequate temperature and humidity conditions.

- Install this projector only in a location where adequate temperature and humidity is available. (refer page 42)

Don't place the projector where it can be covered with dust.

- This may cause overheating of the projector.

Do not obstruct the slots and openings of the projector. This may cause overheating and create a fire hazard.

This projector is manufactured using high-precision technology. You may, however, see tiny black points and/or bright points (red, blue or green) that continuously appear on the projector Screen. This is a normal result of the manufacturing process and does not indicate a malfunction.

To display DTV programs, it is necessary to purchase a DTV receiver (Set-top Box) and connect it to the projector.

The remote control may not work when a lamp equipped with electronic ballast or a three-wavelength lamp is installed. Replace those lamps with international standard products to use the remote control normally.

Basic Operation of the Projector

1. Place the projector on a sturdy and horizontal surface with the PC or AV source.
2. Place the projector with the desired distance from the screen. The distance between the projector and the screen determines the actual size of the image.
3. Position the projector so that the lens is set at a right angle to the screen. If the projector is not set at a right angle, the screen image will be crooked. Although, slight angles can be counteracted using the Keystone adjustment. (Refer to page 20.)
4. Connect the power cable to the projector and the wall outlet after placing the projector in its desired location.

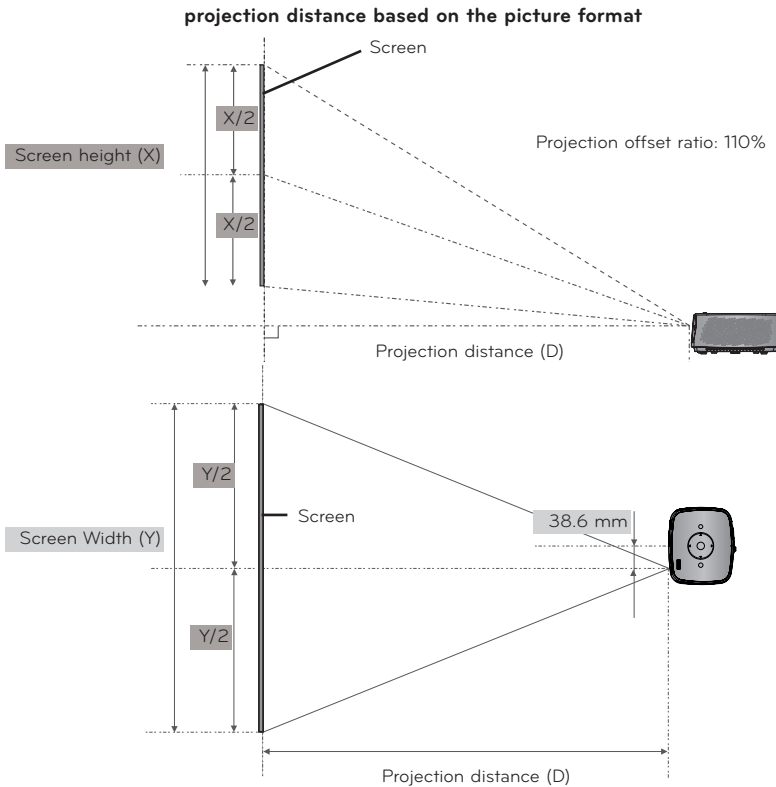

4 : 3 Scale			
Diagonal Size (mm)	Horizontal Size (mm)	Vertical Size (mm)	Projection Distance (D) (mm)
508	406	305	549
635	508	381	686
762	610	457	823
889	711	533	961
1016	813	610	1098
1143	914	686	1235
1270	1016	762	1372
1397	1118	838	1509
1524	1219	914	1655
1651	1321	991	1785
1778	1422	1067	1922
1905	1524	1143	2060
2032	1626	1219	2195
2159	1727	1295	2335
2286	1829	1372	2470
2413	1930	1448	2610
2540	2032	1524	2750

How to install the projector using the tripod

- * You can install this projector using a tripod for the camera. You can assemble the projector instead of the camera on camera tripod.
- * When stabilizing the tripod, we recommend using the locking bolt of the standard size 4.5 mm or less. The maximum size allowed for the locking bolt is 6.5 mm. (If it is longer than the maximum allowed size, it may damage the projector.)

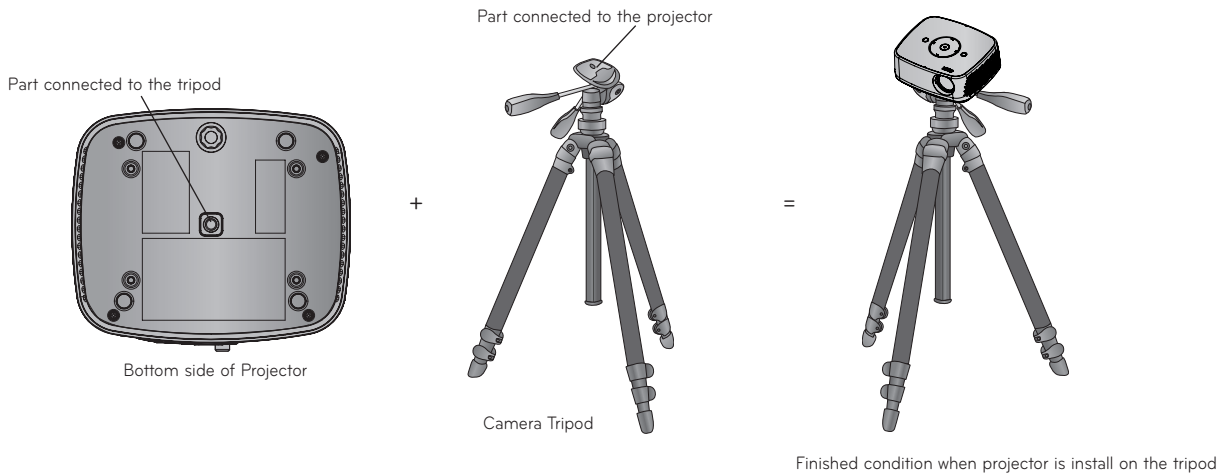

Kensington Security System

- This projector has a Kensington Security System Connector on the side panel. Connect the Kensington Security System cable as below.
- For the detailed installation and use of the Kensington Security System, refer to the user's guide included with the Kensington Security System set. And for further information, contact <http://www.kensington.com>, the internet homepage of the Kensington company that deals with expensive electronic equipment such as notebook PCs or projectors.
- The Kensington Security System is an optional item.

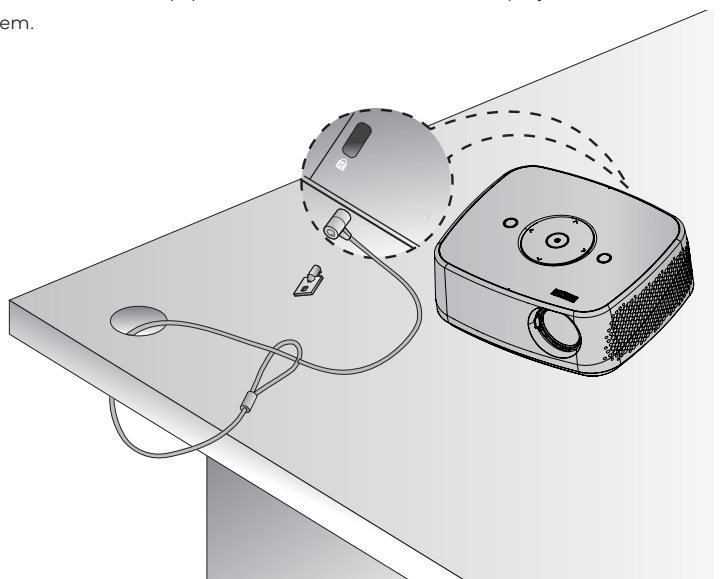

Turning on the Projector

1. Make sure the power cord is connected correctly.
2. Press the **POWER** button on the top cover or the **POWER** button on the remote control. (The light on the control panel will be turned on.)
 - Press the **INPUT** button on the remote control to select the input signal you want.
 - When you press the **POWER** button on the remote control or the **POWER** button on the control panel when you turn on the projector, the lights for all buttons on the control panel will be turned on.
 - Check if the lens door is open before turning on the power.

Turning off the Projector

Press the **POWER** button on the top cover or the **POWER** button on the remote control.

Focus and Position of the Screen Image

When an image appears on the screen, check if it is in focus and fits the screen properly.

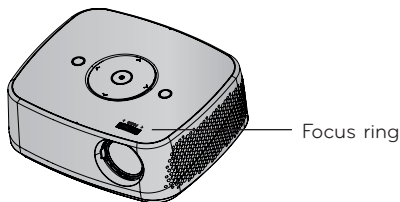

- To adjust the focus of the image, rotate the focus ring.

Selecting input mode

1. Press the **INPUT** button on the remote control.
2. Selecting an input signal with the **INPUT** button will only change the projector only to connected inputs. You can change it to any inputs with the **<**, **>** button.

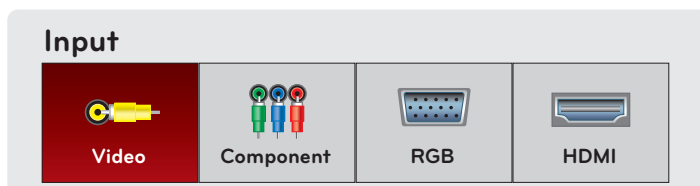

- The component input is always active, and it does not support plug &play function.

Connection

Connecting to a Desktop PC

- * You can connect the projector to a computer with VGA, SVGA, XGA, SXGA output.
- * Refer to page 41 for resolutions the projector supports.

< How to connect >

1. Connect the **RGB IN** of the projector and the computer output port with a computer cable.
2. Connect the **AUDIO IN** of the projector and the computer audio output port with an audio cable.

* You may have to change the resolution that your PC exports to one supported by the projector. (Refer to page 41.) This projector may not support output from laptops when the laptop screen is on.

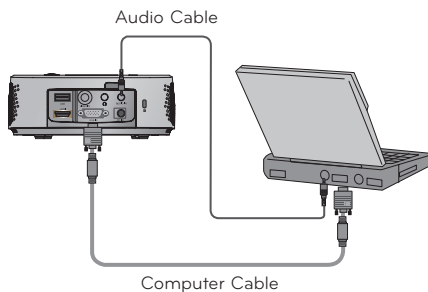
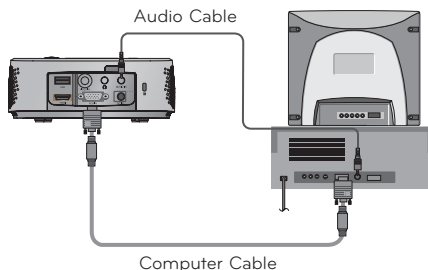

Connecting to a Video Source

* You can connect a VCR, a camcorder or any other compatible video image source to the projector.

< How to connect >

1. Connect the **VIDEO IN** of the projector to the output jack of the video source with a video cable.
2. Connect the **AUDIO IN** of the projector to the output jack of the audio source with an audio cable.

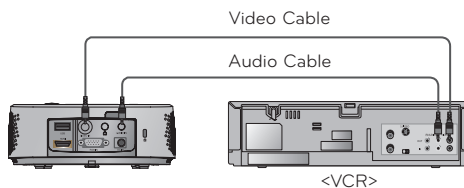

Connecting to a DVD Player

* Depending on the equipment, the component output jacks (Y, Pb, Pr) of the DVD Player may be labeled as Y, Pb, Pr/Y, B-Y, R-Y/Y, Cb, Cr.

< How to connect a HDMI source >

1. Connect the **HDMI** of the projector and the HDMI output port of the DVD Player with an HDMI cable.
2. Set the DVD Player's resolution to one of the following: 480p(576p)/720p/1080i/1080p mode.

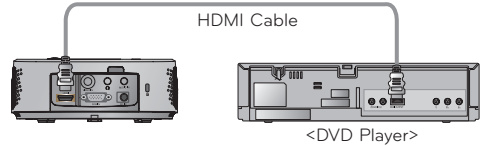

< How to connect a Component source >

1. After connecting the Component cable of DVD Player to the RGB to Component cable, connect it to the **RGB IN** terminal of the projector.
 - * When connecting the component cable, match the jack colors with the component cable.(Y=green, PB=blue, PR=red)
2. Connect the **AUDIO IN** of the projector to the output jacks of the audio source with an audio cable.

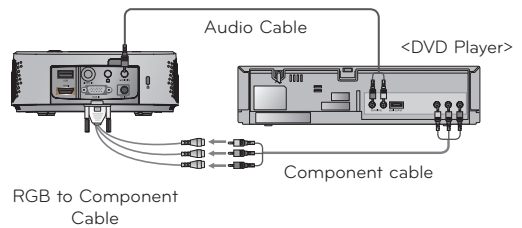

Connecting to a D-TV Set-Top Box

* To receive Digital TV (D-TV) programs, it is necessary to purchase a D-TV receiver (Set-Top Box) and connect it to the projector.
 * Please refer to the owner's manual of the D-TV Set-Top Box for the connection between the projector and D-TV Set-Top Box.

< How to connect a HDMI source >

1. Connect the **HDMI** of the projector and the HDMI output port of the DTV set-top box with an HDMI cable.
2. Set the DTV receiver's resolution to one of the following: 480p(576p)/720p/1080i/1080p mode.

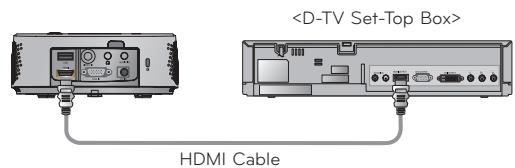

< How to connect a Component source >

1. Connect the D-TV Set-Top Box Component cable with RGB to Component cable and then connect it to **RGB IN** of the projector.
 - * When connecting the component cable, match the jack colors with the component cable.(Y=green, PB=blue, PR=red)
2. Connect the **AUDIO IN** of the projector to the output jacks of the audio source with an audio cable.

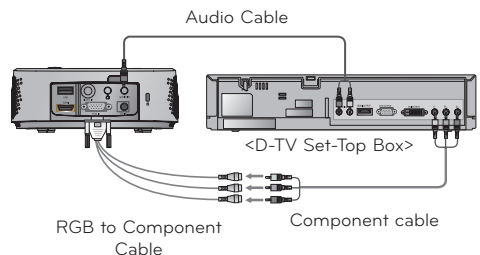

Function

* The On-Screen Display (OSD) in this manual may be slightly different from your projector.

* This operating guide explains operation of RGB(PC) mode mainly.

PICTURE Menu Options

Picture mode

* Use the Picture mode function to set the projector for the best picture appearance.

1. Press the **Q.MENU** button on the remote control.
2. Press the **<**, **>** buttons to move to **Picture mode**.
3. Press the **^**, **v** button to toggle through the preset picture settings.



- You can use this function through the **MENU** button.
- Press the **BACK** button to exit the menu screen.

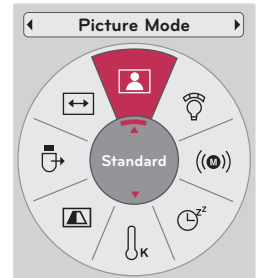

Adjusting Picture Mode

1. Press the **MENU** button. Then, move to **PICTURE** with the **^**, **v**, **<**, **>** buttons and press the **OK** button.
2. Press the **^**, **v** buttons to move to a desired function and press the **OK** button.
3. Press the **<**, **>** buttons to make a desired adjustment and then press the **OK** button.

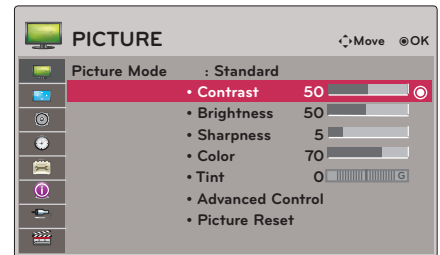

- You can set image values differently for each input and **Picture Mode**.
- Saving after making adjustments will display **(User)** in adjusted **Picture Mode**. (except **Expert 1/2**)
- Execute **Picture Reset** for **Picture Mode** to restore back to default factory settings.
- Press the **BACK** button to exit the menu screen.

Advanced Control Function

1. Press the **MENU** button. Then, move to **PICTURE** with the \wedge , \vee , \leftarrow , \rightarrow buttons and press the **OK** button.
2. Press the \wedge , \vee buttons to move to **Advanced Control** and press the **OK** button.
3. Move to a desired item with the \wedge , \vee buttons.
4. Press the \leftarrow , \rightarrow buttons to make a desired adjustment and then press the **OK** button.

- You can set image values differently for each input and **Picture Mode**.
- Execute **Picture Reset** for **Picture Mode** to restore back to default factory settings.
- Press the **BACK** button to exit the menu screen.

< When **Picture Mode** is **Vivid/Standard/Cinema/Sport/ Game** >

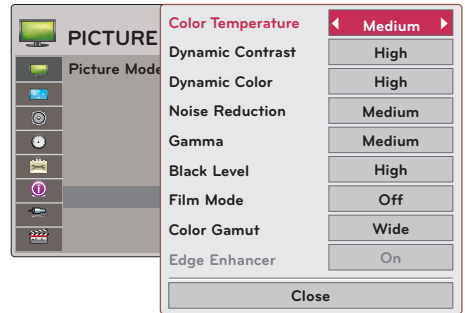

< When **Picture Mode** is **Expert 1/2** >

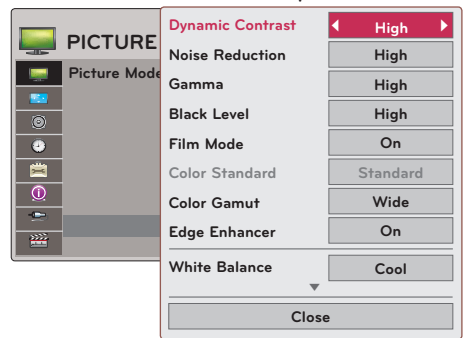

Color Temperature	- This function enables Vivid/Standard/Cinema/Sport/Game . • Set to warm to enhance hotter colors such as red, or set to cool to make picture bluish.
Dynamic Contrast	• Adjusts the contrast to keep it at the best level according to the brightness of the screen. The picture is improved by making bright parts brighter and dark parts darker.
Dynamic Color	- This function enables Vivid/Standard/Cinema/Sport/Game . • Adjusts screen colors so that they look livelier, richer and clearer. This feature enhances hue, saturation and luminance so that red, blue, green and white look more vivid.
Noise Reduction	• Reduces screen noise without compromising video quality.
Gamma	Low : Make dark and middle gray level area of the picture brighter. Medium : Express original picture levels. High : Make dark and middle gray level area of the picture darker. • You can adjust brightness of dark area and middle gray level area of the picture.
Black Level	Low : The reflection of the screen gets darker. High : The reflection of the screen gets brighter. • Set black level of the screen to proper level. • This feather is disables in RGB mode.
Film Mode	• Makes video clips recorded in film look more natural by eliminating judger effect. • DVD and Blu-ray movies are filmed at 24 frames per second.
Color Gamut	Standard : Displays standard color area. Wide : Mode to use and set the rich color area of the display. • Maximize the utilization of color to increase color quality.
Edge Enhancer	• Show clearer and distinctive yet natural corners of the video.
Color Standard	• Convert the color of a different video to HD color.

White Balance	<ul style="list-style-type: none"> - This function enables Expert 1/2. • This is the function to adjust the overall color of the screen to the feeling you want. <ol style="list-style-type: none"> a. Method : 2 Points <ul style="list-style-type: none"> - Pattern: Inner, Outer - Red/Green/Blue Contrast, Red/Green/Blue Brightness: The adjustment range is -50 ~ +50. b. Method : 20 Points IRE <ul style="list-style-type: none"> - Pattern: Inner, Outer - IRE (Institute of Radio Engineers) is the unit to display the size of the video signal and can be set among 5, 10, 15 - 95, 100. You can adjust Red, Green or Blue according to each setting. - Red/Green/Blue: The adjustment range is -50 - +50.
Color Management System	<ul style="list-style-type: none"> - This function enables Expert 1/2. • As the tool used by the experts to make adjustments by using the test patterns, this does not affect other colors but can be used to selectively adjust the 6 color areas (Red/Green/Blue/Cyan/Mgt/Yellow). <p>Color difference may not be distinctive even when you make the adjustments for the general video.</p> <p>Adjusts Red/Green/Blue/Yellow/Cyan, Magenta.</p> <ul style="list-style-type: none"> - Red/Green/Blue/Yellow/Cyan, Magenta Color: The adjustment range is -30 ~ +30. - Red/Green/Blue/Yellow/Cyan, Magenta Tint: The adjustment range is -30 ~ +30. - This feature is disable in PC mode.

Color Temperature Function

1. Press the **Q.MENU** button on the remote control.
2. Press the **<, >** buttons to move to **Color Temperature**.
3. Press the **^, v** button to toggle through the preset picture settings.

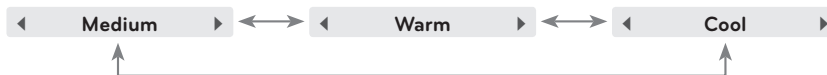

- This function enables **Vivid/Standard/Cinema/Sport/Game**.
- You can use this function through the **MENU** button.
- Press the **BACK** button to exit the menu screen.

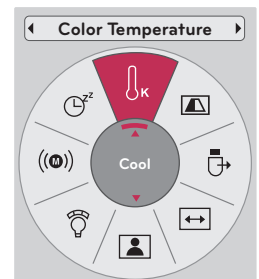

Picture Reset Function

* Settings of the selected **PICTURE** function for each input and **Picture Mode** return to the default factory settings.

1. Press the **MENU** button. Then, move to **PICTURE** with the **^, v, <, >** buttons and press the **OK** button.
2. Press the **^, v** buttons to move to **Picture Reset** and press the **OK** button.
3. Press the **<, >** buttons to move to **Yes** and press the **OK** button.

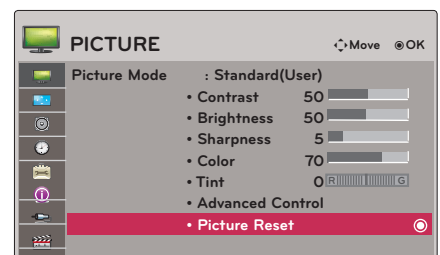

- Press the **BACK** button to exit the menu screen.

SCREEN Menu Options

To Change PJT Mode

* This function turns the projected image upside down or flips horizontal.

1. Press the **Q.MENU** button on the remote control.
2. Press the **<**, **>** buttons to move to **PJT Mode**.
3. Press the **^**, **v** button to select a desired item.
 - Select **Rear** when projecting from the back of the transparent screen purchased separately.
 - Select **Ceiling** when installing the product on the ceiling.
 - When **PJT Mode** is **Rear/Ceiling**, the left/right of the speaker changes automatically.
 - You can use this function through the **MENU** button.
 - Press the **BACK** button to exit the menu screen.

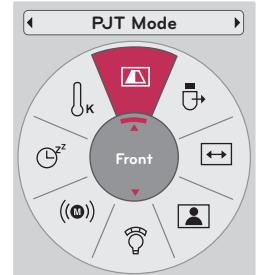

Using Aspect Ratio Function

Press the **RATIO** button to select a desired screen size.

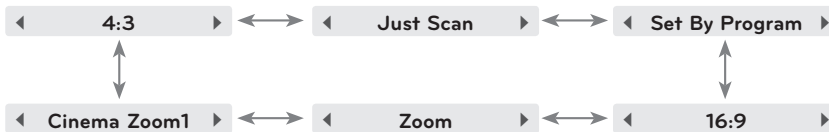

- Some options may not be available depending on input signals.
- You can use this function through the **MENU** button.
- Press the **BACK** button to exit the menu screen.

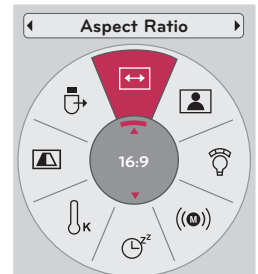

Using Keystone Function

* Use this function when the screen is not at a right angle to the projector and the image is a trapezoid shape.

* Only use the **Keystone** function when you can't get the best angle of projection.

1. Press the **KEY.S▲**, **KEY.S▼** button of remote control.
2. Press the **KEY.S▲**, **KEY.S▼** button to adjust the screen condition as you want.

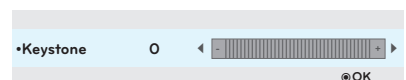

- **Keystone** can be adjusted from **-40** to **40**.
- You can use this function through the **MENU** button.
- Press the **BACK** button to exit the menu screen.

Auto Configure Function

* This function assures you of getting the best video quality by automatically adjusting the horizontal size and synchronization of the image.

* Auto Tracking function works in RGB PC input only.

Press the **AUTO** button of the remote control.

- If you execute screen adjustment for a video from PC graphic signal, optimal state may not be found. Execute the **Auto Config.** function for a still image.
- You can use this function through the **MENU** button.



RGB Config. Function

1. Press the **MENU** button. Then, move to **SCREEN** with the \wedge , \vee , $<$, $>$ buttons and press the **OK** button.
2. Press the \wedge , \vee buttons to move to **RGB Config.** and press the **OK** button.
3. Move to a desired item with the \wedge , \vee buttons and then press the $>$ button.
4. Press the \wedge , \vee , $<$, $>$ button to adjust the screen condition as you want and then press the **OK** button.

- **Resolution** can be chosen between 768 resolution (1024x768/1280x768/1360x768, 60Hz).
- Press the **BACK** button to exit the menu screen.

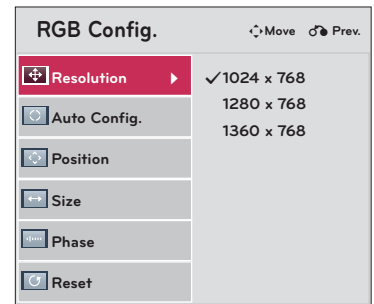

Using the Still Function

1. Press the **STILL** button on the remote control.
* You can freeze the moving image.



< Moving Image >



< Still Image >

2. To exit STILL, press any button.

* The STILL function will release automatically after approximately 10 minutes.

AUDIO Menu Options

What is FM Wireless Audio? (HX300G only)

FM Wireless Audio is a function to send out audio signals from the projector using FM frequency (88.1 MHz - 107.9 MHz).

The frequency of Projector and FM receiver should be same in order to output the sound from FM receiver normally.

The signal can be received by using FM receiver within 3 m of distance.

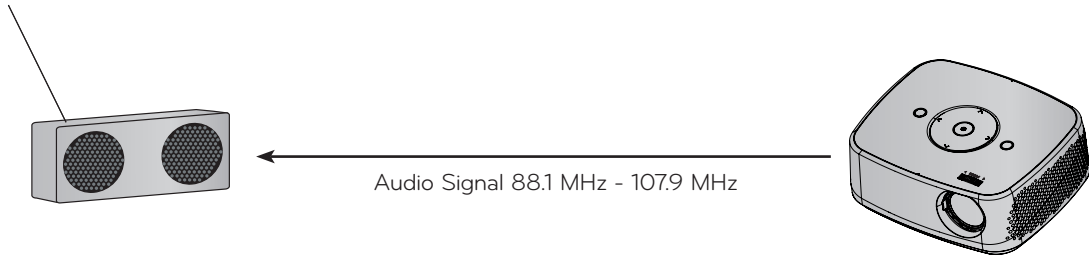

< The recommended use range of FM receiver >

Install projector and FM receiver without any obstacles as shown on the figure below.

A FM receiver can be reached 5 m when the antenna length and direction are good.

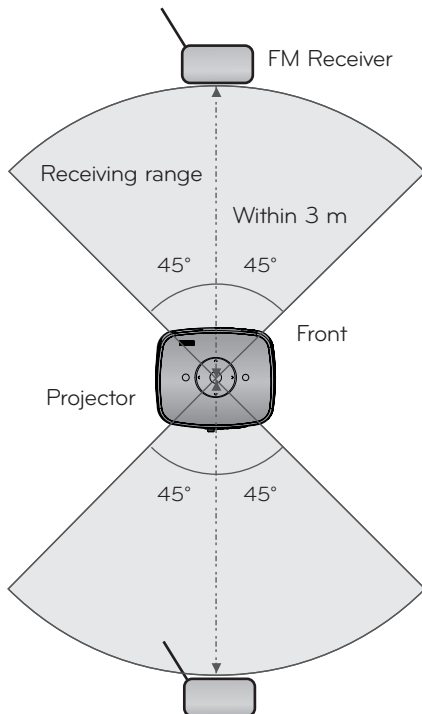

< The recommended length of FM receiver Antenna >

We recommend to use a rod antenna 0.8 m - 1.5 m for better sound quality since audio noise can be detected when using under 0.8 m rod antenna.

Installing Instructions (HX300G only)

- If used in a medical institution, it may cause an error for medical equipments. Please do not use in a medical establishment.
- Please maintain the distance between the projector and FM receiver within 3 m.
- The sound from FM receiver may not come out in the desired quality if the distance is more than 3 m.
- Please adjust the location of FM receiver and its antenna and install them to where it shows a good condition of receiving reception.
- According to the installed location and environment, the receiving distance may become shorter and the sound may be interrupted due to:
 - If an obstacle is located near the projector and FM receiver.
 - If an obstacle passes near by the projector and FM receiver.
 - If the FM receiver is installed Left, Right, or diagonal line of projector
 - If the Projector or the FM receiver is located inside of a rack made of metal.
 - If other FM transmitter equipment is working near at the same frequency.
 - If there is a radio broadcast on air at the same frequency.
 - If working in the dusty, humid, or high temperature environment.

What do I do if the FM receiving signal is not good? (HX300G only)

- Please adjust the antenna of FM receiver or move the location of FM receiver.
- If there is no Audio signal or low reception, within 55 seconds the FM Wireless Audio function will shut down automatically.
- Please check the incoming audio signal.
- Please check if the power of projector or FM receiver is on.
- Please check if there is any obstacle between the projector and FM receiver.
- Please check if there is any metallic hardware or electronic product nearby.
- Please check if there is any radio broadcasting channel using the same frequency.
- If there is a radio broadcasting channel using the same frequency, please change to a different frequency on the projector.
- Please move the location of adaptor or cables which are connected to projector. Adaptor or cables may affect the receiving reception.

To listen through the FM receiver speaker (HX300G only)

1. Press the **MENU** button. Then, move to **AUDIO** with the \wedge , \vee , \leftarrow , \rightarrow buttons and press the **OK** button.
2. Press the \wedge , \vee buttons to move to **FM Wireless Audio** and press the **OK** button.
3. Press the \wedge , \vee buttons to move to **On** and press the **OK** button.
4. Press the \wedge , \vee buttons to move to **Frequency** and press the **OK** button.
5. Press the \leftarrow , \rightarrow buttons to adjusting frequency and press the **OK** button.
6. Set the frequency of FM receiver to the frequency of the set projector.

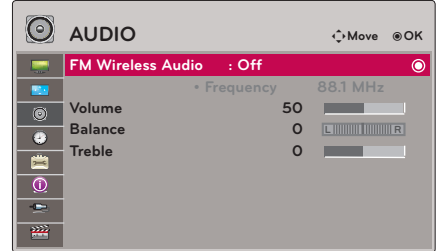

- Setting **FM Wireless Audio** as **On** disables **Mute/Volume/Balance/Treble** functions.
- There may be differences in the reception distance and the audio quality according to the type of FM receiver and installation locations.
- FM frequency can be set between 88.1 MHz - 107.9 MHz.
- If you don't use the FM receiver or audio signals from the projector, **Off** should be selected.
- When power is back on, it is changed to **Off** status.
- Press the **BACK** button to exit the menu screen.

Adjusting Volume

Press the **VOLUME** \wedge , \vee button on the remote control.

- If **FM Wireless Audio** is **On**, it does not function. Adjust with FM receiver.
- You can use this function through the **MENU** button.

Function Audio

1. Press the **Q.MENU** button on the remote control.
2. Press the \leftarrow , \rightarrow buttons to move to **Audio**.
3. Press the \wedge , \vee button to select a desired item.



- This function enables if connected a headphone.
- Press the **BACK** button to exit the menu screen.



Adjusting Speaker Balance

* Adjust the left/right sound of speaker to suit your taste and room situations.

1. Press the **MENU** button. Then, move to **AUDIO** with the \wedge , \vee , $<$, $>$ buttons and press the **OK** button.
2. Press the \wedge , \vee buttons to move to **Balance** and press the **OK** button.
3. Press the $<$, $>$ buttons to adjusting audio balance and press the **OK** button.

- If **FM Wireless Audio** is **On**, it does not function. Adjust with FM receiver.
- Press the **BACK** button to exit the menu screen.

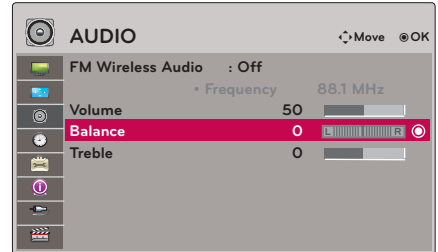

Adjusting Treble

* Adjust the treble your taste and room situations.

1. Press the **MENU** button. Then, move to **AUDIO** with the \wedge , \vee , $<$, $>$ buttons and press the **OK** button.
2. Press the \wedge , \vee buttons to move to **Treble** and press the **OK** button.
3. Press the $<$, $>$ buttons to adjusting audio treble and press the **OK** button.

- If **FM Wireless Audio** is **On**, it does not function. Adjust with FM receiver.
- Press the **BACK** button to exit the menu screen.

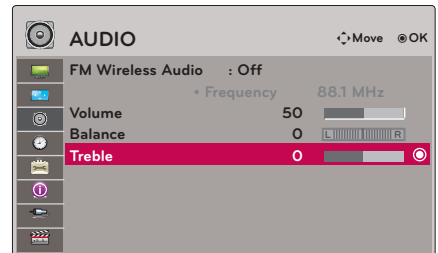

TIME Menu Options

Sleep time Function

* The sleep timer turns the projector off at the preset time.

1. Press the **Q.MENU** button on the remote control.
2. Press the **<**, **>** buttons to move to **Sleep Timer**.
3. Press the **^**, **v** buttons to select a desired preset time.

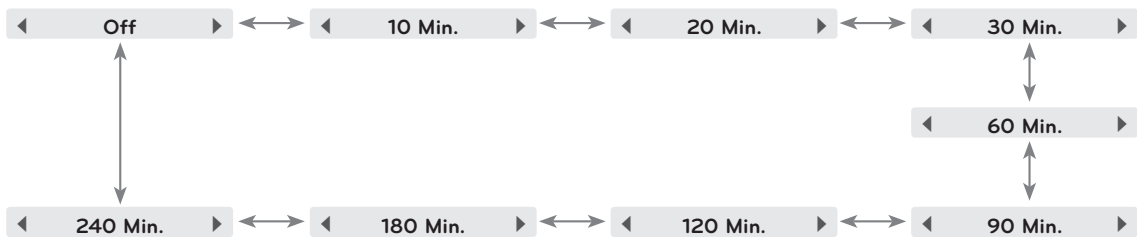

- You can use this function through the **MENU** button.
- Press the **BACK** button to exit the menu screen.

Auto Off Function

* This function turns the projector off automatically after the preset time is passed when there is no signal.

1. Press the **MENU** button. Then, move to **TIME** with the **^**, **v**, **<**, **>** buttons and press the **OK** button.
2. Press the **^**, **v** buttons to move to **Auto Off** and press the **OK** button.
3. Move to a desired item with the **^**, **v** buttons and then press the **OK** button.

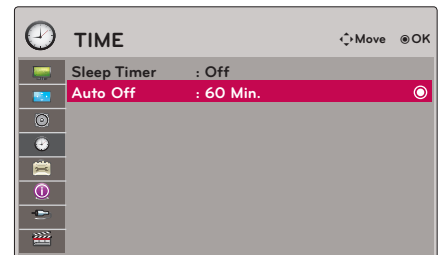

- Press the **BACK** button to exit the menu screen.

OPTION Menu Options

Selecting Language

1. Press the **MENU** button. Then, move to **OPTION** with the \wedge , \vee , $<$, $>$ buttons and press the **OK** button.
2. Press the \wedge , \vee buttons to move to **Menu Language** and press the **OK** button.
3. Move to a desired item with the \wedge , \vee , $<$, $>$ buttons and then press the **OK** button.
 - On-Screen-Display (OSD) is displayed in the selected language.
 - Press the **BACK** button to exit the menu screen.

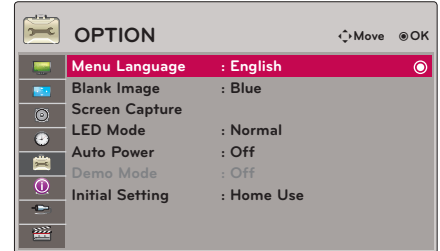

Using Blank Function

* This function may be effective if you need to get the attention of the audience during presentations, meetings or briefings.

1. Press the **BLANK** button on the remote control.
 - The screen turns off to a background color.
 - You can choose the background color. (Refer to 'Selecting Blank image')
2. Press any button to cancel the blank function.
 - To temporarily turn off the lamp, press **BLANK** on the remote control. Do not block the projection lens with any objects when the projector is under operation as this could cause the objects to become heated and deformed or even cause a fire.

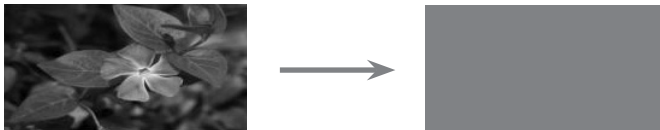

Selecting Blank image

1. Press the **MENU** button. Then, move to **OPTION** with the \wedge , \vee , $<$, $>$ buttons and press the **OK** button.
2. Press the \wedge , \vee buttons to move to **Blank Image** and press the **OK** button.
3. Move to a desired item with the \wedge , \vee buttons and then press the **OK** button.
 - Background image will be altered to the selected Blank function image.
 - If there is no Screen Captured, selecting **Captured Image** will display the Logo.
 - Press the **BACK** button to exit the menu screen.

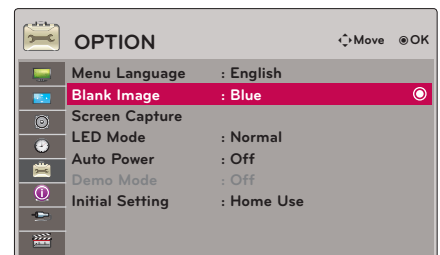

Screen Capture Function

1. Press the **MENU** button. Then, move to **OPTION** with the \wedge , \vee , $<$, $>$ buttons and press the **OK** button.
2. Press the \wedge , \vee buttons to move to **Screen Capture** and press the **OK** button.
 - It can only be elected when there is an input signal.
 - It takes up to 2 minutes when capturing screen.
 - Press the **BACK** button to exit the menu screen.

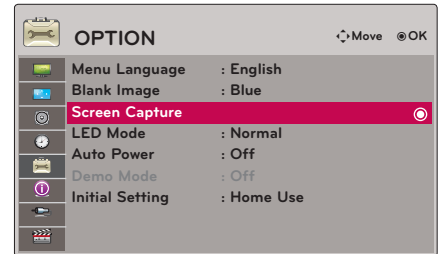

To adjust the brightness of the screen

1. Press the **Q.MENU** button on the remote control.
2. Press the $<$, $>$ buttons to move to **LED Mode**.
3. Move to a desired item with the $<$, $>$ buttons.
 - LED Mode changes into Dimming mode automatically at specific temperatures (37°C or higher). Dimming mode gets about 90% brightness of original led mode.
 - LED Mode changes into Dimming mode automatically if use a optical battery.
 - You can use this function through the **MENU** button.
 - Press the **BACK** button to exit the menu screen.

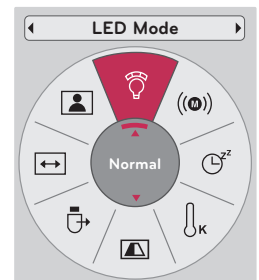

To make the power of the projector turn on automatically when power is in

1. Press the **MENU** button. Then, move to **OPTION** with the \wedge , \vee , $<$, $>$ buttons and press the **OK** button.
2. Press the \wedge , \vee buttons to move to **Auto Power** and press the **OK** button.
3. Press the \wedge , \vee buttons to move to **On** and press the **OK** button.

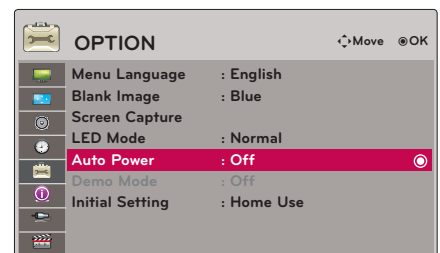

- **On**: Connecting DC cable to the projector turns on the projector.
- **Off**: Connecting DC cable to the projector makes the projector in standby state.
- Press the **BACK** button to exit the menu screen.

Demo Mode Function

1. Press the **MENU** button. Then, move to **OPTION** with the \wedge , \vee , $<$, $>$ buttons and press the **OK** button.
2. Press the \wedge , \vee buttons to move to **Demo Mode** and press the **OK** button.
3. Press the \wedge , \vee buttons to move to **On** and press the **OK** button.
 - It can be selected when **Initial Setting** is set as **Store Demo**.
 - Press the **BACK** button to exit the menu screen.

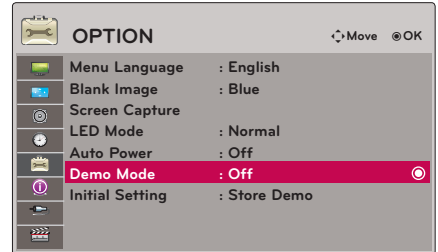

Initial Setting Function

1. Press the **MENU** button. Then, move to **OPTION** with the \wedge , \vee , $<$, $>$ buttons and press the **OK** button.
2. Press the \wedge , \vee buttons to move to **Initial Setting** and press the **OK** button.
3. Move to a desired item with the \wedge , \vee buttons and then press the **OK** button.
 - Set as **Home Use** when used in homes.
 - Press the **BACK** button to exit the menu screen.

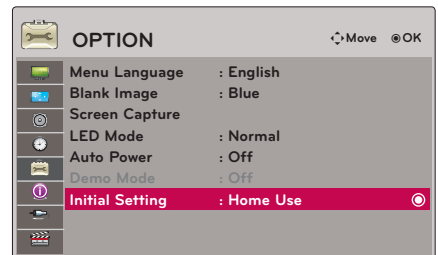

INFORMATION Menu Options

To See The Projector Information

1. Press the **MENU** button. Then, move to **INFORMATION** with the \wedge , \vee , $<$, $>$ buttons and press the **OK** button.
2. You can see the current information of the projector.
 - Press the **BACK** button to exit the menu screen.

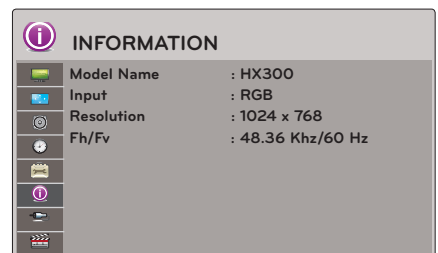

USB

* Image shown may differ from your projector.

To use the USB device

Connecting the USB device

* When you connect a USB device, this screen is displayed, automatically.
In USB device, you can not add a new folder or delete the existing folder.

1. Connect the USB device to the USB jack on the back of the set.
2. It turns automatically to DivX Home Menu.

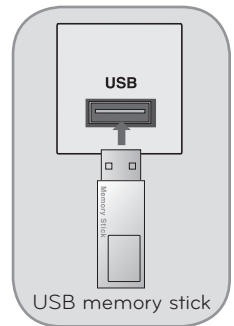
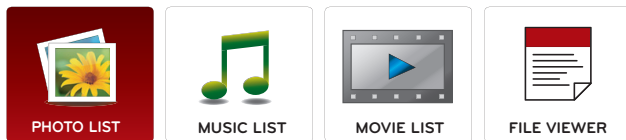

Eject USB

* Select "Eject" in order to eject a USB device.

1. Press the **Q.MENU** button on the remote control.
2. Press the **<**, **>** buttons to move to **USB Device**.
3. Press the **OK** button on the remote control.
 - After **Eject USB**, USB memory cannot be read. Remove USB memory, and connect again.
 - Press the **BACK** button to exit the menu screen.



Precautions when using the USB device

- ▶ Only a USB storage device is recognizable.
- ▶ If the USB storage device is connected through a USB hub, the device is not recognizable.
- ▶ A USB storage device using an automatic recognition programmed may not be recognized.
- ▶ A USB storage device which uses its own driver may not be recognized.
- ▶ The recognition speed of a USB storage device may depend on each device.
- ▶ Please do not turn off the projector or unplug the USB device when the connected USB storage device is working. When such device is suddenly separated or unplugged, the stored files or the USB storage device may be damaged.
- ▶ Please do not connect the USB storage device which was artificially maneuvered on the PC. The device may cause the product to malfunction or fail to be played. Never forget to use only a USB storage device which has normal music files, image files, movie files or text files.
- ▶ Please use only a USB storage device which was formatted as a FAT16, FAT32 and NTFS file system provided with the Windows operating system. In case of a storage device formatted as a different utility programmed which is not supported by Windows, it may not be recognized.
- ▶ Please connect power to a USB storage device which requires an external power supply. If not, the device may not be recognized.
- ▶ Please connect a USB storage device with cable is offered by USB maker. If connected with cable is not offered by USB maker or an excessively long cable, the device may not be recognized.
- ▶ Some USB storage devices may not be supported or operated smoothly.
- ▶ If the name of a folder or file is too long, it will not be displayed or recognized.
- ▶ File alignment method of USB storage device is similar to Window XP and filename can recognize up to 100 English characters.
- ▶ Please backup the important file because a data of USB device may be damaged. Data management is consumer's responsibility and in consequence the manufactures does not cover the product bearing data damage.
- ▶ The recommended capacity is 1TB or less for a USB external hard disk and 32GB or less for USB memory. Any device with more than the recommended capacity may not work properly.
- ▶ Only the FAT32 file system supports the delete function.
- ▶ If the USB memory device does not work properly, disconnect and reconnect it.
- ▶ If a USB external hard disk with a "Energy Saving" function does not work, turn the hard disk off and on again to make it work properly.
- ▶ USB storage devices below USB 2.0 are supported as well. But they may not work properly in the movie list.
- ▶ If your USB memory device has multiple partitions, or if you use a USB multi-card reader, you can use up to 4 partitions or USB memory devices.
- ▶ How fast a USB memory device is detected differs from device to device.
- ▶ If the USB is connected in Standby Mode, specific hard disk will automatically be loaded when the projector is turned on.
- ▶ Some USB storage devices may not be supported or operated smoothly.

PHOTO LIST

* It is available to playback the photo file(*.jpg) in the USB device.

The On Screen Display may be different from your set. Images are an example to assist with the projector operation.

PHOTO(*.JPEG) supporting file
 Baseline : 64 x 64 ~ 15360 x 8640
 Progressive : 64 x 64 ~ 1920 x 1440

- You can play JPEG files only.
- Non-supported files are displayed in the form of predefined icon.

Screen Components

1. Moves to upper level file
2. Preview: Display the thumbnail/folder name of the photo in the selected folder
3. Current page/Total pages
4. Total number of marked photos
5. Corresponding buttons on the remote control

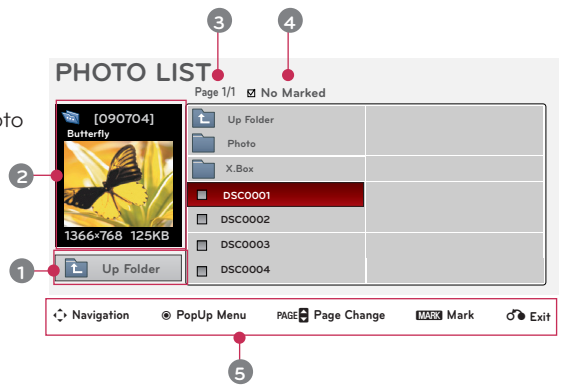
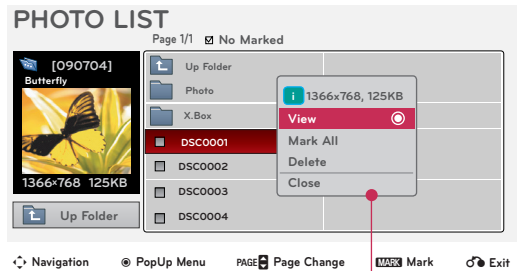

Photo Selection and Popup Menu

1. Press the **USB** button. Then, move to **PHOTO LIST** with the <, > buttons and press the **OK** button.
2. Press the ^, v, <, > buttons to move to a desired photo file and press the **OK** button.
3. Move to a desired item with the ^, v buttons and then press the **OK** button.



- **View:** Display the selected item.
- **Mark All:** Mark all photos on the screen.
- **Delete:** Delete the selected photo item.
- **Close:** Close the pop-up menu.

- If the picture file is damaged, it may not be displayed properly.
- High resolution pictures may take longer time to display on the entire screen.

Full Screen Menu

1. Press the **USB** button. Then, move to **PHOTO LIST** with the <, > buttons and press the **OK** button.
2. Press the ^, v, <, > buttons to move to desired photo and press the **OK** button.
3. Press the ^, v buttons to move to **View** and press the **OK** button.
4. The selected photo is displayed in full size and show up the menu.
5. Use ^, v, <, > button to select and control the menu on the full-sized screen.

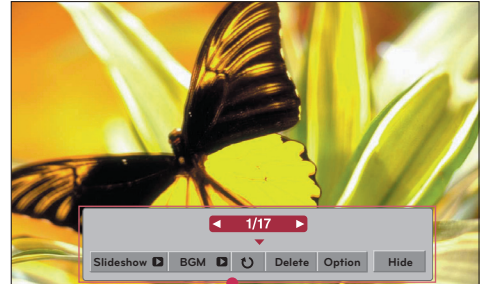

- Use <, > button to select the previous or next photo.
- **Slideshow**: Selected photos are displayed during the slide show. If no photo is selected, all photos in the current folder are displayed during slide show.
 - Set the time interval of the slide show in **Option**.
- **BGM**: Listen to music while viewing photos in full size.
 - Set the BGM device and album in **Option**.
- **Rotate**: Rotate photos.
- **Delete**: Delete photos.
- **Option**: Set values for **Slide Speed** and **Music Folder**.
 - You cannot change **Music Folder** while BGM is playing.
- **Hide**: Hide the menu on the full-sized screen.
 - To see the menu again on the full-sized screen, press **OK** button to display.

MUSIC LIST

* You can use the Music List menu to play MP3 files from a USB storage device.
The On Screen Display on your model may be slightly different.

MUSIC (*.MP3) supporting file
Bit rate range 32 Kbps ~ 320 Kbps

- Sampling rate MPEG1 Layer3 : 32kHz, 44.1kHz, 48kHz
- Sampling rate MPEG2 Layer3 : 16kHz, 22.05kHz, 24kHz
- Sampling rate MPEG2.5 Layer3 : 8kHz, 11.025kHz, 12kHz

Screen Components

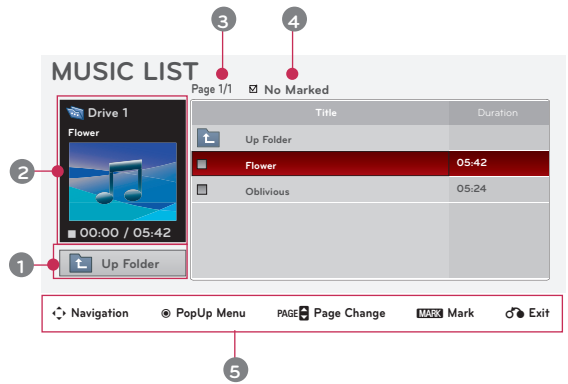

1. Moves to upper level file
2. Preview: Display the title/folder name of the music in the selected folder
3. Current page/Total pages
4. Total number of marked music
5. Corresponding buttons on the remote control

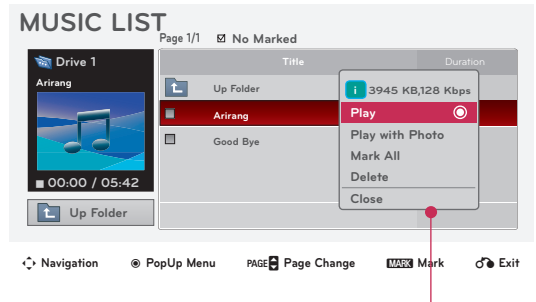

Music Selection and Popup Menu

1. Press the **USB** button. Then, move to **MUSIC LIST** with the <, > buttons and press the **OK** button.
2. Press the ^, v, <, > buttons to move to a desired music file and press the **OK** button.
3. Move to a desired item with the ^, v buttons and then press the **OK** button.



- **Play:** Once a song finishes playing, the next selected one will be played. When there are no selected music to play, the next one in the current folder will be played. If you go to a different folder and press the **OK** button, the current music in playback will stop. When music is playing,  is displayed in front of the music play time. After certain time elapsed, the full music list screen disappears and the playback information screen which is on the top of the music list runs as a screen saver. Press **OK**, , or **BACK** button to stop the screen saver. A damaged or corrupted music file that does not play displays 00:00 as the play time. Music files with copy-protection will not play.
- **Play with Photo:** Start playing the selected music and then move to the **PHOTO LIST**.
- **Mark All:** Mark all music in the folder.
- **Delete:** Delete the selected music.
- **Close:** Close the pop-up menu.

MOVIE LIST

* The movie list is activated once USB is detected. It is used when playing movie files on projector.

Supported Movie File

Extension name	Video Codec	Audio Codec	Max Resolution
mpg, mpeg, vob	MPEG1, MPEG2	Dolby Digital, MPEG, MP3, LPCM	1920x1080 @30p
dat	MPEG1	Dolby Digital, MPEG, MP3, LPCM	
ts, trp, tp	MPEG2, H.264/AVC	Dolby Digital, AAC, MPEG	
mp4	MPEG4 SP, MPEG4 ASP, Divx 3.11, Divx 4.12, Divx 5.x Divx 6, Xvid 1.00, Xvid 1.01, Xvid 1.02, Xvid 1.03 Xvid 1.10-beta 1, Xvid 1.10-beta 2, H.264/AVC	Dolby Digital, HEAAC, AAC, MPEG, MP3, LPCM	
avi	MPEG 2, MPEG 4 SP, MPEG4 ASP, Divx 3.11, Divx 4 Divx 5, Divx 6, Xvid 1.00, Xvid 1.01, Xvid 1.02, Xvid 1.03 Xvid 1.10-beta 1, Xvid 1.10-beta 2, H.264/AVC	Dolby Digital, HEAAC, AAC, MPEG, MP3, LPCM	
mkv	H.264/AVC, MPEG 1, MPEG 2, MPEG 4 SP, MPEG4 ASP	Dolby Digital, HEAAC, AAC, MPEG, MP3, LPCM	
divx	MPEG 2, MPEG 4 SP, MPEG4 ASP, Divx 3.11, Divx 4 Divx 5, Divx 6, Xvid 1.00, Xvid 1.01, Xvid 1.02, Xvid 1.03 Xvid 1.10-beta 1, Xvid 1.10-beta 2, H.264/AVC	Dolby Digital, HEAAC, AAC, MPEG, MP3, LPCM	

Bit rate range : within 32 kbps ~ 320 kbps (MP3)

Subtitle format : *.smi/*.srt/*.sub(MicroDVD, SubViewer1.0/2.0)/*.ass/*.ssa/*.txt(TMPlayer)/*.psb(PowerDivx)

Precautions when playing the DivX

- ▶ A DivX movie file and its subtitle file must be located in the same folder.
- ▶ At this time, a movie file name and its subtitle file name must be identical for it to be displayed.
- ▶ Specific subtitles created by the user may not be operated normally.
- ▶ Some special characters are not supported in subtitles.
- ▶ HTML tags are not supported in subtitles.
- ▶ Subtitles in languages other than the supported languages are not available.
- ▶ Time information in an external subtitle file should be arranged in ascending order to be played.
- ▶ Damaged movie files may not be played, and certain functions could be limited during the playback.
- ▶ Certain video files created with an encoder may not be played.
- ▶ If the video and audio structure of recorded file is not interleaved, either video or audio is outputted.
- ▶ Video with resolution higher than maximum resolution supported for each frame, cannot be guaranteed for smooth playback.
- ▶ DTS Audio codec is not supported.
- ▶ Playback for movie file exceeding 30 GB (Giga Byte) is not supported.
- ▶ Playing a video through a USB connection that doesn't support high speed may not work properly.
- ▶ When watching a video using MOVIE LIST, the function to adjust screen does not work.
- ▶ The screen may suffer temporary interruptions (image stoppage, faster playback, etc.) when the audio language is changed.
- ▶ Movie files other than the specified types and formats may not work properly.
- ▶ Max bitrate of playable movie file is 20Mbps.
- ▶ Files encoded with GMC(Global Motion Compensation) may not be played.
- ▶ When you are watching the movie by Movie List function, user setup for each image mode does not operate.
- ▶ Only the files saved in ASCII CODE is supported for the external subtitles of the movie.
- ▶ Only 500 alphabets and 500 numbers are supported for each line of the subtitle.
- ▶ Only 10000 of sync blocks can be supported within the subtitle file.



- ABOUT DIVX VIDEO: DivX® is a digital video format created by DivX, Inc. This is an official DivX Certified device that plays DivX video. Visit www.divx.com for more information and software tools to convert your files into DivX video.
- ABOUT DIVX VIDEO-ON-DEMAND: This DivX Certified® device must be registered in order to play DivX Video-on-Demand (VOD) content. To generate the registration code, locate the DivX VOD section in the device setup menu. Go to vod.divx.com with this code to complete the registration process and learn more about DivX VOD.
- "DivX Certified® to play DivX® video up to HD 1080p, including premium content"
- "Pat. 7,295,673; 7,460,688; 7,519,274"



Manufactured under license from Dolby Laboratories. "Dolby" and the double-D symbol are trademarks of Dolby Laboratories.

Screen Components

1. Moves to upper level folder
2. Preview: Display the title/folder name of the movie in the selected folder
3. Current page/Total pages
4. Total number of marked movies
5. Corresponding buttons on the remote control

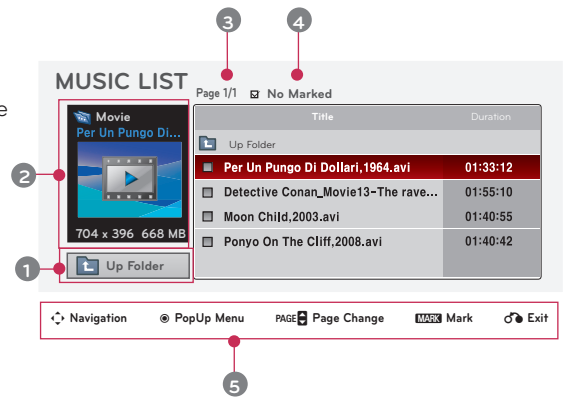

Movie Selection and Popup Menu

1. Press the **USB** button. Then, move to **MOVIE LIST** with the <, > buttons and press the **OK** button.
2. Press the \wedge , \vee , <, > move to a desired movie file and press the **OK** button.
3. Move to a desired item with the \wedge , \vee buttons and then press the **OK** button.

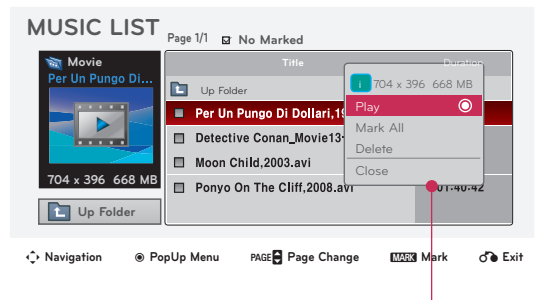

- **Play:** Play the selected movie titles.
 - In the case of files not supported, a message regarding non-supported file is displayed.

This file is invalid.
 - The screen is played, but when the audio file is not supported, the following message shows.

Unsupported Audio.
- **Mark All:** Mark all movies in the folder.
- **Delete:** Delete the selected movie.
- **Close:** Close the pop-up menu.

Playing the Movie

* You can adjust various method during the movie play.

1. Press the **USB** button. Then, move to **MOVIE LIST** with the **<**, **>** buttons and press the **OK** button.
2. Press the **^**, **v**, **<**, **>** move to a desired movie file and press the **OK** button.
3. Press the **^**, **v** buttons to move to **Play** and press the **OK** button.

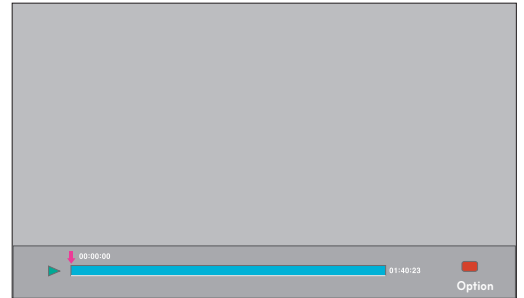

◆ Use of remote control

- Press the **▶|| (Play/Pause)** button to play/pause the screen.
- Press the **■ (Stop)** button to stop.
- Press the **◀◀ (Skip -)** button to play the previous movie.
- Press the **▶▶ (Skip +)** button to play the next movie.

Option Menu Selection

On **MOVIE LIST** play mode.

Press the **RED** (RED) button on the remote control.

- **Picture Size:** Select the **Full** or **Original** screen size.
- **Picture Mode:** Select the **Vivid**, **Standard**, **Cinema**, **Sport** or **Game**.
- **Audio Language:** Select Language Group of the audio during movie play.
- **Subtitle Language:** Select Language Group of the subtitle during movie play. Subtitle language option can be differ according to choice of the language for menu.
 - **Sync:** When the video is not synchronized with the caption, it can be adjusted by the unit of 0.5 second.
 - **Position:** Move the location of the subtitle.

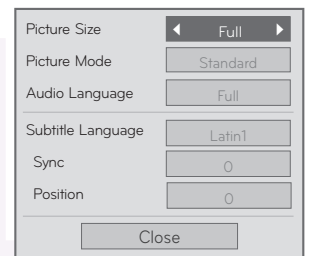

Subtitle Language Group	Supported Language
Latin1	French, Spanish, Catalan Basque, Portuguese, Italian, Albanian, Rhaeto-Romanic, Dutch, German, Danish, Swedish, Norwegian, Finnish, Faeroese, Icelandic, Irish, Scottish, English
Latin2	Czech, Hungarian, Polish, Romanian, Croatian, Slovak, Slovenian, Serbian
Latin4	Estonian, the Baltic languages Latvian(Lettish)and Lithuanian, Greenlandic and Lappish
Latin5	English, Turkish
Cyrillic	Bulgarian, Byelorussian, Macedonian, Russian, Serbian and pre-1990 (no ghe with upturn)Ukrainian
Greek	English, modern Greek
Hebrew	English, modern Hebrew
Chinese	Chinese
Korean	English, Korean
Arabic	English, Arabic

To See The DivX Registration Code

* Confirm the DivX registration code number of the projector.
Using the registration number, movies can be rented or purchased at www.divx.com/vod.

1. Press the **MENU** button. Then, move to **USB** with the \wedge , \vee , $<$, $>$ buttons and press the **OK** button.
2. Press the \wedge , \vee buttons to move to **DivX Reg. Code** and press the **OK** button.
3. You can see the DivX registration code of the projector.

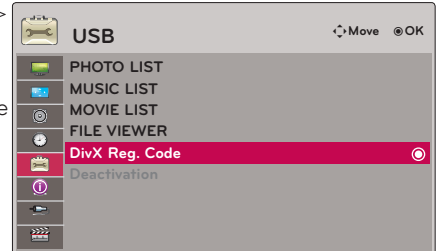

- With a DivX registration code from other projector, playback of rented or purchased DivX file is not allowed. (Only DivX files matched with the registration code of the purchased projector are playable.)
- The video or audio of a file converted based on a standard other than the DivX codec standard may be corrupted or unable to be played.
- Press the **BACK** button to exit the menu screen.

Deactivation Function

* Delete the existing authentication information to receive a new DivX user authentication for projector. Once this function is executed, a DivX user authentication is required again to see DivX DRM files.

1. Press the **MENU** button. Then, move to **USB** with the \wedge , \vee , $<$, $>$ buttons and press the **OK** button.
2. Press the \wedge , \vee buttons to move to **Deactivation** and press the **OK** button.
3. Move to a desired item with the $<$, $>$ buttons and then press the **OK** button.

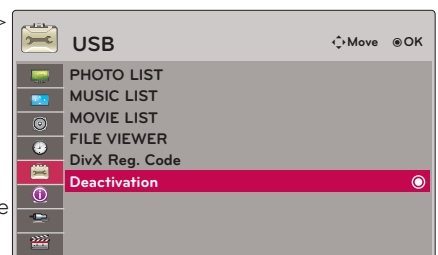

- DRM (Digital Rights Management) function:
These are the technology and the service that prevents the illegal use of digital contents to protect the copyrights owners' benefits and rights. File can be played after the license is cleared through the methods of online, etc.
- Press the **BACK** button to exit the menu screen.

FILE VIEWER

Supported File : XLS, DOC, PPT, TXT, XLSX, PPTX, DOCX, PDF

- Microsoft Office Version 97 / 2000 / 2002 / 2003 / 2007
- Adobe PDF Version 1.0 / 1.1 / 1.2 / 1.3 / 1.4
- File Viewer realigns the document, so it may look different from the PC.
- For the documents that include images, the resolution may look lower during the realigning process.
- If the document volume is big or it has many pages, the loading may take long time.
- For some fonts that are not supported, they may be replaced with other fonts.

Screen Components

1. Moves to upper level file
2. Preview: Display the title/folder name of the file in the selected folder
3. Current page/Total pages
4. Corresponding buttons on the remote control

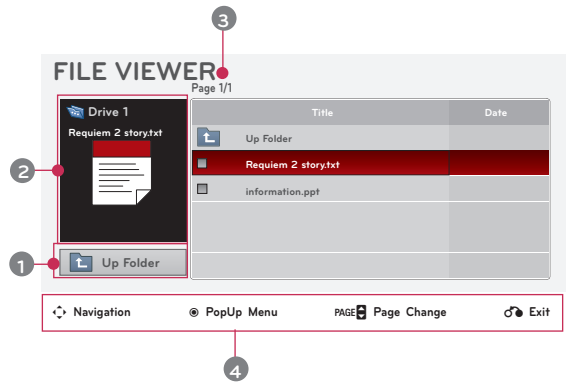

View File

1. Press the **USB** button. Then, move to **FILE VIEWER** with the <, > buttons and press the **OK** button.
2. Press the ^, v, <, > move to a desired file and press the **OK** button.

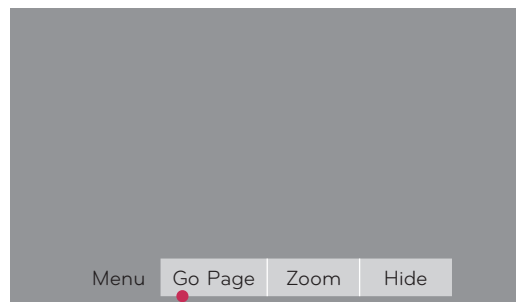

- Use Page ^, v button to move the previous or next page.
- **Go Page:** Move to a desired page.
 - 0 3 /14 page
 - 1. Move to **Go Page** with <, > buttons and press ^ button.
 - 2. Press the ^, v, <, > buttons select a desired page and press the **OK** button.
- **Zoom:** Zoom in or zoom out.
 - 100 % - + horizontal array vertical array OK
 - 1. Move to **Zoom** with <, > buttons and press ^ button.
 - 2. Press the <, > buttons select a desired page and press the **OK** button.
- **Hide:** Close the menu.
 - To see the menu again on the full-sized screen, press **MENU** button to display.

Information

Supported Monitor Display

* The following table lists the display formats supported by the projector.

Format	Vertical Freq.(Hz)	Horizontal Freq.(kHz)
640X350	70.090	31.468
720X400	70.080	31.469
640X480	59.940	31.469
640X480	72.800	37.861
640X480	75.000	37.500
800X600	56.250	35.156
800X600	60.310	37.879
800X600	72.180	48.077
800X600	75.000	46.875
1024X768	60.000	48.363
1024X768	70.060	56.476
1024X768	75.020	60.023
1152X864	60.053	54.348
1280X768	59.870	47.776
1360X768	60.015	47.712
1280X960	60.000	60.000
1280X1024	60.020	63.981
1400X1050	59.979	65.317
1680X1050	60.000	65.300

- * If the projector does not support the input signal, "Invalid Format" message appears on the screen.
- * The projector supports DDC1/2B type as Plug & Play function. (Auto recognition of PC monitor)
- * PC synchronization signal types supported :Separate type synchronization.
- * To get the the best picture quality, adjust the PC graphics card to 1024x768.

< DVD/DTV Input >

Signal	Component-*1	HDMI-*2
NTSC (60 Hz)	480i	○
	480p	○
	720p	○
	1080i	○
	1080p	○
PAL (50 Hz)	576i	○
	576p	○
	720p	○
	1080i	○
	1080p	○
24 / 30 Hz	1080p	○

- * Cable type
- 1- RGB to Component Cable
- 2- HDMI Cable

Maintenance

* The projector needs little maintenance. You should keep the lens clean because any dirt or stains may appear on the screen. If any parts need to be replaced, contact your dealer. When cleaning any part of the projector, always turn the power off and unplug the projector first.



Cleaning the lens

If there is any dust or stain on the surface of the lens, you must always clean the lens. Use an air spray or cleaning cloth for product exterior, provided with the product, to lightly clean the product. Please use a recommended air spray or lens cleaning product. To clean lens, small amount of cleaning agent on a swab or a soft cloth and rub on the lens. Please be aware that liquid may flow pass through the lens if the product is sprayed on lens directly.

Cleaning the Projector Case

To clean the projector case, first unplug the power cable. To remove dirt or dust, wipe the casing with polish cloth provided. When you want to remove the dust or stain on the lens, use the cloth for product exterior, provided with the product. Do not use alcohol, benzene, thinners or other chemical detergents as these can cause the casing to be warped or discolored.

Specifications

MODEL	HX300G (HX300G-JE) / HX301G (HX301G-JE)
Resolution	1024 (Horizontal) x 768 (Vertical) pixel
Horizontal / Vertical Ratio	4:3 (horizontal:vertical)
Panel size (mm)	13.97
Projection distance (Screen size)	0.55 m - 2.75 m (50.8 cm - 254.0 cm)
Projection Offset	110 %
Remote control distance	6 m
Video compatibility	NTSC/PAL/SECAM/NTSC4.43/PAL-M/PAL-N/PAL-60
AC-DC Adapter	LG, PA-1121-04, 19.5 V  , 6.15 A LG, SD-B191A, 19.5 V  , 5.64 A
Audio Output	1W + 1W
Height (mm)	57.5 (without foot), 61.0 (with foot)
Width (mm)	160
Length (mm)	135.5
Weight (g)	786
USB Device	5 V, 0.5 A (max)

Operating Condition

Temperature

In operation : 0°C - 40°C (presentation mode: 0°C - 37°C)
In storage and transit : -20°C - 60°C

Humidity

In operation : 0 % - 80% relative humidity
Not in operation : 0 % - 85% relative humidity

FM Transmitter Spec
(HX300G only)

Frequency Band : 88.1 MHz - 107.9 MHz
Channel Spacing : 200 KHz
Transmission Power : Under 50 nW

Open Source Software Notice

The following GPL executables and LGPL, MPL libraries used in this product are subject to the GPL2.0/LGPL2.1/MPL1.1 License Agreements:

GPL EXECUTABLES:

Linux kernel 2.6, busybox, lzo, u-boot

LGPL LIBRARIES:

uClibc

MPL LIBRARIES:

nanox

LG Electronics offers to provide source code to you on CD-ROM for a charge covering the cost of performing such distribution, such as the cost of media, shipping and handling upon e-mail request to LG Electronics at: opensource@lge.com

This offer is valid for a period of three (3) years from the date of the distribution of this product by LG Electronics.

You can obtain a copy of the GPL, LGPL and MPL licenses on the CD-ROM provided with this product.

Also you can obtain the translation of GPL, LGPL licenses from

<http://www.gnu.org/licenses/old-licenses/gpl-2.0-translations.html>,

<http://www.gnu.org/licenses/old-licenses/lgpl-2.1-translations.html>.

This product includes

- ▶ cmap: copyright © 1990-1998 Adobe Systems Incorporated.
- ▶ GIF LZW Decoder: copyright © 1987, by Steven A. Bennett
- ▶ md5: copyright © 1991-2, RSA Data Security, Inc
- ▶ jpeg: Independent JPEG Group, copyright © 1991 – 1998, Thomas G. Lane.
- ▶ libpng: copyright © 2004 Glenn Randers-Pehrson
- ▶ OSSP str - String Handling:
 - copyright © 1999-2005 Ralf S. Engelschall <rse@engelschall.com>
 - copyright © 1999-2005 The OSSP Project <http://www.ossproject.org/>
- ▶ random number generator : copyright © 1990, 1993 The Regents of the University of California.
- ▶ Standard C functions
 - copyright © 1998 Softweyr LLC.
 - copyright © 1988, 1993 The Regents of the University of California.
- ▶ tinxml: copyright © 2000-2006 Lee Thomason
- ▶ zlib: copyright © 1995-2002 Jean-loup Gailly and Mark Adler.

All rights reserved.

Permission is hereby granted, free of charge, to any person obtaining a copy of this software and associated documentation files (the "Software"), to deal in the Software without restriction, including without limitation the rights to use, copy, modify, merge, publish, distribute, sublicense, and/or sell copies of the Software, and to permit persons to whom the Software is furnished to do so, subject to the following conditions:

THE SOFTWARE IS PROVIDED "AS IS", WITHOUT WARRANTY OF ANY KIND, EXPRESS OR IMPLIED, INCLUDING BUT NOT LIMITED TO THE WARRANTIES OF MERCHANTABILITY, FITNESS FOR A PARTICULAR PURPOSE AND NONINFRINGEMENT. IN NO EVENT SHALL THE AUTHORS OR COPYRIGHT HOLDERS BE LIABLE FOR ANY CLAIM, DAMAGES OR OTHER LIABILITY, WHETHER IN AN ACTION OF CONTRACT, TORT OR OTHERWISE, ARISING FROM, OUT OF OR IN CONNECTION WITH THE SOFTWARE OR THE USE OR OTHER DEALINGS IN THE SOFTWARE.



The model and serial number of the projector is located on the back or one side of the projector. Record it below should you ever need service.

MODEL _____

SERIAL _____