



OWNER'S MANUAL

Network Blu-ray Disc™ / DVD Home Theater System

Please read this manual carefully before operating your set and retain it for future reference.

MODEL

HB994PK (HB994PK / SB94PK-L/S/D, W94-P)

P/NO : MFL65220852



CAUTION
RISK OF ELECTRIC SHOCK
DO NOT OPEN



CAUTION: TO REDUCE THE RISK OF ELECTRIC SHOCK DO NOT REMOVE COVER (OR BACK) NO USER-SERVICEABLE PARTS INSIDE REFER SERVICE TO QUALIFIED SERVICE PERSONNEL.



This lightning flash with arrowhead symbol within an equilateral triangle is intended to alert the user to the presence of uninsulated dangerous voltage within the product's enclosure that may be of sufficient magnitude to constitute a risk of electric shock to persons.



The exclamation point within an equilateral triangle is intended to alert the user to the presence of important operating and maintenance (servicing) instructions in the literature accompanying the product.

WARNING: TO PREVENT FIRE OR ELECTRIC SHOCK HAZARD, DO NOT EXPOSE THIS PRODUCT TO RAIN OR MOISTURE.

WARNING: Do not install this equipment in a confined space such as a book case or similar unit.

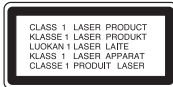

CAUTION: Do not block any ventilation openings. Install in accordance with the manufacturer's instructions.

Slots and openings in the cabinet are provided for ventilation and to ensure reliable operation of the product and to protect it from over heating. The openings shall be never be blocked by placing the product on a bed, sofa, rug or other similar surface. This product shall not be placed in a built-in installation such as a bookcase or rack unless proper ventilation is provided or the manufacturer's instruction has been adhered to.

CAUTION: This product employs a Laser System. To ensure proper use of this product, please read this owner's manual carefully and retain it for future reference. Shall the unit require maintenance, contact an authorized service center.

Use of controls, adjustments or the performance of procedures other than those specified herein may result in hazardous radiation exposure.

To prevent direct exposure to laser beam, do not try to open the enclosure. Visible laser radiation when open. **DO NOT STARE INTO BEAM.**

CAUTION: The apparatus shall not be exposed to water (dripping or splashing) and no objects filled with liquids, such as vases, shall be placed on the apparatus.

CAUTION concerning the Power Cord
Most appliances recommend they be placed upon a dedicated circuit;

That is, a single outlet circuit which powers only that appliance and has no additional outlets or branch circuits. Check the specification page of this owner's manual to be certain. Do not overload wall outlets. Overloaded wall outlets, loose or damaged wall outlets, extension cords, frayed power cords, or damaged or cracked wire insulation are dangerous. Any of these conditions could result in electric shock or fire. Periodically examine the cord of your appliance, and if its appearance indicates damage or deterioration, unplug it, discontinue use of the appliance, and have the cord replaced with an exact replacement part by an authorized service center. Protect the power cord from physical or mechanical abuse, such as being twisted, kinked, pinched, closed in a door, or walked upon. Pay particular attention to plugs, wall outlets, and the point where the cord exits the appliance. To disconnect power from the mains, pull out the mains cord plug. When installing the product, ensure that the plug is easily accessible.

This device is equipped with a portable battery or accumulator.

Safety way to remove the battery or the battery from the equipment:

Remove the old battery or battery pack, follow the steps in reverse order than the assembly.

To prevent contamination of the environment and bring on possible threat to human and animal health, the old battery or the battery put it in the appropriate container at designated collection points. Do not dispose of batteries or battery together with other waste.

It is recommended that you use local, free reimbursement systems batteries and accumulators.

This Class B digital apparatus complies with Canadian ICES-003, Issue 4, and RSS-210, No. 4 (Dec. 2000) and No. 5 (Nov. 2001). "To prevent radio interference to the licensed service, this device is intended to be operated indoors and away from windows to provide maximum shielding. Equipment (or its transmit antenna) that is installed outdoors is subject to licensing."

Operation is subject to the following two conditions :

- (1) This device may not cause Interference, and
- (2) this device must accept any interference, including interference that may cause undesired operation of the device.

Notes on Copyrights

- Because AACS (Advanced Access Content System) is approved as content protection system for BD format, similar to use of CSS (Content Scramble System) for DVD format, certain restrictions are imposed on playback, analog signal output, etc., of AACS protected contents. The operation of this product and restrictions on this product may vary depending on your time of purchase as those restrictions may be adopted and/or changed by AACS after the production of this product. Furthermore, BD-ROM Mark and BD+ are additionally used as content protection systems for BD format, which imposes certain restrictions including playback restrictions for BD-ROM Mark and/or BD+ protected contents. To obtain additional information on AACS, BD-ROM Mark, BD+, or this product, please contact an authorized Customer Service Center.
- Many BD-ROM/DVD discs are encoded with copy protection. Because of this, you should only connect your player directly to your TV, not to a VCR. Connecting to a VCR results in a distorted picture from copy-protected discs.

- This product incorporates copyright protection technologies that are protected by certain U.S. patents and other intellectual property rights owned by Macrovision Corporation and other rights owners. Use of this copyright protection technology must be authorized by Macrovision Corporation and is intended for home and other limited viewing uses only, unless otherwise authorized by Macrovision Corporation. Reverse engineering or disassembly is prohibited.
- Under the U.S. Copyright laws and Copyright laws of other countries, unauthorized recording, use, display, distribution, or revision of television programs, videotapes, BD-ROM discs, DVDs, CDs and other materials may subject you to civil and/or criminal liability.

To use BD-Live functionality

You must attach an external USB device using the USB port (see page 27).



What is SIMPLINK?

Some functions of this unit are controlled by the TV's remote control when this unit and LG TV's with SIMPLINK are connected through HDMI connection.

- Controllable functions by LG TV's remote control; Play, Pause, Scan, Skip, Stop, Power Off, etc.
- Refer to the TV owner's manual for the details of SIMPLINK function.
- LG TV's with SIMPLINK function have the logo as shown above.

Notes:

- Depending on the disc type or playing status, some SIMPLINK operation may differ from your purpose or not work.
- If "SIMPLINK" function does not work, check that your HDMI cable supports by CEC (Consumer Electronics Control) for HDMI.
- If the sound is output from both the system's speakers and TV speaker or not output from both them during SIMPLINK operation, reset speaker setting of LG TV's SIMPLINK menu.

Licenses

Java and all Java-based trademarks and logos are trademarks or registered trademarks of Sun Microsystems, Inc. in the United States and other countries.

Manufactured under license from Dolby Laboratories. Dolby and the double-D symbol are trademarks of Dolby Laboratories.

Manufactured under license under U.S. Patent #'s: 5,451,942; 5,956,674; 5,974,380; 5,978,762; 6,226,616; 6,487,535; 7,392,195; 7,272,567; 7,333,929; 7,212,872 & other U.S. and worldwide patents issued & pending. DTS is a registered trademark and the DTS logos, Symbol, DTS-HD and DTS-HD Master Audio I Essential are trademarks of DTS, Inc. © 1996-2008 DTS, Inc. All Rights Reserved.

HDMI, the HDMI logo and High-Definition Multimedia Interface are trademarks or registered trademarks of HDMI licensing LLC.

“BD-LIVE” logo is trademark of Blu-ray Disc association.

“DVD Logo” is trademark of DVD Format/Logo Licensing Corporation.

“x.v.Colour” is a trademark of Sony Corporation.

“Blu-ray Disc” is a trademark.

“BONUSVIEW” is trademark of Blu-ray Disc Association.

This product is licensed under the AVC patent portfolio license and VC-1 patent portfolio license for the personal and non-commercial use of a consumer to (i) encode video in compliance with the AVC Standard and VC-1 Standard (“AVC/VC-1 Video”) and/or (ii) decode AVC/VC-1 Video that was encoded by a consumer engaged in a personal and non-commercial activity and/or was obtained from a video provider licensed to provide AVC/VC-1 Video. No license is granted or shall be implied for any other use. Additional information may be obtained from MPEG LA, LLC. See <http://www.mpegla.com>.

“AVCHD” and the AVCHD logo are trademarks of Panasonic and Sony Corporation.

YouTube is a trademark of Google Inc.

DLNA and DLNA CERTIFIED are trademarks and/or service marks of Digital Living Network Alliance.

WIFI CERTIFIED 802.11n based on Draft 2.0.

Draft 2.0 refers to the version of the not-yet-ratified IEEE 802.11n standard used in Wi-Fi Alliance as of June 2007.

The specifications of the 802.11n WLAN (wireless local area network) are draft specifications and not final. If the final specifications differ from the draft specification, it may affect the ability of this device to communicate with other 802.11n WLAN devices.

Important Safety Instructions

1. Read these instructions.
2. Keep these instructions.
3. Heed all warnings.
4. Follow all instructions.
5. Do not use this apparatus near water.
6. Clean only with dry cloth.
7. Do not block any ventilation openings. Install in accordance with the manufacturer's instructions.
8. Do not install near any heat sources such as radiators, heat registers, stoves, or other apparatus (including amplifiers) that produce heat.
9. Do not defeat the safety purpose of the polarized or grounding-type plug. A polarized plug has two blades with one wider than the other. A grounding type plug has two blades and a third grounding prong. The wide blade or the third prong are provided for your safety. If the provided plug does not fit into your outlet, consult an electrician for replacement of the obsolete outlet.
10. Protect the power cord from being walked on or pinched particularly at plugs, convenience receptacles, and the point where they exit from the apparatus.
11. Only use attachments/accessories specified by the manufacturer.
12. Use only with the cart, stand, tripod, bracket, or table specified by the manufacturer, or sold with the apparatus. When a cart is used, use caution when moving the cart/apparatus combination to avoid injury from tip-over.
13. Unplug this apparatus during lightning storms or when unused for long periods of time.
14. Refer all servicing to qualified service personnel. Servicing is required when the apparatus has been damaged in any way, such as power-supply cord or plug is damaged, liquid has been spilled or objects have fallen into the apparatus, the apparatus has been exposed to rain or moisture, does not operate normally, or has been dropped.



Contents

Introduction	7-10	Enjoying BD-LIVE™	39-40
Remote control	11	Playing a movie	40-41
Main Unit (Front View)	12	Listening to a music	42
Main Unit (Back View)	13	Viewing a photo	43-44
Assembling the Rear Speakers	14	Using My media features	45-48
Positioning the system	14	Playing YouTube videos	49-51
Connecting the system	15	Listening to the radio	52
Resetting the wireless link	15	Using HDMI IN jack	53
Connections to Your TV	16-17	Using DIGITAL AUDIO IN jacks	53
Resolution Setting	17-18	Reference	54
Connecting to your Home Network	19-23	Code numbers of controllable TVs	55
Network Software Update	24-25	Language Codes	56
Setting the sound mode	26	Area Codes	56
Adjust the speaker level settings	26	Troubleshooting	57-58
Using the late night function	26	Specifications	59
Using the mood lighting	26	IMPORTANT INFORMATION RELATING TO NETWORK SERVICES	60
Using USB devices	27	Open source software notice	61
Using the Home Menu	28		
Adjust the Setup settings	28-33		
Play a disc	34-37		
Displaying disc information	38		

Before connecting, operating or adjusting this product, please read this instruction booklet carefully and completely.

Introduction

To ensure proper use of this product, please read this owner's manual carefully and retain for future reference.

This manual provides information on the operation and maintenance of your player. Should the unit require service, contact an authorized service location.

About the Symbol Display

"" may appear on your TV display during operation and indicates that the function explained in this owner's manual is not available on that specific media.

Symbols Used in this Manual

Note:

Indicates special notes and operating features.

Tip:

Indicates tips and hints for making the task easier.

A section whose title has one of the following symbols are applicable only to the disc represented by the symbol.

ALL	All discs listed below
BD	BD-ROM disc
DVD	DVD-Video, DVD±R/RW in Video mode or VR mode and finalized
AVCHD	DVD±R/RW in AVCHD format
ACD	Audio CDs
MOVIE	Movie files contained in the USB/Disc
MOVIE-N	Movie files in the DLNA server
MUSIC	Music files contained in the USB/Disc
MUSIC-N	Music files in the DLNA server

Handling the Unit

When shipping the unit

Please save the original shipping carton and packing materials. If you need to ship the unit, for maximum protection, re-pack the unit as it was originally packed at the factory.

Keeping the exterior surfaces clean

- Do not use volatile liquids such as insecticide spray near the unit.
- Wiping with strong pressure may damage the surface.
- Do not leave rubber or plastic products in contact with the unit for a long period of time.

Cleaning the unit

To clean the player, use a soft, dry cloth. If the surfaces are extremely dirty, use a soft cloth lightly moistened with a mild detergent solution.

Do not use strong solvents such as alcohol, benzine, or thinner, as these might damage the surface of the unit.

Maintaining the Unit

The unit is a high-tech, precision device. If the optical pick-up lens and disc drive parts are dirty or worn, the picture quality could be diminished.

For details, please contact your nearest authorized service center.

Notes on Discs

Handling Discs

Do not touch the playback side of the disc. Hold the disc by the edges so that fingerprints do not get on the surface. Never stick paper or tape on the disc.

Storing Discs

After playing, store the disc in its case. Do not expose the disc to direct sunlight or sources of heat and never leave it in a parked car exposed to direct sunlight.

Cleaning Discs

Fingerprints and dust on the disc can cause poor picture quality and sound distortion. Before playing, clean the disc with a clean cloth. Wipe the disc from the center out.

Do not use strong solvents such as alcohol, benzine, thinner, commercially available cleaners, or anti-static spray intended for older vinyl records.

Playable Discs



Blu-ray Disc

- Discs such as movies that can be purchased or rented
 - BD-R/RE discs that contain Movie, Music or Photo files.
-



DVD-VIDEO (12 cm disc)

Discs such as movies that can be purchased or rented



DVD-R (12 cm disc)

- Video mode and finalized only
 - Supports the dual layer disc also
 - AVCHD format
 - DVD-R discs that contain Movie, Music or Photo files.
-



DVD-RW (12 cm disc)

- VR mode, Video mode and finalized only
 - AVCHD format
 - DVD-RW discs that contain Movie, Music or Photo files.
-



DVD+R (12 cm disc)

- Finalized disc only
 - Supports the dual layer disc also
 - AVCHD format
 - DVD+R discs that contain Movie, Music or Photo files.
-



DVD+RW (12 cm disc)

- Video mode and finalized only
 - AVCHD format
 - DVD+RW discs that contain Movie, Music or Photo files.
-



Audio CD (12 cm disc)

Audio CDs or CD-Rs/CD-RWs in audio CD format that can be purchased



CD-R/CD-RW (12 cm disc)

CD-R/CD-RW discs that contain audio titles, Movie, Music or Photo files.

Notes:

- Depending on the conditions of the recording equipment or the CD-R/RW (or DVD±R/RW) disc itself, some CD-R/RW (or DVD±R/RW) discs cannot be played on the unit.
- Do not attach any seal or label to either side (the labeled side or the recorded side) of a disc.
- Do not use irregularly shaped CDs (e.g., heart-shaped or octagonal). Doing so may result in malfunctions.
- Depending on the recording software & the finalization, some recorded discs (CD-R/RW or DVD±R/RW) may not be playable.
- DVD±R/RW and CD-R/RW discs recorded using a personal computer or a DVD or CD Recorder may not play if the disc is damaged or dirty, or if there is dirt or condensation on the player's lens.
- If you record a disc using a personal computer, even if it is recorded in a compatible format, there are cases in which it may not play because of the settings of the application software used to create the disc. (Check with the software publisher for more detailed information.)
- This player requires discs and recordings to meet certain technical standards in order to achieve optimal playback quality. Pre-recorded DVDs are automatically set to these standards. There are many different types of recordable disc formats (including CD-R containing MP3 or WMA files) and these require certain pre-existing conditions to ensure compatible playback.
- Customers should note that permission is required in order to download MP3 / WMA files and music from the Internet. Our company has no right to grant such permission. Permission should always be sought from the copyright owner.
- You have to set the disc format option to [Mastered] in order to make the discs compatible with the LG players when formatting rewritable discs. When setting the option to Live System, you cannot use it on LG player. (Mastered/Live File System : Disc format system for windows Vista)

BD-ROM Disc Features

BD-ROM Discs can store 25 GB (single layer) or 50 GB (dual layer) on a single sided disc - about 5 to 10 times the capacity of a DVD.

BD-ROM Discs also support the highest quality HD video available in the industry (up to 1920 x 1080) - Large capacity means no compromise on video quality. Furthermore, a BD-ROM disc has the same familiar size and look as DVD.

- The following BD-ROM disc features are disc dependent and will vary.
- Appearance and navigation of features will also vary from disc to disc.
- Not all discs will have the features described below.
- BD-ROM, Hybrid disc have both BD-ROM and DVD (or CD) layers on one side. On such discs, BD-ROM layer will be only played back in this player.

Video highlights

The BD-ROM format for movie distribution supports three highly advanced video codecs, including MPEG-2, MPEG4 AVC (H.264), and SMPTE VC1. HD video resolutions are also available:

- 1920 x 1080 HD
- 1280 x 720 HD

Graphic planes

Two individual, full HD resolution (1920x1080) graphic planes (layers) are available, on top of the HD video layer. One plane is assigned to video-related, frame accurate graphics (like subtitles), and the other plane is assigned to interactive graphic elements, such as buttons or menus. For both planes, various wipes, fades and scroll effects may be available.

For High-Definition Playback

To view high-definition contents from BD-ROM discs, an HDTV is required. Some discs may require HDMI OUT for viewing of high-definition contents. Ability to view high-definition contents in BD-ROM discs may be limited depending on the resolution of your TV.

Menu sounds

When you highlight or select a menu option, sounds can be heard such as button clicks or a voice-over explaining the highlighted menu choice.

Multi-page/PopUp Menus

With DVD-Video, playback is interrupted each time a new menu screen is accessed. Due to BD-ROM disc's ability to preload data from the disc without interrupting playback, a menu can consist of several pages.

You can browse through the menu pages or select different menu paths, while the audio and video remain playing in the background.

Interactivity

Certain BD-ROM Discs may contain animated menus and/or trivia games.

User Browsable Slideshows

With BD-ROM Discs, you can browse through various still pictures while the audio remains playing.

Subtitles

Depending on what is contained on the BD-ROM disc, you may be able to select different font styles, sizes and colours for some subtitles. Subtitles may also be animated, scrolled or faded in and out.

BD-J Interactive Capability

The BD-ROM format supports Java for interactive functions. "BD-J" offers content providers almost unlimited functionality when creating interactive BD-ROM titles.

BD-ROM Disc Compatibility

This player supports BD-ROM Profile 2.

- Discs supporting BD-Live (BD-ROM version 2 Profile 2) that allows interactive functions to be used when this unit is connected to the Internet in addition to the BONUSVIEW function.
- Discs supporting BONUSVIEW (BD-ROM version 2 Profile 1 version 1.1/Final Standard Profile) that allows Virtual packages or Picture-in-Picture functions to be used.

Regional Code

This unit has a regional code printed on the rear of the unit. This unit can play only BD-ROM or DVD discs labeled same as the rear of the unit or "ALL".

AVCHD (Advanced Video Codec High Definition)

- This player can playback AVCHD format discs. These discs are normally recorded and used in camcorders.
- The AVCHD format is a high definition digital video camera format.
- The MPEG-4 AVC/H.264 format is capable of compressing images at higher efficiency than that of the conventional image compressing format.
- Some AVCHD discs use the "x.v.Colour" format.
- This player can playback AVCHD discs using "x.v.Colour" format.
- "x.v.Colour" is a trademark of Sony Corporation.
- Some AVCHD format discs may not play, depending on the recording condition.
- AVCHD format discs need to be finalized.
- "x.v.Colour" offers a wider colour range than normal DVD camcorder discs.

Compatibility Notes

- Because BD-ROM is a new format, certain disc, digital connection and other compatibility issues are possible. If you experience compatibility problems, please contact an authorized Customer Service Center.
- Viewing high-definition content and up-converting standard DVD content may require a HDMI-capable input or HDCP-capable DVI input on your display device.
- Some BD-ROM and DVD discs may restrict the use of some operation commands or features.
- Dolby Digital EX, DTS-ES and DTS 96/24 are output as Dolby Digital 5.1 or DTS 5.1.
- You can use the USB device that is used to store some disc related information, including downloaded on-line content. The disc you are using will control how long this information is retained.

Certain System Requirements

For high definition video playback:

- High definition display that has HDMI input jacks.
- BD-ROM disc with high definition content.
- HDMI or HDCP capable DVI input on your display device is required for some content (as specified by disc authors).
- For up-conversion of standard definition DVD, a HDMI or HDCP capable DVI input on your display device is required for copy protected content.

Main Unit (Front View)

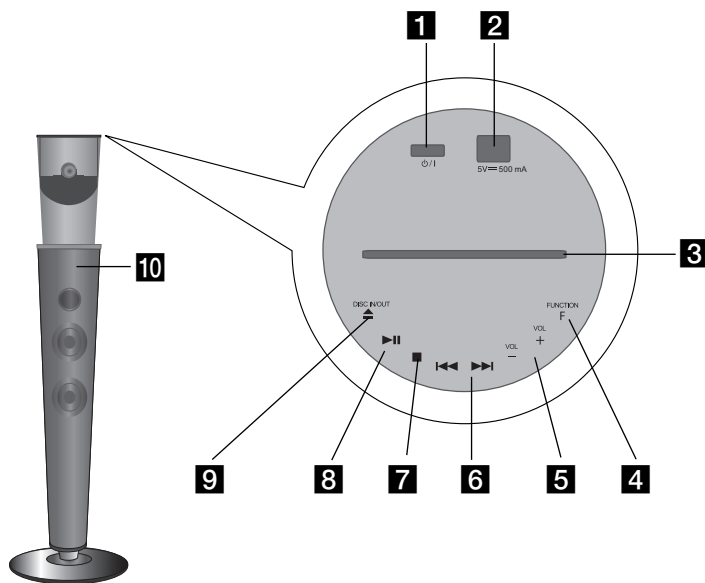

- 1** **⏻/⏻ Button**
Switches the unit ON or OFF.
- 2** **USB Port**
Connect a USB device.
- 3** **Disc Slot**
Insert a disc here.
- 4** **FUNCTION (F)**
Changes the input source (FM, OPTICAL, HDMI IN) or displays On-Screen Display.
- 5** **VOL (+/-)**
Adjusts speaker volume.
- 6** **I<< / >>I**
Go to next or previous file/track/chapter.
Searches backward or forward if you press and hold it.
- 7** **■**
Stops playback.
- 8** **▶/||**
Starts playback.
Pause playback temporarily,
press again to exit pause mode.
- 9** **▲ (DISC IN/OUT)**
Inserts or ejects a disc from the slot loader.
- 10** **Remote Sensor**
Point the remote control here.

Precautions in using the touch buttons

- Use the touch buttons with clean and dry hands.
 - In a humid environment, wipe out any moisture on the touch buttons before using.
- Do not press the touch buttons hard to make it work.
 - If you apply too much pressure, it can damage the sensor of the touch buttons.
- Touch the button that you want to work in order to operate the function correctly.
- Be careful not to have any conductive material such as metallic object on the touch buttons. It can cause malfunctions.

Main Unit (Back View)

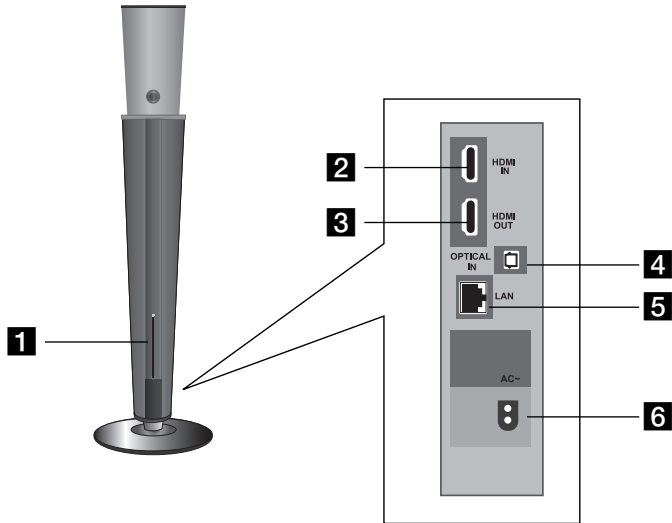

1 FM ANTENNA

2 HDMI IN (Type A)

Connect to an external source with HDMI outputs.

3 HDMI OUT (Type A)

Connect to TV with HDMI inputs. (Interface for digital audio and video)

4 OPTICAL IN

Connect to digital (optical) audio equipment.

5 LAN port

Connect a network with an always-on broadband connection.

6 AC IN Connector

Connect the supplied power cord.



Bottom of the floor base

Take up the slack in the cords by pulling from the bottom of the floor base and secure them by running through the cord retainer.

Assembling the Rear Speakers

Before connecting the rear speakers, assemble the rear speakers.

- 1 Fix the post to the rear speaker by rotating the post.



- 2 Fix the rear speaker to the floor base by rotating the post.

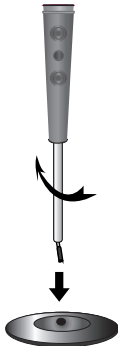

- 3 Connect the connector cable between the rear speaker and the floor base.

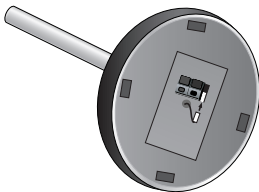

Positioning the System

The following illustration shows an example of positioning the system. Note that the illustrations in these instructions differ from the actual unit for explanation purposes.

For the best possible surround sound, all the speakers other than the subwoofer should be placed at the same distance from the listening position (A).

To prevent injury, install the speakers in a horizontal position only, as the speaker may fall down.

- (A) Wireless front left speaker/ (B) Wireless front right speaker: Place the front speakers to the sides of the monitor or screen and as flush with the screen surface as possible.
- (C) Rear left speaker/ (D) Rear right speaker: Place these speakers behind your listening position, facing slightly inwards. Connect the wireless receiver (E) and the rear speaker (right, left) with the speaker cables.
- (F) Wireless Subwoofer: The position of the subwoofer is not so critical, because low bass sounds are not highly directional. But it is better to place the subwoofer near the front speakers. Turn it slightly toward the center of the room to reduce the wall reflections.

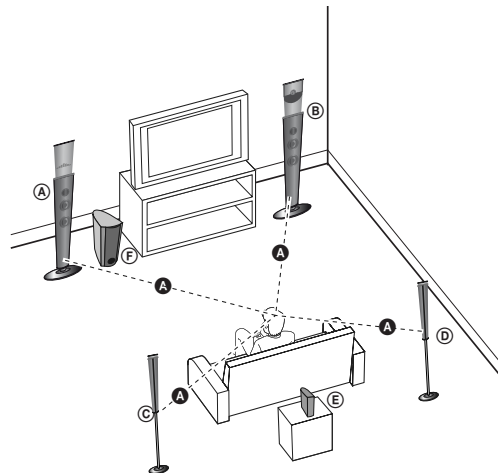

Connecting the System

1 Connect the rear speakers to the wireless receiver with the speaker cables.

Connect the black end of each wire to the terminal marked - (minus) and the other end to the terminal marked + (plus).

2 Connect the AC power cords.

- 1) Connect the AC power cords to the AC~ connector on the back of the wireless front left and right speakers.
Connect the other end to a wall outlet.
- 2) Connect the AC power cord to the AC connector on the bottom of the wireless subwoofer.
Connect the other end to a wall outlet.
- 3) Connect the AC power cord of the wireless receiver to a wall outlet.

3 Press (or)

- After the wireless light is flashing blue about a few seconds, the system will automatically establish a wireless link.
- When the wireless link is established, the wireless light of the wireless front left speaker is off and the wireless lights of the wireless subwoofer and the wireless receiver are solidly on blue.
- When the system is turned off, the wireless lights will turn red.

Resetting the wireless link

If an interference occurs or you replace any part of the system, the wireless link should be set again.

1 Disconnect the power cord from the wall outlet on the wireless front left speaker, the wireless subwoofer, and the wireless receiver.

2 Press and hold the button on the wireless front right speaker and the MUTE button on the remote control simultaneously.

- The unit will display "REMATE".

3 Reconnect the power cord to the wall outlet on the wireless front left speaker, the wireless subwoofer, and the wireless receiver.

Be careful of the following

- If there is a strong electromagnetic wave product nearby, interference may occur. Put the system away from there.
(Ex: Microwave oven)
- Be careful to make sure children do not put their hands or any objects into the *speaker duct.
*Speaker duct: A hole to allow for plentiful bass sound on speaker cabinet (enclosure).
- Set the distance of each system within 10m.
- Be sure to match the speaker cable to the appropriate terminal on the components: + to + and - to -. If the cables are reversed, the sound will be distorted and will lack bass.
- The speakers contain magnet parts, so color irregularity may occur on the TV screen or PC monitor screen. Please use the speakers away from the TV screen or PC monitor screen.

Connections to Your TV

Tip:

Please refer to the manuals of your TV or other devices as necessary to make the best connections.

Cautions:

- Make sure the player is connected directly to the TV. Tune the TV to the correct video input channel.
- Do not connect your player via your VCR. The image could be distorted by the copy protection system.

HDMI Connection

If you have a HDMI TV or monitor, you can connect it to this player using a HDMI cable.

Connect the HDMI OUT jack on the player to the HDMI IN jack on a HDMI compatible TV or monitor.

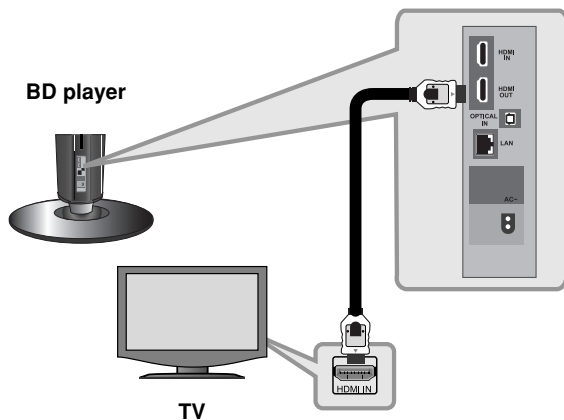

Set the TV's source to HDMI (refer to TV's Owner's manual).

Notes:

- You must select a HDMI audio output that your TV accepts using [HDMI Audio] options on the [Setup] menu (see page 31).
- If a connected HDMI device does not accept the audio output of the unit, the HDMI device's audio sound may be distorted or may not output.

Tips:

- You can fully enjoy digital audio and video signals together with this HDMI connection.
- When you use HDMI connection, you can change the resolution for the HDMI output. (Refer to "Resolution Setting" on page 17-18.)
- Select the type of video output from the HDMI OUT jack using [HDMI Color Setting] option on the [Setup] menu (see page 29).

Cautions:

- Changing the resolution when the connection has already been established may result in malfunctions. To solve the problem, turn off the player and then turn it on again.
- When the HDMI connection with HDCP is not verified, TV screen is changed to black or green screen or the snow noise may occur on the screen. In this case, check the the HDMI connection, or disconnect the HDMI cable.
- If there is noise or lines on the screen, please check the HDMI cable (length is generally limited to 4.5 m) and use a High Speed HDMI cable (Version 1.3).

Additional Information for HDMI

- When you connect a HDMI or DVI compatible device make sure of the following:
 - Try switching off the HDMI/DVI device and this player. Next, switch on the HDMI/DVI device and leave it for around 30 seconds, then switch on this player.
 - The connected device's video input is set correctly for this unit.
 - The connected device is compatible with 720x480p, 1280x720p, 1920x1080i or 1920x1080p video input.
- Not all HDCP-compatible HDMI or DVI devices will work with this player.
 - The picture will not be displayed properly with non-HDCP device.
 - This player does not playback and TV screen is changed to black or green screen or the snow noise may occur on the screen.

Resolution Setting

The player provides several output resolutions for HDMI OUT jack. You can change the resolution using [Setup] menu or pressing the RESOLUTION button in [Home Menu] and [Setup] Menu.

Note:

Since several factors affect the resolution of video output, see "Available resolution according to the resolution setting" on page 18.

How to change the resolution using RESOLUTION button

Press RESOLUTION repeatedly in [Home Menu] and [Setup] Menu to change the resolution. The display window will show you the current resolution.

How to change the resolution using the [Setup] menu

- 1** Press HOME and the [Home Menu] appears.
- 2** Select the [Setup] and press ENTER. The [Setup] menu appears.
- 3** Use \wedge/\vee to select [DISPLAY] option then press > to move to the second level.
- 4** Use \wedge/\vee to select the [Resolution] option then press > to move to the third level.
- 5** Use \wedge/\vee to select the desired resolution then press ENTER to confirm your selection.

Note:

If the video signal from the HDMI OUT jack is not output from the TV screen when [Resolution] is set to [Auto], change the video output resolution by pressing RESOLUTION button.

Available resolution according to the resolution setting

Resolution Setting	Video Output	HDMI OUT
	480i	480p
	480p	480p
	720p	720p
	1080i	1080i
	1080p / 24Hz	1080p / 24Hz
	1080p / 60Hz	1080p / 60Hz

Note:

Depending on your display, some of the resolution settings may result in the picture disappearing or an abnormal picture appearing. In this case, press HOME then RESOLUTION repeatedly until the picture re-appear.

HDMI OUT connection

- For the 480i resolution setting, real output resolution of HDMI OUT will change to 480p.
- If you select a resolution manually and then connect the HDMI jack to TV and your TV does not accept it, the resolution setting is set to [Auto].
- If you select a resolution that your TV does not accept, the warning message will appear. After resolution change, if you cannot see the screen, please wait 20 seconds and the resolution will automatically revert back to the previous resolution.
- The 1080p video output frame rate may be automatically set to either 24Hz or 60Hz depending both on the capability and preference of the connected TV and based on the native video frame rate of the content on the BD-ROM disc.

Connecting to your Home Network

This player can be connected to a local area network (LAN) via the LAN port on the rear panel or the internal wireless module.

By connecting the unit to a broadband home network, you have access to services such as software updates, My Media, BD-Live interactivity and streaming services.

Wired network connection

Using a wired network provides the best performance, because the attached devices connect directly to the network and are not subject to radio frequency interference.

Please refer to the documentation for your network device for further instructions.

Connect the player's LAN port to the corresponding port on your Modem or Router using a commercially available LAN or Ethernet cable (CAT5 or better with RJ45 connector).

In the example configuration for wired connection below, this player would be able to access content from either of the PCs.

Notes:

- When plugging or unplugging the LAN cable, hold the plug portion of the cable. When unplugging, do not pull on the LAN cable but unplug while pressing down on the lock.
- Do not connect a modular phone cable to the LAN port.
- Since there are various connection configurations, please follow the specifications of your telecommunication carrier or internet service provider.
- If you want to access content from PCs or DLNA servers, this player must be connected to the same local area network with them via a router.

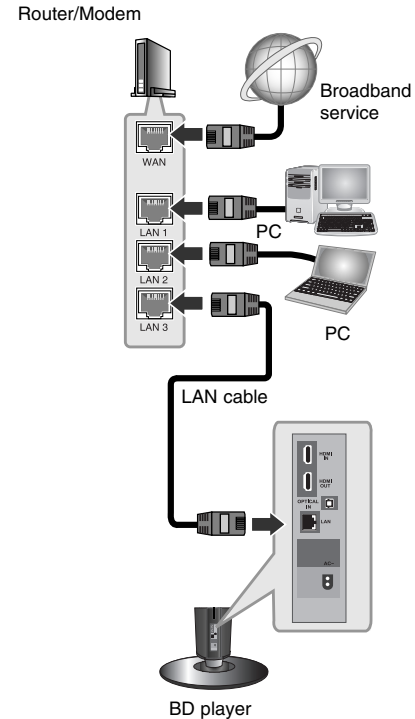

Wired Network Setup

If there is a DHCP server on the local area network (LAN) via wired connection, this player will automatically be allocated an IP address. After making the physical connection, a small number of home networks may require the player's network setting to be adjusted. Adjust the [NETWORK] setting as follows.

Preparation

Before setting the wired network, you need to connect the broadband internet to your home network.



1. Select the [Connection Setting] option in the [Setup] menu then press > or ENTER.



2. The [Connection Setting] menu appear on the screen. Use ^/v to select [Wired] and press ENTER.

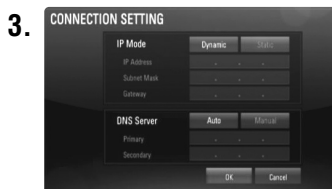

3. Use ^/v/</> to select the IP mode between [Dynamic] and [Static]. Normally, select [Dynamic] to allocate an IP address automatically.

Note:

If there is no DHCP server on the network and you want to set the IP address manually, select [Static] then set the [IP Address], [Subnet Mask], [Gateway] and [DNS Server] using ^/v/</> and numerical buttons. If you make a mistake while entering a number, press CLEAR to clear the highlighted part.

4. Select [OK] and press ENTER to apply network settings.

5. The player will ask you to test the network connection. Select [OK] and press ENTER to complete the network connection.



6. If you select [Test] and press ENTER at step 5 above, the network connection status is displayed on the screen. You can also test it on the [Connection Status] in the [Setup] menu.

Wireless network connection

Another connection option is to use an Access Points or an wireless router. In the example configuration for wireless connection below, this player would be able to access content from either of the PCs.

The network configuration and connection method may vary depending on the equipment in use and the network environment.

This player is equipped with an IEEE 802.11n wireless module, which also supports the 802.11b/g standards. For the best wireless performance, we recommend using a IEEE 802.11n certified Wi-Fi network (access point or wireless router).

Refer to the setup instructions supplied with your access point or wireless router for detailed connection steps and network settings.

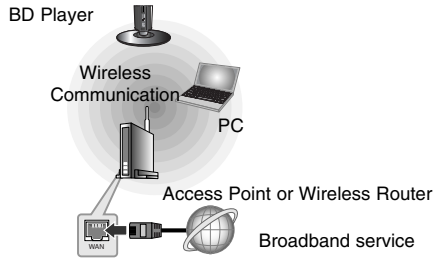

Note:

For best performance, a direct wired connection from this player to your home network's router or cable/DSL modem is always the best option. If the player is far away from your router or cable/DSL modem, Ethernet or LAN cables are available at many stores in lengths of 50 feet and longer. If you do chose to use the wireless option, note that performance can sometimes be affected by other electronic devices in the home.

Wireless network setup

For the wireless network connection, the player needs to be set up for network communication. This adjustment can be done from the [Setup] menu. Adjust the [NETWORK] setting as follows.

Setting up the access point or the wireless router is required before connecting the player to the network.

Preparation

Before setting the wireless network, you need to:

- connect the broadband internet to the wireless home network.
- set the access point or wireless router.
- note the SSID and security code of the network.

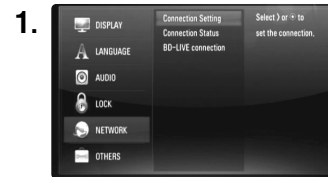

Select the [Connection Setting] option in the [Setup] menu then press > or ENTER.



The [Connection Setting] menu appear on the screen. Use ^/v to select [Wireless] and press ENTER.

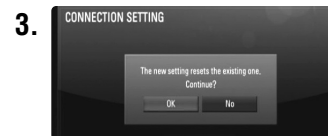

Selects [OK] and press ENTER to continue. The new connection settings resets the current network settings.

4.

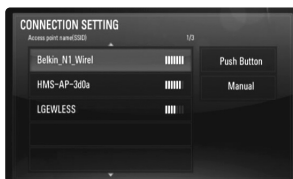

The player scans the all available access points or wireless routers within range and display them as a list. Use \wedge/\vee to select an access point or wireless router on the list, and then press ENTER.

If you have security on your access point or wireless router, verify that the WEP or WPA key that was entered into the player matches the router's information exactly. You need to input the security code as necessary.

Notes:

- WEP security mode generally have 4 keys available on an access point or wireless router's setting. If your access point or wireless router use WEP security, enter the security code of the key "No.1" to connect on your home network.
- An Access Point is a device that allows you to connect to your home network wirelessly.

[Push Button] – If your access point or wireless router that supports Push Button Configuration method, select this option and press the Push Button on your access point or wireless router within 120 counts. You do not need to know the access point name (SSID) and security code of your access point or wireless router.

[Manual] – Your access point may not be broadcasting its access point name(SSID). Check your router settings through your computer and either set your router to broadcast SSID, or manually enter the access point name(SSID) in [Manual].

5. Use $\wedge/\vee/\langle/\rangle$ to select the IP mode between [Dynamic] and [Static]. Normally, select [Dynamic] to allocate an IP address automatically.

Note:

If there is no DHCP server on the network and you want to set the IP address manually, select [Static] then set [IP Address], [Subnet Mask], [Gateway] and [DNS Server] using $\wedge/\vee/\langle/\rangle$ and numerical buttons. If you make a mistake while entering a number, press CLEAR to clear the highlighted part.

6. Select [OK] and press ENTER to apply network settings.
7. The player will ask you to test the network connection. Select [OK] and press ENTER to complete the network connection.
8. If you select [Test] and press ENTER at step 7 above, the network connection status is displayed on the screen. You can also test it on the [Connection Status] in the [Setup] menu.

Notes on Network Connection

- Many network connection problems during set up can often be fixed by re-setting the router or modem. After connecting the player to the home network, quickly power off and/or disconnect the power cable of the home network router or cable modem. Then power on and/or connect the power cable again.
- Depending on the internet service provider (ISP), the number of devices that can receive internet service may be limited by the applicable terms of service. For details, contact your ISP.
- Our company is not responsible for any malfunction of the player and/or the internet connection feature due to communication errors/malfunctions associated with your broadband internet connection, or other connected equipment.
- The features of BD-ROM discs made available through the Internet Connection feature are not created or provided by our company, and our company is not responsible for their functionality or continued availability. Some disc related material available by the Internet Connection may not be compatible with this player. If you have questions about such content, please contact the producer of the disc.
- Some internet contents may require a higher bandwidth connection.
- Even if the player is properly connected and configured, some internet contents may not operate properly because of internet congestion, the quality or bandwidth of your internet service, or problems at the provider of the content.
- Some internet connection operations may not be possible due to certain restrictions set by the Internet service provider (ISP) supplying your broadband Internet connection.
- Any fees charged by an ISP including, without limitation, connection charges are your responsibility.
- A 10 Base-T or 100 Base-TX LAN port is required for wired connection to this player. If your internet service does not allow for such a connection, you will not be able to connect the player.
- You must use a Router to use xDSL service.
- A DSL modem is required to use DSL service and a cable modem is required to use cable modem service. Depending on the access method of and subscriber agreement with your ISP, you may not be able to use the internet connection feature contained in this player or you may be limited to the number of devices you can connect at the same time. (If your ISP limits subscription to one device, this player may not be allowed to connect when a PC is already connected.)
- The use of a “Router” may not be allowed or its usage may be limited depending on the policies and restrictions of your ISP. For details, contact your ISP directly.
- The wireless network operate at 2.4GHz radio frequencies that are also used by other household devices such as cordless telephone, *Bluetooth*® devices, microwave oven, and can be affected by interference from them.
- Turn off all unused network equipment in your local home network. Some devices may generate network traffic.
- For the purpose of the better transmission, place the player as close as possible to the access point.
- In some instances, placing the access point or wireless router at least 0.45 m above the floor may improve the reception.
- Move closer to the access point if possible or re-orient the player so there is nothing between it and the access point.
- The reception quality over wireless depends on many factors such as type of the access point, distance between the player and access point, and the location of the player.
- Set your access point or wireless router to Infrastructure mode. Ad-hoc mode is not supported.

Network Software Update

Network update notification

From time to time, performance improvements and/or additional features or services may be made available to units that are connected to a broadband home network. If there is new software available and the unit is connected to a broadband home network, the player will inform you about the update as follows.

Option 1:

1. The update menu will appear on the screen when you turn on the player.

2.

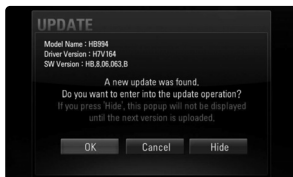

Use </> to select a desired option and then press ENTER.

[OK] - Starts the software update.

[Cancel] - Exits the update menu and displays it next booting.

[Hide] - Exits the update menu and it does not appear until next software is uploaded in the update server.

Option 2:

If the software update is available from the update server, the “Software Update” icon appears at the bottom of the Home menu. Press blue (D) coloured button to start the update procedure.

Software Update

You can update the player using the latest software to enhance the products operation and/or add new features. You can update the software by connecting the unit directly to the software update server.

Cautions:

- Before updating the software in your player, remove any disc and USB Device from the player.
- Before updating the software in your player, turn the player off and then turn it back on.
- **During the software update procedure, do not turn off the player or disconnect AC power, or do not press any button.**
- If you cancel the update, turn off the power and turn it on for stable performance.
- This unit cannot be updated to previous software version.

1. Check the network connection and settings (page 19-23).

2. Select [Software Update] option in the [Setup] menu then press > or ENTER.

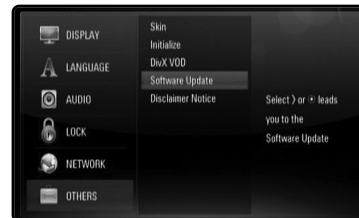

The player will check for the newest update.

Notes:

- Pressing ENTER while checking for the update will end the process.
- If there is no update available, the Message, “No update is found.” appears. Press ENTER to return to the [Home Menu].

3.



If newer version exists, the message “A new update was found. Do you want to download it?” appears.

4. Select OK to download the update. (Selecting [Cancel] will end the update.)
5. The player starts downloading the newest update from the server. (Downloading will takes several minutes depending on your home network condition)
6. When downloading is completed, the message, “Download is complete. Do you want to update?” appears.
7. Select OK to start updating. (Selecting [Cancel] will end the update and downloaded file will not be re-usable. To update software the next time, the software update procedure has to be started from the beginning again.)

Caution:

Do not turn off the power during the software update.

Note:

If the software includes the driver update, disc tray may open during the process.

8. When update is completed, the message, “Update is complete.” will appear, and the power will turn off automatically after 5 seconds.
9. Turn the power back on. The system now operates with the new version.

Note:

The Software Update function may not work properly depending on your internet environment. In this case, you can obtain the latest software from the authorized LG Electronics Service Centre then update your player. Refer to “Customer Support” on page 54.

Setting the sound mode

You can select a suitable sound mode. Press SOUND EFFECT repeatedly until the desired mode appears on the front panel display or the TV screen. The setting of the sound mode is not available when [HDMI Audio] is set to [On] (see page 31).

[Natural] mode: You can enjoy comfortable and natural sound.

[Bypass] mode: Software with multichannel surround audio signals are played according to the way it was recorded.

[Bass Booster] mode: Reinforce the bass sound effect from front left and right speaker and subwoofer.

[News] mode: This mode makes voice sound clear, improving the quality of voice sound.

[Drama] mode: You can enjoy more dynamic sound with improved center channel while watching a television drama.

[Sports] mode: This mode produces dynamic sound expansion for the sports program.

[Game] mode: You can enjoy more virtual sound while playing video games.

[Concert] mode: Creates the sound of concert hall.

[Music ReTouch] mode: When listening to MP3 files or other compressed music, you can enhance the sound. This mode is available only to 2 channel sources.

Adjust the speaker level settings

You can adjust the sound level of each speaker. Press SPEAKER LEVEL repeatedly to select a desired speaker to set. Press VOL (+/-) to adjust the sound level of the selected speaker while the level setting menu is displayed on the front panel display or the TV screen. Repeat and adjust the sound level of the other speakers.

Using the late night function

You can compress the dynamic range of the sound track.

Press NIGHT repeatedly.

This may be useful when you want to watch movies at low volumes late at night.

[NIGHT OFF]: Late night function off.

[NIGHT ON]: Reduction in dynamic range.

Notes:

- The late night function may be less effective or even have no effect depending on the source.
- While the late night mode is on, the lighting of the touch buttons and the level meter are turned off.

Using the mood lighting

You can set the mood lighting mode by pressing  button.

Using USB devices

This unit can play the movie, music and photo files contained in the USB device.

ON REMOTE

1. Connect a USB device:	—
2 Displays the [Home Menu]:	HOME
3 Select a main option: [Movie], [Photo] or [Music] option	^ v < >, ENTER
4 Select the [USB] option:	< >
5 Displays corresponding menu list: [MOVIE], [PHOTO] or [MUSIC] menu appears. Details for the menu are on pages 40-44.	ENTER

Tip:

If you select the [Movie], [Photo] or [Music] option when the USB device is connected and a disc is inserted simultaneously, the menu for selecting a media will appear. Select a media then press ENTER.

For example:

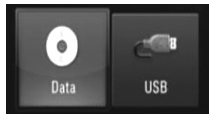

Inserting/Removing the USB device

Inserting the USB device – Insert straight-in until it fits into place.

Removing the USB device – Withdraw the USB device or cable carefully.

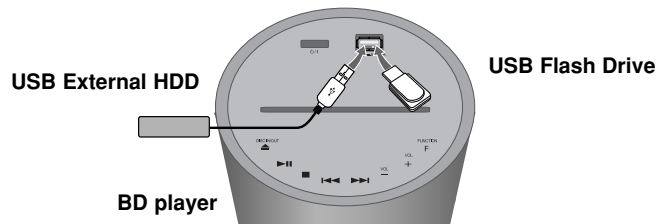

Notes:

- This player supports USB flash memory/external HDD formatted in FAT16, FAT32 and NTFS when accessing files (music, photo, movie). However, for BD-LIVE, only FAT16 and FAT32 formats are supported. Use the USB flash memory/external HDD formatted in either FAT16 or FAT32 when using BD-LIVE.
- The USB device can be used for the local storage for enjoying BD-Live discs with Internet.
- This unit can support up to 4 partitions of the USB device.
- Do not extract the USB device during operation (play, etc.).
- A USB device which requires additional program installation when you have connected it to a computer is not supported.
- USB device: USB device that support USB1.1 and USB2.0.
- Movie files, Music files and photo files can be played. For details of operations on each file, refer to relevant pages.
- Regular back up is recommended to prevent data loss.
- If you use a USB extension cable or USB HUB, the USB device may not be recognized.
- Some USB devices may not work with this unit.
- Digital camera and mobile phone are not supported.
- USB Port of the unit cannot be connected to PC. The unit cannot be used as a storage device.

Using the Home Menu

	ON REMOTE
1 Displays the [Home Menu]:	HOME
2 Select an option:	^ v < >
3 Displays the selected option menu:	ENTER
4 Exit the [Home Menu]:	HOME

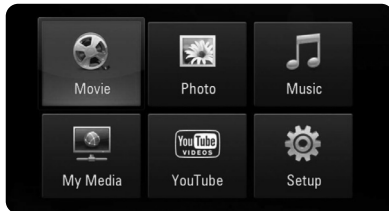

[Movie] – Start video media's playback or displays the [MOVIE] menu.

[Photo] – Displays [PHOTO] menu. (page 43-44)

[Music] – Displays [MUSIC]menu. (page 42)

[My Media] – Display and play the shared contents from the selected server. (pages 45-48)

[YouTube] – Watch YouTube videos streamed from the YouTube server via the internet to your TV. (page 49-51)

[Setup] – Displays the [Setup] menu. (page 28-33)

Note:

The unit will be in stop mode then the [Home Menu] will appear if you press HOME during playback.

Adjust the Setup settings

	ON REMOTE
1 Displays the [Home Menu]:	HOME
2 Select the [Setup] option:	^ v < >, ENTER
3 Select a desired option on the first level:	^ v
4 Move to second level:	>
5 Select a desired option on the second level:	^ v
6 Move to third level:	>
7 Adjust or confirm the setting: Some items require additional steps.	^ v, ENTER
8 Go back to the previous level:	<
9 Exit the [Setup] menu:	HOME or RETURN

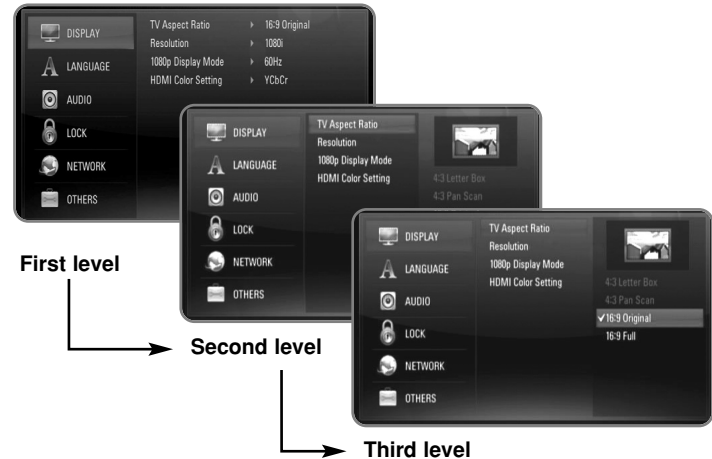

[DISPLAY] Menu

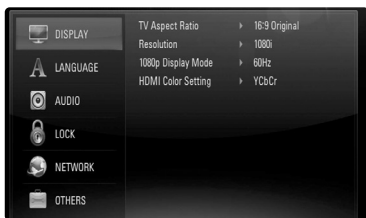

TV Aspect Ratio

[4:3 Letter Box] – Select when a standard 4:3 TV is connected. Displays theatrical images with masking bars above and below the picture.

[4:3 Pan Scan] – Select when a standard 4:3 TV is connected. Displays pictures cropped to fill your TV screen. Both sides of the picture are cut off.

[16:9 Original] – Select when a 16:9 wide TV is connected. The 4:3 picture is displayed with an original 4:3 aspect ratio, with black bars appearing at the left and right sides.

[16:9 Full] – Select when a 16:9 wide TV is connected. The 4:3 picture is adjusted horizontally (in a linear proportion) to fill the entire screen.

Note:

You cannot select [4:3 Letter Box] and [4:3 Pan Scan] option when the resolution is set to higher than 720p.

Resolution

Sets the output resolution of the HDMI video signal. Refer to “Resolution Setting” on page 17-18 for details about the resolution.

[Auto] – If the HDMI OUT jack is connected for TVs providing display information (EDID), automatically selects the resolution best suited to the connected TV.

[1080p] – Outputs 1080 lines of progressive video (only for HDMI connection).

[1080i] – Outputs 1080 lines of interlaced video.

[720p] – Outputs 720 lines of progressive video.

[480p] – Outputs 480 lines progressive video.

[480i] – Outputs 480 lines of interlaced video.

1080p Display Mode

When the resolution is set to 1080p, select [24Hz] for smooth presentation of film material (1080/24p) with a HDMI-equipped display compatible with 1080/24p input.

Notes:

- When you select [24Hz], you may experience some picture disturbance when the video switches video and film material. In this case, select [60Hz].
- Even when [1080p Display Mode] is set to [24Hz], if your TV is not compatible with 1080/24p, the actual frame frequency of the video output will be 60Hz to match the video source format.

HDMI Color Setting

Select the type of output from the HDMI OUT jack. For this setting, please refer to the manuals of your display device.

[YCbCr] – Select when connecting to a HDMI display device.

[RGB] – Select when connecting to a DVI display device.

[LANGUAGE] Menu



Display Menu

Select a language for the [Setup] menu and on-screen display.

Disc Menu / Disc Audio / Disc Subtitle

Select the language you prefer for the audio track (disc audio), subtitles, and the disc menu.

[Original] – Refers to the original language in which the disc was recorded.

[Other] – Press ENTER to select another language. Use number buttons then ENTER to enter the corresponding 4-digit number according to the language code list on page 56.

[Off] (for Disc Subtitle) – Turn off Subtitle.

Note:

Depending on the disc, your language setting may not work for some discs.

[AUDIO] Menu

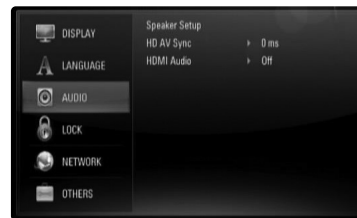

Speaker Setup

To obtain the best possible sound, use the Speaker Setup display to specify the volume of the speakers you have connected and their distance from your listening position. Use the Test to adjust the volume of the speakers to the same level.

[Speaker] – Select a speaker that you want to adjust.

[Volume] – Adjust the output level of each speaker. Be sure to set “Test” to “All” for easy adjustment.

[Distance] – Adjust the distance between each speaker and the listening position.

[Test] – The speakers will emit a test tone.
All: The test tone is emitted from each speaker in sequence.

To save your settings, press ENTER and select [Yes] by pressing < / >.

HD AV Sync

Sometimes Digital TV encounters a delay between picture and sound. If this happens you can compensate by setting a delay on the sound so that it effectively 'waits' for the picture to arrive: this is called HD AV Sync.

Use \wedge / \vee to scroll up and down through the delay amount, which you can set at anything between 0 and 300m sec.

The delay will vary depending on which digital TV channel you are on. If you change channel you may need to readjust the HD AV Sync.

HDMI Audio

You can set TV speaker output for the audio signal from the HDMI OUT jack.

[Off] – Audio signals are output to the system speakers only.

[On] – Audio signals are output from the TV's speaker and the system's front left and right speaker and subwoofer.

Note:

When [HDMI Audio] is set to [On], the sound mode is switched to [BYPASS] automatically.

[LOCK] Menu (Parental Control)

The [LOCK] settings affect only BD and DVD playback.

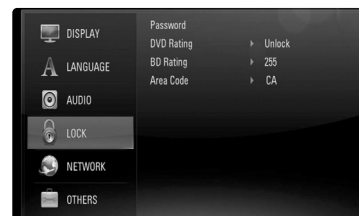

To access any features in [LOCK] settings, you must enter the 4-digit security code you have created.

If you have not entered a password yet, you are prompted to do so. Enter a 4-digit password and press ENTER. Enter it again and press ENTER to verify.

Password

You can create, change or delete the password.

[New] – Enter a 4-digit password and press ENTER. Enter it again and press ENTER to create a new password.

[Change] – Enter the current password and press ENTER.

Enter a 4-digit password and press ENTER. Enter it again and press ENTER to create a new password.

[Delete] – Enter the 4-digit password and press ENTER to delete the password.

Tip:

If you make a mistake before pressing ENTER, press CLEAR. Then input the correct password.

If you forget your password

If you forget your password, you can clear it using the following steps:

- 1** Remove any disc that might be in the player.
- 2** Select [Password] option in the [Setup] menu.
- 3** Use Number buttons to enter "210499". The password is cleared.

DVD Rating

Blocks playback of rated disc based on their content. (Not all discs are rated.)

[Rating 1-8] – Rating one (1) has the most restrictions and rating eight (8) is the least restrictive.

[Unlock] – If you select unlock, parental control is not active and the disc plays in full.

BD Rating

Set an age limit of BD-ROM play. Use number buttons to input an age limit for BD-ROM viewing.

[255] – All BD-ROM can be played.

[0-254] – Prohibits play of BD-ROM with corresponding ratings recorded on them.

Note:

The [BD rating] will be applied only for the BD disc that containing the Advanced Rating Control.

Area Code

Enter the code of the area whose standards were used to rate the DVD video disc, based on the list on page 56.

[NETWORK] Menu

The [NETWORK] settings are needed to use the software update, BD Live, My Media and YouTube features.

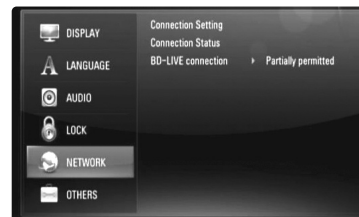

Connection Setting

If you have connected this player to a local area network (LAN), the player needs to be set up for network communication. (See “Connecting to your Home Network” on pages 19-23.)

Connection Status

If you want to check the network status on this player, select the [Connection Status] options and press > or ENTER to check whether a connection to the network and the internet have been established.

BD-LIVE connection

You can restrict Internet access when BD-Live functions are used.

[Permitted] – Internet access is permitted for all BD-Live contents.

[Partially permitted] – Internet access is permitted only for BD-Live contents which have content owner certificates. Internet access and AACS Online functions are prohibited for all BD-Live contents without a certificate.

[Prohibited] – Internet access is prohibited for all BD-Live contents.

[OTHERS] Menu



Skin

Changes the background of the initial screen.

Initialize

You can reset the player to its original factory settings, initialize the BD storage or deactivate the player.

[Factory Set] – If you need to, you can reset the player to all its factory settings. Some options cannot be reset. (Rating, Password and Area Code, etc.)

[BD Storage Clear] – Initializes the BD contents from the connected USB device.

DivX VOD

ABOUT DIVX VIDEO: DivX® is a digital video format created by DivX, Inc. This is an official DivX Certified device that plays DivX video. Visit www.divx.com for more information and software tools to convert your files into DivX videos.

ABOUT DIVX VIDEO-ON-DEMAND: This DivX® Certified device must be registered in order to play DivX Video-on-Demand (VOD) content. To generate the registration code, locate the [DivX VOD] section in the [Setup] menu. Go to vod.divx.com with this code to complete the registration process and learn more about DivX VOD.

[DivX Reg. Code] – Displays the registration code of your player.

[Deactivate] – Deactivate your player and display the deactivation code.

Note:

All the downloaded videos from DivX® VOD can only be played back on this unit.

Software Update

You can update the software by connecting the unit directly to the software update server (see page 24-25).

Disclaimer Notice

Press ENTER or > to view the notice of Network Service Disclaimer on page 60.

Play a disc

	ON REMOTE
1 Raise the disc tray.	OPEN/CLOSE (▲)
2 Insert a disc: Load a disc with the label facing you.	-
3 Lower the disc tray:	OPEN/CLOSE (▲)
4 Adjust the disc menu settings: A disc menu may not appear on the screen depending on the disc.	^ v < >, ENTER
5 Starts playback:	▶
6 Stops playback:	■

Notes:

- When you turn on the player or replace a disc, the player returns to the initial default setting. Depending on the disc, a specific type of audio that the disc has is output.
- Depending on the pre-recorded contents of the BD-ROM, some functions may not be available or may be operated differently than other media.

If a disc menu screen is displayed

BD **DVD** **AVCHD** **MOVIE**

The menu screen may be displayed first after loading a disc which contains a menu.

Use ^/v/</> buttons to select the title/chapter you want to view, then press ENTER to start playback.

Resume playback **ALL**

During playback, press ■ to stop playback.

The unit records the stopped point, depending on the disc. "■■■" appears on the screen briefly. Press ▶ to resume playback (from the scene point). If you press ■ again or unload the disc ("■" appears on the screen.), the unit will clear the stopped point. (■■■ = **Resume Stop**, ■ = **Complete Stop**)

Notes:

- The resume point may be cleared when a button is pressed (for example; POWER, OPEN/CLOSE, etc).
- On BD-Video discs including BD-J, the resume play function does not work.
- On BD-ROM interactive title, the unit will be in Complete Stop mode if you press ■ once during playback.

Skip to the next/previous chapter/track/file **ALL**

During playback, press ◀◀ or ▶▶ to go to the next chapter/track/file or to return to the beginning of the current chapter/track/file.

Press ◀◀ twice briefly to step back to the previous chapter/track/file.

Note:

When you are playing a content in the [My Media] menu, there may be many types of contents in the current folder together. In this case, press ◀◀ or ▶▶ to go to the previous or next content with same type.

Fast forward or fast reverse **ALL**

Press SCAN (◀◀ or ▶▶) to play fast forward or fast reverse during playback.

You can change the various playback speeds by pressing SCAN (◀◀ or ▶▶) repeatedly. Press ▶ to continue play at normal speed.

Notes:

- This function may not work on some disc or titles.
- Some music files on the [My media] menu may not operate this function.

Pause a playback **ALL**

During playback, press || to pause playback. Press ▶ to continue playback.

Tip: During Audio CD or MP3/WMA playback, press || once again to resume playback.

Frame-by-Frame playback

BD DVD AVCHD MOVIE MOVIE-N

Press || repeatedly to play Frame-by-Frame playback.

Slow down the playing speed

BD DVD AVCHD MOVIE MOVIE-N

While the playback is paused, press SCAN ▶▶ repeatedly to play in slow motion (4 steps, forward only).

Playing repeatedly

BD DVD AVCHD ACD MUSIC MUSIC-N

During playback, press REPEAT repeatedly to select a desired repeat mode.

BDs/DVDs

- 🔁 A-B: Selected portion will be repeated continually.
- 🔁 Chapter - The current chapter will be played back repeatedly.
- 🔁 Title - The current title will be played back repeatedly.

To return to normal playback, press REPEAT repeatedly to select [Off].

Audio CDs/Music files

- 🔁 Track – The current track or file will be played back repeatedly.
- 🔁 All – All the tracks or files will be played back repeatedly.
- 🔁 – The tracks or files will be played back in random order.
- 🔁 All – All the tracks or files will be played back repeatedly in random order.
- 🔁 A-B – Selected portion will be repeated continually. (Audio CD only)

To return to normal playback, press CLEAR.

Notes:

- If you press ▶▶ once during Repeat Chapter/ Track playback, the repeat playback cancels.
- This function may not work on some disc or title.

Repeating a specific portion

BD DVD AVCHD ACD

This player can repeat a portion you have selected.

1. During playback, press REPEAT to select [A-] at the beginning of the portion you wish to repeat.
2. Press ENTER at the end of the portion.
Your selected portion will be repeated continually.
3. To return to normal playback, press REPEAT repeatedly to select [Off].

Notes:

- You cannot select a portion less than 3 seconds.
- This function may not work on some disc or title.

Selecting a subtitle language

BD DVD AVCHD MOVIE MOVIE-N

During playback, press SUBTITLE repeatedly to select a desired subtitle language.

OR

During playback, press DISPLAY to display the playback menu.

Use \wedge \vee to select the [Subtitle] option then use \lt \gt to select desired subtitle language.

Notes:

Some discs allow you to change subtitle selections only via the disc menu. If this is the case, press TITLE/POPUP or DISC MENU button and choose the appropriate subtitle from the selections on the disc menu.

Hearing a different audio

BD DVD AVCHD MOVIE MOVIE-N

During playback, press DISPLAY to display the playback menu.

Use \wedge \vee to select the [Audio] option then use \lt \gt to select desired audio language or audio track.

Notes:

- Some discs allow you to change audio selections only via the disc menu. If this is the case, press TITLE/POPUP or DISC MENU button and choose the appropriate audio from the selections on the disc menu.
- Immediately after you have switched sound, there may be a temporary discrepancy between the display and actual sound.
- On BD-ROM disc, the multi audio format (5.1CH or 7.1CH) is displayed with [MultiCH] in the on-screen display.

Using the search menu

BD DVD AVCHD MOVIE MOVIE-N

During playback, press SEARCH to display the search menu.

Press \lt \gt to skip the playback 15 seconds forward or backward.

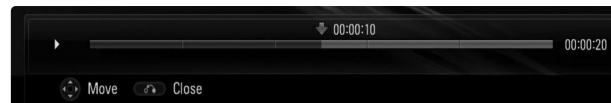

Tip:

You can select a point that you want to skip by pressing and holding \lt \gt button.

Notes:

- This function may not work on some disc or titles.
- This function may not work on some [My media] content depending on the file type and ability of the DLNA server.

Using coloured (A, B, C, D) Buttons **BD**

These buttons are available only during BD-J contents playback. Use the appropriate buttons as indicated by the display. Depending on the disc contents, the functions of each button may differ.

Viewing the Title menu or Popup menu

BD DVD

Press TITLE/POPUP to display the title menu or popup menu.

If the current DVD or BD-ROM disc has a menu, the Title menu or Popup menu appears on the screen. Depending on the disc, the menu may not be available.

Last Scene Memory **BD** **DVD**

This unit memorizes the last scene from the last disc that is viewed. The last scene remains in memory even if you remove the disc from the unit or switch off the unit. If you load a disc that has the scene memorized, the scene is automatically recalled.

Notes:

- Settings are stored in memory for use any time.
- This unit does not memorize settings of a disc if you switch off the unit before commencing to play it.
- Last Scene Memory function for a previous disc is erased once a different disc is played.
- This function may not work depending on the disc.

Screen Saver

The screen saver appears when you leave the player in Stop mode for about five minutes.

Note:

Depending on the unit status, the screen saver may not appear.

Changing content list view

MOVIE **MOVIE-N** **ACD** **MUSIC** **MUSIC-N**

On the [Movie], [Music], [Photo] and [My Media] menu, you can change the content list view by pressing DISPLAY repeatedly.

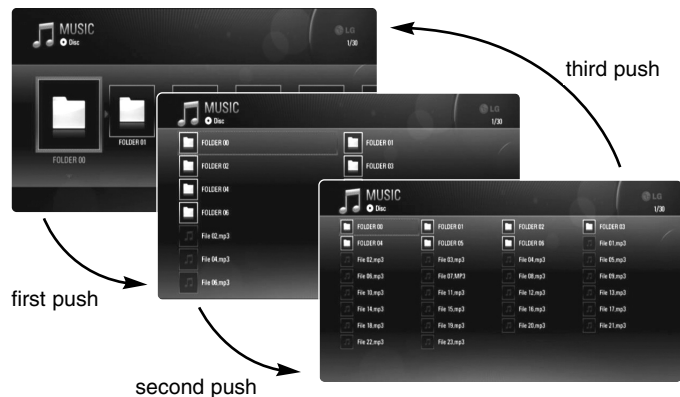

Note:

The equalizer will disappear when you change the music contents list view.

Displaying disc information

	ON REMOTE
1 Play the disc loaded on the unit:	▶
2 Displays the playback menu:	DISPLAY
3 Select an item:	^ v
4 Adjust the playback menu settings:	< >
5 Exit the disc playback menu:	DISPLAY



- 1 Title – Current title number/total number of titles.
- 2 Chapter – Current chapter number/total number of chapters.
- 3 Time – Elapsed playing time.
- 4 Audio – Selected audio language or channel.
- 5 Subtitle – Selected subtitle.
- 6 Angle – Selected angle/total number of angles.

Notes:

- If no button is pressed for a few seconds, the on-screen display disappears.
- A title number cannot be selected on some discs.
- An item may not be available on some discs or titles.
- If BD interactive title is playing back, some setting information is displayed on the screen but prohibited to be changed.

Moving to another title/chapter

BD DVD AVCHD MOVIE

When a disc has more than one title/chapter, you can move to another title/chapter/track.

Press DISPLAY during playback then use ^/v to select the [Title/Chapter] icon. Then, press the appropriate numbered button (0-9) or </> to select a title/chapter number.

Playing from selected time

BD DVD AVCHD MOVIE MOVIE-N

Press DISPLAY during playback. The time search box shows the elapsed playing time. Select the [Time] option and then input the required start time in hours, minutes, and seconds from left to right. For example, to find a scene at 2 hours, 10 minutes, and 20 seconds, enter “21020” and press ENTER. If you enter the wrong numbers, press CLEAR and enter the correct numbers.

Notes:

- This function may not work on some disc or titles.
- This function may not work on some [My media] content depending on the file type and ability of the DLNA server.

Watching from a different angle **BD DVD**

If the disc contains scenes recorded at different camera angles, you can change to a different camera angle during playback.

During playback, press DISPLAY to display the playback menu. Use ^ v to select the [Angle] option, then use < > to select desired angle.

Enjoying BD-LIVE™

	ON REMOTE
1 Raise the disc tray.	OPEN/CLOSE (▲)
2 Inserts a BD-ROM disc with BD-LIVE™ features:	–
3 Lower the disc tray.	OPEN/CLOSE (▲)
4 Check the network connection and settings: BD-Live features need the internet connection.	–
5 Connect a USB device: A USB device is required to use this function.	–
6 Select a BD-LIVE™ features on the disc menu:	▲ ▼ < >, ENTER

This unit allows you to enjoy functions such as picture-in-picture, secondary audio and Virtual packages, etc., with BD-Video supporting BONUSVIEW (BD-ROM version 2 Profile 1 version 1.1/ Final Standard Profile). In addition to the BONUSVIEW function, BD-Video supporting BD-Live (BD-ROM version 2 Profile 2) that has a network extension function allows you to enjoy more functions such as online games by connecting this unit to the Internet.

Enjoying BD-Live discs with Internet

This unit supports BD-Live, a new BD-Video function that allows you to use the following interactive functions when connected to the Internet. (The usable functions and the operating method may vary with each disc. For details, refer to the instructions for the disc.)

- Additional contents such as movie's trailer, subtitles and BD-J, etc. can be downloaded to USB device to play them.
- Special video data, etc. may be played back while they are being downloaded to a USB device.

Preparations:

- The unit must be connected to the Internet and set up to use the BD-Live functions (see page 19-23 and 32).
- A USB device is required to use this function. Connect a USB device (see page 27).
- The free space in the USB device must be more than 1GB.

Caution:

Do not extract the connected USB device while content is being downloaded or a Blu-ray disc is still in the disc tray. Doing so may damage the connected USB device and BD-Live features may not operate properly with the damaged USB device anymore.

If the connected USB device seems damaged from such an action, you can format the connected USB device from the PC and reuse it with this player.

Notes:

- Some BD-Live contents may be restrictively accessed in some territories by contents provider's own decision.
- It may take up to several minutes to load and start enjoying BD-Live contents.
- Depending on a disc, the BD-Live function may not be operated if [BD-LIVE connection] option is set to [Partially permitted]. (See page 32.)
- The connection to the Internet may take time or the Internet may not be connected depending on the connection environment. It is required that you use a broadband connection.
- Do not remove the USB device during operation. The USB device may be damaged. Stop playback and turn off the menu beforehand.

Tip:

Special video data, etc. may be played back while they are being downloaded to a USB device using one function of BD-Live. The playback may be paused depending on the communication environment. Some functions may be disabled to prevent skipping to sections that have not been downloaded, etc.

AACS Online

When discs supporting BD-Live are played back, the player or disc IDs may be sent to the content provider via the Internet.

Services and functions to be provided differ depending on the disc.

- You can be introduced to other similar movies if you record your viewing history on the server by using these IDs.
- Game score histories can be saved.

Playing secondary video (picture-in-picture)

Secondary video can be played from a disc compatible with the picture-in-picture function.

For the playback method, refer to the instructions for the disc.

To turn on/off secondary video, press PIP. Secondary video is played.

Press the button to turn it ON or OFF.

Notes:

- Discs may not always be played back according to the settings on this unit, as certain playback formats are prioritized on certain discs.
- Only the primary video is played during search/slow-motion or frame-by-frame.
- This function may not work depending on the disc.

Playing a movie

The player can play DivX files on the disc/USB device and video contents recorded on a DVD-RW(VR mode) discs. Before playing movie files, read "Movie file requirement" on page 41.

ON REMOTE

1 Insert a disc/USB device containing movie contents.	–
2 Displays the [Home Menu]:	HOME
3 Select the [Movie] option:	^ v < >, ENTER
4 Selects a movie from the [MOVIE] menu:	^ v
5 Plays the selected movie:	▶
6 Stops the playback:	■

Note:

- When the USB device is connected and a disc is inserted simultaneously, the menu for selecting a media will appear. Select a media then press ENTER.
- You can use various playback functions. Refer to pages 34-38.
- On the [MOVIE] menu, use red or blue button to move to the first or the last file or track and green or yellow button to move to the previous or next page.
- Unfinalized DVD VR format discs may not be played in this player.
- Some DVD-VR disc are made with CPRM data by DVD RECORDER. This unit cannot support these kinds of discs.
- Some DivX files may not play, depending on the DivX format or the recording format.
- Press DISC MENU to move to the list menu.

What is CPRM?

CPRM is a copy protection system (with scramble system) only allowing the recording of 'copy once' broadcast programs. CPRM stands for Content Protection for Recordable Media.

Notice for displaying the DivX subtitle

If the subtitle does not display properly, change the language code as described below.

- 1 Press and hold SUBTITLE for 3 seconds during playback.
The language code will appear.
- 2 Press SUBTITLE repeatedly to select another language code until the subtitle is displayed properly and then press ENTER.

Movie file requirement (USB/DISC)

Movie file compatibility with this player is limited as follows:

Available resolution size: 1920 x 1080 (W x H) pixels

File extensions: “.avi”, “.divx”, “.mpg”, “.mpeg”, “.mp4”, “.mkv”

Playable subtitle: SubRip (.srt / .txt), SAMI (.smi), SubStation Alpha (.ssa/.txt), MicroDVD (.sub/.txt), VobSub (.sub) SubViewer 1.0 (.sub), SubViewer 2.0 (.sub/.txt), TMPlayer (.txt), DVD Subtitle System (.txt)

Playable Codec format: “DIVX3.xx”, “DIVX4.xx”, “DIVX5.xx”, “XVID”, “DIVX6.xx” (Standard playback only), H.264/MPEG-4 AVC, DIVX-HD, MPEG1 SS, MPEG2 PS, MPEG2 TS

Playable Audio format: “Dolby Digital”, “DTS”, “MP3”, “WMA”, “AAC”, “AC3”

Sampling frequency: between 32-48 kHz (WMA),
between 16-48 kHz (MP3)

Bit rate: between 20-320 kbps (WMA), between 32-320 kbps (MP3)

CD-R/RW, DVD±R/RW, BD-R/RE Format:

ISO 9660+JOLIET, UDF and UDF Bridge format

Maximum Files/Folder:

Less than 2000 (total number of files and folders)

- The movie file name and subtitle are limited to 180 characters.
- Not all the WMA and AAC Audio format is compatible with this unit.
- HD movie files contained on the CD or USB 1.0/1.1 may not played properly. BD, DVD or USB 2.0 are recommended to play back HD movie files.
- This player support H.264/MPEG-4 AVC profile Main, High at Level 4.1. For a file with higher level, the warning message will be appeared on the screen.
- This player does not support the file that are recorded with GMC*¹ or Qpel*². Those are video encoding techniques in MPEG4 standard, like DivX or XVID have.

*¹ GMC – Global Motion Compensation

*² Qpel – Quarter pixel

Listening to a music

The player can play Audio CDs and MP3/WMA files. Before playing MP3/WMA files, read “MP3/WMA audio file requirement (USB/DISC)”.

ON REMOTE

1 Inserts an Audio CD or a disc/USB Flash Drive containing MP3/WMA files.	–
2 Displays the [Home Menu]:	HOME
3 Select a [Music] option:	^ v < >, ENTER
4 Selects a music from the [MUSIC] menu:	^ v
5 Plays the selected music:	▶
6 Stops the playback:	■

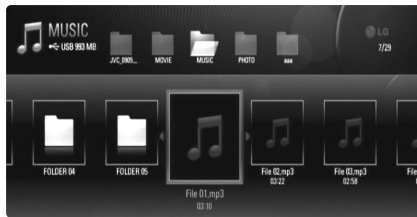

Example MP3 files

Notes:

- When the USB device is connected and a disc is inserted simultaneously, the menu for selecting a media will appear. Select a media then press ENTER.
- You can use various playback functions. Refer to pages 34-37.
- The file name displayed in the [My Media] menu may differ from the file name on the media server.
- Playback quality on the [My Media] menu is affected by the server's ability and condition.

Tips:

- To go directly to any track or file and play, enter the track/file number using the numbered buttons (0-9).
- The playback may start automatically if the Audio CD inserted.
- Use ^/v/</> to select a folder then press ENTER and you can view the files in the folder. If you want to move to the upper or lower directory, use ^/v to move to the desired directory.
- On the [MUSIC] menu, use red or blue button to move to the first or the last file or track and green or yellow button to move to the previous or next page.
- The equalizer indicator is not coupled with the music in play back.
- If there is impossible code to express in the file name, it may be displayed as illegible.

MP3/WMA audio file requirement (USB/DISC)

File extensions: “.mp3”, “.wma”

Sampling frequency: between 8 - 48 kHz (WMA),
between 11 - 48 kHz (MP3)

Bit rate: between 8 - 320 kbps (WMA, MP3)

CD-R/RW, DVD±R/RW, BD-R/RE Format:

ISO 9660+JOLIET, UDF and UDF Bridge format

Maximum Files/Disc:

Less than 2000 (total number of files and folders)

Notes on MP3/WMA file

- Depending on the size and number of the MP3/WMA files, it may take several minutes to read the contents of the media.
- This unit cannot support the ID3 Tag embedded in the MP3 file.
- The total playback time indicated on the screen may not correct for VBR files.

Viewing a photo

This unit can play a photo files. Before playing photo files, read "Photo file requirement (USB/DISC)" on page 44.

ON REMOTE

1 Inserts a disc/USB device containing photo files.	-
2 Displays the [Home Menu]:	HOME
3 Selects a [Photo] option:	<>, ENTER
4 Selects a photo from the [PHOTO] menu:	^ v <>
5 Displays the selected photo in full screen:	ENTER
6 Displays the next or previous photo:	◀◀ / ▶▶
7 Return to the [PHOTO] menu screen:	STOP

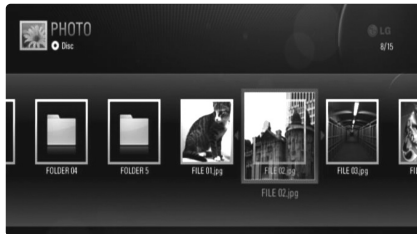

Notes:

- When the USB device is connected and a disc is inserted simultaneously, the menu for selecting a media will appear. Select a media then press ENTER.
- You can start the slide show by pressing ▶ while photo file is selected in the [PHOTO] or [My Media] menu.
- On the [PHOTO] menu, use red or blue button to move to the first or the last file and green or yellow button to move to the previous or next page.
- You can change the content list view by pressing DISPLAY repeatedly.

Options during viewing a photo file in full screen

You can use various options during viewing a picture in full screen.

Use ^ v <> to select an option and use the options as described below. Available options in the [PHOTO] menu and [My Media] menu are different as shown below.

Options of [PHOTO] menu

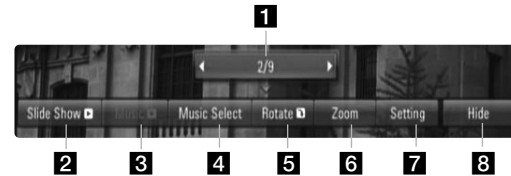

Options of [My Media] menu

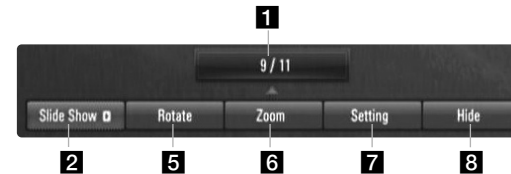

- 1 Use <> to advance to the previous or next file.
- 2 Press ENTER to start or pause the slide show.
- 3 Press ENTER to play or pause the background music. This option is available after the background music is selected using [Music Select] option. This option is not available on [My Media] menu.
- 4 Selects the background music. This option is not available on [My Media] menu.
 - 1) Press ENTER and the menu will appear.
 - 2) Use ^ v <> to select a media or folder where there are music file(s).
 - 3) Press ENTER to confirm your selection.
- 5 Press ENTER to rotate the picture clockwise. This option is not available during slide show.

6 Use green or yellow buttons to zoom in or out of the picture. You can move through the zoomed picture using $\wedge \vee < >$ buttons. Press RETURN to exit the [Zoom] menu and return to the normal picture size.

7 Use $\wedge \vee$ to select an option between [Effect] or [Delay]. Use $< >$ to adjust and press ENTER to set the selected option. [Effect] – You can apply various effects during a photo slide show.

Off : Slide Show without any effect.

Random : Slide show effects are applied randomly.

Slide : Reveals a photo in a sliding motion from various directions.

Door : Photo will be appear like door opening.

Lattice : Photo will be appear from tiled pieces to full screen image

[Delay] – You can set the photo delaying time while Slide Show.

8 Press ENTER to exit the option menu. To access the menu again, press ENTER.

Tips:

- For the files that are contained in a disc or USB device, you can enter the file number using the numbered buttons (0-9) to go directly to a specific file.
- You can start the slide show without option menu by pressing \blacktriangleright during viewing a photo file in full screen.
- Use $\wedge \vee < >$ to select a folder then press ENTER and you can view the files in the folder. If you want to move to the upper or lower directory, use $\wedge \vee$ to move to the desired directory.
- If there is a code that is impossible to express in the file name, it may be displayed as illegible.
- Depending on the DLNA server, the file name displayed on the screen may differ from the original file name.

Listening to music during slide show in [My Media] menu

You can view photos as a slide show while listening to music content on [My Media] menu.

- 1.** Press HOME and select [My Media] in the [Home Menu].
- 2.** Select a server from the list and press ENTER to display the shared folders from the server.
- 3.** Select a music file from the menu and press \blacktriangleright to play the music.
- 4.** Use $\wedge \vee < >$ to select a photo file from the menu and press ENTER to display in full screen.
- 5.** Select [Slide Show] option and press ENTER to start slide show.

Photo file requirement (USB/DISC)

File extensions: “.jpg”, “.jpeg”, “.png”

Recommended size:

Less than 4,000 x 3,000 x 24 bit/pixel

Less than 3,000 x 3,000 x 32 bit/pixel

CD-R/RW, DVD±R/RW, BD-R/RE Format:

ISO 9660+JOLIET, UDF and UDF Bridge format

Maximum Files/Folder: Less than 2000 (total number of files and folders)

Notes on Photo file

- Progressive and lossless compression photo image files are not supported.
- Depending on the size and number of the photo files, it may take several minutes to read the contents of the media.

Using My media features

This unit can browse and play content on DLNA Certified media servers connected on your home network.

ON REMOTE

1 Check the network connection and settings: See pages 19-23.	HOME, \wedge \vee $<$ $>$, ENTER
2 Displays the [Home Menu]:	HOME
3 Selects a [My Media] option:	\wedge \vee $<$ $>$, ENTER
4 Selects a server from the server list:	\wedge \vee, ENTER
5 Selects a content from the list:	\wedge \vee $<$ $>$
6 Plays the selected content:	▶
7 Stops the playback:	■
8 Return to the server list menu:	SEARCH

About DLNA

This Player is a DLNA Certified digital media player that can display and play movie, photo and music content from your DLNA Certified network device and DLNA server.

The Digital Living Network Alliance (DLNA) is a cross-industry organization of consumer electronics, computing industry and mobile device companies. Digital Living provides consumers with easy sharing of digital media through a wired or wireless network in the home.

The DLNA certification logo makes it easy to find products that comply with the DLNA Interoperability Guidelines. This unit complies with DLNA Interoperability Guidelines v1.5.

When a PC running DLNA server software or other DLNA compatible device is connected to this player, some setting changes of software or other devices may be required. Please refer to the operating instructions for the software or device for more information.

About Nero MediaHome 4 Essentials

Nero MediaHome 4 Essentials is a software for sharing movie, music and photo files stored on your computer to this player as a DLNA compatible digital media server.

Notes:

- The Nero MediaHome 4 Essentials CD-ROM is designed for PCs and should not be inserted in this player or in any product other than a PC.
- The supplied Nero MediaHome 4 Essentials CD-ROM is a customized software edition only for sharing files and folders to this player.
- The supplied Nero MediaHome 4 Essentials software does not support the following functions: Transcoding, Remote UI, TV control, Internet services and Apple iTunes
- This manual explains operations with the English version of Nero MediaHome 4 Essentials as examples. Follow the explanation referring to the actual operations of your language version.

Installing Nero MediaHome 4 Essentials

Nero MediaHome 4 Essentials is a software for sharing movie, music and photo files stored on your computer with this player.

Before you install Nero MediaHome 4 Essentials, check the system requirement shown below.

- Windows® XP (Service Pack 2 or higher), Windows Vista® (no Service Pack required), Windows® XP Media Centre Edition 2005 (Service Pack 2 or higher), Windows Server® 2003
- Windows Vista® 64-bit edition (application runs in 32-bit mode)
- Hard drive space: 200 MB hard drive space for a typical installation of Nero MediaHome stand-alone
- 1.2 GHz Intel® Pentium® III or AMD Sempron™ 2200+ processors
- Memory: 256 MB RAM
- Graphics card with at least 32 MB video memory, minimum resolution of 800 x 600 pixels, and 16-bit colour settings
- Windows® Internet Explorer® 6.0 or higher
- DirectX® 9.0c revision 30 (August 2006) or higher
- Network environment: 100 Mb Ethernet, WLAN (IEEE 802.11b/g/n)

Start up your computer, and insert the Nero MediaHome 4 Essentials CD-ROM into your computer's CD-ROM drive. An installation wizard will walk you through the quick and uncomplicated installation process. To install Nero MediaHome 4 Essentials, proceed as follows:

1. Close all Microsoft Windows programs and exit any anti-virus software that may be running.
2. Insert the Nero MediaHome 4 Essentials CD-ROM into your computer's CD-ROM drive.
3. Click [Nero MediaHome 4 Essentials]. The installation is prepared and the installation wizard appears.
4. Click the [Next] button to display the serial number input screen. Click [Next] to go to the next step.
5. If you accept all conditions, click [I accept the License Conditions] check box and click [Next]. Installation is not possible without this agreement.
6. Click [Typical] and click [Next]. The installation process is started.
7. If you want to take part in the anonymous collection of data, select the check box and click the [Next] button.
8. Click the [Exit] button to complete the installation.

Sharing files and folders

On your computer, you must share the folder containing movie, music and/or photo content to play them using [My Media] features. This part explains the procedure for selecting the shared folders on your computer.

1. Double-click the "Nero MediaHome 4 Essentials" icon on the desktop.
2. Click [Network] icon on the left and define your network name in the [Network name] field. The Network name you enter will be recognized by your player.
3. Click [Shares] icon on the left.
4. Click [Local Folders] tab on the [Shares] screen.
5. Click [Add] icon to open the [Browse Folder] window.
6. Select the folder containing the files you want to share. The selected folder is added to the list of shared folders.
7. Click [Start Server] icon to start the server.

Notes:

- If the shared folders or files are not displayed on the player, click the folder on the [Local Folders] tab and click [Rescan Folder] at the [More] button.
- Visit www.nero.com for more information and software tools.

Playing back shared contents

This unit can browse and play content on DLNA Certified media servers connected on your home network.

1. Start a DLNA certified media server that connected on your home network.
2. Press HOME. The [Home Menu] appears on the screen.
3. Use $\wedge \vee < >$ to select [My Media] and press ENTER. The server list appears on the screen.



Use $\wedge \vee$ to select a server from the list and press ENTER to display the shared folders from the server.

Notes:

- Depending on the media server, this player may need to get the permission from the server.
- If you want to re-scan available media server, press the blue (D) coloured button.



Use $\wedge \vee < >$ to navigate the shared contents list and select the content you want to playback. On the [My Media] menu, use the red or blue button to move to the first or the last file/folder and the green or yellow button to move to the previous or next page

6. Press ENTER or \blacktriangleright to playback the selected content.

Note: You can use various playback functions. Refer to pages 34-38.

7. Press \blacksquare to stop playback and go to the contents list menu.

Notes on My Media features

- To play the file on the media server, the player and the media server must be connected to the same access point.
- Because the compatibility and available playback functions on the [My Media] menu are tested on the bundle DLNA server (Nero MediaHome 4 Essentials) environment, file requirements and playback functions on the [My Media] menu may differ depending on media servers.
- The file compatibility on page 48 are not always compatible. There may be some restrictions by the file features and media server's ability.
- If you press TITLE/POPUP while a movie file is selected, The file information is displayed on the screen. But, the information may not be correct compared to the actual file features.
- The thumbnail of the unplayable files can be displayed in the [My Media] menu, but those cannot be played on this player.
- If there is an unplayable music file in the [My Media] menu, the player skip the file and play the next file.
- The file information indicated on the screen may not be correct compared to the music and movie files in [My Media] menu.
- Playing a movie subtitle files are only available on DLNA media server created by the supplied Nero MediaHome 4 Essentials software on this player's package.
- The subtitle file name and movie file name have to be the same and located at the same folder.
- If subtitle files have been added after a directory has been indexed already, the user has to remove and re-add the folder to the list of shared media.
- The playback and operating quality of the [My Media] function may be affected by your home network condition.
- The files from removable media such as USB drive, DVD-drive etc. on your media server may not be shared properly.

Playing YouTube videos

ON REMOTE	
1 Check the network connection and settings: See page 19-23.	HOME, \wedge \vee \langle \rangle , ENTER
2 Displays the [Home Menu]:	HOME
3 Select the [YouTube] option:	\wedge \vee \langle \rangle , ENTER
4 Select a desired option on the YouTube menu:	\wedge \vee \langle \rangle , ENTER
5 Select a video you want to play:	\langle \rangle
6 Starts playback the selected video:	\blacktriangleright , ENTER or DISPLAY

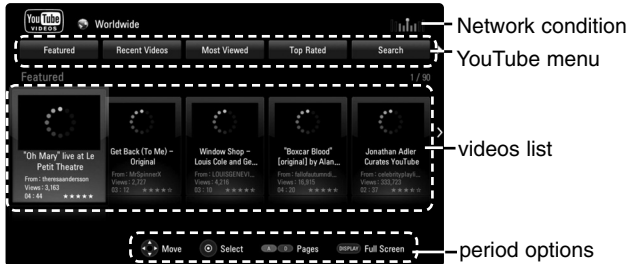

About the YouTube menu

There are various options on the YouTube menu. Use \wedge \vee \langle \rangle to select an option and press ENTER to select the options as described below.



- 1** Featured – The featured videos list will be displayed.
- 2** Recent Videos – The most recently updated videos list will be displayed.
- 3** Most Viewed – The most viewed videos list will be displayed. The period option appears at the bottom of the screen.
- 4** Top Rated – The best rated videos list from YouTube server will be displayed. The period option appears at the bottom of the screen.
- 5** Search – The keyboard menu will be displayed. See “Searching videos” on page 51 for more detail.
- 6** History – The videos list that you recently played on this unit will be displayed. Maximum of 25 videos can be stored.
- 7** Favorites – This option will be appeared only when the unit is in sign-in status. Displays the videos list that is arranged in the YouTube server with your account. Some videos may not appear on the [Favorites] list, even if the videos are arranged in the server.
- 8** Sign in (Sign Out) – Displays the keyboard menu to sign in or returns to the sign-out status. See “Sign in with your YouTube account” on page 51 for more details.
- 9** Local site – Choose which country's videos you would like to view. The countries listed on the [Local Site] menu may differ with those listed on the YouTube web site.

Notes:

- The YouTube menu can display 5 videos in the videos list. Press red or blue button to display next/previous 5 videos.
- If you select the [Most Viewed] or [Top Rated] option in the YouTube menu, the period options appear at the bottom of the screen. Use \wedge \vee \langle \rangle to select a period option and press ENTER to display the videos list within the selected period.
- The videos list searched from the player may differ with the list searched from a web browser on PC.

About YouTube playback screen

When you press ► or ENTER at the video you want to watch, the playback screen and content detail will appear on the screen.

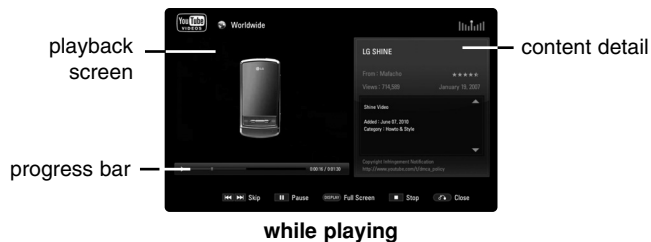

And when the playback ends or stops, the stopped playback screen and related videos list appear on the screen. Use ^ v < > to select the current video or a video from the related videos list and then press ► or ENTER to play the selected video.



When you press DISPLAY at the video you want to watch, the playback starts in full screen.



Press DISPLAY to toggle between playback in full screen and playback screen with content detail.

Playing a video

While watching a video from YouTube via your player, you can control the YouTube video playback. You can use the buttons on the remote to pause and resume viewing, just like when you watch a DVD. While playing a video, the buttons on the remote do the following:

Button(s)	Operations
► or ENTER	Starts playback the video with content detail.
DISPLAY	Toggle between playback in full screen and playback screen with content detail.
	To pause a video while it is playing. To resume playing a paused video, press ► again.
■	Stops the video and displays related videos list.
◀▶▶▶	Skip the playback forward or backward .
HOME	When you have finished watching videos, simply press the HOME button on the remote control to go to the [Home Menu].

Notes:

- The settings of this player do not affect the YouTube's playback quality.
- The playback of YouTube videos may be paused, stopped or buffering occurring often depending on your broadband speed. We recommend a minimum connection speed of 1.5 Mbps. For the best playback condition, a connection speed of 4.0 Mbps is required. Sometimes your broadband speed varies based on your ISP's network conditions. Contact your ISP if you have problems maintaining a fast connection that is reliable, or if you want to increase your connection speed. Many ISPs offer a variety of broadband speed options.

Searching videos

You can search for videos by entering search words of up to 128 characters.

Use < > to select [Search] option from the menu and press ENTER to display the keyboard menu. Use ^ v < > to select a character then press ENTER to confirm your selection on the keyboard menu.

To enter a letter with an accent mark, select the letter from extended character set.

Example: Select "D" and then press DISPLAY to display the extended character set. Use < > to select "D" or "Ð" and then press ENTER.



[OK]: Searching related videos of search words.

[Clear]: Clear all entered characters.

[Space]: Inserts a space at the cursor position.

[Backspace]: Deletes the previous character at the cursor position.

[ABC / abc / #+==&]: Change the keyboard menu settings to capital letter, small letters or symbols.

When you finish entering the search words, select [OK] and press ENTER to display the related videos list.

Note:

Available languages to enter on the keyboard menu are as follows: English, Spanish, Italian, French, German, Dutch, Portuguese, Swedish, Polish and Czech.

Sign in with your YouTube account

To watch videos from your [Favorites] video list on the YouTube server with your account, you need to sign in with your YouTube account.

Use < > to select [Sign In] option from the menu and press ENTER to display the keyboard menu. Use ^ v < > to select a character then press ENTER to confirm your selection on the keyboard menu.



[OK]: Finish entering an ID or password.

[Clear]: Clear all entered characters.

[Space]: Inserts a space at the cursor position.

[Backspace]: Deletes the previous character at the cursor position.

[ABC / abc / #+==&]: Change the keyboard menu settings to capital letters, small letters or symbols.

If you want to sign out, select the [Sign Out] from the YouTube menu and press ENTER.

This unit can automatically store up to 5 IDs which were previously signed-in. The IDs list appears when you select the [Sign In] option. Select a stored ID on the list and press ENTER to display the keyboard menu with the selected ID is entered. You will then only need to enter the password to sign in.



[New ID]: Displays the keyboard menu for entering a new ID and password.

[X]: Delete the stored ID as shown left of the [X] symbol.

Listening to the radio

Be sure that FM antenna is connected.

ON REMOTE

1 Select FM:	RADIO (INPUT)
2 Select a radio station:	TUNING -/+
3 To save a radio station: A preset number will show on the display. Up to 50 radio stations can be saved.	ENTER
4 To confirm press:	ENTER
5 To select a saved station	PRESET ^ V

Listening to the radio - more you can do

Look for radio stations automatically

Press and hold TUNING -/+ for more than a second. The tuner will scan automatically and stop when it finds a radio station.

Choose a preset number for a radio station

When storing a radio station, the preset number can be chosen. When this unit automatically shows a preset number, press PRESET ^/V to change it. Press ENTER to save your chosen number.

Delete all the saved stations

Press and hold ENTER for two seconds. ERASE ALL will flash up on the display. Press ENTER to erase all saved radio stations.

Improve poor FM reception

Press MO./ST. This will change the tuner from stereo to mono and usually improve the reception.

Using HDMI IN jack

You can enjoy the pictures and sound of your component with the HDMI OUT jack.

To the HDMI OUT jack of your component (set-top box, digital satellite receiver, video game machine, etc.)

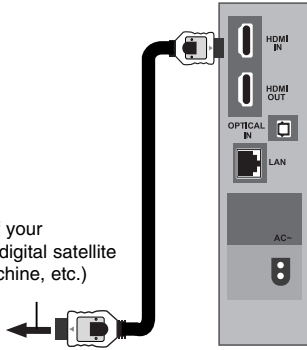

ON REMOTE

1 Connect the HDMI OUT jack of your component into the HDMI IN jack on the back of the wireless front right speaker.	-
2 Turn the power on:	⏻
3 Select the [HDMI IN] option:	RADIO (INPUT)
4 Turn down the volume of this unit:	VOL (+/-)
5 Turn your component on:	-
6 Adjust the volume of this unit:	VOL (+/-)

Note:

- You cannot change the video resolution at the HDMI IN mode. Change the video resolution of the connected component.
- You cannot operate SIMPLINK function at the HDMI IN mode.
- The setting of the sound mode is not available when Dolby Digital Plus, Dolby TrueHD and DTS-HD are played at HDMI IN mode.
- If the video output signal is abnormal when your personal computer is connected to HDMI IN jack, change the resolution of your personal computer to 480p, 720p, 1080i or 1080p.

Using DIGITAL AUDIO IN jacks

You can enjoy the sound of your component with the digital optical output jack from the speakers of the system.

To the digital optical output jack of your component

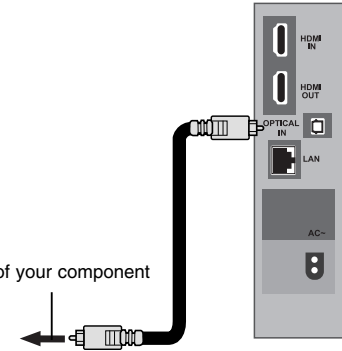

ON REMOTE

1 Connect the optical output jack of your component into the OPTICAL IN jack on the back of the wireless front right speaker.	-
2 Turn the power on:	⏻
3 Select the [OPTICAL] option:	RADIO (INPUT)
4 Turn down the volume:	VOL (+/-)
5 Turn your component on:	-
6 Adjust the volume:	VOL (+/-)

Reference

Controlling a TV with the Supplied Remote Control

You can control the volume, input source, and power state of your TV with the supplied Remote Control.

You can control your TV using the buttons below.

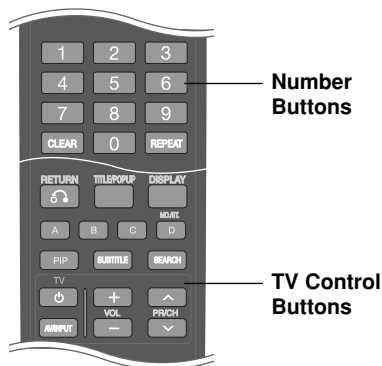

By pressing	You can
TV	Turn the TV on or off.
AV/INPUT	Switch the TV's input source between the TV and other input sources.
PR/CH \wedge/\vee	Scan up or down through memorized channels.
VOL +/-	Adjust the volume of the TV.

To program the remote to control the TV using the manufacturer code

If your TV is listed in the table on the next page, set the appropriate manufacturer code.

1. While holding down TV button, press the number buttons to select the manufacturer code for your TV (Refer to table on the next page).
 - If more than one code number is listed, try entering them one at a time until you find the one that works with your TV.
2. Release TV button.

Notes:

- Depending on your TV, some or all buttons may not function on the TV, even after entering the correct manufacturer code.
- If you enter a new code number, the code number previously entered will be erased.
- When you replace the batteries of the remote, the code number you have set may be reset to the default setting. Set the appropriate code number again.

Resetting the unit

If you observe any of the following symptoms.

- The unit is plugged in, but the power will not turn on or off.
- The front panel display is not working.
- The unit is not operating normally.

You can reset the unit as follows.

- Press and hold the button for at least five seconds. This will force the player to power off. Press the button again to turn the player back on.
- Unplug the power cord, wait at least five seconds, and then plug it in again.

Customer Support

You can update the Player using the latest software to enhance the products operation and/or add new features.

To obtain the latest software for this player (if updates have been made), please visit <http://lgservice.com> or contact LG Electronics customer care centre.

- Design and specifications are subject to change without notice.

Code numbers of controllable TVs

Manufacturer	Code Numbera
A MARK	112 143
ADMIRAL	072 081 161
AKAI	006 146
AMPRO	073 167
AMSTRAD	052
ANAM	026 043 054 056 080 104 108 112 115 118 121 131
AOC	004 006 058 112
BLAUPUNKT	088
CANDLE	002 003 004 006
CAPEHART	058
CETRONIC	043
CITIZEN	002 003 004 006 043 101 103 143
CLASSIC	043
CONCERTO	004
CONTEC	039 043 050 051
CORONADO	143
CRAIG	043 054
CROWN	043 143
CURTIS MATHES	004 006 101 116 143
CXC	043
DAEWOO	004 016 017 043 044 055 071 076 103 107 111 114 117 120 123 125 127 128 136 143
DAYTRON	004 116 143
DYNASTY	043
DYNATECH	062
ELECTROHOME	024 077 143
EMERSON	004 005 006 028 043 047 048 050 051 096 116 143 151 153 154 155
FISHER	007 057
FUNAI	028 043
FUTURETECH	043
GE	004 006 008 009 034 056 073 074 091 116 130 144 155 160 161 165
HALL MARK	004 116

Manufacturer	Code Numbera
HITACHI	004 006 009 010 011 012 023 041 075 143 158 163 166 187
INFINITY	164
INKEL	129
JBL	164
JCPENNY	004 006 008 009 024 030 065 101 143 156 160
JENSEN	013
JVC	034 038 070 083 145
KEC	043
KENWOOD	006 070
KLOSS	002 059
KMC	143
KTV	006 043 143 154
LG	001(Default code) 004 102 106 110 112 113 116 119 122 127 137 143
LODGENET	072
LOGIK	072
LUXMAN	004
LXI	007 015 052 081 160 164 166
MAGNAVOX	003 004 006 022 059 060 061 063 064 127 143 160 164
MARANTZ	006 077 164
MATSUI	164
MEMOREX	004 007 072 116
METZ	088
MGA	004 006 024 028 042 049 077 116
MINERVA	088
MINISUBISHI	004 006 024 028 040 042 109 116 124 146
MTC	004 006 062 101
NAD	015 025
NEC	006 007 016 019 024 040 056 130 132 134
NIKEI	043
ONKING	043
ONWA	043

Manufacturer	Code Numbera
OPTONICA	019 081
PADIO SHACK	004
PANASONIC	034 056 080 092 164
PHILCO	003 004 006 024 043 056 059 060 063 064 127 143 164
PHILIPS	003 004 005 006 038 059 070 093 143 160 164
PIONEER	006 018 023 025 027 116 135 176
PORTLAND	004 143
PROSCAN	144 160 161 165 167
PROTON	004 058 116 131 143 171 173
QUASAR	034 056 092
RADIO SHACK	019 043 047 116 127 143
RCA	004 006 023 024 056 065 074 144 152 156 160 161 165
REALISTIC	007 019 043 047
ROCTEC	186
RUNCO	168 169
SAMPO	004 006 058 116
SAMSUNG	004 050 089 101 105 113 116 127 133 137 143 160
SANYO	007 020 021 033 039 053 057 082 166
SCOTT	004 028 043 048 116 143
SEARS	004 007 015 028 030 057 082 094 101 116 143 160
SHARP	004 014 019 022 028 029 081 143 170 175
SIEMENS	088
SIGNATURE	072
SONY	041 070 079 085 126 139 147 185
SOUNDESIGN	003 004 028 043 116
SPECTRICON	112

Manufacturer	Code Numbera
SSS	004 043
SUPRE MACY	002
SYLVANIA	003 004 006 044 059 060 063 064 116 127 140 160 164
TANDY	081
TATUNG	056 062
TECHNICS	034 080 084
TECHWOOD	004
TEKNIKA	002 003 004 006 024 028 031 043 072 077 101 103 143
TELEFUNKEN	037 046 086 087
TELERENT	072
TERA	172
TMK	004 116
TOSHIBA	007 015 030 040 051 062 101 138
TOTEVISION	143
UNIVERSAL	008 009
VIDEO CONCEPTS	146
VIDIKRON	174
VIDTECH	004 116
WARDS	004 008 009 019 028 060 061 063 064 072 074 116 143 164
YAMAHA	004 006
YORK	004 116
YUPITERU	043
ZENITH	001 072 073 095 103 157
ZONDA	112

Language Codes

Use this list to input your desired language for Disc Audio, Disc Subtitle and Disc Menu.

Language	Code	Language	Code	Language	Code	Language	Code	Language	Code		
Afar	6565	Croatian	7282	Hausa	7265	Lingala	7678	Quechua	8185	Tajik	8471
Afrikaans	6570	Czech	6783	Hebrew	7387	Lithuanian	7684	Rhaeto-Romance	8277	Tamil	8465
Albanian	8381	Danish	6865	Hindi	7273	Macedonian	7775	Rumanian	8279	Telugu	8469
Ameharic	6577	Dutch	7876	Hungarian	7285	Malagasy	7771	Russian	8285	Thai	8472
Arabic	6582	English	6978	Icelandic	7383	Malay	7783	Samoan	8377	Tonga	8479
Armenian	7289	Esperanto	6979	Indonesian	7378	Malayalam	7776	Sanskrit	8365	Turkish	8482
Assamese	6583	Estonian	6984	Interlingua	7365	Maori	7773	Scots Gaelic	7168	Turkmen	8475
Aymara	6588	Faroese	7079	Irish	7165	Marathi	7782	Serbian	8382	Twí	8487
Azerbaijani	6590	Fiji	7074	Italian	7384	Moldavian	7779	Serbo-Croatian	8372	Ukrainian	8575
Bashkir	6665	Finnish	7073	Japanese	7465	Mongolian	7778	Shona	8378	Urdu	8582
Basque	6985	French	7082	Kannada	7578	Nauru	7865	Sindhi	8368	Uzbek	8590
Bengali; Bangla	6678	Frisian	7089	Kashmiri	7583	Nepali	7869	Singhalese	8373	Vietnamese	8673
Bhutani	6890	Galician	7176	Kazakh	7575	Norwegian	7879	Slovak	8375	Volapük	8679
Bihari	6672	Georgian	7565	Kirghiz	7589	Oriya	7982	Slovenian	8376	Welsh	6789
Breton	6682	German	6869	Korean	7579	Panjabi	8065	Spanish	6983	Wolof	8779
Bulgarian	6671	Greek	6976	Kurdish	7585	Pashto, Pushto	8083	Sudanese	8385	Xhosa	8872
Burmese	7789	Greenlandic	7576	Laotian	7679	Persian	7065	Swahili	8387	Yiddish	7473
Byelorussian	6669	Guarani	7178	Latin	7665	Polish	8076	Swedish	8386	Yoruba	8979
Chinese	9072	Gujarati	7185	Latvian, Lettish	7686	Portuguese	8084	Tagalog	8476	Zulu	9085

Area Codes

Choose an area code from this list.

Area	Code	Area	Code	Area	Code	Area	Code	Area	Code		
Afghanistan	AF	Costa Rica	CR	Greenland	GL	Maldives	MV	Paraguay	PY	Sri Lanka	LK
Argentina	AR	Croatia	HR	Hong Kong	HK	Mexico	MX	Philippines	PH	Sweden	SE
Australia	AU	Czech Republic	CZ	Hungary	HU	Monaco	MC	Poland	PL	Switzerland	CH
Austria	AT	Denmark	DK	India	IN	Mongolia	MN	Portugal	PT	Taiwan	TW
Belgium	BE	Ecuador	EC	Indonesia	ID	Morocco	MA	Romania	RO	Thailand	TH
Bhutan	BT	Egypt	EG	Israel	IL	Nepal	NP	Russian Federation	RU	Turkey	TR
Bolivia	BO	El Salvador	SV	Italy	IT	Netherlands	NL	Saudi Arabia	SA	Uganda	UG
Brazil	BR	Ethiopia	ET	Jamaica	JM	Netherlands Antilles	AN	Senegal	SN	Ukraine	UA
Cambodia	KH	Fiji	FJ	Japan	JP	New Zealand	NZ	Singapore	SG	United States	US
Canada	CA	Finland	FI	Kenya	KE	Nigeria	NG	Slovak Republic	SK	Uruguay	UY
Chile	CL	France	FR	Kuwait	KW	Norway	NO	Slovenia	SI	Uzbekistan	UZ
China	CN	Germany	DE	Libya	LY	Oman	OM	South Africa	ZA	Vietnam	VN
Colombia	CO	Great Britain	GB	Luxembourg	LU	Pakistan	PK	South Korea	KR	Zimbabwe	ZW
Congo	CG	Greece	GR	Malaysia	MY	Panama	PA	Spain	ES		

Troubleshooting

Symptom	Possible Cause	Correction
No power.	<ul style="list-style-type: none"> The power cord is disconnected. 	<ul style="list-style-type: none"> Plug the power cord into the wall outlet securely.
No picture.	<ul style="list-style-type: none"> The TV is not set to receive DVD signal output. 	<ul style="list-style-type: none"> Select the appropriate video input mode on the TV.
	<ul style="list-style-type: none"> The video cable is not connected securely. 	<ul style="list-style-type: none"> Connect the video cable securely.
	<ul style="list-style-type: none"> The selected resolution is not capable with your TV. 	<ul style="list-style-type: none"> Select another resolution using RESOLUTION button.
No sound.	<ul style="list-style-type: none"> The equipment connected with the audio cable is not set to receive disc signal output. 	<ul style="list-style-type: none"> Select the correct input mode of the audio receiver so you can listen to the sound from the player.
	<ul style="list-style-type: none"> The power of the equipment connected with the audio cable is turned off. 	<ul style="list-style-type: none"> Turn on the equipment connected with the audio cable.
	<ul style="list-style-type: none"> Check that the [MUTE] is displayed in the display window. 	<ul style="list-style-type: none"> Press MUTE again.
	<ul style="list-style-type: none"> The player is in reverse play, fast forward, slow motion or pause mode. 	<ul style="list-style-type: none"> Return to the normal playback.
The player does not start playback.	<ul style="list-style-type: none"> The disc is upside down. 	<ul style="list-style-type: none"> Insert the disc with the playback side down.
	<ul style="list-style-type: none"> An unplayable disc is inserted. 	<ul style="list-style-type: none"> Insert a playable disc. (Check the disc type and regional code.)
	<ul style="list-style-type: none"> The rating level is set. 	<ul style="list-style-type: none"> Change the rating level.
	<ul style="list-style-type: none"> The disc was recorded on another unit and was not finalized. 	<ul style="list-style-type: none"> Finalize the disc on that unit.
The Remote Control does not work properly.	<ul style="list-style-type: none"> The Remote Control is not pointed at the remote sensor on the player. 	<ul style="list-style-type: none"> Point the Remote Control at the remote sensor of the player.
	<ul style="list-style-type: none"> The Remote Control is too far from the player. 	<ul style="list-style-type: none"> Operate the Remote Control closer to the player.
The level meter is not displayed.	<ul style="list-style-type: none"> Check that the [NIGHT ON] is displayed in the display window. 	<ul style="list-style-type: none"> Press NIGHT again.
The lighting of the touch button is turned off.	<ul style="list-style-type: none"> Check that the [NIGHT ON] is displayed in the display window. 	<ul style="list-style-type: none"> Press NIGHT again.

Troubleshooting

Symptom	Possible Cause	Correction
BD-Live feature does not work.	<ul style="list-style-type: none"> External USB device is not connected. 	<ul style="list-style-type: none"> Connect a FAT16 or FAT32 formatted USB device to the USB port (see page 27).
	<ul style="list-style-type: none"> The connected USB device does not have enough space. 	<ul style="list-style-type: none"> Secure at least 1GB free space in the USB device for using BD-Live features.
	<ul style="list-style-type: none"> Internet connection is not established. 	<ul style="list-style-type: none"> Ensure that the unit is correctly connected to the local area network and can access the internet (see page 19-23 and 32).
	<ul style="list-style-type: none"> The [BD-LIVE connection] option in the [Setup] menu is set to [Prohibited]. 	<ul style="list-style-type: none"> Set the [BD-LIVE connection] option to [Permitted].
Streaming video services (such as YouTube, etc.) often stop or "buffer" during playback.	<ul style="list-style-type: none"> Your broadband service speed may not be fast enough to stream video services (such as YouTube, etc.) 	<ul style="list-style-type: none"> Contact your Internet Service Provider (ISP) and increase the broadband speed is recommended.
The YouTube ID is not automatically stored in the ID list.	<ul style="list-style-type: none"> The ID list is full. 	<ul style="list-style-type: none"> Delete one of the stored IDs and sign in with the ID again.
Shared folder or files from the media server are not displayed on the [My Media] menu.	<ul style="list-style-type: none"> The firewall or anti-virus software on your media server is running. The folders or files have been added or removed after a directory has been indexed already. 	<ul style="list-style-type: none"> Turn off the firewall or anti-virus software running on your media server. Rescan the shared folder on your media server.
The shared files from media server are not played on the [My Media] menu.	<ul style="list-style-type: none"> Shared file is not playable on the player. 	<ul style="list-style-type: none"> See "File compatibility" on page 48.
Radio stations cannot be tuned in.	<ul style="list-style-type: none"> The signal strength of the stations is too weak (when tuning in with automatic tuning). 	<ul style="list-style-type: none"> Use direct tuning.

Specifications

General

Power requirements:	Refer to main label.
Power consumption:	Refer to main label.
Operating temperature:	41 °F to 95 °F (5 °C to 35 °C)
Operating humidity:	5 % to 90 %

Inputs/Outputs

HDMI OUT (video/audio):	19 pin (HDMI standard, Type A)
HDMI IN (video/audio):	19 pin (HDMI standard, Type A)
DIGITAL IN (OPTICAL):	3 V (p-p), Optical jack x 1

Tuner FM

FM Tuning Range:	87.5 - 108.0 MHz
-------------------------	------------------

Amplifier

Stereo mode:	185 W + 185 W (4Ω at 1 KHz, THD 1 %)
Surround mode:	Left+Right: 185 W + 185 W (THD 1 %) Surround: 185 W + 185 W (4Ω at 1 KHz, THD 1 %) Subwoofer: 260 W (3Ω at 30 Hz, THD 1 %)

System

Laser:	Semiconductor laser, wavelength: 405 nm / 650 nm
Signal system:	Standard NTSC colour TV system
Frequency response:	20 Hz to 20 kHz (48 kHz, 96 kHz, 192 kHz sampling)
Signal-to-noise ratio:	More than 100 dB (ANALOG OUT connectors only)
Harmonic distortion:	Less than 0.008%
Dynamic range:	More than 95 dB
LAN port:	Ethernet jack x 1, 10BASE-T/100BASE-TX

Speakers

	Front right speaker	Front left Speaker	Rear Speaker	Passive Subwoofer
Type	2 Way 3speaker	2 Way 3speaker	2 Way 3speaker	1 Way 1 speaker
Impedance	4Ω	4Ω	4Ω	3Ω
Rated Input Power	185 W	185 W	185 W	260 W
Max. Input power	370 W	370 W	370 W	520 W
Net Dimensions (W x H x D)	340 x 1285 x 340 mm	340 x 1285 x 340 mm	290 x 1170 x 290 mm	180 x 436 x 392 mm
Net Weight	12.6 kg	11.6 kg	5.1 kg	7.6 kg

Wireless receiver

Power requirements	Refer to main label
Power consumption	Refer to main label
External dimensions (WxHxD)	64x213x252 mm
Net Weight	1 kg
Reception Output	5.8 GHz

Accessories

Speaker cable (2), Remote control (1), Battery (2), HDMI cable (1), Optical cable (1), Nero MediaHome4 Essentials software CD-ROM (1)

IMPORTANT INFORMATION RELATING TO NETWORK SERVICES

PLEASE READ CAREFULLY. USE OF THE NETWORK SERVICES IS SUBJECT TO THE FOLLOWING TERMS AND CONDITIONS.

Use of the Network Services requires an Internet connection which is sold separately and for which you are solely responsible. The Network Services may be limited or restricted depending upon the quality, capabilities and technical limitations of your Internet service.

The Network Services belong to third parties and may be protected by copyright, patent, trademark and/or other intellectual property laws. The Network Services are provided solely for your personal and noncommercial use. Unless expressly authorized by the respective content owner or service provider, you shall not modify, copy, republish, upload, post, transmit, translate, sell, create derivative works, exploit, or distribute in any manner or medium any content or services accessible through this product.

LG IS NOT RESPONSIBLE FOR YOUR USE OF THE NETWORK SERVICES. THE NETWORK SERVICES ARE PROVIDED "AS IS." TO THE FULLEST EXTENT PERMISSIBLE BY LAW, LG MAKES NO REPRESENTATIONS OR WARRANTIES OF ANY KIND WHATSOEVER (i) FOR THE ACCURACY, VALIDITY, TIMELINESS, LEGALITY, OR COMPLETENESS OF ANY NETWORK SERVICE MADE AVAILABLE THROUGH THIS PRODUCT; OR (ii) THAT THE NETWORK SERVICES ARE FREE OF VIRUSES OR OTHER COMPONENTS THAT MAY INFECT, HARM, OR CAUSE DAMAGE TO THIS PRODUCT, YOUR COMPUTER, TELEVISION, OTHER EQUIPMENT, OR ANY OTHER PROPERTY. LG EXPRESSLY DISCLAIMS ANY IMPLIED WARRANTIES, INCLUDING BUT NOT LIMITED TO, WARRANTIES OF MERCHANTABILITY OR FITNESS FOR A PARTICULAR PURPOSE.

UNDER NO CIRCUMSTANCES AND UNDER NO LEGAL THEORY, WHETHER IN CONTRACT, TORT, STRICT LIABILITY OR OTHERWISE, SHALL LG BE LIABLE TO YOU OR ANY THIRD PARTY FOR ANY DIRECT, INDIRECT, INCIDENTAL, SPECIAL, STATUTORY, CONSEQUENTIAL OR OTHER DAMAGES OR ATTORNEY FEES OR EXPENSES RELATING TO OR ARISING OUT OF THE NETWORK SERVICES EVEN IF ADVISED OF THE POSSIBILITY OF SUCH DAMAGES OR IF SUCH DAMAGES COULD HAVE BEEN REASONABLY FORESEEN.

The Network Services may be terminated or interrupted at any time, and LG makes no representation or warranty that any Network Service will remain available for any period of time. Use of the Network Services may be subject to additional terms and conditions of the respective third party service provider. The Network Services are transmitted by third parties by means of networks and transmission facilities over which LG has no control. LG EXPRESSLY DISCLAIMS ANY RESPONSIBILITY OR LIABILITY FOR ANY INTERRUPTION OR SUSPENSION OF ANY NETWORK SERVICE.

LG shall be neither responsible nor liable for customer service related to the Network Services. Any question or request should be made directly to the respective Network Service providers.

"Network Service(s)" means the third party services accessible through this product including but not limited to all data, software, links, messages, video and other content found thereon or used in connection therewith.

"LG" means LG Electronics, Inc. its parent company and all of their respective subsidiaries, affiliates and related companies worldwide.

Open source software notice

The following GPL executables and LGPL libraries used in this product are subject to the GPL2.0/LGPL2.1 License Agreements:

GPL EXECUTABLES: Linux kernel 2.6, bash, busybox, dhcpcd, mtd-utils, net-tools, procps, sysutils, tinylogin

LGPL LIBRARIES: uClibc, DirectFB, iconv, cairo, gnutls, libcrypt, libgpg-error, libusb

gSOAP Public License 1.3 LIBRARY: gsoap

LG Electronics offers to provide source code to you on CD-ROM for a charge covering the cost of performing such distribution, such as the cost of media, shipping and handling upon e-mail request to LG Electronics at: opensource@lge.com

This offer is valid for a period of three(3) years from the date of the distribution of this product by LG Electronics.

You can obtain a copy of the GPL, LGPL licenses from <http://www.gnu.org/licenses/old-licenses/gpl-2.0.html> and <http://www.gnu.org/licenses/old-licenses/lgpl-2.1.html> .

Also you can obtain a copy of gSOAP public license from <http://www.cs.fsu.edu/~engelen/license.html>.

This software is based in part on the work of the Independent JPEG Group copyright © 1991 - 1998, Thomas G. Lane.

This product includes

- Freetype library : copyright © 2003 The FreeType Project (www.freetype.org).
- libpng library : copyright © 2004 Glenn Randers-Pehrson
- Zlib compression library: Copyright © 1995-2002 Jean-loup Gailly and Mark Adler.
- Expat library : copyright © 2006 expat maintainers.
- OpenSSL library :
 - cryptographic software written by Eric Young (ey@cryptsoft.com).
 - software written by Tim Hudson (tjh@cryptsoft.com).
 - software developed by the OpenSSL Project for use in the OpenSSL Toolkit. (<http://www.openssl.org>)

- libcurl library : Copyright © 1996 - 2008, Daniel Stenberg, daniel@haxx.se
- boost C++ library : © Copyright Beman Dawes 1999-2003
- UPnP SDK : Copyright © 2000-2003 Intel Corporation
- Libnet : © 1998 - 2004 Mike D. Schiffman mike@infonexus.com
- Libpcap

This product includes other open source software.

- Copyright © David L. Mills 1992-2006
 - Copyright © 1998-2003 Daniel Veillard.
 - Copyright © 1998, 1999 Thai Open Source Software Centre Ltd.
 - Copyright © 1990 The Regents of the University of California.
 - Copyright © 1998-2005 The OpenSSL Project.
 - Copyright © 1991, 1992 Paul Kranenburg <pk@cs.few.eur.nl>
 - Copyright © 1993 Branko Lankester <branko@hacktic.nl>
 - Copyright © 1993 Ulrich Pegelow <pegelow@moorea.uni-muenster.de>
 - Copyright © 1995, 1996 Michael Elizabeth Chastain <mec@duracef.shout.net>
 - Copyright © 1993, 1994, 1995, 1996 Rick Sladkey <jrs@world.std.com>
 - Copyright © 1999,2000 Wichert Akkerman <wakkerma@debian.org>
- All rights reserved.

Permission is hereby granted, free of charge, to any person obtaining a copy of this software and associated documentation files (the "Software"), to deal in the Software without restriction, including without limitation the rights to use, copy, modify, merge, publish, distribute, sublicense, and/or sell copies of the Software, and to permit persons to whom the Software is furnished to do so, subject to the following conditions:

THE SOFTWARE IS PROVIDED "AS IS", WITHOUT WARRANTY OF ANY KIND, EXPRESS OR IMPLIED, INCLUDING BUT NOT LIMITED TO THE WARRANTIES OF MERCHANTABILITY, FITNESS FOR A PARTICULAR PURPOSE AND NONINFRINGEMENT. IN NO EVENT SHALL THE AUTHORS OR COPYRIGHT HOLDERS BE LIABLE FOR ANY CLAIM, DAMAGES OR OTHER LIABILITY, WHETHER IN AN ACTION OF CONTRACT, TORT OR OTHERWISE, ARISING FROM, OUT OF OR IN CONNECTION WITH THE SOFTWARE OR THE USE OR OTHER DEALINGS IN THE SOFTWARE.



LG Customer Information Center

1-888-542-2623 CANADA

Register your product Online!

www.lg.com

