

Model	VB78**H**/VB78**NH**		
Language	English		
Page	10	Color(cover/body)	2/1
Material	Weight 100g	Size(W*H)	150 x 220(mm)
Date	2009.06.09	Designer	Yangfan
Part No.	MFL42248104	Description	Owner's manual

### Chage Record

No.	Change content	ECO No.	Date	Designer	Confirm
①	change web site as marketing request	ACTT003937	100526	Y.F	CUIYT
②					
③					
④					
⑤					
⑥					
⑦					
⑧					
⑨					

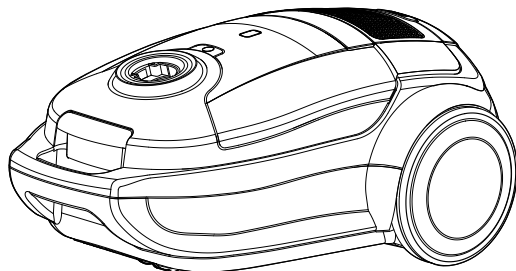

**VB78\*\*H\*\***

**VB78\*\*NH\*\***

**E | English**

## Basic Parts

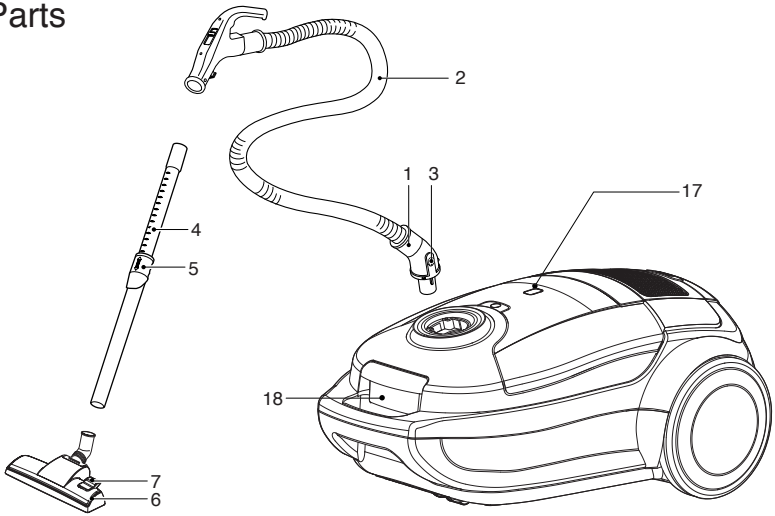

## Optional Parts

- The different figure and quantity of the following part depend on the different models which you have bought.

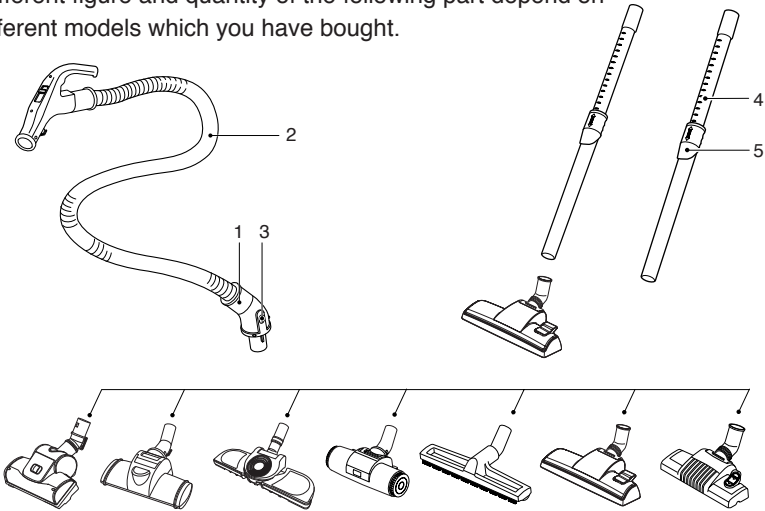

## Accessory

- These specifications are subject to change according to the agent / buyer's request.

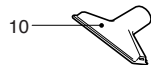
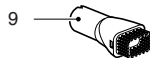

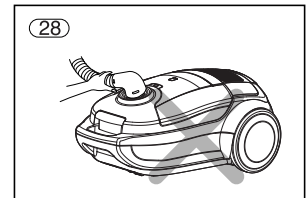
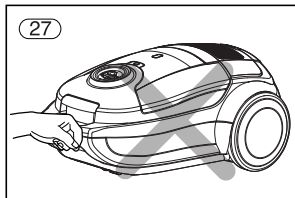
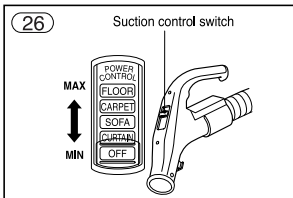
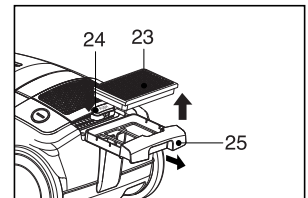
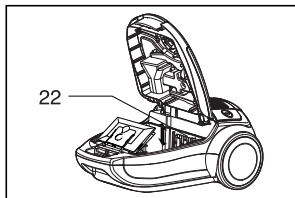
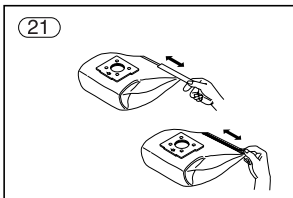
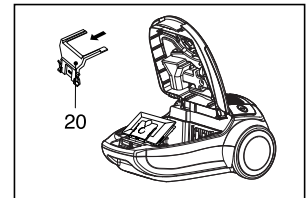
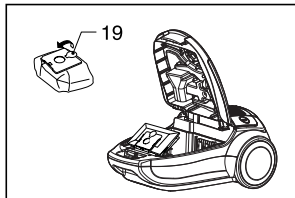
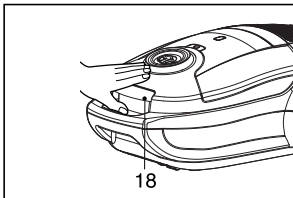
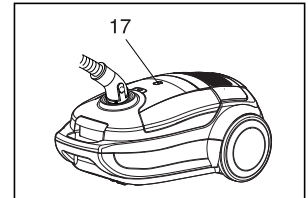
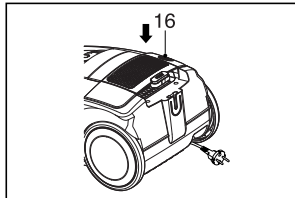
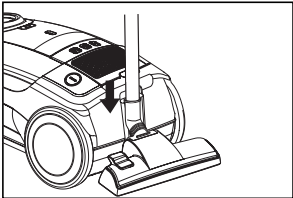
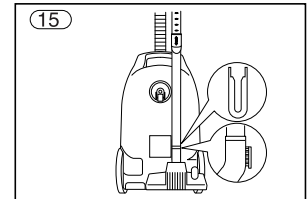
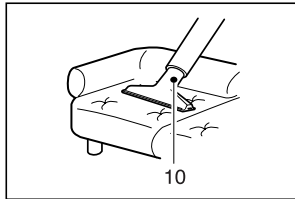
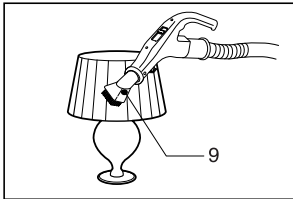
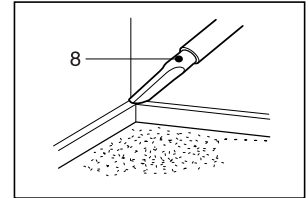
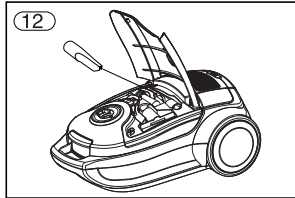
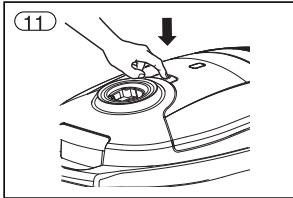
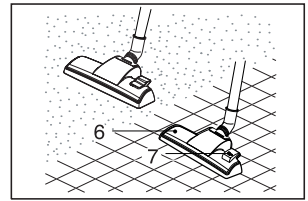
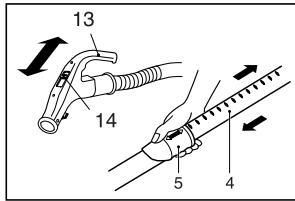
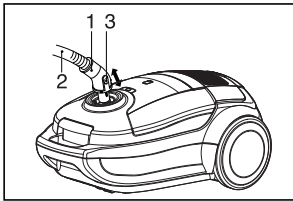

# IMPORTANT SAFETY INSTRUCTIONS

Read and follow all instructions before using your vacuum cleaner to prevent the risk of fire, electric shock, personal injury, or damage when using the vacuum cleaner. This guide does not cover all possible conditions that may occur. Always contact your service agent or manufacturer about problems that you do not understand. This appliance complies with the following ECDirectives :-73/23/EEC, 93/68/EEC-Low Voltage Directive-89/336EEC -EMC Directive.



This is the safety alert symbol.

This symbol alerts you to potential hazards that can kill or hurt you and others.

All safety messages will follow the safety alert symbol and either the word "WARNING" or "CAUTION." These words mean:



**WARNING**

This symbol will alert you to hazards or unsafe practices which could cause serious bodily harm or death.



**CAUTION**

This symbol will alert you to hazards or unsafe practices which could cause bodily injury or property damage.



**WARNING**

- **Disconnect electrical supply before servicing or cleaning the unit or when cleaner is not in use.**

Failure to do so could result in electrical shock or personal injury.

- **Do not use vacuum cleaner to pick up anything that is burning or smoking such as cigarettes, or hot ashes.**

Doing so could result in death, fire or electrical shock.

- **Do not vacuum flammable or explosive substances such as gasoline, benzene, thinners, propane (liquids or gases).**

The fumes from these substances can create a fire hazard or explosion. Doing so could result in death or personal injury.

- **Do not handle plug or vacuum cleaner with wet hands.**

Doing so could result in death or electrical shock.

- **Do not unplug by pulling on cord.**

Doing so could result in product damage or electrical shock. To unplug, grasp the plug, not the cord.

- **Keep hair, loose clothing, fingers, and all parts of the body away from openings and moving parts.**

Failure to do so could result in electrical shock or personal injury.

- **Do not pull or carry by cord, use cord as a handle, close a door on cord, or pull cord around sharp edges or corners. Do not run vacuum cleaner over cord. Keep cord away from heated surfaces.**

Failure to do so could result in electrical shock or personal injury or fire or product damage.

- **Do not allow to be used as toy. Close attention is necessary when used by or near children.**

Personal injury or product damage could result.

- **Do not use the vacuum cleaner if the power cord or plug is damaged or faulty.**

Personal injury or product damage could result. In these cases, contact LG Electronics Service Agent to avoid hazard.

- **Do not use vacuum cleaner if it has been under water.**

Personal injury or product damage could result. In these cases, contact LG Electronics Service Agent to avoid hazard.



## WARNING

- **Do not continue to vacuum if any parts appear missing or damaged.**

Personal injury or product damage could result. In these cases, contact LG Electronics Service Agent to avoid hazard.

- **Do not use an extension cord with this vacuum cleaner**

Fire hazard or product damage could result.

- **Using proper voltage.**

Using improper voltage may result in damage to the motor and possible injury to the user. Proper voltage is listed on the bottom of vacuum cleaner.

- **Turn off all controls before unplugging.**

Failure to do so could result in electrical shock or personal injury.

- **Do not change the plug in any way.**

Failure to do so could result in electrical shock or personal injury or product damage. Doing so result in death. If plug does not fit, contact a qualified electrician to install the proper outlet.

- **Repairs to electrical appliances may only be performed by qualified service engineers.**

Improper repairs may lead to serious hazards for the user.

- **Do not plug in if control knob is not in OFF position.**

Personal injury or product damage could result. (Depending on model)

- **Keep children away and beware of obstructions when rewinding the cord to prevent personal injury.**

The cord moves rapidly when rewinding. (Depending on model)

- **The hose contains electrical wires. Do not use it if it is damaged, cut or punctured.**

Failure to do so could result in death, or electrical shock. (Depending on model)

# IMPORTANT SAFETY INSTRUCTIONS



## CAUTION

- **Do not put any objects into openings.**  
Failure to do so could result in product damage.
- **Do not use with any opening blocked: keep free of dust, lint, hair, and anything that may reduce air flow.**  
Failure to do so could result in product damage.
- **Do not use vacuum cleaner without dust tank and/or filters in place.**  
Failure to do so could result in product damage.
- **Do not use vacuum cleaner to pick up sharp hard objects, small toys, pins, paper clips, etc.**  
They may damage the cleaner or dust bin.
- **Store the vacuum cleaner indoors.**  
Put the vacuum cleaner away after use to prevent tripping over it.
- **The vacuum cleaner is not intended to use by young children or infirm people without supervision.**  
Failure to do so could result in personal injury or product damage.
- **Only use parts produced or recommended by LG Electronics Service Agents.**  
Failure to do so could result in product damage.
- **Use only as described in this manual. Use only with LG recommended or approved attachments and accessories.**  
Failure to do so could result in personal injury or product damage.
- **To avoid personal injury and to prevent the machine from falling when cleaning stairs, always place it at the bottom of stairs.**  
Failure to do so could result in personal injury or product damage.
- **Use accessory nozzles in sofa mode.**  
Failure to do so could result in product damage.
- **Make sure the filters (exhaust filter and motor safety filter) are completely dry before replacing in the machine.**  
Failure to do so could result in product damage.
- **Do not dry the filter in an oven or microwave.**  
Failure to do so could result in fire hazard.
- **Do not dry the filter in a clothes dryer.**  
Failure to do so could result in fire hazard.
- **Do not dry near an open flame.**  
Failure to do so could result in fire hazard.
- **Always clean the dust bin after vacuuming carpet cleaners or fresheners, powders and fine dust.**  
  
These products clog the filters, reduce airflow and can cause damage to the cleaner. Failure to clean the dust bin could cause permanent damage to the cleaner. (Depending on model)
- **Don't grasp the tank handle when you are moving the vacuum cleaner.**  
The vacuum cleaner's body may fall when separating tank and body. Personal injury or product damage could result. **You should grasp the carrier handle** when you are removing the vacuum cleaner. (Depending on model)
- **If after emptying the dust tank the indicator light is on (red), clean the dust tank.**  
Failure to do so could result in product damage. (Depending on model)

# IMPORTANT SAFETY INSTRUCTIONS



## CAUTION

### **Thermal protector :**

This vacuum cleaner has a special thermostat that protects the vacuum cleaner in case of motor overheating. If the vacuum cleaner suddenly shuts off, turn off the switch and unplug the vacuum cleaner. Check the vacuum cleaner for possible source of overheating such as a full dust tank, a blocked hose or clogged filter. If these conditions are found, fix them and wait at least 30 minutes before attempting to use the vacuum cleaner. After the 30 minute period, plug the vacuum cleaner back in and turn on the switch.

## How to Use

### Connecting the flexible hose

Push the end of the head (1) on the flexible hose (2) into the attachment point on the vacuum cleaner.

To remove the flexible hose from the vacuum cleaner, press on the button (3) situated on the head, then pull upwards.

### Assembling the tubes

(depending on model)

#### • Telescopic tube (4)

- Push spring latch (5) forward.
- Pull out tube to required length.
- Release spring latch to lock.

### Using the cleaning head and Accessory

#### Nozzles (depending on model)

Fit the large cleaning head onto the end of the tube.

- **The 2 position head (6)** is equipped with a pedal (7) which allows you to alter its position according to the type of floor to be cleaned.

**Hard floor position** (tiles, parquet floors...). Press on the pedal to lower the brush.

**Carpet or rug position.** Press on the pedal to lift the brush up.

#### • Crevice Tool (8)

For vacuuming in those normally inaccessible places i.e. reaching cobwebs, or down the side of a sofa!

#### • Dusting brush (9)

For vacuuming picture frames furniture outlines, books and other uneven objects.

#### • Upholstery Nozzle (10)

For vacuuming upholstery, mattresses, etc. The thread collectors help to pick up the threads and fluff.

### How to plug in and use

Pull out the supply cord to the desired length and plug into the socket.

### Electronic power control

Suction capacity increases steplessly up to MAX.

### Adjusting the power level

- The flexible hose handle (13) has a manual air flow regulator (14) which allows you to briefly reduce the suction level.

### Storage (15)

When you have switched off and unplugged the appliance, press on the button (16) to automatically rewind the cord.

You can move or store your appliance in a vertical position by sliding the hook on the large cleaning head into the clip on the underside of the appliance.

### Changing the dust bag

The dustbag needs changing when the cleaner is set to maximum power and the cleaner heads off the floor but the "bag full" indicator window (17) is completely coloured red.

Even if the dustbag does not appear to be full at this stage, it should be changed.

It could be that a great deal of very fine dust has clogged up the pores of the dust bag.

- Turn off the appliance and unplug it.
- Open the cover by pressing the hook (18) and lifting it up until it snaps into place.

Your appliance is equipped with either a paper dust bag (19) or a fabric dust bag (21) (depending on model).

- Take hold of the dust bag by the handle and pull. Remove the bag and throw it away.
- To refit a new bag push the cardboard support of a new bag into the bag mount (20) until it will go no further.

**If your appliance is fitted with a fabric dust bag** follow the same instructions as above.

Empty it and replace it (21).

**Note:** as the appliance is fitted with a safety device which checks that the bag is in place you cannot close the lid if the bag is not fitted correctly.

### Cleaning the motor filter

The motor filter is situated inside the appliance between the dust bag and the motor. Each time that you change the air outlet filter we advise you to remove the motor filter **(22)** and to clean it by tapping to remove the dirt and then replacing it in the vacuum cleaner.

### Changing the air outlet filter

- Depending on the model you Should press the HEPA locker **(24)**, then remove the HEPA filter **(23)** from the HEPA frame **(25)** and Clean it.
- Cleaning the washable HEPA filter with water at least once a year.

### WARNING

Please never close the Filter Cover like **(27)**, To avoid nipping your hand.

Please do not hold the hose when we lift the main body off the floor **(28)**.

### What to do if your appliance does not work?

Check that the appliance is correctly plugged in and that the electrical socket is working.

### What to do when the suction performance reduces?

- Stop the appliance and unplug it.
- Check that the tubes, flexible hose and cleaning tool are not blocked.
- Check that the dust bag is not full. Replace if necessary.



**LG Electronics Inc.**

<http://www.lg.com>