



LG

Life's Good

ENGLISH

OWNER'S MANUAL

Real Surround Blu-ray 3D™ / DVD Home Theater System

Please read this manual carefully before operating your set and retain it for future reference.

MODEL

HX995TZ (HX995TZ/ SX95TZ-S/C/D)

P/NO : MFL65220893

1 Safety Information

1 Safety Information



CAUTION: TO REDUCE THE RISK OF ELECTRIC SHOCK DO NOT REMOVE COVER (OR BACK) NO USER-SERVICEABLE PARTS INSIDE REFER SERVICING TO QUALIFIED SERVICE PERSONNEL.



This lightning flash with arrowhead symbol within an equilateral triangle is intended to alert the user to the presence of uninsulated dangerous voltage within the product's enclosure that may be of sufficient magnitude to constitute a risk of electric shock to persons.



The exclamation point within an equilateral triangle is intended to alert the user to the presence of important operating and maintenance (servicing) instructions in the literature accompanying the product.

Cautions and Warnings

WARNING: TO PREVENT FIRE OR ELECTRIC SHOCK HAZARD, DO NOT EXPOSE THIS PRODUCT TO RAIN OR MOISTURE.

WARNING: Do not install this equipment in a confined space such as a book case or similar unit.



CAUTION: Do not block any ventilation openings. Install in accordance with the manufacturer's instructions.

Slots and openings in the cabinet are provided for ventilation and to ensure reliable operation of the product and to protect it from over heating. The openings shall be never be blocked by placing the product on a bed, sofa, rug or other similar surface. This product shall not be placed in a built-in installation such as a bookcase or rack unless proper ventilation is provided or the manufacturer's instruction has been adhered to.

CAUTION: This product employs a Laser System. To ensure proper use of this product, please read this owner's manual carefully and retain it for future reference. Shall the unit require maintenance, contact an authorized service Centre.

Use of controls, adjustments or the performance of procedures other than those specified herein may result in hazardous radiation exposure.

To prevent direct exposure to laser beam, do not try to open the enclosure. Visible laser radiation when open. **DO NOT STARE INTO BEAM.**

CAUTION concerning the Power Cord

Most appliances recommend they be placed upon a dedicated circuit;

That is, a single outlet circuit which powers only that appliance and has no additional outlets or branch circuits. Check the specification page of this owner's manual to be certain. Do not overload wall outlets. Overloaded wall outlets, loose or damaged wall outlets, extension cords, frayed power cords, or damaged or cracked wire insulation are dangerous. Any of these conditions could result in electric shock or fire. Periodically examine the cord of your appliance, and if its appearance indicates damage or deterioration, unplug it, discontinue use of the appliance, and have the cord replaced with an exact replacement part by an authorized service centre. Protect the power cord from physical or mechanical abuse, such as being twisted, kinked, pinched, closed in a door, or walked upon. Pay particular attention to plugs, wall outlets, and the point where the cord exits the appliance. To disconnect power from the mains, pull out the mains cord plug. When installing the product, ensure that the plug is easily accessible.

This device is equipped with a portable battery or accumulator.

Safety way to remove the battery or the battery from the equipment:

Remove the old battery or battery pack, follow the steps in reverse order than the assembly. To prevent contamination of the environment and bring on possible threat to human and animal health, the old battery or the battery put it in the appropriate container at designated collection points. Do not dispose of batteries or battery together with other waste. It is recommended that you use local, free reimbursement systems batteries and accumulators. The battery shall not be exposed to excessive heat such as sunshine, fire or the like.

CAUTION: The apparatus shall not be exposed to water (dripping or splashing) and no objects filled with liquids, such as vases, shall be placed on the apparatus.

Disposal of your old appliance



1. When this crossed-out wheeled bin symbol is attached to a product it means the product is covered by the European Directive 2002/96/EC.
2. All electrical and electronic products shall be disposed of separately from the municipal waste stream via designated collection facilities appointed by the government or the local authorities.
3. The correct disposal of your old appliance will help prevent potential negative consequences for the environment and human health.
4. For more detailed information about disposal of your old appliance, please contact your city office, waste disposal service or the shop where you purchased the product.

Europe Notice**CE0678** 

LG Electronics hereby declares that this product is in compliance with the essential requirements and other relevant provisions of Directive 1999/5/EC, EMC Directive 2004/108/EC, Low Voltage Directive 2006/95/EC, and ErP Directive 2009/125/EC.

Please contact to the following address for obtaining a copy of the DoC (Declaration of Conformity).

European representative :

LG Electronics Service Europe B.V.
Veluwezoom 15, 1327
AE Almere. The Netherlands
(Tel : +31-(0)36-547-8888)

Indoor Use Only

RF Radiation Exposure Statement

This equipment should be installed and operated with minimum distance 20 cm between the radiator and your body.

France Notice**Pour la France métropolitaine**

2.400 - 2.4835 GHz (Canaux 1 à 13) autorisé en usage intérieur

2.400 - 2.454 GHz (canaux 1 à 7) autorisé en usage extérieur

Pour la Guyane et la Réunion

2.400 - 2.4835 GHz (Canaux 1 à 13) autorisé en usage intérieur

2.420 - 2.4835 GHz (canaux 5 à 13) autorisé en usage extérieur

Italy Notice

A general authorization is requested for outdoor use in Italy.

The use of these equipments is regulated by:

1. D.L.gs 1.8.2003, n. 259, article 104 (activity subject to general authorization) for outdoor use and article 105 (free use) for indoor use, in both cases for private use.
2. D.M. 28.5.03, for supply to public of RLAN access to networks and telecom services.

L'uso degli apparati è regolamentato da:

1. D.L.gs 1.8.2003, n. 259, articoli 104 (attività soggette ad autorizzazione generale) se utilizzati al di fuori del proprio fondo e 105 (libero uso) se utilizzati entro il proprio fondo, in entrambi i casi per uso private.
2. D.M. 28.5.03, per la fornitura al pubblico dell'accesso R-LAN alle reti e ai servizi di telecomunicazioni.

Brazil Notice

Este equipamento opera em caráter secundário, isto é, não tem direito a proteção contra interferência prejudicial, mesmo de estações do mesmo tipo, e não pode causar interferência a sistemas operando em caráter primário.

Latvia Notice

A license is required for outdoor use for operation in 2.4 GHz band.

Notes on Copyrights

- Because AACCS (Advanced Access Content System) is approved as content protection system for BD format, similar to use of CSS (Content Scramble System) for DVD format, certain restrictions are imposed on playback, analogue signal output, etc., of AACCS protected contents. The operation of this product and restrictions on this product may vary depending on your time of purchase as those restrictions may be adopted and/or changed by AACCS after the production of this product.
- Furthermore, BD-ROM Mark and BD+ are additionally used as content protection systems for BD format, which imposes certain restrictions including playback restrictions for BD-ROM Mark and/or BD+ protected contents. To obtain additional information on AACCS, BD-ROM Mark, BD+, or this product, please contact an authorized Customer Service Centre.
- Many BD-ROM/DVD discs are encoded with copy protection. Because of this, you should only connect your player directly to your TV, not to a VCR. Connecting to a VCR results in a distorted picture from copy-protected discs.
- This product incorporates copyright protection technology that is protected by U.S. patents and other intellectual property rights. Use of this copyright protection technology must be authorized by Rovi, and is intended for home and other limited viewing uses only unless otherwise authorized by Rovi. Reverse engineering or disassembly is prohibited.
- Under the U.S. Copyright laws and Copyright laws of other countries, unauthorized recording, use, display, distribution, or revision of television programmes, videotapes, BD-ROM discs, DVDs, CDs and other materials may subject you to civil and/or criminal liability.

Important Notice for TV colour system

The colour system of this player differs according to currently playing discs.

For example, when the player plays the disc recorded in the NTSC colour system, the image is output as an NTSC signal.

Only the multi system colour TV can receive all signals output from the player.

- If you have a PAL colour system TV, you will see just distorted images when using discs or video contents recorded in NTSC.
- The multi system colour TV changes the colour system automatically according to input signals. In case that the colour system is not changed automatically, turn it off and then on to see normal images on screen.
- Even if the disc recorded in NTSC colour system are well displayed on your TV, these may not be recorded correctly on your recorder.

Contents

1

Safety Information

- 2 Cautions and Warnings

2

Preparation

- 8 **Introduction**
- 8 About the "⊘" Symbol Display
- 8 Symbols Used in this Manual
- 9 Supplied Accessories
- 10 Playable Discs
- 11 File compatibility
- 12 Regional Code
- 12 AVCHD (Advanced Video Codec High Definition)
- 12 Certain System Requirements
- 12 Compatibility Notes
- 13 **Remote control**
- 14 **Player (Front)**
- 15 **Player (Rear)**
- 16 **Active woofer**

3

Installation

- 17 **Installing the player**
- 17 Assembling the player with stand
- 19 Mounting the player on a wall
- 21 **Assembling the speaker**
- 23 **Mounting the speakers on a wall**
- 24 **Positioning the system**
- 25 **Speaker Connection**
- 25 Wireless connection
- 25 Wireless connection for manually
- 25 Attaching the speakers
- 26 **Connecting to Your TV**
- 26 HDMI Connection
- 27 What is SIMPLINK?
- 28 Video Connection
- 28 Resolution Setting
- 29 **Antenna connection**
- 29 **Connections with external device**
- 29 PORT. IN connection
- 30 OPTICAL IN connection
- 30 HDMI IN 1/2 connection
- 31 **Connecting to your Home Network**
- 31 Wired network connection
- 32 Wired Network Setup
- 33 Wireless Network Connection
- 34 Wireless Network Setup
- 37 **USB device connection**
- 38 **Settings**
- 38 Adjust the Setup Settings
- 38 [DISPLAY] Menu
- 40 [LANGUAGE] Menu
- 40 [AUDIO] Menu

- 42 [LOCK] Menu
- 43 [NETWORK] Menu
- 43 [OTHERS] Menu
- 45 Sound Effect

4 Operation

- 46 General Playback
- 50 Advanced Playback
- 53 On-Screen display
- 56 Enjoying BD-Live™
- 57 Playing a movie file and VR disc
- 59 Viewing a photo
- 61 Listening to music
- 65 Playing the iPod
- 66 Radio Operations
- 67 Playing content via your home network
- 72 Using NetCast™ Entertainment Access
 - 72 YouTube
 - 76 Picasa Web Albums
 - 79 Using the AccuWeather

5 Maintenance

- 81 Notes on Discs
- 81 Handling the Unit

6 Troubleshooting

- 82 General
- 83 Picture
- 83 Sound
- 84 Network

7 Appendix

- 85 Controlling a TV with the Supplied Remote Control
- 86 Area Code List
- 87 Language code List
- 88 Network Software Update
 - 88 Network update notification
 - 88 Software Update
- 90 Video output resolution
- 91 Trademarks and Licences
- 93 Specifications
- 95 Important Information Relating to Network Services
- 96 Open source software notice
- 97 Gracenote® End User Licence Agreement

1

2

3

4

5

6

7

8

2 Preparation



Preparation

Introduction

About the “⊘” Symbol Display

“⊘” may appear on your TV display during operation and indicates that the function explained in this owner’s manual is not available on that specific media.

Symbols Used in this Manual



NOTE

Indicates special notes and operating features.



CAUTION

Indicates cautions for preventing possible damages from abuse.

A section whose title has one of the following symbols are applicable only to the disc represented by the symbol.

BD	BD-ROM disc
DVD	DVD-Video, DVD±R/RW in Video mode or VR mode and finalized
AVCHD	DVD±R/RW in AVCHD format
ACD	Audio CDs
MOVIE	Movie files
MUSIC	Music files
PHOTO	Photo files

Supplied Accessories

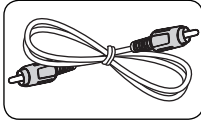

Video cable (1)

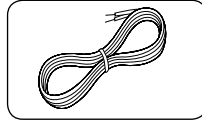

Speaker Cables (5)



Remote control (1)

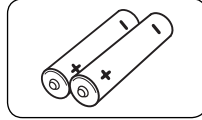

Batteries (2)



FM antenna (1)

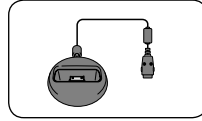

iPod cradle (1)

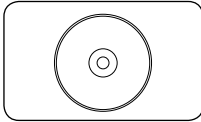
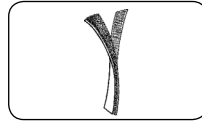
Nero MediaHome4
Essentials software
CD-ROM (1)

Velcro (1)

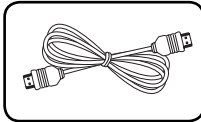

HDMI cable (1)

For Mounting (speakers)

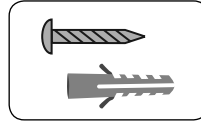
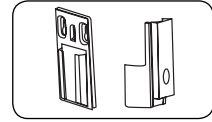
Screw/ Wall plug
(Wall mounting) (8)Wall Mount Bracket
(Wall/ Speaker) (4)

For standing (player)

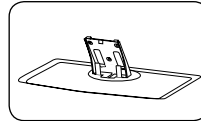

Stand (1)

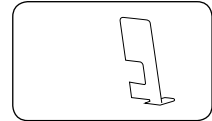

Rear cover (1)

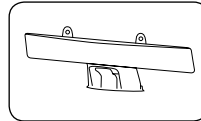

cable cover (1)

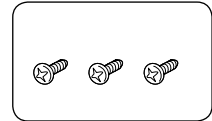

Middle screws (3)

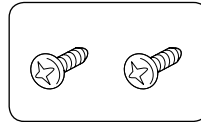

Big screws (2)



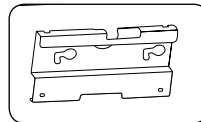



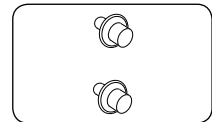

For Mounting (player)



Bracket (1)

Screws for mounting
(2)

Playable Discs

	<p>Blu-ray Disc™</p> <ul style="list-style-type: none"> - Discs such as movies that can be purchased or rented. - BD-R/RE discs that contain Movie, Music or Photo files. - "Blu-ray 3D™" discs and "Blu-ray 3D™ ONLY" discs
	<p>DVD-VIDEO (8 cm / 12 cm disc)</p> <p>Discs such as movies that can be purchased or rented.</p>
 	<p>DVD±R (8 cm / 12 cm disc)</p> <ul style="list-style-type: none"> - Video mode and finalized only - Supports the dual layer disc also - Finalized AVCHD format - DVD±R discs that contain Movie, Music or Photo files.
	<p>DVD-RW (8 cm / 12 cm disc)</p> <ul style="list-style-type: none"> - VR mode, Video mode and finalized only - Finalized AVCHD format - DVD-RW discs that contain Movie, Music or Photo files.
	<p>DVD+RW (8 cm / 12 cm disc)</p> <ul style="list-style-type: none"> - Video mode and finalized only - Finalized AVCHD format - DVD+RW discs that contain Movie, Music or Photo files.
	<p>Audio CD (8 cm / 12 cm disc)</p>
	<p>CD-R/RW (8 cm / 12 cm disc)</p> <p>CD-R/RW discs that contain audio titles, Movie, Music or Photo files.</p>

! **NOTE**

- Depending on the conditions of the recording equipment or the CD-R/RW (or DVD±R/RW) disc itself, some CD-R/RW (or DVD±R/RW) discs cannot be played on the unit.
- Depending on the recording software & the finalization, some recorded discs (CD-R/RW, DVD±R/RW, BD-R/RE) may not be playable.
- BD-R/RE, DVD±R/RW and CD-R/RW discs recorded using a personal computer or a DVD or CD Recorder may not play if the disc is damaged or dirty, or if there is dirt or condensation on the player's lens.
- If you record a disc using a personal computer, even if it is recorded in a compatible format, there are cases in which it may not play because of the settings of the application software used to create the disc. (Check with the software publisher for more detailed information.)
- This player requires discs and recordings to meet certain technical standards in order to achieve optimal playback quality.
- Pre-recorded DVDs are automatically set to these standards. There are many different types of recordable disc formats (including CD-R containing MP3 or WMA files) and these require certain pre-existing conditions to ensure compatible playback.
- Customers should note that permission is required in order to download MP3 / WMA files and music from the Internet. Our company has no right to grant such permission. Permission should always be sought from the copyright owner.
- You have to set the disc format option to [Mastered] in order to make the discs compatible with the LG players when formatting rewritable discs. When setting the option to Live System, you cannot use it on LG player. (Mastered/Live File System : Disc format system for windows Vista)

File compatibility

Overall

Available File extensions:

“.jpg”, “.jpeg”, “.png”, “.avi”, “.divx”, “.mpg”, “.mpeg”, “.mkv”, “.mp4”, “.mp3”, “.wma”, “.wav”

- Available file extensions differ depending on the DLNA servers.
- Some “.wav” files are not supported on this player.
- The file name is limited to 180 characters.
- Depending on the size and number of the files, it may take several minutes to read the contents on the media.

Maximum Files/Folder: Less than 2 000 (total number of files and folders)

CD-R/RW, DVD±R/RW, BD-R/RE Format:

ISO 9660+JOLIET, UDF and UDF Bridge format

MOVIE

Available resolution size:

1 920 x 1 080 (W x H) pixels

Playable subtitle: SubRip (.srt / .txt), SAMI (.smi), SubStation Alpha (.ssa/.txt), MicroDVD (.sub/.txt), VobSub (.sub), SubViewer 1.0 (.sub), SubViewer 2.0 (.sub/.txt), TMLPlayer (.txt), DVD Subtitle System (.txt)

- VobSub (.sub) is not available in the [Home Link] feature.

Playable Codec format: “DIVX3.xx”, “DIVX4.xx”, “DIVX5.xx”, “XVID”, “DIVX6.xx” (Standard playback only), H.264/MPEG-4 AVC, MPEG1 SS, MPEG2 PS, MPEG2 TS

Playable Audio format: “Dolby Digital”, “DTS”, “MP3”, “WMA”, “AAC”, “AC3”

- Not all the WMA and AAC Audio formats are compatible with this unit.

Sampling frequency:

between 32 kHz to 48 kHz (WMA),
between 16 kHz to 48 kHz (MP3)

Bit rate:

between 20 kbps to 320 kbps (WMA),
between 32 kbps to 320 kbps (MP3)



NOTE

- HD movie files contained on the CD or USB 1.0/1.1 may not played properly. BD, DVD or USB 2.0 are recommended to play back HD movie files.
- This player supports H.264/MPEG-4 AVC profile Main, High at Level 4.1. For a file with higher level, the warning message will appear on the screen.
- This player does not support the files that are recorded with GMC*1 or Qpel*2. Those are video encoding techniques in MPEG4 standard, like DivX or XVID have.
*1 GMC – Global Motion Compensation
*2 Qpel – Quarter pixel

MUSIC

Sampling frequency:

between 8 kHz to 48 kHz (WMA),
between 11 kHz to 48 kHz (MP3)

Bit rate:

between 8 kbps to 320 kbps (WMA, MP3),



NOTE

- This unit cannot support the ID3 Tag embedded MP3 file.
- The total playback time indicated on the screen may not be correct for VBR files.

PHOTO

Recommended size:

Less than 4,000 x 3,000 x 24 bit/pixel
Less than 3,000 x 3,000 x 32 bit/pixel

- Progressive and lossless compression photo image files are not supported.

Regional Code

This unit has a regional code printed on the rear of the unit. This unit can play only BD-ROM or DVD discs labeled same as the rear of the unit or "ALL".

AVCHD (Advanced Video Codec High Definition)

- This player can playback AVCHD format discs. These discs are normally recorded and used in camcorders.
- The AVCHD format is a high definition digital video camera format.
- The MPEG-4 AVC/H.264 format is capable of compressing images at higher efficiency than that of the conventional image compressing format.
- Some AVCHD discs use the "x.v.Colour" format.
- This player can playback AVCHD discs using "x.v.Colour" format.
- Some AVCHD format discs may not play, depending on the recording condition.
- AVCHD format discs need to be finalized.
- "x.v.Colour" offers a wider colour range than normal DVD camcorder discs.

Certain System Requirements

For high definition video playback:

- High definition display that has HDMI input jacks.
- BD-ROM disc with high definition content.
- HDMI or HDCP capable DVI input on your display device is required for some content (as specified by disc authors).
- For up-conversion of standard definition DVD, a HDMI or HDCP capable DVI input on your display device is required for copy protected content.

Compatibility Notes

- Because BD-ROM is a new format, certain disc, digital connection and other compatibility issues are possible. If you experience compatibility problems, please contact an authorized Customer Service Centre.
- Viewing high-definition content and up-converting standard DVD content may require a HDMI-capable input or HDCP-capable DVI input on your display device.
- Some BD-ROM and DVD discs may restrict the use of some operation commands or features.
- You can use a USB device that is used to store some disc related information, including downloaded on-line content. The disc you are using will control how long this information is retained.

Remote control



Battery Installation

Remove the battery cover on the rear of the Remote Control, and insert two R03 (size AAA) batteries with + and - matched correctly.

..... 1

⏻ (POWER): Switches the player ON or OFF.

⏪ OPEN/CLOSE: Ejects or inserts disc

RADIO&INPUT: Changes input mode.

0-9 numerical buttons: Selects numbered options in a menu.

CLEAR: Removes a mark on the search menu or a number when setting the password.

REPEAT: Repeats a desired section or sequence.

..... 2

⏮/⏭ SCAN: Searches backward or forward.

⏮/⏭ SKIP: Goes to the next or previous chapter / track / file.

■ (STOP): Stops playback.

▶ (PLAY): Starts playback.

⏸ (PAUSE): Pauses playback

SPEAKER LEVEL: Sets the sound level of desired speaker.

SOUND EFFECT: Selects a sound effect mode.

VOL +/- : Adjusts speaker volume.

OPTICAL: Changes input mode to optical directly.

MUTE: Mute the unit.

..... 3

🏠 HOME: Displays or exits the [Home Menu].

MUSIC ID: When connected to the network, can provide information about the current song during movie playback.

📺 INFO/DISPLAY: Displays or exits On-Screen Display.

Direction buttons: Selects an option in the menu.

⊙ ENTER: Acknowledges menu selection.

↶ RETURN: Exits the menu or resumes playback.

TITLE/POPUP: Displays the DVD title menu or BD-ROM's pop-up menu, if available.

DISC MENU: Accesses the menu on a disc.

..... 4

Coloured (R, G, Y, B) buttons: Use to navigate on menus.

MONO/STEREO: Selects mono/ stereo in FM mode.

MARKER: Marks any point during playback.

SEARCH: Displays or exits the search menu.

SLEEP: Sets a certain period of time after which the unit will switch to off.

● REC: Records an audio CD.

TV Control Buttons: See page 85.

2 Preparation

Player (Front)

2
Preparation



- ① USB Port
- ② PORT. IN
- ③ ⏻ (POWER) Button
- ④ Display window
- ⑤ **Operation buttons**
 - F** (Function)
Changes the input source or function.
 - >||** (PLAY / PAUSE)
 - (STOP)
 - |<< / >>|** (SKIP/SCAN)
 - volume +** (Adjusts speaker volume.)
 - ≡** Ejects or inserts disc

CAUTION

Precautions in using the touch buttons

- Use the touch buttons with clean and dry hands.
 - In a humid environment, wipe out any moisture on the touch buttons before using.
- Do not press the touch buttons hard to make it work.
 - If you apply too much strength, it can damage the sensor of the touch buttons.
- Touch the button that you want to work in order to operate the function correctly.
- Be careful not to have any conductive material such as metallic object on the touch buttons. It can cause malfunctions.

Player (Rear)

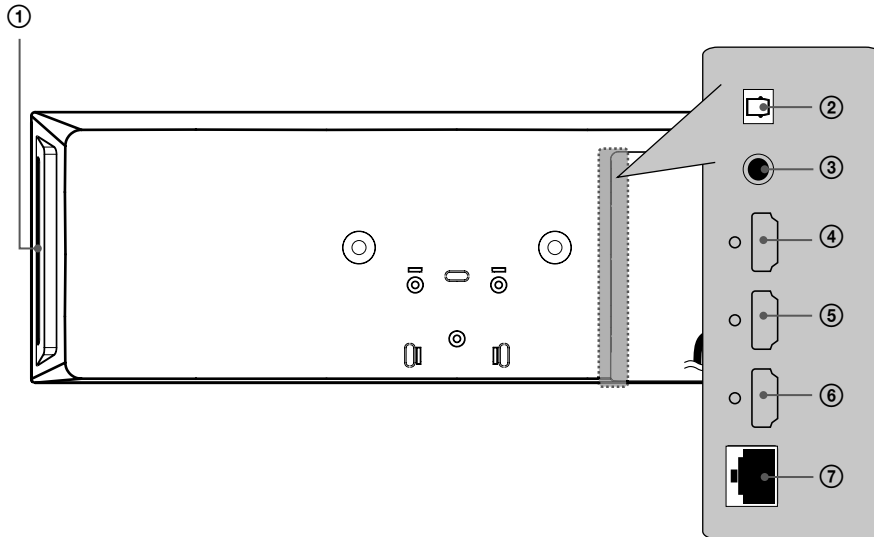

- ① Disc Slot
Insert a disc here.
- ② OPTICAL IN
- ③ VIDEO OUT
- ④ HDMI OUT (type A, Version 1.3)
Connect to TV with HDMI inputs.
- ⑤ HDMI IN 2
- ⑥ HDMI IN 1
- ⑦ LAN port

Active woofer

2
Preparation

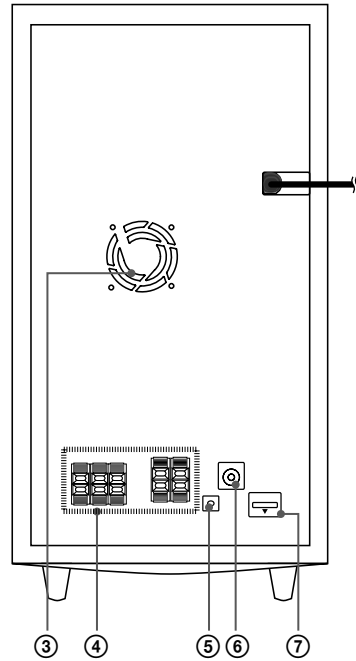
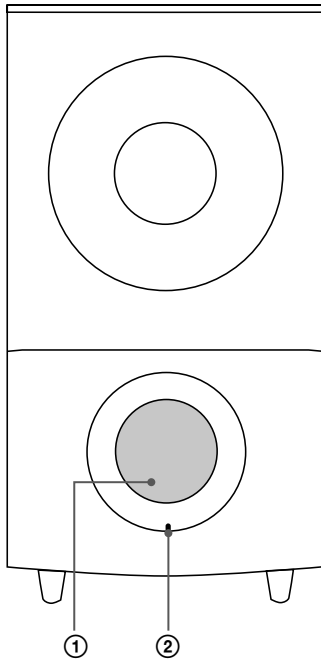

① Speaker duct

CAUTION

Be careful to make sure children not to put their hands or any objects into the speaker duct.

- ② LED (connection status)
BLUE: The connection is completed.
BLUE(blink): The woofer is trying to connect.
RED: The connection is failed.

- ③ Cooling Fan
- ④ Speakers connectors
- ⑤ PAIRING button
- ⑥ Antenna Connector
- ⑦ iPod (24 pin)
Connect to the furnished iPod cradle.

3 Installation

Installing the player

You can stand the player or mount on a wall.

Assembling the player with stand

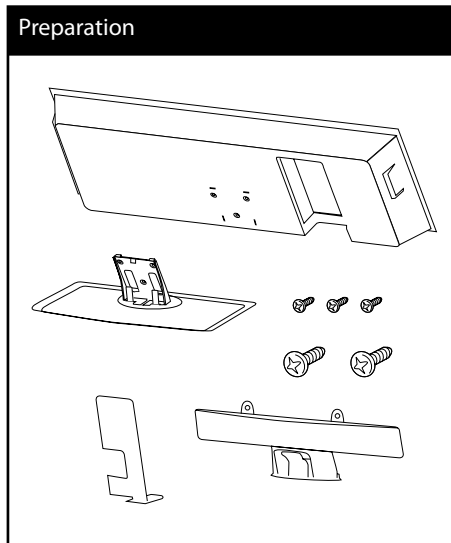

1. Connect the cables.

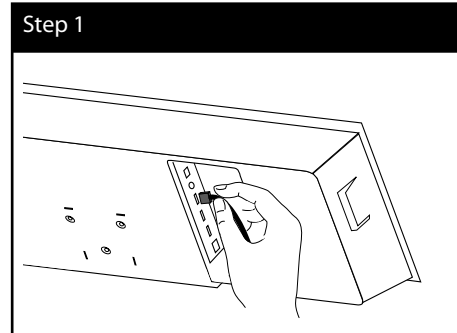

2. After connecting the cables, you can arrange the cable with cable holder as shown below.

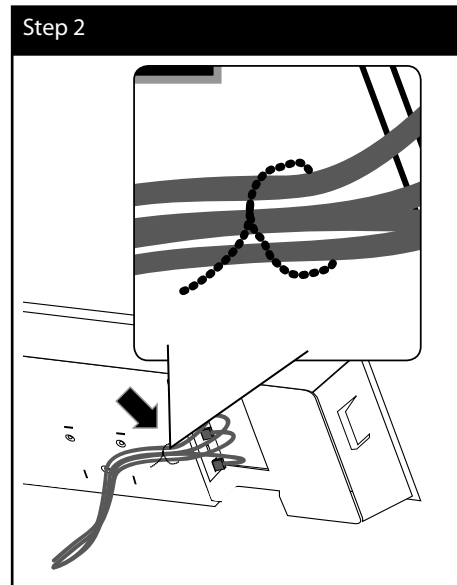

- 3. Assemble the cover as shown below

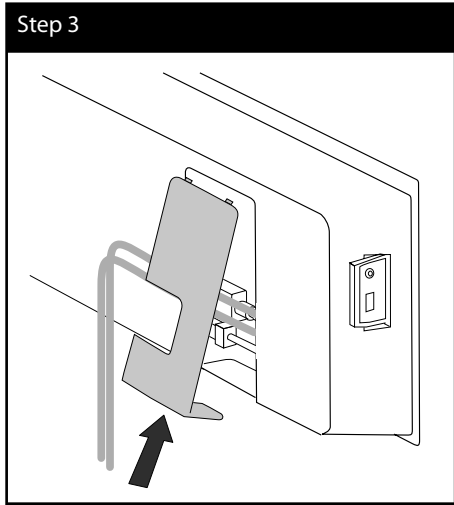

- 4. Attach the player to the stand.
Then secure the connection with the supplied middle screws.

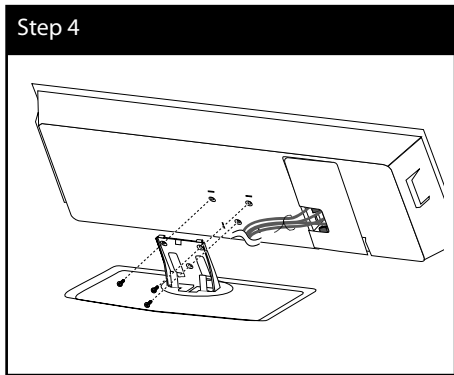

- 5. Arrange the cable with cable holder as shown below.

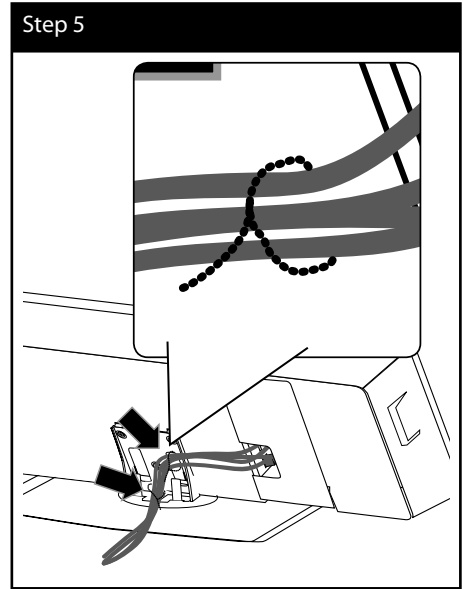

- 6. Assemble the rear cable cover as shown below.
Then secure the cover with the supplied big screws.

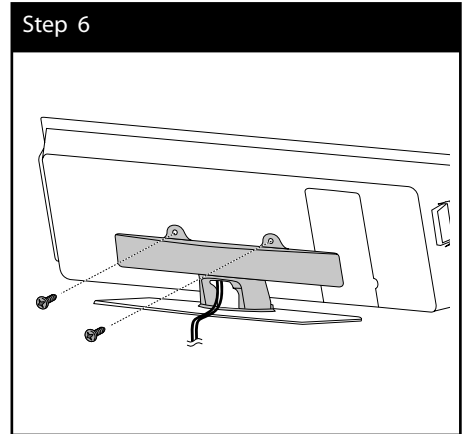

Mounting the player on a wall

You can mount the player on a wall. Prepare screws, bracket and guide sheet (the rear page of install guide) supplied.

Preparation

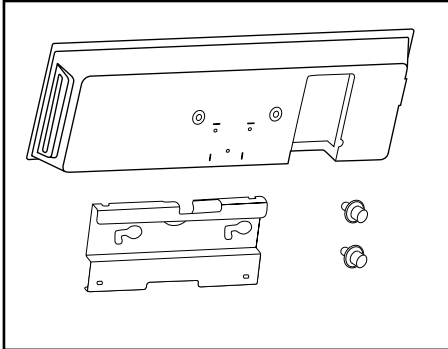

1. You should drill some holes. A guide sheet (rear page of the install guide) is supplied to drill. Use the sheet to check the point to drill.

Step 1

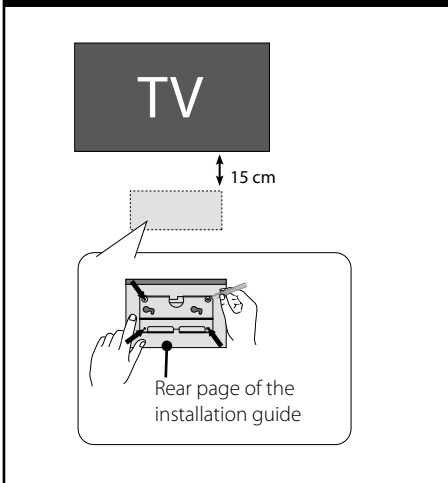

2. When you mount on a wall (concrete), use the wall plugs and screws (Not supplied). Attach the wall bracket on the wall as shown in the illustration below.

Step 2

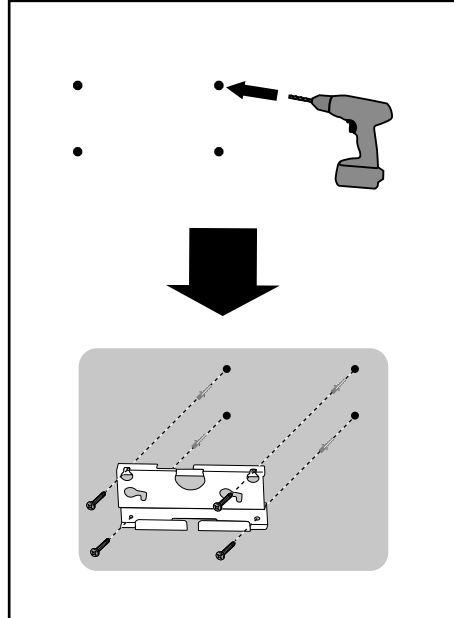

NOTE

- Screws and Wall Plugs are not supplied for mounting the unit. We recommend the Hilti (HUD-1 6 x 30) for the mounting. Please purchase it.

3. Assemble the screws.

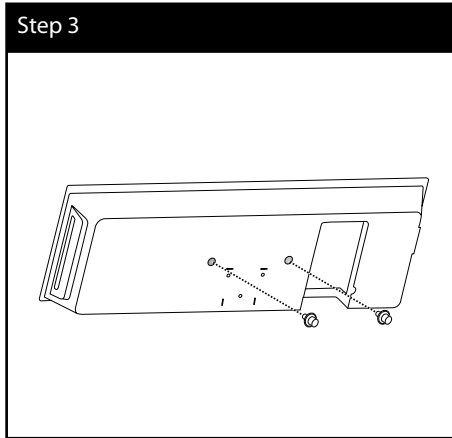

5. Hang the player onto the brackets as below.

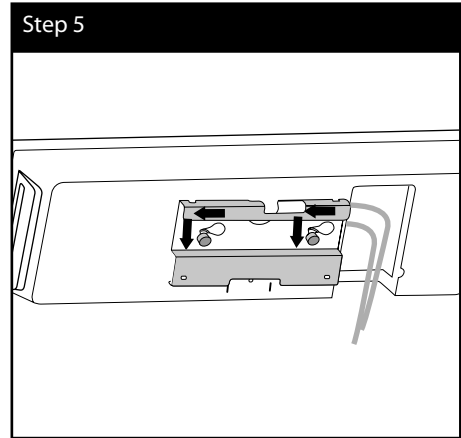

4. Connect the cables.

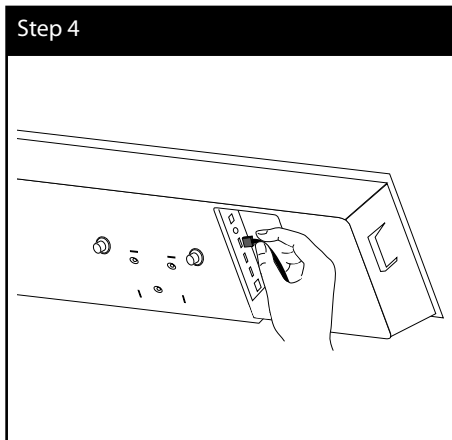

 CAUTION

- Do not hang onto the installed unit and avoid any impact to the unit.
- Secure the unit firmly to the wall so that it does not fall off. If the unit falls off, it may result in an injury or damage to the product.
- When the unit is installed on a wall, please make sure that a child does not pull any of connecting cables, as it may cause it to fall.

Assembling the speaker

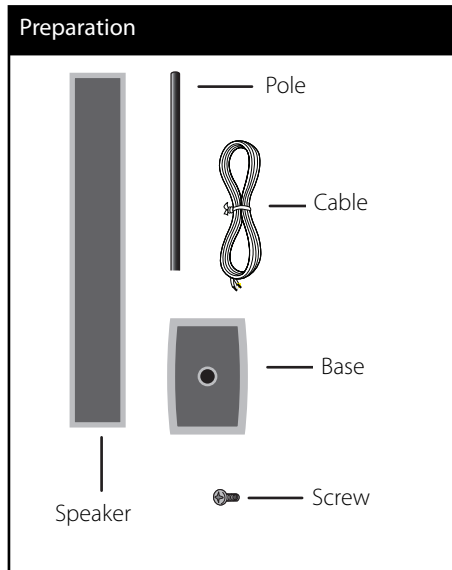

1. Attach the pole to the base, then secure the connection with a supplied screw.

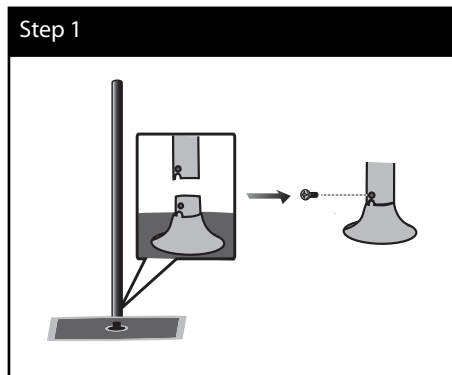

2. Insert a speaker wire from the bottom of the base.

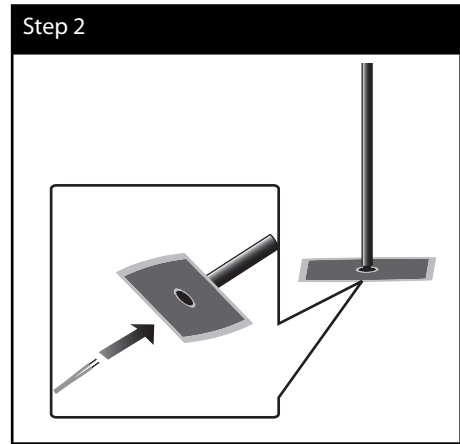

3. Draw the speaker wire through the inside of the pole and also through the hole on the bottom of the speaker.

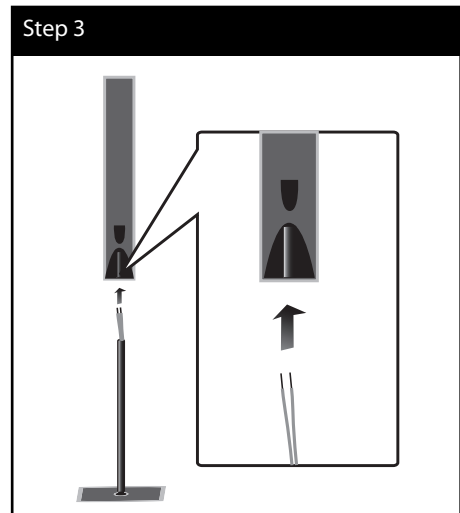

3

Installation

4. Attach the speaker to the pole, then secure the connection with a supplied screw.

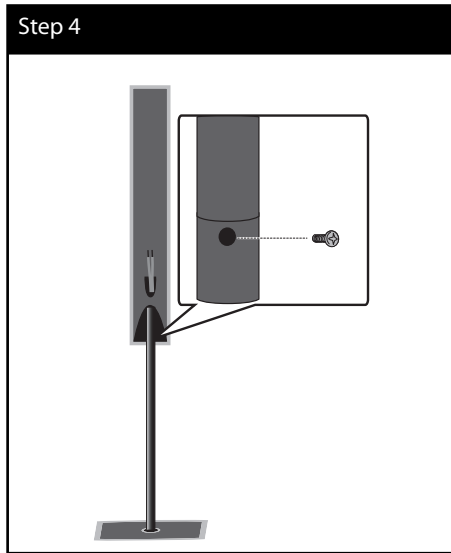

5. Connect the speaker wire to the terminal on the speaker.

Make sure the wire marked black goes in to the terminal marked “-” (minus) and the other wire goes in to the terminal marked “+” (plus).

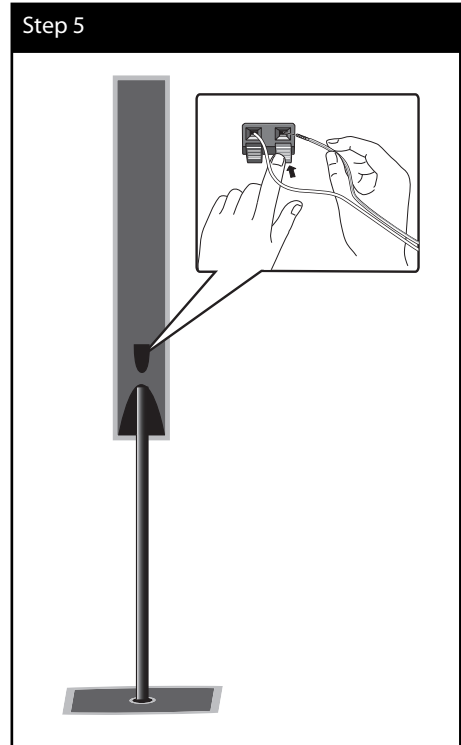

CAUTION

Be careful that the speaker should not fall down. Otherwise it may result in the speaker malfunctioning and causing personal injury and/or property damage.

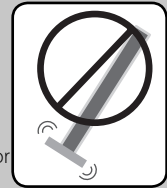

Mounting the speakers on a wall

You can mount the speakers on a wall. Prepare screws and brackets supplied.

When you mount to a wall (concrete), use the wall plugs. You should drill some holes (Diameter: 6 mm, Depth: more than 32 mm) for the mounting.

Screw & Wall plug

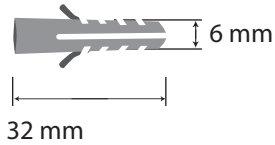
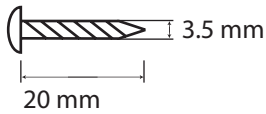

1. Attach the wall bracket to the wall with screws as shown in the illustration below.

Step 1

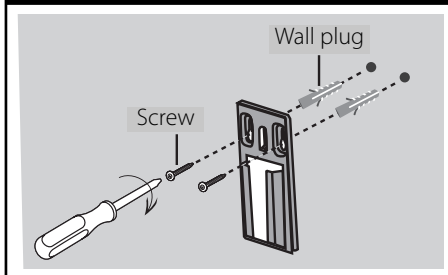

2. Attach the speaker bracket to the speaker and fasten the screws.

Step 2

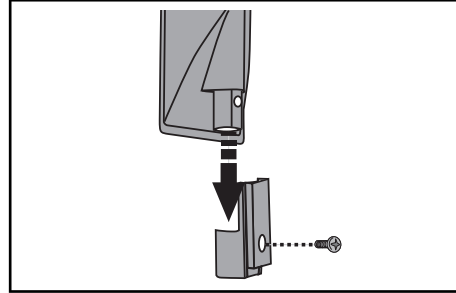

3. Hang the speaker bracket onto the wall bracket.

Step 3

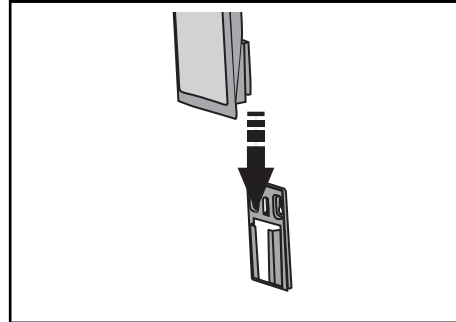

4. Press the speaker to secure the brackets.

Step 4

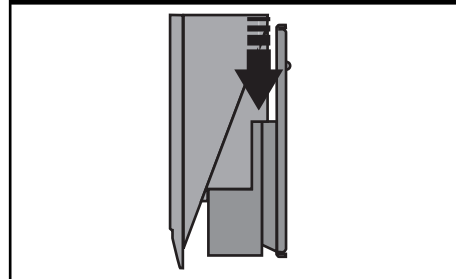

3

Installation

Positioning the system

The following illustration shows an example of positioning the system. Note that the illustrations in these instructions differ from the actual unit for explanation purposes. For the best possible surround sound, all the speakers other than the subwoofer should be placed at the same distance from the listening position (A).

3

Installation

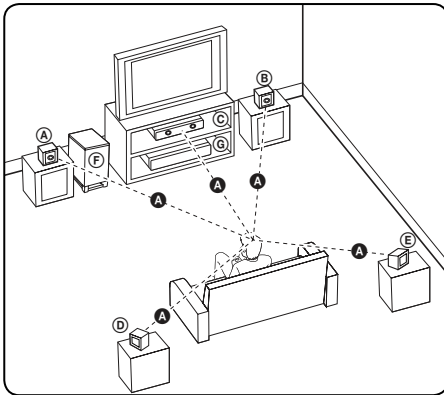

(A) Front left speaker (L)/

(B) Front right speaker (R):

Place the front speakers to the sides of the monitor or screen and as flush with the screen surface as possible.

(C) Centre speaker:

Place the Centre speaker above or below the monitor or screen.

(D) Surround left speaker (L)/

(E) Surround right speaker (R):

Place these speakers behind your listening position, facing slightly inwards.

(F) Subwoofer:

The position of the subwoofer is not so critical, because low bass sounds are not highly directional. But it is better to place the subwoofer near the front speakers. Turn it slightly toward the Centre of the room to reduce the wall reflections.

(G) Unit



CAUTION

- Place the Centre speaker at a safe distance from the child's reach. Otherwise it may result in the speaker falling down and causing personal injury and/or property damage.
- The speakers contain magnet parts, so colour irregularity may occur on the TV screen or PC monitor screen. Please use the speakers away from the TV screen or PC monitor screen.

Speaker Connection

Wireless connection

The wireless subwoofer makes setup simple, too - there are no cables to connect. When you turn on the unit and subwoofer the connection will be completed automatically. When the connection is completed, you can see the icon on the display window.

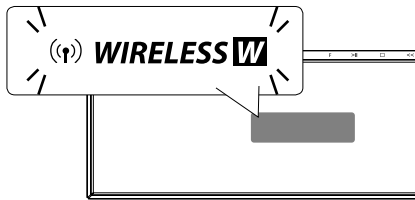

! NOTE

- If the wireless connection fails again, check whether there is any conflict or strong interference (for example, interference from other electronic devices) around your location. After removal of the conflict or strong interference, repeat the above procedures.
- The available length is 20 m for wireless connection on open place.

Wireless connection for manually

You can set up wireless connection manually, when your connection is not completed. Refer to the "Connect wireless speakers" on page 41.

Attaching the speakers

Connect speaker wires to the woofer.

To connect the cable to the woofer, press each plastic finger pad to open the connection terminal. Insert the wire and release the finger pad.

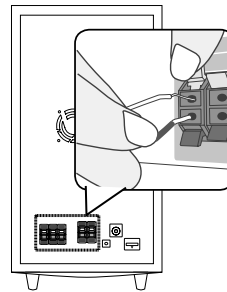

Connecting to Your TV

Make one of the following connections, depending on the capabilities of your existing equipment.

- HDMI connection (page 26)
- Video connection (page 28)

NOTE

- Depending on your TV and other equipment you wish to connect, there are various ways you could connect the player. Use only one of the connections described in this manual.
- Make sure the player is connected directly to the TV. Tune the TV to the correct video input channel.
- Do not connect your player via your VCR. The image could be distorted by the copy protection system.

3

Installation

HDMI Connection

If you have a HDMI TV or monitor, you can connect it to this player using a HDMI cable. Connect the HDMI OUT jack on the player to the HDMI IN jack on a HDMI compatible TV or monitor.

Set the TV's source to HDMI (refer to TV's Owner's manual).

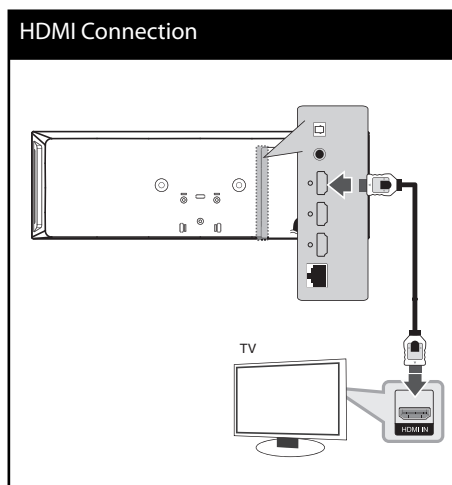

! NOTE

- Changing the resolution when the connection has already been established may result in malfunctions. To solve the problem, turn off the player and then turn it on again.
- When the HDMI connection with HDCP is not verified, TV screen is changed to black screen. In this case, check the HDMI connection, or disconnect the HDMI cable.
- If there is noise or lines on the screen, please check the HDMI cable (length is generally limited to 4.5 m).
- If a connected HDMI device does not accept the audio output of the player, the HDMI device's audio sound may be distorted or may not output.
- When you use HDMI connection, you can change the resolution for the HDMI output. (Refer to "Resolution Setting" on page 28.)
- Select the type of video output from the HDMI OUT jack using [HDMI Color Setting] option on the [Setup] menu (see page 39).
- When you connect a HDMI or DVI compatible device make sure of the following:
 - Try switching off the HDMI/DVI device and this player. Next, switch on the HDMI/DVI device and leave it for around 30 seconds, then switch on this player.
 - The connected device's video input is set correctly for this unit.
 - The connected device is compatible with 720x576p (480p), 1280x720p, 1920x1080i or 1920x1080p video input.
- Not all HDCP-compatible HDMI or DVI devices will work with this player.
 - The picture will not be displayed properly with non-HDCP device.
 - This player does not playback and TV screen is changed to black screen.

What is SIMPLINK?



LG TV's with SIMPLINK function has the logo as shown above.

Some functions of this unit are controlled by the TV's remote control when this unit and LG TV's with SIMPLINK are connected through HDMI connection.

Controllable functions by LG TV's remote control; Play, Pause, Scan, Skip, Stop, Power Off, etc.

Refer to the TV owner's manual for the details of SIMPLINK function.

! NOTE

Depending on the disc type or playing status, some SIMPLINK operation may differ from your purpose or not work.

Video Connection

Connect the VIDEO OUT jack on the player to the video in jack on the TV using a video cable. You can hear the sound through the system's speakers.

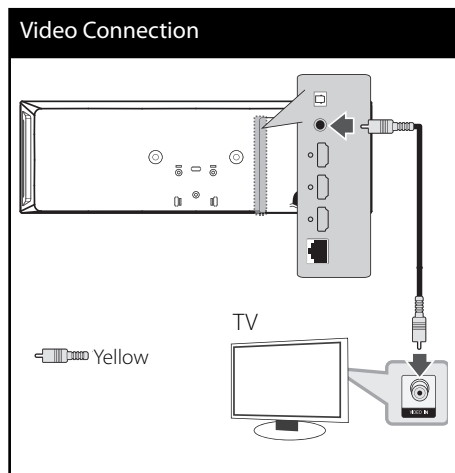

Resolution Setting

The player provides several output resolutions for HDMI OUT jacks. You can change the resolution using [Setup] menu.

1. Press HOME (🏠).
2. Use </> to select the [Setup] and press ENTER (⊙). The [Setup] menu appears.
3. Use ^/v to select [DISPLAY] option then press > to move to the second level.
4. Use ^/v to select the [Resolution] option then press ENTER (⊙) or > to move to the third level.

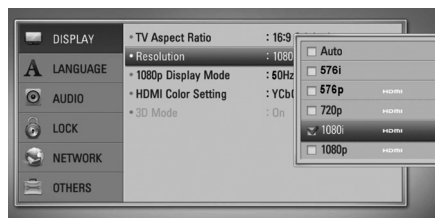

5. Use ^/v to select the desired resolution then press ENTER (⊙) to confirm your selection.

! NOTE

- If your TV does not accept the resolution you have set on the player, you can set resolution to 576p (480p) as follows:
 1. Press ▲.
 2. Press ■ for more than 5 seconds.
- Since several factors affect the resolution of video output, see "Video Output Resolution" on page 90.

Antenna connection

Connect the supplied antenna for listening to the radio.

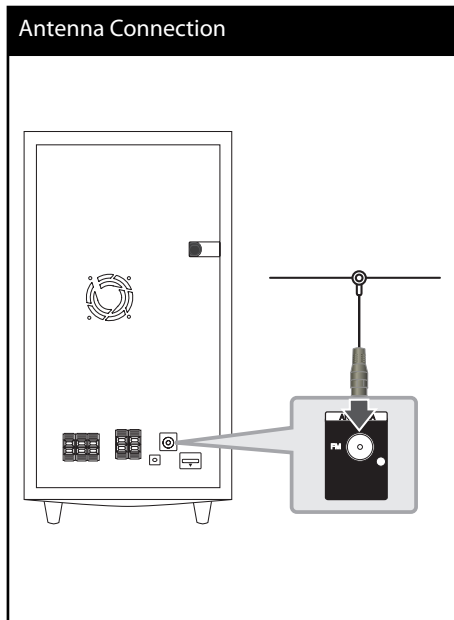

NOTE
 After connecting the FM wire antenna, keep it as horizontal as possible. Be sure to fully extend the FM wire antenna.

Connections with external device

PORT. IN connection

You can enjoy the sound from your portable audio player through the speakers of this system.

Connect the headphones (or line out) jack of the portable audio player into the PORT. IN socket of this unit. And then select the [PORTABLE] option by pressing RADIO&INPUT and ENTER (Ⓞ).

You can also use the F (Function) button on the front panel to select the input mode.

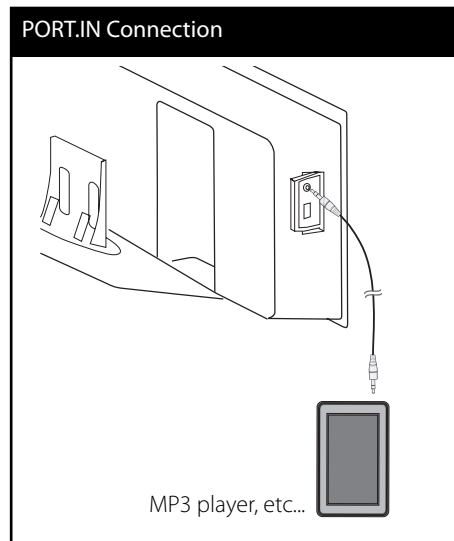

 **OPTICAL IN connection**

You can enjoy the sound from your component with a digital optical connection through the speakers of this system.

Connect the optical output jack of your component into the OPTICAL IN jacks on the unit. And then select the [OPTICAL] option by pressing RADIO&INPUT and ENTER (⊙). Or press OPTICAL to select directly.

You can also use the F (Function) button on the front panel to select the input mode.

 **HDMI IN 1/2 connection**

You can enjoy the pictures and sound from your component through this connection.

Connect the HDMI OUT jack of your component into the HDMI IN 1 or 2 jack on this unit. And then select the [HDMI IN 1/2] option by pressing RADIO&INPUT and ENTER (⊙).

You can also use the F (Function) button on the front panel to select the input mode.

3

Installation

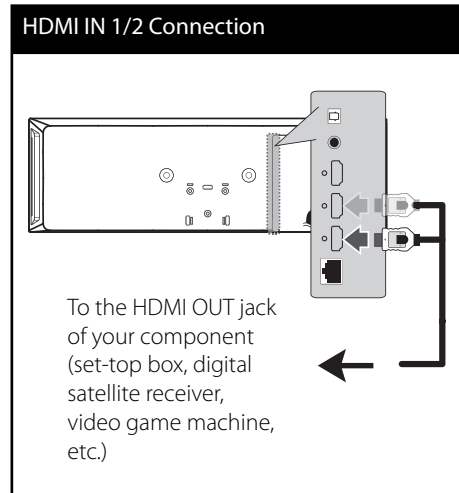
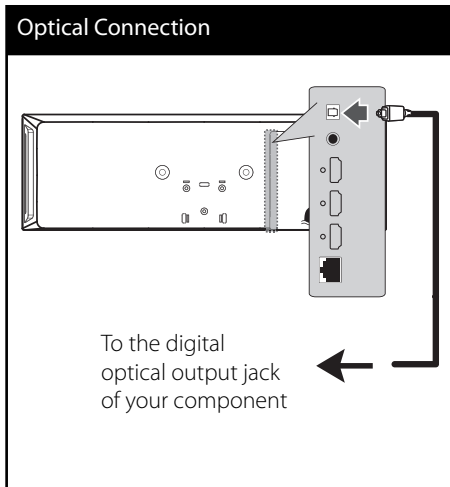

 **NOTE**

- You cannot change the video resolution in the HDMI IN 1/2 mode. Change the video resolution of the connected component.
- If the video output signal is abnormal when your personal computer is connected to HDMI IN 1/2 jack, change the resolution of your personal computer to 576p (480p), 720p, 1080i or 1080p.
- The video signal from the HDMI input cannot be output from the composite video outputs.
- The player sends audio from the HDMI inputs to both the HDMI output and to the unit's speakers.

Connecting to your Home Network

This player can be connected to a local area network (LAN) via the LAN port on the rear panel or the internal wireless module. By connecting the unit to a broadband home network, you have access to services such as software updates, Home Link, BD-Live™ interactivity and streaming services.

Wired network connection

Using a wired network provides the best performance, because the attached devices connect directly to the network and are not subject to radio frequency interference. Please refer to the documentation for your network device for further instructions. Connect the player's LAN port to the corresponding port on your Modem or Router using a commercially available LAN or Ethernet cable (CAT5 or better with RJ45 connector). In the example configuration for wired connection below, this player would be able to access content from either of the PCs.



NOTE

- When plugging or unplugging the LAN cable, hold the plug portion of the cable. When unplugging, do not pull on the LAN cable but unplug while pressing down on the lock.
- Do not connect a modular phone cable to the LAN port.
- Since there are various connection configurations, please follow the specifications of your telecommunication carrier or internet service provider.
- If you want to access content from PCs or DLNA servers, this player must be connected to the same local area network with them via a router.

Wired Network Setup

Before setting the wired network, you need to connect the broadband internet to your home network.

If there is a DHCP server on the local area network (LAN) via wired connection, this player will automatically be allocated an IP address. After making the physical connection, a small number of home networks may require the player's network setting to be adjusted. Adjust the [NETWORK] setting as follow.

1. Select [Connection Setting] option in the [Setup] menu then press ENTER (⊙).

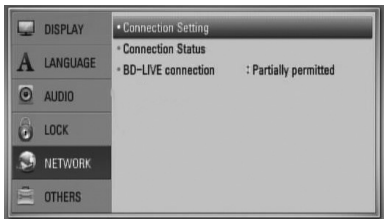

2. The [Connection Setting] menu appear on the screen. Use \wedge/\vee to select the [Wired] and press ENTER (⊙).
3. Selects [Yes] and press ENTER (⊙) to continue. The new connection setting resets the current network settings.
4. Use $\wedge/\vee/\lt;/\gt$ to select the IP mode between [Dynamic] and [Static]. Normally, select [Dynamic] to allocate an IP address automatically.

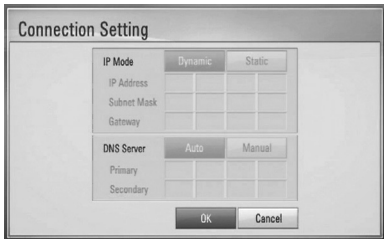

NOTE

If there is no DHCP server on the network and you want to set the IP address manually, select [Static] then set the [IP Address], [Subnet Mask], [Gateway] and [DNS Server] using $\wedge/\vee/\lt;/\gt$ and numerical buttons. If you make a mistake while entering a number, press CLEAR to clear the highlighted part.

5. Select [OK] and press ENTER (⊙) to apply network settings.
6. The player will ask you to test the network connection. Select [OK] and press ENTER (⊙) to complete the network connection.
7. If you select [Test] and press ENTER (⊙) at step 6 above, the network connection status is displayed on the screen.

You can also test it on the [Connection Status] in the [Setup] menu.

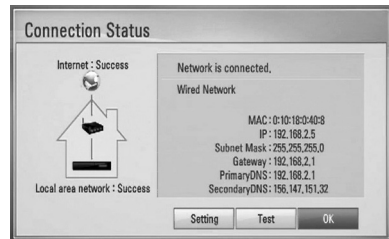

3 Installation

Wireless Network Connection

Another connection option is to use an Access Point or a wireless router. In the example configuration for wireless connection below, this player would be able to access content from either of the PCs.

The network configuration and connection method may vary depending on the equipment in use and the network environment.

Refer to the setup instructions supplied with your access point or wireless router for detailed connection steps and network settings.

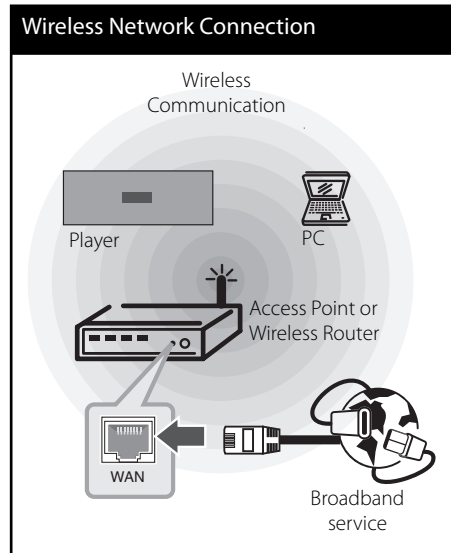

NOTE

- For best performance, a direct wired connection from your Home theatre to your home network's router or cable/DSL modem is always the best option. If your Home theatre is far away from your router or cable/DSL modem, Ethernet or LAN cables are available at many stores in lengths of 15 m and longer. If you do choose to use the wireless option, note that performance can sometimes be affected by other electronic devices in the home.
- An Access Point is a device that allows you to connect to your home network wirelessly.

Wireless Network Setup

Before setting the wireless network, you need to:

- connect the broadband internet to the wireless home network.
- set the access point or wireless router.
- note the SSID and security code of the network.

For the wireless network connection, the player needs to be set up for network communication. This adjustment can be done from the [Setup] menu. Adjust the [NETWORK] setting as follow. Setting up the access point or the wireless router is required before connecting the player to the network.

1. Select [Connection Setting] option in the [Setup] menu then press ENTER (Ⓢ).

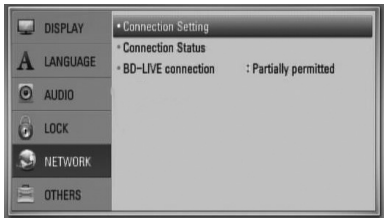

2. The [Connection Setting] menu appear on the screen. Use ^/V to select [Wireless] and press ENTER (Ⓢ).

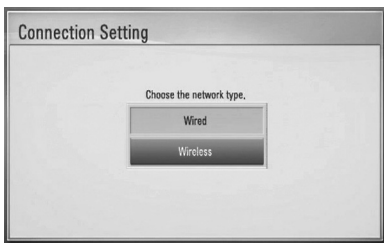

3. Selects [Yes] and press ENTER (Ⓢ) to continue. The new connection setting resets the current network settings.

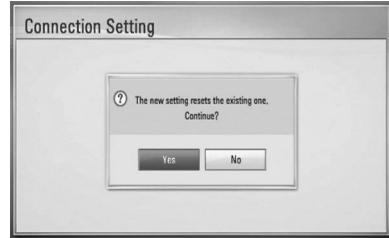

4. The player scans the all available access points or wireless routers within range and display them as a list. Use ^/V to select an access point or wireless router on the list, and then press ENTER (Ⓢ).



If you have security on your access point or wireless router, verify that the WEP or WPA key that was entered into the player matches the router's information exactly. You need to input the security code as necessary.

NOTE

WEP security mode generally have 4 keys available on an access point or wireless router's setting. If your access point or wireless router use WEP security, enter the security code of the key "No.1" to connect on your home network.

[Manual] – Your access point may not be broadcasting its access point name (SSID). Check your router settings through your computer and either set your router to broadcast SSID, or manually enter the access point name (SSID) in [Manual].

[Push Button] – If your access point or wireless router that supports Push Button Configuration method, select this option and press the Push Button on your access point or wireless router within 120 counts. You do not need to know the access point name (SSID) and security code of your access point or wireless router.

- Use $\Delta/V/</>$ to select the IP mode between [Dynamic] and [Static]. Normally, select [Dynamic] to allocate an IP address automatically.



NOTE

If there is no DHCP server on the network and you want to set the IP address manually, select [Static] then set [IP Address], [Subnet Mask], [Gateway] and [DNS Server] using $\Delta/V/</>$ and numerical buttons. If you make a mistake while entering a number, press CLEAR to clear the highlighted part.

- Select [OK] and press ENTER (⊙) to apply network settings.
- The player will ask you to test the network connection. Select [OK] and press ENTER (⊙) to complete the network connection.
- If you select [Test] at step 7 above, the network connection status is displayed on the screen.
You can also test it on the [Connection Status] in the [Setup] menu.

Notes on Network Connection:

- Many network connection problems during set up can often be fixed by re-setting the router or modem. After connecting the player to the home network, quickly power off and/or disconnect the power cable of the home network router or cable modem. Then power on and/or connect the power cable again.
- Depending on the internet service provider (ISP), the number of devices that can receive internet service may be limited by the applicable terms of service. For details, contact your ISP.
- Our company is not responsible for any malfunction of the player and/or the internet connection feature due to communication errors/malfunctions associated with your broadband internet connection, or other connected equipment.
- The features of BD-ROM discs made available through the Internet Connection feature are not created or provided by our company, and our company is not responsible for their functionality or continued availability. Some disc related material available by the Internet Connection may not be compatible with this player. If you have questions about such content, please contact the producer of the disc.
- Some internet contents may require a higher bandwidth connection.
- Even if the player is properly connected and configured, some internet contents may not operate properly because of internet congestion, the quality or bandwidth of your internet service, or problems at the provider of the content.

- Some internet connection operations may not be possible due to certain restrictions set by the Internet service provider (ISP) supplying your broadband Internet connection.
- Any fees charged by an ISP including, without limitation, connection charges are your responsibility.
- A 10 Base-T or 100 Base-TX LAN port is required for wired connection to this player. If your internet service does not allow for such a connection, you will not be able to connect the player.
- You must use a Router to use xDSL service.
- A DSL modem is required to use DSL service and a cable modem is required to use cable modem service. Depending on the access method of and subscriber agreement with your ISP, you may not be able to use the internet connection feature contained in this player or you may be limited to the number of devices you can connect at the same time. (If your ISP limits subscription to one device, this player may not be allowed to connect when a PC is already connected.)
- The use of a "Router" may not be allowed or its usage may be limited depending on the policies and restrictions of your ISP. For details, contact your ISP directly.
- The wireless network operate at 2.4 GHz radio frequencies that are also used by other household devices such as cordless telephone, *Bluetooth*® devices, microwave oven, and can be affected by interference from them.
- Turn off all unused network equipment in your local home network. Some devices may generate network traffic.
- For the purpose of the better transmission, place the player as close as possible to the access point.
- In some instances, placing the access point or wireless router at least 0.45 m above the floor may improve the reception.
- Move closer to the access point if possible or re-orient the player so there is nothing between it and the access point.
- The reception quality over wireless depends on many factors such as type of the access point, distance between the player and access point, and the location of the player.
- Set your access point or wireless router to Infrastructure mode. Ad-hoc mode is not supported.

USB device connection

This player can play movie, music and photo files contained in the USB device.

1. Insert a USB device to the USB port until it fits into place.

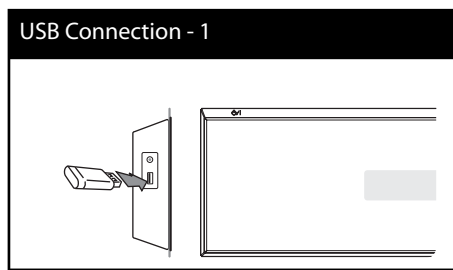

2. Select [Movie], [Photo] or [Music] using </>, and press ENTER (⊙).
3. Select a file using ^/v/</>, and press PLAY or ENTER (⊙) to play the file.
You can check the space of the USB device on the screen.

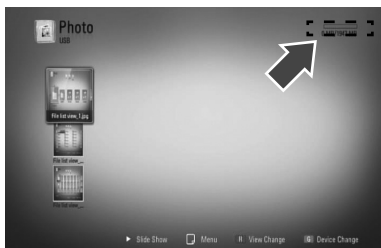

4. Select the other mode. And withdraw the USB device carefully.

NOTE

- This player supports USB flash memory/external HDD formatted in FAT16, FAT32 and NTFS when accessing files (music, photo, movie). However, for BD-Live™ and Audio CD recording, only FAT16 and FAT32 formats are supported. Use the USB flash memory/external HDD formatted in either FAT16 or FAT32 when using BD-Live™ and Audio CD recording.
- The USB device can be used for the local storage for enjoying BD-Live™ discs with Internet.
- This unit can support up to 4 partitions of the USB device.
- Do not extract the USB device during operation (play, etc.).
- An USB device which requires additional programme installation when you have connected it to a computer, is not supported.
- USB device: USB device that support USB 1.1 and USB 2.0.
- Movie, music and photo files can be played. For details of operations on each file, refer to relevant pages.
- Regular back up is recommended to prevent data loss.
- If you use a USB extension cable, USB HUB or USB Multi-reader, the USB device may not be recognised.
- Some USB device may not work with this unit.
- Digital camera and mobile phone are not supported.
- USB Port of the unit cannot be connected to PC. The unit cannot be used as a storage device.

Settings

Adjust the Setup Settings

You can change the settings of the player in the [Setup] menu.

1. Press HOME (🏠).

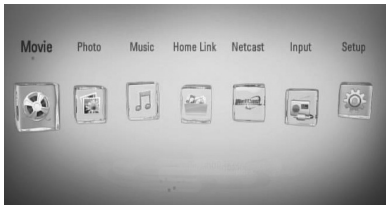

2. Use </> to select the [Setup] and press ENTER (⊙). The [Setup] menu appears.
3. Use ^/v to select a first setup option, and press > to move to the second level.

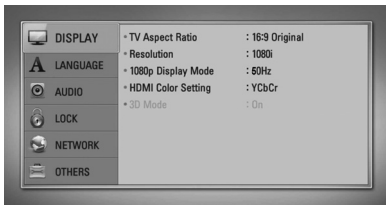

4. Use ^/v to select a second setup option, and press ENTER (⊙) to move to the third level.

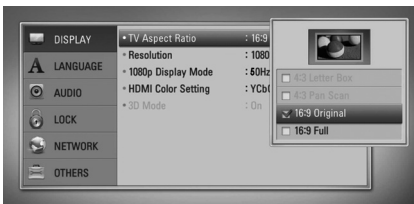

5. Use ^/v to select a desired setting, and press > or ENTER (⊙) to confirm your selection.

[DISPLAY] Menu

TV Aspect Ratio

Select a TV aspect ratio option according to your TV type.

[4:3 Letter Box]

Select when a standard 4:3 TV is connected. Displays theatrical images with masking bars above and below the picture.

[4:3 Pan Scan]

Select when a standard 4:3 TV is connected. Displays pictures cropped to fill your TV screen. Both sides of the picture are cut off.

[16:9 Original]

Select when a 16:9 wide TV is connected. The 4:3 picture is displayed with an original 4:3 aspect ratio, with black bars appearing at the left and right sides.

[16:9 Full]

Select when a 16:9 wide TV is connected. The 4:3 picture is adjusted horizontally (in a linear proportion) to fill the entire screen.

 **NOTE**
 You cannot select [4:3 Letter Box] and [4:3 Pan Scan] option when the resolution is set to higher than 720p.

Resolution

Sets the output resolution of the HDMI video signal. Refer to page 28 and page 90 for details about the resolution setting.

[Auto]

If the HDMI OUT jack is connected to TVs providing display information (EDID), automatically selects the resolution best suited to the connected TV.

[1080p]

Outputs 1080 lines of progressive video.

[1080i]

Outputs 1080 lines of interlaced video.

[720p]

Outputs 720 lines of progressive video.

[576p (480p)]

Outputs 576 (480) lines of progressive video.

[576i (480i)]

Outputs 576 (480) lines of interlaced video.

1080p Display Mode

When the resolution is set to 1080p, select [24 Hz] for smooth presentation of film material (1080p/ 24 Hz) with a HDMI-equipped display compatible with 1080p/ 24 Hz input.



NOTE

- When you select [24 Hz], you may experience some picture disturbance when the video switches video and film material. In this case, select [50 (60) Hz].
- Even when [1080p Display Mode] is set to [24 Hz], if your TV is not compatible with 1080p/ 24 Hz, the actual frame frequency of the video output will be 50 (60) Hz to match the video source format.

HDMI Color Setting

Select the type of output from the HDMI OUT jack. For this setting, please refer to the manuals of your display device.

[YCbCr]

Select when connecting to a HDMI display device.

[RGB]

Select when connecting to a DVI (RGB) display device.

3D Mode

Select the type of output mode for Blu-ray 3D™ disc playback. Refer to page 48 for more information about Blu-ray 3D™ disc.

[Off]

Blu-ray 3D™ disc playback will output as 2D mode like a normal BD-ROM disc playback.

[On]

Blu-ray 3D™ disc playback will output as 3D mode.

A [LANGUAGE] Menu

Display Menu

Select a language for the [Setup] menu and on-screen display.

Disc Menu/ Disc Audio/ Disc Subtitle

Select the language you prefer for the audio track (disc audio), subtitles, and the disc menu.

[Original]

Refers to the original language in which the disc was recorded.

[Other]

Press ENTER (Ⓞ) to select another language. Use number buttons then ENTER (Ⓞ) to enter the corresponding 4-digit number according to the language code list on page 87.

[Off] (for Disc Subtitle only)

Turn off Subtitle.



NOTE

Depending on the disc, your language setting may not work.

A [AUDIO] Menu

Speaker Setup

To obtain the best possible sound, use the speaker setup display to specify the volume of the speakers you have connected and their distance from your listening position. Use the test to adjust the volume of the speakers to the same level.

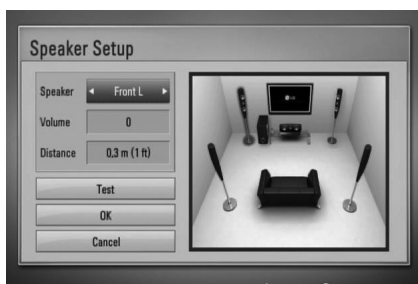

[Speaker]

Select a speaker that you want to adjust.

[Volume]

Adjust the output level of each speaker.

[Distance]

Adjust the distance between each speaker and the listening position.

[Test/ Stop test tone]

The speakers will emit a test tone.

[OK]

Confirms the setting.

[Cancel]

Cancels the setting.

HD AV Sync

Sometimes Digital TV encounters a delay between picture and sound. If this happens you can compensate by setting a delay on the sound so that it effectively 'waits' for the picture to arrive: this is called HD AV Sync. Use **▲ ▼** to scroll up and down through the delay amount, which you can set at anything between 0 and 300 ms.

The delay will vary depending on which digital TV channel you are on. If you change channel you may need to readjust the HD AV Sync.

DRC (Dynamic Range Control)

This function allows you to listen to a movie at a lower volume without losing clarity of sound.

[Off]

Turns off this function.

[On]

Compress the dynamic range of the Dolby Digital, Dolby Digital Plus or Dolby TrueHD audio output.

[Auto]

The dynamic range of the Dolby TrueHD audio output is specified by itself. And the dynamic range of the Dolby Digital and Dolby Digital Plus are operated as same as the [On] mode.



NOTE

The DRC setting can be changed only when a disc is not inserted or the unit is in complete stop mode.

Connect wireless speakers

When the unit is manufactured, the ID is already set. If an interference occurs or you use a new wireless subwoofer, an ID should be set again.

When the [Wireless Speaker Connection Guide] appears, press PAIRING button on the subwoofer.

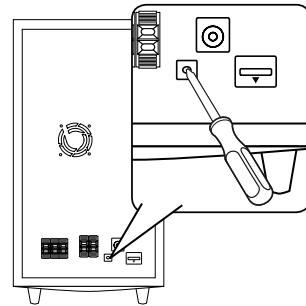

- If you see the blue LED indicator light on the woofer, the pairing was successful. Select the [Speaker test] to test the connection.



[LOCK] Menu

To access the any features in [LOCK] settings, you must enter the 4-digit security code you have created.

If you have not entered a password yet, you are prompted to do so. Enter a 4-digit password twice, and press ENTER (Ⓞ) to create a new password.

Password

You can create or change the password.

[None]

Enter a 4-digit password twice, and press ENTER (Ⓞ) to create a new password.

[Change]

Enter the current password and press ENTER (Ⓞ). Enter a 4-digit password twice, and press ENTER (Ⓞ) to create a new password.



NOTE

If you make a mistake before pressing ENTER (Ⓞ), press CLEAR. Then input the correct password.

If you forget your password,

If you forget your password, you can clear it using the following steps:

1. Remove any disc that might be in the player.
2. Select [Lock] option in the [Setup] menu.
3. Use number buttons to enter "210499" on the [Lock] Menu. The password is cleared.

DVD Rating

Blocks playback of rated DVD based on their content. (Not all discs are rated.)

[Rating 1-8]

Rating one (1) has the most restrictions and rating eight (8) is the least restrictive.

[Unlock]

If you select this, parental control is not active and the disc plays in full.

BD Rating

Sets an age limit for BD-ROM playback.

Use number buttons to input an age limit for BD-ROM viewing.

[255]

All BD-ROM can be played.

[0-254]

Prohibits play of BD-ROM with corresponding ratings recorded on them.



NOTE

The [BD Rating] will be applied only for the BD disc that containing the Advanced Rating Control.

Area Code

Enter the code of the area whose standards were used to rate the DVD video disc, based on the list on page 86.



[NETWORK] Menu

The [NETWORK] settings are needed to use the software update, BD Live, Home Link and NetCast features.

Connection Setting

If your home network environment is ready to connect to the player, the player needs to be set up for network communication. (See "Connecting to your Home Network" on page 31.)

Connection Status

If you want to check the network status on this player, select the [Connection Status] options and press ENTER (Ⓢ) to check whether a connection to the network and the internet have been established.

BD-Live™ connection

You can restrict Internet access when BD-Live™ functions are used.

[Permitted]

Internet access is permitted for all BD-Live™ contents.

[Partially permitted]

Internet access is permitted only for BD-Live™ contents which have content owner certificates. Internet access and AACIS Online functions are prohibited for all BD-Live™ contents without a certificate.

[Prohibited]

Internet access is prohibited for all BD-Live™ contents.



[OTHERS] Menu

DivX VOD

ABOUT DIVX VIDEO: DivX® is a digital video format created by DivX, Inc. This is an official DivX Certified device that plays DivX video. Visit www.divx.com for more information and software tools to convert your files into DivX video.

ABOUT DIVX VIDEO-ON-DEMAND: This DivX Certified® device must be registered in order to play DivX Video-on-Demand (VOD) content. To generate the registration code, locate the DivX VOD section in the device setup menu. Go to vod.divx.com with this code to complete the registration process and learn more about DivX VOD.

[Register]

Displays the registration code of your player.

[Deregister]

Deactivate your player and display the deactivation code.



NOTE

All the downloaded videos from DivX VOD with this player's registration code can only be played back on this unit.

Auto Power Off

The screen saver appears when you leave the player in stop mode for about five minutes. If you set this option to [On], the unit automatically turns itself off after the Screen Saver is displayed for 25 minutes. Set this option to [Off] to leave the screen saver until the unit is operated by the user.

Initialize

Factory Set

You can reset the player to its original factory settings.

BD Storage Clear

Initializes the BD contents from the connected USB storage.



NOTE

If you reset the player to its original factory settings using [Factory Set] option, you have to set all the activation for the on-line services and network settings again.

Software

Information

Displays the current software version.

Update

You can update the software by connecting the unit directly to the software update server (see page 88).

Disclaimer Notice

Press ENTER (Ⓞ) to view the notice of Network Service Disclaimer on page 95.

Sound Effect

You can select a suitable sound mode. Press SOUND EFFECT repeatedly until the desired mode appears on the front panel display or the TV screen. The displayed items for the equalizer maybe different depending on sound sources and effects.

[Natural Plus]: You can enjoy the natural sound effect same as 5.1 channel.

[Natural]: You can enjoy comfortable and natural sound.

[Bypass]: Software with multichannel surround audio signals is played according to the way it was recorded.

[Bass Blast]: Reinforce the bass sound effect from front left and right speaker and subwoofer.

[PL II Movie]: Performs Pro Logic II movie mode decoding to the input signal and produces five full-bandwidth output channels from 2 channel sources. This setting is ideal for watching videos of overdubbed or old movies. This mode is available only to 2 channel sources.

[PL II Music]: Performs Pro Logic II music mode decoding to the input signal and produces five full-bandwidth output channels from 2 channel sources. This setting is ideal for normal stereo sources such as CD. This mode is available only to 2 channel sources.

[Clear Voice]: This mode makes voice sound clear, improving the quality of voice sound.

[Virtual]: You can enjoy more dynamic sound with improved Centre channel.

[Game]: You can enjoy more virtual sound while playing video games.

[Night]: This may be useful when you want to watch movies at low volumes late at night.

[Mus. ReTouch]: When listening to MP3 files or other compressed music, you can enhance the sound. This mode is available only to 2 channel sources.

[Loudness]: Improves bass and treble sound.

4 Operation

General Playback

Playing Discs

1. Insert a Disc.

For the most Audio CD, BD-ROM and DVD-ROM discs, playback starts automatically.

2. Press HOME (🏠).



3. Select [Movie], [Photo] or [Music] using </>, and press ENTER (⊙).

4. Select the Disc option using </>, and press ENTER (⊙).

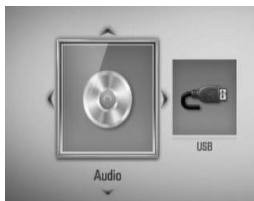

When you connect up to two devices, it appears as above.

5. Select a file using ^/V/</>, and press ► (PLAY) or ENTER (⊙) to play the file.

! NOTE

- Playback functions described in this manual are not always available in every files and medium. Some functions can be restricted depending on many factors.
- Depending on the BD-ROM titles, a USB device connection may be needed for the proper playback.

To stop playback

Press ■ (STOP) during playback.

To pause playback

Press ■■ (PAUSE) during playback.
Press ► (PLAY) to resume playback.

To play frame-by-frame

Press ■■ (PAUSE) while movie playback.
Press ■■ (PAUSE) repeatedly to play Frame-by-Frame playback.

To scan forward or backward

Press ◀◀ or ▶▶ to play fast forward or fast reverse during playback.
You can change the various playback speeds by pressing ◀◀ or ▶▶ repeatedly.

To slow down the playing speed

While the playback is paused, press ▶▶ repeatedly to play various speeds of slow motion.

To skip to the next/previous chapter/track/file

During playback, press ◀◀◀ or ▶▶▶ to go to the next chapter/track/file or to return to the beginning of the current chapter/track/file.
Press ◀◀ twice briefly to step back to the previous chapter/track/file.

Using the disc menu

BD DVD AVCHD

To display the disc menu

The menu screen may be displayed first after loading a disc which contains a menu. If you want to display the disc menu during playback, press DISC MENU.

Use ^/V/</> buttons to navigate through menu items.

To display the Pop-up menu

Some BD-ROM discs contain a Pop-up menu that appears during playback.

Press TITLE/POPUP during playback, and use ^/V/</> buttons to navigate through menu items.

Resume playback

BD **DVD** **AVCHD** **MOVIE** **ACD**
MUSIC

The unit records the point where you pressed the ■ (STOP) depending on the disc.

If "■■■ (Resume Stop)" appears on the screen briefly, press ► (PLAY) to resume playback (from the scene point).

If you press ■ (STOP) twice or unload the disc, "■" (Complete Stop) appears on the screen. The unit will clear the stopped point.



NOTE

- The resume point may be cleared when a button is pressed (for example; ⏻ (POWER), ▲ (OPEN/CLOSE), etc).
- On BD-Video discs with BD-J, the resume playback function does not work.
- If you press ■ (STOP) once during BD-ROM interactive title playback, the unit will be in Complete Stop mode.

4

Operation

Playing Blu-ray 3D™ disc

This player can play the Blu-ray 3D™ discs which contains separate views for the left and right eyes.

Preparation

In order to playback Blu-ray 3D™ title in stereoscopic 3D mode, you need to:

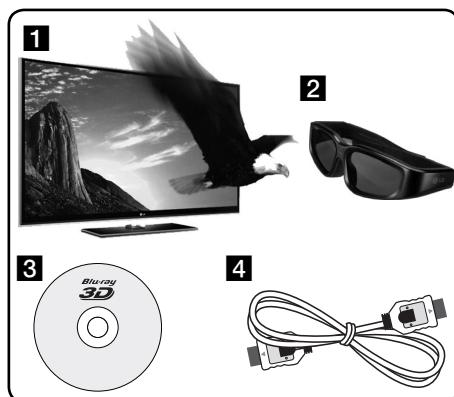

- 1** Check if your TV is 3D capable and has HDMI 1.4 input(s).
- 2** Wear 3D glasses to enjoy the 3D experience if it is necessary.
If you want to purchase additional 3D-ready glasses, contact the dealer that you purchased the 3D-ready TV from.
- 3** Check whether the BD-ROM title is the Blu-ray 3D™ disc or not.
- 4** Connect an HDMI cable (version 1.3 or higher) between the player's HDMI output and TV's HDMI input.

1. Press HOME (🏠), and set the [3D Mode] option on the [Setup] menu to [On] (page 39).
2. Insert a disc.
3. The playback starts automatically.



The 3D icon appears on the screen when 3D content is in playback.

4. Refer to the owner's manual of your 3D-ready TV for the further instruction.
You may need to adjust the display settings and focus on your TV's setting for the improved 3D effect.



CAUTION

- Watching a 3D content for a long period time may cause dizziness or tiredness.
- It is not recommended to watch a movie in 3D mode for infirm, child and pregnant woman.
- If you are experiencing headache, tiredness or dizziness while viewing contents in 3D, it is strongly recommended to stop the playback and rest until you feel normal.

Available Blu-ray 3D™ Discs



The "Blu-ray 3D™" logo labeled BD-ROM disc can be played on this player with 3D mode output. If your TV is not the Blu-ray 3D™-ready TV*, 2D mode output is available.



The "Blu-ray 3D™ ONLY" logo labeled BD-ROM disc can be played on this player with 3D mode output. The Blu-ray 3D™ ONLY disc playback is not available, if your TV or player are not the Blu-ray 3D™-ready device.

* **3D-ready TV** refers to TVs that are compliant with "HDMI 1.4 3D mandatory format" standard.



NOTE

The "Blu-ray 3D™" and "Blu-ray 3D™ ONLY" may not be printed on your BD-ROM disc, even if the disc contains 3D contents.

Advanced Playback

Repeat Playback

BD DVD AVCHD ACD MUSIC

During playback, press REPEAT repeatedly to select a desired repeat mode.

BDs/DVDs

 **A-** – Selected portion will be repeated continually.

 **Chapter** – The current chapter will be played back repeatedly.

 **Title** – The current title will be played back repeatedly.

To return to normal playback, press REPEAT repeatedly to select [Off].

Audio CDs/Music files

 **Track** – The current track or file will be played back repeatedly.

 **All** – All the tracks or files will be played back repeatedly.

 – The tracks or files will be played back in random order.

 **All** – All the tracks or files will be played back repeatedly in random order.

 **A-B** – Selected portion will be repeated continually. (Audio CD only)

To return to normal playback, press CLEAR.



NOTE

- If you press  once during Repeat Chapter/Track playback, the repeat playback cancels.
- This function may not work on some disc or title.

Repeating a specific portion

BD DVD AVCHD ACD

This player can repeat a portion you have selected.

1. During playback, press REPEAT to select [A-] at the beginning of the portion you wish to repeat. And then press ENTER ().
2. Press ENTER () at the end of the portion. Your selected portion will be repeated continually.
3. To return to normal playback, press REPEAT repeatedly to select [OFF] or press CLEAR.

NOTE

You cannot select a portion less than 3 seconds.

Marker Search

BD DVD AVCHD MOVIE

You can start playback from up to nine memorized points.

To enter a marker

1. During playback, press MARKER at the desired point. The Marker icon appears on the TV screen briefly.
2. Repeat step 1 to add up to nine markers.

To recall a marked scene

1. Press SEARCH and the search menu appears on the screen.
2. Press a number button to select a marker number that you want to recall. Playback starts from the marked scene.

To delete a Marker

1. Press SEARCH and the search menu appears on the screen.



2. Press V to highlight a marker number. Use </> to select a marked scene that you want to delete.
3. Press CLEAR and the marked scene is erased from the search menu.



NOTE

- This function may not work depending on discs, titles, server ability.
- All marked points are cleared if the title is in complete stop (■) mode, the title is changed or if you unload the disc.
- If the total length of the title is less than 10 seconds, this function is not available.

Using the search menu



Using search menu, you can easy to find the point where you want to start playback.

To search a point

1. During playback, press SEARCH to display the search menu.



2. Press </> to skip the playback 15 seconds forward or backward. You can select a point that you want to skip by pressing and holding </> button.

To start playback from a marked scene

1. Press SEARCH and the search menu appears on the screen.
2. Press V to highlight a marker number. Use </> to select a marked scene that you want to playback from.
3. Press ENTER (⊙) to start playback from the marked scene.



NOTE

- This function may not work depending on discs, titles, server ability.
- This function may not work on some [Home Link] contents depending on the file type and ability of the DLNA server.

Changing content list view

MOVIE MUSIC PHOTO

On the [Movie], [Music], [Photo] or [Home Link] menu, you can change the content list view.

Method 1

Press red (R) coloured button repeatedly.

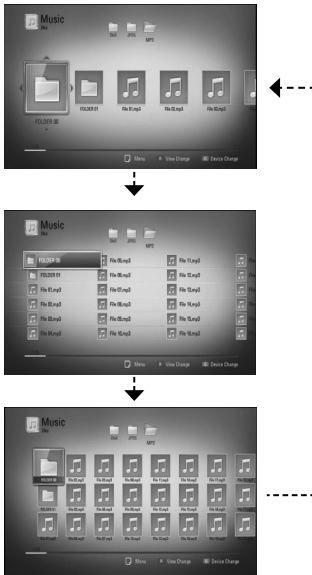

4 Operation

Method 2

1. On the content list, press INFO/DISPLAY (i) to display the option menu.
2. Use \wedge/\vee to select the [View Change] option.
3. Press ENTER (o) to change the content list view.

Viewing content information

MOVIE

The player can display the content information.

1. Select a file using $\wedge/\vee/</>$.
2. Press INFO/DISPLAY (i) to display the option menu.
3. Select the [Information] option using \wedge/\vee , and press ENTER (o).

The file information appears on the screen.

During movie playback, you can display the file information by pressing TITLE/POPUP.



NOTE

The information displayed on the screen may not be correct compared to the actual content information.

Last Scene Memory

BD DVD

This unit memorizes the last scene from the last disc that is viewed. The last scene remains in memory even if you remove the disc from the unit or switch off the unit. If you load a disc that has the scene memorized, the scene is automatically recalled.



NOTE

- Last Scene Memory function for a previous disc is erased once a different disc is played.
- This function may not work depending on the disc.
- This unit does not memorize settings of a disc if you switch off the unit before commencing to play it.

On-Screen display

You can display and adjust various information and settings about the content.

Displaying content information on-screen

BD DVD AVCHD MOVIE

1. During playback, press INFO/DISPLAY (ⓘ) to show various playback information.

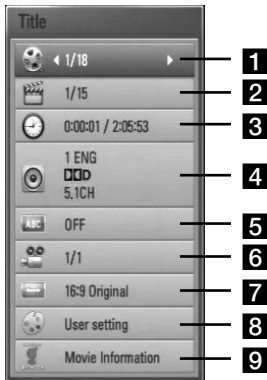

- 1 Title** – Current title number/total number of titles
- 2 Chapter** – Current chapter number/total number of chapters
- 3 Time** – Elapsed playing time/Total playback time
- 4 Audio** – Selected audio language or channel
- 5 Subtitle** – Selected subtitle
- 6 Angle** – Selected angle/total number of angles
- 7 TV Aspect Ratio** – Selected a TV aspect Ratio
- 8 Picture Mode** – Selected picture mode

- 9 Movie Information** – Select this option and press ENTER (Ⓜ) to display movie information

2. Select an option using Δ/∇ .
3. Use \leftarrow/\rightarrow to adjust the selected option value.
4. Press RETURN (↵) to exit the On-Screen display.

NOTE

- If no button is pressed for a few seconds, the on-screen display disappears.
- A title number cannot be selected on some discs.
- Available items may differ depending on discs or titles.
- If BD interactive title is playing back, some setting information is displayed on the screen but prohibited to be changed.
- To use the [Movie Information] option, the player must be connected to the broadband internet for accessing the Gracenote Media Database.
- If the music information from the Gracenote® media database is either not correct or not exist, please contact Gracenote® at <http://www.gracenote.com> for support.
- LG is a licence of Gracenote® technology and is not responsible or reliable for information from the Gracenote® media database.

Playing from selected time

BD DVD AVCHD MOVIE

1. Press INFO/DISPLAY (ⓘ) during playback. The time search box shows the elapsed playing time.
2. Select the [Time] option and then input the required start time in hours, minutes, and seconds from left to right.

For example, to find a scene at 2 hours, 10 minutes, and 20 seconds, enter "21020".

Press </> to skip the playback 60 seconds forward or backward.

3. Press ENTER (Ⓞ) to start playback from selected time.

! NOTE

- This function may not work on some disc or titles.
- This function may not work on some [Home Link] contents depending on the file type and ability of the DLNA server.

4

Operation

Hearing different audio

BD DVD AVCHD MOVIE

1. During playback, press INFO/DISPLAY (ⓘ) to display the on-screen display.
2. Use \wedge/\vee to select the [Audio] option.
3. Use </> to select desired audio language, audio track or audio channel.

! NOTE

- Some discs allow you to change audio selections only via the disc menu. If this is the case, press TITLE/POPOP or DISC MENU button and choose the appropriate audio from the selections on the disc menu.
- Immediately after you have switched sound, there may be a temporary discrepancy between the display and actual sound.
- On BD-ROM disc, the multi audio format (5.1CH or 7.1CH) is displayed with [MultiCH] in the on-screen display.

Selecting a subtitle language

BD DVD AVCHD MOVIE

1. During playback, press INFO/DISPLAY (ⓘ) to display the on-screen display.
2. Use \wedge/\vee to select the [Subtitle] option.
3. Use </> to select desired subtitle language.
4. Press RETURN (↵) to exit the On-Screen display.

! NOTE

Some discs allow you to change subtitle selections only via the disc menu. If this is the case, press TITLE/POPOP or DISC MENU button and choose the appropriate subtitle from the selections on the disc menu.

Watching from a different angle

BD DVD

If the disc contains scenes recorded at different camera angles, you can change to a different camera angle during playback.

1. During playback, press INFO/DISPLAY (i) to display the on-screen display.
2. Use \wedge/\vee to select the [Angle] option.
3. Use $\lt;/\gt$ to select desired angle.
4. Press RETURN (↵) to exit the On-Screen display.

Changing the TV Aspect Ratio

BD DVD AVCHD MOVIE

You can change the TV aspect ratio setting during playback.

1. During playback, press INFO/DISPLAY (i) to display the on-screen display.
2. Use \wedge/\vee to select the [TV Aspect Ratio] option.
3. Use $\lt;/\gt$ to select desired option.
4. Press RETURN (↵) to exit the On-Screen display.

NOTE

Even if you change the value of the [TV Aspect Ratio] option in On-Screen display, the [TV Aspect Ratio] option in the [Setup] menu is not changed.

Changing the Picture Mode

BD DVD AVCHD MOVIE

You can change the [Picture mode] option during playback.

1. During playback, press INFO/DISPLAY (i) to display the on-screen display.
2. Use \wedge/\vee to select the [Picture Mode] option.
3. Use $\lt;/\gt$ to select desired option.
4. Press RETURN (↵) to exit the On-Screen display.

Setting the [User setting] option

1. During playback, press INFO/DISPLAY (i) to display the on-screen display.
2. Use \wedge/\vee to select the [Picture Mode] option.
3. Use $\lt;/\gt$ to select the [User setting] option, and press ENTER (⊙).



4. Use $\wedge/\vee/\lt;/\gt$ to adjust the [Picture Mode] options.
Select [Default] option then press ENTER (⊙) to reset the all adjustments.
5. Use $\wedge/\vee/\lt;/\gt$ to select the [Close] options, and press ENTER (⊙) to finish setting.

Enjoying BD-Live™

This unit allows you to enjoy functions such as picture-in-picture, secondary audio and Virtual packages, etc., with BD-Video supporting BONUSVIEW™ (BD-ROM version 2 Profile 1 version 1.1/ Final Standard Profile).

Secondary video and audio can be played from a disc compatible with the picture-in-picture function. For the playback method, refer to the instructions in the disc.

In addition to the BONUSVIEW™ function, BD-Video supporting BD-Live™ (BD-ROM version 2 Profile 2) that has a network extension function allows you to enjoy more functions such as downloading new movie trailers by connecting this unit to the internet.

4

Operation

1. Check the network connection and settings (page 31).
2. Insert a USB storage device.

A USB storage device is needed to download bonus content.

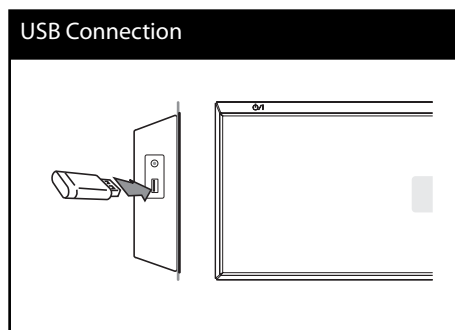

3. Press Home (🏠), and set the [BD-LIVE connection] option on the [Setup] menu (page 43).

Depending on the disc, the BD-Live™ function may not operate if [BD-LIVE connection] option is set to [Partially Permitted].

4. Insert a BD-ROM with BD-Live™.

The operations may differ depending on the disc. Refer to the manual supplied with the disc.



NOTE

- Do not extract the connected USB device while content is being downloaded or a Blu-ray disc™ is still. Doing so may damage the connected USB device and BD-Live™ features may not operate properly with the damaged USB device anymore. If the connected USB device seems damaged from such an action, you can format the connected USB device from the PC and reuse it with this player.
- Some BD-Live™ contents may be restrictively accessed in some territories by contents provider's own decision.
- It may take up to several minutes to load and start enjoying BD-Live™ contents.

Playing a movie file and VR disc

You can play DVD-RW discs that are recorded in Video Recording (VR) format and movie files contained in a disc or USB device.

1. Press HOME (🏠).



2. Select [Movie] using </>, and press ENTER (⊙).
3. Select the device using </>, and press ENTER (⊙).

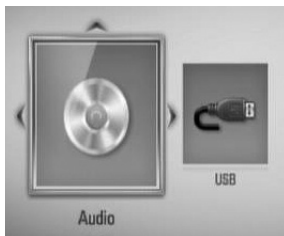

When you connect up to two devices, it appears as above.

4. Select a file using ^/V/</>, and press PLAY or ENTER (⊙) to play the file.

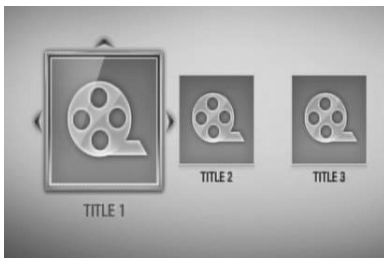

NOTE

- The file requirements are described on page 11.
- You can use various playback functions. Refer to pages 46-55.
- Unfinalized DVD VR format discs may not be played in this player.
- Some DVD-VR disc are made with CPRM data by DVD recorder. This unit cannot support these kinds of discs.

What is CPRM?
 CPRM is a copy protection system (with scramble system) only allowing the recording of 'copy once' broadcast programmes. CPRM stands for Content Protection for Recordable Media.

Selecting a subtitle file

MOVIE

If a movie file name and the subtitle file name are the same, subtitle file is played automatically when playing the movie file.

If the subtitle file name is different with the movie file name, you need to select the subtitle file on the [Movie] menu before playing the movie.

1. Use $\wedge/V/</>$ to select the subtitle file you wish to play in the [Movie] menu.
2. Press ENTER (⊙).



Press ENTER (⊙) again to deselect the subtitle file. Selected subtitle file will be displayed when you play the movie file.

! NOTE

- If you press ■ (STOP) during playback, the subtitle selection is cancelled.
- This function may not work in the [Home Link] feature.

Changing subtitle code page

MOVIE

If the subtitle is not displayed properly, You can change the subtitle code page to view the subtitle file properly.

1. During playback, press INFO/DISPLAY (⏏) to display the on-screen display.
2. Use \wedge/V to select the [Code Page] option.
3. Use $</>$ to select desired code option.

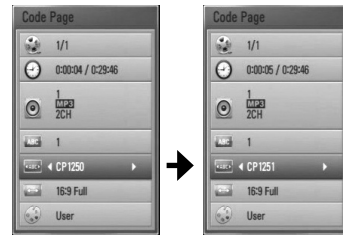

4. Press RETURN (↵) to exit the On-Screen display.

Viewing a photo

You can view photo files using this player.

1. Press HOME (🏠).

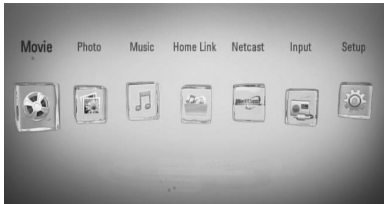

2. Select [Photo] using </>, and press ENTER (⊙).
3. Select the device using </>, and press ENTER (⊙).

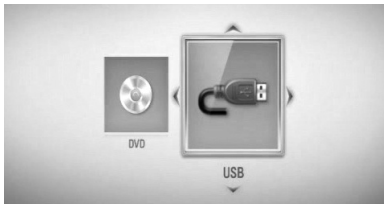

When you connect up to two devices, it appears as above.

4. Select a file using ^/v/</>, and press ENTER (⊙) to view the photo.

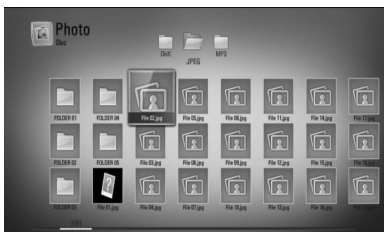

To play a slide show

Press ► (PLAY) to start slide show.

To stop a slide show

Press ■ (STOP) while slide show.

To pause a slide show

Press || (PAUSE) while slide show.

Press ► (PLAY) to re-start the slide show.

To skip to the next/previous photo

While viewing a photo in full screen, press < or > to go to the previous or next photo.

NOTE

- The file requirements are described on page 11.
- You can use various playback functions. Refer to pages 46-55.

Options while viewing a photo

You can use various options during viewing a photo in full screen.

1. While viewing a photo in full screen, press INFO/DISPLAY (i) to display the option menu.
2. Select an option using Δ/V .



- 1 Current photo/Total number of photos** – Use \leftarrow/\rightarrow to view previous/next photo.
- 2 Slide Show** – Press ENTER (⊙) to start or pause slide show.
- 3 Music Select** – Select the background music for the slide show.
- 4 Music** – Press ENTER (⊙) to start or pause background music.
- 5 Rotate** – Press ENTER (⊙) to rotate the photo clockwise.
- 6 Zoom** – Press ENTER (⊙) to display the [Zoom] menu.
- 7 Effect** – Use \leftarrow/\rightarrow to select a transition effect between photos in a slide show.
- 8 Speed** – Use \leftarrow/\rightarrow to select a delaying speed between photos in a slide show.

3. Press RETURN (↵) to exit the option menu.

Listening to music while slide show

You can display photo files while listening to music files.

1. Press HOME (🏠).

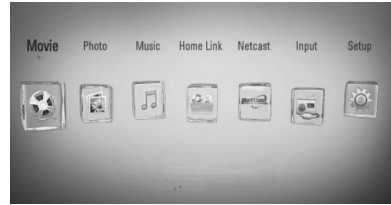

2. Select [Photo] or [Home Link] using \leftarrow/\rightarrow , and press ENTER (⊙).
3. Select the [Disc] or [USB] option using \leftarrow/\rightarrow , and press ENTER (⊙).

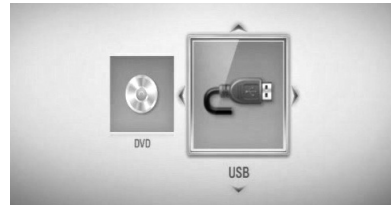

Selecting a server or a share folder is needed for [Home Link] menu.

4. Select a file using $\Delta/V/\leftarrow/\rightarrow$, and press ENTER (⊙) to view the photo.
5. Press INFO/DISPLAY (i) to display the option menu.
6. Use Δ/V to select [Music Select] option, and press ENTER (⊙) to display the [Music Select] menu.

- Use \wedge/V to select a device, and press ENTER (⊙).

Devices that you can select may differ depending on the location of the photo file you are displaying in full screen.

Photo location	Available Device
Disc	Disc, USB
USB	Disc, USB
Share Folder on your PC (CIFS)	CIFS
DLNA server	DLNA server

- Use \wedge/V to select a file or a folder you wish to play.

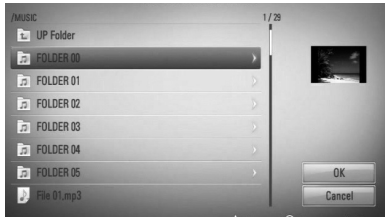

Select a folder and press ENTER (⊙) to display the lower directory.

Select \updownarrow and press ENTER (⊙) to display the upper directory.

NOTE

When selecting music from [Home Link], folder selection is not available. Only file selection is available on the [Home link].

- Use \gt to select [OK], and press ENTER (⊙) to complete music selection.

Listening to music

The player can play Audio CDs and music files

- Press HOME (🏠).



- Select [Music] using \leftarrow/\rightarrow , and press ENTER (⊙).

- Select the device using \leftarrow/\rightarrow , and press ENTER (⊙).

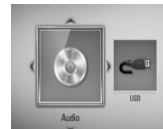

When you connect up to two devices, it appears as above.

- Select a music file or audio track using $\wedge/V/\leftarrow/\rightarrow$, and press ENTER (⊙) to play the music.

NOTE

- The file requirements are described on page 11.
- You can use various playback functions. Refer to pages 46-55.



Audio CD Recording



You can record one desired track or all of the tracks in Audio CD to a USB storage device.

1. Insert a USB storage device to the USB port on the front panel.
2. Insert CD
The playback starts automatically.
3. Press INFO/DISPLAY () to display the option menu.

Or

Press ● REC button on the remote control.
You can record all musics in the audio CD.

4. Use \wedge/\vee to select [CD Recording] option, and press ENTER () to display the [CD Recording] menu.
Repeat this step to select tracks as many as you want.
5. Use \wedge/\vee to select a track you wish to copy on the menu, and press ENTER ().
Repeat this step to select tracks as many as you want.

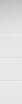

	Select all the tracks on an Audio CD.
	Selects an encoding option from the pop-up menu (128 kbps, 192 kbps, 320 kbps or Lossless).
	Cancels the recording and returns to the previous screen.

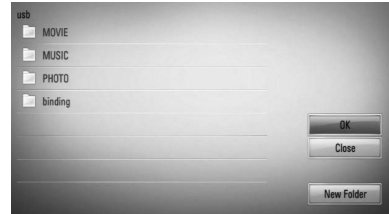
6. Use $\wedge/\vee/</>$ to select [Start], and press ENTER ().
7. Use $\wedge/\vee/</>$ to select the destination folder to be copied.



If you want to create a new folder, use $\wedge/\vee/</>$ to select [New Folder] and press ENTER ().

Enter a folder name using the virtual keyboard, and press ENTER () while [OK] is selected.

8. Use $\wedge/\vee/</>$ to select [OK], and press ENTER () to start Audio CD recording.
If you want to stop in progressing Audio CD recording, press ENTER () while [Cancel] is highlighted.
9. A message appears when Audio CD recording is completed. Press ENTER () to check the music file created in the destination folder.

NOTE

- The table below shows the average recording time from an audio track with 4 minutes of playback time to a music file with 192 kbps as an example.

stop mode	during playback
1.4 min.	2 min.

- All times in the above table are approximate.
- Actual recording time for USB storage device varies depending on the USB storage device's ability.
- Make sure that there is minimum of 50 MB free space when recording into the USB storage device.
- The length of the music should be longer than 20 seconds for the proper recording.
- Do not turn off this player or extract the connected USB storage device during Audio CD recording.

The making of unauthorized copies of copy-protected material, including computer programmes, files, broadcasts and sound recordings, may be an infringement of copyrights and constitute a criminal offense. This equipment should not be used for such purposes.

**Be responsible
Respect copyrights**

Viewing information from Gracenote Media Database

The player can access to the Gracenote Media Database and loads the music information so that Track name, Artist Name, Genre and other text information can be displayed on the list.

Audio CD

When you insert an Audio CD, the player starts playback automatically and load the music title from the Gracenote® Media Database.

If there is no music information from the database, music titles will not appear on the screen.

Music file

1. Select a music file or audio track using $\wedge/V/</>$.
2. Press INFO/DISPLAY (□) to display the option menu.
3. Select the [Information] option using \wedge/V , and press ENTER (⊙).

The player accesses Gracenote Media Database for the music information.

BD/DVD

While listening to music from the movie playback, press MUSIC ID to start loading music information from the Gracenote Media Database.

! NOTE

- The player must be connected to the broadband internet for accessing the Gracenote® Media Database.
- If the music information is not in the Gracenote® Media Database, message appears on the screen.
- If the music information from the Gracenote® media database is either not correct or not exist, please contact Gracenote® at <http://www.gracenote.com> for support.
- Depending on the cases, it will takes a few minutes to load music information from the Gracenote® media database.
- Information may be displayed in broken letters, if the language you selected is not available on the Gracenote Media Database.
- This function is not available for NetCast on-line content and content in DLNA servers.
- LG is a licence of Gracenote® technology and is not responsible or reliable for information from the Gracenote® media database.
- Audio CDs that users made for their only private purposes cannot be supported in this feature because they are not in the Gracenote Media Database.

Playing the iPod

Preparation

- Before connecting the iPod, turn this unit off and reduce the volume of this unit to its minimum.

1. Connect the iPod firmly.

If you turn this unit on, your iPod is automatically turned on and recharging starts.

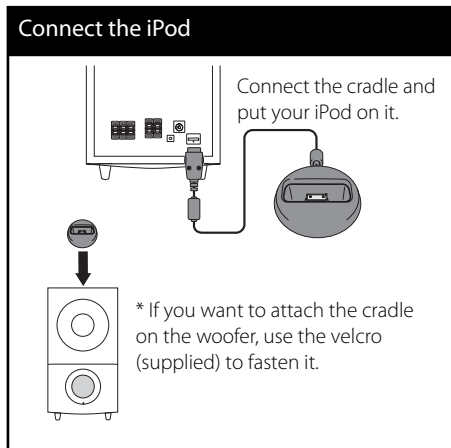

2. Press RADIO&INPUT to select iPod IN mode.

▲/▼/◀/▶	Selects an option in the menu.
▶/ENTER	Starts playback.
	To pause while it is playing. To resume playing, press ▶ (PLAY) again.
◀◀/▶▶	Fast-forward or rewind a song
◀◀/▶▶	Skip the playback forward or backward .
REPEAT	To select a desired repeat mode: Track (🔁), All (🔁), Off (No display).

! NOTE

- An error message “CHECK IPOD” or “Connected iPod model is not supported” appears when:
 - your iPod is not available for the function to be operated.
- An error message “CHECK IPOD” or “Please update iPod’s software.” appears when:
 - your iPod has an old software version.
 - Update your iPod software to latest version.
- If this unit displays an error message, follow the message. An error message “CHECK IPOD” or “Please check your iPod.” appears when:
 - the communication between this unit and your iPod is failed.
 - Undock & re-dock your iPod in this unit.
 - your iPod is not connected firmly.
 - this unit recognises your iPod as unknown device.
 - your iPod is exceptionally low on power.
 - The battery needs to be charged.
 - If you charge the battery while iPod is extremely low in power, it may take longer to charge.
- You may use the dock adapter which should be supplied with your iPod to the dock for the stable use of the iPod. If you need an adapter, consult your iPod dealer.
- Compatibility with your iPod may vary depending on the type of your iPod.
- iPod touch and iPhone have any difference in operation other than iPod. You may need any additional control to use them with this unit. (e.g. “slide to unlock”)
- If you use an application, make a call, or send and receive SMS text message, etc. on iPod touch or iPhone, disconnect it from iPod dock of this unit and then use it.
- Depending on your iPod’s software version, it may not be possible to control your iPod from this unit. We recommend installing the latest software version.
- If you have a problem with your iPod, please visit www.apple.com/support/ipod.

Radio Operations

Be sure that the antenna is connected.
(Refer to the page 29)

Listening to the radio

1. Press RADIO&INPUT until TUNER (FM) appears in the display window. The last received station is tuned in.
2. Press and hold TUNING (-/+) for about two seconds until the frequency indication starts to change. Scanning stops when the unit tunes in a station. Or Press TUNING (-/+) repeatedly.
3. Adjust the volume by pressing VOL (+/-) on the remote control.

Presetting the Radio Stations

You can preset 50 stations for FM.
Before tuning, make sure that you have turned down the volume.

1. Press RADIO&INPUT until the TUNER (FM) appears in the display window.
2. Select the desired frequency by using TUNING (-/+).
3. Press ENTER (⊙) a preset number will flash in the display window.
4. Press PRESET (-/+) to select the preset number you want.
5. Press ENTER (⊙). The station is stored.
6. Repeat the steps 2 to 5 to store other stations.

Deleting all the saved stations

Press and hold CLEAR for two seconds. "ERASE ALL" will flash up. Press CLEAR again. Then all the saved stations are deleted.

Improving poor FM reception

Press B (blue) (MONO/STEREO) coloured button on the remote control. This will change the tuner from stereo to mono and usually improve the reception.

See information about a radio station

The FM tuner is supplied with the RDS (Radio Data System) facility. This shows information about the radio station being listened to. Press RDS repeatedly to cycle through the various data types:

PS	(Programme Service Name) The name of the channel will appear in the display
PTY	(Programme Type Recognition) The programme type (e.g. Jazz or News) will appear in the display.
RT	(Radio Text) A text message contains special information from the broadcast station. This text may scroll across the display.
CT	(Time controlled by the channel) This shows the time and date as broadcast by the station.

Playing content via your home network

This Player can browse and play content from your PC and DLNA certified media servers connected on your home network.

About DLNA

This Player is a DLNA Certified digital media player that can display and play movie, photo and music content from your DLNA-compatible digital media server (PC and Consumer Electronics).

The Digital Living Network Alliance (DLNA) is a cross-industry organization of consumer electronics, computing industry and mobile device companies. Digital Living provides consumers with easy sharing of digital media through a wired or wireless network in the home.

The DLNA certification logo makes it easy to find products that comply with the DLNA Interoperability Guidelines. This unit complies with DLNA Interoperability Guidelines v1.5.

When a PC running DLNA server software or other DLNA compatible device is connected to this player, some setting changes of software or other devices may be required. Please refer to the operating instructions for the software or device for more information.

Accessing a DLNA media server

1. Check the network connection and settings (page 31).
2. Press HOME (🏠).
3. Select [Home Link] using </>, and press ENTER (⊙).
4. Select a DLNA media server from the list using ▲/▼, and press ENTER (⊙).

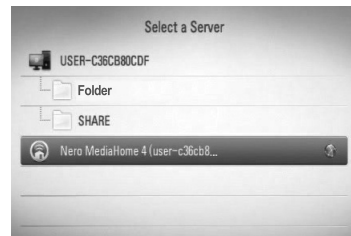

If you want to rescan for available media servers, press the green (G) coloured button.

NOTE

Depending on the media server, this player may need to get permission from the server.

5. Select a file using ▲/▼/</>, and press ENTER (⊙) to play the file.



**NOTE**

- The file requirements are described on page 11.
- You can use various playback functions. Refer to pages 46-55.
- Because the compatibility and available playback functions on the [Home Link] menu are tested on the bundle DLNA server (Nero MediaHome 4 Essentials) environment, file requirements and playback functions on the [Home Link] menu may differ depending on media servers.
- The file requirements on page 11 are not always compatible. There may have some restrictions by file features and media server's ability.
- The thumbnail of the unplayable files can be displayed in the [Home Link] menu, but those cannot be played on this player.
- If there is an unplayable music file in the [Home Link] menu, the player skips the file and plays the next file.
- Playing movie subtitle files are only available on DLNA media server created by supplied Nero MediaHome 4 Essentials software on this player package.
- The subtitle file name and movie file name have to be the same and located at the same folder.
- The playback and operating quality of the [Home Link] function may be affected by your home network condition.
- The files from removable media such as USB drive, DVD-drive etc. on your media server may not be shared properly.

About Nero MediaHome 4 Essentials

Nero MediaHome 4 Essentials is a software for sharing movie, music and photo files stored on your computer with this player as a DLNA-compatible digital media server.

**NOTE**

- The Nero MediaHome 4 Essentials CD-ROM is designed for PCs and should not be inserted in this player or in any product other than a PC.
- The supplied Nero MediaHome 4 Essentials CD-ROM is a customized software edition only for sharing files and folders with this player.
- The supplied Nero MediaHome 4 Essentials software does not support following functions: Transcoding, Remote UI, TV control, Internet services and Apple iTunes
- This manual explains operations with the English version of Nero MediaHome 4 Essentials as examples. Follow the explanation referring to the actual operations of your language version.

Installing Nero MediaHome 4 Essentials

Before you install Nero MediaHome 4 Essentials, check the system requirement shown below.

- Windows® XP (Service Pack 2 or higher), Windows Vista® (no Service Pack required), Windows® XP Media Centre Edition 2005 (Service Pack 2 or higher), Windows Server® 2003
- Windows Vista® 64-bit edition (application runs in 32-bit mode)
- Hard drive space: 200 MB hard drive space for a typical installation of Nero MediaHome stand-alone
- 1.2 GHz Intel® Pentium® III or AMD Sempron™ 2200+ processors
- Memory: 256 MB RAM

- Graphics card with at least 32 MB video memory, minimum resolution of 800 x 600 pixels, and 16-bit colour settings
- Windows® Internet Explorer® 6.0 or higher
- DirectX® 9.0c revision 30 (August 2006) or higher
- Network environment: 100 Mb Ethernet, WLAN (IEEE 802.11b/g)

Start up your computer, and insert the Nero MediaHome 4 Essentials CD-ROM into your computer's CD-ROM drive. An installation wizard will walk you through the quick and uncomplicated installation process. To install Nero MediaHome 4 Essentials, proceed as follows:

1. Close all Microsoft Windows programmes and exit any anti-virus software that may be running.
2. Insert the Nero MediaHome 4 Essentials CD-ROM into your computer's CD-ROM drive.
3. Click [Nero MediaHome 4 Essentials]. The installation is prepared and the installation wizard appears.
4. Click the [Next] button to display the serial number input screen. Click [Next] to go to the next step.
5. If you accept all conditions, click [I accept the Licence Conditions] check box and click [Next]. Installation is not possible without this agreement.
6. Click [Typical] and click [Next]. The installation process is started.
7. If you want to take part in the anonymous collection of data, select the check box and click the [Next] button.
8. Click the [Exit] button to complete the installation.

Sharing files and folders

On your computer, you must share the folder contained movie, music and/or photo content to play them using [Home Link] features.

This part explains the procedure for selecting the shared folders on your computer.

1. Double-click the "Nero MediaHome 4 Essentials" icon on the desktop.
2. Click [Network] icon on the left and define your network name in the [Network name] field. The Network name you enter will be recognised by your player.
3. Click [Shares] icon on the left.
4. Click [Local Folders] tab on the [Shares] screen.
5. Click [Add] icon to open the [Browse Folder] window.
6. Select the folder containing the files you want to share. The selected folder is added to the list of shared folders.
7. Click [Start Server] icon to start the server.



NOTE

- If the shared folders or files are not displayed on the player, click the folder on the [Local Folders] tab and click [Rescan Folder] at the [More] button.
- Visit www.nero.com for more information and software tools.

Accessing a share folder from your PC

1. Start your PC that connected on your local area network.
2. On your PC, share folders which contain movie, photo or music files.
3. On the player, check the network connection and settings (page 31).
4. Press HOME (🏠).
5. Select [Home Link] using </>, and press ENTER (⊙).
6. Select a share folder from the list using ▲/▼, and press ENTER (⊙).

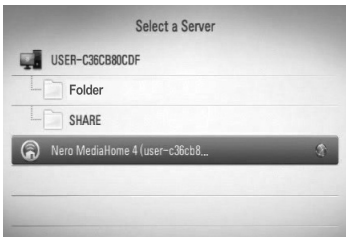

If you want to rescan available media servers, press the green(G) coloured button.

! NOTE

Depending on the share folder, this player may need to input network user ID and password for accessing the folder.

7. Select a file using ▲/▼/</>, and press ENTER (⊙) to play the file.

! NOTE

- The file requirements are described on page 11.
- You can use various playback functions. Refer to pages 46-55.
- The thumbnail of the unplayable files can be displayed in the [Home Link] menu, but those cannot be played on this player.
- If there is an unplayable music file in the [Home Link] menu, the player skips the file and play next file.
- The subtitle file name and movie file name have to be the same and located at the same folder.
- The playback and operating quality of the [Home Link] function may be affected by your home network condition.
- The files on a removable media such as USB drive, DVD-drive etc. on your PC may not be shared properly.
- You may experience connection problems depending on your PC's environment.

PC requirements

- Windows® XP (Service Pack 2 or higher), Windows Vista® (no Service Pack required) Windows 7®
- 1.2 GHz Intel® Pentium® III or AMD Sempron™ 2200+ processors
- Network environment: 100 Mb Ethernet, WLAN (IEEE 802.11b/g)

! NOTE

If you use Windows® XP or Windows Vista®, visit link below for more information on file share settings.

Windows® XP:
[http:// support.microsoft.com/kb/304040](http://support.microsoft.com/kb/304040)

Windows Vista®:
[http:// support.microsoft.com/kb/961498](http://support.microsoft.com/kb/961498)

Entering a network user ID and the password

Depending on your PC's environment, you may need to enter a network user ID and the password for accessing a shared folder.

1. The keyboard menu appears automatically if the network user ID and the password are required.
2. Use $\wedge/\vee/\lt;/\gt;$ to select a character then press ENTER (Ⓢ) to confirm your selection on the keyboard menu.

To enter a letter with an accent mark, select the letter from extended character set.

Example: Select "D" and then press INFO/DISPLAY (Ⓢ) to display the extended character set. Use $\lt;/\gt;$ to select "D" or "Ď" and then press ENTER (Ⓢ).

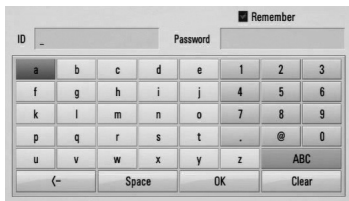

-
- [Clear]** – Clear all entered characters.

 - [Space]** – Inserts a space at the cursor position.

 - [<-]** – Deletes the previous character at the cursor position.

 - [ABC / abc / #+==&]** – Change the keyboard menu settings to capital letters, small letters or symbols.

3. When you finish entering the network user ID and password, select [OK] using $\wedge/\vee/\lt;/\gt;$ and press ENTER (Ⓢ) to access the folder.

The network user ID and password will be remembered after accessing the folder for your convenience. If you do not want the network user ID and password to be remembered, press red (R) coloured button to un-tick the [Remember] check box before accessing the folder.

Using NetCast™ Entertainment Access

You can use various content services via Internet with NetCast Entertainment Access feature.

1. Check the network connection and settings (page 31).
2. Press HOME (🏠).
3. Select the [NetCast] using </>, and press ENTER (⊙).
4. Select an option using </>, and press ENTER (⊙).

YouTube – See page 72

Picasa Web Albums – See page 76

AccuWeather – See page 79

5. While enjoying on-line content from NetCast, press blue (B) coloured button to go to NetCast Home screen.

! NOTE

- The content of NetCast services and service related information, including user interface, is subject to changes. Please refer to the web site of each service for most up-to-date information.
- The background image on the NetCast home indicates the weather of your favorite city in the AccuWeather feature.

YouTube

You can browse, search and watch YouTube videos over the internet on your TV via your LG Blu-ray disc™ player.

Watch YouTube videos on your TV

1. On the player, select the [YouTube] option in the [NetCast] menu using </>, and press ENTER (⊙).
2. Press \wedge to select the option menu bar.
3. Use </> to select an option and press ENTER (⊙) to search for videos.
4. Use </> to select a video and press ENTER (⊙) or \blacktriangleright (play) to play the video.

Button	Operation
\blacktriangleright or ENTER	Starts playback of the video with content detail.
INFO/DISPLAY	Toggle between playback in full screen and playback screen with content detail.
	To pause a video while it is playing. To resume playing a paused video, press \blacktriangleright again.
■	Stops the video and displays related videos list.
$\blacktriangleleft/\blacktriangleright$	Skip the playback forward or backward .

About the YouTube menu

There are various options on the YouTube menu. Use $\wedge/V/</>$ to select an option and press ENTER (⊙) to select the options as described below.

Featured – The featured videos list will be displayed.

Recent Videos – The most recently updated videos list will be displayed.

Most Viewed – The most viewed videos list will be displayed. The period option appears at the bottom of the screen.

Top Rated – The best rated videos list from YouTube server will be displayed. The period option appears at the bottom of the screen.

Search – The virtual keyboard will be displayed. See “Searching videos” on page 75 for more detail.

History – The videos list that you previously played on this unit will be displayed. Maximum of 25 videos can be stored.

Favorites – This option will only appear only when the unit is in sign-in status. Displays the videos list that is arranged in the YouTube server with your account. Some videos may not appear on the [Favorites] list, even if the videos are arranged in the server.

Sign in (Sign Out) – Displays the virtual keyboard to sign in or returns to the sign-out status.

See “Sign in with your YouTube account” on page 75 for more details.

Local site – Choose which country’s videos you would like to view. The countries listed on the [Local Site] menu may be different from those listed on the YouTube web site.



NOTE

- The YouTube menu can display 5 videos in the videos list. Press green (G) or yellow (Y) buttons to display previous/next 5 videos.
- If you select the [Most Viewed] or [Top Rated] option in the YouTube menu, the period options appear at the bottom of the screen. Use $\wedge/V/</>$ to select a period option and press ENTER (⊙) to display the videos list within the selected period.
- The videos list located using this player may be different from the list when searching via a PC.
- The playback of YouTube videos may be paused, stopped or buffering occurring often depending on your broadband speed.
We recommend a minimum connection speed of 1.5 Mbps. For the best playback condition, a connection speed of 4.0 Mbps is required. Sometimes your broadband speed varies based on your ISP’s network conditions. Contact your ISP if you have problems maintaining a fast connection that is reliable, or if you want to increase your connection speed. Many ISPs offer a variety of broadband speed options.

Using the virtual keyboard

On the virtual keyboard, there are two input modes for the entering a character. Press the yellow (Y) coloured button to toggle the display between keyboard mode and keypad mode.

Keyboard Mode

Use $\wedge/\vee/\lt;/\gt$ to select a letter on the screen, and press ENTER (⊙) to confirm your selection.



Keypad Mode

This mode allows you to enter letters by pressing the buttons on the remote control. Press the buttons with the required letter once, twice, three or four times until the letter is displayed.



4

Operation

[Cancel] – Return to the previous screen.

[Space] – Inserts a space at the cursor position.

[Backspace] – Deletes the previous character at the cursor position.

[ABC / abc / #+==&] – Changes the virtual keyboard settings to capital letters, small letters or symbols.

Press CLEAR to clear all entered characters.

To enter a letter with an accent mark:

1. Select a letter using $\wedge/\vee/\lt;/\gt$ on the virtual key board.
2. Press INFO/DISPLAY (⏏) to display the extended character set.
3. Use $\lt;/\gt$ to select a character then press ENTER (⊙).

Available languages to enter on the keyboard mode are as follows: English, Spanish, Italian, French, German, Dutch, Portuguese, Swedish, Polish and Czech.

Button	Operation
CLEAR	Deletes the previous character at the cursor position.
REPEAT	Inserts a space at the cursor position.
\ll/\gg	Change the character set of the remote control (#+==&, 123, ABC or abc)

NOTE

The keypad mode is available only in the [YouTube] and [Picasa Web Albums] features.

Searching videos

You can search for videos by entering search words of up to 128 characters.

1. Use </> to select [Search] option from the menu and press ENTER (⊙) to display the virtual keyboard.

Refer to "Using the virtual keyboard" on page 74 for using the virtual keyboard.

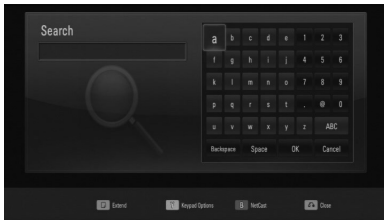

When you are entering a character, a maximum of 5 suggestion words will be displayed.

2. When you finish entering the search words, select [OK] and press ENTER (⊙) to display the related video list.

Sign in with your YouTube account

To watch videos from your [Favorites] video list on the YouTube server with your account, you need to sign in with your YouTube account.

1. Use </> to select the [Sign In] option from the menu and press ENTER (⊙) to display the virtual keyboard.
2. Use ^/v/</> to select a character then press ENTER (⊙) to confirm your selection on the virtual keyboard.

Refer to "Using the virtual keyboard" on page 74 for using the virtual keyboard.

3. When you finish entering the user name and the password, select [OK] and press ENTER (⊙) to sign in.
4. If you want to sign out, select the [Sign Out] from the YouTube menu and press ENTER (⊙).

This unit can automatically store up to 5 username which were previously signed-in. The user name list appears when you select the [Sign In] option.

Select a stored user name on the list and press ENTER (⊙) to display the keyboard menu with the selected user name entered. You will then only need to enter the password to sign in.

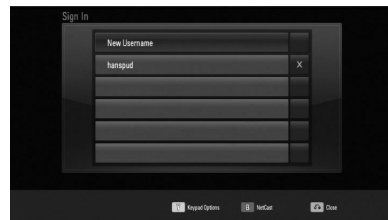

Select the [X] symbol and press ENTER (⊙) to delete the stored user name.

Picasa Web Albums

Enjoy photo albums from friends and family on the Picasa Web Albums on-line service.

View Picasa Web Albums on your TV

1. On the player, select the [Picasa Web Albums] option in the [NetCast] menu using </>, and press ENTER (⊙).
Featured photos are displayed on the screen.
2. Use \wedge/\vee / \leftarrow/\rightarrow to select a photo and press ENTER (⊙) to view the photo in full screen.

Button	Operation
▶	Starts a slide show.
INFO/DISPLAY	Displays the photo option menu.
⏸	Pauses a slide show. To resume slide show, press ▶ again.
■	Stops the slide show and return to the Picasa Web Albums menu.
</>	Moves to the next or previous photo.

4 Operation

Options while viewing a photo

You can use various options during viewing a photo in full screen.

1. While viewing a photo in full screen, press INFO/DISPLAY (□) to display the option menu.
2. Select an option using \wedge/\vee .

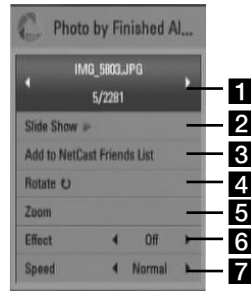

- 1 Current photo/Total number of photos** – Use </> to view previous/next photo.
- 2 Slide Show** – Press ENTER (⊙) to start or pause slide show.
- 3 Add to NetCast Friends List** – Add the current photo owner to my friend list.
- 4 Rotate** – Press ENTER (⊙) to rotate the photo clockwise.
- 5 Zoom** – Press ENTER (⊙) to display the [Zoom] menu.
- 6 Effect** – Use </> to select a transition effect between photos in a slide show.
- 7 Speed** – Use </> to select a delay time between photos in a slide show.

3. Press RETURN (↵) to exit the option menu.

About the Picasa Web Albums menu

There are various options on the Picasa Web Albums menu. Use $\wedge/\vee/</>$ to select an menu option and press ENTER (Ⓞ) to select the options as described below.

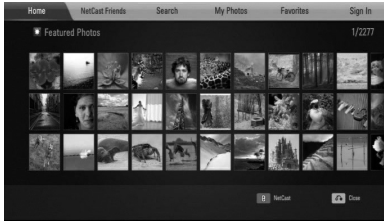

Home – The featured photo list will be displayed.

NetCast Friends – List of your friends will be displayed.

Search – Enter a search word to find related photos. The virtual keyboard will be displayed (page 78).

My Photos – Displays the photos organised in my Picasa Web Albums. This option is available only when the unit is in sign-in status.

Favorites – Displays up to 50 favorite web albums that are arranged in the Picasa Web Albums server with your account. This option is available only when the unit is in sign-in status.

Sign in (Sign Out) – Displays the virtual keyboard to sign in or returns to the sign-out status (page 78)

NOTE

Photos displayed in [My Photos] and [Favorites] may differ from the photos from a web browser on PC.

Adding friends

If you add your friends on the [NetCast Friends] menu, you can see the photos of your friend's public photos directly.

1. Select the [NetCast Friends] on the Picasa Web Albums menu using $\wedge/\vee/</>$, and press ENTER (Ⓞ).

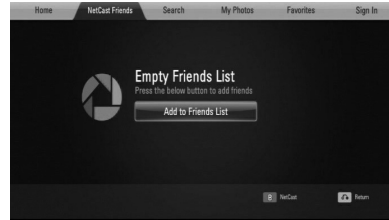

2. Press ENTER (Ⓞ) to display the virtual keyboard.
3. Enter a name using the virtual keyboard. Refer to "Using the virtual keyboard" on page 74 for using the virtual keyboard.
4. Select [OK] using $\wedge/\vee/</>$, and press ENTER (Ⓞ) to display the web album of your friend.

NOTE

- If you want to delete your friend from the list, press green (G) coloured button while the web album is selected.
- If you want to add more friends, press red (R) coloured button on the list.
- You can add more web albums of your friends up to 50.

Searching photos

You can enter a search word to find related photos.

1. Select the [Search] on the Picasa Web Albums menu using $\wedge/\vee/</>$, and press ENTER (⊙).
2. Enter a search word using the virtual keyboard.
Refer to "Using the virtual keyboard" on page 74 for using the virtual keyboard.
3. Select [OK] using $\wedge/\vee/</>$, and press ENTER (⊙) to display the search result.

3. Enter the password using the virtual keyboard, and press ENTER (⊙) while [OK] is selected.
Your web album is displayed on the screen.

4. If you want to sign out, select the [Sign Out] from the Picasa Web Albums menu and press ENTER (⊙).

This unit can automatically store up to 5 user names which were previously signed-in. The user name list appears when you select the [Sign In] option.

Select a stored user name on the list and press ENTER (⊙) to display the virtual keyboard with the selected user name is entered. You will then only need to enter the password to sign in.

NOTE

The search result from the player may differ from the result when searched from a web browser on PC.

4

Operation

Signing in with your account

To display photos in your web album on the screen, you need to sign in with your Picasa Web Albums account.

1. Select the [Sign In] on the Picasa Web Albums menu using $\wedge/\vee/</>$, and press ENTER (⊙).

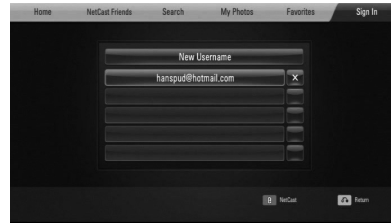

Select the [X] symbol and press ENTER (⊙) to delete the stored user name.

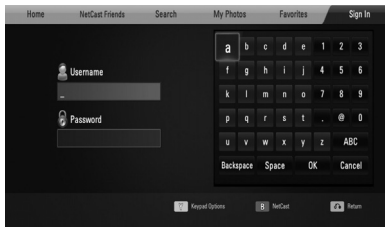

2. Enter your user name using the virtual keyboard, and press ENTER (⊙) while [OK] is selected.

Refer to "Using the virtual keyboard" on page 74 for using the virtual keyboard.

Using the AccuWeather



See on-line local and global weather forecasts from AccuWeather.com.

Viewing weather information

1. On the player, select the [AccuWeather] option in the [NetCast] menu using </>, and press ENTER (⊙).

The city selection menu appears on the screen.

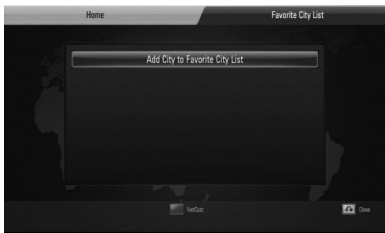

2. Press ENTER (⊙) while [Add City to Favorite City List] is selected.
3. Select a region using ^/V, and press ENTER (⊙).

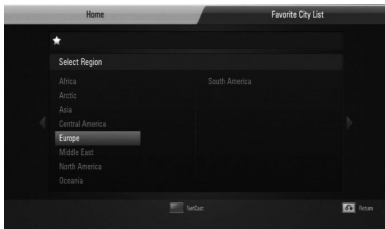

4. Select a, country using ^/V/</>, and press ENTER (⊙).

5. Select a city using ^/V/</>, and press ENTER (⊙).
6. Use ^/V/</> to select [Home] and press ENTER (⊙) to display weather information of the selected city.



Press red (R) coloured button to toggle display between Fahrenheit or Celsius thermometre.

7. Use </> to select previous or next city, and press ENTER (⊙) to display the weather information.

This step works only when you add more than 1 city to the [Favorite city List].

NOTE

- The weather information is not always correct.
- The weather information may be displayed in English, if your own language is not available on the AccuWeather service.

Adding more cities

1. Use </> to select [Favorite City List] on the AccuWeather menu, and press ENTER (⊙).

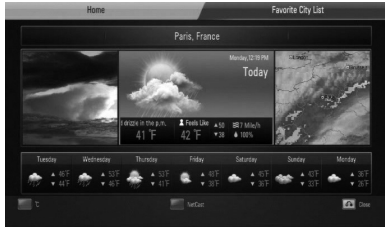

2. Press ENTER (⊙) while [Add City to Favorite City List] is selected.
3. Select a region, country and city using $\wedge/\vee/\langle/\rangle$ and ENTER (⊙).
4. Repeats step 2-3 to add up to 5 cities.
Select the [X] symbol and press ENTER (⊙) to delete the stored favorite city.
5. Use \wedge/\vee to select a city from the [Favorite City List], and press ENTER (⊙) to display the weather information.

4

Operation

5 Maintenance

Notes on Discs

Handling Discs



Never stick paper or tape on the disc.

Storing Discs

After playing, store the disc in its case. Do not expose the disc to direct sunlight or sources of heat and never leave it in a parked car exposed to direct sunlight.

Cleaning Discs

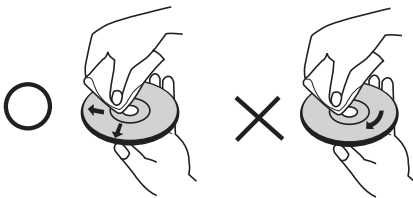

Do not use strong solvents such as alcohol, benzene, thinner, commercially available cleaners, or anti-static spray intended for older vinyl records.

Handling the Unit

When shipping the unit

Please save the original shipping carton and packing materials. If you need to ship the unit, for maximum protection, re-pack the unit as it was originally packed at the factory.

Keeping the exterior surfaces clean

- Do not use volatile liquids such as insecticide spray near the unit.
- Wiping with strong pressure may damage the surface.
- Do not leave rubber or plastic products in contact with the unit for a long period of time.

Cleaning the unit

To clean the player, use a soft, dry cloth. If the surfaces are extremely dirty, use a soft cloth lightly moistened with a mild detergent solution. Do not use strong solvents such as alcohol, benzene, or thinner, as these might damage the surface of the unit.

Maintaining the Unit

The unit is a high-tech, precision device. If the optical pick-up lens and disc drive parts are dirty or worn, the picture quality could be diminished. For details, please contact your nearest authorized service Centre.

6 Troubleshooting

General

<p>The Power does not turn on.</p>	<ul style="list-style-type: none"> • Plug the power cord into the wall outlet securely.
<p>The unit does not start playback.</p>	<ul style="list-style-type: none"> • Insert a playable disc. (Check the disc type, colour system, and regional code.) • Place the disc with the playback side down. • Clean the disc. • Cancel the rating function or change the rating level.
<p>The angle cannot be changed.</p>	<ul style="list-style-type: none"> • Multi-angles are not recorded on the DVD Video being played.
<p>The subtitle language cannot be changed or turned off.</p>	<ul style="list-style-type: none"> • Subtitles are not recorded on the DVD Video being played.
<p>Cannot play MP3/WMA/JPEG/DivX files.</p>	<ul style="list-style-type: none"> • The files are not recorded in a format that the unit can play. • The unit does not support the codec of the movie file.
<p>The remote control does not work properly.</p>	<ul style="list-style-type: none"> • The remote control is not pointed at the remote sensor of the unit. • The remote control is too far from the unit. • There is an obstacle in the path of the remote control and the unit. • The batteries in the remote control are exhausted.



Picture

There is no picture.	<ul style="list-style-type: none"> • Select the appropriate video input mode on the TV so the picture from the unit appears on the TV screen. • Connect the video connection securely. • Check the [HDMI Color Setting] in the [Setup] menu is set to the appropriate item that conforms to your video connection. • Your TV may not support the resolution you have set on the player. Change the resolution that your TV accepts. • The player's HDMI OUT jack is connected to a DVI device that does not support copyright protection.
Picture noise appears	<ul style="list-style-type: none"> • You are playing a disc recorded in a colour system that is different from your TV. • Set the resolution which your TV accepts.
Blu-ray 3D™ disc playback does not output 3D views.	<ul style="list-style-type: none"> • Connect the player to your TV with HDMI cable (Version 1.3 or higher). • Your TV may not support "HDMI 1.4 3D mandatory format". • The [3D Mode] option in the [Setup] menu is set to [Off]. Set the option to [On].

Sound

There is no sound or the sound is distorted.	<ul style="list-style-type: none"> • The unit is in scan, slow motion, or pause mode. • The sound volume is low. • Check the speaker cable connection. (page 25)
--	---

Network

BD-Live™ feature does not work.	<ul style="list-style-type: none"> • The connected USB storage may not have enough space. Connect the USB storage with at least 1GB free space. • Ensure that the unit is correctly connected to the local area network and can access the internet (see page 31). • Your broadband speed may not fast enough to use the BD-Live™ features. Contact your Internet Service Provider (ISP) and increase the broadband speed is recommended. • The [BD-LIVE connection] option in the [Setup] menu is set to [Prohibited]. Set the option to [Permitted].
Streaming video services (such as YouTube, etc.) are often stopped or “buffered” during playback.	<ul style="list-style-type: none"> • Your broadband service speed may not be fast enough to stream video services. Contact your Internet Service Provider (ISP) and increase the broadband speed is recommended.
Shared folder or files from your PC or a media server are not displayed on the [Home Link] menu.	<ul style="list-style-type: none"> • The firewall or anti-virus software on your media server is running. Turn off the firewall or anti-virus software running on your PC or media server. • The player is not connected to the local area network that your PC or the media server are connected.
Cannot connect the player to the access point or wireless LAN router.	<ul style="list-style-type: none"> • The wireless communication may be interrupted from household devices that are using radio frequencies. Move the player away from them.
Access point is not displayed on the “Access point name” list.	<ul style="list-style-type: none"> • The access point or wireless LAN router may not broadcast its SSID. Set your access point to broadcast its SSID through your computer.

6

Troubleshooting

Design and specifications are subject to change without notice.

Customer Support

You can update the Player using the latest software to enhance the products operation and/or add new features. To obtain the latest software for this player (if updates have been made), please visit <http://lgservice.com> or contact LG Electronics customer care Centre.

7

Appendix

Controlling a TV with the Supplied Remote Control

You can control your TV using the buttons below.

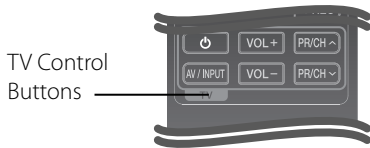

Button	Operation
 (TV Power)	Turn the TV on or off.
AV/ INPUT	Switch the TV's input source between the TV and other input sources.
VOL +/-	Adjust the volume of the TV.
PR/CH ^/v	Scan up or down through memorized channels.

NOTE

Depending on the unit being connected, you may not be able to control your TV using some of the buttons.

Setting up the remote to control your TV

You can operate your LG/GoldStar TV with the supplied remote control.

While holding down TV POWER button, press PR/CH ^/v. Release the TV POWER button to complete setting.

When you replace the batteries of the remote, you may have reset the remote control.

Area Code List

Choose an area code from this list.

Area	Code	Area	Code	Area	Code	Area	Code
Afghanistan	AF	Fiji	FJ	Monaco	MC	Singapore	SG
Argentina	AR	Finland	FI	Mongolia	MN	Slovak Republic	SK
Australia	AU	France	FR	Morocco	MA	Slovenia	SI
Austria	AT	Germany	DE	Nepal	NP	South Africa	ZA
Belgium	BE	Great Britain	GB	Netherlands	NL	South Korea	KR
Bhutan	BT	Greece	GR	Netherlands		Spain	ES
Bolivia	BO	Greenland	GL	Antilles	AN	Sri Lanka	LK
Brazil	BR	Hong Kong	HK	New Zealand	NZ	Sweden	SE
Cambodia	KH	Hungary	HU	Nigeria	NG	Switzerland	CH
Canada	CA	India	IN	Norway	NO	Taiwan	TW
Chile	CL	Indonesia	ID	Oman	OM	Thailand	TH
China	CN	Israel	IL	Pakistan	PK	Turkey	TR
Colombia	CO	Italy	IT	Panama	PA	Uganda	UG
Congo	CG	Jamaica	JM	Paraguay	PY	Ukraine	UA
Costa Rica	CR	Japan	JP	Philippines	PH	United States	US
Croatia	HR	Kenya	KE	Poland	PL	Uruguay	UY
Czech Republic	CZ	Kuwait	KW	Portugal	PT	Uzbekistan	UZ
Denmark	DK	Libya	LY	Romania	RO	Vietnam	VN
Ecuador	EC	Luxembourg	LU	Russian Federation	RU	Zimbabwe	ZW
Egypt	EG	Malaysia	MY	Saudi Arabia	SA		
El Salvador	SV	Maldives	MV	Senegal	SN		
Ethiopia	ET	Mexico	MX				

Language code List

Use this list to input your desired language for the following initial settings: [Disc Audio], [Disc Subtitle] and [Disc Menu].

Language	Code	Language	Code	Language	Code	Language	Code
Afar	6565	French	7082	Lithuanian	7684	Sindhi	8368
Afrikaans	6570	Frisian	7089	Macedonian	7775	Singhalese	8373
Albanian	8381	Galician	7176	Malagasy	7771	Slovak	8375
Ameharic	6577	Georgian	7565	Malay	7783	Slovenian	8376
Arabic	6582	German	6869	Malayalam	7776	Spanish	6983
Armenian	7289	Greek	6976	Maori	7773	Sudanese	8385
Assamese	6583	Greenlandic	7576	Marathi	7782	Swahili	8387
Aymara	6588	Guarani	7178	Moldavian	7779	Swedish	8386
Azerbaijani	6590	Gujarati	7185	Mongolian	7778	Tagalog	8476
Bashkir	6665	Hausa	7265	Nauru	7865	Tajik	8471
Basque	6985	Hebrew	7387	Nepali	7869	Tamil	8465
Bengali; Bangla	6678	Hindi	7273	Norwegian	7879	Telugu	8469
Bhutani	6890	Hungarian	7285	Oriya	7982	Thai	8472
Bihari	6672	Icelandic	7383	Panjabi	8065	Tonga	8479
Breton	6682	Indonesian	7378	Pashto, Pushto	8083	Turkish	8482
Bulgarian	6671	Interlingua	7365	Persian	7065	Turkmen	8475
Burmese	7789	Irish	7165	Polish	8076	Twi	8487
Byelorussian	6669	Italian	7384	Portuguese	8084	Ukrainian	8575
Chinese	9072	Japanese	7465	Quechua	8185	Urdu	8582
Croatian	7282	Kannada	7578	Rhaeto-Romance	8277	Uzbek	8590
Czech	6783	Kashmiri	7583			Vietnamese	8673
Danish	6865	Kazakh	7575	Rumanian	8279	Volapük	8679
Dutch	7876	Kirghiz	7589	Russian	8285	Welsh	6789
English	6978	Korean	7579	Samoan	8377	Wolof	8779
Esperanto	6979	Kurdish	7585	Sanskrit	8365	Xhosa	8872
Estonian	6984	Laothian	7679	Scots Gaelic	7168	Yiddish	7473
Faroese	7079	Latin	7665	Serbian	8382	Yoruba	8979
Fiji	7074	Latvian, Lettish	7686	Serbo-Croatian	8372	Zulu	9085
Finnish	7073	Lingala	7678	Shona	8378		

Network Software Update

Network update notification

From time to time, performance improvements and/or additional features or services may be made available to units that are connected to a broadband home network. If there is new software available and the unit is connected to a broadband home network, the player will inform you about the update as follows.

Option 1:

1. The update menu will appear on the screen when you turn on the player.
2. Use </> to select a desired option and then press ENTER (⊙).

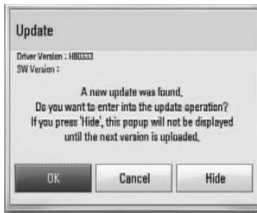

[OK]

Starts the software update.

[Cancel]

Exits the update menu and displays its next booting.

[Hide]

Exits the update menu and it does not appear until next software is uploaded in the update server.

Option 2:

If the software update is available from the update server, the "Update" icon appears at the bottom of the Home menu. Press blue (B) coloured button to start the update procedure.

Software Update

You can update the player using the latest software to enhance the products operation and/or add new features. You can update the software by connecting the unit directly to the software update server.



CAUTION

- Before updating the software in your player, remove any disc and USB Device from the player.
- Before updating the software in your player, turn the player off and then turn it back on.
- **During the software update procedure, do not turn off the player or disconnect AC power, or do not press any button.**
- If you cancel the update, turn off the power and turn it on for stable performance.
- This unit cannot be updated to previous software version.

1. Check the network connection and settings (page 31).
2. Select [Software] option in the [Setup] menu then press ENTER (⊙).
3. Select [Update] option, and press ENTER (⊙).

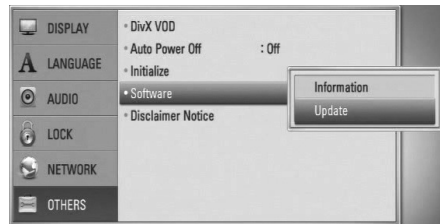

The player will check for the newest update.

NOTE

- Pressing ENTER (Ⓢ) while checking for the update will end the process.
- If there is no update available, the Message, "No update is found." appears. Press ENTER (Ⓢ) to return to the [Home Menu].

4. If newer version exists, the message "A new update was found. Do you want to download it?" appears.



5. Select [OK] to download the update. (Selecting [Cancel] will end the update.)
6. The player starts downloading the newest update from the server. (Downloading will take several minutes depending on your home network condition)
7. When downloading is completed, the message, "Download is complete. Do you want to update?" appears.
8. Select [OK] to start updating. (Selecting [Cancel] will end the update and downloaded file will not be re-usable. To update software the next time, the software update procedure has to be started from the beginning again.)

CAUTION

Do not turn off the power during the software update.

9. When update is completed, the message, "Update is complete." will appear, and then power will turn off automatically after 5 seconds.
10. Turn the power back on. The system now operates with the new version.

NOTE

The Software Update function may not work properly depending on your internet environment. In this case, you can obtain the latest software from the authorized LG Electronics Service Centre then update your player. Refer to "Customer Support" on page 84.

Video output resolution

Resolution \ Video Out	HDMI OUT
576i (480i)	576p (480p)
576p (480p)	576p (480p)
720p	720p
1080i	1080i
1080p / 24 Hz	1080p / 24 Hz
1080p / 50 (60) Hz	1080p / 50 (60) Hz

HDMI OUT connection

- For the 576i (480i) resolution setting, real output resolution of HDMI OUT will change to 576p (480p).
- If you select a resolution manually and then connect the HDMI jack to TV and your TV does not accept it, the resolution setting is set to [Auto].
- If you select a resolution that your TV does not accept, the warning message will appear. After resolution change, if you cannot see the screen, please wait 20 seconds and the resolution will automatically revert back to the previous resolution.
- The 1080p video output frame rate may be automatically set to either 24 Hz or 50 (60) Hz depending both on the capability and preference of the connected TV and based on the native video frame rate of the content on the BD-ROM disc.

VIDEO OUT connection

The resolution of the VIDEO OUT jack is always outputted at 576i (480i) resolution.

Trademarks and Licences



“Blu-ray Disc™” is a trademark.



“Blu-ray 3D™” and “Blu-ray 3D™” logo are trademarks of Blu-ray Disc™ Association.



“BD-Live™” logo is a trademark of Blu-ray Disc™ Association.

“BONUSVIEW™” is trademark of Blu-ray Disc™ Association.



Java and all Java-based trademarks and logos are trademarks or registered trademarks of Sun Microsystems, Inc. in the United States and other countries.



Manufactured under licence from Dolby Laboratories. Dolby, Pro Logic, and the double-D symbol are trademarks of Dolby Laboratories.



Manufactured under licence under U.S. Patent #'s: 5,451,942; 5,956,674; 5,974,380; 5,978,762; 6,226,616; 6,487,535; 7,392,195; 7,272,567; 7,333,929; 7,212,872 & other U.S. and worldwide patents issued & pending. DTS and the Symbol are registered trademarks, & DTS-HD, DTS-HD Master Audio | Essential and the DTS logos are trademarks of DTS, Inc. Product includes software. © DTS, Inc. All Rights Reserved.



HDMI, the HDMI logo and High-Definition Multimedia Interface are trademarks or registered trademarks of HDMI licensing LLC.



“DVD Logo” is a trademark of DVD Format/Logo Licensing Corporation.



DLNA®, the DLNA Logo and DLNA CERTIFIED® are trademarks, service marks, or certification marks of the Digital Living Network Alliance.



The Wi-Fi CERTIFIED Logo is a certification mark of the Wi-Fi Alliance.



DivX is a registered trademark of DivX, Inc., and is used under license.

“x.v.Colour” is a trademark of Sony Corporation.



“AVCHD” and the “AVCHD” logo are trademarks of Panasonic Corporation and Sony Corporation.

This product is licenced under the AVC patent portfolio licence and VC-1 patent portfolio licence for the personal and non-commercial use of a consumer to (i) encode video in compliance with the AVC Standard and VC-1 Standard (“AVC/VC-1 Video”) and/or (ii) decode AVC/VC-1 Video that was encoded by a consumer engaged in a personal and non-commercial activity and/or was obtained from a video provider licenced to provide AVC/VC-1 Video. No licence is granted or shall be implied for any other use. Additional information may be obtained from MPEG LA, LLC. See <http://www.mpegla.com>.



iPod is a trademark of Apple Inc., registered in the U.S. and other countries.

iPhone is a trademark of Apple Inc.

“Made for iPod” and “Made for iPhone” mean that an electronic accessory has been designed to connect specifically to iPod or iPhone respectively, and has been certified by the developer to meet Apple performance standards.

Apple is not responsible for the operation of this device or its compliance with safety and regulatory standards.

Please note that the use of this accessory with iPod, iPhone may affect wireless performance.



Gracenote®, Gracenote logo and logotype, and the “Powered by Gracenote” logo are either registered trademarks or trademarks of Gracenote, Inc. in the United States and/or other countries.

Music recognition technology and related data are provided by Gracenote®.

Portions of the content is copyright © Gracenote or its providers.



Specifications

General

- Power requirements:
AC 200 - 240 V, 50/ 60 Hz
- Power consumption:
25 W
- Dimensions (W x H x D):
Wall Mounted 580 x 199 x 54 mm
With stand 580 x 215 x 138 mm
- Net Weight (Approx.):
3.1 kg (With stand: 3.9 kg)
- Operating temperature:
41 °F to 95 °F (5 °C to 35 °C)
- Operating humidity:
5 % to 90 %

Inputs/ Outputs

- VIDEO OUT:
1.0 V (p-p), 75 Ω , sync negative, RCA jack x 1
- HDMI IN/OUT (video/audio):
19 pin (HDMI standard, Type A, Version 1.3)
- DIGITAL IN (OPTICAL IN):
3 V (p-p), Optical jack
- PORT. IN:
0.5 Vrms (3.5 mm stereo jack)
- Bus Power supply (USB):
DC 5 V \equiv 500 mA

Tuner

- FM Tuning Range:
87.5 to 108.0 MHz or 87.50 to 108.00 MHz

Amplifier

- Power output (4 Ω), (PEAK)

Total	1100 W
Front	180 W x 2
Centre	180 W
Rear	180 W x 2
Sub-Woofer	200 W (Active)
- Power output (4 Ω), (RMS), THD 10 % (4 Ω / 3 Ω)

Total	980 W
Front	160 W x 2
Centre	160 W
Rear	160 W x 2
Sub-Woofer	180 W (Active)

System

- Laser:
Semiconductor laser
Wavelength: 405 nm / 650 nm
- Signal system:
Standard NTSC/PAL colour TV system
- Frequency response:
20 Hz to 20 kHz (48 kHz, 96 kHz, 192 kHz sampling)
- Signal-to-noise ratio:
More than 85 dB
- Total harmonic distortion:
0.05 % at 1 W
- Dynamic range:
More than 90 dB
- LAN port:
Ethernet jack x 1, 10BASE-T/100BASE-TX
- Wireless LAN (internal antenna):
Compatible with 802.11b/g Wi-Fi networks.

Speakers

- Front speaker (Left/ Right)

Type:	2 Way 3 speaker
Impedance Rated:	4 Ω
Input Power:	180 W
Max. Input power:	360 W
Net Dimensions (W x H x D):	280 x 1212 x 195 mm
Net Weight:	2.7 kg
- Rear speaker (Left/ Right)

Type:	2 Way 3 speaker
Impedance	4 Ω
Input Power:	180 W
Max. Input power:	360 W
Net Dimensions (W x H x D):	280 x 1212 x 195 mm
Net Weight:	2.7 kg
- Centre speaker

Type:	2 Way 3 speaker
Impedance Rated:	4 Ω
Input Power:	180 W
Max. Input power:	360 W
Net Dimensions (W x H x D):	400 x 75 x 52 mm
Net Weight:	0.55 kg
- Subwoofer

Type:	1 Way 1 speaker
Impedance Rated:	3 Ω
Input Power:	200 W
Max. Input power:	400 W
Net Dimensions (W x H x D):	216 x 405 x 390 mm
Net Weight:	9.3 kg
Power requirements:	AC 200-240 V, 50/60 Hz
Power consumption:	Refer to main label.
Reception Output:	5.8 GHz

Important Information Relating to Network Services

PLEASE READ CAREFULLY. USE OF THE NETWORK SERVICES IS SUBJECT TO THE FOLLOWING TERMS AND CONDITIONS.

Use of the Network Services requires an Internet connection which is sold separately and for which you are solely responsible. The Network Services may be limited or restricted depending upon the quality, capabilities and technical limitations of your Internet service.

The Network Services belong to third parties and may be protected by copyright, patent, trademark and/or other intellectual property laws. The Network Services are provided solely for your personal and noncommercial use. Unless expressly authorized by the respective content owner or service provider, you shall not modify, copy, republish, upload, post, transmit, translate, sell, create derivative works, exploit, or distribute in any manner or medium any content or services accessible through this product.

LG IS NOT RESPONSIBLE FOR YOUR USE OF THE NETWORK SERVICES. THE NETWORK SERVICES ARE PROVIDED "AS IS," TO THE FULLEST EXTENT PERMISSIBLE BY LAW, LG MAKES NO REPRESENTATIONS OR WARRANTIES OF ANY KIND WHATSOEVER (i) FOR THE ACCURACY, VALIDITY, TIMELINESS, LEGALITY, OR COMPLETENESS OF ANY NETWORK SERVICE MADE AVAILABLE THROUGH THIS PRODUCT; OR (ii) THAT THE NETWORK SERVICES ARE FREE OF VIRUSES OR OTHER COMPONENTS THAT MAY INFECT, HARM, OR CAUSE DAMAGE TO THIS PRODUCT, YOUR COMPUTER, TELEVISION, OTHER EQUIPMENT, OR ANY OTHER PROPERTY. LG EXPRESSLY DISCLAIMS ANY IMPLIED WARRANTIES, INCLUDING BUT NOT LIMITED TO, WARRANTIES OF MERCHANTABILITY OR FITNESS FOR A PARTICULAR PURPOSE.

UNDER NO CIRCUMSTANCES AND UNDER NO LEGAL THEORY, WHETHER IN CONTRACT, TORT, STRICT LIABILITY OR OTHERWISE, SHALL LG BE LIABLE TO YOU OR ANY THIRD PARTY FOR ANY DIRECT, INDIRECT, INCIDENTAL, SPECIAL, STATUTORY, CONSEQUENTIAL OR OTHER DAMAGES OR ATTORNEY FEES OR EXPENSES RELATING TO OR ARISING OUT OF THE NETWORK SERVICES EVEN IF ADVISED OF THE POSSIBILITY OF SUCH DAMAGES OR IF SUCH DAMAGES COULD HAVE BEEN REASONABLY FORESEEN.

The Network Services may be terminated or interrupted at any time, and LG makes no representation or warranty that any Network Service will remain available for any period of time. Use of the Network Services may be subject to additional terms and conditions of the respective third party service provider. The Network Services are transmitted by third parties by means of networks and transmission facilities over which LG has no control. LG EXPRESSLY DISCLAIMS ANY RESPONSIBILITY OR LIABILITY FOR ANY INTERRUPTION OR SUSPENSION OF ANY NETWORK SERVICE.

LG shall be neither responsible nor liable for customer service related to the Network Services. Any question or request should be made directly to the respective Network Service providers.

"Network Service(s)" means the third party services accessible through this product including but not limited to all data, software, links, messages, video and other content found thereon or used in connection therewith.

"LG" means LG Electronics, Inc. its parent company and all of their respective subsidiaries, affiliates and related companies worldwide.

Open source software notice

The following GPL executables and LGPL libraries used in this product are subject to the GPL2.0/LGPL2.1 License Agreements:

GPL EXECUTABLES: Linux kernel 2.6, bash, busybox, cramfs, dhcpcd, e2fsprogs, fdisk, mkdosfs, mtd-utils, net-tools, procs, samba-3.0.25b, sysutils, tcpdump, tftpd, tinylogin, unzip, utelnetd

LGPL LIBRARIES: uClibc, DirectFB, blowfish, cairo, ffmpeg, iconv, libusb, mpg123, webkit

gSOAP Public License 1.3 LIBRARY: gsoap

LG Electronics offers to provide source code to you on CD-ROM for a charge covering the cost of performing such distribution, such as the cost of media, shipping and handling upon e-mail request to LG Electronics at: opensource@lge.com. This offer is valid for a period of three (3) years from the date of the distribution of this product by LG Electronics.

You can obtain a copy of the GPL, LGPL licenses from <http://www.gnu.org/licenses/old-licenses/gpl-2.0.html> and <http://www.gnu.org/licenses/old-licenses/lgpl-2.1.html>.

Also you can obtain a copy of gSOAP public license from <http://www.cs.fsu.edu/~engelen/license.html>.

This product includes

- boost C++: copyright © Beman Dawes 1999-2003
- c-ares : copyright © 1998 by the Massachusetts Institute of Technology
- curl: copyright © 1996 - 2008, Daniel Stenberg
- expat: copyright © 2006 expat maintainers
- fontconfig: copyright © 2002 Keith Packard
- freetype: copyright © 2003 The FreeType Project (www.freetype.org).
- icu: copyright © 1995-2009 International Business Machines Corporation and others
- jpeg: This software is based in part on the work of the Independent JPEG Group copyright © 1991 – 1998, Thomas G. Lane
- libxslt: copyright © 2001-2002 Thomas Broyer, Charlie Bozeman and Daniel Veillard.
- mng: copyright © 2000-2007 Gerard Juyn, Glenn Randers-Pehrson
- ntp : copyright © David L. Mills 1992-2006
- openssl:
 - cryptographic software written by Eric Young (eyay@cryptsoft.com).
 - software written by Tim Hudson (tjh@cryptsoft.com).
 - software developed by the OpenSSL Project for use in the OpenSSL Toolkit. (<http://www.openssl.org>)

- pixman:
 - copyright © 1987, 1988, 1989, 1998 The Open Group
 - copyright © 1987, 1988, 1989 Digital Equipment Corporation
 - copyright © 1999, 2004, 2008 Keith Packard
 - copyright © 2000 SuSE, Inc.
 - copyright © 2000 Keith Packard, member of The XFree86 Project, Inc.
 - copyright © 2004, 2005, 2007, 2008 Red Hat, Inc.
 - copyright © 2004 Nicholas Miell
 - copyright © 2005 Lars Knoll & Zack Rusin, Trolltech
 - copyright © 2005 Trolltech AS
 - copyright © 2007 Luca Barbato
 - copyright © 2008 Aaron Plattner, NVIDIA Corporation
 - copyright © 2008 Rodrigo Kumpera
 - copyright © 2008 André Tupinambá
 - copyright © 2008 Mozilla Corporation
 - copyright © 2008 Frederic Plourde
- png: copyright © 2004 Glenn Randers-Pehrson
- portmap : copyright © 1990 The Regents of the University of California
- ptmalloc : copyright © 2001-2006 Wolfram Gloger
- UnitTest++ : copyright © 2006 Noel Llopis and Charles Nicholson
- UPnP SDK : copyright © 2000-2003 Intel Corporation
- strace :
 - copyright © 1991, 1992 Paul Kranenburg
 - copyright © 1993 Branko Lankester
 - copyright © 1993 Ulrich Pegelow
 - copyright © 1995, 1996 Michael Elizabeth Chastain
 - copyright © 1993, 1994, 1995, 1996 Rick Sladkey
 - copyright © 1999,2000 Wichert Akkerman
- xml2 : copyright © 1998-2003 Daniel Veillard
- XML-RPC For C/C++:
 - copyright © 2001 by First Peer, Inc. All rights reserved.
 - copyright © 2001 by Eric Kidd. All rights reserved.
- zlib: copyright © 1995-2002 Jean-loup Gailly and Mark Adler.

All rights reserved.

Permission is hereby granted, free of charge, to any person obtaining a copy of this software and associated documentation files (the "Software"), to deal in the Software without restriction, including without limitation the rights to use, copy, modify, merge, publish, distribute, sublicense, and/or sell copies of the Software, and to permit persons to whom the Software is furnished to do so, subject to the following conditions:

THE SOFTWARE IS PROVIDED "AS IS," WITHOUT WARRANTY OF ANY KIND, EXPRESS OR IMPLIED, INCLUDING BUT NOT LIMITED TO THE WARRANTIES OF MERCHANTABILITY, FITNESS FOR A PARTICULAR PURPOSE AND NONINFRINGEMENT. IN NO EVENT SHALL THE AUTHORS OR COPYRIGHT HOLDERS BE LIABLE FOR ANY CLAIM, DAMAGES OR OTHER LIABILITY, WHETHER IN AN ACTION OF CONTRACT, TORT OR OTHERWISE, ARISING FROM, OUT OF OR IN CONNECTION WITH THE SOFTWARE OR THE USE OR OTHER DEALINGS IN THE SOFTWARE.

Gracenote® End User Licence Agreement

This application or device contains software from Gracenote, Inc. of Emeryville, California ("Gracenote"). The software from Gracenote (the "Gracenote Software") enables this application to perform disc and/or file identification and obtain music-related information, including name, artist, track, and title information ("Gracenote Data") from online servers or embedded databases (collectively, "Gracenote Servers") and to perform other functions. You may use Gracenote Data only by means of the intended End-User functions of this application or device.

You agree that you will use Gracenote Data, the Gracenote Software, and Gracenote Servers for your own personal non-commercial use only. You agree not to assign, copy, transfer or transmit the Gracenote Software or any Gracenote Data to any third party. **YOU AGREE NOT TO USE OR EXPLOIT GRACENOTE DATA, THE GRACENOTE SOFTWARE, OR GRACENOTE SERVERS, EXCEPT AS EXPRESSLY PERMITTED HEREIN.**

You agree that your non-exclusive licence to use the Gracenote Data, the Gracenote Software, and Gracenote Servers will terminate if you violate these restrictions. If your licence terminates, you agree to cease any and all use of the Gracenote Data, the Gracenote Software, and Gracenote Servers. Gracenote reserves all rights in Gracenote Data, the Gracenote Software, and the Gracenote Servers, including all ownership rights. Under no circumstances will Gracenote become liable for any payment to you for any information that you provide. You agree that Gracenote, Inc. may enforce its rights under this Agreement against you directly in its own name.

The Gracenote service uses a unique identifier to track queries for statistical purposes. The purpose of a randomly assigned numeric identifier is to allow the Gracenote service to count queries without knowing anything about who you are. For more information, see the web page for the Gracenote Privacy Policy for the Gracenote service.

The Gracenote Software and each item of Gracenote Data are licenced to you "AS IS." Gracenote makes no representations or warranties, express or implied, regarding the accuracy of any Gracenote Data from in the Gracenote Servers. Gracenote reserves the right to delete data from the Gracenote Servers or to change data categories for any cause that Gracenote deems sufficient. No warranty is made that the Gracenote Software or Gracenote Servers are error-free or that functioning of Gracenote Software or Gracenote Servers will be uninterrupted. Gracenote is not obligated to provide you with new enhanced or additional data types or categories that Gracenote may provide in the future and is free to discontinue its services at any time.

GRACENOTE DISCLAIMS ALL WARRANTIES EXPRESS OR IMPLIED, INCLUDING, BUT NOT LIMITED TO, IMPLIED WARRANTIES OF MERCHANTABILITY, FITNESS FOR A PARTICULAR PURPOSE, TITLE, AND NON-INFRINGEMENT. GRACENOTE DOES NOT WARRANT THE RESULTS THAT WILL BE OBTAINED BY YOUR USE OF THE GRACENOTE SOFTWARE OR ANY GRACENOTE SERVER. IN NO CASE WILL GRACENOTE BE LIABLE FOR ANY CONSEQUENTIAL OR INCIDENTAL DAMAGES OR FOR ANY LOST PROFITS OR LOST REVENUES.

© Gracenote, Inc. 2009



	Телефон	Режим работы	Интернет
Россия	8-800-200-7676	Круглосуточно	http://www.lg.com
Беларусь	8-820-0071-1111		
Латвия	8-0003-271		
Литва	8-800-30-800		
Эстония	800-9990		
Украина	0-800-303-000	8:00 - 21:00 (Пн.-Пят.) 9:00 - 18:00 (Суб., Вс.)	
Казахстан	8-8000-805-805	9:00 - 18:00 (Пн.-Пят.) 9:00 - 18:00 (Суб.)	
	2255 (для мобильных телефонов)		
Кыргызстан	8-0000-710-005	Круглосуточно	
Узбекистан			

