

Table of Contents

3	Safety Note	16-17	Connecting a <i>Bluetooth</i> wireless technology
4	Front Panel		Using the buttons for <i>Bluetooth</i> wireless technology
5	Remote Control		Disconnecting a phone
	Battery installation		Answering and ending a call
6	About detachable control panel		Rejecting a call
	Attaching the control panel		Making a call saved as preset number
	Detaching the control panel		Checking missed calls
7	Installation		Saving call numbers in the latest calls
	Basic installation		Audio transfer
	Removing the existing receiver unit		Pairing your unit and device with <i>Bluetooth</i> wireless technology
	ISO-DIN installation		Playing MP3 files
8	Connection		<i>Bluetooth</i> wireless technology profiles information
9-10	Basic operation	18	Adjusting the setting (<i>Bluetooth</i> wireless technology)
	Mute	19-21	Phone compatibility list (<i>Bluetooth</i> wireless technology)
	Using the EQ	22	Troubleshooting
	Using XDSS+(Extreme Dynamic Sound System)	23	Specifications
	Checking the clock		
	Turning off the display light		
	Resetting the unit		
	Adjusting general settings		
10-11	Listening to a CD		
	Pausing or restarting CD playback		
	Searching for a section within a track /file		
	Checking information about your music		
	Playing back tracks/files in a way you want		
11	Listening to music from an external device		
12-13	Listening to the radio		
	Storing desired frequencies manually		
	Listening to a preset station		
	Adjusting tuner settings		
14	Using USB device		
	Moving to another drive		
	Recording to USB from audio CD or FM tuner		
	Quick search of a desired file		
15	Listening to music by connecting iPod		

Safety Note



CAUTION
RISK OF ELECTRIC SHOCK
DO NOT OPEN



CAUTION : TO REDUCE THE RISK OF ELECTRIC SHOCK DO NOT SPLIT COVER(OR BACK) NO USER SERVICEABLE PARTS INSIDE. REFER SERVICING TO QUALIFIED SERVICE PERSONNEL.



This lightning flash with arrowhead symbol within an equilateral triangle is intended to alert the user to the presence of uninsulated dangerous voltage within the product's enclosure that may be of sufficient magnitude to constitute a risk of electric shock to persons.



The exclamation point within an equilateral triangle is intended to alert the user to the presence of important operating and maintenance (servicing) instructions in the literature accompanying the product.



Always operate the vehicle in a safe manner. Do not become distracted by the vehicle while driving, and always be fully aware of all driving condition. Do not change settings, or any functions. Pull over in a safe and legal manner before attempting such operations.



Do not use for many hours at extremely low or high temperature. (-10 °C to 60 °C)



To reduce the risk of electric shock, do not remove the cover or back of this product. There are no user-serviceable parts inside. Refer servicing to qualified service personnel.



To reduce the risk of fire or electric shock, do not expose this product to dripping or splashing water, rain, or moisture.



The temperature of unit's outside can be extremely high, please use the unit after proper installation in your vehicle.



This unit cannot play 8 cm disc (use 12 cm disc only).

CAUTION : This product uses a Laser System.

To ensure proper use of this product, please read this owner's manual carefully and retain it for future reference.

Should the unit require maintenance, contact an authorized service center. Performing controls, adjustments, or carrying out procedures other than those specified herein may result in hazardous radiation exposure.

To prevent direct exposure to laser beam, do not try to open the enclosure. Visible laser radiation when open. **DO NOT STARE INTO BEAM.**

CLASS 1 LASER PRODUCT
KLASSE 1 LASER PRODUKT
LUOKAN 1 LASER LAITE
KLASS 1 LASER APPARAT
CLASSE 1 PRODUIT LASER

"This device is equipped with a portable battery or accumulator.

Safe way to remove the battery or the battery from the equipment:

Remove the old battery or battery pack, follow the steps in reverse order than the assembly. To prevent contamination of the environment and bring on possible threat to human and animal health, the old battery or the battery put it in the appropriate container at designated collection points. Do not dispose of batteries or battery together with other waste. It is recommended that you use local, free reimbursement systems batteries and accumulators."

The battery shall not be exposed to excessive heat such as sunshine, fire or the like.

Caution

When being connected in a wrong way, the unit displays as follows.

- Antenna port short : **"ANTENNA ON PORT SHORT CIRCUIT CHECK"**

After connecting it again, restart the unit.

Front Panel

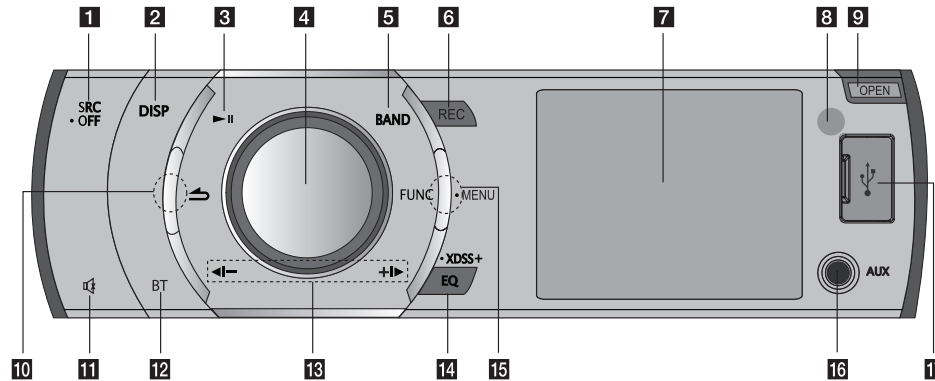

- | | |
|---|--|
| <p>1 [SRC] Selects function sources.
[• OFF] Power on/off.</p> <p>2 [DISP]
• Press it, you can check the clock time.
• Press and hold it, you can turn off the display light.</p> <p>3 [▶] Plays or pauses playback</p> <p>4 Volume knob
• Adjusts volume level.
• Confirms the settings.
• Checks tracks or files in CD mode or preset stations in TUNER mode.</p> <p>5 [BAND] Selects a band.
[• TA] Traffic Announcement (OPTIONAL)
Searches stations that have TA/TP information.</p> | <p>6 [REC] Recording to USB</p> <p>7 Display window</p> <p>8 Remote Sensor</p> <p>9 [OPEN] Opens the front panel.</p> <p>10 [↶] Returns to the previous step.</p> <p>11 [🔇] Temporarily stops the sound.</p> <p>12 [BT] Activates BT function.</p> <p>13 [◀-/+▶]
Skip / Search / Seek / Tune</p> <p>14 [EQ]/[• XDSS+]
Improves sound quality.</p> <p>15 [FUNC] In each mode, sets playback items.
[• Menu] Activates setting menu.</p> <p>16 [AUX] If connected to other portable player, you can enjoy musics of it on the unit.</p> <p>17 USB port</p> |
|---|--|

Note

Make sure to press protruded parts(Refer to the circled parts) when you want to use FUNC or ↶ button function.

Remote Control

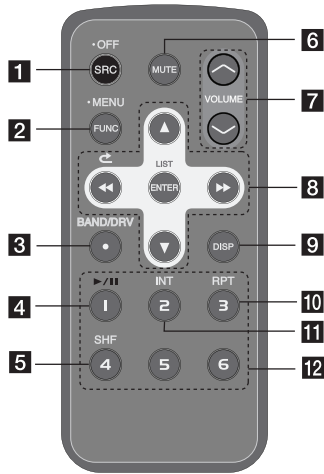

- 1** [SRC] Selects function sources.
[• OFF] Power off.
- 2** [• Menu] Activates setting menu
[FUNC]
In each mode, sets playback items.
- 3** [BAND/DRV]
• Selects a band.
• Moves to a next USB drive
- 4** [▶/||] Plays or pauses playback
- 5** [SHF] Shuffle
- 6** [MUTE] Temporarily stops the sound.

- 7** Adjusts volume level.
- 8** [◀▶] Skip / Search / Seek / Tune
[↵] Returns to the previous step.
[▲▼]
• List up/ down
• Adjusts settings.
• Moves 10 MP3/WMA tracks backward or forward if there is no folder or one folder on a CD.
- 9** [DISP]
• Press it, you can check the clock time.
• Press and hold it, you can turn off the display light.
- 10** [RPT] Repeat function
- 11** [INT] Intro scan
- 12** **Numeric buttons**
Selects a numbered preset station in TUNER.

Battery Installation

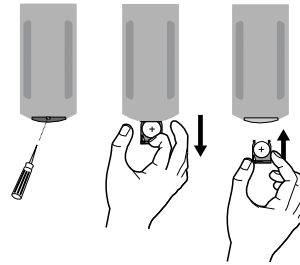

Note

- Use only one CR2025 (3 V) lithium battery.
- Remove the battery if the remote control is not used for a long period of time.
- Do not leave the product in a hot or humid place.
- Do not handle the battery with metallic tools.
- Do not store the battery with metallic materials.

- 1 Pull out the battery holder with a sharp product like a ball point pen.
- 2 Put the battery with + and - correctly on the battery holder.
- 3 Push the battery holder back into its original position.

About detachable control panel

Attaching the control panel

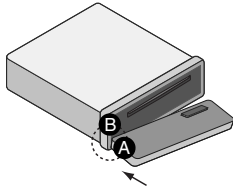

- 1 Attach part **A** of the control panel to part **B** of the unit.

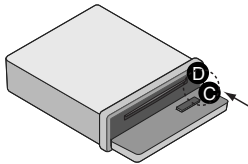

- 2 Attach part **C** of the control panel to part **D** of the unit while pushing the control panel to left.
- 3 Close the control panel.

Caution

- The control buttons may not work properly if the control panel is not attached properly. If this occurs, gently press the display.
- Do not leave the control panel in any area exposed to high temperatures or direct sunlight.
- Do not drop the control panel or otherwise subject it to strong impact.
- Do not allow such volatile agents as benzine, thinner, or insecticides to come into contact with the surface of the control panel.

Detaching the control panel

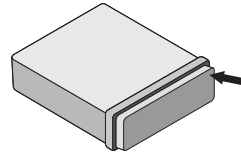

- 1 Press the [**OPEN**] to open the control panel.

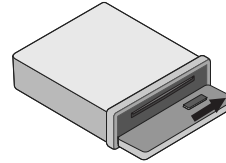

- 2 Push the control panel to right.

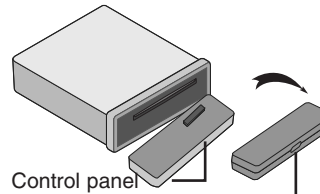

- 3 Pull the control panel out of the unit.
- 4 Put the detached control panel into the protective case.



Note

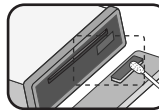

Periodically wipe the contacts on the back of the control panel with a cotton swab moistened with alcohol. For safety, turn off the ignition before cleaning, and remove the key from the ignition switch.

Installation

Basic Installation

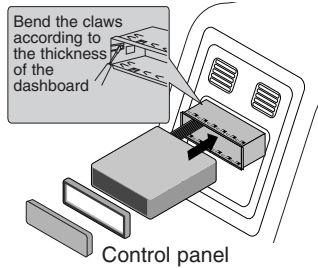

Before installing, make sure that the ignition-switch is set to OFF and remove the terminal of the car battery to avoid short-circuiting.

- 1 Remove the existing receiver unit.
- 2 Make the necessary connections.
- 3 Install the installation sleeve.
- 4 Install the unit into the installation sleeve.

ISO-DIN Installation

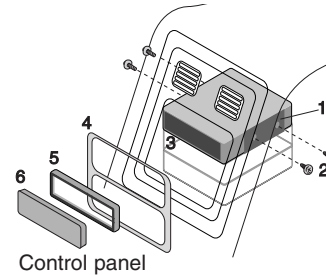

- 1 Slide the unit into the ISO-DIN frame.
- 2 Fit screws removed from the old unit.
- 3 Slide the unit and frame into the dash opening.
- 4 Install the dash panel or adapter plate.
- 5 Install the trim ring to the unit.
- 6 Install the control panel to the unit.

Removing the existing receiver unit

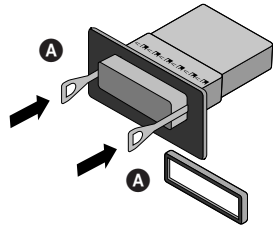

If there is already an installation sleeve for the receiver unit in the dashboard, it must be removed.

- 1 Remove the rear support from the unit.
- 2 Remove the control panel and trim ring from the unit.
- 3 Insert the lever **A** into the hole on one side of the unit. Perform the same operation on the other side and pull the unit out from the mounting sleeve.

Connection

Before connecting, make sure that the ignition switch is set to OFF, and remove the battery ⊖ terminal to avoid short circuits.

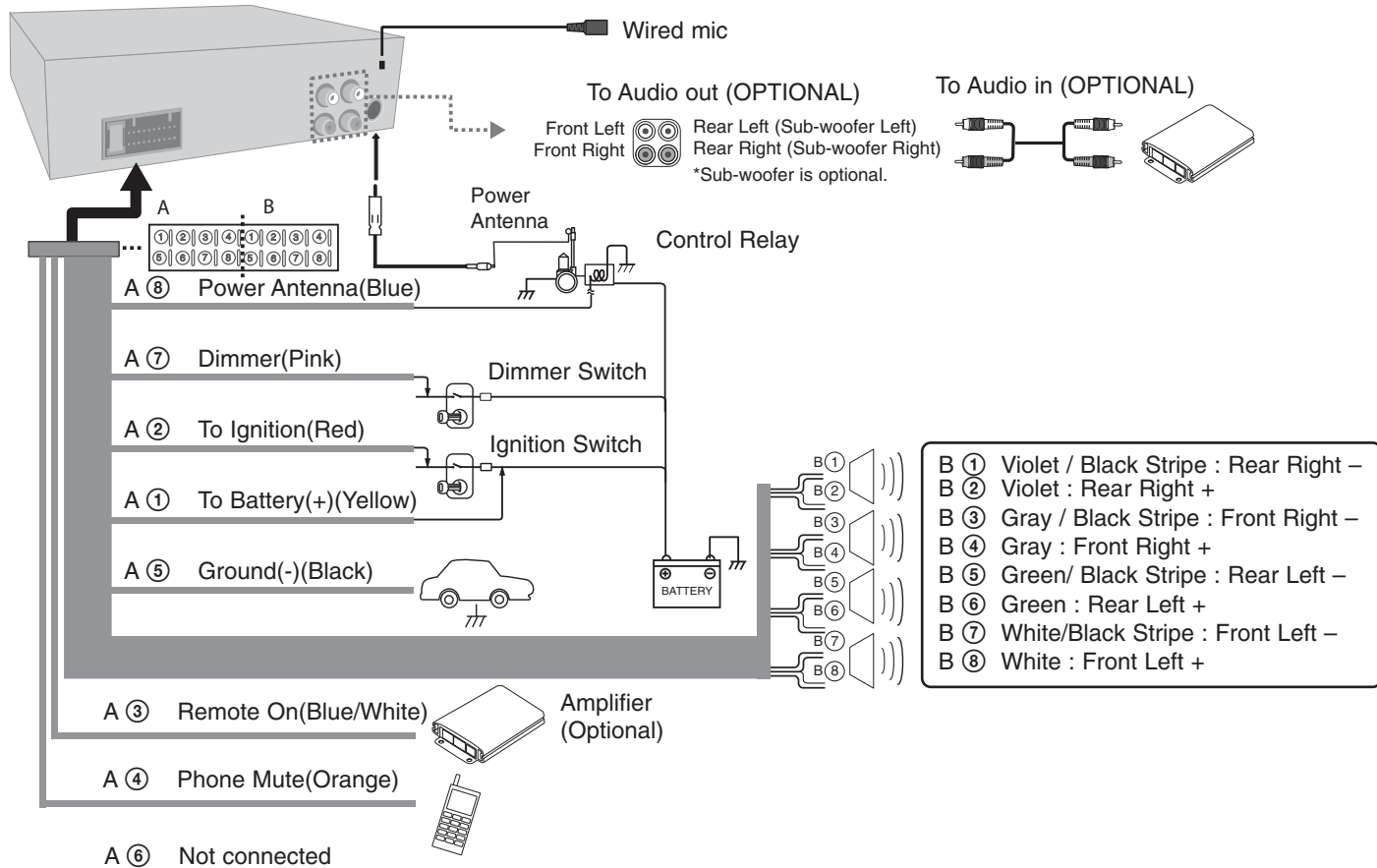

Basic Operation

	ON PLAYER	ON REMOTE
1. Turn the unit on.	Any key	-
2. Select a source.	SRC	SRC
3. Adjust the volume.	Rotate the volume knob	VOLUME ^ v
4. Turn the unit off.	Press and hold ● OFF	Press and hold ● OFF

Basic operation - more you can do

Mute

1. Press **MUTE** on the unit (**MUTE** on the remote control) to cut the sound.
2. To cancel it, press again.

Using EQ(Equalizer)

EQ is to increase or decrease the signal strength of audio frequencies. The function helps you to enjoy sound more plentifully.

Press **EQ** **XDSS+** on the unit repeatedly. The indicator lights up in the following order.

POP → CLASSIC → ROCK → JAZZ → VOCAL → SALSA → SAMBA → REGGAE → RUSSY → USER1 → USER2 → Off(not displayed)

Note

- When XDSS+ is set to "Off", you can adjust the EQ settings.
- You can adjust sound level to your preference. Once you select a USER mode and press [SOUND], then adjust the sound level(BASS(bass), MID(middle), TRB(treble)), it will be automatically stored for the currently selected USER mode. Refer to the "For sound setting" for USER 1/2 mode.

Using XDSS+ (Extreme Dynamic Sound System)

It improves the treble and bass sound.

1. Press and hold **EQ** **XDSS+** on the unit.
2. To cancel it, press and hold it again.

Checking the clock

1. Press **DISP** once to check the clock.
2. Press it again to remove it.

Turning off the display light

1. Press and hold **DISP**.
2. Press and hold it again to turn it on.

Note

Under the light-off condition, press any keys, the light is turned on and then off automatically if you don't press it within a few seconds.

Resetting the unit

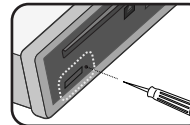

It resets the unit when it does not operate properly.

1. Press **[OPEN]** and pull out the front panel.
(Refer to page 6 for detaching the control panel.)
2. Prick the RESET hold with sharp object.

Adjusting general settings

You can adjust sound, light and other settings by using the **MENU** button.

On the Unit

1. Press and hold **FUNC** **MENU**.
2. Rotate the volume knob to select [SOUND], [LIGHT], or [OTHER] and press it.
3. Rotate the volume knob to select the item and press it.
4. Rotate the volume knob clockwise or counterclockwise to adjust the level.
5. Press the volume knob to confirm the setting.
If you want to return to the previous step, press **↶**.

On the Remote Control

1. Press and hold **FUNC** **MENU**.
2. Press **▲** or **▼** to select [SOUND], [LIGHT], or [OTHER] and press **ENTER**.
3. Press **▲** or **▼** to select the mode and press **ENTER**.
4. Press **▲** or **▼** to adjust the level.
5. Press **ENTER** to confirm the setting.
If you want to return to the previous step, press **↶**.

For Sound setting

You can adjust sound quality by adjusting the level of BAL(left/right speaker), FAD(front/rear speaker) and S--W(Sub-woofer:optional).

For Light setting

You can adjust the light effects by adjusting LED, DIM, or DIM L.

- LED COL1/ COL2/ AUTO: You can change the LED window color.
- DIM(Dimmer) OFF / ON / AUTO : You can change the brightness of the display window during the power-on status. When you set DIMMER to AUTO, the dimmer operates according to the car dimmer setting.
- DIM L (Dimmer Level): When you set DIM to ON/AUTO, you can adjust the dimmer level. (-2,-1,0,+1,+2)

For Other setting

- AUX (Auxiliary) ON / OFF

It is possible to use auxiliary equipment with this unit. Activate the auxiliary setting when using auxiliary equipment connected to this unit.

- BEEP 2ND / ALL
BEEP 2ND : The beep is generated when a key is long pressed. (1 sec)
BEEP ALL : The beep is generated when any key is pressed.
- A-EQ(Auto EQ) ON/OFF
AUTO EQ operates only in the music file supported with Genre in the device. When you set AUTO EQ to ON, POP, CLASSIC, ROCK, or JAZZ is automatically selected according to the music genre.
- SW(Subwoofer) OFF / SW 55HZ / SW 85HZ / SW 120 HZ
You can enable the subwoofer.
SW OFF <-> SW 55HZ <-> SW 85HZ <-> SW 120 HZ.
- DEMO OFF/ ON
You can change the initial indication on the display to information name (function name, EQ name, etc...) while listening to a source.
- CLK(Clock)
For the model RDS is not supported or even for a RDS supported unit, when RDS CT information is not received and then you set CT on the setting menu to OFF, you can adjust the time by yourself. Refer to the page 12 for setting the CT(Clock Time) ON/OFF.

Listening to a CD

	ON PLAYER	ON REMOTE
1. Open the front panel.	OPEN	-
2. Insert a CD.	-	-
3. Adjust the volume.	Rotate the volume knob	VOLUME ^ v

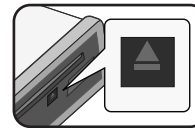

Listening to a CD - more you can do









Note

Make sure to press  after pressing **OPEN** to release a disc. Refer to the picture on the left.

Pausing or restarting playback

1. Press  on the player ( on the remote control) during playback.
2. Press it to resume playback.



Searching for a section within a track / file

1. Press and hold  or  on the player ( or  on remote control) for about 1 second during playback.
2. Press  on the player ( on the remote control) at the point you want.

Skipping to another track/ file

Press  or  on the unit ( or  on remote control.).

Or

1. Press the volume knob on unit or **ENTER** on the remote control.
2. Rotate the volume knob on unit or press  or  on the remote control to select a desired track or file.
2. Press **ENTER (or the volume knob)** to start playback.

Note

To skip to previous track, press briefly  within 3 seconds of playing time.

Checking information about your music

MP3/WMA files often come with tags. The tag gives the Title, Artist or Album. Press **DISP** repeatedly during MP3/WMA/CD TEXT file playback. If there is no information, "NO TEXT" will be shown in the display window.

Playing back tracks/files in a way you want

On the Unit

1. Press **FUNC/• MENU**.
2. Rotate the volume knob to select an item and press it.
4. Rotate the volume knob to set the option.
5. Press the volume knob to confirm the setting.
If you want to return to the previous step, press **↵**.

On the Remote Control

1. Press **INT/RPT/SHF**.
2. Press it again to cancel.

Or

1. Press **FUNC/• MENU**.
2. Press **▲** or **▼** to select an item and press **ENTER**.
3. Press **▲** or **▼** to set the option.
5. Press **ENTER** to confirm the setting.
If you want to return to the previous step, press **↵**.

● INT (Intro Scan)

Each files in the current selected folder (**■ INT**) or the first 10 seconds of each tracks/files (**INT**) on the disc are played.

● RPT (Repeat)

The current selected tracks/files (**1 RPT**) or folder (**■ RPT**) on the disc is played repeatedly.

● SHF (Shuffle)

Each files in the current selected folder (**■ SHF**) or all of the tracks/files (**SHF**) on the disc is played randomly. During random playback, even if you press **◀|**, you won't go back to the previous track.

Note

- **■** : The icon is displayed during MP3/WMA playback.
- **MP3/WMA Disc compatibility with this unit is limited as follows:**
 1. Sampling Frequency / 8 kHz to 48 kHz (MP3) 22.05 kHz to 48kHz (WMA)
 2. Bit rate / within 8 kbps to 320 kbps (include VBR) (MP3) 32 kbps to 320kbps (WMA)
 3. CD-R/CD-RW file system should be "ISO 9660"
 4. If you record MP3/WMA files using software which cannot create a FILE SYSTEM, for example "Direct-CD" etc., it will not be possible to playback MP3/WMA files. We recommend that you use "Easy-CD Creator" which creates an ISO9660 file system.

You have to set the disc format option to [Mastered] in order to make the discs compatible with the LG players when formatting rewritable discs. When setting the option to Live File System, you cannot use it on LG players. (Mastered/Live File System : Disc format system for Windows Vista)

Customers should also note that permission is required in order to download MP3/WMA files and music from the Internet. Our company has no right to grant such permission. Permission should always be sought from the copyright owner.

Listening to music from an external device

	ON PLAYER	ON REMOTE
1. Connect an external device to the AUX jack with line input cable.	-	-
2. Select a source to AUX.	SRC	SRC
3. Play the connected Auxiliary Equipment.	-	-
4. Adjust the volume.	Rotate the volume knob	VOLUME ▲ ▼

Listening to music from a portable player - more you can do

Preventing radical changes in volume as switching sources

Only when you set AUX to ON as switching sources, you can adjust the volume level of each source to prevent radical changes in volume by selecting GAIN LOW or HIGH.

1. Press **FUNC/• MENU**.
2. Rotate the volume knob on unit or press **▲** or **▼** on the remote control to set the option(GIN L/H).
3. Press the volume knob on unit or **ENTER** on the remote control to confirm the setting.
4. If you want to return to the previous step, press **↵**.

Listening to the radio

	ON PLAYER	ON REMOTE
1. Select a source to tuner.	SRC	SRC
2. Select a band.	BAND	BAND
3. Auto seek. Manual seek.	◀ -/ ▶ Press and hold ◀ -/ ▶	◀◀/▶▶ Press and hold ◀◀/▶▶

Listening to the radio - more you can do

Storing desired frequencies manually

1. Press **BAND** to select a desired band you want to store.
2. Press and hold **◀|-** or **+|▶** on the unit or **◀◀** or **▶▶** on the remote control until the beep sound is heard.
3. Press it repeatedly to select a desired frequency.
4. Press and hold one of preset buttons among 1 to 6 until the beep sound is heard.
5. Repeat steps 1 to 4 to preset other stations.

Note

- When a station is stored on the preset numbers on which another station of the same band has already been preset, the previously preset station is automatically erased.

Listening to a preset station

1. Press **BAND** to select a desired band.
2. Press the volume knob on the unit or **ENTER** on the remote control.
3. Rotate the volume knob on the unit or press **▲** or **▼** on the remote control to select a preset station.
4. Press the volume knob on the unit or **ENTER** on the remote control.

Or

Press **BAND** and then the desired preset button among 1 to 6 on the remote control.

Adjusting TUNER settings

On the Unit

1. Press **FUNC/▶ MENU**.
2. Rotate the volume knob to select an item and press it.
3. Rotate the volume knob to set the option and press it.
4. If you want to return to the previous step, press **↶**.

On the Remote Control

1. Press **FUNC/▶ MENU**.
2. Press **▲** or **▼** to select an item and press **ENTER**.
3. Press **▲** or **▼** to set the option and press **ENTER**.
4. If you want to return to the previous step, press **↶**.

● PTY (Program type) (OPTIONAL)

It searches the radio stations by program types of FM tuner. The program types are displayed as follows.

NEWS	VARIED	LEISURE	JAZZ
AFFAIRS	WEATHER	DOCUMENT	COUNTRY
INFO	FINANCE	POP M	NATION M
SPORT	CHILDREN	ROCK M	OLDIES
EDUCATE	SOCIAL	EASY M	FOLK M
DRAMA	RELIGION	LIGHT M.	
CULTURE	PHONE IN	CLASSICS	
SCIENCE	TRAVEL	OTHER M	

● PI (Programme Identification) SOUND / MUTE (OPTIONAL)

PI SOUND : When the frequency of a tuned station switches to an AF(Alternative frequency) with an unidentified PI, it keeps the sound.

PI MUTE : When the frequency of a tuned station switches to an AF with an unidentified PI, it mutes the sound until the PI is identified.

● CT (Clock Time) ON/OFF (OPTIONAL)

You can use the RDS CT information to update the time. When RDS CT information is not received and then you set CT to OFF, you can adjust the time by yourself. Refer to the page 10 for setting the clock.

● TA(Traffic Announcement) ALARM / SEEK (OPTIONAL)

TA ALARM : When the tuned station has no TP information for 5 seconds, a double beep sound is output.

TA SEEK : When the tuned station does not receive TP information for 5 seconds, the receiver retunes to the next station that has the TP information.

- REG (Region) ON / OFF (OPTIONAL)

REG ON : The unit switches to another station, within the same network, broadcasting the same program when the receiving signals from the current station become weak.

REG OFF : The unit switches to another station, within the same network when the receiving signals from the current station become weak. (This mode, the program may differ from the one currently received.)

- AF(Alternative frequency) ON / OFF (OPTIONAL)

When the reception quality drops, the tuner automatically changes to another station in the network, broadcasting a better reception quality, using the PI and AF codes.

- SENS(Tuner sensitivity) MID/ HI/ LOW

In a area in which signal reception is weak, it helps the tuner to search more stations. The weaker the reception is, the lower option you should set to.

- PS(Preset scan)

Each preset station appears. To cancel, press **ENTER (or the volume knob)**.

- AS (Auto Store)

The six strongest broadcasting frequencies will be stored under preset button 1 to 6 in the order of their signal strength.

To cancel, press **ENTER (or the volume knob)**.

Using an USB device

	ON PLAYER	ON REMOTE
1. Open the USB cover.	-	-
2. Connect the USB device.	-	-
3. Adjust the volume.	Rotate the volume knob	VOLUME ▲ ▼

Using an USB device - more you can do

Moving to another drive

When connecting this unit to multi reader, press **BAND** (**BAND/DRV** on remote control) to go to the next drive. Each time you press the button, the driver modes changes.

Note

- If the USB device is already connected, press **SRC** (**SRC** on remote control.) to select a source to USB.
- Other functions are same with “Listening to a CD - more you can do”. Refer to page 10.

Recording to USB from audio CD or FM tuner

1. Open the USB cover and connect it to the unit.
2. Select audio CD or FM tuner.
3. Start playback.
4. Press **REC** to start recording.
 - For one track CD recording, press it once.
 - For all tracks recording, press and hold it until the beep is heard.
5. Press it again to stop.

Note

- Only in audio CD and FM tuner, recording is available.
- Do not remove the USB device during recording, or an incomplete file may be made and not deleted on PC.
- When USB memory is full, “Memory Full” displays and stops recording.
- For tuner recording, the broadcastings are recorded by 20 moments on a file name.

Quick search of a desired file

You can select and play a desired file regardless of the order in USB.

1. Press **ENTER** (or the volume knob) to check all files.
2. Rotate the volume knob on unit or press **▲** or **▼** on the remote control to select a desired file.
3. Press **ENTER** (or the volume knob) to start playback.

Note

- Press and hold **ENTER** (or the volume knob) to check all folders. Then, repeat the previous steps from 1 to 3 for playing a desired file.
- If the USB device is already connected, press **SRC** (**SRC** on remote control.) to select a source to USB.
- Other functions are same with “Listening to a CD - more you can do”. Refer to page 10.

Look out for the following

- Do not extract the USB device while in operation.
- For a large capacity USB, it may take longer than a few minute to be searched.
- To prevent data loss, back up all data.
- If you use a USB extension cable or USB hub, the USB device is not recognized.
- Using NTFS file system is not supported. (Only FAT(16/32) file system is supported.)
- External HDD, Locked devices or hard type USB devices are not supported.
- USB port of the unit can not be connected to PC. This unit can not be used as a storage device.

Listening to music by connecting iPod

You can enjoy iPod-stored music on the unit by connecting it to the USB connector using the appropriate cable.

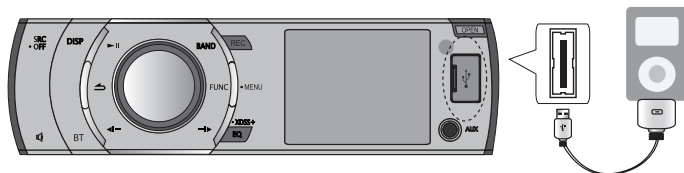

Not Supplied

	ON PLAYER	ON REMOTE
1. Open the USB cover.	-	-
2. Connect the iPod.	-	-
3. Adjust the volume.	Rotate the volume knob	VOLUME ▲ ▼

Note

- If the iPod is already connected, press **SRC** to select a source to USB.
- Refer to the page 23 to check the compatible iPod model for this unit.

Listening to music by connecting iPod

- more you can do

Pausing or restarting playback

Press **▶||** on the player (**▶/||** on the remote control) during playback. Press this button again to resume play.

Checking information about your music

MP3/WMA files often come with tags. The tag gives the Title, Artist or Album. Press **DISP** repeatedly during MP3/WMA file playback. If there is no information, "NO TEXT" will be shown in the display window.

Playing back files in a way you want

On the Unit

1. Press **FUNC/• MENU**.
2. Rotate the volume knob to select an item and press it.
3. Rotate the volume knob to set the option.
4. Press the volume knob to confirm the setting. If you want to return to the previous step, press **↶**.

On the Remote Control

1. Press **RPT/SHF**.
2. Press it again to cancel.

Or

1. Press **FUNC/• MENU**.
2. Press **▲** or **▼** to select an item and press it.
3. Press **▲** or **▼** to set the option.
4. Press **ENTER** to confirm the setting. If you want to return to the previous step, press **↶**.

● PRT (Repeat)

The current selected tracks/files (1 RPT) on the iPod is played repeatedly. During playback, if you press **◀|** or **|▶**, you won't go back to the previous or next track.

● SHF (Shuffle)

Each file in the currently selected album (**■ SHF**) or all of the tracks/files (**SHF**) on the iPod are played randomly.

● SPD (BOOK SPEED)

You can adjust the the audiobook speed of iPod to NOR(Normal), SLOW, or FAST.

Playing back files by music menus

You can check files by music menus and play it back.

The music menus are as follows.

PLAYLISTS → ARTISTS → ALBUMS → GENRES → SONGS →
COMPOSER → AUDIO BOOK → PODCAST→...

1. Press the volume knob on the unit or **ENTER** on the remote control.
2. Rotate the volume knob on the unit or press **▲** or **▼** on the remote control to select a music menu and press it.
3. Rotate the volume knob on the unit or press **▲** or **▼** on the remote control to select a file.
4. Press the volume knob on the unit or **ENTER** on the remote control to confirm the setting. If you want to return to the previous step, press **↶**.

Connecting a Bluetooth wireless technology

Before you start the pairing procedure, make sure the *Bluetooth* wireless technology is turned on in to your phone. Refer to your phone's user guide. Pairing links your unit and phone with *Bluetooth* wireless technology, and is required only once for the initial setup. If the connection is successful, the phone is registered (Device 1–5) and the flashing of indicator stops on the unit. The process of pairing may be different depend on the phones. The PIN CODE is 1234.

	ON PLAYER
1. Enter the menu.	BT
2. Find the "CONN" menu.	Rotate the volume knob
3. Search the phones supported Bluetooth wireless technology.	Press the volume knob
4. Select a phone you want to connect.	Rotate the volume knob
5. Connect the phone.	Press the volume knob
6. Select the "CONN" menu.	Press the volume knob

Note

- If you power off the unit while talking on the phone through the unit by using the BT function, the function is deactivated and you can talk on the phone directly.
- The microphone needs to be close to and pointed toward the person speaking. Install the microphone as shown below.

Microphone unit (supplied)

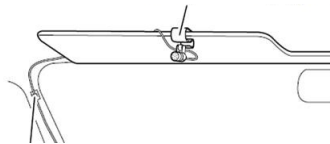

Using the buttons for Bluetooth wireless technology

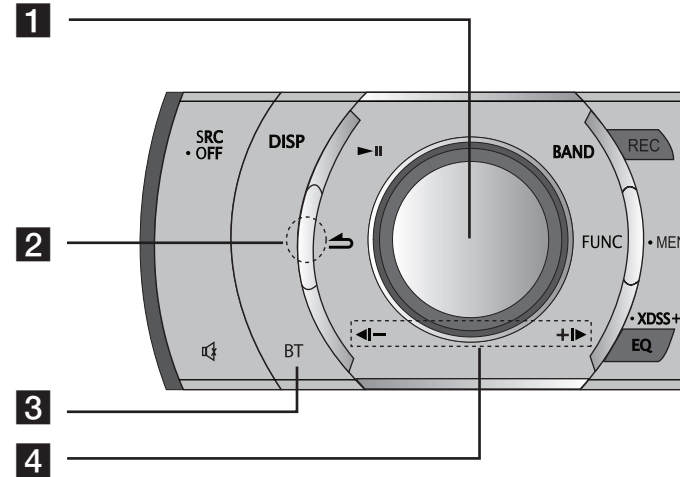

- Press **the volume knob**: Go to the next contents of the setting.
 - Rotate **the volume knob**: Move the contents vertically on the setting or choose a spell when you write the words on the unit.
- ↶ : Returns to the previous step.
- **BT**: Press it to enter BT function.
- Adjusts the mic volume while talking on the phone by BT function.
 - **◀|**: Press it to delete a spell or go back previous contents. Press more 1 second to delete all words entered on display when you write some words on the unit.
 - **+|▶**: When you write some words on the unit, press it to move next space on display.

Using a *Bluetooth* wireless technology - more you can do

Disconnecting a phone

Go to the menu (BT -> CONN -> Connected device name -> DISCONNECT).

Answering and Ending a call

When your unit rings, press **BT** to answer a call.
To end a call, press and hold **BT**.

Rejecting a call

When your unit rings, press and hold **BT**.

Making a call saved as a preset number

Press **BT** and a preset number (1 to 6).

Checking missed calls

When an incoming call is not answered, the missed call message is displayed on the display window (without headset profile). When the “?” appears, go to the menu (BT -> CALL -> MISSED). You can check the list of missed call. To place a call, press **BT**. And to end the call and hang up the phone, press and hold **BT**.

Note

- The lists of Missed calls, Dialed calls and Received calls are sorted from newest to oldest entries.
- When you want to make an international call, press **+I▶** to add “+” and to delete it press again.
- “+” can only be added when the detail list of Missed call, Dialed call or Received call is selected.
- Rejecting a call / Making a call saved preset number / Missed call notification (These features are only available on phones with Headset profile.)

Saving call numbers in the latest calls

You can easily save up to 6 phone numbers in the latest calls. Go to the menu (CALL -> RECEIVED or MISSED -> Rotate the volume knob to select the phone number you want to save -> SAVE -> select 1 to 6).

Audio transfer

It is possible to switch the audio connection between your phone equipped with Bluetooth wireless technology and this unit.

- 1 Press **BT** to answer the call.
- 2 Press **BT** again. The “PRIVATE” is displayed.
If the private mode is selected on the unit, press **BT** to return to the call to hands-free mode.

Paring your unit and device with *Bluetooth* wireless technology (MP3 Player, MP3 Phone...)

When you activate your Bluetooth device's linked unit, you can listen to MP3 with wireless connections. The method of use for a Bluetooth device is the same as when using a Bluetooth phone. Refer to the phone's user guide for using this function.

Playing MP3 files

When you turn Bluetooth on, your device supported Bluetooth wireless technology displays “Bluetooth” on the home screen. The Bluetooth remains on until you turn the device off. Press **SRC** repeatedly to select “BT MUSIC”. To play an MP3 file stored on your device. Refer to the phone's user guide for using this function.

Bluetooth wireless technology profiles information.

In order to use Bluetooth wireless technology, devices must be able to interpret certain profiles. This unit is compatible with following profiles.

- GAP** (Generic Access Profile)
- HFP** (Hands Free Profile)
- HSP** (Hands Set Profile)
- GAVDP** (Generic Audio/Video Distribution Profile)
- A2DP** (Advanced Audio Distribution Profile)
- AVRCP** (Audio/Video Distribution Remote Control Profile)
- OPP** (Object Push Profile)

Adjusting the setting. (Bluetooth wireless technology)

BT

CALL	RECEIVED/DIALED/MISSED	Phone number list.
	RECEIVED	• To call the phone number, select the phone number and press BT .
	DIALED	• To save it, select the phone number and press the volume knob . "SAVE" will be shown. Press the volume knob again. Rotate the volume knob to select a preset number(1 to 6). Press the volume knob again. The phone number be saved.
	MISSED	
	PRESET	— Checks and deletes the phone number saved preset number. To delete the phone number, select the preset number by rotating the volume knob . And then press the volume knob . Press the volume knob again when the "DELETE" is displayed.
	REDIAL	— Adjusts the counts of redial. (1 TIME <-> 2 TIMES.)
P--BOOK	DIAL	— Enters the number directly on the unit. To select the 1 to 10 rotate the volume. Press +▶ to make the phone number. To call it, Press BT .
	LIST	— Checks the list of the phone numbers saved by phonebook.
	SEARCH	— Searches the phone number in the list. (English and Russian only) Press +▶ longer than 1 second to change the languages between Russian and English.
	GET (ADD)	— GET : Getting the Phonebook from the phone automatically. (This menu is only available with phones supported this function.) ADD (Under disconnection) : PHONEBOOK -> ADD-> Press the volume knob -> "000/500" will be displayed. Then send the phonebook data from your phone. Depend on your phone, sending process is different. Refer to your phone's guide.
CONN	Connected Device Name	— Connected Device Name will be displayed. When the unit is not under connection, you can search the phones available to connect. Select the register in the Connection contents.
SETUP	VISIBL	— Makes it is impossible to search this unit. (SHOWN <-> HIDDEN)
	A--CONN	— Adjusts connection with automatically or not. (AUTO <-> MANUAL)
	ANSWER	— Adjusts answering automatically or not. (AUTO <-> MANUAL)
	MIC	— Adjusts microphone volume on the phone from 1 to 5. While you are on the phone with bluetooth wireless technology, rotate the volume knob to adjust the MIC volume.
INFO	NAME	— Changes the name of this unit.
	PIN	— Changes the PIN code. Default is 1234.
	ADDR	— Checks the address.

Phone compatibility list (Bluetooth wireless technology)

Bluetooth list and manufacturing company applicable.

H : Handsfree
A : Audio Streaming (A2DP)

P : Phonebook Sync (GET)
V : Object Push(Vcard, ADD)

Company	List	H	A	P	V	Company	List	H	A	P	V	Company	List	H	A	P	V		
Nokia	3230	○			○	Nokia	E70	○			○	Motorola	E398	○			○		
	3250	○			○		E71	○	○	○	○		E550	○			○	○	
	3650	○			○		E73	○	○	○	○		E680	○			○	○	
	5300	○	○	○	○		E90	○	○		○		E680i	○	○		○	○	○
	6021	○		○	○		N70	○			○		KRZR K1	○	○	○		○	○
	6103	○		○	○		N71	○			○		L72	○	○	○		○	○
	6120	○	○		○		N73	○	○				RAZR V3	○		○		○	○
	6131	○	○	○	○		N77	○	○		○		RAZR V3i	○		○		○	○
	6230	○			○		N80	○			○		RAZR V3X	○	○			○	○
	6270	○		○			N82	○	○		○		RAZR V9	○	○	○		○	○
	6280	○	○	○	○		N90	○	○		○		RIZR Z3	○	○			○	○
	6300	○	○	○	○		N91	○	○		○		RIZR Z8	○	○	○		○	○
	6500	○	○		○		N92	○			○		ROKR E2	○	○			○	○
	6600	○			○		N93	○	○		○		ROKR E6	○	○			○	○
	6630	○			○		N95	○	○		○		SLVR L7	○			○		○
	6650	○		○	○		N-Gage	○			○		U6	○			○		○
	6670	○			○		N-Gage QD	○			○		V195	○			○		○
	6680	○			○		E63	○	○	○	○		V360	○			○		○
	6681	○			○		N72	○	○		○		V3ROHS	○	○			○	○
	6820	○			○		N97	○	○		○		V500	○			○		○
	7370	○		○	○		N81	○	○		○		V525	○			○		○
	7380	○		○	○		N85	○	○		○		V600	○			○		○
	7610	○			○		N86 8MP	○	○		○		A1600	○	○				○
	7650	○			○		N95	○	○		○		A1890	○	○				○
	7600	○			○		N96	○	○		○		V8	○	○				○
	8600	○	○	○	○		5530	○	○		○		A1200	○	○				○
	8800	○	○	○	○		5310	○	○	○	○		V6	○	○				○
	9500	○			○		5320	○	○		○		W510	○	○				○
	3650 (Italy)	○			○		5800i	○	○		○		SONY	K610i	○			○	○
	5500 SPORT	○			○		5800	○	○		○		ERICSSON	K618i	○	○			○
	6230i	○		○	○		6120C	○	○		○		K700i	○					○
	6820a	○			○		6303C	○	○	○	○		K750i	○			○		○
	7500prism	○	○		○		2630	○	○		○		K770i	○	○				○
7650 (Italy)	○			○	6110 Navigator	○	○		○	K800i	○	○	○			○			
8910i	○		○	○	6288	○	○		○	K850i	○	○	○			○			
9300i	○			○	E65	○	○		○	M600i	○	○	○			○			
E50	○			○	E75	○	○		○	P1i	○	○	○			○			
E51	○	○		○	Motorola	A1000	○			P990i	○	○	○			○			
E60	○			○	A780	○			○	S500i	○	○	○			○			
E61	○			○	E1000	○			○	S700i	○					○			
E62	○			○	E1070	○	○		○	T610	○			○		○			

Bluetooth list and manufacturing company applicable.

H : Handsfree

P : Phonebook Sync (GET)

A : Audio Streaming (A2DP)

V : Object Push(Vcard, ADD)

Company	List	H	A	P	V	Company	List	H	A	P	V	Company	List	H	A	P	V	
SONY ERICSSON	T68i	○		○	○							LG	CU500	○	○		○	
	V600	○		○	○		G600	○	○		○		KE970	○	○		○	
	V800	○		○	○		i900	○	○		○		KG245	○			○	
	W550i	○		○	○		L600	○	○		○		KG800	○			○	
	W710i	○	○	○	○		U600	○	○		○		U880	○			○	
	W800i	○		○	○		U700	○	○		○		U890	○	○			
	W810i	○		○	○		Z170	○	○		○		M4410	○			○	
	W850i	○	○	○	○		T509	○			○		KF600	○	○		○	
	W980i	○	○	○	○		SIEMENS	EF81	○		○		○	KE850 PRADA	○	○		○
	Z1010	○		○	○		S55	○			○		KG290	○			○	
	Z600	○		○	○		S65	○			○		KE500	○	○		○	
	W300	○			○		S88	○			○		KM500	○	○		○	
	W880	○	○		○		SK65	○			○		KU990 VIEWTY	○	○		○	
	W910	○	○		○		SL75	○		○	○		KU580	○	○		○	
	Z610	○	○		○		SX1	○			○		KU970	○	○		○	
						SXG75	○		○	○	KU960	○	○					
SAMSUNG	D500	○			○		BLACK	8800	○		○		U370	○			○	
	D600	○	○		○		BERRY	8100(PEARL)	○				KE770	○	○		○	
	D820	○	○		○			8707v	○		○	○	GD900	○	○		○	
	D900	○	○		○			BOLD 9000	○	○		○	KF900 Prada	○	○		○	
	E770	○	○		○			Curve 8310	○	○	○	○	KC910 Renoir	○	○		○	
	E900	○		○	○		HP	HW6915	○		○	○	KM900 Arena	○	○		○	
	i600	○	○		○			iPAQ h6315	○			○	KS10	○	○		○	
	T509	○			○							○	KU250	○	○		○	
	X820	○	○		○		HP											
	Z540V	○			○		PALM	Treo750v	○	○		○						
	A707(SYNC)	○	○				PHILIPS	O2 Xda Atom	○	○		○	NEC	N750	○			
	S5230	○	○		○								N930	○				
	D900	○	○		○		SHARP	GX15	○			○						
	i8910	○	○		○			GX25	○			○	SAGEM	MYX6-2	○			
	S8003	○	○		○								Apple	iPhone	○			
	S8300	○	○		○		I-MATE	K-JAM	○			○		iPhone 3G	○	○		
	E950	○	○		○		PANTECH	PG-6200	○	○		○		iPhone 3GS	○	○	○	
	F210	○	○		○			PG-8000	○			○						
	F300	○	○		○		HTC	Touch	○	○		○						
								Touch Pro	○	○		○						

Note

1. When the phone features <Bluetooth Power Save> function, you should make the function turned on to maintain connection.
2. When you switch the call mode from handsfree to phone, the connection may be disconnected.
3. Some phones don't support Reject function.
4. Low battery in phone may cause the problems.



“The *Bluetooth* word mark and logos are owned by the Bluetooth SIG, Inc. and any use of such marks by LG Electronics is under license. Other trademarks and trade names are those of their respective owners.”

Bluetooth® wireless technology is a system which allows radio contact between electronic devices within a max. range of 10 meters. Connecting individual devices under *Bluetooth*® wireless technology does not incur any charges. A mobile phone with *Bluetooth*® wireless technology can be operated via the Cascade if the connection was made via *Bluetooth*® wireless technology.

Operating condition for using a *Bluetooth* wireless technology function

- Close windscreen.
- Turn off the air conditioner/ heater.
- Stop the vehicle or drive at low speed.
- Make the call in a quiet location.
- There may be differences in call quality depending on phone type, road conditions weather, etc.
- Using the phone while driving may cause unexpected accidents.
- The *Bluetooth* wireless technology function may not operate properly with certain types of phones equipped with *Bluetooth* wireless technology.

Troubleshooting

	Symptom	Cause	Correction
General	Power doesn't turn on / The unit doesn't operate.	Leads and connectors are not properly.	Confirm once more that all connections are correct.
		The fuse is blown.	Rectify the problem that caused the fuse to blow, and then replace it. Be very sure to install the correct fuse with the same rate.
		Noise and other factors are causing the built-in microprocessor to operate incorrectly.	Turn the unit off and then on.
	No sound is heard / The volume level will not rise.	Cables are not connected correctly.	Connect the cables correctly.
CD	There's audio skipping.	This unit is not firmly secured.	Secure this unit firmly.
	The playback is not possible.	The disc is dirty.	Clean the disc.
		The loaded disc is of a type this unit cannot play.	Check what type the disc.
Radio	Radio stations cannot be tuned in.	The signal strength of the stations is too weak(when tuning in with automatic tuning.)	Tune in the stations manually.
		No station has been preset or preset stations have been cleared(when tuning by scanning preset stations.)	Preset the stations.(Refer to the page 12)
iPod	iPod does not work.	Check whether iPod is connected to the unit correctly.	Connect it to the unit correctly.
Remote control	The unit does not operate correctly even when the appropriate remote control buttons are pressed.	Battery power is low.	Load a new battery.

Specifications

General

Output Power	24 W x 4 CH (RMS)
Power Source	DC 12V
Speaker impedance	4 Ω
Ground System	Negative
Dimensions (W x H x D)	178 x 50 x 169 mm (Without Control Panel)
Net Weight	1.35 kg

Tuner

FM

Frequency Range	87.5 MHz to 107.9 MHz, 87.5 MHz to 108 MHz, 65 MHz to 74 MHz or 87.5 MHz to 108 MHz
S/N Ratio	55 dB
Distortion	0.7 %
Usable Sensitivity	12 dBμV

AM (MW)

Frequency Range	520 kHz to 1720 kHz or 522 kHz to 1620 kHz
S/N Ratio	50 dB
Distortion	1.0 %
Usable Sensitivity	28 dBμV

CD

Frequency Response	20 Hz to 20 kHz
S/N Ratio	80 dB
Distortion	0.12 %
Channel Separation (1 kHz)	55 dB

AUX

Frequency Response	20 Hz to 20 kHz
S/N Ratio	80 dB
Distortion	0.1 %
Channel Separation (1 kHz)	45 dB
Max Input Level (1 kHz)	1.1 V

Bluetooth

TX POWER	4 dBm
Frequency Range	2402 MHz to 2480 MHz
Version	Bluetooth Specification 2.0 + EDR

USB

Version	USB 1.1
---------	---------

Line OUT

Frequency Response	20 Hz to 20 kHz
Output Voltage	2 V (Max.)

Subwoofer (optional)

Frequency Response	20 Hz to 120 Hz
Output Voltage	2.0 V (Max.)

Compatible iPod models

- iPod touch
- iPod classic
- iPod with video (5th generation)
- iPod nano (1st generation)
- iPod nano (2nd generation)
- iPod nano (3rd generation)



"Made for iPod" means that an electronic accessory has been designed to connect specifically to iPod and has been certified by the developer to meet Apple performance standards.

Apple is not responsible for the operation of this device or its compliance with safety and regulatory standards.

iPod is a trademark of Apple Inc., registered in the U.S. and other countries.

Designs and specifications are subject to change without notice.

The making of unauthorized copies of copy-protected material, including computer programs, files, broadcasts and sound recordings, may be an infringement of copyrights and constitute a criminal offense. This equipment should not be used for such purposes.

**Be responsible
Respect copyrights**

