



OWNER'S MANUAL

Hybrid Digital Video Recorder

Please read this manual carefully before operating your set and retain it for future reference.

MODELS

LE5016/LE5008 Series

LE4016/LE4008 Series

1

Safety Information



CAUTION

**RISK OF ELECTRIC SHOCK
DO NOT OPEN**



CAUTION: TO REDUCE THE RISK OF ELECTRIC SHOCK
DO NOT REMOVE COVER (OR BACK)
NO USER-SERVICEABLE PARTS INSIDE
REFER SERVICING TO QUALIFIED SERVICE PERSONNEL.



This lightning flash with arrowhead symbol within an equilateral triangle is intended to alert the user to the presence of uninsulated dangerous voltage within the product's enclosure that may be of sufficient magnitude to constitute a risk of electric shock to persons.



The exclamation point within an equilateral triangle is intended to alert the user to the presence of important operating and maintenance (servicing) instructions in the literature accompanying the product.

FCC WARNING: This equipment may generate or use radio frequency energy. Changes or modifications to this equipment may cause harmful interference unless the modifications are expressly approved in the instruction manual. The user could lose the authority to operate this equipment if an unauthorized change or modification is made.

REGULATORY INFORMATION: FCC Part 15

This equipment has been tested and found to comply with the limits for a Class A digital device, pursuant to Part 15 of the FCC Rules. These limits are designed to provide reasonable protection against harmful interference when the equipment is operated in a commercial environment.

This equipment generates, uses, and can radiate radio frequency energy and, if not installed and used in accordance with the instruction manual, may cause harmful interference to radio communications.

Operation of this equipment in a residential area is likely to cause harmful interference in which case the user will be required to correct the interference at his own expense.

- A suitable conduit entries, knock-outs or glands shall be provided in the cable entries of this product in the end user.
- **Caution:** Danger of explosion if battery is incorrectly replaced. Replaced only with the same or equivalent type recommended by the manufacturer. Dispose of used batteries according to the manufacturer's instructions.
- Holes in metal, through which insulated wires pass, shall have smooth well rounded surfaces or shall be provided with brushings.

This Class A digital apparatus complies with Canadian ICES-003.
Cet appareil numérique de la classe A est conforme à la norme NMB-003 du Canada.

Warning: Do not install this equipment in a confined space such as a bookcase or similar unit.

Warning: Wiring methods shall be in accordance with the National Electric Code, ANSI/NFPA 70.

Warning: This is a class A product. In a domestic environment this product may cause radio interference in which case the user may be required to take adequate measures.

Warning: To reduce a risk of fire or electric shock, do not expose this product to rain or moisture.

Caution: This installation should be made by a qualified service person and should conform to all local codes.

Caution: To avoid electrical shock, do not open the cabinet. Refer servicing to qualified personnel only.

Caution: The apparatus should not be exposed to water (dripping or splashing) and no objects filled with liquids, such as vases, should be placed on the apparatus.

Caution:

This product employs a Laser System. To ensure proper use of this product, please read this owner's manual carefully and retain it for future reference. Should the unit require maintenance, contact an authorized service center. Performing controls, adjustments, or carrying out procedures other than those specified herein may result in hazardous radiation exposure. To prevent direct exposure to laser beam, do not try to open the enclosure. Visible laser radiation when open. DO NOT STARE INTO BEAM.

To disconnect power from mains, pull out the mains cord plug. When installing the product, ensure that the plug is easily accessible.



LG Electronics hereby declares that this/these product(s) is/are in compliance with the essential requirements and other relevant provisions of Directive 2004/108/EC, 2006/95/EC, and 2009/125/EC.

European representative :

LG Electronics Service Europe B.V. Veluwezoom 15,
1327
AE Almere. The Netherlands
(Tel : +31-(0)36-547-8888)

Disposal of your old appliance



1. When this crossed-out wheeled bin symbol is attached to a product it means the product is covered by the European Directive 2002/96/EC.
2. All electrical and electronic products should be disposed of separately from the municipal waste stream via designated collection facilities appointed by the government or the local authorities.
3. The correct disposal of your old appliance will help prevent potential negative consequences for the environment and human health.
4. For more detailed information about disposal of your old appliance, please contact your city office, waste disposal service or the shop where you purchased the product.

EEE Compliance with Directive. (for Turkey only)

Safety way to remove the battery or the battery from the equipment:

Remove the old battery or battery pack, follow the steps in reverse order than the assembly. To prevent contamination of the environment and bring on possible threat to human and animal health, the old battery or the battery put it in the appropriate container at designated collection points. Do not dispose of batteries or battery together with other waste. It is recommended that you use local, free reimbursement systems batteries and accumulators. The battery shall not be exposed to excessive heat such as sunshine, fire or the lile.

IMPORTANT SAFETY INSTRUCTIONS

1. Read these instructions.
 2. Keep these instructions.
 3. Heed all warnings.
 4. Follow all instructions.
 5. Do not use this apparatus near water.
 6. Clean only with dry cloth.
 7. Do not block any ventilation openings. Install in accordance with the manufacturer's instructions.
 8. Do not install near any heat sources such as radiators, heat registers, stoves, or other apparatus (including amplifiers) that produce heat.
 9. Do not defeat the safety purpose of the polarized or grounding-type plug. A polarized plug has two blades with one wider than the other. A grounding type plug has two blades and a third grounding prong. The wide blade or the third prong are provided for your safety. If the provided plug does not fit into your outlet, consult an electrician for replacement of the obsolete outlet.
 10. Protect the power cord from being walked on or pinched particularly at plugs, convenience receptacles, and the point where they exit from the apparatus.
 11. Only use attachments/accessories specified by the manufacturer.
 12. Use only with the cart, stand, tripod, bracket, or table specified by the manufacturer, or sold with the apparatus. When a cart is used, use caution when moving the cart/apparatus combination to avoid injury from tip-over.
- 
13. Unplug this apparatus during lightning storms or when unused for long periods of time.
 14. Refer all servicing to qualified service personnel. Servicing is required when the apparatus has been damaged in any way, such as power-supply cord or plug is damaged, liquid has been spilled or objects have fallen into the apparatus, the apparatus has been exposed to rain or moisture, does not operate normally, or has been dropped.

Safety warnings and Cautions

The following are warnings and cautions for the safety of the users and for the prevention of any property damage. Please read the following carefully.

WARNING

- Turn off the system before installation. Do not plug in several electric devices to the same outlet.
 - This may cause heating, fire, or electric shock.
- Do not place any liquid container on the system, such as water, coffee, or other beverage.
 - If liquid is poured onto the system, it can cause a system breakdown or fire.
- Prevent the power cable from being severely bent or having pressure exerted on it by a heavy object.
 - This may cause fire.
- Clean the dust around the system on a regular basis. When cleaning the system, always use a dry cloth. Do not use a wet cloth or other organic solvents.
 - This may damage the surface of the system and can cause a system breakdown or electric shock.
- Avoid any place with moisture, dust, or soot.
 - This can cause fire or electric shock.
- When pulling the power cable from the plug, do so gently. Do not touch the plug with wet hands and avoid using the plug if the holes in the outlet are too loose.
 - This may cause fire or electric shock.
- Do not attempt to disassemble, repair, or modify the system on your own. It is extremely dangerous due to the high voltage running through the system.
 - This may cause fire, electric shock, or serious injury.
- Check for any danger signs such as a moist floor, a loosened or damaged power cable, or an unstable surface. If you encounter any problems, ask your dealer for assistance.
 - This may cause fire or electric shock.
- Keep a distance of at least 15cm between the back of the system and the wall for the cables connected to the system otherwise, they may be bent, damaged, or cut.
 - This may cause fire, electric shock, or injury.
- Install the system in a cool place without direct sunlight and always maintain room temperature. Avoid candlelight and heat generating devices such as heaters. Keep the system away from places where many people pass.
 - This may cause fire.
- Install the system on a plain surface with sufficient air ventilation. Do not place the system on an elevated surface.
 - This may cause system breakdown or serious injury.
- The power outlet must be placed on the ground, and the voltage range must be within 10% of the voltage rate. Do not use the same outlet with a hair dryer, iron, refrigerator, or any heating appliances.
 - This may cause fire, over heating or electric shock.
- When the system's battery is depleted, replace it with the same or equivalent type of battery specified by the manufacturer. Depleted batteries should be discarded according to the manufacturer's instructions.
 - This may cause an explosion.
- If the system's HDD exceeds its life span, you may not be able to recover any data stored inside the HDD. If the video on the system screen appears 'damaged' while playing a recording stored inside the system's HDD, it must be replaced with a new one. Ask for an engineer's assistance for HDD replacement from your dealer.
 - LG Electronics is not responsible for deleted data caused by user mishandling.

CAUTION

Please beware of the following precautions before installing the DVR.

- Avoid positioning the product in any place where the unit may come into contact with moisture, dust, or soot.
- Avoid placing in direct sunlight or near heating appliances.
- Keep the product away from electric sparks or magnetic substances.
- Do not place any conductive material through the ventilation grills.
- Keep the system turned off before installation.
- Ensure enough space is left for cable connections.
- Place the system on a solid surface with sufficient air ventilation. Avoid any surface that vibrates.
- Placing the system near electronic devices such as a radio or a TV may cause the product to breakdown.
- Do not disassemble the product without seeking assistance from LG Electronics.
- Do not place any heavy object on the system.
- Prevent any substances from being inserted into the system.
 - This may cause system breakdown.
- Install the system in a place with sufficient air ventilation.
 - Keep at least 15cm distance between the back of the system and the wall, and at least 5cm distance between the side of the system and the wall.
- Do not install the system in a place with high magnetic, electric wave, or wireless devices such as a radio or a TV.
 - Do not install the system in a place with magnetic objects, electric frequencies, or vibration.
- Do not place any heavy object on the system.
 - This may cause system breakdown.
- Install the system on a stable, level surface.
 - The system may not operate properly.
- Install the system in a place with appropriate moisture and temperature levels.
 - Avoid installing the system in a place with high (over 40°C) or low (under 0°C) temperature.
- The system can be damaged from a strong impact or vibration. Avoid throwing objects within the vicinity of the system.
- Avoid direct sunlight or any heating appliances.
 - Recommended operating temperature is over 0°C (32°F).
- Ventilate the air inside the system operation room, and tighten the system cover firmly.
 - System breakdown may be caused by an inappropriate environment. It is recommended to use AVR (Automatic Voltage Regulator) for a stable power supply. It is recommended to coil the core-ferrite around the connector of the system to avoid electromagnetic interference.
- The outlet must be placed on the ground.
- If there is strange sound or smell, unplug the power cable immediately and contact the service center.
 - This may cause fire or electric shock.
- In order to maintain stable system performance, have your system checked regularly by the service center.
 - LG Electronics is not held responsible for system breakdown caused by user mishandling.
 - There is a risk of explosion if a battery is replaced by an incorrect type. Dispose of used batteries according to the instructions.
- Do not overturn the product during use.

Contents

1 Safety Information

- 3 IMPORTANT SAFETY INSTRUCTIONS

2 Preparation

- 8 Introduction
- 8 Features
- 8 Accessories
- 9 Front Panel
- 11 Rear Panel
- 12 Remote Control

3 Installation

- 13 Connections
- 13 Precautions
- 13 Basic Connection Overview
- 14 Connecting Camera
- 14 Connecting Display device
- 14 Connecting Audio device
- 15 Connecting USB device
- 15 Connecting ATM/POS
- 16 Connecting Network
- 16 Connecting RS-485 device
- 17 Connecting Alarm Input and Alarm Output
- 18 HDD INSTALLATION
- 18 Note for Hard Disk Drive
- 18 Installing the Hard Disk Drive
- 19 Replacing the Hard Disk Drive
- 19 Recommended HDD
- 19 System Operation
- 19 System Shutdown
- 20 General Explanation of the Live Screen on the Main Monitor
- 20 Main Monitor Screen
- 21 Selecting the Main Monitor screen mode
- 22 Selecting the Spot Monitor screen mode
- 22 PTZ Camera Control
- 24 Viewing System Information
- 24 Viewing the System Log List

- 26 Configuration menu
- 27 System settings
- 27 Properties
- 27 Network
- 28 Network Streaming
- 28 DDNS
- 28 Date/Time
- 29 NTP
- 29 Controller
- 29 Update
- 30 Backup
- 31 Device settings
- 31 Camera
- 31 PTZ
- 32 IP Camera
- 32 ATM/POS
- 33 Storage
- 33 Display settings
- 33 OSD
- 33 Sequence
- 34 Channel Composition
- 34 Video Adjustment
- 34 Record settings
- 34 Schedule
- 34 To Set the Recording Schedule for a Typical Day of the Week
- 36 Copying the Recording Schedule
- 36 Normal
- 36 Sensor
- 37 Motion
- 37 Text
- 37 Instant/Panic
- 38 IP camera
- 38 Event settings
- 38 Sensor
- 38 Motion
- 39 ATM/POS Data Format
- 39 Event Popup
- 39 Notification
- 40 Mail
- 40 Emergency
- 40 Output
- 41 Buzzer
- 41 User settings
- 41 Group Authority

4 Operation

- 43 Instant Recording

43	Panic Recording	78	Recording Time Table (250GB HDD)
44	Instant Playback	81	Specifications
44	Search and Playback		
44	Date and Time Search		
44	Event Search		
45	Bookmark Search		
45	ATM/POS Search		
46	Export Search		
47	Functions Available During Playback		

5

LG Network Client Program

48	Introduction
48	Recommended PC Requirements
48	Before install the program
48	Getting Started
48	Install the LG Network Client on your PC
48	Starting the LG Network Client
49	LG Network Client Overview
51	Operation and settings
51	Register the Site Name or Group Name
51	Connect to the DVR
51	Connect the group device
52	Disconnect the site name or group name
52	Using the Live function
55	Using the Search function
56	Using the Remote Setup function
61	Using the Export function
62	Using the E-Map function
63	Additional Programs
63	Emergency Agent Program
64	Export Viewer Program
65	Web Viewer Program

6

Troubleshooting

7

Appendix

69	Recommended Devices
69	Recommended USB Memory list
69	Recommended External Device list
69	Recommended CD/DVD Media list
70	Supported function list for device
70	Supported PTZ Camera list
71	Time zones
72	Factory Default Configuration Settings

2 Preparation

Introduction

Model LE5016D (16 Channel) is used for the description, operation and details provided in this operating guide.

Features

- Stable embedded Linux operating system.
- Journal filing system for HDD file recovery following power recovery.
- Small file sizes with H.264 compression.
- Internal storage expandable to 4TB. (Expandable if new high capacity HDD is launched)
- NTSC and PAL selectable video format.
- Full real-time recording.

NTSC	Up to 480 IPS @ 704x480, LE5016 Series Up to 240 IPS @ 704x480, LE5008 Series Up to 480 IPS @ 352x240, LE4016 Series Up to 240 IPS @ 352x240, LE4008 Series
PAL	Up to 400 IPS @ 704x576, LE5016 Series Up to 200 IPS @ 704x576, LE5008 Series Up to 400 IPS @ 352x288, LE4016 Series Up to 200 IPS @ 352x288, LE4008 Series





- Various recording resolutions and quality levels.

NTSC	D1(704x480), Half D1(704x240), CIF(352x240)
PAL	D1(704x576), Half D1(704x288), CIF(352x288)

- 5 step quality level (Highest, High, Standard, Low, Lowest).
- Easy operation using various user interface & user friendly GUI.
 - Optical mouse, Full function IR remote controller
- Powerful multiplex function.
 - Simultaneous live display, recording, playback, network transmission, back-up.
- Various search function.
 - Date/time search (calendar search), event search, bookmark search.
- Event data protection by event partition recording.
- Pre-alarm recording (Up to 1 minute).
- Motion event recording and preview test function of motion sensitivity.
- Recording image rate & quality adjustment per individual camera.
- Powerful record scheduling.
- Instant playback in live mode.
- Perfect audio/video synchronization.

- Automatic backup by schedule.
- Image authentication (Watermark).
- Three USB 2.0 ports for backup interface.
- Setup configuration export/import with USB memory stick.
- Easy system S/W update with USB memory stick.
- Clients S/W can manage max 100 DVR servers.
- Max five clients can access one DVR server simultaneously.
- Network bandwidth throttle.
 - Automatically adjust a bandwidth according to network speed status of unit.
- Remote alarm notification via client software or E-mail.
- Time and date sync from NTP server.
- Daylight saving mode.
- Covert camera protection.
- Support Gigabit Ethernet.
- E-SATA storage interface.
- Two-way audio.
- Text Input for ATM and POS device.
- User management (User level control).
- PTZ Control.
 - Dome camera telemetry control (Dome OSD control).

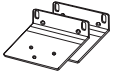
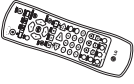
Accessories

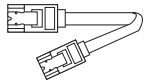
Software Install CD		Screws	
Mouse		Rack Mount Bracket	
Remote Control		Power Plug	
AAA type batteries		SATA cable(s)	

Front Panel

Front of the LE5016/LE4016 series

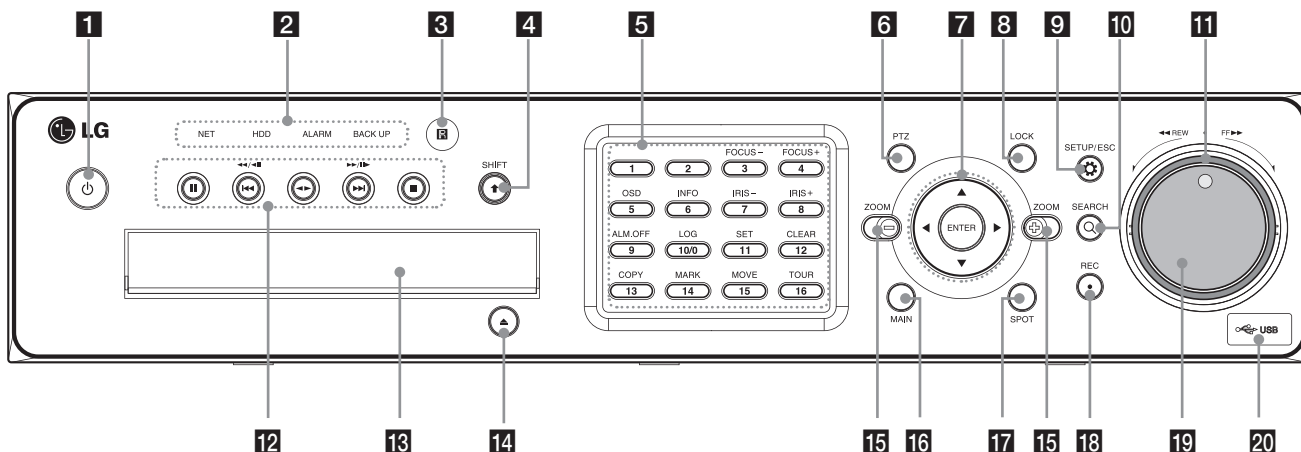

Front of the LE5008/LE4008 series

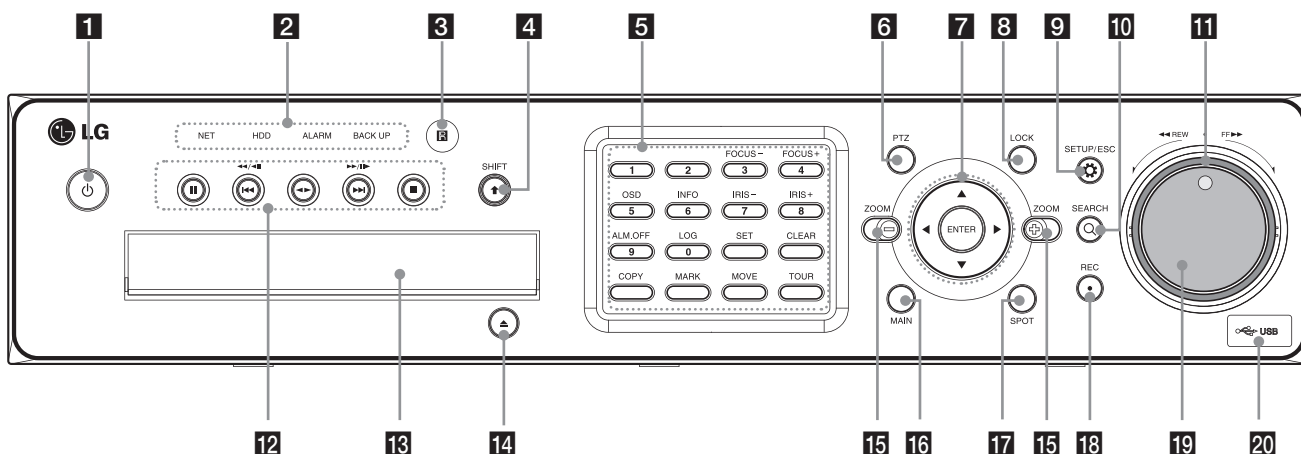

- 1** (Power): Turns DVR on or off. Press and hold for more than 2 seconds to turn on or off.
- 2** Indicator
 - NET: Lights when the network is connected.
 - HDD: Blinks when the HDD is accessed.
 - ALARM: Lights when the alarm out is in progress.
 - BACK UP: Lights when the data back up is in progress.
- 3** Remote Sensor: Point the remote control here.
- 4** SHIFT button: If you use the Sub-function of the channel button, the button is activated.
- 5** Channel Buttons: You can input a number with channel buttons. You can also use the channel buttons for sub-function with SHIFT button (11 to 16 buttons of 8 channel DVR are used for sub-function without SHIFT button.).
 - The LED in the button indicates the status as follows:
 - Off: The current status is for live mode.
 - Red: Recording mode.
 - Blinks when an event occurs.

- Sub-functions

Button number	Function	Description
3/4	FOCUS - / FOCUS +	Adjusts focus position.
5	OSD	Accesses or removes the System Control Bar (OSD).
6	INFO	Displays or removes system information.
7/8	IRIS - / IRIS +	Adjust iris position.
9	ALM.OFF	Cancels alarm activation and returns the system to the condition before the alarm was activated.
10/0	LOG	Displays or removes the System Log List.
11	SET	Registers the PTZ camera's preset position.
12	CLEAR	Deletes a memorized preset position.
13	COPY	Copies the recording data to an external device.
14	MARK	Sets the mark point for recording search.
15	MOVE	Moves the camera to the preset position.
16	TOUR	Tours all registered preset positions in the camera.

6 PTZ: Switches this unit to PTZ mode to control the PTZ camera connected.

7 Arrow Buttons

- ◀▶▲▼: Select or move between the menu options.
- ENTER: Confirms menu selections.

8 LOCK: Displays the lock menu to change the user type or disable the system operation.

9 SETUP/ESC: Displays the setup menu or cancels operation on the setup menus.

10 SEARCH: Displays the search menu.

11 Shuttle Ring: Fast forward or reverse picture search when the dial is rotated.

12 Playback Control Buttons

- ■■: Pauses playback.
- ◀◀, ◀◀/◀■: Searches the recorded images in reverse or skips the recorded images.
- ◀▶: Playback or reverse playback of recorded images.
- ▶▶, ▶▶/■▶: Forward searches the recorded images or skips the recorded images.
- ■: Stops playback.

13 Disc Tray: Insert a disc here.

14 OPEN: Opens or closes the disc tray.

15 ZOOM + / -: Zooms in/out on playback window.

16 MAIN: Displays or removes the screen setup menu for MAIN monitor.

17 SPOT: Displays or removes the screen setup menu for SPOT monitor.

18 REC: Starts or stops instant recording.

19 JOG Dial: Allows a forward or reverse frame search. In pause mode, plays recorded images frame by frame through rotation. Increases or decreases the options value.

20 USB Port: Connects an external USB device for backup or playback.

Rear Panel

Rear of the LE5016/LE4016 series

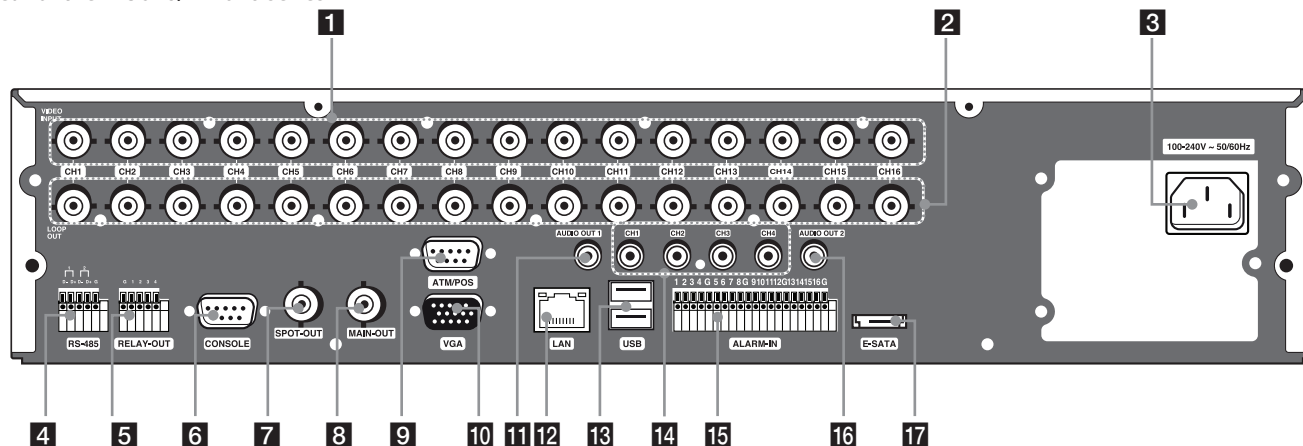

Rear of the LE5008/LE4008 series

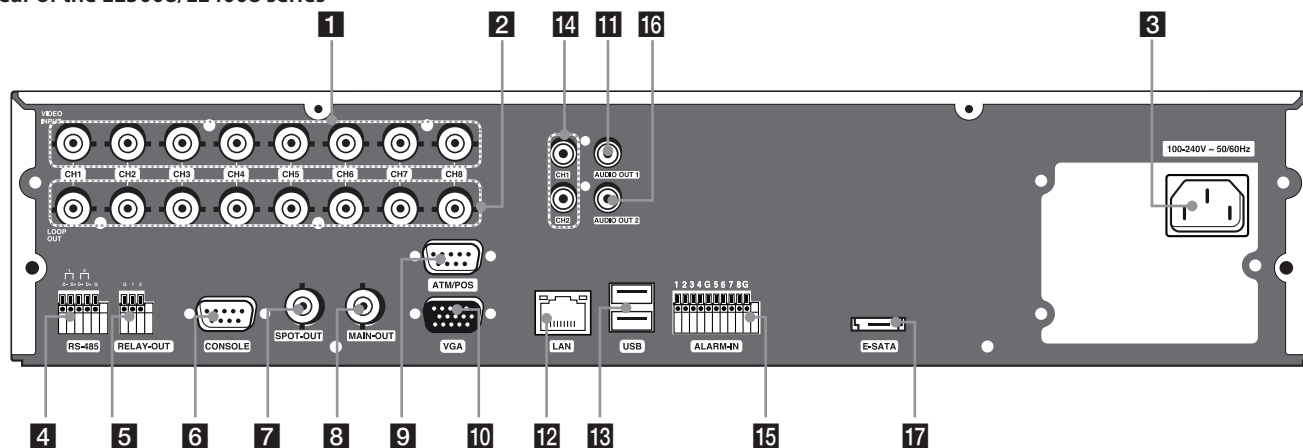

- 1** VIDEO INPUT: Connect the camera's video output to these BNC connectors.
- 2** LOOP OUT: The signal from VIDEO INPUT connector is looped out to this connector.
- 3** Power Cord Inlet (AC IN): Connect the power plug.
- 4** RS-485 Terminals: Connect RS-485 compatible cameras.
- 5** RELAY-OUT Terminals: Output terminals for alarm (relay) signal.
- 6** CONSOLE: Used to connect to a host device equipped with RS-232C connector (such as a personal computer).
- 7** SPOT-OUT (BNC Type Connector): Connect to spot monitor or display device.
- 8** MAIN-OUT (BNC Type Connector): Connect to main monitor or display device.
- 9** ATM/POS: Used to connect to a ATM/POS device.
- 10** VGA: Connect a VGA monitor.
- 11** AUDIO OUT 1: Connect to an active speaker with a built-in amplifier.
- 12** LAN Port: Connect the ethernet 10/100/1000 Mbps network cable for controlling this unit via a PC network.
- 13** USB Ports: Connect an optional extension USB device.
- 14** AUDIO INPUT: Connect the audio output of an external device.
- 15** ALARM-IN Terminals: Input terminals for alarm (relay) signal.
- 16** AUDIO OUT 2: Connect to an active speaker with a built-in amplifier. Two-way audio output.
- 17** E-SATA: Connect the external SATA device.

Remote Control

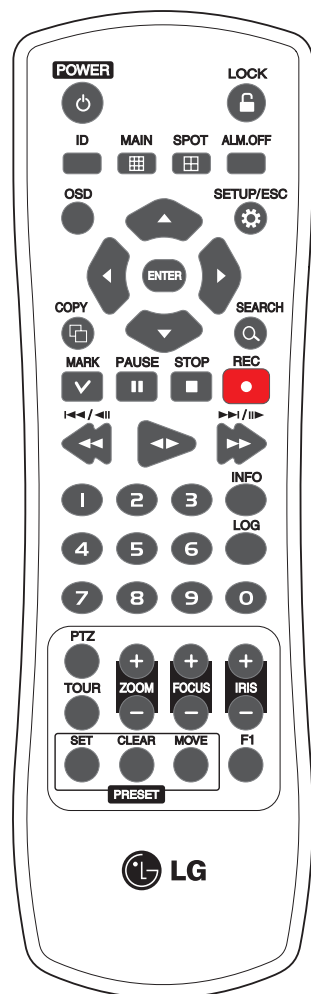

Button	Description
POWER (⏻)	Turns DVR on or off.
LOCK	Displays the lock menu to change user type or disable system operation.
ID	Set the appropriate DVR system ID to operate via the IR Remote Controller when using the multiple DVR. Press the ID button then press the number button within 2 seconds to select the system ID of the DVR. If you set the system ID to "0", you can control multiple DVR at the same time.
MAIN	Displays or removes the screen setup menu for MAIN monitor.
SPOT	Displays or removes the screen setup menu for SPOT monitor.
ALM.OFF	Cancels alarm activation and returns the system to the condition before the alarm was activated.
OSD	Accesses or removes the system control bar.
SETUP/ESC	Displays the setup menu or cancels operation of the setup menu.
◀▶▲▼	Selects or moves between the menu options.
ENTER	Confirms menu selections.
COPY	Copies the recording data to an external device.
SEARCH	Displays the search menu.
MARK	Sets the mark point for recording search. You can set the mark point during the single or multi channel playback of recorded data.
PAUSE (⏸)	Pauses playback.
STOP (■)	Stops playback.
REC (●)	Starts or stops recording.
◀◀, ◀◀/◀◀	Searches the recorded images in reverse or skips the recorded images.
◀◀	Playback or reverse playback of recorded images.
▶▶, ▶▶/▶▶	Forward searches the recorded images or skips the recorded images.
Number Buttons	To select the PTZ preset number, ID, or channel.
INFO	Displays or removes the system information window.
LOG	Displays or removes the System Log List window.
PTZ	Switches this unit to PTZ mode to control the connected PTZ camera.
TOUR	Tours all registered preset positions in the camera.
ZOOM + / -	Zooms in/out on the playback window.
FOCUS + / -	Adjusts the focus of a camera.
IRIS + / -	Adjusts the iris of a camera.
SET	Registers the PTZ camera's preset positions.
CLEAR	Deletes a memorized preset position.
MOVE	Moves the camera to the preset position.
F1	This button is not available.

3 Installation

Connections

Precautions

- Depending on the camera and other equipment there are various ways to connect the unit. Please refer to the camera manual or manuals for other devices as necessary for additional connection information.
- Be sure to switch off the camera before installation and connection.

Basic Connection Overview

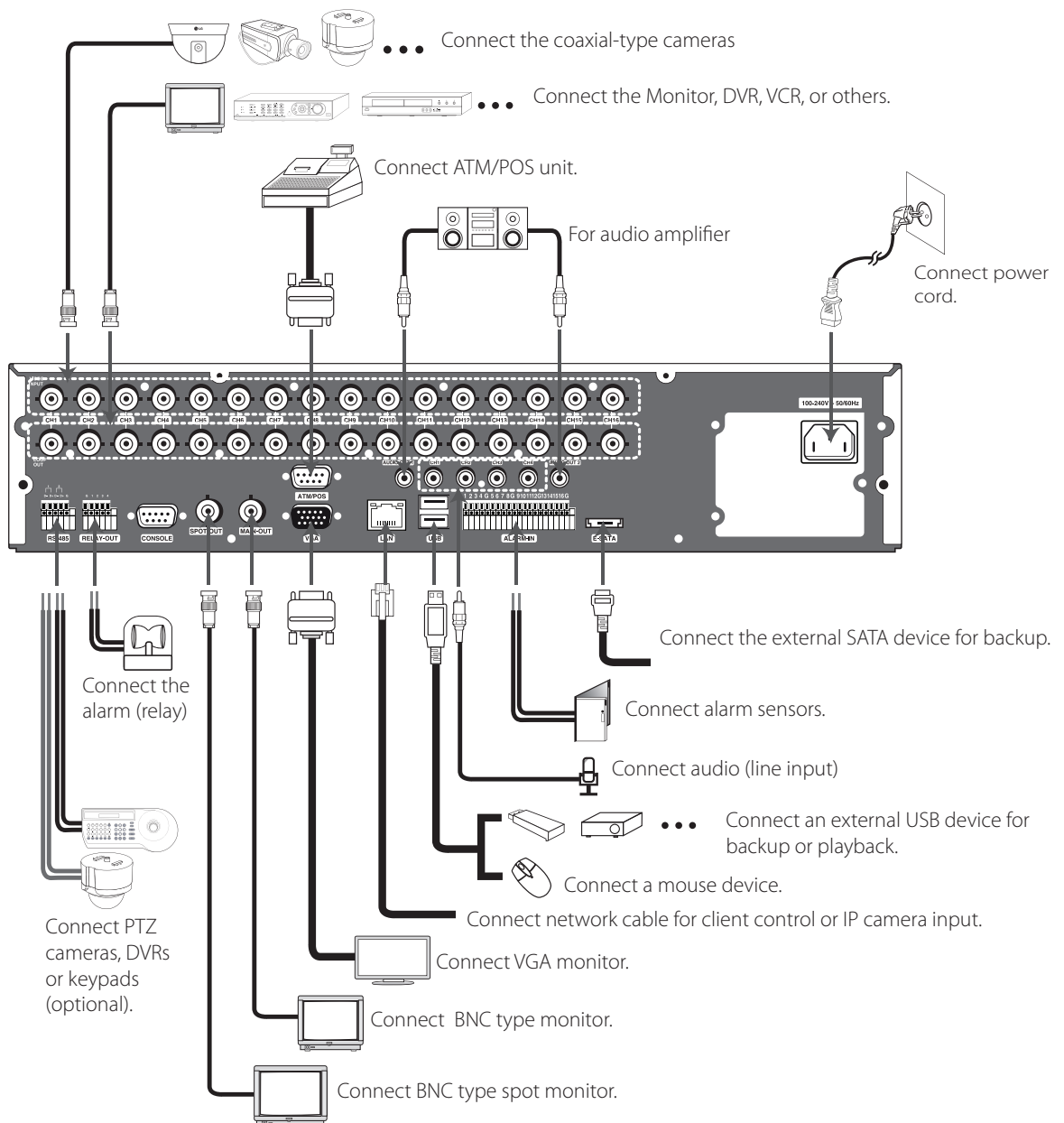

Connecting Camera

Connect the video output of your camera to the unit, using a standard 75 Ω video coaxial cable with BNC connector.

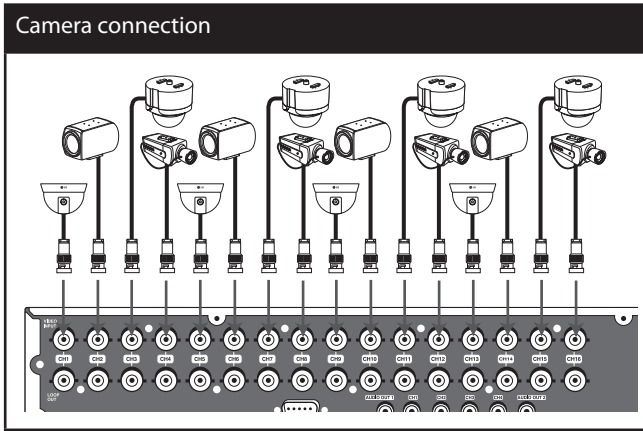

Connecting Display device

This unit can be outputted simultaneously from the VGA and MAIN OUT jack. The video signal connection between the DVR and the monitor.

CCTV(Composite Video Type) Monitor connection

Connect the unit to the CCTV monitor via 75 Ω video coaxial cables with BNC connector.

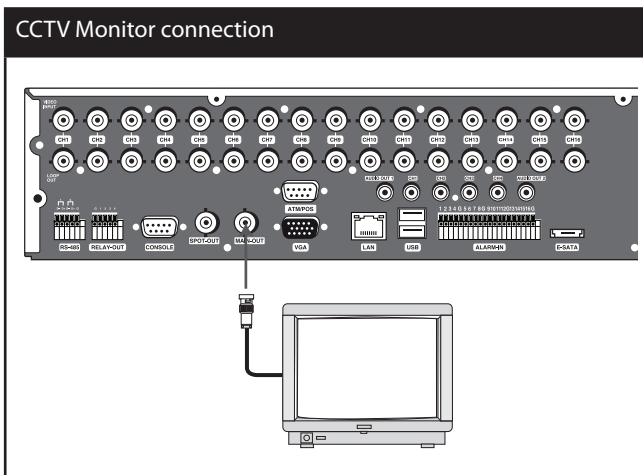

VGA Monitor connection

Connect the VGA jacks on the rear of the unit to the corresponding input jacks on the TV or monitor using the VGA cable.

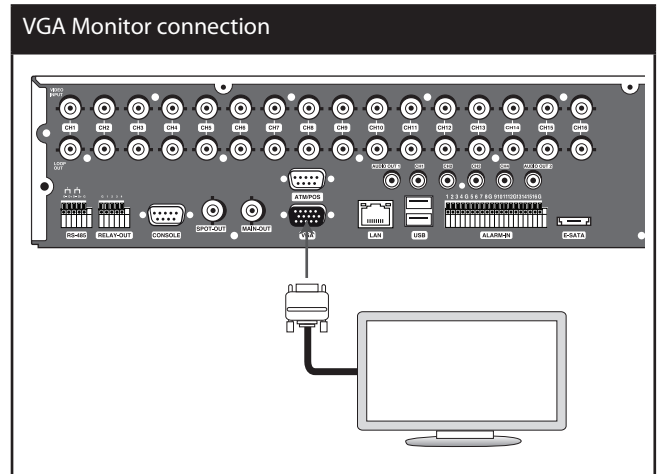

SPOT Monitor connection

Connect the unit to the SPOT monitor via 75 Ω video coaxial cables with BNC connector.

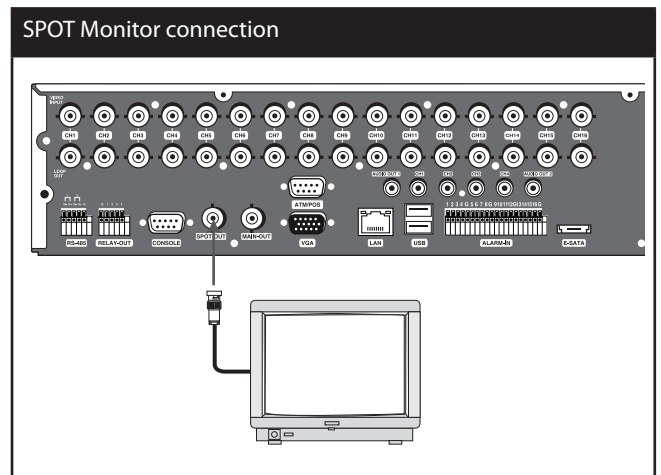

Connecting Audio device

Connect the AUDIO OUT jacks on the unit to the mono audio in jacks on your audio device.

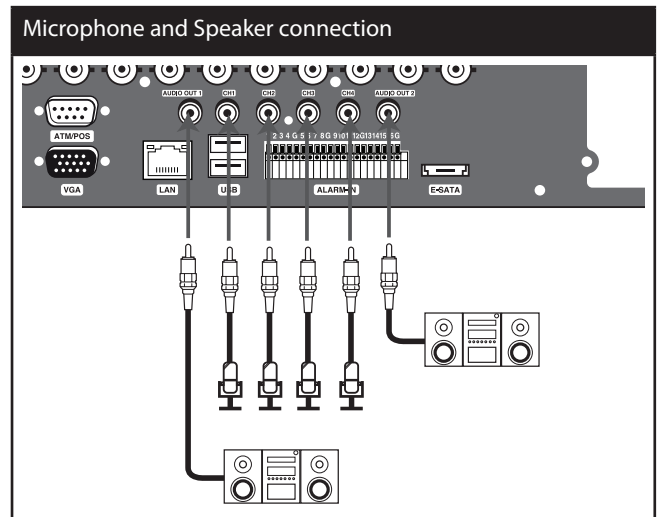

Connecting USB device

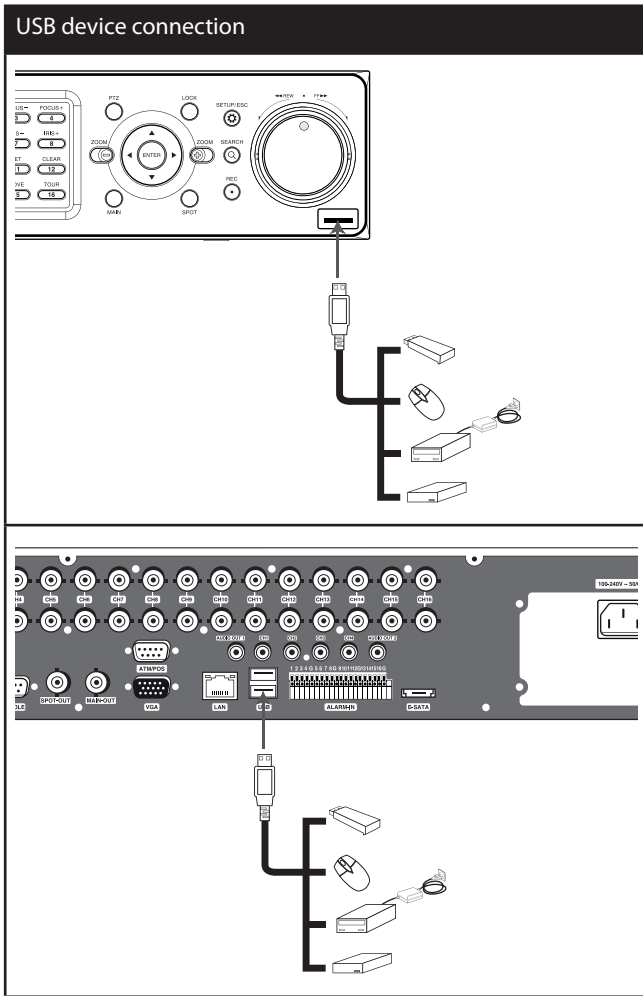

USB Memory device

Insert the memory device into the USB port. The system automatically recognizes the device. Using a USB memory device the system software can be easily upgraded.

USB External device

Connect the external device to the USB port. (Example: External HDD or other external storage).

Mouse

Connect the mouse for function control of the unit.

Connecting ATM/POS

Connect the ATM/POS unit to the ATM/POS port.

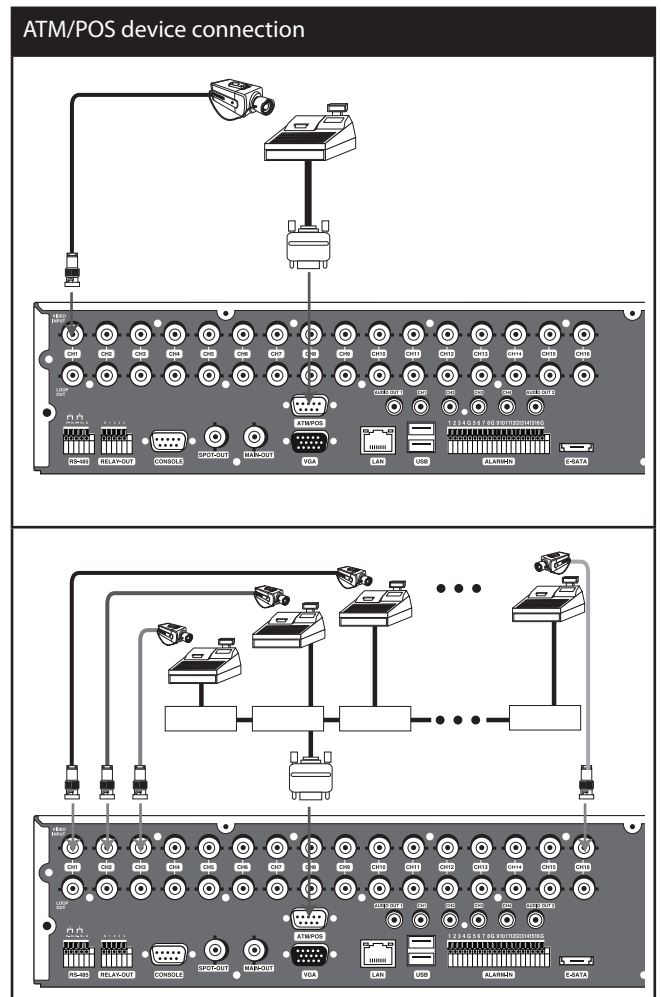

NOTE

- The following device has been tested and compatibility is ensured. When you use the multiple ATM/POS device use the recommended device.
 - AVE Products
 - > VSI-PRO: Video serial interface
 - > Regcom: RS-485 networker
 - > Hydra: RS-485 to RS-232 converter
- The installation and connection work should be done by qualified service personnel or system installers and should conform to all local codes.

Connecting Network

You can control and monitor the system via network. With the remote control (monitoring), you can change the system configuration or monitors the image via network. After the installation, check the network settings for the remote control and monitoring work.

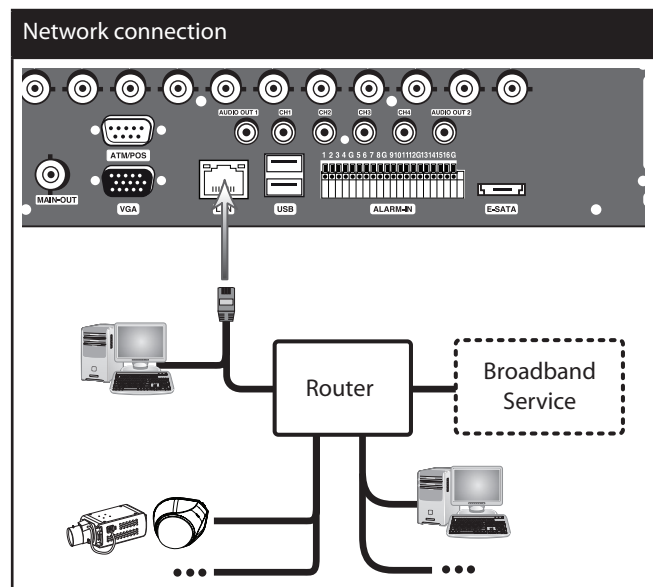

LAN connection

Connect the LAN port to an available 10/100/1000 base-T port with a straight ethernet cable (not supplied). The NET indicator on the front panel will be lit.

IP Camera connection

Connect the IP camera. After the installation, check the IP camera settings on the setup menu.

Automatic network configuration

The DVR can automatically obtain and configure the network interface via DHCP.

Manually configure network

The DVR may be manually configured by assigning an IP address, subnet mask, gateway and DNS.

Connecting RS-485 device

This DVR has two data terminals. Use this port to connect PTZ cameras, DVRs or keypads (optional).

RS-485 Terminal	Description
D - (DATA -)	Data Transmission/Reception
D + (DATA +)	Data Transmission/Reception
GND	Shield

Connecting the PTZ device

Connecting the PTZ serial communication lines to the RS-485 terminal.

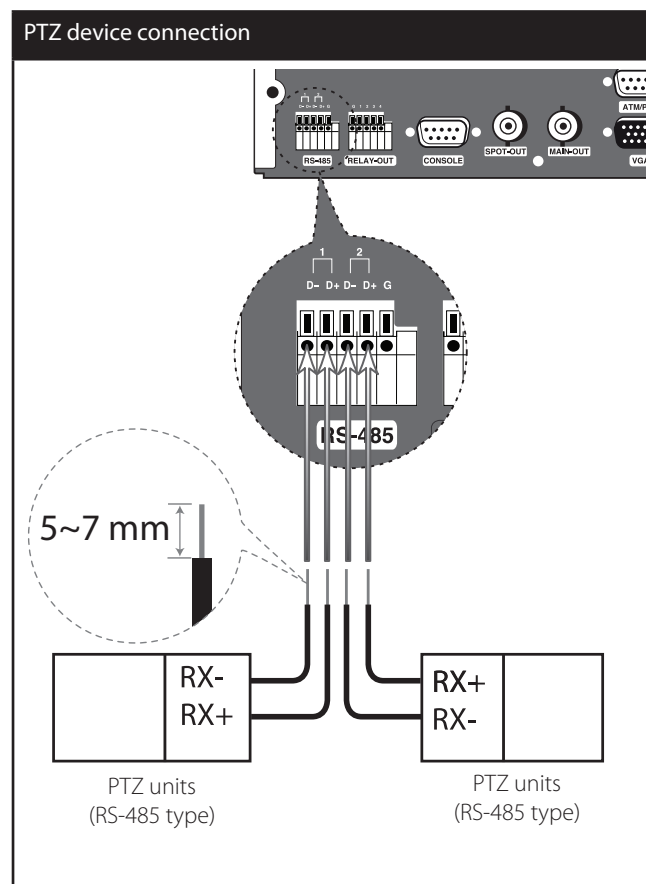

NOTE

- When connecting lines, connect the "D -" of the DVR to "RX -" of the PTZ unit and "D +" of the DVR to "RX +" of the PTZ unit correctly.
- Recommended initial data are 9600 Baud Rate, 8 Data bits, 1 Stop bit and No parity.
- When connecting PTZ cameras to DVRs it is necessary to set the setup menu for this unit according to the RS-485 settings of the camera and DVRs.

Connecting LKD1000 controller

Connecting the LKD1000 controller to control the DVR. (Refer to the manuals of the LKD1000 controller for more details.) The LKD1000 controller have to be connected to the 2 (DATA 2) port as shown illustration. If you connect the LKD1000 controller to the 1 (DATA 1) port, the LKD1000 controller will not be activated.

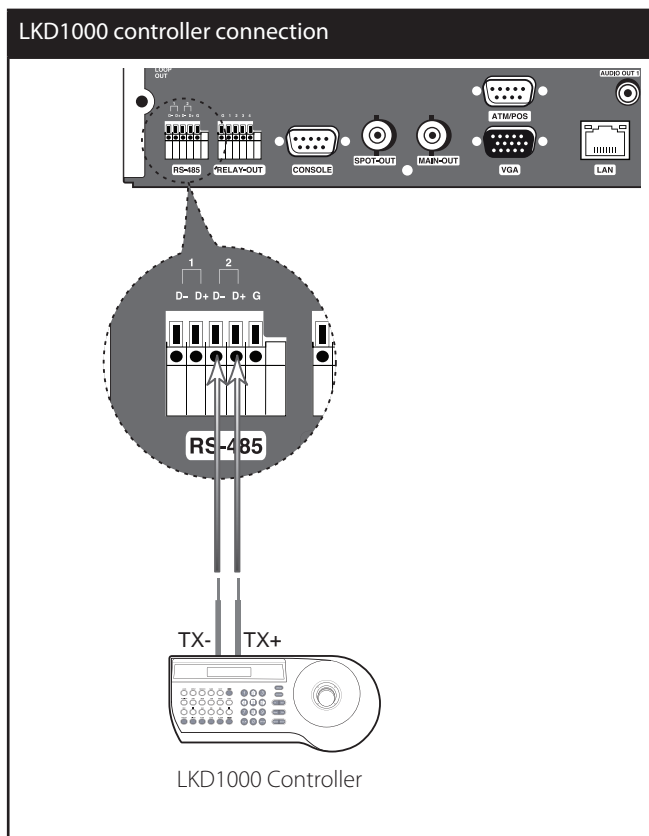

NOTE
Do not connect a PTZ camera and LKD1000 controller at the same time to the D1 or D2 port. It may cause a malfunction.

Connecting Alarm Input and Alarm Output

Alarm terminals are used to connect the alarm devices such as sensors, door switches, etc.

Alarm Input

You can connect up to 16 alarm sensors (LE5008/LE4008: 8 alarm sensors). Each alarm sensor should be connected with G (GND). The signal state is adjustable to N/O (Normal Open) or N/C (Normal Close) through the setup menu.

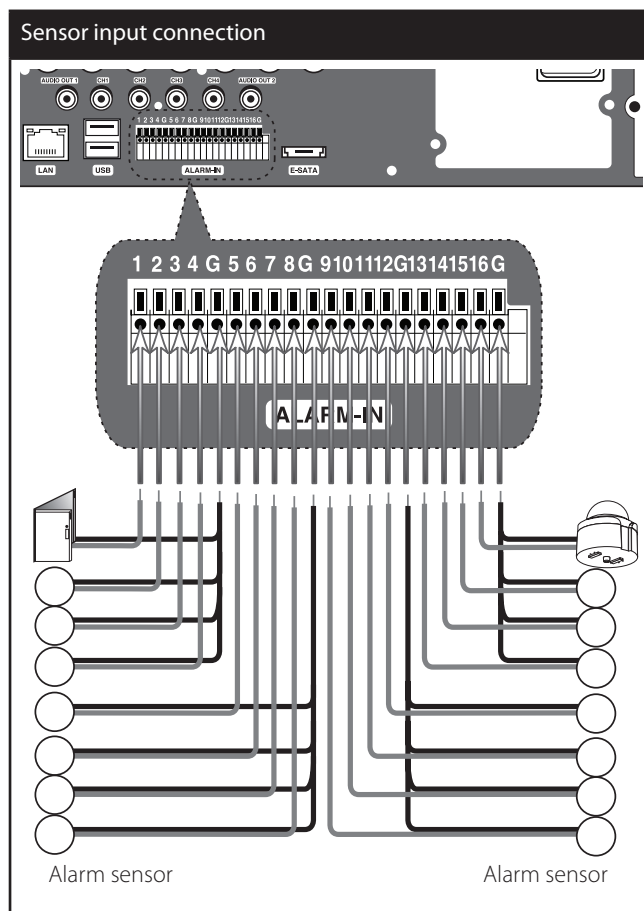

Terminal No.	Description
1	Sensor Input 1
2	Sensor Input 2
3	Sensor Input 3
4	Sensor Input 4
G	Ground
5	Sensor Input 5
6	Sensor Input 6
7	Sensor Input 7
8	Sensor Input 8
G	Ground
9	Sensor Input 9
10	Sensor Input 10
11	Sensor Input 11
12	Sensor Input 12
G	Ground
13	Sensor Input 13
14	Sensor Input 14
15	Sensor Input 15
16	Sensor Input 16
G	Ground

Alarm Output

Connect the alarm device to the alarm output. Alarm signal output at an event occurrence.

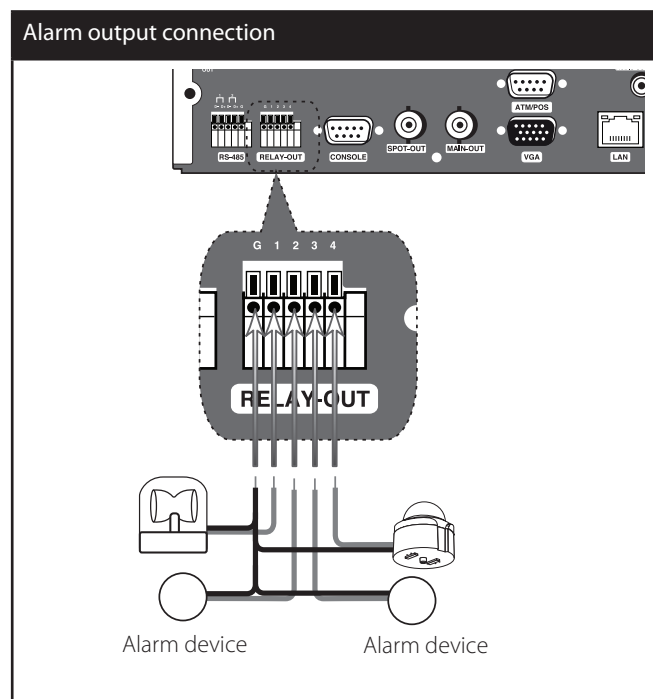

Terminal No.	Description
G	Ground
1	Alarm Output 1
2	Alarm Output 2
3	Alarm Output 3
4	Alarm Output 4

NOTE

The internal switching relays are rated for 0.3 A at 125 V AC or 1 A at 30 V DC. If the electric current is higher than that the unit can be damaged.

HDD INSTALLATION

Note for Hard Disk Drive

The internal hard disk drive (HDD) is a fragile piece of equipment. Please follow the guidelines below when using the DVR to protect against possible HDD failure. We recommend that you back up your important recordings onto an external backup device in order to prevent accidental loss.

Make sure that the power is turned OFF when attaching or removing the HDD.

- Do not move the DVR while the power is on.
- Do not use the DVR in excessively hot or humid places, or in places that may be subject to sudden changes in temperature. Sudden changes in temperature can cause condensation to form inside the DVR. This can be a cause of HDD failure.
- While the DVR is switched on, do not unplug from the wall socket or switch the electricity off from the breaker switch.
- If there's a power failure while the DVR is on, some data on the HDD may be lost.
- Do not drop the HDD. Also do not put the metallic object such as coins or screwdrivers into the HDD tray.
- When a power failure occurs during recording, avoid adding, replacing or transporting the HDD as the recorded data may be erased. In this case, turn the power back on to boot up the unit normally with the HDD that was being used at the time of the power failure attached. Then add, replace, or transport the HDD.
- The HDD is very delicate. Handle the HDD with care and follow the precautions below because even a tiny shock may damage the internal components of the HDD.
 - Do not place the HDD on the desk or table directly. Put a thick cushion under the HDD because even a small shock may damage the internal components of the HDD.
 - Do not use an electric screwdriver. Vibrations and shocks caused by an electric screwdriver may damage the internal components of the HDD.
 - When replacing the HDD, do not knock the HDD with other components such as another HDD and the HDD tray.
 - Do not knock the HDD with tools such as a driver when replacing the HDD.
- Protect the hard disk drives from static electricity.

Installing the Hard Disk Drive

You can install up to 4 HDDs.

Improper installation or setup may disturb HDD recognition or normal product operation. So you should consult with an expert from the store where the product was purchased.

1. Detach the top case by sliding it after removing the screws.
2. Remove the screws and detach the hard disk mounting brackets from the unit.
3. Attach the HDD onto the hard disk mounting brackets with four screws.
4. Attach the hard disk mounting brackets with the screws.
5. Connect the HDD power cable to the HDD.
6. Connect the SATA cable to the HDD.

7. Connect the SATA cable to the SATA connector on the main board.
8. Assemble the top case.
9. Fix the screws.
10. When you turn the power of the unit on, the new HDD is detected and formatted automatically.

Replacing the Hard Disk Drive

Turn the power of the unit off and detach the power plug from the outlet.

1. Follow steps 1 to 2 described in "Installing the Hard Disk Drive".
2. Remove the connector from the HDD.
3. Remove the screws from the hard disk drive on the left/right side of the hard disk mounting bracket.
4. Remove the HDD from the hard disk mounting bracket.
5. Install the new HDD.
6. After replacing the hard disk drive, insert the power plug into the outlet and turn the power of the unit on. The new HDD is detected and formatted automatically.

! NOTE

- Make sure that each of the SATA cables is connected to the connector housing through its holes.
- Do not use an electric screwdriver to fix them.

Recommended HDD

The following HDD has been tested and compatibility is ensured. When you attach multiple HDDs use the recommended HDDs.

! NOTE

If you do not use the recommended HDD, the system may not be operated normally.

Maker	RPM	Capacity	Interface	Model No.
Seagate	7,200	250 GB	SATA	ST3250311SV
	7,200	500 GB	SATA	ST3500410SV
	5,400	1 TB	SATA	ST31000424CS
Hitachi	5,700	1 TB	SATA	HCS5C1010CLA382

System Operation

1. Turn on the unit. System booting will commence. The LG logo image will be displayed on the main monitor during the system booting.
2. When the booting is complete the live window will be displayed. Click the LOCK icon on the system control bar or press the LOCK button on the remote control to display the log-in window.
3. Select a user name by using the mouse or arrow and the ENTER button on the remote control or front panel. For the first time, you can select the ADMINISTRATOR user name only. You can register a new user with various access rights using the user setup menu.
4. Enter the password by using the virtual keyboard. (Note that the default administrator password is "000000".)
5. Press the LOCK button or click the [OK] icon. You can see the live screen and operate the system.

! NOTE

- This DVR is based on a VGA monitor using OSD. We recommend to using the VGA monitor with this unit. If you use a composite monitor, the OSD quality may be low to read it.
- If the DVR is turned off accidentally and then turned on again, the DVR may take a long time to be rebooted.

System Shutdown

1. First, you must stop playback and exit the setup menu. In playback, press STOP.
2. Press and hold  (POWER) button until the beep sounds and the logout window will be displayed.
3. Enter the password by using the virtual keyboard.
4. Press the LOCK button or click the [OK] icon. The system will shutdown.

General Explanation of the Live Screen on the Main Monitor

Main Monitor Screen

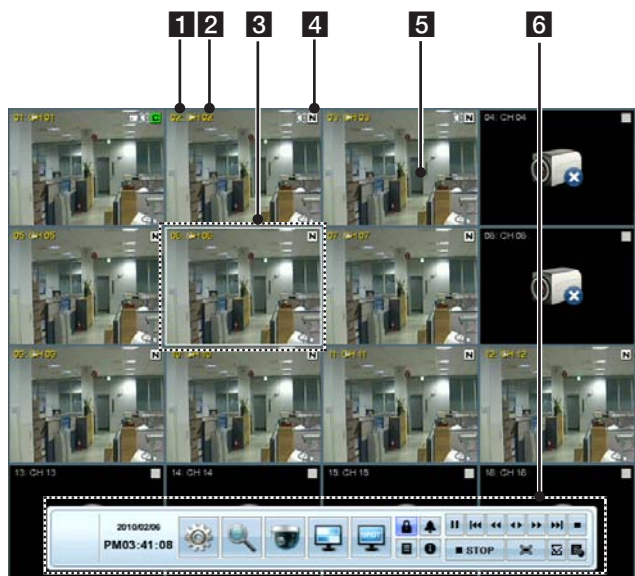

1 Channel Number

Displays the channel number.

2 Channel Name

Displays the edited channel name.

3 Selected Channel

Displays the selected channel with white box.

4 Camera Status Icon



	Displays the PTZ camera status.
	Displays the input audio status.
	Green "C" indicates continuous recording.
	Green "I" indicates Instant recording.
	Red "S" indicates sensor triggered recording.
	Blue "M" indicates motion detection recording.
	White "N" indicates the channel is not being recorded.
	Violet "T" indicates text event recording.

5 Live Screen

Displays the current surveillance live screen.

6 System Control Bar

	Displays the current date and time.
	Displays the setup menu.
	Displays the search menu.
	Displays the PTZ remote control window.
	Displays the screen division selection window for the main monitor.
	Displays the screen division selection window for the spot monitor.
	Displays the lock menu to change the user type or disable system operation.
	Turns the alarm off.
	Displays the system log list window.
	Displays the system information window.
	Pause playback.
	Jump to the beginning of the current data recorded on the same date.
	Select the required scanning speed.
	Starts instant playback in selected recording channel. If the recorded data is empty, a warning message is displayed.
	Jump to the last minute of the current data recorded on the same date.
	Stop playback.
	Display playback status.

	<p>You can capture and save the current image in JPEG file format. You should connect the external device to save the capture image.</p> <ol style="list-style-type: none"> 1. Playback the recorded data. 2. Pause the playback at a desired point during playback. 3. Click this button. The device selection window is displayed. 4. Select a device and click [OK]. 5. After saving the JPEG file, the confirmation window is displayed. Click [OK].
	<p>Click at a desired point to be marked during playback. Up to 15 points can be marked.</p>
	<p>Display copy (export) menu.</p>

NOTE

To display / remove the system control bar

Use OSD with the SHIFT button on the front panel or click the right mouse button in live screen mode and then the system control bar will be displayed or removed.

Selecting the Main Monitor screen mode

You can select the live screen mode to display a full, 4-split, 6-split, 8-split, 9-split or 16-split screens on the main monitor.

1. Press MAIN or click the  icon in the system control bar.
Screen mode select menu of main monitor is displayed on the main monitor.
2. Select screen mode.

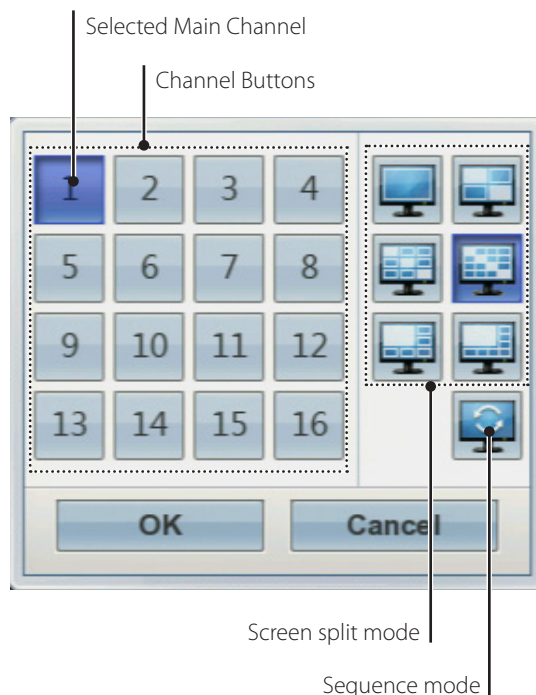

- Channel Number: Press the 1 to 16 channel button to see the current surveillance images in selected live screens on the main monitor.
 - Full Screen Mode: When you see the selected channel on the full screen.
 - 4, 9, 16, 1+5 and 1+7 Split Mode: Displays selected split screens on the main monitor.
 - Sequence: View all channels in sequence. You cannot use sequence mode with the 16 split (LE5008/LE4008 series: 8 split).
3. Select [OK] and press ENTER to confirm your selection.

NOTE

To display the screen you desire to watch in full screen mode, double click the desired channel.

Selecting the Spot Monitor screen mode

You can select the live screen mode to full or 4-split screens on the spot monitor.

1. Press SPOT or Click the  icon in the system control bar.
Screen mode select menu of spot monitor is displayed on the main monitor.
2. Select screen mode.

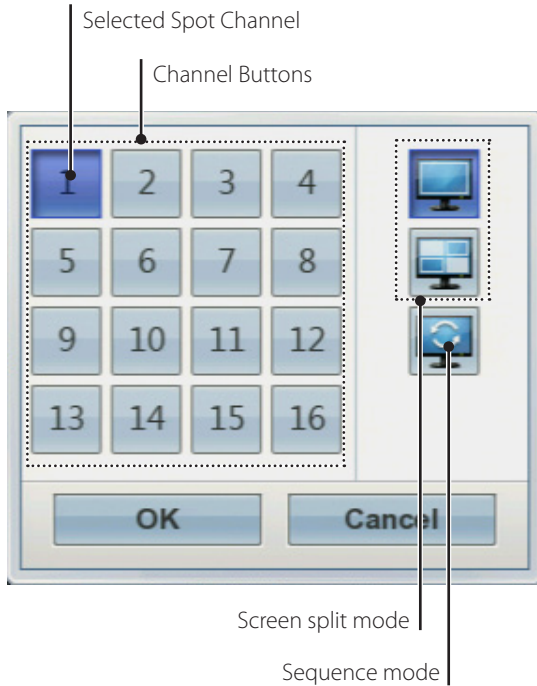















- Channel Number: Press the 1 to 16 channel button to see the current surveillance image on the spot monitor.
 - Full Screen Mode: When you see the selected channel on the full screen.
 - 4 Split Mode: Displays 4 split screens on the spot monitor.
 - Sequence: Views the all channels in sequence.
3. Select [OK] and press ENTER to confirm your selection.

PTZ Camera Control

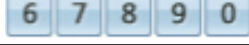
You can control the cameras connected via the data port of RS-485 terminal. You must set the configuration between the PTZ camera and the DVR.

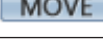
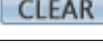
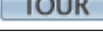
1. Select the PTZ camera channel on the main monitor you want to control.
2. Press PTZ or Click the  icon in the system control bar.
Virtual PTZ remote control is displayed on the main monitor.
3. Use each item to control the PTZ camera.

Button	Function
	Remove the PTZ virtual remote control.
	Use to pan/tilt the camera.
	Confirm the preset position.
SPEED 	Select the Pan/Tilt/Zoom speed.
 ZOOM 	To adjust the camera zoom.
 FOCUS 	To manually adjust the focus of a camera.
 IRIS 	To manually adjust the iris of a camera.
PRESET <input type="text"/>	Displays the Selected Preset number.
 	To input the preset number.
	To register preset positions.
	To move the camera to the preset position.
	To delete a memorized preset position.
	To start a preset tour.
	To displays the setup menu of the PTZ camera.







Preset Settings

Preset position is the function to register camera monitoring positions (preset positions) associated with position numbers. By entering the position numbers, you can move cameras to the preset positions.

NOTE

To activate this function, you need to register the preset positions of the PTZ cameras.

To Register Preset Positions



1. Move the camera to a point you wish by using the , , ,  buttons.
2. Press SET or click the  icon.
3. Select the preset number you wish to register.
4. Press ENTER or click the  icon.
The position and its number are memorized.
5. Repeat steps 1 to 4 to add additional positions.

! NOTE

Preset numbers from 0 to 255 are available on this unit but the actual preset range differs depending on PTZ cameras.



Changing to a Picture in a Preset Position

The following function is available only with cameras provided with the preset function. The preset function makes the combination camera move to the programmed preset position. It is necessary to program preset positions for the combination camera beforehand.

1. Press the MOVE button or click the  icon.
2. Use number buttons to enter the memorized preset position's index number then press ENTER or click the  icon. The camera moves to the preset position and the picture of the camera in that position appears on the monitor.

To Clear the Preset Position

You can clear a memorized preset position.



1. Press the CLEAR button or Click the  icon.
2. Use number buttons to enter the memorized preset index number then press ENTER or Click the  icon to clear the preset positions.

! NOTE

This function may not be available depending on PTZ cameras.













To Tour The Preset Positions

You can tour all preset positions.

1. Press the TOUR button or Click the  icon.
All registered preset positions in the camera will be selected and the camera position image will be switched on the active monitor.
2. You can stop the tour by pressing the TOUR button or clicking the  icon.

Setup for PTZ Cameras

You can adapt the camera to your requirements by setting up the respective items in menus.

1. Click the  icon.
The setup menu appears in the selected window of the main monitor.
2. Use , , , ,  ZOOM ,  FOCUS ,  IRIS , and  buttons to set the options.

! NOTE

- Refer to the manuals of the PTZ camera for more details.
- Some PTZ cameras may not operated correctly with this unit.
- You cannot control the other functions when the PTZ virtual remote control is displayed.

Viewing System Information

To view system information:

1. Press the INFO button or click the  icon in the system control bar. The system information window is displayed on the main monitor.

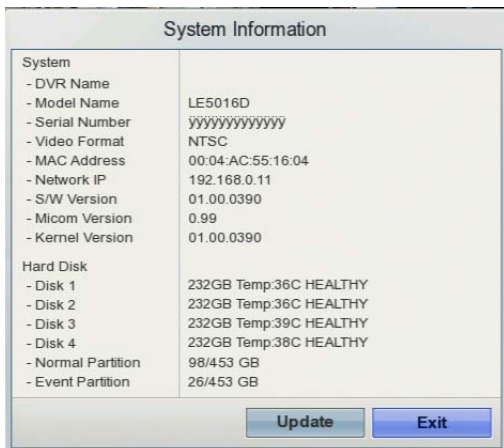

- Update: Press this button to update the system information.
2. Press the INFO button or click the [Exit] button to exit the window.

Viewing the System Log List

To view the system log list:

1. Press the LOG button or click the  icon in the system control bar. The system log list window is displayed on the main monitor.

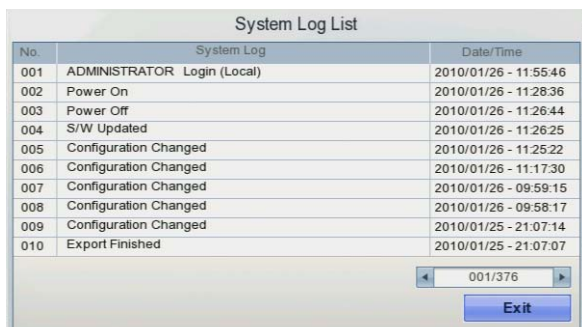

2. Use ◀ / ▶ to see the previous or next log list.
3. Press the LOG button or click the [Exit] button to exit the window.

NOTE

Refer to the following system log list.

No.	Log Message
1	Power On
2	Power Off
3	Admin Login (Remote)
4	Admin Logout (Remote)
5	Admin Login (Local)
6	Admin Logout (Local)
7	Configuration Changed
8	Configuration Imported
9	Factory Default Set
10	Power Recovery
11	Backup Started
12	Backup Finished
13	Backup Failed
14	Export Started
15	Export Finished
16	Export Failed
17	S/W Updated
18	System Fan Failure
19	HDD Damaged (HDD1)
20	HDD Damaged (HDD2)
21	HDD Damaged (HDD3)
22	HDD Damaged (HDD4)
23	HDD Added (HDD1)
24	HDD Added (HDD2)
25	HDD Added (HDD3)
26	HDD Added (HDD4)
27	HDD Removed (HDD1)
28	HDD Removed (HDD2)
29	HDD Removed (HDD3)
30	HDD Removed (HDD4)
31	HDD Formatted (HDD1)
32	HDD Formatted (HDD2)
33	HDD Formatted (HDD3)
34	HDD Formatted (HDD4)
35	HDD Changed (HDD1)
36	HDD Changed (HDD2)
37	HDD Changed (HDD3)
38	HDD Changed (HDD4)

Export the recorded data

This unit can manually copy recorded images and audio from built-in HDD to the external recording devices.

1. Press COPY or click the  icon in the system control bar. The export menu window appears.



2. Select [Target Device] then press ENTER.
3. Use ◀/▶ to select a target device to export.
4. Press ENTER to confirm it.
5. Select the channel number and press ENTER. Repeat this step to select multi channels.
6. Set the [Start Date/Time] and [End Date/Time] to copy.
 - ◀/▶/▲/▼: Moves to the options.
 - ◀/▶: Sets the selected option.
 - ENTER: Selects option or confirms the setting.
7. Press COPY or click the [Export] icon to start exporting. The exported data will be authorized by the unit before saving and it can only be played back with the exclusive player.

! NOTE

- Check the export device before you proceed.
- You can also use the COPY button on the front panel for export function.
- You can export the recorded data only in the live mode.
- If you use the external device, the external device has to be formatted on this unit.
 1. Connect the external device to the USB port on the front or the rear of the DVR.
 2. Select the [Format] icon then press ENTER. Confirm window is displayed after format is completed.
 3. Select [OK] and press ENTER to close the window.
- Check the size of the selected data and free space of the external device. If the device does not have enough space, create space on the device or erase the previously stored data.
- Export can not be executed while the backup is in progress.
- You can search the exported data with the supplied viewer software.
- When you export the recorded data, the audio data will also be exported.
- When you export the recorded data the export viewer program will also be exported in the [ExportViewer] folder of the device. The exported data file name is made automatically as the [Channel name_export date_export time.exp] type.
- Do not remove the USB device while the export is in progress, it may cause a malfunction.
- The warning message appears for the conditions listed below.
 - When the start date/time and end date/time are the same value.
 - When the start date/time is later than the end date/time.
 - The export media does not have enough space.
 - When you set the time for data that does not exist.
- An external media has to be formatted on this unit to prevent a malfunction.
- DVD+RW and DVD-RW discs have to be initialized before using.



Configuration menu

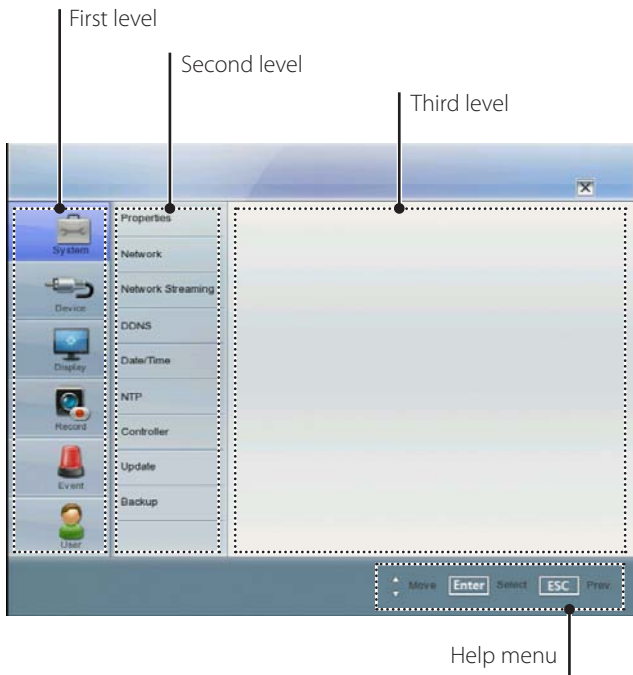

The features and options of the DVR are configured through the menu. The operations of this unit can be set via a menu displayed on the main monitor. You can select and set the operational conditions by using the buttons on the front panel and the remote control or using a Mouse connected to the unit. Only administrator-level users have permission to access the Setup menu and configure the DVR.



Using a mouse to set a menu







Use the left or right mouse buttons to set the menu.

Button	Function
 Left button	<ul style="list-style-type: none"> Use to select a required item or decrease the options value. If you double click the button, you can see the selected channel on the full screen.
 Right button	Use to increase the options value.

- Click the  icon on the System control bar with the left mouse button to display a setup menu.
- Click the desired option with the left mouse button to display the second or third level menu options.
- Click the desired option with the left mouse button.
- Set the selected options value.
- Click the  icon to exit setup menu.

If the save message appears, click [OK] with the left mouse button to save the settings.

Setting the Menu Using the Front Panel Buttons or Remote Control Buttons

Front Panel	Remote Control	Description
		Use these buttons to select the menu options or adjust the options value.
		Select the option or confirm the setting.
		Return to the previous menu or level.

- Press SETUP/ESC to display the setup menu.
- Use ▲ / ▼ to select the desired menu item, then press ENTER to display the submenu.
- Use ▲ / ▼ to select the desired submenu item, then press ENTER to display the setting options.
- Use ▲ / ▼ to select the desired option then press ENTER to set the value.
- Use ◀ / ▶ to select the desired setting then press ENTER to confirm your selection.
- Press SETUP/ESC repeatedly to exit the Setup menu. If the save message appears, select [OK] and press ENTER to save the settings.

NOTE

- When you operate the function menu by using the remote control and front panel buttons, both buttons are operated in the same way to control the function menu.
- To use other functions of number buttons on the front panel as shown below.
 - Press SHIFT. The button indicator turns red.
 - Select the function button you want.
- All the operation explanations are based on using the remote control.

System settings

Properties

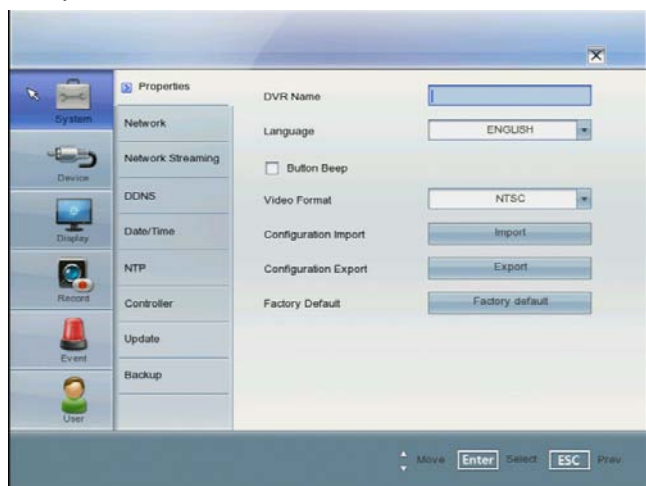

- DVR Name: Enter the DVR name using up to 20 characters.
- Language: Select a language for the setup menu and information display.
- Button Beep: Marks up to activate the button beep. The button beep is activated when using the buttons.
- Video format: Selects the video format to NTSC or PAL according to your video system format. If you change the video format, the HDD is formatted with selected video format. After the HDD has been formatted, the confirmation message is displayed. Select [OK] and press ENTER. The system will reboot.

! NOTE

All cameras must be disconnected before you change the video format to prevent malfunction.

- Configuration Import: Import the DVRs configuration data from the USB memory stick.
- Configuration Export: Export the configuration data from this DVR to the USB memory stick.
- Factory Default: You can reset the DVR to its original factory settings. Some options cannot be reset (date, time, daylight saving, time zone and user password settings).

Network



- DHCP: Select this option when a DHCP server is installed on the network to allow IP address assignment. With this setting, the IP address is assigned automatically.
- IP Address: Enter the IP address.
- Subnet Mask: Enter the subnet mask address.
- Gateway: Enter the gateway address.
- Primary DNS: Enter the Primary domain name server that translates the hostnames into IP address.
- Secondary DNS : Enter the Secondary DNS server address that backups the Primary DNS.
- TCP/IP Port: Enter the TCP/IP Port number. You can watch the live surveillance image over the network with the PC Client program. The factory default port for transmission of video and audio data is 9001. However in some cases it is better to change this port number for added flexibility or security. You can edit this port between 1 025 and 65 535.
- Web Server Port: Enter the Web Sever Port number. You can watch the live surveillance image over the network with a web browser. Typically the TCP port used by HTTP is 80. However in some cases it is better to change this port number for added flexibility or security. You can edit this port to 80 or between 1 025 and 65 535.
- Audio Port: Enter the Audio Port number. You can edit this port between 1 025 and 65 535.
- Bandwidth Throttle: Enter the Bandwidth to adjust the data traffic.

Network Streaming



- Ch: Displays the channel number.
- Resolution: Selects the recording resolution. Each group such as "Ch1 to Ch8" and "Ch9 to Ch16" are set the same resolution.
- Quality: Selects the recording picture quality.
- Frame Rate: Selects the frame rate. The frame rate is the number of transportable frames per second. According to resolution, the frame rate is set automatically. If you wish to set manually, refer to the below.

Resolution		Frame Rate
NTSC	352*240	1, 3, 5, 7.5, 10, 15
	704*240	1, 3, 5, 7.5
	704*480	1, 3
PAL	352*288	1, 3, 5, 6, 7.5, 12.5
	704*288	1, 3, 5, 6
	704*576	1, 3

DDNS

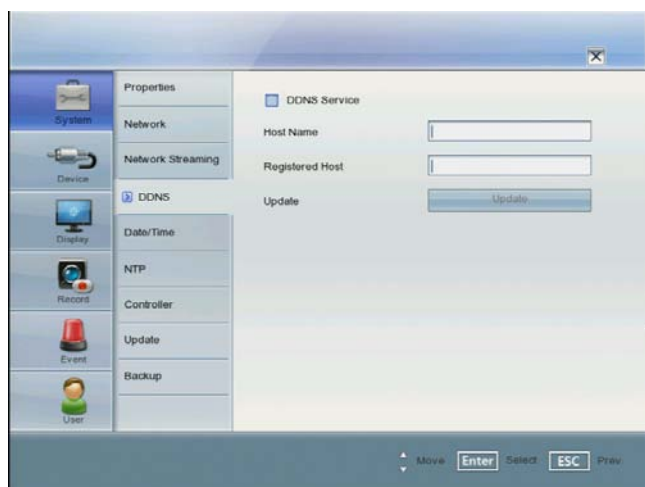

This free service is very useful when combined with the LG DDNS Server. It allows the user to connect the IP device using the URL, rather than an IP Address. This also solves the problem of having a dynamic IP address.

- DDNS Service: Marks up to activate the DDNS function.

- Host Name: Enter the host name you want to use. You can not use the "www", "mail", "http", "ftp", "com", "lg", "lge", "lgddns", "lgeddns", "ddns" for host name.
- Registered Host: The registered host name appears.
- Update: Register the host name you typed in [Host Name] to LG DDNS server.

How to register DDNS host name

With the DDNS function, you can easily use LG DVR.

When you use the DDNS function for the first time after you purchased LG DVR

1. Displays the DVR setup menu.
2. Select [System] > [DDNS] option.
3. Marks up for the [DDNS Service] option.
4. Enter the host name in the [Host Name] option.
5. Press the [Update] button. If host registration is properly completed, the host name will be displayed in the [Registered Host] option. If the host name is not registered after updating, please check network connection.

When you want to change DDNS host name

If you want to change the registered host name to new one, follow as shown below.

1. Enter a new host name in the [Host Name] option.
2. Press the [Update] button. The confirmation window will be displayed to change your host name.
3. Click the [OK] button. When host name is properly changed, the changed host name will be displayed in the [Registered Host] option. If host name is not changed after updating, please check network connection.

Date/Time



- Date: Select the current year, month and day.
- Time: Select the current time.
- Date Format: Select the date display format.
- Time Format: Select the time display format.
- Time Zone: Select the time zone in the area where the DVR is installed.
- Daylight Saving: Mark up when you use the daylight saving function.
- Daylight Saving Start: Select the Daylight Saving start time.
- Daylight Saving End: Select the Daylight Saving end time.

NTP

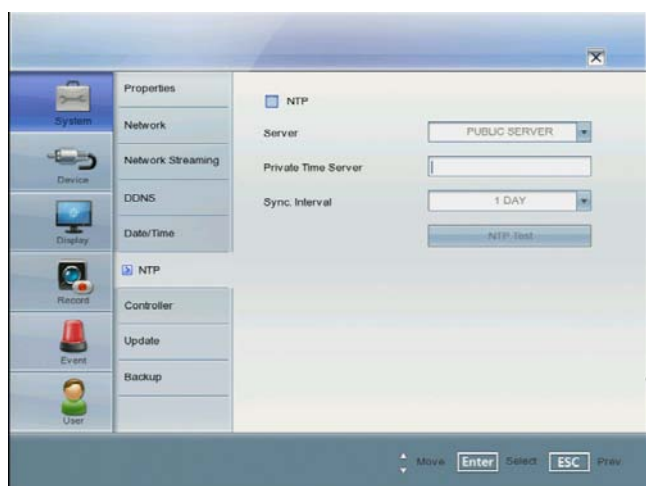

- NTP: Marks up, if you want to synchronize the DVR's date and time with those of the time server called NTP (Network Time Protocol) Specify the NTP server's name.
- Server: For most cases select public. The DVR will obtain the average time among 5 public servers (time.nist.gov, time-a.nist.gov, time-b.nist.gov, ntp.nasa.gov, clock.isc.org).
- Private Time Server: Enter the private time server's IP address or host name using the virtual keyboard.
- Sync. Interval: You can set synchronized intervals with the NTP time server to 1 day, 1 week, 1 month and 1 hour.
- NTP Test: Select [NTP Test] to test the NTP server.

NOTE

If the NTP option is not set to this system, there can be a gap between the system time and actual time. Using NTP is recommended.

Controller

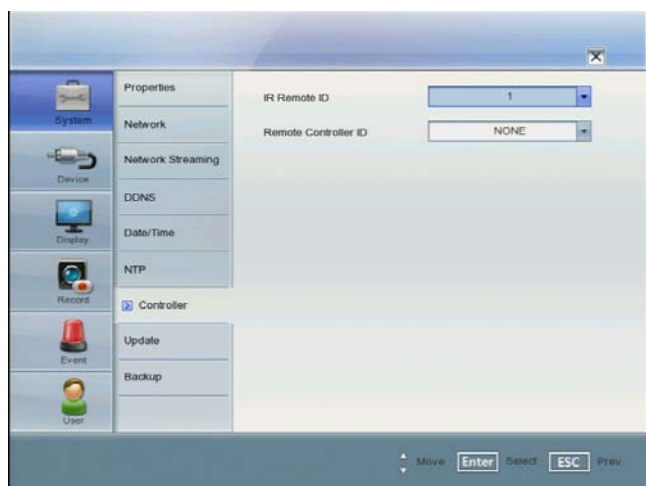

- IR Remote ID: Select the IR Remote ID for this unit. If you use multi systems set the IR Remote ID for each DVR unit.
- Remote Controller ID: Select the Remote Controller ID for this unit. If you use multi systems, set the Remote Controller ID for each DVR unit. You can control the DVR by using the LKD1000 controller. (For more details refer to the LKD1000 owner's manual).

Update

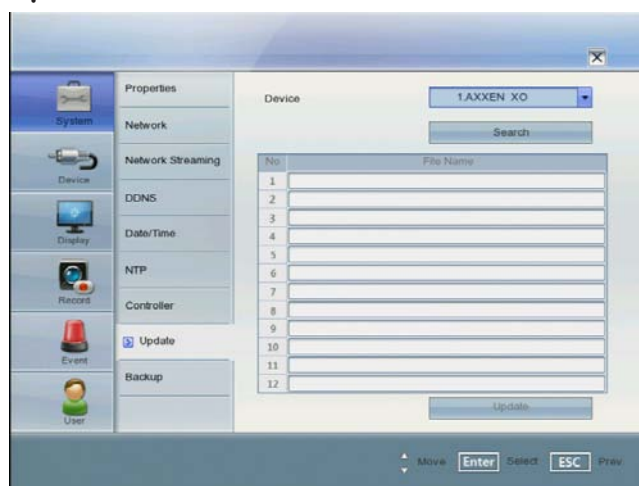

The update feature allows you to upgrade DVR software and add/upgrade PTZ protocols. In this case, the current DVR settings are not deleted or replaced during the update process.

1. Connect the device including update file.
2. Select the update device from the drop-down list.
3. Select the [Search] button and press ENTER. The update file is displayed in the list.
4. Choose the update file from the list.
5. Select the [Update] button and press ENTER. The confirmation window is displayed.
6. Select [OK] to begin the update process or click [Cancel] to stop and exit. After the update process is completed, the system displays the Restart the system dialog box.
7. Click [OK] to restart the DVR.

NOTE

- Do not turn the power off during the update process to prevent the malfunction.
- Do not remove the external device or CD/DVD disc for update whilst the update is in progress. It may cause a malfunction.

Backup



- Partition Selection: Select a backup partition.
- Schedule: You can set the backup schedule.
 - OFF: All options are disabled.
 - WEEKLY or DAILY: The backup data will be automatically saved according to the setting.
 - INSTANT: The backup data is saved manually.
- Device: Select a backup device.
- Schedule Start: Set the schedule start date (A day of the week and time).
- Time Range Date: Enter the backup time range. Enter the date you want to backup.
- Time Range Start: Enter the start day of the week or time.
- Time Range End: Enter the end day of the week or time.
- Estimate Size: Displays the size of backup data and the free space of external devices.
- Start Backup: To start backup.
- Erase Media: To erase the media.

Instant Backup

1. Connect the backup USB device or insert a recordable disk to the disc driver for backup.
2. Select the partition you want to backup.
3. Select INSTANT from the schedule options.
4. Select the backup device.
5. Select the Time Range Date, Time Range Start time, and Time Range End time for backup.
6. Select the [Estimate Size] icon and press ENTER.
7. Check the size of the selected data and free space. If the device does not have enough space, create space on the device or erase the previously stored data.
8. Select the [Start Backup] icon and press ENTER to start backup.
9. Exit the setup menu. You can check the backup status on the system control bar in backup progress.

Daily/Weekly backup

1. Connect the USB device for backup. You cannot use the CD or DVD writer for daily or weekly backup.
2. Select WEEKLY or DAILY on the schedule options.

3. Select the backup device.
4. Enter the date and/or time to start backup on the schedule start option.
5. Enter the day of week and/or time on the Time Range Start option.
6. Enter the day of week and/or time on the Time Range End option.
7. Select the [Estimation Size] icon and press ENTER.
8. Check the size of selected data and free space of USB device. If the USB device does not have enough space, change the USB device to a USB which has enough space or erase data of the connected USB device.

NOTE

- The backup function is not supported on the external USB CD-ROM driver.
- Available external device for backup.

Device	Capacity
USB HDD	Less than 1 TB.
E-SATA HDD	Unlimited.

- Use the recommended external USB devices for preventing malfunction (See page 69).
- The CD-R, DVD-R or DVD+R discs cannot be formatted.
- DVD+RW and DVD-RW discs have to be initialized before using.
- An external media has to be formatted on this unit to prevent malfunction.
- You cannot use the [Estimate size], [Start Backup] and [Erase Media] options in backup progressing.
- Do not remove the external device while the backup is in progress, it may cause a malfunction.
- If you format the external media by using a PC with FAT32, the media may not be used on this unit.
- Check the size of the selected data and free space of the external device. If the device does not have enough space, create space on the device or erase the previously stored data.
 1. Select the [Estimate Size] icon and press ENTER. The size of the selected data and free space is displayed.
 2. Select [OK] and press ENTER to close the window.
- You cannot stop the backup in backup progress.
- The warning message will appear for the conditions listed below.
 - When the start time and end time are the same value.
 - When the start time is later than the end time.
 - When you set the time for data that does not exist.
 - When the start time and end time setting are wrong.
 - A media does not have enough space.
 - When the selected USB device is disconnected.

NOTE

- The disc burning is carried out by a single session closed format.
- If you use the CD/DVD writer device for backup, it is making ISO image and then writing the backup data to the CD/DVD.
- You can see the backup progress status on the system control bar.
- The estimated size of backup data is only the approximate size. So you must prepare sufficient space on the media to prevent lack of space.
- At the scheduled recording time, you can check the backup status on the system control bar.
- While export is in progress or searching the backup data from the external USB device, the scheduled backup will not be started. After the export or backup search is finished, scheduled backup will be restarted.
- When you set the schedule backup, the backup data size is estimated from the recording settings of the Setup menu. If the real recorded data size is over the estimated recording data size, the schedule backup may not be activated.

Device settings

Camera



- Ch: Displays the channel number.
- Name: Enter the channel name using up to 20 characters.
- Audio: Select the input audio channel. You can hear from the selected input audio channel. This function is not available for IP channels.

PTZ

Settings for the PTZ cameras connected via the data port of the RS-485 terminal.



- Channel: Selects the desired channel to set the connected PTZ camera.
- Port: Selects the connected data port of the RS-485 terminal on the rear panel. The DATA 2 port is used to control the PTZ camera connected to DVR or to control by using the LKD1000 controller. If you want to use the PTZ camera via DATA 2 port, you should set the [Remote Controller ID] to [NONE]. If you use the LKD1000 controller to control the DVR via DATA 2 port, you should set the [Remote Controller ID] number between 1 to 16.
- Control ID: Selects the PTZ camera ID. Make the same settings as the PTZ camera.
- Protocol: Selects the protocol supported by PTZ camera.
- Baud Rate: Selects the communication speed.

- PTZ Test: After the PTZ setting, you can test the pan/tilt function for the selected PTZ camera. You can see the test screen from the preview windows on the right side of the PTZ test option.
 - ◀ / ▶: Test the pan direction.
 - ▲ / ▼: Test the tilt direction.

NOTE

The supported PTZ camera list is on page 70 for reference.

IP Camera

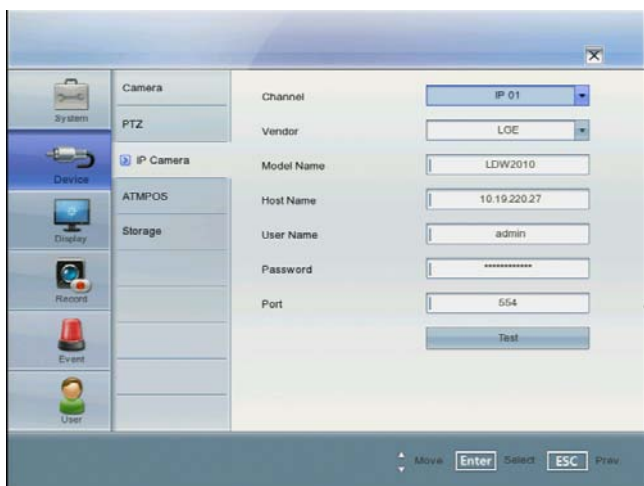

- Channel: Selects the desired channel to set the connected IP camera.
- Vendor: Selects the IP camera vendor from the drop-down list.
- Model Name: Enter the model name of the IP camera.
- Host Name: Enter the IP address of the IP camera.
- User Name: Enter the user ID.
- Password: Enter the user password.
- Port: Enter the port number.
- Test: Select [Test] to test the connection with the IP camera.

NOTE

The Supported IP camera specifications.

Specification	Description
Vendor	LG, AXIS
Recording mode	Continuous, Instant
Video Codec	H.264 Baseline Profile
Audio recording and playback	Not support
Resolution	CIF, Half D1(2CIF), D1(4CIF)
Stream	Master-0 only for LG camera
PTZ	Not support
Sensor/Motion input	Not support

ATM/POS

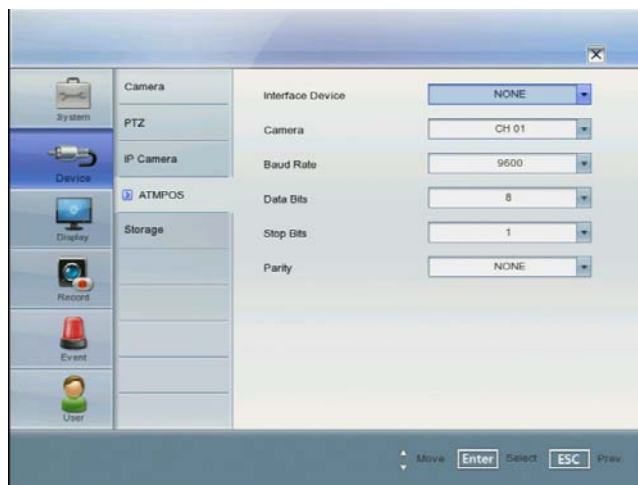

- Interface Device: Select the interface device from the drop-down list.
 - NONE: Selects when the ATM/POS device is connected with the DVR directly.
 - AVE Hydra: Selects when the ATM/POS device is connected via the AVE Hydra device to the DVR. If you set to AVE Hydra, the [Camera], [Baud Rate], [Data Bits], [Stop Bits] and [Parity] options are dimmed and these options are not set.
- Camera: Select the camera number for mapping with ATM/POS device.
- Baud Rate: Select the desired parameter to set the communication speed between DVR and ATM/POS device.
- Data Bits: Select the number of the data bits for RS-485 communication.
- Stop Bits: Select the desired parameter. The stop bit, added to the last of data, in asynchronous communication.
- Parity: Select the desired parameter. The parity bit, added to the data, to perform parity check.

Storage

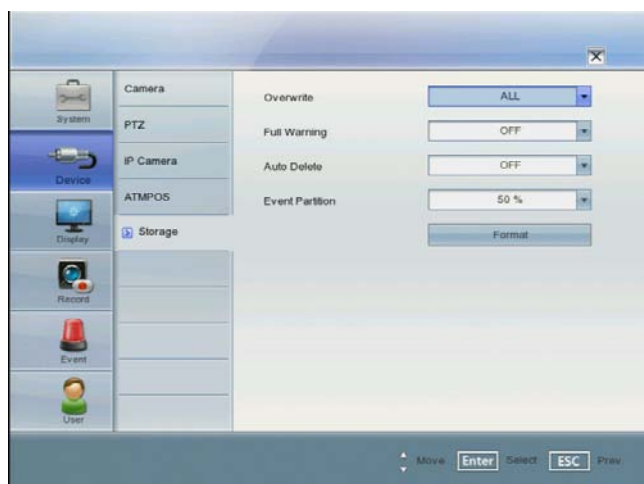

- Overwrite:
 - ALL: Overwrite recording is possible when the normal partition and event partition of HDD have fully recorded.
 - NORMAL PARTITION: Overwrite recording is possible for normal partition of HDD when the normal partition of HDD has fully recorded.
 - EVENT PARTITION: Overwrite recording is possible for event partition of HDD when the event partition of HDD has fully recorded.
 - OFF: Do not use overwriting.
- Full Warning: When the HDD has overflowed a warning message is displayed.
- Auto Delete: Set the auto delete date. If you set the auto delete date, the recorded data will be deleted except the data within the selected date period of time. The Auto Delete function is activated every 35 minutes.
- Event Partition: Set the space of event partition for event recording. The motion and sensor recording data are saved in the event partition area of the HDD. You should set the space of event partition before event recording.
- Format: Initializes the HDD (Hard Disk Drive). All data on the HDD will be erased.

NOTE

If you change the value of event partition, the current recorded data of HDD is deleted and the partition is reset. The partitions will be formatted automatically and the system will be restarted.

How to format the HDD

1. Select the [Event Partition] option and set the event partition rate of the HDD. If you set the event partition to 60%, the remaining space of 40% is set to normal partition automatically.
 - Event Partition: To save space of the HDD for motion and sensor recording data.
 - Normal Partition: To save space of the HDD for instant or normal recording data.
2. Select the [Format] icon and press ENTER.
3. Select [OK] and press ENTER to start format.

Display settings

OSD

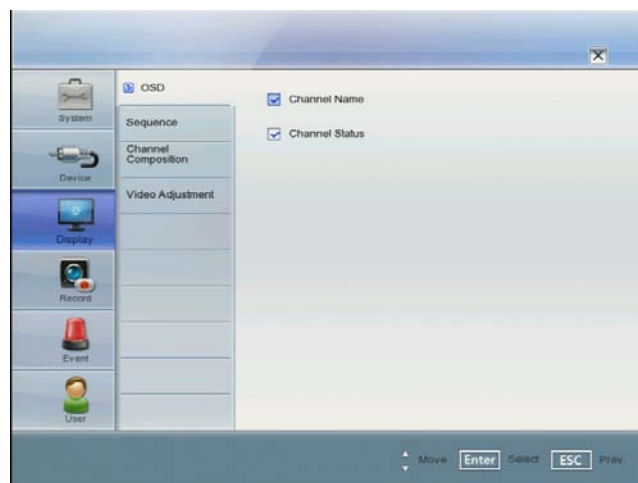

- Channel Name: Mark up to display or remove the channel name in the channel window.
- Channel Status: Mark up to display or remove the channel status in the channel window.

Sequence

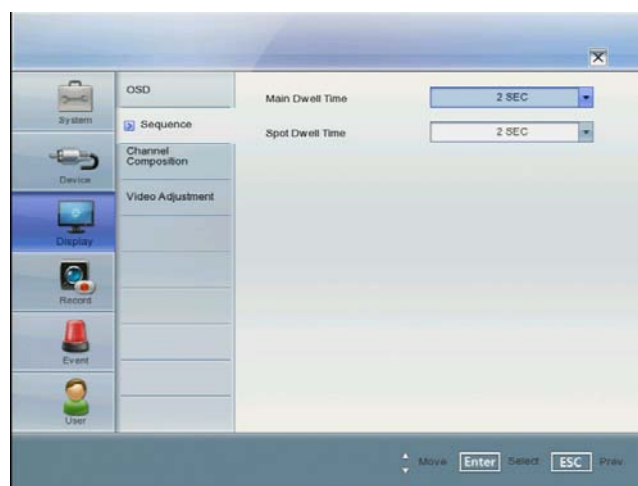

View all the channels in sequence in the selected screen division mode. You cannot use sequence mode with the 16 split (LE5008/LE4008 series: 8 split). While the sequence mode condition, if you change the screen division mode, the sequence function will be canceled.

- Main Dwell Time: Selects the channel sequence time for main monitor.
- Spot Dwell Time: Selects the channel sequence time for spot monitor.

Channel Composition



- Ch: Displays the channel number.
- Name: Selects the desired channel. You can set the IP channel only one time.

Video Adjustment

Adjust the brightness, contrast and color settings of each camera channel. You can see the settings screen from the preview windows.



- Channel: Selects the desired channel to adjust.
- Brightness: Adjust the brightness value from 0 to 100 for the selected channel.
- Contrast: Adjust the contrast value from 0 to 100 for the selected channel.
- Color: Adjust the color value from 0 to 100 for the selected channel.

Record settings

Schedule

A schedule recording can be activated at preset times, in a repeating pattern on selected weekdays. The DVR can record according to a schedule set by the user. It can also record manually regardless of date and time. The recording can be made either continuously or triggered by events (alarm and motion detection).

The recording schedule screen displays one day of the week showing the schedule of all channels over a 24-hour period. For each 1-hour cell block the recording method can be specified. The recording method for each block is shown in color for easy viewing.

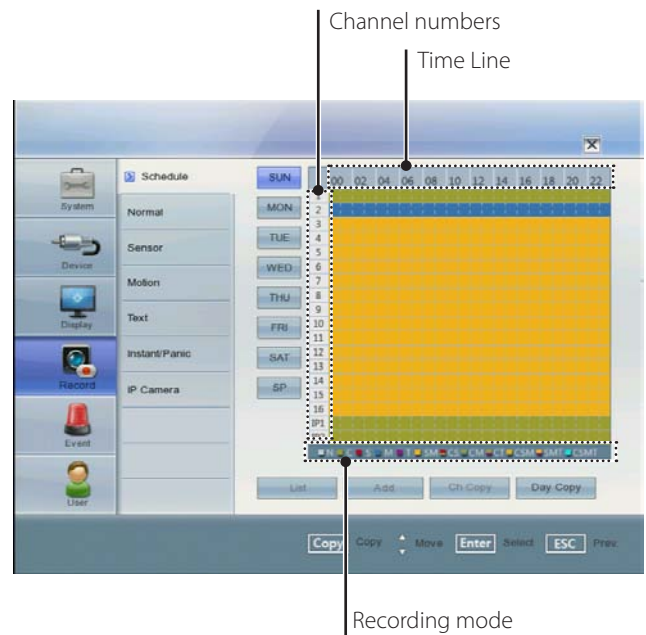

To Set the Recording Schedule for a Typical Day of the Week

1. Select a day of the week.

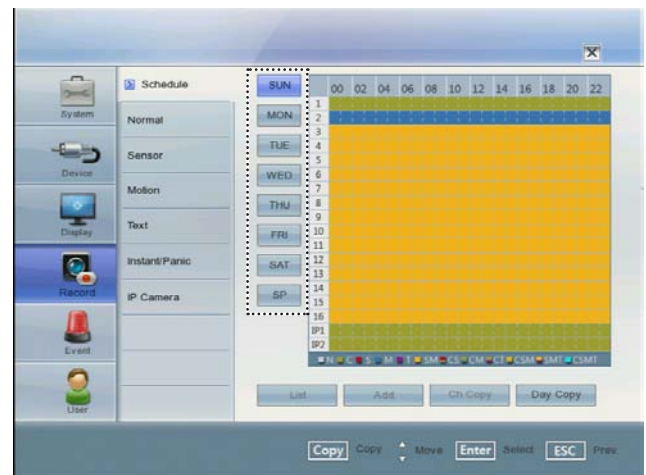

2. Select the desired channel to schedule recording.

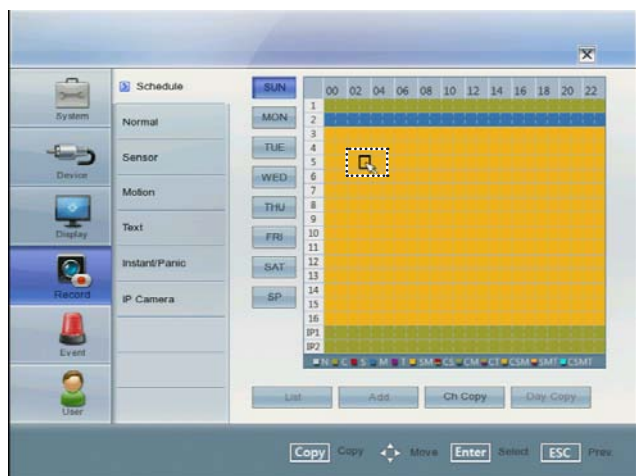

3. Select the time cell block for the start time.
4. Press ENTER or click the left mouse button to select a recording mode. The color of the cell blocks will change automatically.
 - Gray: No schedule recording.
 - Green (Continuous recording): Recording starts automatically from the preset time.
 - Red (Sensor event recording): Recording starts automatically when the sensor alarm occurs within a designated time.
 - Blue (Motion event recording): Recording starts automatically when motion is detected within a designated time.
 - Violet (Text event recording): Recording starts automatically when text input is detected within a designated time.
 - Yellow (Sensor+Motion recording): Recording starts automatically when the sensor alarm signal has input or motion has been detected.
 - Green+Red (Continuous+Sensor event recording): Recording starts automatically from the preset time. When the sensor alarm occurs within a designated time, change the continuous recording mode to sensor event recording mode and recording starts automatically.
 - Green+Blue (Continuous+Motion event recording): Recording starts automatically from the preset time. When the motion is detected within a designated time, change the continuous recording mode to motion event recording mode and recording starts automatically.
 - Green+Violet (Continuous+Text event recording): Recording starts automatically from the preset time. When the text input occurs within a designated time, change the continuous recording mode to text event recording mode and recording starts automatically.
 - Green+Yellow (Continuous+Sensor+Motion event recording): Recording starts automatically from the preset time. When the sensor alarm signal has input or motion has been detected, change the continuous recording mode to motion event recording mode and recording starts automatically.
 - Yellow+Violet (Sensor+Motion+Text event recording): When the sensor alarm signal has input, motion has been detected or the text input occurs and then recording starts automatically.

- Sky blue (Continuous+Sensor+Motion+Text event recording): Recording starts automatically from the preset time. When the sensor alarm signal has input, motion has been detected or the text input occurs within a designated time, change the continuous recording mode to occurred event recording mode and recording starts automatically.
5. Select the next time cell block of schedule time cell blocks to confirm the schedule time.
 6. Press ENTER or click the left mouse button repeatedly to select gray to set the time for the end of the schedule. The settings cell block is highlighted.

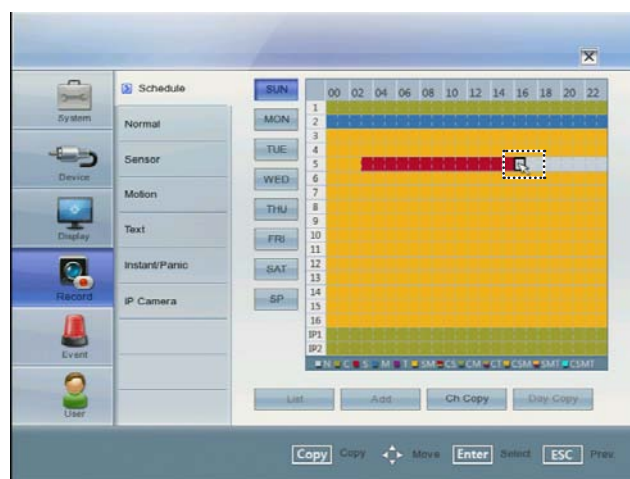

7. Press SETUP/ESC to move to the previous menu. If the save message appears, select [OK] and press ENTER to save the settings.
8. Press SETUP/ESC repeatedly to exit the Setup menu.

To Set a Recording Schedule for a Special Day

In addition to the weekly schedule, up to 10 specific date/time periods can be defined. To configure the specific recording schedule select Specific Dates.

1. Select the [SP] button on the schedule setting menu.
2. Select a cell block.
3. Press the [ZOOM +] button or click the [Add] icon on the special day setting menu. The specific date selection menu appears.
4. Enter the necessary information for year, month and date.
 - ◀ / ▶ / ▲ / ▼: Press to move the columns, [OK] or [Cancel] buttons.
 - ◀ / ▶ (or left/right mouse button): Changes the value at the current position.
5. Use ◀ / ▶ / ▲ / ▼ to select the [OK] button and press ENTER. The virtual keyboard menu appears.
6. Enter the name of the special day. Use ▲ / ▼ / ◀ / ▶ to select a character then press ENTER to confirm your selection.
7. Use ▲ / ▼ to select the [OK] icon then press ENTER to fix the date of the special day and return to the special day menu screen.
8. Select the schedule time and set the recording method for each channel.

Checking the Special Day Schedule List

1. Press [ZOOM -] when the [SP] button is selected. The special day scheduled list appears.
2. Select a special day title on the list and press ENTER. The title color turns orange.
3. Select the [Edit] icon then press ENTER to edit the special day or press [ZOOM -] to delete the special day schedule.
4. Press ESC to exit the special day schedule list.

NOTE

If the special day recording schedule is duplicated with the other recordings, only the special day recording is possible.

Copying the Recording Schedule

Copying from the Scheduled Data of the Channel

You can copy the schedule data of the channel to the other channel(s) within the selected day of the week. You can not copy the schedule data of the IP channel.

1. Select the day of the week and press ENTER.
2. Select channel that you want to copy.
3. Press COPY then the channel selection menu appears.
4. Use ◀ / ▶ to move to the left or right column then press ENTER to select the target channel(s). You can cancel the selected channel by pressing ENTER.
5. Use ▲ / ▼ to select [OK] then press ENTER to confirm your selection.

Copying from the Scheduled Data of the Day

You can copy the scheduled day of the week to another day of the week, weekday and weekend using the COPY button.

1. Select the day of week that you want to copy.
2. Press COPY then the select date(s) menu appears.
3. Use ◀ / ▶ to select the target date(s).
4. Use ▲ / ▼ to select [OK] then press ENTER to confirm your selection.

Normal

Settings concerning normal recording.

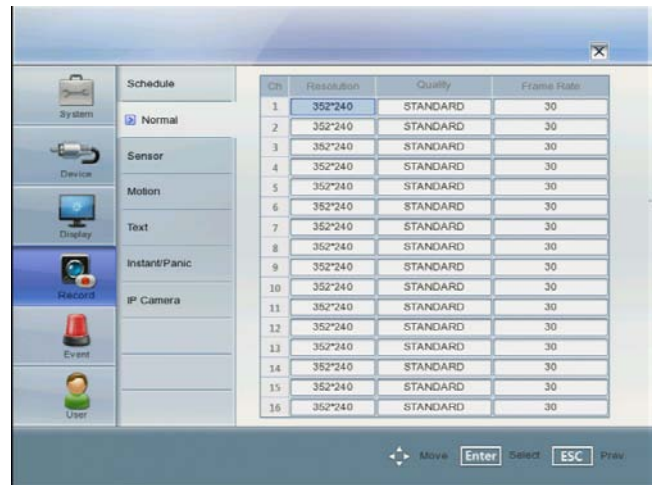

- Ch: Displays the channel number.
- Resolution: Selects the recording resolution.
- Quality: Selects the recording picture quality.
- Frame Rate: Selects the frame rate. The frame rate is the number of recorded frames per second. According to resolution, the frame rate is set automatically.

NOTE

In case of the LE4000 series models, the resolution setting is possible in the Normal setting menu only. Each group such as "Ch1 to Ch4", "Ch5 to Ch8", "Ch9 to Ch12" and "Ch13 to Ch16" are set the same resolution.

If you change the resolution of the Normal option, the resolution of the Motion, Sensor, Text and Instant/Panic options will be changed automatically with the same resolution.

Sensor

Settings concerning sensor recording.



- Ch: Displays the channel number.
- Resolution: Selects the recording resolution. The LE4000 series models are displayed only.

- **Quality:** Selects the recording picture quality
- **Frame Rate:** Selects the frame rate. The frame rate is the number of recorded frames per second. According to resolution, the frame rate is set automatically.
- **Prealarm:** Specify the pre-event recording time. When the Event signal is detected, the DVR is recording the data before the event during the setting time.
- **Postalarm:** Specify the post-event recording time. When the Event signal is detected, the DVR is recording the data after the event during the setting time.

Motion

Settings concerning motion recording.



- **Ch:** Displays the channel number.
- **Resolution:** Selects the recording resolution. The LE4000 series models are display only.
- **Quality:** Selects the recording picture quality.
- **Frame Rate:** Selects the frame rate. The frame rate is the number of recorded frames per second. According to resolution, the frame rate is set automatically.
- **Prealarm:** Specify the pre-event recording time. When the Event signal is detected, the DVR is recording the data before the event during the setting time.
- **Postalarm:** Specify the post-event recording time. When the Event signal is detected, the DVR is recording the data after the event during the setting time.

Text

Settings concerning text recording.



- **Ch:** Displays the channel number.
- **Resolution:** Selects the recording resolution. The LE4000 series models are display only.
- **Quality:** Selects the recording picture quality.
- **Frame Rate:** Selects the frame rate. The frame rate is the number of recorded frames per second. According to resolution, the frame rate is set automatically.
- **Prealarm:** Specify the pre-event recording time. When the Event signal is detected, the DVR is recording the data before the event during the setting time.
- **Postalarm:** Specify the post-event recording time. When the Event signal is detected, the DVR is recording the data after the event during the setting time.

Instant/Panic

Settings concerning instant/panic recording.



- **Ch:** Displays the channel number.
- **Resolution:** Selects the recording resolution. The LE4000 series models are display only.
- **Quality:** Selects the recording picture quality
- **Frame Rate:** Selects the frame rate. The frame rate is the number of recorded frames per second. According to resolution, the frame rate is set automatically.

IP camera

Settings concerning IP camera recording.

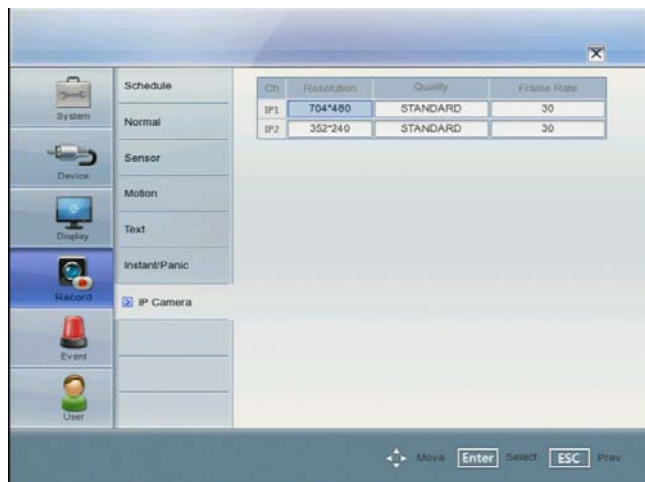

- Ch: Displays the IP camera channel number.
- Resolution: Selects the recording resolution.
- Quality: Selects the recording picture quality
- Frame Rate: Selects the frame rate. The frame rate is the number of recorded frames per second. According to resolution, the frame rate is set automatically.



NOTE

- If the video of some IP cameras is not displayed, you should set the [Resolution] option to CIF (352x240 or 352x288).
- If you want to set the Frame Rate manually for each recording setting menu, refer to the below.

LE5016/LE5008 Series		
	Resolution	Frame Rate
NTSC	352*240	1, 3, 5, 7.5, 10, 15, 30
	704*240	
	704*480	
PAL	352*288	1, 3, 5, 6, 7.5, 12.5, 25
	704*288	
	704*576	

LE4016/LE4008 Series		
	Resolution	Frame Rate
NTSC	352*240	1, 3, 5, 7.5, 10, 15, 30
	704*240	1, 3, 5, 7.5, 10, 15
	704*480	1, 3, 5, 7.5
PAL	352*288	1, 3, 5, 6, 7.5, 12.5, 25
	704*288	1, 3, 5, 6, 7.5, 12.5
	704*576	1, 3, 6

Event settings

Sensor



- In: Displays the number of the ALARM-IN terminal.
- Sensor Type: The sensor state can be set to either N.O. (Normally Open) or N.C. (Normally Closed).
- Camera: Select the connected camera channel to the ALARM-IN terminal.
- Relay Output: Select the alarm (relay) output number for the RELAY-OUT terminal for the output alarm (relay) signal.
- Preset: Select the preset number. When the input is activated, the camera moves to the selected preset position and the picture of the camera in that position appears on the monitor.

Motion

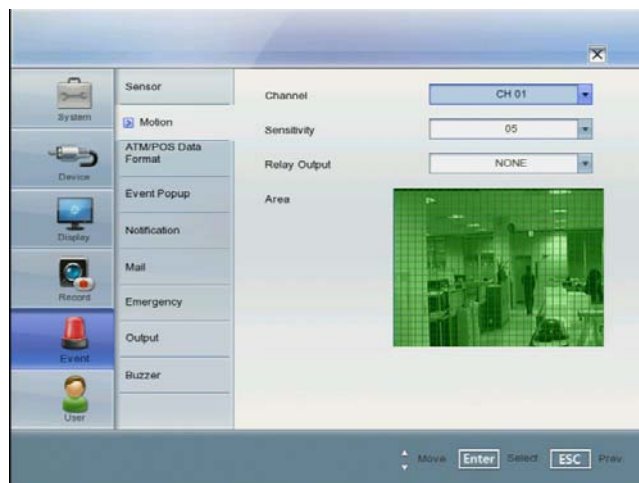

- Channel: Select the channel to set motion detection.
- Sensitivity: Set the level of sensitivity for the created motion detection area. Sensitivity can be set from level 01 to 10 or OFF.
- Relay Output: Select the number of the RELAY-OUT terminal for the output alarm (relay) signal when motion is detected.
- Area: Select the desired motion detection area on the preview window screen.
 - ◀ / ▶ / ▲ / ▼: Moves the yellow cell box to another cell zone.

- ENTER: Selects or cancels the motion detection area at the current cell position.
- Press ESC to exit the settings.

NOTE

- You can select the motion detection area by using the mouse.
 - To select the area: Drag & drop a cell to the right to select the motion detection area.
 - To cancel area: Drag & drop a cell point of a selected cell area to the left to cancel the motion detection area.
- In the condition that illumination is low and the outline of object is not clear enough to see, regardless of sensitivity, Motion Event could be possible not to happen. You must check Motion Event before setting.

ATM/POS Data Format

The DVR can be set to react to text input from devices such as ATMs (Automated Teller Machines) and POS (Point of Sale; i.e., cash registers). This screen allows you to configure the DVR for your input device.



- Input Channel: Select the mapping camera channel.
- Transaction Start: Enter a Transaction Start string. Refer to the device manufacturer's documentation for the text string that the device first sends when a transaction starts.
- Transaction End: Enter a Transaction End string. Refer to the device manufacturer's documentation for the text string that the device sends when a transaction ends.
- Delimiter: Enter the character(s) that the device uses to indicate the end of a line. Refer to the device manufacturer's documentation for Line Delimiter character(s).
- Ignore String: Enter the any strings of text that you want the DVR to ignore. Refer to the device manufacturer's documentation for text strings that the device sends during transactions, so you will know which ones you do not want recorded.
- Time Out: Select the Recording end time.
- Relay Output:
 - 01 to 04: Outputs the alarm (relay) signal via the RELAY-OUT terminal. When the DVR detects text input, it triggers output signals on all the associated RELAY-OUT connectors.
 - NONE: Not used.

NOTE

ATM/POS Recording Information.

Option setting	ATM/POS Recording Action
When the Transaction Start and Transaction End options are set.	Recording is started automatically when the Transaction start data is detected. When the Transaction end data is detected the recording is stopped after post-alarm time.
When the Transaction Start and Transaction End option is not set.	Recording is started automatically when the transaction data is detected. When the transaction data is not detected the recording is stopped after post-alarm time and the time you set of the Time Out option.

Event Popup



- Spot Monitor: Select the event type for the spot monitor display when the event is activated.

Notification

Marks up when you want to activate the selected option. If the selected notification option is activated, the device will notify the user about the information of selected option by E-mail.

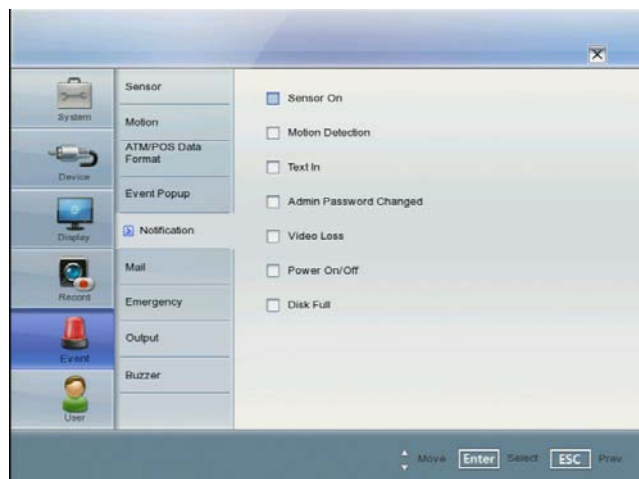

- Sensor On: Sends an e-mail when a sensor has occurred.
- Motion Detection: Sends an e-mail when a motion detection has occurred.
- Text In: Sends an e-mail when a text input is detected.
- Admin Password Changed: Sends an e-mail when the administrator password has changed.
- Video Loss: Sends an e-mail when a video signal from the camera has stopped because of a cable disconnection or malfunction of a camera.
- Power On/Off: Sends an e-mail when power is on or off.
- Disk Full: Sends an e-mail when the HDD has fully recorded.

Mail

- Notification: Marks up to notify the unit operating information according to notification settings by e-mail.
- SMTP Server: Enter the SMTP Server address. If notification option is not mark up and the SMTP server option is empty, the SMTP Port, User Name, Password and TLS options cannot be set.
- SMTP Port: Enter the SMTP Port Number. Typically the port used for SMTP is 25. However in some cases it is better to change this port number for added flexibility or security. You can edit this port between 1 and 65 535.
- User Name: Enter the user name.
- Password: Enter the password.
- TLS: Marks up when using the TLS (Transport Layer Security) function.
- Mail Address (1 to 3): Enter the mail address. You can input up to 3 e-mail addresses.
- E-mail Test: Select [E-mail Test] to test send an e-mail.



NOTE

The SMTP server, SMTP port no., user name or password settings are optional. The DVR can send e-mail directly without the use of an SMTP server or MTA (message transfer agent). In certain cases all e-mail should be forwarded to a specific SMTP server. Specify the server host name or IP address in such a case. For more detail on SMTP setup, ask your network administrator and/or mail service provider.

Emergency

- Notification: Marks up to notify the emergency agent about unit operating information according to your notification settings.
- Host Name/Port: Enter the Host Name and port number of the emergency agent program. The factory default port for this function is 9002. However in some cases it is better to change this port number for added flexibility or security. You can edit this port between 1 025 and 65 535. You can set up to 9 Host Name and port numbers.

Output

- Relay Off
 - ALARM ACKNOWLEDGE: Use the ALM.OFF button to stop alarm.
 - POST-ALARM TIME: The alarm is stopped after post-alarm time.
- System Alarm Out: Outputs the alarm (relay) signal via the selected alarm out terminal number below cases. If you do not use this function, select [NONE] option.
 - When the HDD has a bad sector.
 - When a video signal from the camera has stopped because of a cable disconnection or malfunction of a camera.

Buzzer

Marks up when you want to activate the selected option.

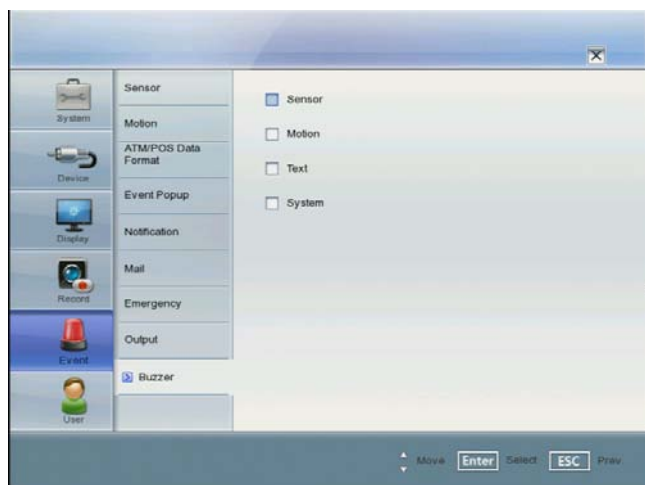

- Sensor: Makes a sound when a sensor occurs.
- Motion : Makes a sound when a motion is detected.
- Text: Makes a sound when the DVR detects text input .
- System: Makes a sound when a cooling fan is not activated or the HDD has bad sector.

User settings

Group Authority

You can register a new user group with various access rights.

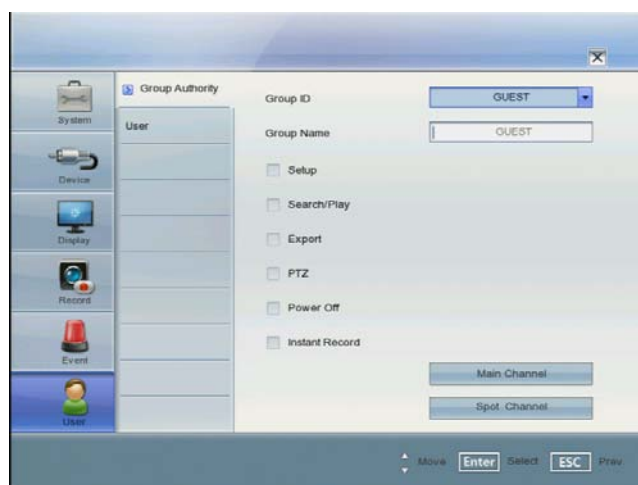

- Group ID: Select the group ID to assign authority.
 - GUEST: The GUEST group has the limited authority of the system. Users in this group are available to see the live image and to set the covert function of the Main or Spot channel.
 - ADMINISTRATOR: The ADMINISTRATOR group has the unlimited authority of the system. Users in this group are available to use all of the functions.
 - [Group 01] to [Group 08]: Users in this group are available to set the authority of the function manually.

! NOTE

The GUEST and ADMINISTRATOR group are set initially for the authority. You cannot change the initial settings and group name (GUEST and ADMINISTRATOR).

- Group Name: If you select one of the group numbers from the Group ID option, you can register the group name. Enter the group name.
 - Setup, Search/Play, Export, PTZ, Power Off, Instant Record: Set the authority for the selected group. Marks up the option to activate it.
- Main Channel/Spot Channel: Selects the channel to allow the operation for the group user. The LG logo is displayed on the covert channel(s).

User

You can set the user name for the selected User ID.

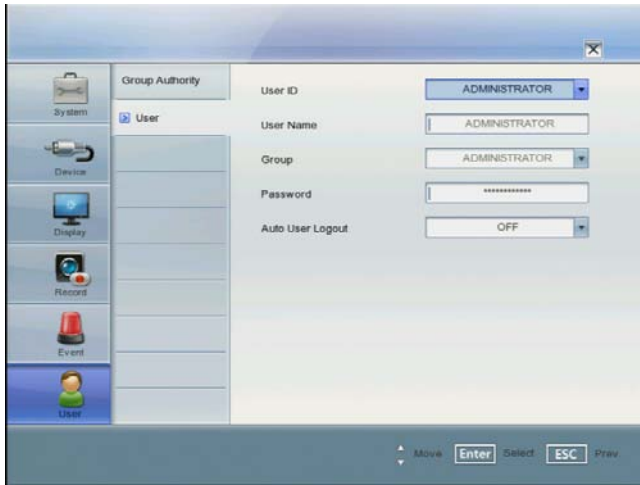

1. Select [User ID] from the drop-down list.
2. Enter the user name of the selected user ID.
3. Select the user group from the drop-down list.
4. Enter the Password.
5. Select the auto user logout time from the drop-down list.
6. Press the ESC button to display the confirmation window.
7. Select [OK] to save the setting or [Cancel] to cancel the setting.

NOTE

- If you set the user ID to [ADMINISTRATOR], you cannot change the [User Name] and [Group] option but you can change the password.
- The user name and password are case-sensitive.

4 Operation

Instant Recording

Images from a camera will be recorded on the built-in hard disk. Ensure all the cameras are connected and that time and date have been set correctly.

Before you start recording, first check the repeat recording settings in the recording menu of the system setup, and then make the recording settings.

1. Press the REC button and then press the channel button you want to record. The recording type indicator turns green on the selected channel screen of the main monitor.

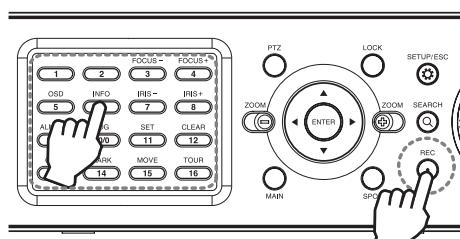

2. Press the REC button and then press the channel button you want to stop recording. If you stop instant recording, the recording mode will be changed into the scheduled recording mode (Continuous/ Alarm/ Motion records). If the schedule is not set, the button indicator turns off and the recording type indicator turns white on the selected channel screen of the main monitor.

Panic Recording

You can record the all channels at the same time.

This function is activated for a live channel only.

1. Press and hold the REC button until the Recording Type indicator turns green on the all live channel screens. The DVR will start recording.
2. Press and hold the REC button until the Recording Type indicator turns white on the all live channel screens. The DVR will stop recording.

! NOTE

- External recording devices can be used as copy areas for images recorded on the hard disk. It is impossible to record images on the external recording devices directly.
- You can record instantly with the left mouse button.
 1. Move the cursor to the desired channel screen on the main monitor.
 2. Click the recording type indicator with the left mouse button and recording starts. Click it once again and the instant record stops and the recording type indicator will be changed into the scheduled recording mode (Continuous / Alarm / Motion record). If the schedule is not set, the recording type indicator turns white.
- You can instant record that the channels scheduled such as alarm, motion or continuous.
- Once you stop instant recording, the recording type indicator will be changed to the scheduled recording mode.
- You can not record the Instant and Continuous recording in following conditions.
 - A HDD is not attached.
 - A HDD is not formatted.
 - The channel has no video input for display.
 - Overwrite sets to "OFF" or "EVENT PARTITION", and normal partition is full.
 - On the HDD setting, the event partition is set to 100 %.
- You can not record the Alarm and Motion recording in following conditions.
 - A HDD is not attached.
 - A HDD is not formatted.
 - The channel has no video input for display.
 - Overwrite sets to "OFF" or "NORMAL PARTITION", and event partition is full.
 - On the HDD setting, the event partition is set to 0 %.
 - The schedule (Alarm/Motion) record is not set.
- HDD partition according to a recording type.
 - Normal Partition: It is the space in the HDD that stores the continuous and instant recorded data. Once the normal partition is set to 0% (the event partition is 100%), you can not record the continuous or instant recordings.
 - Event Partition: It is the space in the HDD that stores the alarm and motion recorded data. Once the event partition is set to 0%, you can not record the alarm and motion recording.
- Priority of record.
Instant record > Alarm record > Motion record > Continuous record.

Instant Playback

It is possible to play a recorded image without stopping recording.

1. Select a channel you want to playback.
2. Press ◀▶ (Play) button to play a recorded image of the previous 1 or 2 minutes of recording. The playback image will be displayed on the full screen window.
3. Press ■ (STOP) button to stop the playback.

Search and Playback

The various search functions of this unit can be used to go to the beginning of the desired picture. When the SEARCH button is pressed the search menu is displayed.

Date and Time Search

Use to search recorded pictures by specifying date, hour and minute.

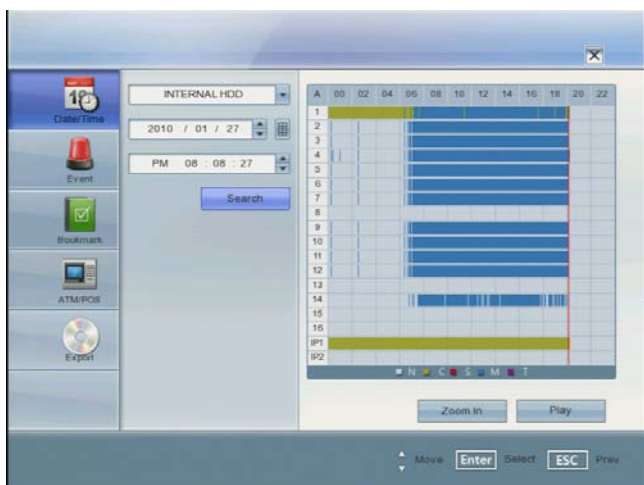

1. Use ▲/▼ button to select the [Date/Time] icon then press ENTER.
2. Select the desired source device.
 - INTERNAL HDD: Plays back or searches recorded contents of the internal HDD device.
 - Source Device: Plays back or searches backup contents of the source device.
3. Set the year, month, date and time.
 - ◀▶: Moves to the previous or next column.
 - ▲/▼: Changes the value at the current position.
 - ENTER: Selects the column or confirms the setting.
4. Select the [Search] icon then press ENTER. The search result is displayed.
5. Use ▲/▼ button to select the channel and press ENTER. Repeat this step to select the other channels.
6. Press ◀▶ (Play) button or click the [Play] button to start playback. The picture(s) is (are) displayed on the main monitor.
7. Press STOP (■) to stop playback and return to the search menu.

8. Press SETUP/ESC to exit the [Date/Time] menu.

Using the calendar icon to select the date

1. Select calendar icon then press ENTER.
2. Select year or month column then press ENTER.
3. Use ◀▶ button to input the year or month.
4. Press ENTER to confirm it.
5. Use ▲/▼/◀▶ to select date then press ENTER.
6. Select [OK] button and press ENTER to confirm the settings.

NOTE

- While the backup is in progress, you can not search the data on the backup device.
- Do not remove the external USB device whilst the backup search is in progress from the USB device. It may cause a malfunction.
- Recorded data shown on the time graph will be displayed in different colors depending on the recording type.
 - Green: Continuous recording.
 - Red: Sensor recording.
 - Blue: Motion-detection recording.
 - Gray: No recording.
 - Violet: ATM/POS recording.
- Use the ZOOM + button to view the detailed time by 6 hour intervals.

Event Search

Search a recorded picture by date and type of event.



1. Use ▲/▼ button to select the [Event] icon then press ENTER.
2. Select the desired source device.
3. Set the year, month, date and time.
 - ◀▶: Moves to the previous or next column.
 - ▲/▼: Changes the value at the current position.
 - ENTER: Selects the column or confirms the setting.
4. Use ▲/▼/◀▶ button to select the channel and press ENTER button to confirm the selection. If you want to select the all channels, marks up the [All Channels] option.
5. Select the [Event Type] then press ENTER.
6. Use ▲/▼ to select the event type then press ENTER.

7. Select the [Search] icon then press ENTER.
The event list menu appears.
8. Select the recording data on the event list then press ◀▶ (Play) button, click [Play] or double click the selected data to start playback.
The picture is displayed on the main monitor.
9. Press STOP (■) to stop playback and return to the event list menu.
10. Press SETUP/ESC repeatedly to exit the event search menu.

Bookmark Search

Search the desired picture with a bookmark registered by the bookmark function.

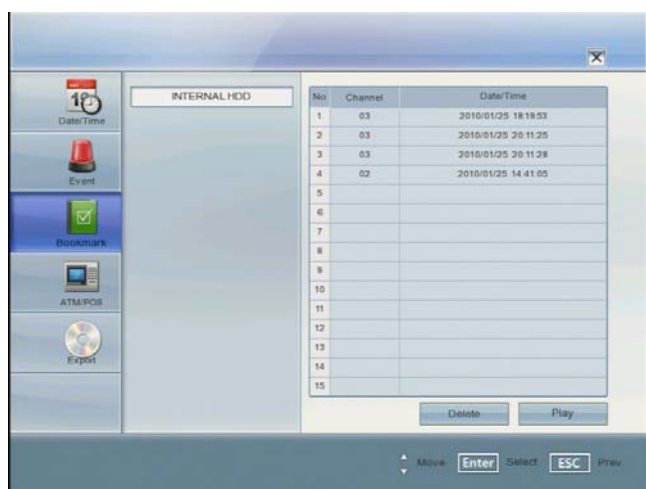

1. Use ▲/▼ button to select the [Bookmark] icon then press ENTER.
2. Select the recording data on the list then press ◀▶ (Play), click [Play] or double click the selected data to start playback.
The picture is displayed in the main monitor.
3. Press STOP (■) to stop playback and return to the bookmark list menu.
4. Press SETUP/ESC to exit the bookmark search menu.

NOTE

- Backup data can not be played back by a bookmark search.
- You can register a bookmark only in the single channel playback.
- If you delete the bookmark on the list, select the recording data and select [Delete] button and press ENTER.

ATM/POS Search

Search the recorded text information by ATM/POS device. This function is available with backup data of the internal or external HDD only.



1. Use ▲/▼ button to select the [ATM/POS] icon then press ENTER.
2. Select the desired source device.
3. Set the year, month, date and time.
 - ◀/▶: Moves to the previous or next column.
 - ▲/▼: Changes the value at the current position.
 - ENTER: Selects the column or confirms the setting.
4. Use ▲/▼/◀/▶ button to select the channel and press ENTER button to confirm the selection. If you want to select the all channels, marks up the [All Channels] option.
5. Set the detail search options.
 - Number: Displays the preset number.
 - Option Item: Enter the text to search what you want.
 - AND/OR : Select the Boolean operator when you use the Text search and Number search function simultaneously.
 - Value: Enter the number to search what you want.
 - >, <, <=, =, >= (compare symbols): Select the compare symbol for number search.

>	To find the lower value than the input value.
<	To find the higher value than the input value.
<=	To find the higher or even value than the input value.
=	To find the even value than the input value.
>=	To find the lower or even value than the input value.

6. Select the [Search] icon then press ENTER.
7. Select the text data on the list then press ◀▶ (Play) button, click [Play] or double click the selected text data to start playback.
The picture is displayed on the main monitor.
8. Press STOP (■) to stop playback and return to the ATM/POS search list menu.

Export Search

Search an exported data from the external device or internal DVD-ROM device.

If you want to use this function, you have to connect the external device or insert the CD/DVD disc with exported data otherwise the warning message will be displayed.

Check the export device before you proceed.

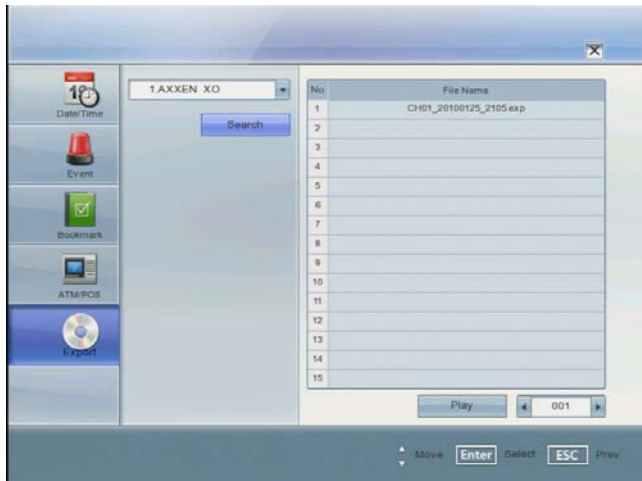

1. Use ▲/▼ button to select the [Export] icon then press ENTER.
2. Select the desired source device.
3. Select the [Search] icon then press ENTER.
The exported file list menu appears.
4. Select the exported file on the exported file list then press ◀▶ (Play) button or click [Play] to start playback.
The picture is displayed on the main monitor.
5. Press STOP (■) to stop playback and return to the exported file list menu.

5

LG Network Client Program

Introduction

The LG Network Client program is an IP-Surveillance software that works with the LG DVR to provide video monitoring, recording setting and event management functions. The software has multiple search functions for recorded events. Remote viewing and playback are also possible with the use of the LG Network Client.

This manual contains instructions on how to use and manage the LG Network Client in your networking environment. Some knowledge of networking environments would be beneficial to the reader.

Should you require any technical assistance, please contact authorized service center.

Recommended PC Requirements

The LG Network Client program must be installed below operating systems for best performance and stability.

Items	Requirements
Operating System	Windows XP Professional Service Pack 2 or above
CPU	Intel Pentium IV or above
Web Browser	Microsoft Internet Explorer 6.0 or above
Memory	512 MB or above RAM
Graphics Card	128 MB or above Video RAM (Use latest graphics card driver.)
Resolution	1024 x768 (with 32bit color) or above
Network	100 Megabit Network (Gigabit Network recommended for larger systems)

Before install the program

- The description pictures may differ from your OS (Operating System) or Web Browser type.
- The pictures used in this manual are based on Windows XP Professional.
- Do not use other applications with this program. This can cause memory shortage and program malfunction.
- Check that the LG DVR is(are) connected to the network and that power is supplied.

Getting Started

Install the LG Network Client on your PC

You can install the LG Network Client software following steps.

1. Insert the Client Program CD which will be started automatically. If the disc does not run automatically on your PC, open the Client Program CD and install the program manually.
2. Run the install file and install the programs to your computer following the on-screen instructions. The [LG Emergency Agent] and [LG Export viewer] programs will be installed with the LG Network Client program installation.
3. After finishing installation, you will find the programs in the Start menu or on the desktop.

Starting the LG Network Client

1. Run the LG Network Client program. To launch LG Network Client, select LG Network Client from your **Start > Programs > LG Electronics > LG Network Client > LG Network Client** or click the **LG Network Client** icon on your desktop. The client password input window is displayed.
2. Enter the password. (Note that the default client password are "000000")
3. Click the [OK] button and then the LG Network Client window is displayed.

NOTE

If you mark up the [Auto Connection] option, the LG Network Client program is connected automatically at the next time.

LG Network Client Overview

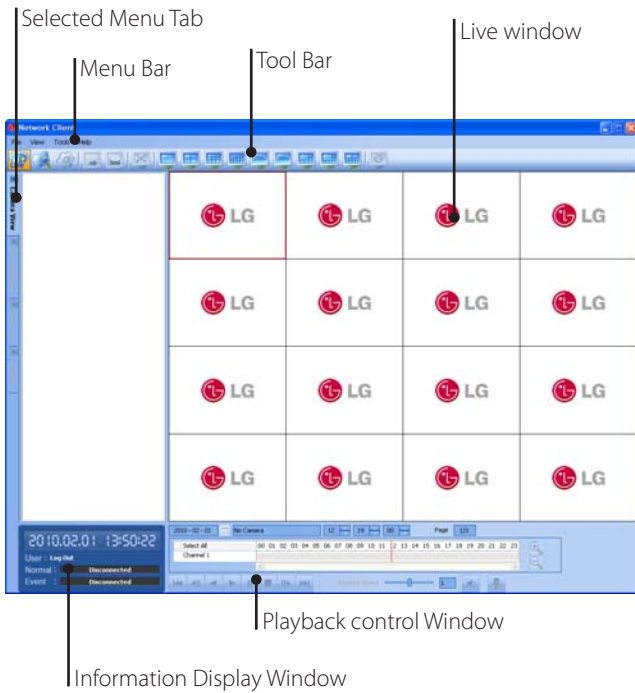



Menu Bar







Menu	Sub-Menu	Description
File	Client Password	You can change the password of the Network Client program. 1. Select this option. The Client Password Setup window is displayed. 2. Enter the password. 3. Click [OK] to confirm your settings.
	Save to JPEG	You can capture and save the current image in JPEG file format. 1. Play the recorded data. 2. Pause the playback at a desired point during playback. 3. Select this option. The JPEG Export window is displayed. 4. Set the options. 5. Click the [Save] button.
	Backup Search	Search and playback a backup data. 1. Select the Search Mode icon. 2. Select this option. The Backup Search window is displayed. 3. Click the [Add] button. 4. Enter the Name. 5. Find and open the backup file. 6. Click the [OK] button. 7. Use the time line and playback control buttons to play the backup data.

File	End Backup Search	Use to stop and exit the backup search function.
	Software Update	Use to upgrade DVR software or add/upgrade PTZ protocols. 1. Log-in the Network Client program as the permitted user who has the Group Setup authority. 2. Click this option. The Update setting window is displayed. 3. Select the update device from the list. <ul style="list-style-type: none"> Select All: If you click this button, the all devices in the list are selected . Clear All: If you click this button, the all selected devices in the list are deselected . 4. Find and open the update file. 5. Click the [Update] button to begin the update process. The DVR will be restarted after updating. 6. Click the [Exit] button.
	Exit	Exit the program.
View	OSD	<ul style="list-style-type: none"> Channel Number: Displays or removes the channel number in the channel window. Site Name: Displays or removes the site name in the channel window. Camera Name: Displays or removes the camera name in the channel window. Playback Time: Displays or removes the date/time of playback data in the channel window. PTZ: Displays PTZ camera icon in the channel window. Audio: Displays audio icon in the channel window. Select All: Displays all OSD options in the channel window.
	Sequence (Dwell Time)	Select the sequence to 5 seconds, 10 seconds, 15 seconds or 20 seconds.
	Sequence Mode	<ul style="list-style-type: none"> Channel Sequence: Each channel of the selected site in the sequence mode will be displayed in sequence. Site Sequence: Each channel of the logged site in the sequence mode will be displayed in sequence

View	Language	Select the language for LG Network Client program.
	Resolution	Select the resolution of the LG Network Client program.
Tools	Connection Information	Displays the Connection List windows. Add, Edit or Delete the site name or group name in LG Network Client.
	E-Map	Displays the E-Map pop-up windows. This function gives a visual overview of the cameras in your surveillance environment using the imported maps.
Help	Client Information	Displays Network Client Version Information.

 <p>Division</p>	When the icon is clicked, the screen will be changed to split mode and if the icon is clicked again, the screen will be changed by sequence (except 36 split mode). Choose the screen division mode.
 <p>Sequence</p>	View all the channels in sequence. You cannot use sequence mode with the 36 split.

Tool Bar

Icon	Description
 <p>Live</p>	Displays the live view workspace. <ul style="list-style-type: none"> • Camera View: You can see the surveillance camera's images in the window(s) and the camera information. • Pan/Tilt/Zoom: You can control the PTZ camera. • Log View: You can see the system log list. • Favorites: You can save the current configuration of the camera view. And, it is possible to return to a previous configuration of the camera view.
 <p>Search</p>	Displays the search workspace. You can search and play the recorded data using the search functions.
 <p>Setup</p>	You can set the configuration of the selected site via the network.
 <p>Export</p>	Displays the Export pop-up windows.
 <p>Print</p>	When you click the PAUSE button to pause the playing the recorded data of the selected channel, the Print Icon is activated. You can print the paused picture of the recorded data of the selected channel.
 <p>Full Screen</p>	You can view the live window in full screen mode. To return to the normal screen, click the right mouse button.

Information Display Window

Displays current date and time, user information and the remaining HDD status of the selected site name.

Playback control Window

You can playback the recorded data of the selected channel.

Operation and settings

Register the Site Name or Group Name

The first time LG Network Client is started, you should register a site name to control it by the LG Network Client program. The computer running LG Network Client program must be on the same network with DVR.

1. Select [Tools] > [Connection Information] option on the menu bar. The Connection List window is displayed.
2. After completing the settings, click the [OK] button to confirm the settings and exit the window. The registered site or group name is(are) displayed on the [Camera View] tab window.

Create a new group name

1. Click the [Add Group] button. The Add Group window is displayed.
2. Enter the group name.
3. Click the [OK] button to confirm it. The registered group name is displayed on the Connection List.

Edit a group name

1. Select the required group name on the Connection List.
2. Click the [Edit] button. The Edit Group window is displayed.
3. Overwrite the existing group name with a new name that you want.
4. Click the [OK] button to confirm it.

Delete a group folder

1. Select the required group name on the Connection List.
2. Click the [Delete] button. The selected group name is deleted. Deleting a group name will delete all site names within the group name as well.

Add the Site Name

1. Click the [Add] button. The Connection Setup window is displayed.
2. Select the group name from the drop-down list.
3. Enter the description of the site name.
4. Enter the IP Address or the Host Name that you entered in the DDNS setup menu of the DVR.
In case of entering the server name instead of the IP Address. You should set up the DDNS configuration properly in the server. Please refer to the server manual to set up the DDNS function.

Case	How to find the IP Address
Using the Static IP Address	Check the IP Address in the TCP/IP option of the DVR setup menu.
Using the Dynamic IP Address	You have to activate the DHCP function. 1. Press INFO to display the System Information window. 2. Check the "Network IP" options value.
Using the DDNS function	Check the registered Host Name of the DDNS setup menu.

The DVR is connected to the network through the Broadband Router	You must set the port forwarding according to the settings of the broadband router. Refer to the manual of Broadband router for more detailed settings. If you use the multi DVR with Broadband router, you must set the TCP/IP port number for each DVR.
--	---

5. Enter the TCP/IP port number of the DVR. If it isn't entered, the port number is set by default.
6. Enter the User ID and Password. If you set the User ID and Password, you can use the Auto connection function.
7. Click the [OK] button. The registered site name is displayed on the Connection List.

Edit the Site Name

1. Select the required site name on the Connection List.
2. Click the [Edit] button. The Connection Setup window is displayed.
3. Specify the Group Name, IP Address, Port, User ID, Password and click the [OK] button to confirm the settings. You cannot edit the site name option.

Delete the Site Name

1. Select the required site name on the Connection List.
2. Click the [Delete] button. The selected site name is deleted.

Connect to the DVR

1. Select the registered site name to connect it.
2. Click the right mouse button on the site name. Select the [Connect] option. The site name is connected automatically and the site name is activated. If the site name has no information of the User ID and/or Password, the remote login window is displayed. In that case, enter the User ID and the password.

About the pop-up menu

- User Log-In: Select to connect the DVR manually.
 - User Log-Out: Select to disconnect the site name.
 - Connect: Select to connect to the DVR automatically. You should set the User ID and Password option of the connection information setting menu for using this function.
 - Disconnect: Select to disconnect to the site name.
3. Repeat step 1 to 2 to connect the other site name.



NOTE
Up to 5 users can connect to the DVR system using the LG Network Client program.

Connect the group device

1. Select the registered group name to connect it.
2. Click the right mouse button on the group name. Select the [Connect] option. Each site name is connected automatically and the site name is activated in the group name.
3. Repeat step 1 to 2 to connect the other group name.

Disconnect the site name or group name

1. Select the required site name or group name.
2. Click the right mouse button on the site name or group name. Select the [Disconnect] option. The site name is disconnected and deactivated.
3. Repeat step 1 to 2 for disconnection.

Using the Live function



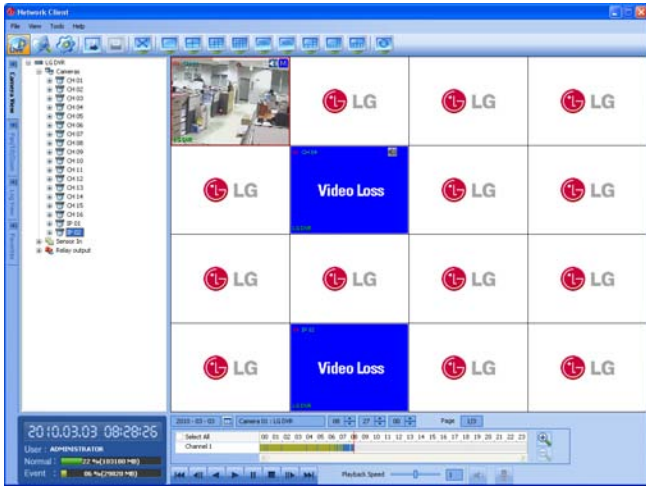







Camera View Tab

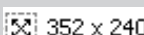
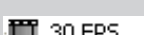

1. Select the [Camera View] tab in the live mode.
2. Select the activated site name and double click the left mouse button or click the plus mark of the registered site name.
3. Select [Cameras] and double click the left mouse button or click the plus mark.
4. Select the channel number you want to view.
5. Click the channel number and drag and drop to live window position. If you select [Cameras] and drag and drop to a live window then all channels are displayed.
6. Live image is displayed in the selected window.
7. Repeat steps 3 to 5 to set the other live windows.

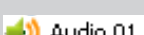
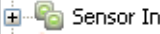
NOTE

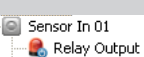

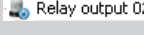





- Configuration of camera view is set the first time only. This configuration setup is memorized for the next time and displayed as it is.
- About the camera view menu tree.

 LG DVR	Displays the registered site name or group name.	
	Displays the camera information .	
	 CH 01	Displays the camera channel name.
	 352 x 240	Displays the Resolution.
	 30 FPS	Displays the Recording Frame Rate.
	 Standard	Displays the Quality.
	 Continuous	Displays the Recording mode.
	 None	Displays the relay output condition.
 Audio 01	Displays the Audio information.	
	Displays the Sensor In information.	
	 Sensor In 01	Displays the ON/ OFF condition of the connected sensor.
	 Sensor In 01 Relay Output 03	Displays the relay output condition for the selected sensor input.
 Sensor In 02	Displays the camera condition for the selected sensor input.	
	Displays the Relay output information.	
	 Relay output 02	<p>You can control the relay output using the mouse button.</p> <ol style="list-style-type: none"> 1. Click the right mouse button on the relay output. 2. Select the ON or OFF option. 3. The selected relay is activated or deactivated.

Instant playback

It is possible to play a recorded image without stopping recording.

1. Select the [Camera View] tab in the live mode.
2. Select a channel you want to playback.
3. Select the date.
The day is displayed in a blue text when recorded data exists.
4. Select playback start time.
When using timeline to search a start time, use the zoom in/out icons for more detailed searches (4 step).
5. Select playback speed. Use the slider to select the playback speed.
6. Start playback using these control buttons.





	Click this button to jump to the beginning of the data.
	Click this button repeatedly to play frame-by-frame playback in reverse.
	Click this button to play reverse or normal playback.
	Click this button to pause playback.
	Click this button to stop playback.
	Click this button repeatedly to play frame-by-frame playback.
	Click this button to jump to the last 1 minute of the data.
	Click this button to switch the speaker on and off for the computer. The speaker button is activated when the playback speed option is set to "1" and the live window is set to 1 division mode.
	The microphone icon is not activated in playback mode.

NOTE

- If you don't want to play with sound, click the speaker icon to mute.
- If you want to play with sound, the live window have to be set to 1 division mode.
- This function is permitted for Administrator group and other group users who have the Search/Play authority.

Two-way audio controls

Two-way audio function is for transmitting and receiving audio streams simultaneously in both directions. You can transmit audio to the camera by connecting an microphone of the computer. You can also play received audio from the camera via a connected speaker on the computer. These buttons are activated only when the live window is set to 1 division mode.

	ON	Click this button to switch the speaker on and off for the computer.
	OFF	
	ON	Click this button to switch the microphone off and on for the computer.
	OFF	











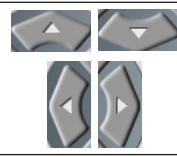

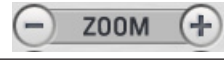
Pan/Tilt/Zoom Tab

You can control the PTZ cameras via the network.

1. Select the PTZ camera channel window in the camera view mode.
2. Select the Pan/Tilt/Zoom tab.
3. Use virtual remote control buttons to control the PTZ camera.

NOTE

- If someone is controlling a PTZ camera using the DVR, you cannot use the PTZ function and vice versa.
- This function is permitted for Administrator group and other group users who have the PTZ authority.

Button	Function
	Use to pan/tilt the camera.
	Confirm the preset position.
	Select the Pan/Tilt/Zoom speed.
	To adjust the camera zoom.
	To manually adjust the focus of a camera.
	To manually adjust the iris of a camera.
	Displays the Selected Preset number.
	To input the preset number.
	To register preset positions.
	To move the camera to the preset position.
	To delete a memorized preset position.
	To start a preset tour.
	To display the setup menu of the PTZ camera.

Preset Settings

Preset position is the function to register camera monitoring positions (preset positions) associated with position numbers. By entering the position numbers, you can move cameras to the preset positions.

NOTE

To activate this function, you need to register the preset positions of the PTZ cameras.

To Register Preset Positions

1. Move the camera to a point you wish.
2. Click the [SET] icon.
3. Select the preset number you wish to register.
4. Click the  icon.
The position and its number are memorized.
5. Repeat steps 1 to 4 to add additional positions.

NOTE

Preset numbers from 0 to 255 are available on this unit but the actual preset range differs depending on PTZ cameras.

Changing to a Picture in a Preset Position

The following function is available only with cameras provided with the preset function. The preset function makes the combination camera move to the programmed preset position. It is necessary to program preset positions for the combination camera beforehand.

1. Click the [MOVE] icon.
2. Use number buttons to enter the memorized preset position's index number then click the  icon. The camera moves to the preset position and the picture of the camera in that position appears on the monitor.

To Clear the Preset Position

You can clear a memorized preset position.

1. Click the [CLEAR] icon.
2. Use number buttons to enter the memorized preset index number then click the  icon to clear the preset positions.

NOTE

This function may not be available depending on PTZ cameras.

To Tour The Preset Positions

You can tour all preset positions.

1. Click the [TOUR] icon.
All registered preset positions in the camera will be selected and the camera position image will be switched on the active monitor.
2. You can stop the tour by clicking the [TOUR] icon.

Setup for PTZ Cameras

You can adapt the camera to your requirements by setting up the respective items in menus.



1. Click the [SETUP] icon.
The setup menu appears in the selected window.
2. Use arrow and  buttons to set the options.

NOTE

- Refer to the manuals of the PTZ camera for more details.
- Some PTZ cameras may not be operated correctly with this program.

Log View Tab

You can see the system log list of selected site name.

1. Select the [Log View] tab.
2. Click the  icon and select the day.
(The selectable days are displayed in blue color.)
3. Click the  icon.
The system log is displayed in the list.



Favorites Tab

You can save the current configuration of camera view. This favorite setup is useful for the next time to display it.

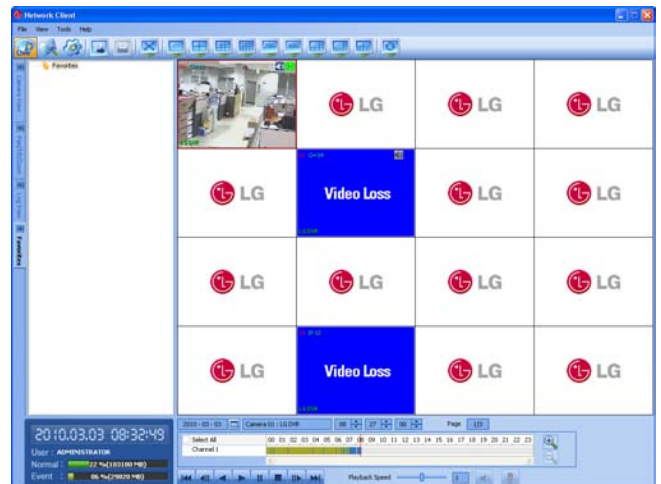

Add the favorite

1. Select the [Favorites] tab.
2. Select the [Favorites] option and click the right mouse button.
3. Select the [Add favorite] option. The Add Favorite window is displayed.
4. Enter the favorite name and click the [OK] button.
The entered favorite name is displayed under the Favorites option.

Edit the favorite

1. Select the registered favorite name and click the right mouse button.
2. Select the [Edit Favorite] option. The Edit Favorite window is displayed.
3. Overwrite the existing name with a new name.
4. Click the [OK] button to confirm it.

Delete the favorite

1. Select the registered favorite name and click the right mouse button.
2. Select the [Delete Favorite] option. The selected favorite name is deleted.

Using the Search function

Date/Time Search Tab

Use to search a recorded picture by specifying date, hour and minute.

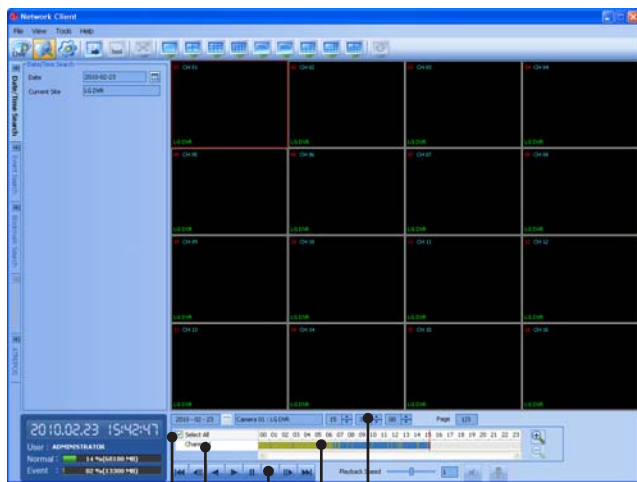

Time input column
 Time line
 Playback control buttons
 Displays selected channel number.
 Mark up when you want to view from all camera channel windows.

1. Select the [Date/Time Search] tab.
2. Click the [Calendar] icon and select the day. (The selectable days are displayed in blue color.)
3. Select the channel window you want to view.
4. Select the time using the Time line and Time input column to search recorded data.
5. Play the searched data using the playback control buttons.

Event Search Tab

Search a recorded picture by date and event type.

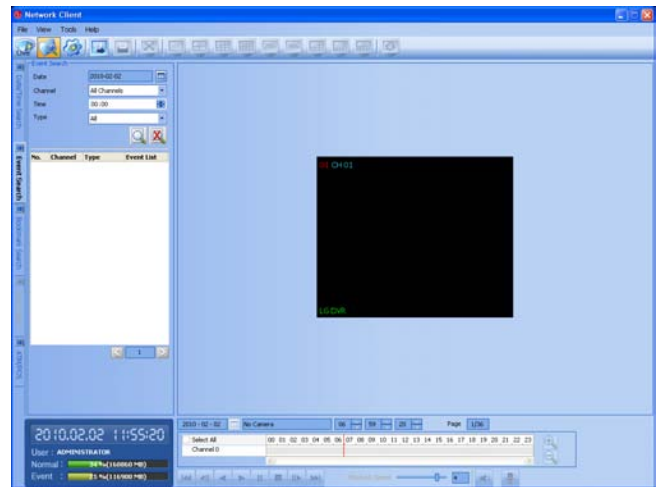

1. Select the [Event Search] tab.
2. Click the [Calendar] icon and select the day. (The selectable days are displayed in blue color.)
3. Select the camera channel for event search.
4. Select the start time.
5. Select the event type.
6. Click the [Search] icon. The event list is displayed.
7. Select the event from the event list.
8. You can play the searched data using the playback control buttons.

Bookmark Search



Search the desired picture with a registered bookmark using the bookmark function.

1. Select the [Bookmark Search] tab.
2. Click the [Search] icon. All bookmark data is displayed in the list.
3. Select the data in the list.
4. Play the searched data using the playback control buttons.

ATM/POS Search Tab

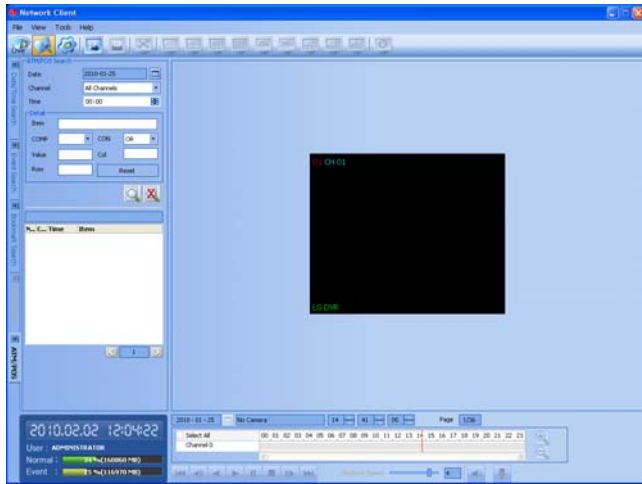
Search the recorded text information by ATM/POS device. This function is available with backup data of the internal or external HDD only.



1. Select the [ATM/POS Search] tab.
2. Click the  icon and select the day. (The selectable days are displayed in blue color.)
3. Select the camera channel for event search.
4. Select the start time.
5. Set the detail search options.
 - Item: Enter the text to search what you want.
 - COMP: Select the compare symbol for number search.
 - CON: Select the Boolean operator when you use the Text search and Number search function simultaneously.
 - Value: Enter the number to search what you want.
 - Col: Enter the column.
 - Row: Enter the row.
 - Reset: Reset all items.
6. Click the  icon.
7. Play the searched data using the playback control buttons.

Using the Remote Setup function

You can set the DVR configuration of a selected site name using this function.

System settings

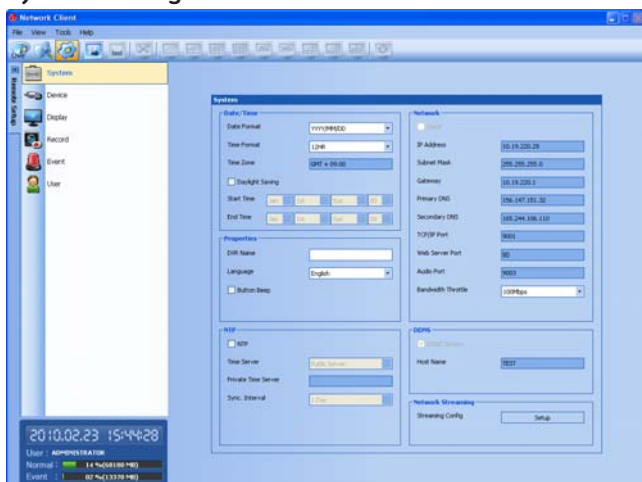

Date/Time

- Date Format: Select the date display format.
- Time Format: Select the time display format.
- Time Zone: This option setting is not available in the client program.
- Daylight Saving: Mark up when you use the daylight saving function.
- Start Time: Select the Daylight Saving start time.
- End Time: Select the Daylight Saving end time.

Properties

- DVR Name: Enter the DVR name using up to 20 characters.
- Language: Select a language for the setup menu and information display of the DVR.
- Button Beep: Marks up to activate the button beep. The button beep is activated when using the buttons.

NTP

- NTP: Marks up, if you want to synchronize the DVR's date and time with those of the time server called NTP (Network Time Protocol) Specify the NTP server's name.
- Time Server: For most cases select public. The DVR will obtain the average time among 5 public servers (time.nist.gov, time-a.nist.gov, time-b.nist.gov, ntp.nasa.gov, clock.isc.org).
- Private Time Server: Enter the private time server's IP address or host name.
- Sync. Interval: You can set synchronized intervals with the NTP time server to 1 day, 1 hour, 1 month and 1 week.

Network

These option settings are not available in the client program except the [Bandwidth Throttle] option.

- Bandwidth Throttle: Enter the Bandwidth to adjust the data traffic.

DDNS

These option settings are not available in the client program.

Network Streaming

1. Click the [Setup] button to display the Network Streaming configuration window.
 - Ch: Displays the channel number.
 - Resolution: Selects the recording resolution. Each group such as "Ch1 to Ch8" and "Ch9 to Ch16" are set the same resolution.
 - Quality: Selects the recording picture quality.
 - Frame Rate: Selects the frame rate. The frame rate is the number of transportable frames per second. According to resolution, the frame rate is set automatically. If you wish to set manually, refer to the below.

	Resolution	Frame Rate
NTSC	352*240	1, 3, 5, 7.5, 10, 15
	704*240	1, 3, 5, 7.5
	704*480	1, 3
PAL	352*288	1, 3, 5, 6, 7.5, 12.5
	704*288	1, 3, 5, 6
	704*576	1, 3

2. Click the [OK] button to confirm the settings.

Device settings

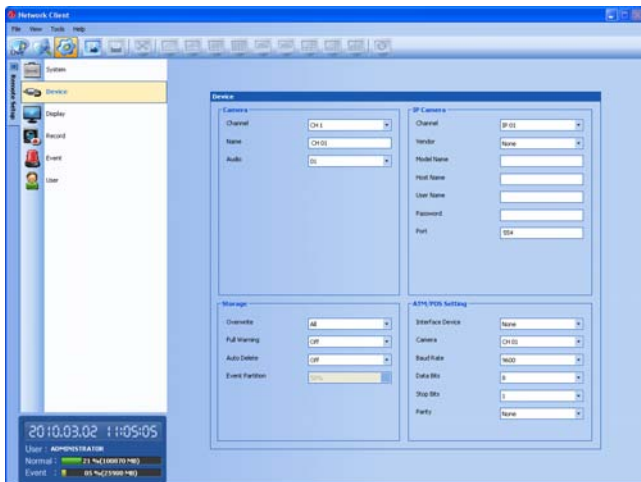

Camera

- Channel: Select the channel number.
- Channel Name: Enter the channel name using up to 20 characters.
- Audio: Select the input audio channel. You can hear from the selected input audio channel. This function is not available for IP channels.

IP Camera

- Channel: Selects the desired channel to set the connected IP camera.
- Vendor: Selects the IP camera vendor from the drop-down list.
- Model Name: Enter the model name of the IP camera.
- Host Name: Enter the IP address of the IP camera.
- User Name: Enter the user ID.
- Password: Enter the user password.
- Port: Enter the port number.

ATM/POS Setting

- Interface Device: Select the interface device from the drop-down list.
- Camera: Select the camera number for mapping with ATM/POS device.
- Baud Rate: Select the desired parameter to set the communication speed between DVR and ATM/POS device.
- Data Bits: Select the number of the data bits for RS-485 communication.
- Stop Bits: Select the desired parameter. The stop bit, added to the last of data, in asynchronous communication.
- Parity: Select the desired parameter. The parity bit, added to the data, to perform parity check.

Storage

- Overwrite:
 - All: Overwrite recording is possible when the normal partition and event partition of HDD have fully recorded.
 - Normal Partition: Overwrite recording is possible for normal partition of HDD when the normal partition of HDD has fully recorded.
 - Event Partition: Overwrite recording is possible for event partition of HDD when the event partition of HDD has fully recorded.
 - Off: Do not use overwriting.

- Full Warning: When the HDD has overflowed a warning message is displayed.
- Auto Delete: Set the auto delete date. If you set the auto delete date, the recorded data will be deleted except the data within the selected date period of time. The Auto Delete function is activated every 35 minutes.
- Event Partition: This option setting is not available in the client program.

Display settings

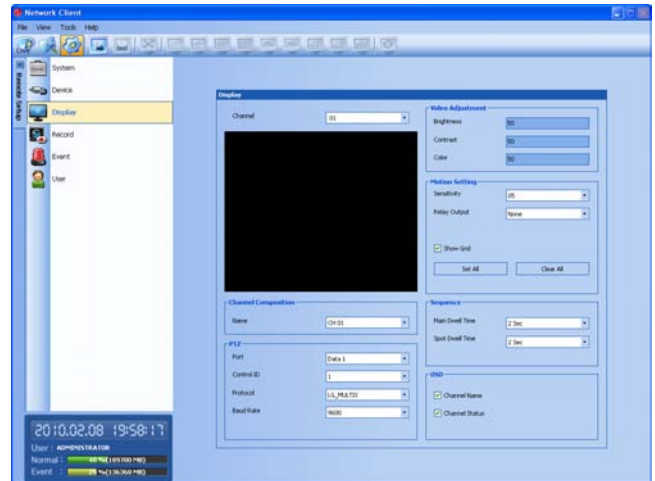

- Channel: Selects the desired channel to adjust.

Channel Composition

- Name: Selects the desired channel.

PTZ

Settings for the PTZ cameras connected via the data port of the RS-485 terminal.

- Port: Selects the connected data port of the RS-485 terminal on the rear panel. The DATA 2 port is used to control the PTZ camera connected to DVR or to control by using the LKD1000 controller. If you want to use the PTZ camera via DATA 2 port, you should set the [Remote Controller ID] to [NONE]. If you use the LKD1000 controller to control the DVR via DATA 2 port, you should set the [Remote Controller ID] number between 1 to 16.
- Control ID: Selects the PTZ camera ID. Make the same settings as the PTZ camera.
- Protocol: Selects the protocol supported by PTZ camera.
- Baud Rate: Selects the communication speed.

Video Adjustment

Adjust the brightness, contrast and color settings of each camera channel. You can see the settings screen from the preview windows.

- Brightness: Adjust the brightness value from 0 to 100 for the selected channel.
- Contrast: Adjust the contrast value from 0 to 100 for the selected channel.
- Color: Adjust the color value from 0 to 100 for the selected channel.

Motion Settings

- Sensitivity: Set the sensitivity level for the created motion detection area.
- Relay Output: Select the number of the RELAY-OUT terminal for the output alarm (relay) signal when motion is detected.
- Area: The factory default of the Motion detection area is set as the whole area. You can change the area by using mouse on the preview window screen.
 - Select area: Click one point with the left mouse button and drag & drop to the end point.
 - Clear area : Click the start point with the right mouse button and drag & drop to the end point.

NOTE

- If you want to display the grid, mark up the [Show Grid] option.
- If you want to select the entire area, click the [Set All] button or click the [Clear All] button to cancel the selected area.

Sequence

View all the channels in sequence in the selected screen division mode. You cannot use sequence mode with the 16 split (LE5008/LE4008 series: 8 split). While the sequence mode condition, if you change the screen division mode, the sequence function will be canceled.

- Main Dwell Time: Selects the channel sequence time for main monitor.
- Spot Dwell Time: Selects the channel sequence time for spot monitor.

OSD

- Channel Name: Mark up to displays or removes the channel name in the channel window.
- Channel Status: Mark up to displays or removes the channel status in the channel window.

Record settings

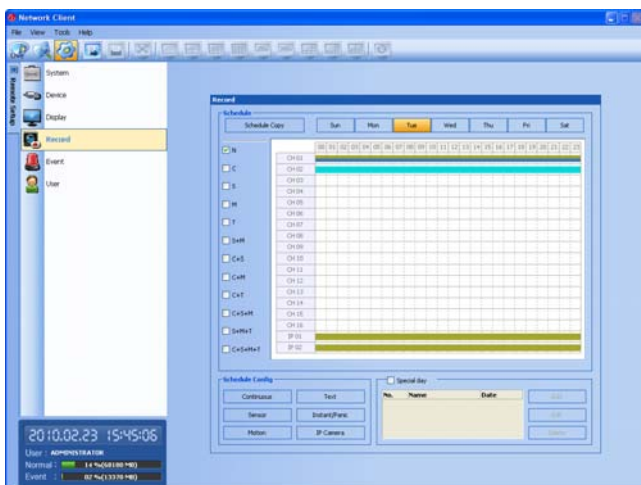

1. Select a day of the week.
2. Mark up the desired recording option.
 - N : No schedule recording.
 - C (Continuous recording): Recording starts automatically from the preset time.
 - S (Sensor event recording): Recording starts automatically

when the sensor alarm is occurs within a designated time.

- M (Motion event recording): Recording starts automatically when motion is detected within a designated time.
- T (Text event recording): Recording starts automatically when text input is detected within a designated time.
- S+M (Sensor+Motion recording): Recording starts automatically when the sensor alarm signal has input or motion has been detected.
- C+S (Continuous+Sensor event recording): Recording starts automatically from the preset time. When the sensor alarm occurs within a designated time, change the continuous recording mode to sensor event recording mode and recording starts automatically.
- C+M (Continuous+Motion event recording): Recording starts automatically from the preset time. When the motion is detected within a designated time, change the continuous recording mode to motion event recording mode and recording starts automatically.
- C+T (Continuous+Text event recording): Recording starts automatically from the preset time. When the text input occurs within a designated time, change the continuous recording mode to text event recording mode and recording starts automatically.
- C+S+M (Continuous+Sensor+Motion event recording): Recording starts automatically from the preset time. When the sensor alarm signal has input or motion has been detected, change the continuous recording mode to motion event recording mode and recording starts automatically.
- S+M+T (Sensor+Motion+Text event recording): When the sensor alarm signal has input, motion has been detected or the text input occurs and then recording starts automatically.
- C+S+M+T (Continuous+Sensor+Motion+Text event recording): Recording starts automatically from the preset time. When the sensor alarm signal has input, motion has been detected or the text input occurs within a designated time, change the continuous recording mode to occurred event recording mode and recording starts automatically.

3. Select the desired channel to schedule recording.
4. Click the start time cell block and drag & drop to select a time period cell block.

or

Click the start time cell block of a channel and drag & drop across the channels to select the time period block for multi-channel setting at the same time. The color of the cell blocks will change.

Schedule day copy settings

1. Select the source day to copy.
2. Click the [Schedule Copy] button to display the schedule copy setup window.
3. Select the destination day from the day of the week, weekday or weekend options.
4. Click the [Copy] button on the Day Copy option to copy the scheduled data of the day.

Schedule channel copy settings

1. Select the day.
2. Click the [Schedule Copy] button to display the schedule copy setup window.
3. Select the source channel.
4. Select the destination channel.
5. Click the [Copy] button on the Channel copy option to copy the scheduled data of the channel.

Schedule Configuration Settings

1. Click the one of the buttons to display the recording setting window.
2. Set the detail options.
3. Click the [OK] button to confirm the settings.

To add the Special day

1. Mark up the [Special day] option.
2. Click the [Add] button.
3. Enter the name of the special day.
4. Select the date to set the special day schedule and click the [Add] button. The special day is added to the list.
5. Mark up the desired recording option.
6. Set the schedule time for each channel(s).

To edit the Special day

1. Select a special day title on the list.
2. Click the [Edit] button.
3. Select the date to change the special day schedule and click the [Edit] button.
4. Change the schedule time for each channel(s).

To delete the Special day

1. Select a special day title on the list.
2. Click the [Delete] button.

Event Settings

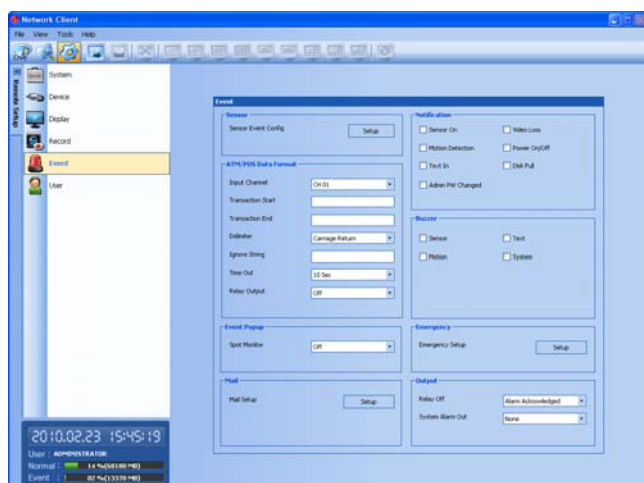

Sensor

1. Click the [Setup] button.
2. Set the below options.
 - Sensor: Displays the number of the ALARM-IN terminal.
 - Sensor Type: The sensor state can be set to either N.O. (Normally Open) or N.C. (Normally Closed).
 - Linked Camera: Select the connected camera channel to the ALARM-IN terminal.

- Relay Output: Select the alarm (relay) output number for the RELAY-OUT terminal for the output alarm (relay) signal.
 - Preset: Select the preset number. When the input is activated, the camera moves to the selected preset position and the picture of the camera in that position appears on the monitor.
3. Click the [OK] button to confirm the settings.

ATM/POS Format

The DVR can be set to react to text input from devices such as ATMs (Automated Teller Machines) and POS (Point of Sale; i.e., cash registers). This screen allows you to configure the DVR for your input device.

- Input Channel: Select the mapping camera channel.
- Transaction Start: Enter a Transaction Start string. Refer to the device manufacturer's documentation for the text string that the device first sends when a transaction starts.
- Transaction End: Enter a Transaction End string. Refer to the device manufacturer's documentation for the text string that the device sends when a transaction ends.
- Delimiter: Enter the character(s) that the device uses to indicate the end of a line. Refer to the device manufacturer's documentation for Line Delimiter character(s).
- Ignore String: Enter the any strings of text that you want the DVR to ignore. Refer to the device manufacturer's documentation for text strings that the device sends during transactions, so you will know which ones you do not want recorded.
- Time Out: Select the Recording end time.
- Relay Output:
 - 01 to 04: Outputs the alarm (relay) signal via the RELAY-OUT terminal. When the DVR detects text input, it triggers output signals on all the associated Alarm-Out connectors.
 - Off: Not used.

NOTE

ATM/POS Recording Information.

Option setting	ATM/POS Recording Action
When the Transaction Start and Transaction End options are set.	Recording is started automatically when the Transaction start data is detected. When the Transaction end data is detected the recording is stopped after post-alarm time.
When the Transaction Start and Transaction End option is not set.	Recording is started automatically when the transaction data is detected. When the transaction data is not detected the recording is stopped after post-alarm time and the time you set of the Time Out option.

Event Popup

- Spot Monitor: Select the event type for the spot monitor display when the event is activated.

Mail

1. Click the [Setup] button.
2. Set the below options.
 - Notification: Marks up to notify the unit operating information according to notification settings by e-mail. If notification option is not set, the other options cannot be set.
 - SMTP Server: Enter the SMTP Server address.
 - SMTP Port: Enter the SMTP Port Number. Typically the port used for SMTP is 25. However in some cases it is better to change this port number for added flexibility or security. You can edit this port between 1 and 65 535.
 - User Name: Enter the user name.
 - Password: Enter the password.
 - TLS: Marks up when using the TLS (Transport Layer Security) function.
 - Mail Address (1 to 3): Enter the mail address. You can input up to 3 e-mail addresses.



NOTE

The SMTP Server, SMTP Port, user name or password settings are optional. The DVR can send e-mail directly without the use of an SMTP server or MTA (message transfer agent). In certain cases all e-mail should be forwarded to a specific SMTP server. Specify the server host name or IP address in such a case. For more detail on SMTP setup, ask your network administrator and/or mail service provider.

3. Click the [OK] button to confirm the settings.

Notification

Marks up when you want to activate the selected option. If the selected notification option is activate, notify the user about the information of selected option by E-mail.

- Sensor On: Sends an e-mail when a sensor has occurred.
- Motion Detection: Sends an e-mail when an motion detection has occurred.
- Text In: Sends an E-mail when the text input is detected.
- Admin PW Changed: Sends an e-mail when the administrator password has changed.
- Video Loss: Sends an e-mail when a video signal from the camera has stopped because of a cable disconnection or malfunction of a camera.
- Power On/Off: Sends an e-mail when power is on or off.
- Disk Full: Sends an e-mail when the HDD has fully recorded.

Buzzer

Marks up when you want to activate the selected option.

- Sensor: Makes a sound when a sensor occurs.
- Motion : Makes a sound when a motion is detected.
- Text: Makes a sound when the DVR detects text input .
- System: Makes a sound when a cooling fan is not activated or the HDD has bad sector.

Emergency

1. Click the [Setup] button.
2. Set the below options.
 - Notification: Marks up to notify the emergency agent about unit operating information according to your notification settings.
 - Host Name/Port: Enter the Host Name and port number of the emergency agent program. The factory default port for this function is 9002. However in some cases it is better to change this port number for added flexibility or security. You can edit this port between 1 025 and 65 535. You can set up to 9 Host Name and port numbers.
3. Click the [OK] button to confirm the settings.

Output

- Relay Off
 - Alarm Acknowledged: Use the ALM.OFF button to stop alarm.
 - Post Alarm Time: The alarm is stopped after post-alarm time.
- System Alarm Out: Outputs the alarm (relay) signal via the selected alarm out terminal number below cases. If you do not use this function, select [None] option.
 - When the HDD has a bad sector.
 - When a video signal from the camera has stopped because of a cable disconnection or malfunction of a camera.

User Settings

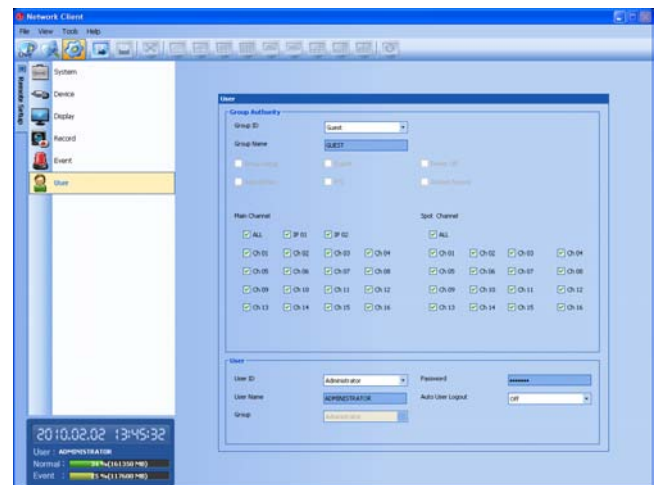

Group Authority

You can register a new user group with various access rights.

- Group ID: Select the group ID to assign authority.
 - Guest: The GUEST group has the limited authority of the system. Users in this group are available to see the live image and to set the covert function of the Main or Spot channel.
 - Administrator: The ADMINISTRATOR group has the unlimited authority of the system. Users in this group are available to use all of the functions.
 - [Group 01] to [Group 08]: Users in this group are available to set the authority of the function manually.



NOTE

The GUEST and ADMINISTRATOR group are set initially for the authority of all functions. You cannot change the initial settings and group name (GUEST and ADMINISTRATOR).

- Group Name: If you select a one of the group number from the Group ID option, you can register the group name. Enter the group name.
 - Group Setup, Search/Play, Export, PTZ, Power Off, Instant Record: Set the authority for the selected group. Marks up the option to activate it.
- Main Channel/Spot Channel: Selects the channel to allow the operation for the group user. The LG logo is displayed on the covert channel(s).

User

1. Select the [User ID] from the drop-down list.
2. Enter the user name of the selected user ID.
3. Select the user group from the drop-down list.
4. Enter the Password.
5. Select the auto user logout time from the drop-down list.

NOTE
 If you set the user ID to [ADMINISTRATOR], you cannot change the [User Name] and [Group] option but you can change the password.

Using the Export function

You can copy the recorded images and audio data from the DVR unit to the PC. This function is permitted for Administrator and other group users who have the Export authority.

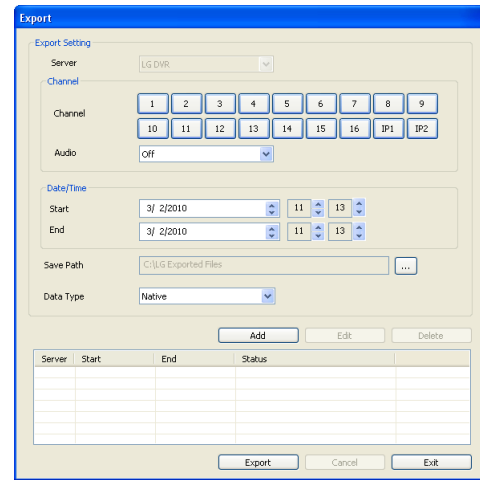

- Server: Displays the selected server name.
- Channel: Select a channel(s) to export the data.
- Audio: Set to On or Off to export the audio data.
- Start: Set the start date/time to copy.
- End: Set the end date/time to copy.
- Save Path: Displays the current exported data save folder. You can select (or make) the folder on the computer to save the exported data. The initial save folder is "C:\LG Exported Files". If you want to change the storage folder, click the [...] button and select the new folder.
- Data Type: You can select the saving file format between "Native [*.exp]" and "AVI". The Native file is saved with the extension of "*.exp" and the AVI file is saved with the extension of "*.avi". The saved "*.exp" file can playback using the Export Viewer program and "*.avi" file can playback using the Windows Media Player or the other ".avi" file player.
- Add: Add the export setting schedule to the list.
- Edit: Edit the selected export setting on the list.
- Delete: Delete the selected export setting schedule from the list.
- Export: Click to start export the data of the selected export setting.
- Cancel: Click it to cancel data exporting.
- Exit: Click to exit the window.

How to export the data

1. Set the Channel options. You have to select more than one channel.
2. Select the audio option.
 - On: Select when the Audio data is exported.
 - Off: Select when the Audio data is not exported.
3. Set the Date/Time options.
4. Select the folder on the computer to save the exported data.
5. Select the data type.
6. Click [Add] button. Listing the configured server, start time, end time and Status.
7. Select the registered export setting schedule in the list.
8. Click the [Export] button to begin the export. The export status will be displayed on the Status column.

NOTE

- The exported data file name is made automatically as the [Server name_Channel number_export start time.exp(or "avi")] type.
- If you do not assign the export directory, the export directory will be set to default directory and sub directory will be created with start date.
- If you log-out from the network client, the export sequence will be terminated.
- If you set the time for data that does not exist, the export function is not activated.
- The warning message appears for the conditions listed below.
 - When the start date/time and end date/time are the same.
 - When the start date/time is later than the end date/time.
 - When the channel is not selected.

Using the E-Map function

This function gives a visual overview of the cameras in your surveillance environment.

E-Map Overview

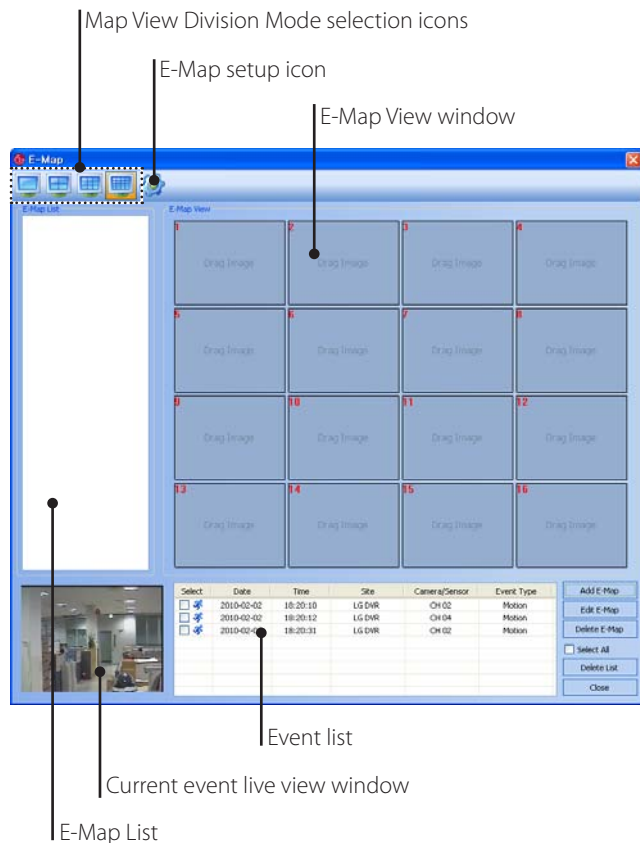

- Map View Division Mode selection icons: When the icon is clicked, the screen will be changed to split mode. Choose the Map View division mode.
- E-Map setup icon: Click to set the operation time.
- E-Map List: Displays the imported E-Maps.
- E-Map View window: Displays the registered E-Maps.

Add the Map

1. Click the [Add E-Map] button. The Add E-Map window is displayed.
2. Click the [...] button in the [E-Map path] option.
3. Find and open the map image file. If you want to change the E-Map name, select the [E-Map Name] option and overwrite the existing name with a new name.
4. Drag-and-drop camera channel or sensor on the Map.

NOTE

To delete the registered camera or sensor, follow these steps:

- 4.1 Select the camera or sensor.
 - 4.2 Click right mouse button on the selected camera or sensor.
 - 4.3 Select [Delete] option to delete it.
5. Click the [OK] button to save settings and close the window.
 6. Repeat steps 1 to 5 to add the other E-Maps up to 16.

Activate the Map

1. Select the required E-Map from the E-Map List.
2. Drag and drop the E-Map on the required position of the E-Map View window.
3. Repeat steps 1 to 2 to activate the other E-Maps.

Edit the Map

1. Select the required E-Map from the E-Map View window.
2. Click the [Edit E-Map] button. The E-Map View window is displayed.
3. Edit the camera position, E-Map name or delete the camera.
4. Click the [OK] button to save E-Map and exit the window.

Delete the Map

1. Select the required E-Map from the E-Map List.
2. Click the [Delete E-Map] button. The selected E-Map is deleted.

Delete the event

1. Select the event in the event list.
2. Click the [Delete List] button to delete the event.
If you select the [Select All] option, all events are deleted.

Additional Programs

Emergency Agent Program

The system sends a message according to the Notification and Emergency settings in the event setup menu.

Emergency Agent Overview

Display the received message list.

Detailed view of the received message.

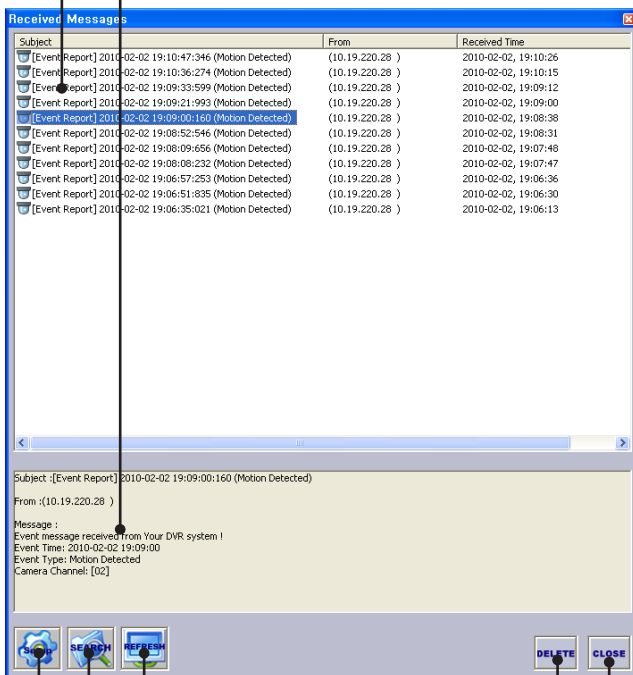

Deletes the selected message from the list.

Closes the [Received Messages] window.

Refreshes the received message on the list.

Displays the search window.

Displays the port change window.

To activate the Emergency Agent program

1. Run the [LG Emergency Agent] program. The Emergency icon is displayed in the system tray.
2. Whenever a notification function occurs, a message box is displayed on the bottom right of the screen. The message box is displayed for 5 seconds.
3. Check the message.
4. Click the message box within 5 seconds to display the [Received Messages] window.
 - or
 - Right click the mouse on the program icon in the system tray and select the [Check Message Box] option to display the [Received Messages] window.
5. You can check all the subjects of received messages.
6. Click the [CLOSE] button to close the [Received Messages] window.

Port Setting

1. Click the [Setup] button. The option window is displayed.
2. Enter the port number of the emergency agent listening port. The factory default port is 9002. However in some cases it is better to change this port number for added flexibility or security.
3. Click the [OK] button to exit.

Message Search

1. Click the [SEARCH] button. The message search window is displayed.
2. Select the search method.
 - Event Search: Search by selected type of event for the message.
 - Date Search: Search by selected date.
3. Click the [Search] button. The search message is displayed on the [Received Messages] window.

Delete the Message from the List

1. Select the message(s) you want to delete.
2. Click the [DELETE] button. The confirmation window is displayed.
3. Click the [Yes] button to delete the message(s).

Export Viewer Program

You can playback from the export data on the PC using this program. The export viewer program is saved automatically when you install the client program or export the data.

Export Viewer Overview

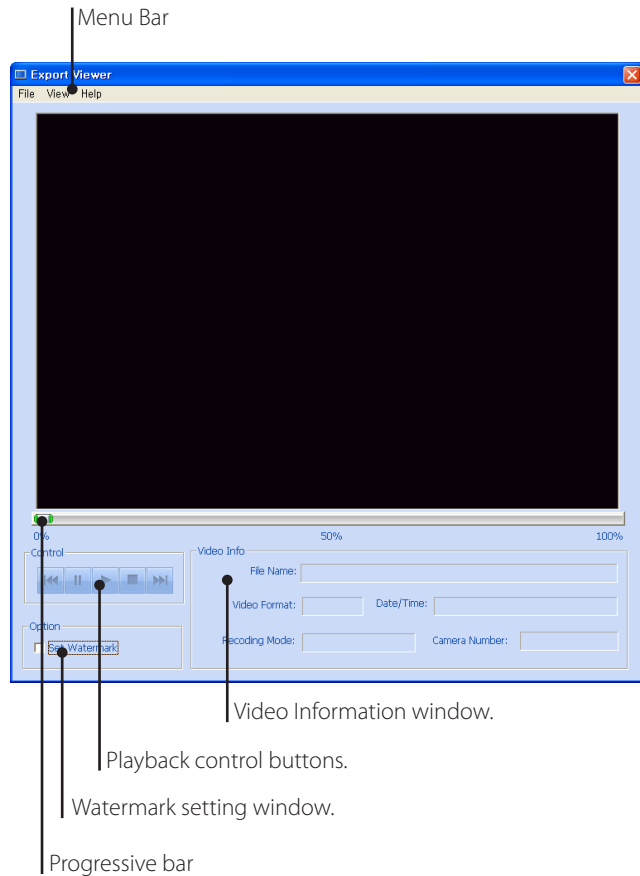

Menu Bar

Menu	Sub-Menu	Description
File	Open	Open the data file.
	Print	Prints the current playback image.
	Save to JPEG	You can capture and save the current image in JPEG file format. 1. Play the recorded data. 2. Pause the playback at a desired point during playback. 3. Select this option. The JPEG Export window is displayed. 4. Set the options. 5. Click the [Save] button.
	Exit	Exit the program.
View	Language	Select the language for Export Viewer program.
	Video Size	Select the video size of the data file.
Help	About Export Viewer	Displays Export Viewer information.

Playback control buttons

	Jumps to the beginning of the file.
	Pauses playback.
	Starts playback.
	Stops playback.
	Jumps to the end of the file.

Watermark Setting window

The warning window will appear with watermark option, if the file which is in playback differs from the file that is originally recorded.

Video Information window

- File Name: Displays the file name.
- Video Format: Displays the video type of the data.
- Date/Time: Displays the recorded date and time of data.
- Recording Mode: Displays the save mode of the data.
- Camera Number: Displays the camera channel number of recorded data.

To play the exported data

1. Run the LG Export Viewer program on the PC or in the Export Viewer folder of the external USB device. If you insert the exported data CD or DVD disc, the export viewer program run automatically.
2. Select [File] > [Open]. The open window is displayed.
3. Select the root directory of the USB device and search&select the desired file. An example of playable file format is "Channel name_date_time.exp".
4. Click the [Open] button. The selected data is played back automatically.
5. Click the [STOP] button to stop playback.

Progressive bar

You can search the image directly using the progressive bar. Click and hold the Slider bar and move to the other point you want and then release it. Or, Click the point on the progressive bar you want to playback.

Web Viewer Program

Logging in the Web Viewer









1. Start the web browser. The recommended browser is Internet Explorer with Windows.
2. In the Address Box, enter "HTTP:///" and the IP Address of the DVR. You can use the Host Name that you entered in the DDNS setup menu of the DVR.
3. Press the ENTER button on the keyboard and then the Web viewer and the Remote Login menu will be displayed.
4. Enter the User Name and Password.
5. Click the [OK] button.

NOTE

- If the Web Viewer is not displayed, check the TCP/IP settings of the DVR.
- If you connect the DVR for the first time, the Security Warning window is displayed. You must click [Install] on the Security Warning window to install the program for use the Web Viewer. If you click [Don't Install], the Web Viewer program is not available.

Web Viewer Overview

You can control the live image using the Web Viewer.

	Click to change into the Live View mode.
	Click to change into the PTZ View mode
	Click to display the WebViewer Control Properties pop-up windows.
	Click to display the Remote Export pop-up windows.
	You can view the live window in full screen mode. To return to the normal screen, click the right mouse button.
	Screen Mode selection icons.
	View all the channels in sequence. You cannot use sequence mode with the 16 split.
	You can capture and save the current image in JPEG file format. The initial save folder is "C:\LG Exported Files". If you want to change the storage folder, set the [Save Path] option on the WebViewer Control Properties Window. <ol style="list-style-type: none"> 1. Select the channel window. 2. Mark up the selected channel name. 3. Search the recorded data and then play the recorded data. 4. Click this button when you want to capture the current image.

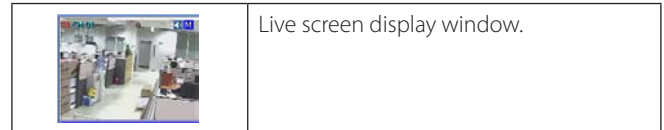

Live screen display window.

Live screen control

- Left mouse button: Select the channel. If you want to set the 1 split mode, double click the selected channel. To return to the normal screen double click again.
- Right mouse button: If you want to exit the full screen mode, right click the mouse to return to the normal screen.

PTZ View control

1. Click the [PTZ View] icon to change into the PTZ view mode. The PTZ virtual remote control is displayed.
2. Use virtual remote control buttons to control the PTZ camera.

Playback of Recorded Data

1. Select the camera's display window.
2. Select the date.
The day is displayed in a blue text when recorded data exists.
3. Select playback start time.
When using timeline to search a start time, use the zoom in/out icons for more detailed searches (4 step).
4. Select the channel you want to playback. If you check "Select All" option, you can playback the all channels simultaneously from all camera channel windows.
5. Select playback speed.
6. Start playback using these control buttons.

NOTE

This function is permitted for Administrator and other group users who have the Search/Play authority.

Using the WebViewer Control Properties window

1. Click the [Setup] button.
WebViewer Control Properties window is displayed.
2. Set the below options.
 - OSD: Mark up to display or remove the selected option in the channel window.
 - Sequence: Selects the channel sequence time.
 - Video Display: Marks up when using the DirectX function.
 - Snapshot Save Path: Displays the storage folder for the captured image file. If you want to change the storage folder, click the [...] button and select the new folder.
3. Click the [OK] button to exit.

6

Troubleshooting

Check the following guide for the possible cause of a problem before contacting service.

Symptoms	Resolutions
The system power does not turn on.	Check the power cable is connected correctly.
	Check the input voltage is correct.
	If the system power does not turn on even if the power cable is connected correctly, please contact the service center.
The system power is turned on but no video data is displayed on the monitor.	Check the monitor power cable is connected properly.
	Make sure the monitor is turned on.
	Check the video output cable of the LG DVR is properly connected to the monitor.
	Unplug the power cable and plug in again.
The camera numbers are displayed on the screen but the camera images are not displayed.	Check the camera video output is connected to the DVR system correctly.
	Check the power cable on the camera is connected correctly.
	Check there is no problem with the video cable connection from the camera to the LG DVR system.
	Turn off the DVR system and turn it on again.
The camera video is shown on the screen but the system does not record the video.	Check the recording mode in the record setting menu.
	Check the HDD detection status in the System Information window. If the HDD detection status is abnormal, check the HDD formatting and the connection of the HDD.
	Check the recordable disk space in the HDD.
	Check the overwrite option in the setup menu for overwrite recording.
It is impossible to search through the recorded video.	Check if there is recorded video data at the time that you are trying to search on the table.
	If there is no recorded video data, check the recording mode in the record setting menu.
	Check the HDD detection status in the system information window. If the HDD detection status is abnormal, check the HDD formatting and the connection of the HDD.
	Check the user type. The search function is not available for a normal user.

Symptoms	Resolutions
Audio data recorded with video data is not playing.	Check the audio recording option is correctly set for the camera you wish to record audio.
	Check the speaker and audio (line input) on the rear of system are connected correctly.
	Check the connected speaker is working properly.
The colors of some camera videos are strange or videos are displayed abnormally.	If the camera connected to the system has a problem, make sure that the camera is not damaged by trying another camera into a working video output.
	Check the video format setting of the unit is the same as the connected camera's video format. Depending on your region, the camera's video format can support either PAL or NTSC. Depending on the camera's video format, the video process can differ greatly, therefore it can be difficult to recognize the video data if the video format setting is different from the camera's video format.
There is a lot of (screen) noise accompanying the image.	Check if the video signal output from the camera has a problem. Ensure the camera is not damaged by trying another camera with a working video output.
	Check if the video cable connection between the camera and the DVR is cut, crosswired or shorted.
	Check if there is a high voltage wire around the video cable connection between camera and DVR system. It can cause interference and affect video quality.
	Check the video cable connection between the camera and the DVR system is the correct video cable. When a normal power-supplying cable is used instead of the video cable, screen noise can be generated.
The connected sensor is not operating.	Check the type of sensor in the camera setting is the same as with the connected sensor.
	Check the system is set to use the sensor in the recording schedule window in the recording setting menu.
	Check the sensor is properly connected to the ALARM-IN.
The connected PTZ camera is not operating.	Check the system is set to use the PTZ camera in the camera setting menu.
	Check the power cable of the PTZ camera is properly connected.
	Check the signal cable of the PTZ camera is properly connected.
	Check the selected channel to control the PTZ camera.
	Check the user type. The PTZ camera control is not available for a normal user.

Symptoms	Resolutions
An E-mail sent from this product was not received.	E-mail reception failed without SMTP server setting. <ul style="list-style-type: none"> • Make sure the network is correctly set. • Make sure the mail address is input correctly. • Check the spam mail setting of the inputted mail address. (If you set the spam mail, some mails are deleted automatically or classified in the spam mail box) • Some of SMTP mail services do not support an E-mails from private SMTP servers. In this case use the public SMTP server.
	E-mail reception failed even if the SMTP server was set. <ul style="list-style-type: none"> • When the [Please check the SMTP information or internet cable] message is displayed. <ul style="list-style-type: none"> - Check the SMTP server address. - Check the SMTP port number. (Default setting is 25). - Check the network settings. • When the [Please check the authentication information] message is displayed. <ul style="list-style-type: none"> - Check the user name. - Check the password. • The mail reception failed without error message. <ul style="list-style-type: none"> - Check the receiver's mail address. - Check your E-mail is not classified as a spam mail on the receiver's mail setting.
The remote control does not work properly.	Check the batteries in the remote control.
	Check the ID setting for the remote control (See the page 29).

NOTE
If you observe any of the following symptoms:

- Some of the front panel LEDs do not light.
- The DVR does not operate normally.

You can reboot the DVR as follows:

1. Turn off the DVR and turn it on again after a few seconds.
2. When the recorder does not work normally after rebooting, contact the service center.

7

Appendix

Recommended Devices

Recommended USB Memory list

No.	Maker	Model Name	Capacity
1	LG Electronics	XTICK Mini Slide / Slide	1 G/2 G/4 G
2	IOCELL	CellDisk Swing	1 G/2 G/4 G/8 G
3	Sony	MicroVault	1 G/2 G/4 G
4	HP	S100 / M100 / V210W	1 G/2 G/4 G
5	SANDISK	Cruzer Micro	512 M/1 G
6	TRANSCEND	JF	1 G/2 G
7	IMATION	Flash Drive Nano / Icon	1 G/2 G
8	Samsung Electronics	Classic&Simple	1 G/2 G/4 G/8 G



NOTE

Some USB memory devices other than the ones on the above table may not work properly, even if this DVR reads them.

Recommended External Device list

Device	Capacity	File system	Backup search function for the client program
USB HDD	Up to 1 TB.	FAT 32 (This file system is compatible with Windows and Linux system.)	Yes
E-SATA HDD	Unlimited.	EXT4 (Linux file system) This file system is not compatible with Windows system.	No

Recommended CD/DVD Media list

Maker	CD-R	CD-RW	DVD-R	DVD-RW	DVD+R	DVD+RW
Imation	○	○	○	○	○	○
Memorex	○	○	○	○	○	○
MITSUBISHI	○	○	○	○	○	○
PHILIPS	○	○	○	○	○	○
SONY	○	○	○	○	○	○
Verbatim	○	○	○	○	○	○



NOTE

8 cm (1.4 GB) Mini CD/DVD and the Dual Layer type media (DVD) are not supported.

Supported function list for device

Device	Instant backup	Schedule backup	Export	Configuration Import/Export
CD/DVD	O	X	O	X
USB memory	O	O	O	O
USB HDD	O	O	O	O
E-SATA HDD	O	O	O	O

! NOTE

If you use a USB memory stick or USB HDD for configuration import/export you must disconnect the other external USB devices.

Supported PTZ Camera list

Protocol Name	Maker	Pan/Tilt	Zoom	Focus	Iris	Preset	Tour	Setup
		Speed control						
LG_MULTIX	LG	YES	YES	YES	YES	YES	YES	YES
		YES	NO					
LG_MULTIX EXTENTION	LG	NO	YES	YES	YES	NO	NO	YES
		NO	NO					
LG_SD168	LG	YES	YES	YES	YES	YES	YES	YES
		YES	NO					
LG_LS903	LG	NO	NO	NO	NO	NO	NO	YES
		NO	NO					
LG_ZOOM	LG	No	YES	YES	YES	NO	NO	YES
		NO	NO					
LPT_A100L	LG	YES	NO	NO	NO	NO	NO	NO
		NO	NO					
PELCO_D	PELCO	YES	YES	YES	YES	YES	YES	YES
		YES	NO					
PELCO_P	PELCO	YES	YES	YES	YES	YES	YES	YES
		YES	NO					
GANZ_DSCP	CBC	YES	YES	YES	YES	YES	YES	YES
		YES	YES					
GANZ_P360V1	CBC	YES	YES	YES	YES	YES	YES	NO
		YES	NO					
GE KALATEL_CYBERDOM	KALATEL	YES	YES	YES	YES	YES	YES	NO
		YES	NO					
PANASONIC_CS850	PANASONIC	YES	YES	YES	YES	YES	YES	YES
		YES	NO					
BOSCH_AUTODOME	BOSCH	YES	YES	YES	YES	YES	YES	NO
		YES	YES					
SAMSUNG_SCC	SAMSUNG	YES	YES	YES	YES	YES	YES	YES
		YES	NO					

Time zones

Timezone name	Timezone Abbreviation	Timezone	DST
Eniwetok, Kwajalein	EK	-12:00	
Midway Island, Samoa	MIS	-11:00	
Hawaii	HAW	-10:00	
Alaska	ALA	-09:00	-08:00
Pacific Time (US and Canada); Tajuana	PST	-08:00	-07:00
Mountain Time (US and Canada), Chihuahua, La Paz, Mazatlan, Arizona	MST	-07:00	-06:00
Central Time (US and Canada), Saskatchewan, Guadalajara, Mexico City, Monterrey, Central America	CST	-06:00	-05:00
Eastern Time (US and Canada), Indiana (East), Bogota, Lima, Quito	EST	-05:00	-04:00
Atlantic Time (Canada), Caracas, La Paz, Santiago	AST	-04:00	
Newfoundland	NWF	-03:30	-02:30
Brasilia, Buenos Aires, Georgetown, Greenland	BBA	-03:00	
Mid-Atlantic	MAT	-02:00	
Azores, Cape Verde Islands	AZO	-01:00	
Greenwich Mean Time: Dublin, Edinburgh, Lisbon, London, Casablanca, Monrovia	GMT	0	+01:00
Amsterdam, Belgrade, Bratislava, Budapest, Ljubljana, Prague, Sarajevo, Skopje, Warsaw, Zagreb, Brussels, Copenhagen, Madrid, Paris, Berlin, Bern, Rome, Stockholm, Vienna, West Central Africa	AMS	+01:00	+02:00
Athens, Istanbul, Minsk	AIM	+02:00	+03:00
Bucharest, Cairo, Pretoria, Jerusalem, Harare, Pretoria	BCP	+02:00	+03:00
Helsinki, Riga, Israel, Kyiv, Sofia, Tallinn, Vilnius	HRI	+02:00	+03:00
Baghdad, Kuwait, Riyadh, Nairobi	BKR	+03:00	+04:00
Moscow, St.Petersburg, Volgograd	MSV	+03:00	+04:00
Tehran	THE	+03:30	+04:30
Abu Dhabi, Muscat, Baku, Tbilisi, Yerevan	ABT	+04:00	
Kabul	KAB	+04:30	
Ekaterinburg, Islamabad, Karachi, Tashkent	EIK	+05:00	
Bombay, Calcutta, Madras, New Delhi, Chennai, Kolkata	BCD	+05:30	
Almaty, Dhaka, Colombo, Astana, Sri Jayawardenepura, Novosibirsk	ADC	+06:00	
Bangkok, Hanoi, Jakarta, Krasnoyarsk	BHJ	+07:00	
Beijing, Changqing, Hong Kong, Urumqi	BHU	+08:00	
Perth, Singapore, Taipei, Beijing, Chongqing, Hong Kong SAR, Urumqi, Kuala Lumpur, Irkutsk, Ulaan Bataar	SST	+08:00	
Osaka, Sapporo, Tokyo	OST	+09:00	
Seoul, Yakutks	SYA	+09:00	
Adelaide, Darwin	ADA	+09:30	
Brisbane, Guam, Port Moresby	BGP	+10:00	
Canberra, Melbourne, Sydney	CMS	+10:00	
Hobart, Vladivostok	HVL	+10:00	
Magadan, Solomon Islands, New Caledonia	MSN	+11:00	+12:00
Auckland, Wellington	AWE	+12:00	
Fiji Islands, Kamchatka, Marshall Islands	FKM	+12:00	

Factory Default Configuration Settings

1st level	2nd level	3rd level	Default Setting	Factory Default setting
System	Properties	DVR Name	NULL	YES
		Language	The option depends on the model.	YES
		Button Beep	OFF	YES
		Video Format	NTSC or PAL	NO
		Configuration Import	-	-
		Configuration Export	-	-
		Factory Default	-	-
	Network	DHCP	ON	YES
		IP Address	NULL	YES
		Subnet Mask	NULL	YES
		Gateway	NULL	YES
		Primary DNS	NULL	YES
		Secondary DNS	NULL	YES
		TCP/IP Port	9001	YES
		Web Server Port	80	YES
		Audio Port	9003	YES
		Bandwidth Throttle	100 Mbps	YES
	Network Streaming	Ch	-	-
		Resolution	352X240 (NTSC)/352X288 (PAL)	YES
		Quality	STANDARD	YES
		Frame Rate	15 (NTSC)/12.5 (PAL)	YES
	DDNS	DDNS Service	OFF	YES
		Host Name	NULL	YES
		Registered Host	NULL	YES
		Update	-	-

	Date/Time	Date	(2010.01.01)	NO	
		Time	Current Time	NO	
		Date Format	YYYY/MM/DD	YES	
		Time Format	12 HR	YES	
		Time Zone	The option depends on the model.	NO	
		Daylight Saving	OFF	NO	
		Daylight Saving Start	JAN, 1st, SUN, 00	NO	
		Daylight Saving End	JAN, 1st, SUN, 00	NO	
	NTP	NTP	OFF	YES	
		Server	PUBLIC SERVER	YES	
		Private Time Server	NULL	YES	
		Sync. Interval	1 Day	YES	
		NTP test	-	-	
	Controller	IR Remote ID	1	YES	
		Remote Controller ID	NONE	YES	
	Update	Device	-	YES	
		Search	-	-	
		No	-	-	
		File Name	NULL	-	
		Update	-	-	
	Backup	Partition Selection	ALL	YES	
		Schedule	OFF	YES	
		Device	-	YES	
		Schedule Start	SUN, 00, 00	YES	
		Time Range Date	Current Date	YES	
		Time Range Start	SUN, 00, 00	YES	
		Time Range End	SUN, 00, 00	YES	
		Estimate Size	-	-	
		Start Backup	-	-	
		Erase Media	-	-	
	Device	Camera	Ch	-	-
			Name	CH 01 to CH 16, IP 01, IP 02	YES
			Audio	01 to 04, NONE	YES

	PTZ	Channel	CH 01	YES	
		Port	NONE	YES	
		Control ID	00	YES	
		Protocol	LG_MULTIX	YES	
		Baud Rate	9600	YES	
		PTZ Test	-	-	
	IP Camera	Channel	IP 01	-	
		Vendor	NONE	YES	
		Model Name	NULL	YES	
		Host Name	NULL	YES	
		User Name	NULL	YES	
		Password	NULL	YES	
		Port	554	YES	
		Test	-	-	
	ATM/POS	Interface Device	NONE	YES	
		Camera	CH 01	YES	
		Baud rate	9600	YES	
		Data Bits	8	YES	
		Stop Bits	1	YES	
		Parity	NONE	YES	
	Storage	Overwrite	ALL	YES	
		Full Warning	OFF	YES	
		Auto Delete	OFF	YES	
		Event Partition	50%	NO	
		Format	-	-	
	Display	OSD	Channel Name	ON	YES
			Channel Status	ON	YES
Sequence		Main Dwell Time	2 SEC	YES	
		Spot Dwell Time	2 SEC	YES	
Channel Composition		Ch	-	-	
		Name	CH 01 to CH 16	YES	
Video Adjustment		Channel	CH 01	-	
		Brightness	50	YES	
		Contrast	50	YES	
		Color	50	YES	

Record	Schedule	SUN	S+M	YES
		MON	S+M	YES
		TUE	S+M	YES
		WED	S+M	YES
		THU	S+M	YES
		FRI	S+M	YES
		SAT	S+M	YES
		SP	S+M	YES
		List	-	-
		Add	-	-
		Ch Copy	-	-
		Day Copy	-	-
		Normal	Ch	-
	Resolution		352X240 (NTSC)/352X288 (PAL)	YES
	Quality		STANDARD	YES
	Frame Rate		30 (NTSC)/25 (PAL)	YES
	Sensor	Ch	-	-
		Resolution	352X240 (NTSC)/352X288 (PAL)	YES
		Quality	STANDARD	YES
		Frame Rate	30 (NTSC)/25 (PAL)	YES
		Prealarm	OFF	YES
		Postalarm	10SEC	YES
	Motion	Ch	-	-
		Resolution	352X240 (NTSC)/352X288 (PAL)	YES
		Quality	STANDARD	YES
		Frame Rate	30 (NTSC)/25 (PAL)	YES
		Prealarm	OFF	YES
		Postalarm	10SEC	YES
	Text	Ch	-	-
		Resolution	352X240 (NTSC)/352X288 (PAL)	YES
		Quality	STANDARD	YES
		Frame Rate	30 (NTSC)/25 (PAL)	YES
		Prealarm	OFF	YES
		Postalarm	10SEC	YES

	Instant/Panic	Ch	-	-
		Resolution	352X240 (NTSC)/352X288 (PAL)	YES
		Quality	STANDARD	YES
		Frame Rate	30 (NTSC)/25 (PAL)	YES
	IP Camera	Ch	-	-
		Resolution	352X240 (NTSC)/352X288 (PAL)	YES
		Quality	STANDARD	YES
		Frame Rate	30 (NTSC)/25 (PAL)	YES
Event	Sensor	In	-	YES
		Sensor Type	N.O.	YES
		Camera	01 to 16	YES
		Relay Output	NONE	YES
		Preset	NONE	YES
	Motion	Channel	CH 01	YES
		Sensitivity	05	YES
		Relay Output	NONE	YES
		Area	All selected	-
	ATM/POS Data Format	Input Channel	CH 01	YES
		Transaction Start	NULL	YES
		Transaction End	NULL	YES
		Delimiter	CARRIAGE RETURN	YES
		Ignore String	NULL	YES
		Time Out	10 Min	YES
	Event Popup	Relay Output	NONE	YES
		Spot Monitor	OFF	YES
	Notification	Sensor On	OFF	YES
		Motion Detection	OFF	YES
		Text In	OFF	YES
		Admin Password Changed	OFF	YES
Video Loss		OFF	YES	
Power On/Off		OFF	YES	
	Disk Full	OFF	YES	

	Mail	Notification	OFF	YES
		SMTP Server	NULL	YES
		SMTP Port	25	YES
		User Name	NULL	YES
		Password	NULL	YES
		TLS	OFF	YES
		Mail Address 1	NULL	YES
		Mail Address 2	NULL	YES
		Mail Address 3	NULL	YES
		E-mail Test	-	-
	Emergency	Notification	OFF	YES
		Host name	NULL	YES
		Port	9002	YES
	Output	Relay Off	ALARM ACKNOWLEDGE	YES
		System Alarm Out	NONE	YES
	Buzzer	Sensor	OFF	YES
		Motion	OFF	YES
		Text	OFF	YES
		System	OFF	YES
User	Group Authority	Group ID	GUEST	YES
		Group Name	GUEST	YES
		Setup	OFF	YES
		Search/Play	OFF	YES
		Export	OFF	YES
		PTZ	OFF	YES
		Power OFF	OFF	YES
		Instant Record	OFF	YES
		Main Channel	All Enable	YES
		Spot Channel	All Enable	YES
	User	User ID	ADMINISTRATOR	YES
		User Name	ADMINISTRATOR	YES
		Group	NULL	YES
		Password	"000000"	YES
		Auto user logout	OFF	YES

Recording Time Table (250GB HDD)

Resolution (NTSC/PAL)	Quality	FPS (NTSC/PAL)	Recording Time(Hr)			
			Video(NTSC/PAL)		Video + Audio(NTSC/PAL)	
			8ch	16ch	8ch	16ch
352x240 / 352x288	LOWEST	30/25	1022/800	511/400	838/683	461/368
		15/12.5	1188/1142	594/571	947/917	527/509
		10/8	1508/1416	754/708	1139/1086	649/615
		7.5/6	1573/1588	787/794	1176/1185	673/679
		5/5	2095/1658	1047/829	1445/1223	855/704
		3/3	2441/2023	1220/1011	1602/1411	967/831
		1/1	3182/2677	1591/1338	1891/1700	1186/1040
	LOW	30/25	765/574	383/287	657/511	354/270
		15/12.5	996/779	498/390	820/668	450/360
		10/8	1162/963	581/481	930/798	517/436
		7.5/6	1220/1098	610/549	967/889	539/491
		5/5	1342/1130	671/565	1042/910	587/504
		3/3	1408/1160	704/580	1082/929	612/516
		1/1	1765/1493	882/746	1280/1131	742/643
	STANDARD	30/25	668/497	334/249	584/449	312/236
		15/12.5	881/671	441/336	741/587	403/313
		10/8	975/805	487/402	806/686	441/370
		7.5/6	1033/939	517/470	846/782	465/427
		5/5	1178/950	589/475	940/789	523/431
		3/3	1331/1114	666/557	1035/899	582/497
		1/1	1605/1370	802/685	1194/1059	685/597
	HIGH	30/25	541/411	271/206	485/378	256/197
		15/12.5	686/542	343/271	598/486	319/256
		10/8	794/671	397/336	678/587	366/313
		7.5/6	819/770	409/385	696/661	376/356
		5/5	994/787	497/393	819/673	449/363
		3/3	1032/802	516/401	845/684	464/369
		1/1	1166/990	583/495	933/816	518/447
HIGHEST	30/25	511/342	256/171	461/318	242/165	
	15/12.5	618/471	309/236	545/428	290/224	
	10/8	692/578	346/289	603/514	322/272	
	7.5/6	736/681	368/341	636/594	341/317	
	5/5	859/721	430/360	726/624	393/334	
	3/3	998/823	499/412	822/700	451/378	
	1/1	1247/1064	624/532	984/866	550/477	

704x240 / 704x288	LOWEST	30/25	563/425	281/212	502/389	265/203
		15/12.5	764/602	382/301	657/533	353/283
		10/8	899/771	449/385	753/661	410/356
		7.5/6	949/888	474/444	788/746	431/405
		5/5	1175/925	587/463	938/772	522/421
		3/3	1235/980	617/490	976/810	545/443
		1/1	1553/1337	777/669	1165/1039	666/585
	LOW	30/25	469/330	235/165	426/308	223/159
		15/12.5	625/465	312/233	551/423	293/222
		10/8	724/577	362/288	627/513	336/272
		7.5/6	774/695	387/348	664/605	357/323
		5/5	924/713	462/357	771/619	420/331
		3/3	1065/853	533/427	867/721	478/391
		1/1	1347/1152	673/576	1045/924	588/513
	STANDARD	30/25	369/251	185/125	342/238	178/122
		15/12.5	479/343	240/171	435/319	228/165
		10/8	544/437	272/218	487/399	257/209
		7.5/6	571/514	286/257	509/463	269/244
		5/5	666/530	333/265	583/476	311/251
		3/3	731/537	365/268	632/481	339/254
		1/1	843/697	422/348	714/606	387/324
	HIGH	30/25	293/222	147/111	276/212	142/109
		15/12.5	398/312	199/156	366/292	191/151
		10/8	457/391	228/196	416/361	218/188
		7.5/6	496/472	248/236	448/429	235/225
		5/5	567/492	283/246	505/445	267/234
		3/3	691/569	345/285	602/507	322/268
		1/1	828/752	414/376	703/647	380/348
HIGHEST	30/25	254/192	127/96	241/185	124/94	
	15/12.5	340/266	170/133	317/252	164/129	
	10/8	386/334	193/167	357/312	186/161	
	7.5/6	418/398	209/199	384/367	200/191	
	5/5	489/401	244/201	442/370	232/192	
	3/3	507/406	254/203	458/374	241/195	
	1/1	630/545	315/273	555/488	295/258	

704x480 / 704x576	LOWEST	30/25	302/236	151/118	284/224	146/115
		15/12.5	430/337	215/169	394/315	206/163
		10/8	470/435	235/217	427/398	224/208
		7.5/6	573/516	287/258	511/465	270/245
		5/5	712/536	356/268	618/481	331/254
		3/3	876/683	438/342	738/596	401/318
		1/1	1250/999	625/500	986/823	551/451
	LOW	30/25	236/169	118/84	225/163	115/83
		15/12.5	322/237	161/118	301/225	156/115
		10/8	381/307	191/153	352/288	183/149
		7.5/6	412/368	206/184	378/341	197/177
		5/5	500/372	250/186	451/345	237/179
		3/3	516/404	258/202	465/372	245/194
		1/1	682/559	341/280	595/499	318/264
	STANDARD	30/25	198/138	99/69	190/134	97/68
		15/12.5	272/194	136/97	257/186	132/95
		10/8	317/253	159/127	297/240	154/123
		7.5/6	351/304	176/152	327/286	169/147
		5/5	418/317	209/159	383/297	200/153
		3/3	503/365	252/183	454/339	239/176
		1/1	663/552	332/276	581/494	310/261
	HIGH	30/25	160/113	80/57	155/110	79/56
		15/12.5	217/160	108/80	207/154	106/78
		10/8	255/207	127/103	242/198	124/101
		7.5/6	277/249	138/125	261/237	134/121
		5/5	322/265	161/133	301/251	156/129
		3/3	339/315	170/158	316/295	164/153
		1/1	445/377	223/189	406/349	212/181
HIGHEST	30/25	139/104	69/52	135/102	68/51	
	15/12.5	200/150	100/75	192/145	98/74	
	10/8	236/196	118/98	224/188	115/96	
	7.5/6	266/237	133/119	252/226	130/116	
	5/5	312/242	156/121	292/230	151/118	
	3/3	318/306	159/153	297/287	154/148	
	1/1	422/371	211/185	387/343	202/178	

 **NOTE**

This recording time table is for reference only.
The recording time can be different depending on your surveillance environment.

Specifications

Model			LE5008 Series	LE5016 Series
			LE4008 Series	LE4016 Series
Video	Input		8	16
	Output	Loop Through	8	16
		Composite	1	1
		VGA	1	1
		Spot	1	1
Audio	Input		2	4
	Output		2	2
Alarm	Input		8	16
	Output		2	4
	Pre-Alarm Recording		Up to 60 seconds	
Recording	Frame Rate (/Second)	NTSC	Up to 240 IPS @ 704x480	Up to 480 IPS @ 704x480
			Up to 240 IPS @ 352x240	Up to 480 IPS @ 352x240
		PAL	Up to 200 IPS @ 704x576	Up to 400 IPS @ 704x576
			Up to 200 IPS @ 352x288	Up to 400 IPS @ 352x288
Search	Playback Function		FF, FB, Frame Advance, Go to First, Go to Last	
	Search Mode		Date/Time, Calendar, Event (Motion, Alarm), Bookmark, Text	
Display	Frame Rate (/Second)	NTSC	240 IPS (Real time per each channel)	480 IPS (Real time per each channel)
		PAL	200 IPS (Real time per each channel)	400 IPS (Real time per each channel)
	Division Mode		1, 4, 9, 1+5, 1+7	1, 4, 9, 16, 1+5, 1+7
Storage	Internal HDD	Max Capacity	4 TB (Up to 4 HDDs)	
	External HDD	Interface Type	E-SATA	
		Max Capacity	Unlimited	
Backup	Backup Interface		USB 2.0 (x3), E-SATA, Network	
	Supportable Devices		Memory Stick, CD-RW, DVD-RW, External HDD	
Serial I/F	PTZ Control Interface		RS-485 (x2)	
	Serial Interface		RS-232C (D-SUB9) (x2)	
Network	Network Connection		Ethernet 10/100/1000 Mbps (RJ-45)	
	Network Transmission Speed		Up to 240 IPS	
	Bandwidth Control		Yes	
Security	Password Protection		Yes	
	Image Authentication		Yes	

Power	AC Free 100~240 V, 50/60 Hz	
Power Consumption	Maximum 80 W (with 4 HDD)	
Dimension (WxDxH)	430 mm x 430 mm x 96 mm	
Net Weight (without HDD)	6.85 kg	6.97 kg
Operation Temp. / Humidity	0 °C to 40 °C / 0 %RH to 80 %RH	

