



LG

Life's Good

OWNER'S MANUAL

Speaker Sound Bar

Please read this manual carefully before operating your set and retain it for future reference.

HLS36W (HLS36W, SHS36-D)

P/NO : MFL66306888

www.lg.com

Safety Information

1

Getting Started



CAUTION: TO REDUCE THE RISK OF ELECTRIC SHOCK DO NOT REMOVE COVER (OR BACK) NO USER-SERVICEABLE PARTS INSIDE REFER SERVICING TO QUALIFIED SERVICE PERSONNEL.



This lightning flash with arrowhead symbol within an equilateral triangle is intended to alert the user to the presence of uninsulated dangerous voltage within the product's enclosure that may be of sufficient magnitude to constitute a risk of electric shock to persons.



The exclamation point within an equilateral triangle is intended to alert the user to the presence of important operating and maintenance (servicing) instructions in the literature accompanying the product.

WARNING: TO PREVENT FIRE OR ELECTRIC SHOCK HAZARD, DO NOT EXPOSE THIS PRODUCT TO RAIN OR MOISTURE.

WARNING: Do not install this equipment in a confined space such as a book case or similar unit.

CAUTION: Do not block any ventilation openings. Install in accordance with the manufacturer's instructions.

Slots and openings in the cabinet are provided for ventilation and to ensure reliable operation of the product and to protect it from over heating. The openings shall be never be blocked by placing the product on a bed, sofa, rug or other similar surface. This product shall not be placed in a built-in installation such as a bookcase or rack unless proper ventilation is provided or the manufacturer's instruction has been adhered to.

Most appliances recommend they be placed upon a dedicated circuit;

That is, a single outlet circuit which powers only that appliance and has no additional outlets or branch circuits. Check the specification page of this owner's manual to be certain. Do not overload wall outlets. Overloaded wall outlets, loose or damaged wall outlets, extension cords, frayed power cords, or damaged or cracked wire insulation are dangerous. Any of these conditions could result in electric shock or fire. Periodically examine the cord of your appliance, and if its appearance indicates damage or deterioration, unplug it, discontinue use of the appliance, and have the cord replaced with an exact replacement part by an authorized service center. Protect the power cord from physical or mechanical abuse, such as being twisted, kinked, pinched, closed in a door, or walked upon. Pay particular attention to plugs, wall outlets, and the point where the cord exits the appliance. To disconnect power from the mains, pull out the mains cord plug. When installing the product, ensure that the plug is easily accessible.

This device is equipped with a portable battery or accumulator.

Safety way to remove the battery or the battery from the equipment: Remove the old battery or battery pack, follow the steps in reverse order than the assembly. To prevent contamination of the environment and bring on possible threat to human and animal health, the old battery or the battery put it in the appropriate container at designated collection points. Do not dispose of batteries or battery together with other waste. It is recommended that you use local, free reimbursement systems batteries and accumulators. The battery shall not be exposed to excessive heat such as sunshine, fire or the like.

IMPORTANT SAFETY INSTRUCTIONS

1. Read these instructions.
2. Keep these instructions.
3. Heed all warnings.
4. Follow all instructions.
5. Do not use this apparatus near water.
6. Clean only with dry cloth.
7. Do not block any ventilation openings.
Install in accordance with the manufacturer's instructions.
8. Do not install near any heat sources such as radiators, heat registers, stoves, or other apparatus (including amplifiers) that produce heat.
9. Do not defeat the safety purpose of the polarized or grounding-type plug. A polarized plug has two blades with one wider than the other. A grounding type plug has two blades and a third grounding prong. The wide blade or the third prong are provided for your safety. If the provided plug does not fit into your outlet, consult an electrician for replacement of the obsolete outlet.
10. Protect the power cord from being walked on or pinched particularly at plugs, convenience receptacles, and the point where they exit from the apparatus.
11. Only use attachments/accessories specified by the manufacturer.
12. Use only with the cart, stand, tripod, bracket, or table specified by the manufacturer, or sold with the apparatus. When a cart is used, use caution when moving the cart/apparatus combination to avoid injury from tip-over.
13. Unplug this apparatus during lightning storms or when unused for long periods of time.
14. Refer all servicing to qualified service personnel. Servicing is required when the apparatus has been damaged in any way, such as power-supply cord or plug is damaged, liquid has been spilled or objects have fallen into the apparatus, the apparatus has been exposed to rain or moisture, does not operate normally, or has been dropped.



Table of Contents

1 Getting Started

- 2 Safety Information
- 6 Unique Features
 - 6 - Portable In
 - 6 - Speaker ez (easy) Setup
- 6 Accessories
- 7 Introduction
 - 7 - Symbols Used in this Manual
- 7 Playable file
 - 7 - MP3/ WMA music file requirement
- 8 Remote control
- 9 Front panel
- 9 Rear panel

2 Connecting

- 10 Mounting the main unit on a wall
- 12 Setting up
 - 12 - Pairing wireless subwoofer
- 13 Optional Equipment Connection
 - 13 - AUDIO (PORT. IN) In Connection
 - 13 - Listening to music from your portable player
 - 13 - OPTICAL In connection
 - 13 - Speaker ez (easy) setup
- 14 - USB Playback

3 Operating

- 15 Basic Operations
 - 15 - USB Operation
- 15 Other Operations
 - 15 - DOLBY DRC (Dynamic Range Control)
 - 15 - AV Sync
 - 16 - Sleep Timer Setting
 - 16 - Dimmer
 - 16 - Turn off the sound temporarily
 - 16 - Adjust the woofer level settings
 - 16 - Displaying file and input source
- 17 Sound adjustment
 - 17 - Setting the surround mode
- 18 Using Bluetooth technology
 - 18 - Listening to music stored on the Bluetooth devices
 - 19 - Listening to sound through the Bluetooth devices
- 20 - Checking the information of connected Bluetooth device
- 21 Controlling a TV with the Supplied Remote Control
 - 21 - Setting up the remote to control your TV

4 Troubleshooting

22 Troubleshooting

5 Appendix

23 Maintenance

23 - Handling the Unit

24 Trademarks and Licenses

25 Specifications

1

2

3

4

5

Unique Features

1

Getting Started

Portable In

Listen to music from your portable device. (MP3, Notebook, etc)

Speaker ez (easy) Setup

Listen to sounds from TV, DVD or Digital device with vivid 2.1 or 2.0 ch mode.

Accessories

Please check and identify the supplied accessories.



Remote control (1)

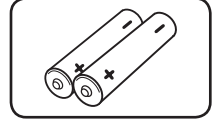

Batteries (2)

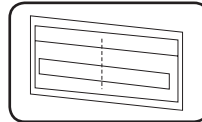

WALL BRACKET
INSTALL GUIDE (1)

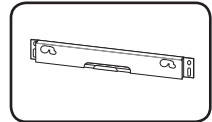

Wall bracket (1)

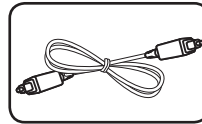

Optical cable (1)

Introduction

Symbols Used in this Manual

 **Note**

Indicates special notes and operating features.

 **Tip**

Indicates tip and hints for making the task easier.

 **Caution**

Indicates cautions for preventing possible damages from abuse.

Playable file

MP3/ WMA music file requirement

MP3/ WMA file compatibility with this unit is limited as follows :

- Sampling frequency : within 32 to 48 kHz (MP3), within 32 to 48 kHz (WMA)
- Bit rate : within 32 to 320 kbps (MP3), 40 to 192 kbps (WMA)
- Maximum files : Under 999
- File extensions : ".mp3"/ ".wma"

Remote control

1
Getting Started

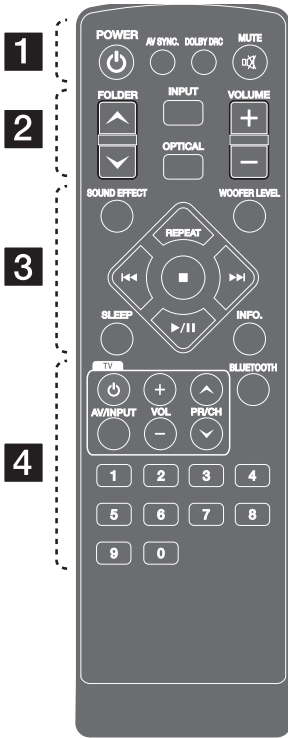

Battery Installation

Remove the battery cover on the rear of the Remote Control, and insert two (size AAA) battery with **+** and **-** matched correctly.

..... **1**

POWER: Switches the unit ON or OFF.

AV SYNC: Synchronizes the audio and video.

DOLBY DRC: Sets the Dobby DRC.

MUTE: Mutes the sound.

..... **2**

FOLDER: Searches for a folder of MP3/ WMA files. When a USB containing MP3/ WMA files in several folders is being played, press FOLDER to select the folder you want to play.

INPUT: Changes input sources.

OPTICAL: Changes input source to optical directly.

VOLUME: Adjusts speaker volume.

..... **3**

SOUND EFFECT: Selects a sound effect mode.

WOOFER LEVEL: Sets the sound level of woofer.

REPEAT: Listens to your files repeatedly or randomly.

◀◀ / ▶▶: Goes to next or previous file.

■: Stops playback.

▶ / ||: Starts playback. / Pauses playback.

SLEEP: Sets the system to turn off automatically at a specified time.

INFO.: Displays the file or input source information.

..... **4**

TV Control buttons: See page 21

BLUETOOTH: Pairing, connecting and disconnecting your unit and Bluetooth device in function other than the Bluetooth.

0 to 9 numerical buttons: Selects numbered numbered files. Enters the PIN code.

Front panel

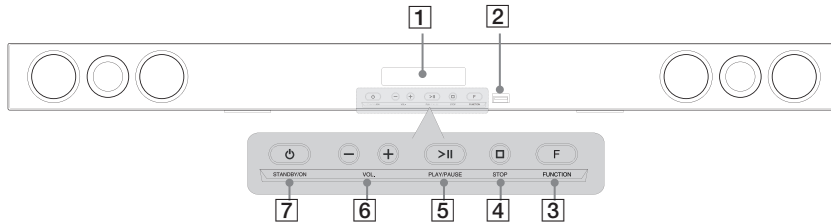

- | | |
|---|--|
| 1 Display | 4 <input type="checkbox"/> STOP |
| 2 USB Port | 5 > PLAY / PAUSE |
| 3 F FUNCTION
Press it repeatedly to select other function. | 6 - VOL +
Adjusts speaker volume. |
| | 7 <input type="checkbox"/> STANDBY/ON |

Rear panel

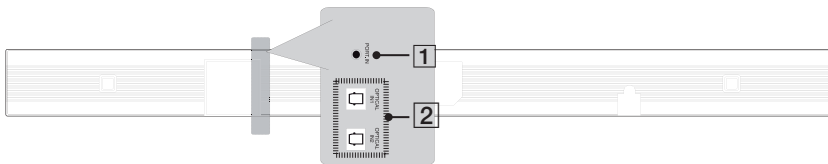

- | | |
|------------------------------|-------------------------|
| 1 PORT. (Portable) IN | 2 OPTICAL IN 1/2 |
|------------------------------|-------------------------|

Mounting the main unit on a wall

You can mount the main unit on a wall. Prepare screws and brackets.

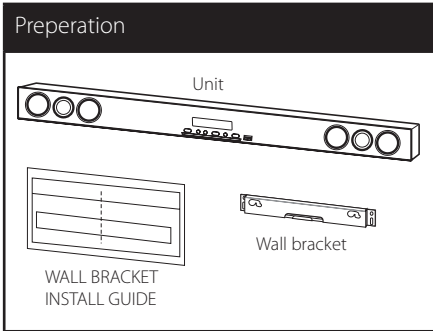

1. Match the TV's BOTTOM EDGE of WALL BRACKET INSTALL GUIDE with the bottom of TV and attach to the position.

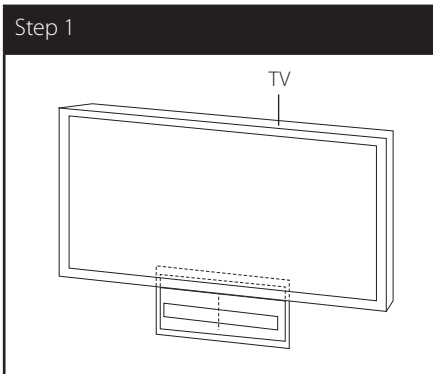

2. When you mount it on a wall (concrete), use the wall plugs (Not supplied). You should drill some holes. A guide sheet (WALL BRACKET INSTALL GUIDE) is supplied to drill. Use the sheet to check the point to drill.

Step 2

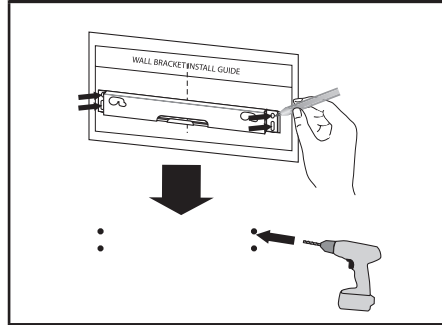

! Note

Screws and Wall Plugs are not supplied for mounting the unit. We recommend the Hilti (HUD-1 6 x 30) for the mounting. Please purchase it.

3. Remove the WALL BRACKET INSTALL GUIDE.
4. Fix it with screws (not supplied) as shown in the illustration below.

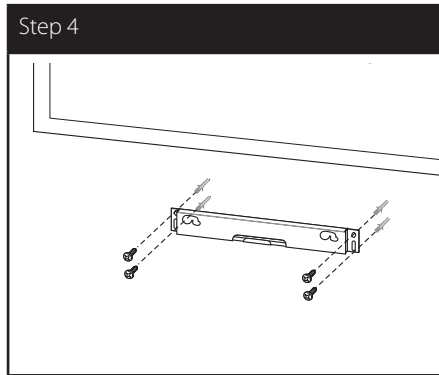

! Note

Detach the unit from the bracket as shown below.

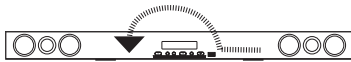

5. Hang the main unit onto the bracket as shown below.

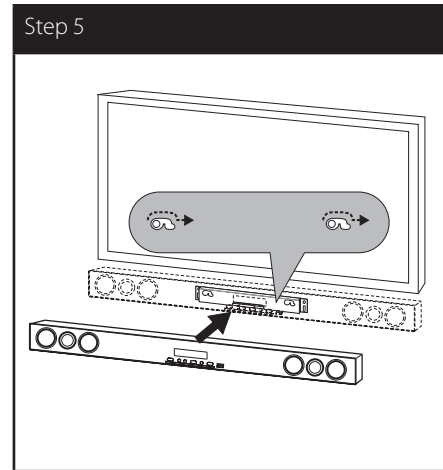

! Note

You can arrange power cord cable with the bracket as shown below.

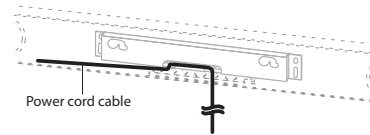

! Caution

- Do not hang onto the installed unit and avoid any impact to the unit.
- Secure the unit firmly to the wall so that it does not fall off. If the unit falls off, it may result in an injury or damage to the product.
- When the unit is installed on a wall, please make sure that a child does not pull any of connecting cables, as it may cause it to fall.

Setting up

Pairing wireless subwoofer

LED indicator of wireless subwoofer



LED Color	Status
Blue	The wireless subwoofer is receiving the signal of the unit.
Blue (blink)	The wireless subwoofer is trying to connect.
Red	The Wireless subwoofer is in standby mode.
Off (No display)	The Wireless subwoofer is turned off.

Setting up the wireless subwoofer for the first time

1. Connect the power cord of the Wireless subwoofer to the outlet.
2. Turn on the main unit : The main unit and wireless subwoofer will be automatically connected.

Manually pairing wireless subwoofer

When your connection is not completed, you can see the red LED on the woofer and woofer is not made sound. To solve the problem, follow the below steps.

1. Press and hold  STOP button on the unit and  MUTE button on the remote control simultaneously.
 - Displays the "REMATE".
2. Press **PAIRING** on back of the woofer.
 - The blue LED will flicker
3. Turn off and on the unit.
 - If you see "blue" LED, it's successful.
4. If you don't see "blue" LED, try again Step 1 - Step 3.

Note

- If you operate main unit then wireless subwoofer (rear speakers) sound within a few seconds in standby mode.
- Set the distance between this unit and subwoofer Receiver within 10 m (32 ft.).
- Optimum performance can be implemented only when the unit and the Wireless subwoofer within distance of 2 m (6 ft.) to 10 m (32 ft.) is used since communication failure may occur if longer distance is used.
- It takes a few seconds (and may take longer) for the Wireless Transmitter and subwoofer to communicate with each other.

Optional Equipment Connection

AUDIO (PORT. IN) In Connection

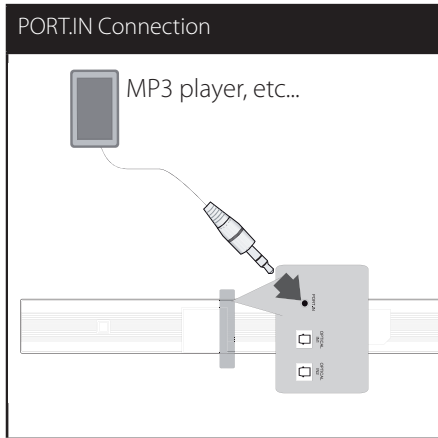

Listening to music from your portable player

The unit can be used to play the music from many types of portable player or external devices.

1. Connect the portable player to the AUDIO (PORT. IN) IN connector of the unit.
2. Turn the power on by pressing **POWER**.
3. Select the PORTABLE function by pressing **INPUT**.
4. Turn on the portable player or external device and start playing it.

OPTICAL In connection

Connect an optical output of Unit (or Digital Device etc) to the OPTICAL IN 1/2 connector.

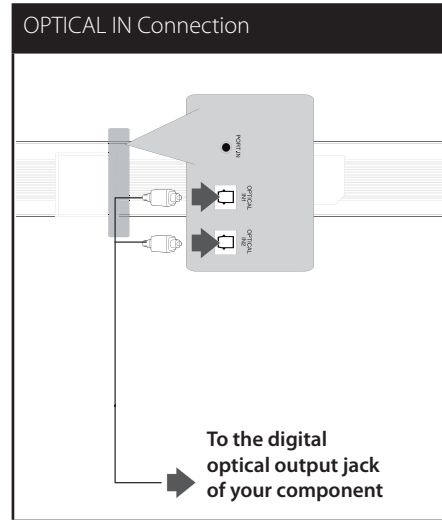

Speaker ez (easy) setup

Listens to sound from TV or DVD or Digital Device with 2.1 or 2ch mode.

1. Connect the unit's OPTICAL IN 1/2 jack to jack on optical out of your TV (or Digital Device etc.).
2. Select the OPTICAL 1/2 by using the **OPTICAL**. To select the OPTICAL 1/2 directly
3. Listen to sound with 2.1 or 2ch speaker.
4. Press **OPTICAL** to exit from OPTICAL 1/2. Function is returned to previous one.

USB Playback

Insert USB memory device to the USB port on the front of the unit.

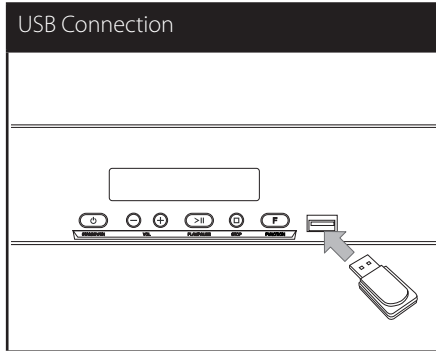

Removing the USB Device from the unit.

1. Choose a different function mode or press STOP twice in a row.
2. Remove the USB device from the unit.

Compatible USB Devices

- MP3 Player : Flash type MP3 player.
- USB Flash Drive : Devices that support USB2.0 or USB1.1.
- The USB function of this unit does not support some USB devices.

USB device requirement

- Devices which require additional program installation connected to a computer, are not supported.
- Do not extract the USB device while in operation.
- For a large capacity USB, it may take longer than a few minutes to be searched.
- To prevent data loss, back up all data.
- If you use a USB extension cable or USB hub, the USB device is not recognized.
- Using NTFS file system is not supported. (Only FAT(16/32) file system is supported.)
- This unit is not supported when the total number of files is 1 000 or more.
- External HDD, Card readers, Locked devices, or hard type USB devices are not supported.
- The unit's USB Port cannot be connected to PC. The unit can not be used as a storage device.

Basic Operations

USB Operation

1. Connect the USB device to the USB port.
2. Select the USB function by pressing **INPUT**.
3. Select a file you want to play by pressing **◀◀** or **▶▶**.

To	Do this
Stop	Press ■
Playback	Press ▶/
Pause	Press ▶/
Skipping to the next/ previous file	During playback, press ◀◀ or ▶▶ to go to the next file or to return to the beginning of the current file. Press ◀◀ twice briefly to step back to the previous file.
Playing repeatedly or randomly	Press REPEAT on the remote control repeatedly, the display change in the following order, RPT 1 → RPT D (DIRECTORY) → RPT ALL → RANDOM → OFF.
Selecting files directly	Press 0 to 9 numerical buttons on the remote control to go to the desired file directly.

Other Operations

DOLBY DRC (Dynamic Range Control)

Make the sound clear when the volume is turned down (Dolby Digital only). Set to [DRC ON] by using **DOLBY DRC**.

AV Sync

When receiving audio signals from TV, sound and images may not be matched. In the case, this function can adjust the delay time.

1. Press **AV SYNC**.
2. Use **◀◀▶▶** to scroll up and down through the delay amount, which you can set at anything between 0 and 300m/sec.

Sleep Timer Setting

Press **SLEEP** one or more times to select delay time between 10 and 180 minutes, after the unit will turn off.

To check the remaining time, press **SLEEP**.

To cancel the sleep function, press **SLEEP** repeatedly until "SLEEP 10" appears, and then press **SLEEP** once again while "SLEEP 10" is displayed.

Note

You can check the remaining time before the Unit turns off.

Press **SLEEP** The remaining time appears in the display window.

Displaying file and input source

You can display various information on the USB and OPTICAL IN 1/ 2 mode by pressing **INFO.**

USB : MP3/WMA containing file information

OPTICAL IN 1/ 2 : Audio format, Audio channel

3

Operating

Dimmer

Press **SLEEP** once. The display window will be darkened by half. To cancel it, press **SLEEP** repeatedly until dim off.

Turn off the sound temporarily

Press  **MUTE** to mute your unit.

You can mute your unit in order, for example, to answer the telephone, appearing the  in the display window.

Adjust the woofer level settings

You can adjust the sound level of woofer.

1. Press **WOOFER LEVEL**.
2. Press **VOLUME +/-** to adjust the sound level of the woofer.

Sound adjustment

Setting the surround mode

This system has a number of pre-set surround sound fields. You can select a desired sound mode by using **SOUND EFFECT**.

The displayed items for the equalizer may be different depending on sound sources and effects.

On Display	Description
NATURAL	You can enjoy comfortable and natural sound.
BYPASS	You can enjoy the sound without equalizer effect.
BASS	The BASS is Bass Blast. During playback, reinforce the treble, bass and surround sound effect.
CLRVOICE	The CLRVOICE is Clear Voice. This program make voice sound clear, improving the quality of voice sound. (We encourage to use this EQ when you watch the movie of 5.1 channel.)
VIRTUAL	The VIRTUAL is VSM Plus. You can enjoy more virtual surround sound.
GAME	The GAME is Game Equalizer. You can enjoy more virtual sound while playing video games.
NIGHT	The NIGHT is Night Mode. This may be useful when you want to watch movies at low volume late at night.
UPSCALER	The UPSCALER is MP3 Up-Scaling. When listening to MP3 files or other compressed music, you can enhance the sound. This mode is available only to 2 channel sources.
LOUDNESS	Improves the bass and treble sound.

! Note

- In some of surround modes, some speakers, there's no sound or low sound. It depends on the mode of surround and the source of audio, it is not defective.
- You may need to reset the surround mode, after switching the input, sometimes even after the sound file changed.

Using Bluetooth technology

About Bluetooth

Bluetooth® is wireless communication technology for short range connection.

The available range is within 10 meters.

(The sound may be interrupted when the connection interfered by the other electronic wave or you connect the bluetooth in the other rooms.)

Connecting individual devices under Bluetooth® wireless technology does not incur any charges. A mobile phone with

Bluetooth® wireless technology can be operated via the Cascade if the connection was made via Bluetooth® wireless technology.

Available Devices : Mobile phone, MP3, Laptop, PDA (This units be supported the Stereo Headset.)

Bluetooth Profiles

In order to use Bluetooth wireless technology, devices must be able to interpret certain profiles. This unit is compatible with following profile.

A2DP (Advanced Audio Distribution Profile)

AVRCP (Audio/ Video Distribution Remote Control Profile)

Listening to music stored on the Bluetooth devices

Pairing your unit and Bluetooth device

Before you start the pairing procedure, make sure the Bluetooth feature is turned on in to your Bluetooth device. Refer to your Bluetooth device's user guide. Once a pairing operation is performed, it does not need to be performed again.

1. Select the Bluetooth function by using the **INPUT**.
Appears "BT" and then "BT READY" in display window.
2. Operate the Bluetooth device and perform the pairing operation. When searching for this unit with the Bluetooth device, a list of the devices found may appear in the Bluetooth device display depending on the type of Bluetooth device. Your unit appears as "LG AUDIO".
3. Enter the PIN code.
PIN code : 0000
4. When this unit successfully paired with your Bluetooth device, Bluetooth LED of this unit lights up and appears "PAIRED".

! Note

- Depending on the Bluetooth device type, some device have a different pairing way.
- This function is recommended to use to listening to music. While using Bluetooth headset, sound and images may not be matched depending on the wireless environment or the connection conditions.

5. Listen to music.
To play a music stored on your Bluetooth device, refer to your Bluetooth device's user guide.

! Note

- If you change the function of the unit, the Bluetooth function is disconnected, operate pairing again.
(Bluetooth ↔ Function other than the Bluetooth)
- AVRCP is not supported in this mode.

Listening to sound through the Bluetooth devices

Pairing your unit and Bluetooth device

Before you start the pairing procedure, make sure the Bluetooth feature is turned on in to your Bluetooth device. Refer to your Bluetooth device's user guide. Once a pairing operation is performed, it does not need to be performed again.

1. Select a function other than the Bluetooth function by using the **INPUT**.
2. Place the Bluetooth device to be connected to this unit within 3 feet of the unit.
3. Put the Bluetooth device in pairing mode. Refer to your Bluetooth device's user guide.
4. Press and hold **BLUETOOTH**.
Appears "INQUIRY".
If searched Bluetooth is only one, pairing the unit. Refer the step 7.
5. Appears depending on type of Bluetooth devices in display window .
6. Select a Bluetooth device you want to connect by using **▲ V FOLDER** and press **■** (STOP).
7. Enter the PIN code by using numerical buttons.
PIN code : 0000
8. Press **■** (STOP) to confirm.
When this unit successfully paired with your Bluetooth device, Bluetooth icon of this unit lights up and appears "BT SRC".
You can listen to music played on this unit using your Bluetooth device.
Sound output from the speakers is stopped.

! Note

You cannot use VOL (volume), SOUND EFFECT, WOOFER LEVEL buttons on the remote control or the unit in this mode.

Operating with Bluetooth device

You can operate a unit by connecting a Bluetooth device using AVRCP. For details about operation, refer to the Bluetooth device's User Guide.

! Note

These operations may not be available for certain Bluetooth device. In addition, the actual operations may differ depending on the connected Bluetooth device.

Connecting and disconnecting with a Bluetooth device

This function is operated after pairing.

Press **BLUETOOTH** to connect or disconnect with a Bluetooth device.

Appears in as below display window.

Connection : BT CONN

Disconnection : DISCONN

! Note

If you change the function of the unit, the Bluetooth function is disconnected, press **BLUETOOTH** pairing again.
(Bluetooth ↔ Function other than the Bluetooth)

Checking the information of connected Bluetooth device

This function is operated after pairing. You can check the Bluetooth information.

Press and hold **INFO**. repeatedly.

Bluetooth information is changed as follows.

Local Bluetooth Device Address → Device Name
→ None → ...

3

Operating

! Note

- This units does not be supported the Mono Headset Profile (Hands Free Profile)
- The sound may be interrupted when the connection interfered by the other electronic wave.
- You cannot control the Bluetooth device with this unit.
- Pairing is limited one Bluetooth device per one unit and multi-pairing is not supported.
- Although the distance between your Bluetooth and the set is less than 10m, there are obstacles between both, your Bluetooth device cannot be connected.
- Depending on the type of the device, you may not be able to use the Bluetooth function.
- You can enjoy wireless system using phone, MP3, Notebook, headset, etc..
- When not connected the Bluetooth, "BT READY" appears on the display window.
- The Electrical malfunction due to devices using same frequency such as Medical equipment, Microwaves or wireless LAN devices, the connection will be disconnected.
- When someone stands and interrupts communication between Bluetooth device and the player, the connection will be disconnected.
- If the gotten away of the distance between Bluetooth and the unit, the sound quality is lower and lower the connection will disconnect when the space between the Bluetooth and the unit gets out of the operating range of Bluetooth.
- The device with Bluetooth wireless technology is disconnected, if you turn off the main unit or put the device away from the main unit more than 10m.

Controlling a TV with the Supplied Remote Control

You can control your TV using the buttons below.

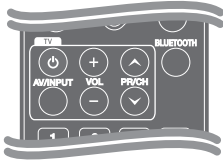

Button	Operation
(TV POWER)	Turn the TV on or off.
AV/INPUT	Switch the TV's input source between the TV and other input sources.
VOL +/-	Adjust the volume of the TV.
PR/CH ^ / V	Scan up or down through memorized channels.

Note

Depending on the unit being connected, you may not be able to control your TV using some of the buttons.

Setting up the remote to control your TV

You can operate your TV with the supplied remote control.

If your TV is listed in the table below, set the appropriate manufacturer code.

1. While holding down (TV POWER) button, and press the manufacturer code for your TV with the numerical buttons (see the table below).

Manufacturer	Code Number
LG	1(Default), 2
Zenith	1, 3, 4
GoldStar	1, 2
Samsung	6, 7
Sony	8, 9
Hitachi	4

2. Release the (TV POWER) button to complete setting.

Depending on your TV, some or all buttons may not function on the TV, even after entering the correct manufacturer code. When you replace the batteries of the remote, the code number you have set may be reset to the default setting. Set the appropriate code number again.

Troubleshooting

PROBLEM	CORRECTION
No Power	Plug in the power cord.
	Check the condition by operating other electronic devices.
No sound	Press FUNCTION and check the selected function.
	The power cord of woofer is not connected. Plug the power cord into the wall outlet securely. Pairing between the unit and woofer gets disconnected. Connect the unit and woofer. (Refer to the page 12)
The remote control does not work properly.	The remote control is too far from the unit.
	Operate the remote control within about 23 ft (7m).
	There is an obstacle in the path of the remote control and the unit. Remove the obstacle. The battery in the remote control is exhausted. Replace the battery with new one.



4 Troubleshooting

Maintenance

Handling the Unit

When shipping the unit

Please save the original shipping carton and packing materials. If you need to ship the unit, for maximum protection, re-pack the unit as it was originally packed at the factory.

Keeping the exterior surfaces clean

- Do not use volatile liquids such as insecticide spray near the unit.
- Wiping with strong pressure may damage the surface.
- Do not leave rubber or plastic products in contact with the unit for a long period of time.

Cleaning the unit

To clean the player, use a soft, dry cloth. If the surfaces are extremely dirty, use a soft cloth lightly moistened with a mild detergent solution. Do not use strong solvents such as alcohol, benzine, or thinner, as these might damage the surface of the unit.

Trademarks and Licenses



Manufactured under license from Dolby Laboratories. Dolby and the double-D symbol are trademarks of Dolby Laboratories.



Manufactured under license under U.S. Patent #s: 5,451,942; 5,956,674; 5,974,380; 5,978,762; 6,487,535 & other U.S. and worldwide patents issued & pending. DTS and the Symbol are registered trademarks & DTS Digital Surround and the DTS logos are trademarks of DTS, Inc. Product includes software. © DTS, Inc. All Rights Reserved.



Bluetooth® wireless technology is a system which allows radio contact between electronic devices within a max. range of 10 meters.

Connecting individual devices under Bluetooth® wireless technology does not incur any charges. A mobile phone with Bluetooth® wireless technology can be operated via the Cascade if the connection was made via Bluetooth® wireless technology.

The Bluetooth® word mark and logos are owned by the Bluetooth® SIG, Inc. and any use of such marks by LG Electronics is under license.

Other trademarks and trade names are those of their respective owners.

Specifications

General	
Power requirements	Refer to main label.
Power consumption	Refer to main label.
Dimensions (W x H x D)	(39 x 3 x 20) inches without foot
Net Weight (Approx.)	5.1 lbs
Operating temperature	41 °F to 95 °F (5 °C to 35 °C)
Operating humidity	5 % to 90 %
Bus Power Supply (USB)	DC 5 V  500 mA

Inputs	
DIGITAL IN (OPTICAL IN)	3 V (p-p), Optical jack x 2
PORT. IN	0.5Vrms (3.5 mm stereo jack)

Amplifier	
Stereo mode	70 W + 70 W (4 Ω at 1 kHz)
Subwoofer	140 W (3 Ω at 60 Hz)

Wireless subwoofer	
Power requirements	Refer to main label on the Subwoofer.
Power consumption	Refer to main label on the Subwoofer.
Reception Output	5.8 GHz
Type	1 Way 1 Speaker
Impedance Rated	3 Ω
Input Power	140 W
Max. Input Power	280 W
Net Dimensions (W x H x D)	(8 x 15 x 12) inches
Net Weight	15.2 lbs

Designs and specifications are subject to change without prior notice.



LG Customer Information Center

1-888-542-2623 CANADA

Register your product Online!

www.lg.com