



SIMPLE MANUAL 3D Blu-ray™ Home Theater

Please read this manual carefully before operating your set and retain it for future reference.

HB806TGW (HB806TGW, SH86TG-S/ C, SH95TA-W, W86S)

P/NO: MFL67204993

Safety Information

1

Getting Started



CAUTION: TO REDUCE THE RISK OF ELECTRIC SHOCK DO NOT REMOVE COVER (OR BACK) NO USER-SERVICEABLE PARTS INSIDE REFER SERVICING TO QUALIFIED SERVICE PERSONNEL.



This lightning flash with arrowhead symbol within an equilateral triangle is intended to alert the user to the presence of uninsulated dangerous voltage within the product's enclosure that may be of sufficient magnitude to constitute a risk of electric shock to persons.



The exclamation point within an equilateral triangle is intended to alert the user to the presence of important operating and maintenance (servicing) instructions in the literature accompanying the product.

WARNING: TO PREVENT FIRE OR ELECTRIC SHOCK HAZARD, DO NOT EXPOSE THIS PRODUCT TO RAIN OR MOISTURE.

WARNING: Do not install this equipment in a confined space such as a book case or similar unit.

CAUTION: Do not block any ventilation openings. Install in accordance with the manufacturer's instructions.

Slots and openings in the cabinet are provided for ventilation and to ensure reliable operation of the product and to protect it from over heating. The openings shall be never be blocked by placing the product on a bed, sofa, rug or other similar surface. This product shall not be placed in a built-in installation such as a bookcase or rack unless proper ventilation is provided or the manufacturer's instruction has been adhered to.



CAUTION: This product employs a Laser System. To ensure proper use of this product, please read this owner's manual carefully and retain it for future reference. Shall the unit require maintenance, contact an authorized service centre. Use of controls, adjustments or the performance of procedures other than those specified herein may result in hazardous radiation exposure. To prevent direct exposure to laser beam, do not try to open the enclosure. Visible laser radiation when open. DO NOT STARE INTO BEAM.

CAUTION concerning the Power Cord

Most appliances recommend they be placed upon a dedicated circuit;

That is, a single outlet circuit which powers only that appliance and has no additional outlets or branch circuits. Check the specification page of this owner's manual to be certain. Do not overload wall outlets. Overloaded wall outlets, loose or damaged wall outlets, extension cords, frayed power cords, or damaged or cracked wire insulation are dangerous. Any of these conditions could result in electric shock or fire. Periodically examine the cord of your appliance, and if its appearance indicates damage or deterioration, unplug it, discontinue use of the appliance, and have the cord replaced with an exact replacement part by an authorized service centre. Protect the power cord from physical or mechanical abuse, such as being twisted, kinked, pinched, closed in a door, or walked upon. Pay particular attention to plugs, wall outlets, and the point where the cord exits the appliance. To disconnect power from the mains, pull out the mains cord plug. When installing the product, ensure that the plug is easily accessible.

This device is equipped with a portable battery or accumulator.

Safety way to remove the battery or the battery from the equipment: Remove the old battery or battery pack, follow the steps in reverse order than the assembly. To prevent contamination of the environment and bring on possible threat to human and animal health, the old battery or the battery put it in the appropriate container at designated collection points. Do not dispose of batteries or battery together with other waste. It is recommended that you use local, free reimbursement systems batteries and accumulators. The battery shall not be exposed to excessive heat such as sunshine, fire or the like.

CAUTION: The apparatus shall not be exposed to water (dripping or splashing) and no objects filled with liquids, such as vases, shall be placed on the apparatus.

Notes on Copyrights

This product incorporates copyright protection technology that is protected by U.S. patents and other intellectual property rights. Use of this copyright protection technology must be authorized by Rovi, and is intended for home and other limited viewing uses only unless otherwise authorized by Rovi. Reverse engineering or disassembly is prohibited.

Important Notice for TV colour system

The colour system of this player differs according to currently playing discs.

For example, when the player plays the disc recorded in the NTSC colour system, the image is output as an NTSC signal.

Only the multi system colour TV can receive all signals output from the player.

- If you have a PAL colour system TV, you will see just distorted images when using discs or video contents recorded in NTSC.
- The multi system colour TV changes the colour system automatically according to input signals. In case that the colour system is not changed automatically, turn it off and then on to see normal images on screen.
- Even if the disc recorded in NTSC colour system are well displayed on your TV, these may not be recorded correctly on your recorder.

Supplied Accessories

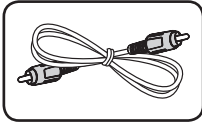

Video cable (1)

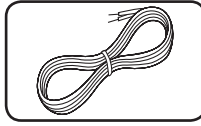

Speaker cables (6)

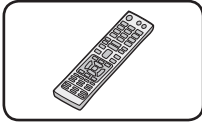

Remote control (1)

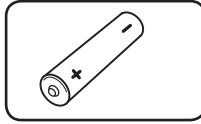

Battery (1)

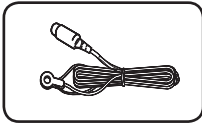

FM antenna (1)

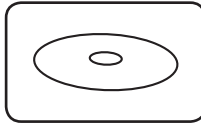

Owner's Manual & PC Software CD

Network Software Update

Network update notification

From time to time, performance improvements and/or additional features or services may be made available to units that are connected to a broadband home network. If there is new software available and the unit is connected to a broadband home network, the player will inform you about the update as follows.

Option 1:

1. The update menu will appear on the screen when you turn on the player.
2. Use **</>** to select a desired option and then press **ENTER** (⊙).



[OK]	Starts the software update.
[Cancel]	Exits the update menu and displays it next booting.
[Hide]	Exits the update menu and it does not appear until next software is uploaded in the update server.

Option 2:

If the software update is available from the update server, the “Software Update” icon appears in the Home menu. Press blue (B) coloured button to start the update procedure.

Table of Contents

1 Getting Started

- 2 Safety Information
- 4 – Supplied Accessories
- 4 Network Software Update
- 4 – Network update notification
- 6 Introduction
- 6 – Playable Discs and symbols used in this manual
- 7 – File requirement
- 8 Remote control
- 9 Front panel
- 9 Rear panel

2 Connecting

- 10 Assembling the speaker stand to the speaker
- 10 – Preparation
- 11 Positioning the system
- 12 Speaker Connection
- 12 – Attaching the speakers to the player
- 12 – Attaching the rear speakers to the wireless receiver
- 13 – Wireless connection

3 System Setting

- 14 Settings
- 14 – Adjust the Setup Settings
- 14 – Resolution Setting
- 15 – Wired Network Setup

4 Operating

- 16 General Playback
- 16 – Using [HOME] menu
- 16 – Playing a Disc
- 16 – Playing a file on disc/USB device
- 17 – Basic operations for video and audio content
- 17 On-Screen display

5 Troubleshooting

- 18 Troubleshooting
- 19 – Customer Support
- 19 – Open source software notice

6 Appendix

- 20 Trademarks and Licenses
- 21 Specifications

To view the Owner's Manual on the CD-ROM

Load the supplied CD-ROM into the CD-ROM drive on your PC. After a while, the web page will open automatically. (Windows users only)

If the web page does not appear automatically, browse the CD-ROM drive and double-click the "index.html" file.

To view the Owner's Manual on the CD-ROM, Adobe Acrobat Reader must be installed on your PC. The "Acrobat Reader" folder on the CD-ROM contains the installation program for Acrobat Reader.

1

2

3

4

5



























6

Introduction

1

Getting Started

Playable Discs and symbols used in this manual

Media/Term	Logo	Symbol	Description
Blu-ray	  		<ul style="list-style-type: none"> Discs such as movies that can be purchased or rented. "Blu-ray 3D" discs and "Blu-ray 3D ONLY" discs. BD-R/RE discs that are recorded in BDAV format.
		  	<ul style="list-style-type: none"> BD-R/RE discs that contain Movie, Music or Photo files. ISO 9660+JOLIET, UDF and UDF Bridge format
DVD-ROM DVD-R DVD-RW DVD+R DVD+RW (8 cm, 12 cm)	    		<ul style="list-style-type: none"> Discs such as movies that can be purchased or rented. Movie mode and finalized only Supports the dual layer disc also
			Finalized AVCHD format
		  	<ul style="list-style-type: none"> DVD±R/RW discs that contain Movie, Music or Photo files. ISO 9660+JOLIET, UDF and UDF Bridge format
DVD-RW (VR) (8 cm, 12 cm)			VR mode and finalized only
Audio CD (8 cm, 12 cm)			Audio CD
CD-R/RW (8 cm, 12 cm)		  	<ul style="list-style-type: none"> CD-R/RW discs that contain Movie, Music or Photo files. ISO 9660+JOLIET, UDF and UDF Bridge format
Note	–		Indicates special notes and operating features.
Caution	–		Indicates cautions for preventing possible damages from abuse.

File requirement

Movie files

File Location	File Extension	Codec Format	Audio Format	Subtitle
Disc, USB	“.avi”, “.divx”, “.mpg”, “.mpeg”, “.mkv”, “.mp4”, “.asf”, “.wmv”, “.m4v” (DRM free)	DIVX3.xx, DIVX4.xx, DIVX5.xx, DIVX6.xx (standard playback only), XVID, MPEG1 SS, H.264/MPEG-4 AVC, MPEG2 PS, MPEG2 TS, RV30, RV40	“Dolby Digital”, “DTS”, “MP3”, “WMA”, “AAC”, “AC3”, “COOK”	SubRip (.srt / .txt), SAMI (.smi), SubStation Alpha (.ssa/.txt), MicroDVD (.sub/.txt), VobSub (.sub), SubViewer 1.0 (.sub), SubViewer 2.0 (.sub/.txt), TMLayer (.txt), DVD Subtitle System (.txt)
DLNA	“.avi”, “.divx”, “.mpg”, “.mpeg”, “.mkv”, “.mp4”, “.asf”, “.wmv”	DIVX3.xx, DIVX4.xx, DIVX5.xx, DIVX6.xx (standard playback only), XVID, MPEG1 SS, H.264/MPEG-4 AVC, MPEG2 PS, MPEG2 TS	Dolby Digital, DTS, MP3, WMA, AAC, AC3	SubRip (.srt / .txt), SAMI (.smi), SubStation Alpha (.ssa/.txt), MicroDVD (.sub/.txt), SubViewer 1.0 (.sub), SubViewer 2.0 (.sub/.txt), TMLayer (.txt), DVD Subtitle System (.txt)

Music files

File Location	File Extension	Sampling Frequency	Bitrate	Note
Disc, USB, DLNA	“.mp3”, “.wma”, “.wav”, “.m4a” (DRM free)	within 32 - 48 kHz (WMA), within 16 - 48 kHz (MP3)	within 32 - 192 kbps (WMA), within 32 - 320 kbps (MP3)	Some wav files are not supported on this player.

Photo files

File Location	File Extension	Recommended Size	Note
Disc, USB, DLNA	“.jpg”, “.jpeg”, “.png”	Less than 4,000 x 3,000 x 24 bit/pixel Less than 3,000 x 3,000 x 32 bit/pixel	Progressive and lossless compression photo image files are not supported.

Remote control

1

Getting Started

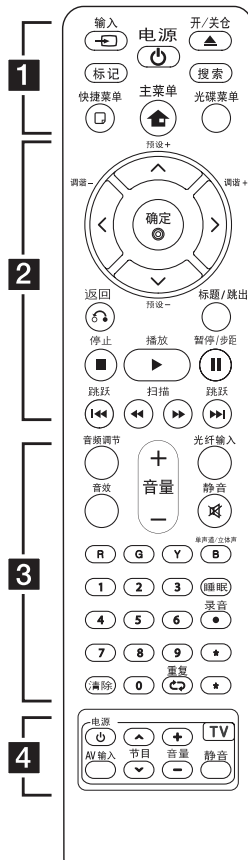

..... **1**

RADIO&INPUT (↔) (输入):
Changes input mode.

MARKER (标记): Marks any point during playback.

⏻ (POWER) (电源): Switches the player ON or OFF.

▲ (OPEN/CLOSE) (开/关仓):
Opens and closes the disc tray.

SEARCH (搜索): Displays or exits the search menu.

INFO/DISPLAY (□) (快捷菜单):
Displays or exits On-Screen Display.

HOME (🏠) (主菜单): Displays or exits the [Home Menu].

DISC MENU (光碟菜单): Accesses menu on a disc.

..... **2**

PRESET (-/+) (预设): Selects programme of Radio.

TUNING (-/+ (调谐): Tunes in the desired radio station.

▲/▼/◀/▶ (up/down/left/right): Used to navigate on-screen displays.

ENTER (⊙) (确定):
Acknowledges menu selection.

BACK (↶) (返回): Exits the menu or resumes playback. The resume play function may not work depending on the BD-ROM disc.

TITLE/POPUP (标题/跳出):
Displays the DVD title menu or BD-ROM's pop-up menu, if available.

■ (STOP) (停止): Stops playback.

▶ (PLAY) (播放): Starts playback.

⏸ PAUSE/STEP (暂停/步距):
Pauses playback

◀◀/▶▶ (SCAN) (扫描):
Searches backward or forward.

◀◀/▶▶ (SKIP) (跳跃): Goes to the next or previous chapter / track / file.

..... **3**

SPEAKER LEVEL (音频调节):
Sets the sound level of desired speaker.

SOUND EFFECT (音效): Selects a sound effect mode.

VOL +/- (音量): Adjusts speaker volume.

OPTICAL (光纤输入): Changes input mode to optical directly.

MUTE (静音): Mute the unit.

Coloured (R, G, Y, B) buttons:
Use to navigate on menus.

MONO/STEREO (单声道/立体声): Selects mono/ stereo in FM mode.

SLEEP (睡眠): Sets a certain period of time after which the unit will switch to off.

● REC (录音): Records an audio CD.

0-9 numerical buttons: Selects numbered options in a menu.

CLEAR (清除): Removes a mark on the search menu or a number when setting the password.

REPEAT (重复): Repeats a desired section or sequence.

★: This button is not available.

..... **4**

TV Control Buttons

Battery Installation

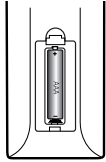

Remove the battery cover on the rear of the Remote Control, and insert a (size AAA) battery with + and - matched correctly.

Front panel

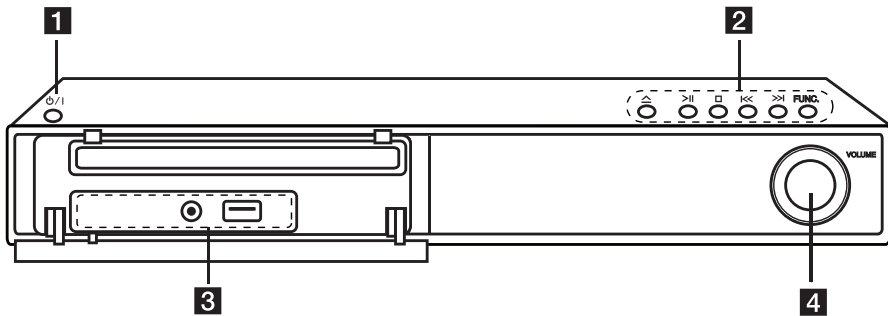

- 1** ⏻/I (POWER) Button
- 2** △ (OPEN/CLOSE)
>|| (PLAY/PAUSE)
□ (STOP)
|<</>>| (SKIP)
FUNC. (Function)
- 3** PORT.IN
USB Port
- 4** Volume control

Rear panel

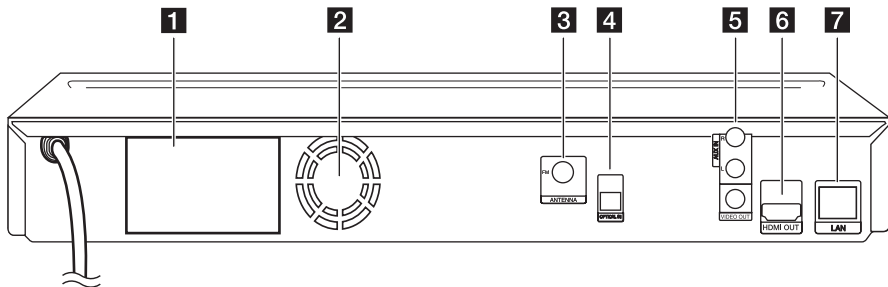

- 1** Speakers connectors
- 2** Cooling Fan
- 3** Antenna Connector
- 4** OPTICAL IN
- 5** AUX (R/L) IN/VIDEO OUT
- 6** HDMI OUT (Type A, HDMI™ Connector)
Connect to TV with HDMI inputs.
- 7** LAN port

Assembling the speaker stand to the speaker

Before connecting the speakers, assemble the speakers. Please check the items for assembling the speakers.

Attach the speakers to the speaker stands by rotating the screws.

Preparation

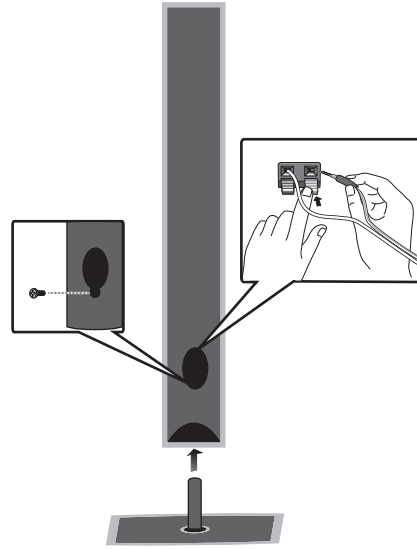
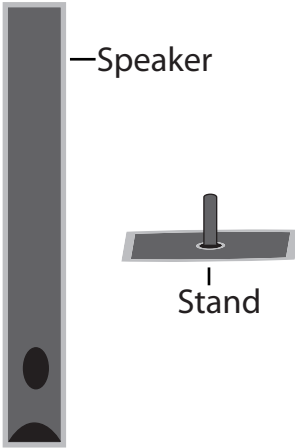

2

Connecting

Positioning the system

The following illustration shows an example of positioning the system. Note that the illustrations in these instructions differ from the actual unit for explanation purposes.

For the best possible surround sound, all the speakers other than the subwoofer should be placed at the same distance from the listening position (A).

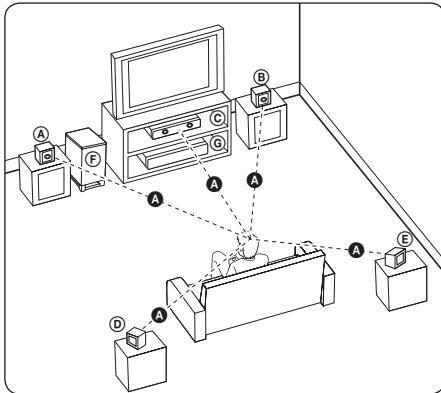

(A) Front left speaker (L)/

(B) Front right speaker (R):

Place the front speakers to the sides of the monitor and screen and as flush with the screen surface as possible.

(C) Center speaker:

Place the center speaker above or below the monitor or screen.

(D) Surround left speaker (L)/

(E) Surround right speaker (R):

Place these speakers behind your listening position, facing slightly inwards.

(F) Subwoofer:

The position of the subwoofer is not so critical, because low bass sounds are not highly directional. But it is better to place the subwoofer near the front speakers. Turn it slightly toward the center of the room to reduce the wall reflections.

(G) Unit

Caution

- Be careful to make sure children not to put their hands or any objects into the *speaker duct.
*Speaker duct: A hole for plentiful bass sound on speaker cabinet (enclosure).
- Place the center speaker at a safe distance from the child's reach.
Otherwise it may result in the speaker falling down and causing personal injury and/or property damage.
- The speakers contain magnetic parts, so colour irregularity may occur on the CRT TV screen or PC monitor screen. Please use the speakers away from the TV screen or PC monitor screen.

Speaker Connection

Attaching the speakers to the player

Connect the wires hooked up to the speaker to the unit.

- To connect the cable to the unit, press each plastic finger pad to open the connection terminals on the unit. Insert the wire and release the finger pad.
- Connect the black stripe of each wire to the terminals marked - (minus) and the other end to the terminals marked + (plus).

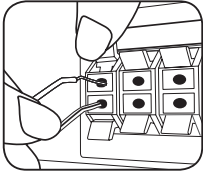

Colour	Speaker	Position
Green	Center	Centre
Orange	Sub woofer	Any front position
Red	Front	Front right
White	Front	Front left

Wireless connection

When you turn on the player, the wireless connection will be completed automatically. When the connection is completed, you can see the icon (●) on the display window.

LED indicator of wireless receiver

LED Color	Operation
Blue (Blink)	The connection is not completed.
Blue	The connection is completed.
Red	The connection is in standby mode or failed.
Off (No display)	The AC power cord is unplugged.

Note

- Be sure to match the speaker, cable to the appropriate terminal on the unit: + to + and – to –. If the cables are reversed, the sound will be distorted and will lack bass.
- If there is a strong electromagnetic wave product nearby, interference may occur. Put the unit (Wireless Receiver and main unit) away from there.
- It takes a few seconds (and may take longer) for the player with the built-in wireless transmitter and wireless receiver to communicate with each other.
- The available range is 20 m for wireless connection in an open place.

Connect wireless speakers

When the unit is manufactured, the ID is already set. If interference occurs or you use a new wireless unit, an ID should be set again.

When the [Wireless Speaker Connection Guide] appears, press the PAIRING button on the receiver.

- If you see the blue LED indicator light on the wireless receiver, the pairing was successful. Select the [Speaker test] to test the connection.

Settings

Adjust the Setup Settings

You can change the settings of the player in the [Setup] menu.

1. Press HOME (🏠).



2. Use </> to select the [Setup] and press ENTER (⊙). The [Setup] menu appears.



3. Use ^/v to select the first setup option, and press > to move to the second level.



4. Use ^/v to select a second setup option, and press ENTER (⊙) to move to the third level.

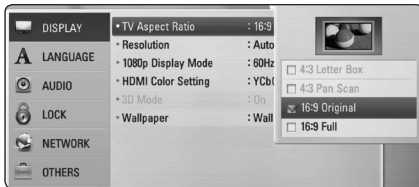

5. Use ^/v to select a desired setting, and press ENTER (⊙) to confirm your selection.

Resolution Setting

The player provides several output resolutions for HDMI OUT jack. You can change the resolution using [Setup] menu.

1. Press HOME (🏠).
2. Use </> to select the [Setup] and press ENTER (⊙). The [Setup] menu appears.
3. Use ^/v to select [DISPLAY] option then press > to move to the second level.
4. Use ^/v to select the [Resolution] option then press ENTER (⊙) to move to the third level.



5. Use ^/v to select the desired resolution then press ENTER (⊙) to confirm your selection.

Note

- If your TV does not accept the resolution you have set on the player, you can set resolution to 576p as follows:

1. Press ▲ to open the disc tray.
2. Press ■ (STOP) for more than 5 seconds.



System Setting

Wired Network Setup

If there is a DHCP server on the local area network (LAN) via wired connection, this player will automatically be allocated an IP address. After making the physical connection, a small number of home networks may require the player's network setting to be adjusted. Adjust the [NETWORK] setting as follow.

Preparation

Before setting the wired network, you need to connect the broadband internet to your home network.

1. Select [Connection Setting] option in the [Setup] menu then press ENTER (⊙).

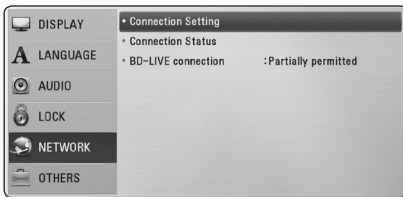

2. Select [Yes] and press ENTER (⊙) to continue. The new connection settings reset the current network settings.
3. Use \wedge / \vee / \lt / \gt to select the IP mode between [Dynamic] and [Static].

Normally, select [Dynamic] to allocate an IP address automatically.

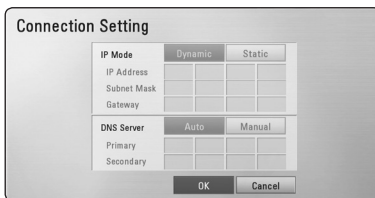

Note

If there is no DHCP server on the network and you want to set the IP address manually, select [Static] then set [IP Address], [Subnet Mask], [Gateway] and [DNS Server] using \wedge / \vee / \lt / \gt and numerical buttons. If you make a mistake while entering a number, press CLEAR to clear the highlighted part.

4. Select [OK] and press ENTER (⊙) to apply network settings.

5. The player will ask you to test the network connection. Select [OK] and press ENTER (⊙) to complete the network connection.
6. If you select [Test] and press ENTER (⊙) at step 5 above, the network connection status is displayed on the screen. You can also test it on the [Connection Status] in the [Setup] menu.

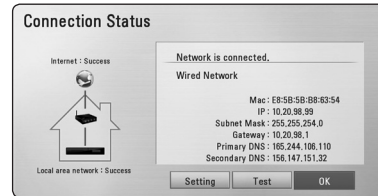

General Playback

Using [HOME] menu

The home menu appears when you press HOME (🏠). Use </> to select a category and press ENTER (⊙).

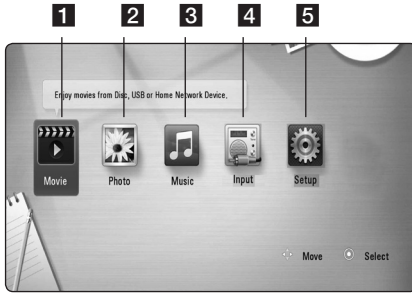

1	[Movie] - Plays video contents.
2	[Photo] - Plays photo contents.
3	[Music] - Plays audio contents.
4	[Input] - Changes input mode
5	[Setup] - Adjusts the system settings.

Playing a Disc

BD DVD ACD

1. Press ▲ (OPEN/CLOSE), and place a disc on the disc tray.
2. Press ▲ (OPEN/CLOSE) to close the disc tray.
For the most Audio CD, BD-ROM and DVD-ROM discs, playback starts automatically.
3. Press HOME (🏠).
4. Select [Movie] or [Music] using </>, and press ENTER (⊙).
5. Select [BD], [DVD], [VR] or [Audio] option using ▲/▼, and press ENTER (⊙).

! Note

- Playback functions described in this manual are not always available in every files and media. Some functions can be restricted depending on many factors.
- Depending on the BD-ROM titles, a USB device connection may be needed for the proper playback.
- Unfinalized DVD VR format discs may not be played in this player.
- Some DVD-VR discs are made with CPRM data by DVD RECORDER. This unit cannot support these kinds of discs.

Playing a file on disc/USB device

MOVIE MUSIC PHOTO

This player can play movie, music and photo files contained in the disc or USB device.

1. Insert a data disc on the tray or connect a USB device.
2. Select [Movie], [Photo] or [Music] using </>, and press ENTER (⊙).
3. Select [Data] or [USB] option using ▲/▼, and press ENTER (⊙).
4. Select a file using ▲/▼/</>, and press ►(PLAY) or ENTER (⊙) to play the file.

Basic operations for video and audio content

To stop playback

Press ■ (STOP) while playback.

To pause playback

Press ⏸ (PAUSE) while playback.
Press ▶ (PLAY) to resume playback.

To play frame-by-frame (Video)

Press ⏸ (PAUSE) while movie playback.
Press ⏸ (PAUSE) repeatedly to play Frame-by-Frame playback.

To scan forward or backward

Press ◀◀ or ▶▶ to play fast forward or fast reverse during playback.

You can change the various playback speeds by pressing ◀◀ or ▶▶ repeatedly.

To slow down the playing speed (Video)

While the playback is paused, press ▶▶ repeatedly to play various speeds of slow motion.

To skip to the next/previous chapter/track/file

During playback, press ◀◀ or ▶▶ to go to the next chapter/track/file or to return to the beginning of the current chapter/track/file.

Press ◀◀ twice briefly to step back to the previous chapter/track/file.

In the file list menu of a server, there may have many types of contents in a folder together. In this case, press ◀◀ or ▶▶ to go to the previous or next content with same type.

On-Screen display

You can display and adjust various information and settings about the content.

BD DVD AVCHD MOVIE

1. While playback, press INFO/DISPLAY (i) to show various playback information.



- 1 **Title** – current title number/total number of titles
- 2 **Chapter** – current chapter number/total number of chapters
- 3 **Time** – elapsed playing time/total playback time
- 4 **Audio** – selected audio language or channel
- 5 **Subtitle** – selected subtitle.
- 6 **Angle** – selected angle/total number of angles
- 7 **TV Aspect Ratio** – selected TV aspect Ratio
- 8 **Picture Mode** – selected picture mode

2. Select an option using \wedge / \vee .
3. Use \langle / \rangle to adjust the selected option value.
4. Press BACK (⏪) to exit the On-Screen display.

Troubleshooting

Symptom	Cause & Solution
The Power does not turned on.	<ul style="list-style-type: none"> Plug the power cord into the wall outlet securely.
The unit does not start playback.	<ul style="list-style-type: none"> Insert a playable disc. (Check the disc type, colour system, and regional code.) Place the disc with the playback side down. Place the disc on the disc tray correctly inside the guide. Clean the disc. Cancel the Rating function or change the rating level.
The angle cannot be changed.	<ul style="list-style-type: none"> Multi-angles are not recorded on the DVD Video being played.
Cannot play movie, photo or music files.	<ul style="list-style-type: none"> The files are not recorded in a format that the unit can play. The unit does not support the codec of the movie file.
The remote control does not work properly.	<ul style="list-style-type: none"> The remote control is not pointed at the remote sensor of the unit. The remote control is too far from the unit. There is an obstacle in the path of the remote control and the unit. The batteries in the remote control are exhausted.
The unit is plugged in, but the power will not turn on or off.	<p>You can reset the unit as follows.</p> <p>Press and hold the POWER button for at least five seconds. This will force the unit to power off then turn the unit back on.</p>
The unit is not operating normally.	
There is no picture.	<ul style="list-style-type: none"> Select the appropriate video input mode on the TV so the picture from the unit appears on the TV screen. Connect the video connection securely. Check the [HDMI Color Setting] in the [Setup] menu is set to the appropriate item that conforms to your video connection. Your TV may not support the resolution you have set on the player. Change the resolution that your TV accepts. The player's HDMI OUT jack is connected to a DVI device that does not support copyright protection.
Picture noise appears.	<ul style="list-style-type: none"> You are playing a disc recorded in a colour system that is different from your TV. Set the resolution which your TV accepts.
Blu-ray 3D disc playback does not output 3D views.	<ul style="list-style-type: none"> Connect the player to your TV with HDMI cable (Type A, High Speed HDMI™ Cable). Your TV may not support "HDMI 1.4 3D mandatory format". The [3D Mode] option in the [Setup] menu is set to [Off]. Set the option to [On].

Symptom	Cause & Solution
BD-Live feature does not work.	<ul style="list-style-type: none"> The connected USB storage may not have enough space. Connect the USB storage with at least 1GB free space. Ensure that the unit is correctly connected to the local area network and can access the internet. Your broadband speed may not fast enough to use the BD-Live features. Contact your Internet Service Provider (ISP) and increase the broadband speed is recommended. The [BD-LIVE connection] option in the [Setup] menu is set to [Prohibited]. Set the option to [Permitted].
Streaming video services (such as YouTube™, etc.) are often stopped or “buffer” during playback.	<ul style="list-style-type: none"> Your broadband service speed may not be fast enough to stream video services. Contact your Internet Service Provider (ISP) and increase the broadband speed is recommended.
Shared folder or files from media server are not displayed on the device list.	The player is not connected to the local area network that your media server are connected.
There is no sound or the sound is distorted.	<ul style="list-style-type: none"> The unit is in scan, slow motion, or pause mode. The sound volume is low. Check the speaker cable connection.

Customer Support

You can update the Player using the latest software to enhance the products operation and/or add new features. To obtain the latest software for this player (if updates have been made), please visit <http://lgservice.com> or contact LG Electronics customer care centre.

Open source software notice

To obtain the corresponding source code under GPL, LGPL and other open source licenses, please visit <http://opensource.lge.com>. All referred license terms, warranty disclaimers and copyright notices are available to download with the source code.

Trademarks and Licenses



Blu-ray Disc™, Blu-ray™, Blu-ray 3D™, BD-Live™, BONUSVIEW™ and the logos are trademarks of the Blu-ray Disc Association.



"DVD Logo" is a trademark of DVD Format/Logo Licensing Corporation.



Java and all Java-based trademarks and logos are trademarks or registered trademarks of Sun Microsystems, Inc. in the United States and other countries.



HDMI, the HDMI logo and High-Definition Multimedia Interface are trademarks or registered trademarks of HDMI licensing LLC.



Manufactured under license from Dolby Laboratories. Dolby and the double-D symbol are trademarks of Dolby Laboratories.



Manufactured under license under U.S. Patent #'s: 5,451,942; 5,956,674; 5,974,380; 5,978,762; 6,226,616; 6,487,535; 7,392,195; 7,272,567; 7,333,929; 7,212,872 & other U.S. and worldwide patents issued & pending. DTS and the Symbol are registered trademarks, & DTS-HD, DTS-HD Master Audio | Essential and the DTS logos are trademarks of DTS, Inc. Product includes software. © DTS, Inc. All Rights Reserved.



DLNA®, the DLNA Logo and DLNA CERTIFIED® are trademarks, service marks, or certification marks of the Digital Living Network Alliance.



"AVCHD" and the "AVCHD" logo are trademarks of Panasonic Corporation and Sony Corporation.



DivX®, DivX Certified® and associated logos are trademark of DivX, Inc., and are used under license.

Specifications

General	
Power requirements	Refer to main label.
Power consumption	Refer to main label.
Dimensions (W x H x D)	Approx. 360 x 59 x 307 mm without foot
Net Weight (Approx.)	2.8 kg
Operating temperature	5 °C to 35 °C (41 °F to 95 °F)
Operating humidity	5 % to 90 %

Inputs/Outputs	
VIDEO OUT	1.0 V (p-p), 75 Ω, sync negative, RCA jack x 1
HDMI OUT (video/audio)	19 pin (Type A, HDMI™ Connector)
ANALOG AUDIO IN	2.0 Vrms (1 kHz, 0 dB), 600 Ω, RCA jack (L, R) x 1
DIGITAL IN (OPTICAL)	Optical Connector x 1
PORT. IN	0.5 Vrms (3.5 mm stereo jack)

Tuner	
FM Tuning Range	87.5 to 108.0 MHz or 87.50 to 108.00 MHz

Amplifier	
Power output (3 Ω), (RMS), THD 10 %	
Total	850 W
Front	141 W x 2
Center	141 W
Surround	141 W x 2
Sub-Woofer	145 W (Passive)

Wireless receiver	
Power requirements	Refer to main label on the bottom of the receiver.
Power consumption	Refer to main label on the bottom of the receiver.
External dimensions (WxHxD)	64 x 213.6 x 180 mm (2.5 x 8.4 x 7.1 inches)
Net Weight	1 kg (2.2 lbs)

System	
Laser	Semiconductor laser
Wavelength	405 nm / 650 nm
Signal system	Standard NTSC /PAL color TV system
Frequency response	20 Hz to 20 kHz (48 kHz, 96 kHz, 192 kHz sampling)
Signal-to-noise ratio	More than 80 dB
Total harmonic distortion	0.05 % at 1 W
Dynamic range	More than 85 dB
LAN port	Ethernet jack x 1, 10BASE-T / 100BASE-TX
Bus Power Supply (USB)	DC 5 V  500 mA

Speakers			
Front speaker (Left/ Right)			
Type	2 Way 2 speaker	Max. Input power	282 W
Impedance Rated	3 Ω	Net Dimensions (W x H x D)	270 X 1 052 X 225 mm
Input Power	141 W	Net Weight	2.9 kg
Rear speaker (Left/ Right)			
Type	2 Way 2 speaker	Max. Input power	282 W
Impedance Rated	3 Ω	Net Dimensions (W x H x D)	270 X 1 052 X 225 mm
Input Power	141 W	Net Weight	2.9 kg
Center speaker			
Type	2 Way 3 speaker	Max. Input power	282 W
Impedance Rated	3 Ω	Net Dimensions (W x H x D)	320 X 103 X 86 mm
Input Power	141 W	Net Weight	1.0 kg
Subwoofer			
Type	1 Way 1 speaker	Max. Input power	290 W
Impedance Rated	3 Ω	Net Dimensions (W x H x D)	190 x 385 x 318 mm
Input Power	145 W	Net Weight	5.0 kg

- Design and specifications are subject to change without notice.



An extended Owner's Manual that contains information on the advanced features is located on the CD-ROM provided in an electronic version. To read these files, you will need to use a Personal Computer (PC) equipped with a CD-ROM drive.