

# PRADA



PRADA phone by LG / USER GUIDE



PRADA / LG ELECTRONICS INC.

PRADA phone by LG

CE 0168

[www.pradaphonebylg.com](http://www.pradaphonebylg.com)

P/N : MMBB0320912(1.0)

## ENGLISH

Please read this manual carefully before operating your mobile phone. Retain it for future reference.

**Bluetooth QD ID B014644**

# | KF900 | USER GUIDE

Some of the contents in this manual may differ from your phone depending on the software of the phone or your service provider.

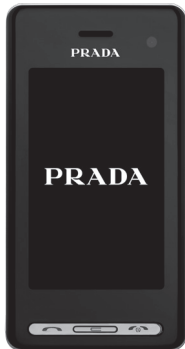

# CONTENTS

## Guidelines for safe and efficient use

### Set up

#### **11 GETTING TO KNOW YOUR PHONE**

---

12 Open view

#### **14 INSTALLING THE USIM AND BATTERY**

---

#### **16 MEMORY CARD**

---

### Your standby screen

#### **18 TOUCH SCREEN TIPS**

---

#### **20 USING TOUCHSCREEN MORE CONVENIENTLY**

---

20 Activating top menus directly

20 Touchscreen tips

#### **23 MENU MAP**

---

## The basics

### **24 CALLS**

---

24 Making a call or video call

24 CHANGING THE SETTING OF DIALLING KEYPAD DISPLAY

24 Making a call from your contacts

25 Answering and rejecting a call

26 Adjusting the call volume

26 Speed dialling

26 Making a second call

27 Turning off DTMF

27 Viewing your call logs

27 Using call divert

28 Using call barring

28 Changing the common call setting

29 Changing your video call settings

### **30 CONTACTS**

---

30 Searching for a contact

30 Adding a new contact

31 Contact options

31 Creating a group

32 Changing your contact settings

32 Viewing information

### **33 MESSAGING**

---

33 Messaging

33 Sending a message

34 Entering text

34 T9 predictive

34 Abc manual

**35 Qwerty keypad**

- 35 Entering text
- 35 Text input mode using the keypad
- 35 Sending an email using your new account
- 36 Setting up your email
- 36 Retrieving your email
- 37 Changing your email settings
- 37 Message folders
- 38 Managing your messages
- 38 Using templates
- 38 Using emoticons
- 39 Changing your text message settings
- 39 Changing your multimedia message settings
- 40 Changing your other settings

**Get creative****41 CAMERA**

---

- 41 Taking a quick photo
- 41 After you've taken your photo
- 42 Getting to know the viewfinder
- 43 Using the flash
- 43 Choosing a shot type
- 44 Taking a burst shot
- 44 Taking a panoramic shot
- 44 Adjusting the exposure
- 45 Using the advanced settings
- 46 Changing the image size
- 46 Choosing a colour effect

**47 VIDEO CAMERA**

---

- 47 Shooting a quick video
- 47 After you've shot your video

- 48 Getting to know the viewfinder

- 49 Adjusting the Exposure

- 49 Using the advanced settings

- 50 Changing the video image size

- 50 Choosing a color effect

**51 YOUR PHOTOS AND VIDEOS**

---

- 51 Viewing your photos and videos

- 51 Using zoom when viewing a photo

- 51 Adjusting the volume when viewing a video

- 51 Viewing your photos as a slide show

- 51 Setting a photo as wallpaper

- 52 Editing your photos

- 53 Adding text to a photo

- |    |                                   |                      |                                     |  |  |
|----|-----------------------------------|----------------------|-------------------------------------|--|--|
| 53 | Adding an effect to a photo       | <b>60 MULTIMEDIA</b> | 65                                  | Installing a Java game and application |  |
| 53 | Resizing a photo                  | 60                   | Pictures                            | 65                                     | Flash contents                           |
| 54 | Morphing a photo                  | 60                   | My images option menus              | 65                                     | Viewing an SWF file                      |
| 54 | Adding a colour accent to a photo | 61                   | Sending a photo                     | 65                                     | Using options while viewing the SWF file |
| 55 | Swapping the colours in a photo   | 61                   | Using an image                      | 65                                     | Documents                                |
| 55 | Watching your videos on your TV   | 62                   | Marking up your images              | 65                                     | Transferring a file to your phone        |
| 55 | Editing your videos               | 62                   | Printing an image                   | 66                                     | Viewing a file                           |
| 56 | Trimming the length of your video | 62                   | Moving or copying an image          | 66                                     | Others                                   |
| 56 | Merging two videos together       | 62                   | Creating a slide show               | 66                                     | Creating a movie                         |
| 57 | Merging a photo with a video      | 62                   | Checking your memory status         | 67                                     | Music                                    |
| 57 | Adding text to a video            | 63                   | Sounds                              | 67                                     | Transferring music onto your phone       |
| 58 | Overlaying a photo                | 63                   | Using a sound                       | 68                                     | Playing a song                           |
| 58 | Adding a voice recording          | 63                   | Videos                              | 68                                     | Using options while playing music        |
| 59 | Adding a soundtrack to your video | 63                   | Using options while video is paused | 69                                     | Creating a playlist                      |
| 59 | Changing the speed of your video  | 64                   | Sending a video clip                | 69                                     | Editing a playlist                       |
| 59 | Adding a dimming effect           | 64                   | Using the video options menu        | 69                                     | Deleting a playlist                      |
|    |                                   | 64                   | Games and Applications              |  |  |
|    |                                   | 64                   | Playing a game                      |  |  |
|    |                                   | 64                   | Using the options menu              |  |  |

- 70 Using the radio
- 70 Searching for stations
- 70 Resetting channels
- 70 Listening to the radio

## Get organised

### **71 ORGANISER**

---

- 71 Adding an event to your calendar
- 71 Changing your default calendar view
- 71 Adding an item to your to do list
- 72 Sharing a to do item
- 72 Using date finder
- 72 Setting your alarm
- 73 Adding a memo
- 73 Voice recorder
- 73 Recording a sound or voice
- 74 Sending the voice recording
- 74 Using your calculator
- 74 Converting a unit
- 74 Using the stopwatch
- 75 Adding a city to your world time

### **76 PC SYNC**

---

- 76 Installing LG PC Suite on your computer
- 76 Connecting your phone and PC
- 76 Backing up and restoring your phone's information
- 77 Viewing your phone files on your PC
- 77 Synchronising your contacts
- 77 Synchronising your messages
- 77 Using your phone as a mass storage device
- 78 Using iSync
- 78 DivX Converter

## The web

### **79 THE WEB**

---

- 79 Browser
- 79 Accessing the web
- 79 Adding and accessing your bookmarks
- 80 Using RSS reader
- 80 Saving a page
- 80 Accessing a saved page
- 80 Viewing your browser history
- 81 Changing the web browser settings
- 81 Using your phone as a modem

## Settings

### **82 SETTINGS**

---

- 82 Changing your screen settings
- 82 Personalising your profiles
- 82 Changing your phone settings
- 83 Changing the setting of touchpad
- 83 Changing your connectivity settings
- 84 Using memory manager
- 85 Using flight mode
- 85 Sending and receiving your files using Bluetooth
- 86 Pairing with another Bluetooth device
- 86 Using a Bluetooth headset

### **87 WIFI**

---

### **87 ANTI-THEFT MOBILE TRACK (ATMT)**

---

### **88 ACCESSORIES**

---

### **89 NETWORK SERVICE**

---

## **90 TECHNICAL DATA**

---

### **91 TROUBLESHOOTING**

---

Please read these simple guidelines. Not following these guidelines may be dangerous or illegal.

## EXPOSURE TO RADIO FREQUENCY ENERGY

### Radio wave exposure and Specific Absorption Rate (SAR) information

This mobile phone model KF900 has been designed to comply with applicable safety requirements for exposure to radio waves. These requirements are based on scientific guidelines that include safety margins designed to assure the safety of all persons, regardless of age and health.

- The radio wave exposure guidelines employ a unit of measurement known as the Specific Absorption Rate, or SAR. Tests for SAR are conducted using standardised methods with the phone transmitting at its highest certified power level in all used frequency bands.
- While there may be differences between the SAR levels of various LG phone models, they are all designed to meet the relevant guidelines for exposure to radio waves.
- The SAR limit recommended by the International Commission on Non-ionizing Radiation Protection (ICNIRP) is 2W/kg averaged over 10g of tissue.

- The highest SAR value for this model phone tested by DASY4 for use at the ear is 0.208 W/kg (10g) and when worn on the body is 1.55 W/Kg(10g).
- SAR data information for residents in countries/regions that have adopted the SAR limit recommended by the Institute of Electrical and Electronics Engineers (IEEE), which is 1.6 W/kg averaged over 1g of tissue.

## PRODUCT CARE AND MAINTENANCE

### > WARNING:

**Only use batteries, chargers and accessories approved for use with this particular phone model. The use of any other types may invalidate any approval or warranty applying to the phone, and may be dangerous.**

- Do not disassemble this unit. Take it to a qualified service technician when repair work is required.
- Keep away from electrical appliances such as TVs, radios, and personal computers.
- The unit should be kept away from heat sources such as radiators or cookers.
- Do not drop.

- Do not subject this unit to mechanical vibration or shock.
- Switch off the phone in any area where you are required by special regulations. For example, do not use your phone in hospitals as it may affect sensitive medical equipment.
- Do not handle the phone with wet hands while it is being charged. It may cause an electric shock and can seriously damage your phone.
- Do not to charge a handset near flammable material as the handset can become hot and create a fire hazard.
- Use a dry cloth to clean the exterior of the unit (do not use solvents such as benzene, thinner or alcohol).
- Do not charge the phone when it is on soft furnishings.
- The phone should be charged in a well ventilated area.
- Do not subject this unit to excessive smoke or dust.
- Do not keep the phone next to credit cards or transport tickets; it can affect the information on the magnetic strips.
- Do not tap the screen with a sharp object as it may damage the phone.
- Do not expose the phone to liquid or moisture.
- Use the accessories like earphones cautiously. Do not touch the antenna unnecessarily.

## EFFICIENT PHONE OPERATION

### ELECTRONICS DEVICES

**All mobile phones may get interference, which could affect performance.**

- Do not use your mobile phone near medical equipment without requesting permission. Avoid placing the phone over pacemakers, for example, in your breast pocket.
- Some hearing aids might be disturbed by mobile phones.
- Minor interference may affect TVs, radios, PCs, etc.

### ROAD SAFETY

**Check the laws and regulations on the use of mobile phones in the area when you drive.**

- Do not use a hand-held phone while driving.
- Give full attention to driving.
- Use a hands-free kit, if available.
- Pull off the road and park before making or answering a call if driving conditions so require.
- RF energy may affect some electronic systems in your vehicle such as car stereos and safety equipment.

- When your vehicle is equipped with an air bag, do not obstruct with installed or portable wireless equipment. It can cause the air bag to fail or cause serious injury due to improper performance.
- If you are listening to music whilst out and about, please ensure that the volume is at a reasonable level so that you are aware of your surroundings. This is particularly imperative when near roads.

## **AVOID DAMAGE TO YOUR HEARING**

Damage to your hearing can occur if you are exposed to loud sound for long periods of time. We therefore recommend that you do not turn on or off the handset close to your ear. We also recommend that music and call volumes are set to a reasonable level.

## **GLASS PARTS**

Some parts of your mobile device are made of glass. This glass could break if your mobile device is dropped on a hard surface or receives a substantial impact. If the glass breaks, do not touch or attempt to remove. Stop using your mobile device until the glass is replaced by an authorized service provider.

## **BLASTING AREA**

Do not use the phone where blasting is in progress. Observe restrictions, and follow any regulations or rules.

## **POTENTIALLY EXPLOSIVE ATMOSPHERES**

- Do not use the phone at a refueling point.
- Do not use near fuel or chemicals.
- Do not transport or store flammable gas, liquid, or explosives in the same compartment of your vehicle as your mobile phone and accessories.

## **IN AIRCRAFT**

Wireless devices can cause interference in aircraft.

- Turn your mobile phone off before boarding any aircraft.
- Do not use it on the ground without permission from the crew.

## **CHILDREN**

Keep the phone in a safe place out of the reach of small children. It includes small parts which may cause a choking hazard if detached.

## EMERGENCY CALLS

Emergency calls may not be available under all mobile networks. Therefore, you should never depend solely on the phone for emergency calls. Check with your local service provider.

## BATTERY INFORMATION AND CARE

- You do not need to completely discharge the battery before recharging. Unlike other battery systems, there is no memory effect that could compromise the battery's performance.
- Use only LG batteries and chargers. LG chargers are designed to maximize the battery life.
- Do not disassemble or short-circuit the battery pack.
- Keep the metal contacts of the battery pack clean.
- Replace the battery when it no longer provides acceptable performance. The battery pack maybe recharged hundreds of times until it needs replacing.
- Recharge the battery if it has not been used for a long time to maximize usability.
- Do not expose the battery charger to direct sunlight or use it in high humidity, such as in the bathroom.
- Do not leave the battery in hot or cold places, this may deteriorate the battery performance.
- There is risk of explosion if the battery is replaced by an incorrect type.
- Dispose of used batteries according to the manufacturer's instructions. Please recycle when possible. Do not dispose as household waste.
- If you need to replace the battery, take it to the nearest authorized LG Electronics service point or dealer for assistance.
- Always unplug the charger from the wall socket after the phone is fully charged to save unnecessary power consumption of the charger.

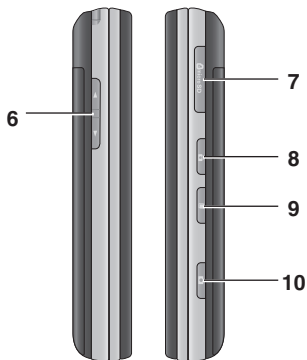
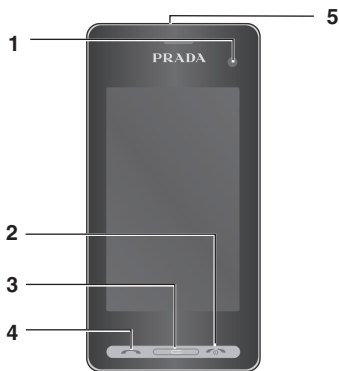

## GETTING TO KNOW YOUR PHONE

### 1. INNER CAMERA LENS

### 2. END/POWER KEY

- Ends or rejects a call. Turns the phone on/off. Press once to return to the standby screen.

### 3. CLEAR KEY

### 4. CALL KEY

- Dials a phone number and answers incoming calls.

Placing a heavy object on the phone or sitting on it while it is in your pocket can damage the phone's LCD and touch screen functionality.

### 5. CHARGER, CABLE, HANDSFREE CONNECTOR

To connect the USB cable, wait until the phone has powered up and has registered to the network.

### 6. SIDE KEYS

- **When the screen is idle:** volume of key tone.
- **During a call:** volume of the earpiece.

### 7. MICRO SD MEMORY CARD SOCKET

### 8. LOCK/ UNLOCK KEY

### 9. MULTITASKING KEY

### 10. CAMERA KEY

**OPEN VIEW****CLEAR KEY**

- Clears a character with each press. Hold the key down to clear all input.

**ENTER KEY**

**CHANGE THE TEXT MODE**  
(Capital/ Small)

**ALPHA NUMERIC KEYS**

**SPACE KEY**

Use to enter space while editing.

**SYMBOL KEY**

Enters symbolic character.

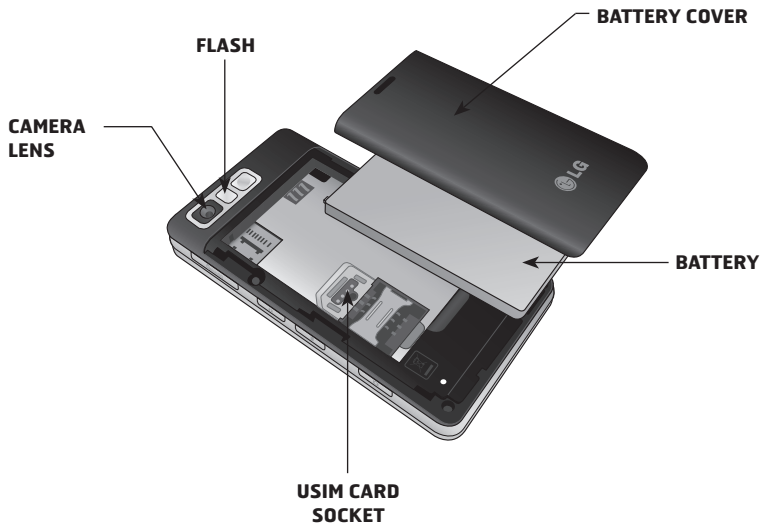

## INSTALLING THE USIM AND BATTERY

### 1. REMOVE THE BATTERY COVER

Press and hold down the battery release button at the top of the phone and lift off the battery cover.



### 2. REMOVE THE BATTERY

Hold the top edge of the battery and lift it from the battery compartment using the battery cover.



**Do not use your fingernail when removing the battery.**

**Do not remove the battery when the phone is switched on, as this may damage the phone.**

### 3. INSTALL THE USIM CARD

Slide the USIM card into the USIM card holder. Make sure that the gold contact area on the card is facing downwards. To remove the USIM card, pull it gently in the opposite direction.



#### 4. INSTALL THE BATTERY

Insert the top of the battery first into the top edge of the battery compartment. Ensure that the battery contacts align with the terminals on the phone. Press down the bottom of the battery until it clips into place.



#### 5. REPLACE THE COVER

Place the cover over the battery and slide up into position.

#### 6. CHARGING YOUR PHONE

Slide back the cover of the charger socket on the top of your KF900. Insert the charger and plug into a mains electricity socket. Your KF900 will need to be charged until a message reading "Battery full" appears on screen.



## MEMORY CARD

### INSTALLING A MEMORY CARD



You can expand the memory space available on your phone using a memory card.

1. For inserting memory card no need to remove Battery cover.
2. Slide the memory card into the slot at the top, until it clicks into place. Make sure that the gold contact area is facing downwards.



### FORMATTING THE MEMORY CARD

Your memory card may already be formatted. If your card isn't already formatted, you will need to do so before you can begin using it.

1. From the standby screen select , then touch  **Setting** and choose **Phone settings**.
2. Touch **Memory manager** then choose **External memory**.
3. Touch **Format** and then confirm your choice.
4. Enter the password, if one is set, and your card will be formatted and ready to use.

**To change your default storage destination, open Memory manager from the Phone settings menu and select Primary storage settings.**

**If your memory card has existing content on, it will automatically be filed in the correct folder, for example, videos will be stored in the My Videos folder.**

## TRANSFERRING YOUR CONTACTS

To transfer your contacts from your USIM to your phone:

1. From the Communicate tab, select **Contacts** and choose **Settings**.
2. Touch **Copy**.
3. Choose **Handset to USIM** and touch **Done**.
4. Choose **Select all** or choose names one by one and touch **OK**.

Whenever your KF900 is not in use it will return to your home screen. From here you can access all menu options, make a quick call and view the status of your phone - as well as many other things.

## TOUCH SCREEN TIPS

The home screen is also a great place to get accustomed to the touch screen. To select an item, touch the icon accurately. Your KF900 will vibrate slightly when it recognises you've touched an option.

To scroll through lists, touch the last item visible and slide your finger up the screen.

The list will move up so more items are visible.

- There's no need to press too hard, the touchscreen is sensitive enough to pick up on a light yet firm touch.
- Use the tip of your finger to touch the option you require. Be careful not to touch any other keys around it.
- When the screen light is off, press the Unlock/Lock key on the right hand side to restore the home screen.
- Don't cover the phone with a case or cover as the touchscreen will not work with any material covering it.

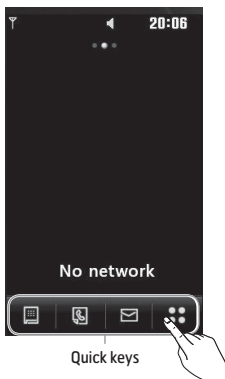

## THE QUICK KEYS

The quick keys provide easy, one-touch access to your most used functions.



Touch to bring up the touch dialling pad to make a call. Input the number as you would using a normal key pad and touch **Call** or press the  hard key.



Touch to open your **Contacts** menu. To search for the number you want to call enter the name of the contact using the touchpad. You can also create new contacts and edit existing ones. See page 30 for details.



Touch to access the Messaging options menu. From here you can create a new SMS. See page 33 for details.



Touch to open the full Top menu which is separated into four sub-menus. Touch each sub-menu's vertical tab to view further options.

## USING TOUCHSCREEN MORE CONVENIENTLY

Your LG KF900 is a small masterpiece, combining stylish design and a crystal sharp, smart LCD. The touch reactive LCD gives an interactive and ultra-convenient experience.

### Activating top menus directly

You can access and use the Dialling, Messaging, Contacts menu by a simple touch of the screen.

### Touchscreen tips

If you unlock the screen, the screen will switch to the interactive touchscreen keypad.

To select an item touch the icon on the touchscreen. Your KF900 will vibrate when it recognises you've touched an option.



























Quick keys

## THE STATUS BAR

The status bar uses various icons to indicate things like signal strength, new messages and battery life as well as telling you whether your Bluetooth or GPRS is active.

Below is a table which explains the meaning of icons you're likely to see in the status bar.

Icon	Description
	Multitasking
	Network signal strength (number of bars will vary)
	No network signal
	Remaining battery life
	Battery empty
	New text message
	Multimedia Message
	New voice message
	Message inbox is full
	Message sending failed
	An alarm is set
	Normal profile in use

Icon	Description
	Outdoor profile in use
	Silent profile in use
	Calls are diverted
	EDGE in use
	Roaming
	Flight mode is on
	Bluetooth is active
	Set the schedule
	View the status of external memory
	HSDPA in use
	Play the MP3 file
	Pause the MP3 file
	Wifi on

## CHANGING YOUR STATUS FROM THE STATUS BAR

Touch the current status icon that represents your current setting in the status bar to open the Status Summary. It shows the current Time, Network, SVC ID, Battery, Handset memory, External Memory, Profile, MP3, Bluetooth and Wifi status. You can set Profile type, play/pause MP3 and activate/deactivate Bluetooth and Wifi.

## USING THE MULTITASKING FUNCTION

Press  side key to open the Multitasking menu. From here you can view all the applications you have running and access them with one touch.

From any application, press the Multitasking key and select Home screen to return to the standby screen without exiting or closing the application.

When you have an application running in the background (e.g. a game or the FM radio),  will appear in the status bar.

Touch  in the standby screen to open a **Top menu**. From here you can access further menus: **Communicate**, **Entertainment**, **Utilities** and **Settings**.



## Communicate

- 1 Dialling
- 2 Speed dials
- 3 Contacts
- 4 Call history
- 5 New message
- 6 New Email
- 7 Message box
- 8 Messaging



## Entertainment

- 1 Gallery
- 2 My stuff
- 3 Camera
- 4 Video camera
- 5 Muvee studio
- 6 Music
- 7 FM radio
- 8 Games & apps



## Utilities

- 1 Browser
- 2 World time
- 3 Organiser
- 4 Alarms
- 5 Memo
- 6 Voice recorder
- 7 Tools
- 8 STK (SIM Tool Kit)





## Settings





- 1 Profiles
- 2 Screen settings
- 3 Phone settings
- 4 Call settings
- 5 Touch settings
- 6 Connectivity
- 7 Bluetooth
- 8 Wi-Fi

## CALLS

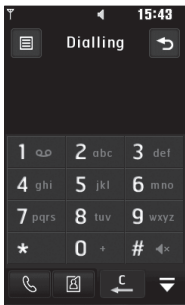
### MAKING A CALL OR VIDEO CALL

1. Touch  to open the keypad.
2. Key in the number using the keypad. To delete a digit press the clear key.
3. Touch the  hard key to initiate the call.
4. To end the call press the  hard key.





- : Makes a voice call
- : Makes a video call
- : Delete a number or character
- : Exits the dialling keypad

To enter + for making an international call, touch  for two seconds.

Touch the lock/unlock key to lock the touchscreen to prevent calls being made by mistake.

You can Make video call, Send message, Save number or Search contacts by tapping  .

### CHANGING THE SETTING OF DIALLING KEYPAD DISPLAY

1. Touch  to open the keypad.
2. Touch  and select **Dial screen setting** to change the display of dialling pad.
3. You can change the font style, size and colour.

### MAKING A CALL FROM YOUR CONTACTS

1. From the standby screen touch  to open the address book, or touch **Contacts** in Communicate tab.
2. You can choose from **Add contact, Search, Groups, and Settings**.
3. Choose **Search**, touch **Name** and enter the first few letters of the contact you would like to call.
4. From the filtered list, touch the contact you'd like to call and select the number to use if you have more than one saved.
5. Touch **Call**.

You can search your contacts from the call screen. Touch  and choose Search contacts. Scroll through your contacts or enter the first few digits of a number to filter the list.

## ANSWERING AND REJECTING A CALL

When your phone rings press the  hard key to answer the call.

Press the  hard key to reject an incoming call.

## Adjusting the call volume

To adjust the volume during a call, use the up and down buttons on the left side of the phone.

## Speed dialling





You can assign a frequently-called contact to a speed dial number.

1. From the standby screen touch  to open the menu.
2. Touch **Speed dials**.
3. Your Voicemail and Videomail are already set to speed dial 1. You cannot change this. Touch any other number to assign it a speed dial contact.
4. Your address book will open. Select the contact you'd like to assign to that number by touching the phone number once.

To call a speed dial number, touch  from the standby screen then press and hold the assigned number until the contact appears on screen. The call will initiate automatically, there's no need to press

 .

## Making a second call

1. During your initial call, touch  and select the number you want to call.
2. Dial the number or search your contacts (see **Making a call or video call** on page 24 for details).
3. Press  to connect the call.
4. Both calls will be displayed on the call screen. Your initial call will be locked and the caller put on hold.
5. To change between the calls, touch  and choose **Swap call** or press the number of the held call.
6. To end one or both calls press  and select **End call** followed by **All calls**, **Held call** or **Active call**.

**You can combine your calls by selecting **Accept** then **Join**. Check that your network provider supports conference calling.**

**You will be charged for each call you make.**

## Turning off DTMF

DTMF allows you to use numerical commands to navigate menus within automated calls. DTMF is switched on as default.

To turn it off during a call (to make a note of a number for example) touch  and select DTMF off.

## Viewing your call logs

To scroll through a list of options, touch the last item visible and slide your finger up the screen. The list will move up so more items are visible.

Touch  and select  **Communicate** and tap **Call history**.

Choose to view:

- **All calls:** View a complete list of all your dialled, received and missed calls.
- **Dialled calls:** View a list of all the numbers you have called.
- **Received calls:** View a list of all the numbers that have called you.
- **Missed calls:** View a list of all the calls you have missed.

From any call log touch  and **Delete all** to delete all the recorded items.

Touch any single call log entry to view the date, time and duration of the call.



## Using call divert

1. Touch , select **Setting** and choose **Call settings**.
2. Touch **Call Divert** and choose **Video calls** and/or **Voice calls**.
3. Choose whether to divert all calls, when the line is busy, when there is no answer or when you are not reachable.
4. Input the number you'd like to divert to.
5. Touch **Request** to activate.

Charges are incurred for diverting calls. Please contact your network provider for details.



To turn off all call diverts, choose **Deactivate all** from the **Call divert** menu.

## Using call barring

1. Touch , select  **Setting** and choose **Call settings**.
2. Touch **Call barring** and choose **Video calls** and/or **Voice calls**.
3. Choose any or all of the six options:
  - All outgoing**
  - Outgoing international**
  - Outgoing international calls except home country**
  - All incoming**
  - Incoming when abroad**
4. Enter the call barring password. Please check with your network operator for this service.



Select Fixed dial number to turn on and compile a list of numbers which can be called from your phone. You'll need your PIN2 code from your operator. Only numbers included in the fixed dial list can be called from your phone.

## Changing the common call setting

1. Touch , select  **Setting** and choose **Call settings**.
2. Touch **Common settings** (you may have to scroll down to see this). From here you can amend the settings for:
  - **Call reject:** Slide the switch to highlight the Reject list. You can touch the text box to choose from all calls, specific contacts or groups, or those from unregistered numbers (those not in your contacts). Touch **Save** to change the setting.
  - **Send my number:** Choose whether your number will be displayed when you call someone.
  - **Auto redial:** Slide the switch left for **On** or right for **Off**.
  - **Answer mode:** Choose whether to answer the phone using the send key or any key.
  - **Minute minder:** Slide the switch left to **On** to hear a tone every minute during a call.
  - **BT answer mode:** Select **Hands-free** to be able to answer a call using a Bluetooth headset, or select **Handset** to press a key on the handset to answer a call.
  - **Save new number:** Select **Yes** to save a new number.
  - **Select line:** You can send your phone number depending on two line service such as line 1 or line 2.

To scroll through a list of options, touch the last item visible and slide your finger up the screen. The list will move up so more items are visible.

## Changing your video call settings



1. Touch , select  **Setting** and choose **Call settings**.
2. Touch **Video call**.
3. Choose the settings for your video calling. Determine whether to Use private picture/ My image size and select one, and/or switch on the Mirror.

## CONTACTS

### Searching for a contact

There are two ways to search for a contact:

#### From the standby screen

1. From the standby screen touch then  to open the address book. To delete a digit press the Clear  hard key.
2. Touch **Call** or the  hard key to initiate the call.

**You can search by group by selecting Groups. This will bring up a list of all your groups.**

#### From the main menu

1. Touch , select **Communicate**.
2. Touch **Contacts**.
3. Touch **Search**.
4. Enter the letters in Name filed.
5. Your address book will bring up a list of the contacts corresponding to the letters you've entered.

**To scroll through your list of contacts, touch the last item visible and slide your finger up the screen. The list will move up so more items are visible.**

### Adding a new contact

1. From the standby screen touch  and select **Add contact**.
2. Choose whether to save the contact to your **Handset** or **USIM**.
3. Enter the first and last name of your new contact. You do not have to enter both, but you must enter one or the other.
4. Enter up to five different numbers and assign a type for each. Choose from **Mobile, Home, Office, Pager, Fax, VT** and **General**. Touch **OK**.
5. Add an email.
6. Assign the contact to one or more groups. Choose from **No group, Family, Friends, Colleagues, School** or **VIP**.
7. You can also add a **Ringtone, Birthday, Anniversary, Homepage, Home address, Company name, Job title, Company address** and a **Memo**.
8. Touch **Save** to save the contact.

**You can create customised groups for your contacts, see Creating a group on page 31.**

## Contact options

There are many things you can do when viewing a contact. Here's how to access and use the options menu:

1. Open the contact you'd like to use. See

**Searching for a contact** on page 30.

2. You can call or send a message directly from here.



3. Press  to open the list of options.

From here you can:

- **Make a video call:** Video call the contact.
- **Edit:** Change any of the contact's details.
- **Delete:** Delete the contact. Touch **Yes** if you are sure.
- **Copy or Move to USIM/Handset:** Choose to move or copy to the USIM card or handset (depending on where you originally saved the contact).
- **Send business card:** Send the contact's details to another person as a business card. Choose to send as a **Text message**, **Multimedia message**, **Email** or via **Bluetooth**.

**Send message - Send a message to the contact. If the contact has an email address, select whether you'd like to send an email or SMS/MMS. See page 35 for details on how to send messages.**

## Creating a group

1. From the standby screen touch  and touch  and select **Groups**.
2. Touch .
3. Select **Add group**.
4. Enter a name for your new group.
5. Touch **Save**.



**If you delete a group, the contacts which were assigned to that group will not be lost. They will remain in your address book.**

**You can edit an existing group by highlighting it and touching . Choose to Add members to the group from your contacts, assign a Group ringtone, Rename the group or Delete a group.**

## Changing your contact settings



You can adapt your contact settings so that your address book suits your own preferences.

**To scroll through a list of options, touch the last item visible and slide your finger up the screen. The list will move up so more items are visible.**

1. From the standby screen touch  touch  and select **Settings**.
2. From here you can adjust the following settings:
  - **Contact list settings:** Choose whether to view contacts saved to both your **Handset & USIM**, **Handset only** or **USIM only**. You can also choose to show the first name or last name of a contact first.
  - **Synchronise contact:** Connect to your server to synchronise your contacts.
  - **Copy:** Copy your contacts from your USIM to your handset or from your handset to your USIM. Choose to do this one at a time, or all at once. If you select one at a time, you'll need to select each contact to copy one by one.
  - **Move:** This works in the same way as Copy, but the contact will only be saved to the location you've moved it to. So, if you move a contact from the USIM to the handset it will be deleted from the USIM memory.

- **Send all contacts via Bluetooth:** Send all of your contacts to another device using Bluetooth. You will be prompted to turn on Bluetooth if you select this option.
- **Backup contacts:** See **Backing up and restoring your phone's information** on page 76.
- **Restore contacts:** See **Backing up and restoring your phone's information** on page 76.
- **Clear contacts:** Delete all your contacts. Touch **Yes** if you are sure you want to wipe your address book.

## Viewing information

1. From the standby screen touch  touch  and touch **Information**.
2. From here you can view your **Service dial numbers**, your **Own number**, your **Memory info**. (how much memory space is left) and **My business card**.



**If you've yet to add a business card for yourself, select My business card and enter all your details as you would for any contact. Touch Save to finish.**

# MESSAGING

## Messaging

Your KF900 combines SMS, MMS and email into one intuitive and easy to use menu.

There are two ways to enter the messaging centre:

1. Touch  from the standby screen.
2. Touch  from the standby screen, then select  **Communicate** then **Messaging**.

## Sending a message

1. Touch **New message** in Communicate tab to open a blank message or select **Create new message** in Messaging menu.
2. From here you can send a text message or Multimedia message. To send an email, choose **New Email** in Communicate tab.
3. Touch **Insert**, to add an image, video, sound or template.

4. Touch Recipient at the left hand side bottom and touch **To1** at the top of the screen to enter the recipient's number, or touch the search icon to open your address book. Touch **Send**. Enter the phone number or touch **Contacts** to open your contacts list. You can add multiple contacts.

**You will be charged per 160 character text message for each person that you send the message to.**

**If an image, video or sound is added to an SMS it will be automatically converted to an MMS and you will be charged accordingly.**



**Quick reply - Send a reply promptly to the selected message using a template.**

## Entering text

There are three ways to enter text: T9 text mode/ Normal text mode/Qwerty keypad.

Tap the screen once, the keyboard appears.



-  Touch to turn on T9 predictive text.
-  You can choose the writing language.
-  Tap to change numbers, symbols and texts keypad.

Use  to scroll through the different keyboard types in each text entry mode (for example, capitals or lower case).

To enter a space touch .

To delete character or remove the sentence, touch clear .

Simply touch each letter to write your message and press:



to switch to upper case



to add a space

## T9 predictive

In T9 mode you will see .

T9 mode uses a built-in dictionary to recognise words you're writing based on the key sequences you touch. Simply touch the number key associated with the letter you want to enter, and the dictionary will predict the word you want to use. For example, press 8, 3, 5, 3, 7, 4, 6, 6, 3 to write 'telephone'.

If the word you want doesn't appear, touch **Spell**. If you touch **Spell** you can then enter the word using Abc manual mode and your word or name will be added to the dictionary.

## Abc manual

In Abc mode you must touch the key repeatedly to enter a letter. For example, to write 'hello', touch 4 twice, 3 twice, 5 three times, 5 three times again, then 6 three times.

## QWERTY KEYPAD

### Entering text

You can enter alphanumeric characters using the phone's keypad. For example, storing names in Contacts, writing a message and creating scheduling events in the calendar all require entering text. The following text input methods are available in the phone: ABC manual mode and 123 mode.

**Some fields may allow only one text input mode (e.g. telephone number in address book fields).**

To input a symbol in the text entry field, press the  key and select a symbol, then select **OK**.

Scroll using the navigation keys to show more symbol options.

Complete each word with a space by pressing .

To delete a character, press  key.

### Text input mode using the keypad

When you are required to enter text, for example when writing a message, the keypad will default to ABC mode. If you are entering a number, for example when making a call, the keypad number keys will default to numbers.

In ABC mode you can enter numbers by first pressing  and then the number you require.

### Sending an email using your new account

To send/receive an email, you should set up an email account (see below).

1. Touch  from the standby screen, and select **Messaging**.
2. Choose Create new message- **Email** and a new email will open. Or, if you select **New Email** in Communicate tab, you can enter this menu directly.
3. You can enter the recipient's address and write your message. You can also attach images, videos, sounds or other file types.
4. Enter your message using the keypad.
5. Select **Options** and choose an attachment to add: **Image/Video/Sound/Template/Emoticon/Bcc/Singture/Name&Number/More (Business card/Schedule/Memo/To do /My business card/FlashContents/Documents/Other files)**.

## Setting up your email

You can stay in touch on the move using email on your KF900. It's quick and simple to set up a POP3 or IMAP4 email account. If you complete setting up e-mail account, "Update inbox now?" message will be displayed. You can receive the e-mail of selected account.

**To scroll through a list of options, touch the last item visible and slide your finger up the screen. The list will move up so more items are visible.**

1. Touch  from the standby screen, and touch **Messaging**.
2. Select **Settings**.
3. Touch **Mailbox** then **Email accounts**.
4. Touch **Add account**.
5. You can now choose how your account works:
  - **Email address:** Enter the e-mail address.
  - **Password:** Enter the account's password.
  - **Username:** Enter the account's username.
  - **Mailbox type:** Enter the mailbox type, POP3 or IMAP4.
  - **Incoming server:** Enter the incoming email server address
  - **Outgoing server:** Enter the outgoing email server address

- **SMTP authentication:** Choose the security settings for the outgoing mail server

- **Account name**



Now your account is set up, it will appear in the list of accounts in your Email folder.

## Retrieving your email

You can automatically or manually check your account for new emails. See

**Changing your email settings** on page 37 to check automatically.

To check manually:

1. Touch  then **Messaging**.
2. Select **Mailbox**.
3. Touch the account you want to use then  .
4. Choose **Retrieve or Sync** and your KF900 will connect to your email account and retrieve your new messages.

## Changing your email settings

You can change your email settings according to your own preferences.

**To scroll through a list of options, touch the last item visible and slide your finger up the screen. The list will move up so more items are visible.**

1. Touch  from the standby screen, and touch **Messaging**.
2. Select **Settings**.
3. Touch **Mailbox** and then you can adapt the following settings:
  - **Email accounts:** Set up the Email account.
  - **Allow reply Email:** Choose to allow the sending of read confirmation messages.
  - **Request reply Email:** Choose whether to request read confirmation messages.
  - **Retrieve interval:** Choose how often your KF900 checks for new email messages.
  - **Retrieve amount:** Choose the number of emails to be retrieved at one time.
  - **Include message in Fwd & Reply:** Choose to include the original message in your reply.
  - **Include attachment:** Choose to include the original attachment in any reply.
  - **Auto Retrieval in Roaming:** Choose whether to retrieve your messages automatically when abroad (roaming).

- **New email notification:** Choose whether to be alerted to new emails.
- **Signature:** Create an email signature and switch this feature on.
- **Priority:** Choose the priority level of your email messages.

## Message folders

You'll recognise the folder structure used on your KF900, which is fairly self-explanatory.

- **Inbox:** All the messages you receive are placed into your inbox. From here you can view, delete and more, see **Managing your messages** below for details. You can enter this menu through **Message box**.
- **Mailbox:** All the emails you receive on your KF900 will be placed in your mailbox.
- **Drafts:** If you don't have time to finish writing a message, you can save what you've done so far here.
- **Outbox:** This is a temporary storage folder while messages are being sent.
- **Sent items:** All the messages you have sent are placed in this folder.
- **My Folders:** Create folders to store your messages.

## Managing your messages

You can use your Inbox to manage your messages.

To scroll through a list of options, touch the last item visible and slide your finger up the screen. The list will move up so more items are visible.

1. Touch **Messaging** then **Inbox**. Or, you can enter this menu through **Message box** in Communicate tab.
2. Touch  and then choose to:
  - **Delete:** Delete marked messages.
  - **Change view:** You can change the style of message display.
  - **Create new message:** Open a new blank message or email.
  - **Move to my folders:** Move the marked messages to My folders.
  - **Filter:** View your message by type. This will group only text message separately from MMS.
  - **Delete all:** Delete all of the messages.

If you see the message **No space for USIM messages** you should delete some messages from your inbox. If you see the message **No space for messages** you can delete either messages or saved files to create space.

## Using templates

Create templates for the SMS and MMS messages you send most frequently. You'll find some templates already on your phone, you can edit these if you wish.

1. Touch **Messaging** then choose **Templates**.
2. Choose **Text templates** or **Multimedia templates**. You can then touch  to **Add new**, **Delete** or **Delete all** templates.

## Using emoticons

Live up your messages using emoticons. You'll find some commonly used emoticons already on your phone.

1. Touch **Messaging** then choose **Emoticons**.
2. Touch  to **Add new**, **Delete** or **Delete all** emoticons.

## Changing your text message settings

Your KF900 message settings are pre-defined so that you can send messages immediately. These settings can be changed according to your preferences.

**To scroll through a list of options, touch the last item visible and slide your finger up the screen. The list will move up so more items are visible.**

Touch **Messaging** then choose **Settings** and **Text message**. You can make changes to:

- **Text message centre:** Enter the details of your message centre.
- **Delivery report:** Slide the switch to the left to receive confirmation that your messages have been delivered.
- **Validity period:** Choose how long your messages are stored at the message centre.
- **Message types:** Convert your text into **Voice, Fax, X.400** or **Email**.
- **Character encoding:** Choose how your characters are encoded. This impacts the size of your messages and therefore data charges.
- **Send long text as:** Choose to send long messages as Multiple SMS or as MMS.

## Changing your multimedia message settings

Your KF900 message settings are pre-defined so that you can send messages immediately. These settings can be changed according to your preferences. Touch **Messaging** then choose **Message settings** and **Multimedia message**. You can make changes to:

- **Retrieval mode:** Choose **Home** or **Roaming network**. If you then choose **Manual** you will receive only notifications of MMS and you can then decide whether to download them in full.
- **Delivery report:** Choose to allow and/or request a delivery report.
- **Read reply:** Choose to allow and/or send a read reply.
- **Priority:** Choose the priority level of your MMS.
- **Validity period:** Choose how long your message is stored at the message centre.
- **Slide duration:** Choose how long your slides appear on screen.
- **Creation mode:** Choose your message creation mode.
- **Delivery time:** Choose how long before a message is delivered.
- **Multi msg. centre:** Enter the details of your message centre.

## Changing your other settings

Touch **Messaging**, choose **Settings** then:

- **Voicemail:** Touch  to add a new Voicemail service. Contact your network operator for more information on the service they provide.
- **Service message:** Choose to receive or block service messages. You can also set your message security by creating trusted and untrusted lists of senders.
- **Info service:** Choose your reception status, language and other settings.

## CAMERA

### Taking a quick photo

1. Press the  key on the right side of the phone.
2. The viewfinder will appear on screen.
3. Holding the phone horizontally, point the lens towards the subject of the photo.
4. Slightly press the capture button, a focus box will appear in the centre of the viewfinder screen.
5. Position the phone so you can see the subject of your photo in the focus box.
6. When the focus box turns green and the tone sounds the camera has focused on your subject.
7. Press the capture button fully.

### After you've taken your photo

Your captured photo will appear on screen. The name of the image runs along the bottom of the screen together with five icons down the right side.



-  Go to gallery of pictures directly.
-  Touch to send the photo as a message, e-mail or Bluetooth.
-  Touch to edit the image by using various tools.
-  Touch to set the picture you have taken as Wallpaper.
-  Touch to delete the photo you have just taken and confirm by touching **Yes**. The viewfinder will reappear.
-  Touch to take another photo straightaway. Your current photo will be saved.

## Getting to know the viewfinder

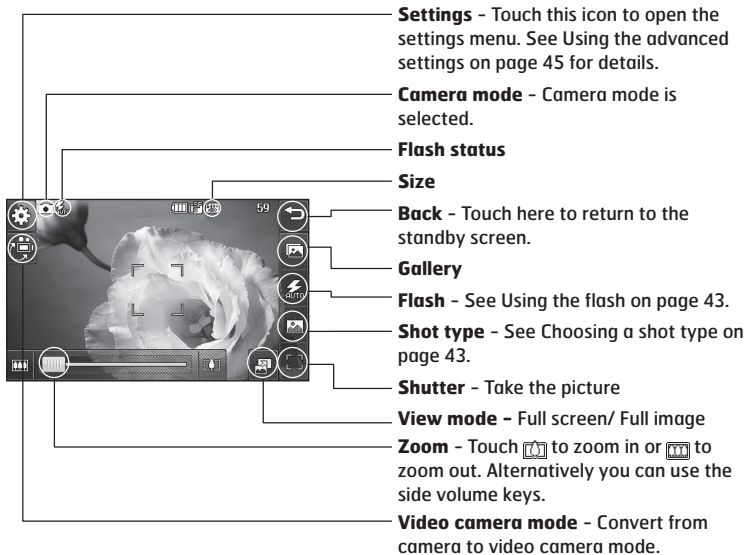

The shortcut options disappear after a few seconds automatically. Simply touch the centre of the viewfinder once. To recall the options touch the screen again.

## Using the flash

The flash is set to auto as default, but there are other options.

1. Select  from the right side of the viewfinder to enter the flash sub-menu.
2. There are three flash options:
  - **Auto:** Your camera will assess the lighting needed to take a good picture and use the flash as necessary.
  - **Always on:** The flash will always be on.
  - **Always off:** The camera will never flash. This is useful if you want to save battery power.
  - **When taking:** The camera will flash when taking a picture.
3. Touch the flash option you'd like to use.
4. When you've made your selection the flash menu will automatically close, ready for you to take your picture.
5. The flash status icon in the viewfinder will change according to your new flash mode.

## Choosing a shot type

1. Touch  to open the available shot types.
2. Choose from three options:
  - **Normal shot:** This is the default shot type, the photo will be taken in the normal way, as outlined in taking a quick photo.
  - **Burst shot:** This enables you to take nine shots automatically in very quick succession.
  - **Panorama:** This shot type is great for taking a photo of a large group of people or for capturing a panoramic view.

## Taking a burst shot

1. Touch  open the available shot types and select **Burst shot** then choose the number of shots.
2. Position the subject in the viewfinder and press the capture button as you would to take a normal photo.
3. Automatically all the images will get saved. Select the one you want to keep by touching the thumbnail: once to view and touch Save to save.

## Taking a panoramic shot



Capture life as it appears using a panoramic shot. The camera will let you take three photos, all aligned, and combine them into one wide angle image.

1. Touch  to open the available shot types and select **Panorama shot**.
2. Take the first photo as normal. A ghosted version of the right side of the image will appear in the viewfinder.
3. When you take the second and third photo, line the ghost of the previous image up with the image in the viewfinder.
4. In the photo gallery, the photos will be saved as panoramic image.

**Due to the image size the panoramic photo will appear slightly distorted in the Gallery view. Touch it twice to view it properly.**

## Adjusting the exposure

Exposure defines the difference between light and dark in an image. A low contrast image will appear foggy, whereas a high contrast image will appear much sharper.

1. From the viewfinder touch to open all the advanced settings options.
2. Touch **Exposure**.
3. Slide the contrast indicator along the bar, towards  for a lower exposure, hazier image or towards  for a higher exposure, sharper image.

## Using the advanced settings

From the viewfinder touch  to open all the advanced settings options.

### Preview settings

- **Exposure:** Exposure value refers to the amount of light for a given exposure. When the main subject is darker than the background, increase exposure value. If the subject is much lighter than the background, decrease exposure value.
- **Size:** Change the size of the photo to save on memory space or take a picture preset to the correct size for contact. See **Changing the image size** on page 46.
- **Colour Effect:** Choose a color effect to apply to the photo you're taking. See **Choosing a colour effect** on page 46.
- **White balance:** Choose from Auto, Incandescent, Sunny, Fluorescent or Cloudy.
- **Macro:** Switch on to take close up shots.
- **Self-timer:** The self-timer allows you to set a delay after the capture button is pressed. Choose from **3 seconds**, **5 seconds** or **10 seconds**. Great for that group photo you want to be part of.
- **ISO:** ISO determines the sensitivity of the camera's light sensor. The higher the ISO, the more sensitive the camera will be. This is useful in darker conditions when the flash can't be used. Choose an ISO

value from **Auto**, **ISO 100**, **ISO 200**, **ISO 400** or **ISO 800**.

- **Quality:** Choose between **Super fine**, **Fine** and **Normal**. The finer the quality the sharper a photo will be, but the file size will increase as a result, which means you'll be able to store fewer photos in your memory.
- **Inner/Outer Camera:** For self portraits, switch to the LG KF900's inner camera.

### Other settings

- **Memory:** Choose whether to save your photos to the Handset memory or to the External memory.
- **Image stabilization:** Enables you to take a photo without camera instability or shake.
- **Focus:** Choose from On or Off.
- **Shutter sound:** Select one of the three shutter sounds.
- **Grid screen:** Choose from Off, Simple cross or Trisection
- **Reset settings:** Reset all the camera settings.

**When you exit the camera all your settings will return to default, except image size and image quality. Any non-default settings you require will need to be reset, for example colour tone and ISO. Check them before you shoot your next photo.**

The settings menu is super imposed over the viewfinder, so when you change elements of the image colour or quality you'll be able to see the image change in preview behind the settings menu.

## Changing the image size

The more pixels, the larger the file size, which in turn means they take up more of your memory. If you want to fit more pictures on to your phone you can alter the pixel number to make the file size smaller.

1. From the viewfinder touch  in the top left corner.
2. Select **Size** from the Preview menu.
3. Select a pixel value from the six numerical options (**5M: 2592x1944**, **3M: 2048x1536**, **2M: 1600x1200**, **1M: 1280x960**, **640x480**, **320x240**) or choose the preset:



## Choosing a colour effect

1. From the viewfinder touch  in the top left corner.
2. Select **Colour Effect** from the Preview menu.
3. There are five colour tone options: **Off**, **Black & White**, **Negative** or **Sepia**.
4. When you've made your selection the colour tone menu will be closed after selecting back icon, ready for you to take your picture.

You can change a photo taken in colour to black and white or sepia after it's taken, but you cannot change a picture taken in black and white or sepia back to colour.

## VIDEO CAMERA





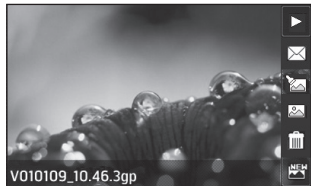

### Shooting a quick video

1. Touch **Video camera** in Entertainment tab.
2. The video camera's viewfinder will appear on screen.
3. Holding the phone horizontally, point the lens towards the subject of the video.
4. Press the capture button once to start recording.
5. **REC** will appear at the top of the viewfinder and a timer at the bottom showing the length of your video.
6. To pause the video touch  and resume by selecting .
7. Touch  on screen or press the capture button a second time to stop recording.

### After you've shot your video

A still image representing your captured video will appear on screen. The name of the video runs along the bottom of the screen together with five icons down the right side .



-  Touch to play the video.
-  Touch to send the video as **Message**, **Email** or by **Bluetooth**. See page 33 for **Sending a message**, or page 85 for **Sending and receiving your files using Bluetooth**.
-  Touch to edit video file.
-  Touch to view a gallery of saved videos.
-  Touch to delete the video you have just made and confirm by touching **Yes**. The viewfinder will reappear.
-  Touch to shoot another video straight away. Your current video will be saved.

## Getting to know the viewfinder

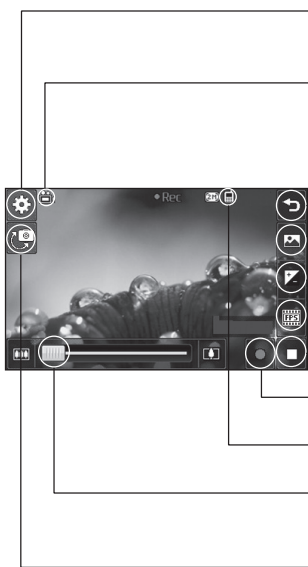

**Settings** - Touch this icon to open the settings menu. See **Adjusting the exposure** on page 49 for details.

**Video mode** - Video mode is selected.

**Back** - Touch here to return to the standby screen.

**Gallery**



**Brightness** - See Adjusting the Exposure on page 49.

**Recording speed**

**Recording stop**

**Recording start**

**Saving to handset memory/external memory**



**Zoom** - Touch  to zoom in or  to zoom out. Alternatively you can use the side volume keys.

**Camera mode** - Change from video camera to camera mode.

The shortcut options disappear after a few seconds automatically. Simply touch the centre of the viewfinder once. To recall the options touch the screen again.

## Adjusting the Exposure

Exposure defines the difference between light and dark in an image. A low contrast image will appear foggy, whereas a high contrast image will appear much sharper.

1. Touch .
2. Slide the exposure indicator along the bar, towards  for a lower exposure, hazier image, or towards  for a higher contrast, sharper image.

## Using the advanced settings

From the viewfinder touch **Settings** to open all the advanced settings options.

### Preview settings

- **Video size:** Change the size of the video to save on memory space. See **Changing the video image size** on page 50.
- **Colour Effect:** Choose a colour effect to apply to the video you're taking. See **Choosing a colour effect** on page 50.
- **White balance:** The white balance ensures that any white in your videos is realistic. In order for your camera to correctly adjust the white balance you may need to determine the light conditions. Choose from **Auto**, **Incandescent**, **Sunny**, **Fluorescent** or **Cloudy**.

- **Quality:** Choose between **Super fine**, **Fine** and **Normal**. The finer the quality the sharper a video will be, but the file size will increase as a result, which means you'll be able to store fewer videos in the phone's memory.
- **Set time:** Set a duration limit for your video. Choose from **No limit**, or **MMS** to limit the size to be able to send the video as an MMS.

**If you choose MMS duration, try choosing a lower image quality to enable you to shoot a longer video.**

- **Inner camera:** Switch to your KF900's inner camera to record a video of yourself.

### Other settings

- **Memory:** Choose whether to save your videos to the **Handset memory** or to the **External memory**.
- **Voice:** Choose Mute to record a video without sound.
- **Reset settings:** Reset all the video camera settings.

## Changing the video image size

The more pixels, the larger the file size, which in turn means they take up more memory. If you want to fit more videos onto your phone you can alter the pixel number to make the file size smaller.

1. From the viewfinder touch **Settings** in the top left corner.
2. Select **Video size** from the Preview menu.
3. Select a pixel value from the five options:
  - 720x480(D1), 640x480(VGA)** - The highest quality widescreen option.
  - 400x240 (Wide)** - This is also widescreen, but of a lower resolution.
  - 640x480 (VGA)** - Standard sized VGA.
  - 320x240 (QVGA)** - Smaller image size, therefore smaller file size. Great for saving on memory space.
  - 176x144 (QCIF)** - Smallest image size and therefore smallest file size.
4. Select the size option you'd like to use.

**For video format conversion software, see the CD you received with your KF900.**

## Choosing a color effect



1. From the viewfinder touch  in the top left corner.
2. Select **Colour Effect** from the settings menu.
3. There are five colour tone options, **Off, Black & White, Negative, Sepia**.
4. Touch the colour tone you'd like to use.

**You can change a video shot in colour to black and white or sepia after it's taken, but you cannot change a video shot in black and white or sepia back to colour.**

**You can still alter the image size, video quality, duration, mute, white balance, colour tone and the memory by touching Settings in the same way as when using the main camera.**

## YOUR PHOTOS AND VIDEOS

### Viewing your photos and videos

1. Touch  on your camera preview screen.
2. Your gallery will appear on screen.
3. Touch the video or photo twice to open it fully.
4. Videos will begin to play automatically. To pause playback touch the screen to bring up the options and select .

**Flick left or right to view other photos or videos.**

**To delete a photo or video, open it and select . Touch Yes to confirm.**

### Using zoom when viewing a photo

Use the thumbnail in the bottom right corner to move the focus area.

### Adjusting the volume when viewing a video





To adjust the volume of the audio on a video whilst it is playing, slide the marker up and down the volume bar on the left side of the screen.

### Viewing your photos as a slide show

Slideshow mode will show all the photos in your gallery one at a time as a slideshow. Videos can not be viewed as a slideshow.

1. Touch the photo you would like to begin the slideshow twice to open it.
2. Select .
3. The slideshow will begin.

There are options within slideshows:

-  Touch again to resume playback.
-  Touch to pause the slideshow on a particular photo.
-  Random On/ Off
-  Touch to increase or decrease the speed of the slideshow.



### Setting a photo as wallpaper

1. Touch the photo you would like to set as wallpaper twice to open it.
2. Touch .
3. The screen will switch to portrait mode. You can change the size of the picture.
4. When you are happy with the picture touch **Set**.

## Editing your photos

There are loads of great things you can do to your photos to change them, add to them or liven them up a little.





1. Open the photo you'd like to edit and touch **Edit** to bring up the options.
2. Touch the icons to adapt your photo:
  -  **Crop** your photo. Choose a square or circular crop area and move your finger across the screen to select the area.
  -  **Draw** something on your photo freehand. Select the thickness of the line from the four options and the colour you would like use.
  -  **Put writing** on the picture. See **Adding text to a photo** on page 53.

 **Decorate** your photo with stamps. Choose from the different stamps available and touch your photo wherever you'd like them to be.

 **Remove** the drawing line.

 Touch to return to the gallery.

 **Save** the changes you have made to the photos. Select to save the changes over the **Original file**, or as a **New file**. If you select **New file** enter a file name.

 **Undo** the last **Effect** or edit you made to the photo.

 **Add** an effect to a photo by using various tools.



 Touch to open further effect options including **Rotate**. There are also more advanced editing options. See **Morphing a photo**, **Adding a colour accent** and **Swapping the colours in a photo** on page 55.

 See **Adding an effect to a photo** on page 53.

## Adding text to a photo

1. From the editing screen, touch **T**.
2. Select **Signature** to add unframed text or choose one of the speech bubble shapes then touch **OK**.
3. Enter your text using the keypad and touch **Done**.
4. Move the text bubble by touching it and sliding it to the place you'd like it to be.

## Adding an effect to a photo

1. From the editing screen, touch .
2. Choose to apply any of the eighteen options to the photo. Select **OK** icon to apply the changes or choose  to cancel.
  - **Face Beautify:** Automatically detect a face in the image and brighten it up.
  - **Tunnel effect:** Change the effect so that the picture appears to have been taken in a tunnel.
  - **Colour negative:** Colour negative effect.
  - **Black and white:** Black and white colour effect.
  - **Sepia:** Sepia effect.
  - **Blur:** Apply a blurred effect.
  - **Sharpen:** Move the marker along the bar to sharpen the focus of the photo.
  - **Mosaic blur:** Touch to apply a blurred mosaic effect to the photo.
  - **Oil painting:** Oil painting effect.
  - **Sketch:** Apply an effect to make the picture look like a sketch.

- **Emboss:** Emboss effect.
  - **Solarize:** Change the effect of exposure to the light
  - **Vivid:** An effect of clearness and brilliance.
  - **Moonlight:** Change the light to look like moonlight.
  - **Antique:** An old image effect.
  - **Glow:** A light beam effect.
  - **Cartoon:** A cartoon effect.
  - **Water color:** Adjust water color painting.
3. To undo an effect simply touch **Undo**.

**You can add more than one effect to a photo.**

## Resizing a photo

1. From the editing screen touch .
2. Choose **Resize**.
3. Touch your desired size to change the size of the photo.

## Morphing a photo



Morphing a photo is great for changing the facial expressions of friends, or just for distorting a photo for artistic effect.

1. From the editing screen touch .
2. Choose **Morphing** and four crosses will appear on the photo.
3. Move the crosses around the photo so they are on the part you'd like to morph. For example, if you are morphing a face, place a cross on the outside corner of each eye and one each side of the lips.
4. Select a face to represent how you'd like to morph the photo.
5. Select **Save** to save the changes.

## Adding a colour accent to a photo

1. From the editing screen, touch .
2. Choose **Colour accent**.
3. Select part of the photo. A traced line will appear around everything in that area which is of the same or similar colour.  
For example, someone's hair or the colour of their jumper.
4. Touch **Done**.
5. All colour will be removed from the photo, apart from the section marked for colour accenting.
6. Alter the intensity of the accenting by sliding the marker up or down the intensity bar.
7. Select **Save** to save the changes.

## Swapping the colours in a photo

1. From the editing screen, touch .
2. Choose **Colour swapping**.
3. Select part of the photo. A traced line will appear around everything in that area which is of the same or similar colour.  
For example, someone's hair or the colour of their jumper.
4. Touch  and select a colour.
5. Press **OK**.
6. The part of the photo selected for colour accenting will change to the selected colour.
7. Select **Save** to save the changes.

## Watching your videos on your TV

Connect your KF900 to your TV using the TV output cable. Open the video you'd like to watch on TV, select play.

**The TV output cable is available for purchase separately.**





**All formats except 320x240 and 176x144 are compatible with watching on TV.**

## Editing your videos



The editing features are available for all video types except 640X384 and 640x480.

Don't record in these formats if you plan to edit your video.

## Trimming the length of your video

1. Open the video you'd like to edit, select  and touch the screen to bring up the options.
2. Select  and choose **Trim**.
3. Touch  and mark the new start and end points using .
4. Touch **Preview** to ensure you are happy with the new cut.
5. Touch **Save** or, alternatively, touch  to return to the gallery and discard the changes.





## Merging two videos together

1. Open the video you'd like to edit, select  and touch the screen to bring up the options.
2. Select  and choose **Video merge**.
3. The My videos folder will open. Choose the video you would like to merge and touch **Select**.
4. Touch and slide the photo to merge it to the end or the beginning of the video.
5. Touch **Effect** to choose how the videos merge together: **None, Fade out, Pan zoom, Oval, Uncover, Blind, Checker board, Dissolve, Split or Shape diamond**.
6. Press  followed by **Yes** to save the new merged video. Choose to save over the original file or as a new file.
7. Repeat these steps to merge more videos.

## Merging a photo with a video

1. Open the video you'd like to edit, select  and touch the screen to bring up the options.
2. Select  and choose **Image merge**.
3. The My images folder will open. Choose the photo you would like to merge into your video and touch **Select**.
4. Touch and slide the photo to merge it to the end or the beginning of the video.
5. Touch **Effect** to choose how the photo and video merge together: **None, Fade out, Pan zoom, Oval, Uncover, Blind, Checker board, Dissolve, Split** or **Shape diamond**.
6. Press  followed by **Yes**. Choose to save over the original file or as a new file.
7. Repeat these steps to merge more photos.







## Adding text to a video

1. Open the video you'd like to edit, select  and touch the screen to bring up the options.
2. Select  and choose **Text overlay**.
3. Enter your text using the keypad and select **Save**.
4. Touch  and mark when you'd like the text to appear using .
5. Touch the area of the screen you'd like the text to appear in.
6. Touch  to mark when you'd like the text to disappear.
7. Touch **Preview** to ensure you are happy with the text overlay.
8. Touch **Save** followed by **Yes**. Choose to save over the original file or as a new file.
9. Repeat these steps to add more text.



## Overlaying a photo

1. Open the video you'd like to edit, select  and touch the screen to bring up the options.
2. Select  and choose **Image overlay**.
3. The My images folder will open. Choose the photo you would like to overlay your video and touch **Select**.
4. Touch  and mark when you'd like the photo to appear using .
5. Touch the area of the screen you'd like the photo to appear in. If the photo is too big it will overlay the whole screen, not just the area selected.
6. Touch  to mark when you'd like the photo to disappear.
7. Touch **Preview** to ensure you are happy with the photo overlay.
8. Touch  followed by **Yes**. Choose to save over the original file or as a new file.
9. Repeat these steps to add more photos.



## Adding a voice recording

1. Open the video you'd like to edit, select  and touch the screen to bring up the options.
2. Select  and choose **Voice recording**.
3. The quality of the original audio will be affected by adding a voice recording. Touch **Yes** to continue.
4. Touch  to view your video. When you get to the part you'd like to record your voice over, press .
5. Press  to stop recording and playback.
6. Touch **Preview** to ensure you are happy with the voice recording.
7. Touch  followed by **Yes** to save. Choose to save over the original file or as a new file.
8. Repeat these steps to add more voice recordings to the video.



## Adding a soundtrack to your video

1. Open the video you'd like to edit, select  and touch the screen to bring up the options.
2. Select  and choose **Audio dubbing**.
3. The My sounds folder will open. Choose the track you would like to add to your video and touch **Select**.
4. The original audio of your video will be erased. Touch **Yes** to continue.
5. If the audio is shorter than the video choose whether to play **Once** or to **Repeat** it.
6. Choose to save over the original file or as a new file.



## Changing the speed of your video

1. Open the video you'd like to edit, select  and touch the screen to bring up the options.
2. Select  and choose **Time scaling**.
3. Select one of the four speed options: **x4**, **x2**, **x1/4**, **x1/2**.
4. Choose to save over the original file or as a new file.

## Adding a dimming effect

1. Open the video you'd like to edit, select  and touch the screen to bring up the options.
2. Select  and choose **Dimming effect**.
3. Choose to save over the original file or as a new file.
4. Your video will now fade in at the start and fade out at the end.

## MULTIMEDIA

You can store any multimedia files into your phone's memory so that you have easy access to all of your pictures, sounds, videos and games. You can also save your files to a memory card. The advantage of using a memory card is that you can free up space on your phone's memory. To access the Multimedia menu, touch  then  **Entertainment**. Touch **My stuff** to open a list of folders storing all of your multimedia files.

### Pictures

**My images** contains a list of pictures including default images pre-loaded onto your phone, images downloaded by you and images taken on your phone's camera.



### My images option menus

The options which are available to you in **My images** depend on what type of image you have selected. All of the options will be available for pictures you have taken on the phone's camera, but only the **Use as**, **Print**, **Sort by** and **Memory manager** options are available for default images.

**When looking at a picture, turn the phone to landscape to bring up further options on the right side of the screen. Choose from send, slideshow, gallery, edit and delete.**



- **Send:** Send the image to a friend.
- **Move:** Move an image from the phone memory to a memory card or vice versa.
- **Copy:** Copy an image from the phone memory to a memory card or vice versa.
- **Delete:** Delete an image.
- **Rename:** Rename an image.
- **Print:** Print the selected image using a printer supported by Bluetooth.
- **Create new folder:** Create a new folder within the My images folder.
- **Slide show:** Create slide show of selected images.
- **Grid view/ List view:** Grid view to List view or vice versa.
- **Folder info.:** View the information of each folder.
- **Memory manager:** View the memory status.
- **Delete all:** Delete all of your images.

## Sending a photo

1. Touch  then  **Entertainment**.
2. Touch **My stuff** then choose **My images**.
3. Touch , then select send and touch on message or email or bluetooth from the options under send.
4. If you choose **Message** or **Email**, your photo will be attached to a message and you can write and send the message as normal. If you choose **Bluetooth**, you will be prompted to turn Bluetooth on and your phone will search for a device to send the picture to.

## Using an image

You can choose images to use as wallpapers and screensavers or even to identify a caller.



1. Touch  then  **Entertainment**.
2. Touch **My stuff** then **My images**.
3. Select an image and touch  .
4. Touch **Use as** and choose from:
  - **Wallpaper:** Set a wallpaper for the standby screen.
  - **Contacts image:** Allocate an image to a particular person in your contacts list so that the picture shows when they call you.
  - **Incoming call:** Set an image to appear during incoming call.
  - **Outgoing call:** Set an image to appear during outgoing calls.

## Marking up your images

A low- light photo can be adjusted without lowering the quality of the picture.

1. Touch  then **Entertainment**.
2. Touch **My stuff** then **My images**.



## Printing an image

1. Touch  then **Entertainment**.
2. Touch **My stuff** then **My images**.
3. Select an image and touch .
4. Touch **Print** then choose between **Bluetooth** and **PictBridge**.

**You can to print via bluetooth or by connecting to a PictBridge compatible printer.**

## Moving or copying an image

You can move or copy an image between the phone memory and the memory card. You might want to do this to either free up some space in one of the memory banks or to safeguard your images from being lost.

1. Touch  then **Entertainment**.
2. Touch **My stuff** then **My images**.
3. Touch .
4. Select **Move** or **Copy**.



## Creating a slide show

If you want to look at all of the images on your phone, you can create a slide show to save you from having to open and close each individual image.

1. Touch  then **Entertainment**.
2. Touch **My stuff** then **My images**.
3. Touch .

## Checking your memory status

You can check to see how much of your memory space you have used and how much you have left to use.



1. Touch  then **Entertainment**.
2. Touch **My stuff** then **My images**.
3. Touch .
4. Choose **Handset memory** or **External memory**.

**If you do not have a memory card inserted, you will not be able to select External memory.**

## Sounds

The **My sounds** folder contains the Downloaded sounds, **Default sounds** and **Voice recordings**. From here you can manage, send or set sounds as ringtones.

### Using a sound

1. Touch  then  **Entertainment**.
2. Touch **My stuff** then **My sounds**.
3. Select **Default sounds** or **Voice recordings**.
4. Select a sound and it will begin to play.
5. Touch  and select **Use as**.
6. Choose from **Voice ringtone**, **Video ringtone**, **Message tone**, **Start-up** or **Shut down**.

## Videos

The **My videos** folder shows a list of downloaded videos and videos you have recorded on your phone.

Watching a video

1. Touch  then  **Entertainment**.
2. Touch **My stuff** then **My videos**.
3. Select a video to play.

## Using options while video is paused

Touch  while in pause mode and choose from:

- **Send:** Send the video in a message or via Bluetooth, Email.
- **Delete:** Delete the video.
- **Edit :** Offers a range of editing options
- **File info.:** View the Name, Size, Date, Type, Duration and Protection.

**The TV output cable is available for purchase separately.**

## Sending a video clip

1. Select a video and touch  .
2. Touch **Send** and choose from **Message**, **Email** or **Bluetooth**.
3. If you choose **Message** or **Email**, your video clip will be attached to the message and you can write and send the message as normal. If you choose **Bluetooth**, you will be prompted to turn Bluetooth on and your phone will search for a device to send the video to.

## Using the video options menu

From the **My videos** folder, you can choose from the following options:

- **Send:** Send a video to a friend.
- **Move:** Move a video clip from the phone memory to a memory card or vice versa.
- **Copy:** Copy a video clip from the phone memory to a memory card or vice versa.
- **Delete:** Delete a video.
- **Rename:** Rename a video.
- **Create new folder:** Create a new folder within the My videos folder.
- **Sort by:** Sort videos into order by Date, Type or Name.
- **List view/ Grid view:** View the menu by list type or grid type.
- **Folder info.:** View the information of each folder.
- **Memory manager:** View the memory status.
- **Delete all:** Delete all videos.

## Games and Applications

You can download new games and applications to your phone to keep you amused when you have time to spare.

## Playing a game

1. Touch  then  **Entertainment**.
2. Touch **Games & Apps**.
3. Touch **My games and apps**.
4. Touch Games or Applications folder.
5. Choose and touch a game or an application to launch.

## Using the options menu

Within **Games** and **Application** folders, the following options are available:

- **Create new folder:** Create a folder within **Games** or **Applications**
- **Sort by:** Sort the games and applications by **Date**, **Size** or **Name**.
- **Memory manager:** View the memory status handset or external memory.

## Installing a Java game and application

1. Touch  then  **Entertainment**.
2. Touch **My stuff** then **Others** or **My memory card**. If you insert new memory card, you can select **My memory card** menu.
3. Select the file(\*.jad or \*.jar) you want to install and touch **Install**.

## Flash contents

The Flash contents folder contains all of your default and downloaded SWF files.

### Viewing an SWF file

1. Touch  then  **Entertainment**.
2. Touch **My stuff** then **Flash contents**.
3. Select the file to view.

### Using options while viewing the SWF file

Touch  and choose from:

- **Play/Pause:** Play or pause the flash file.
- **Mute:** Switch the sound off.
- **Send:** Send the file as a **MMS**, **Email** or via **Bluetooth**.
- **Main screen theme:** Set the file as your wallpaper.
- **File info.:** View the Name, Size, Date, Time, Type and Protection of the file.
- **Delete:** Remove the selected file.

## Documents

From the Documents menu, you can view all of your document files. From here you can view Excel, Powerpoint, Word, Text and pdf files.



### Transferring a file to your phone

Bluetooth is probably the easiest way to transfer a file from your computer to your phone. You can also use LG PC Suite via your sync cable.

To transfer using Bluetooth:

1. Make sure your phone and computer have Bluetooth switched on and are visible to one another.
2. Use your computer to send the file via Bluetooth.
3. When the file is sent you will have to accept it on your phone by touching **Yes**.
4. The file should appear in your **Documents** or **Others folder**.

## Viewing a file



1. Touch  then  **Entertainment**.
2. Touch **My stuff** then **Documents**.
3. Select a document and touch **View**.

## Others





The **Others** folder is used to store files which are not pictures, sounds, videos, games or applications. It is used in the same way as the **Documents** folder. You may find that when you transfer files from your computer to your phone that they appear in the **Others** folder rather than the **Documents** folder.

If this happens you can move them.

To Move a file from Others to Documents:

1. Touch  then  **Entertainment**.
2. Touch **My stuff** then **Others**.
3. Touch  then **Move**.
4. Select the file you want to move then touch **Move** again.

## Creating a movie

1. Touch  then  **Entertainment**.
2. Touch **Muvee studio**.
3. Touch  to add an image. Touch the images you want to include then select **Insert**.
4. Touch style tab to choose a Muvee style.
5. Touch **Play** button to see what you've created.
6. Touch  then **Order** to make an order.
7. Touch  then **Save Location** to choose where to save the movie. Touch **Music type** to choose between Use To Send and Use To Save.

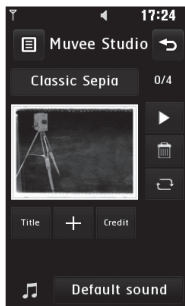

## Music

Your LG KF900 has a built-in music player so you can play all your favourite tracks.

To access the music player, touch  then

 **Entertainment** then **Music**. From here you can access a number of folders:

- **Recently played:** View all of the songs you have played recently.
- **All tracks:** Contains all of the songs you have on your phone.
- **Artists:** Browse through your music collection by artist.
- **Albums:** Browse through your music collection by album.
- **Genres:** Browse through your music collection by genre.
- **Playlists:** Contains any playlists you have created.
- **Shuffle tracks:** Play your tracks in a random order.







## Transferring music onto your phone

The easiest way to transfer music onto your phone is via Bluetooth or your sync cable.

You can also use LG PC Suite, see page 76 for details. To transfer using Bluetooth:

1. Make sure both devices have Bluetooth switched on and are visible to one another.
2. Select the music file on the other device and choose to send it via Bluetooth.
3. When the file is sent you will have to accept it on your phone by touching **Yes**.
4. The file should appear in **Music > All tracks**.

## Playing a song

1. Touch  then  **Entertainment**.
2. Touch **Music**, then **All tracks**.
3. Select the song you want to play and touch **Play**.
4. Touch  to pause the song.
5. Touch  to skip to the next song.
6. Touch  to skip to the previous song.
7. Touch  to return to the **Music** menu.

To change the volume while listening to music, touch .

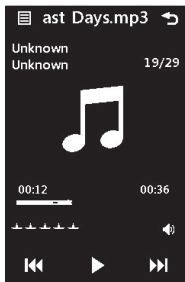



## Using options while playing music

Touch  and choose from:

- **Minimize:** Make the music player screen disappear so that you can continue using your phone as normal.
- **Go to my music:** View your music files
- **Equalizer:** Adjust the sound preferences
- **Send:** Send the song as a message or via Bluetooth
- **Use as:** Use the song as a ringtone. Message tone, Start-up or Shut-down
- **File info:** View information including the Name, Size, Date, Time, Type, Duration, Protection and Copyright of the song.

## Creating a playlist



You can create your own playlists by choosing a selection of songs from the **All tracks** folder.

1. Touch  then  **Entertainment**.
  2. Touch **Music**, then **Playlists**.
  3. Touch **Add new playlist**, enter the playlist name and touch **Save**.
  4. The All tracks folder will show. Touch all of the songs that you would like to include in your playlist; a tick will show next to the track names.
  5. Touch **Done**.
- To play a playlist, select it and touch Play.



**To add a second playlist, touch Add new playlist.**

## Editing a playlist

From time to time, you may want to add new songs or delete songs from a playlist. When you want to do this, you can edit the playlist.

1. Touch  then  **Entertainment**.
2. Touch **Music**, then **Playlists**.
3. Select the playlist.
4. Touch  and select:
  - **Add new songs:** To add more songs to the playlist. Mark the ones you want and touch **Done**.
  - **Remove:** Remove a song from the playlist. Touch **Yes** to confirm.
  - **Memory status:** View the memory status.
  - **Remove all:** Remove all tracks from the playlist.

## Deleting a playlist

1. Touch  then  **Entertainment**.
2. Touch **Music**, then **Playlists**.
3. Touch  then Delete, select the playlists which you want to delete then **Delete** or **Delete all** to delete all the playlists.

## Using the radio



Your LG KF900 has an FM radio feature so you can tune into your favourite stations to listen to on the move.



**You will need to insert your headphones in order to listen to the radio. Insert them into the headphone socket (this is the same socket that you plug your charger into).**



## Searching for stations

You can tune radio stations into your phone by searching for them either manually or automatically. They will then be saved to specific channel numbers so you don't have to keep re-tuning. You can save up to 50 channels in your phone.



### To auto tune:

1. Touch  then  **Entertainment**.
2. Touch **FM radio** then .
3. Touch **Auto scan** then **Yes**. The stations found will automatically be allocated to channel numbers in your phone.



**You can also manually tune into a station by using  and  displayed next to the radio frequency or dragging the tuner on the touch screen.**

**You can also search next station by using  and .**

## Resetting channels

1. Touch  then  **Entertainment**.
2. Touch **FM radio** then .
3. Choose **Reset** to reset the current channel or choose **Reset all** to reset all of the channels. Each channel will return to the starting 87.5Mhz frequency.

## Listening to the radio

1. Touch  then  **Entertainment**.
2. Touch **FM radio** then touch the channel number of the station you would like to listen to.

**To improve the radio reception, extend the headset cord, which functions as the radio antenna.**



## ORGANISER

### Adding an event to your calendar

1. From the standby screen select , then touch  **Utilities** and choose **Organiser**.  
Select **Calendar**.
2. Select the date you would like to add an event to.
3. Touch  then **Add event**.
4. Touch **Category** then choose from **Appointment**, **Anniversary** or **Birthday**.  
Check the date and enter the time you would like your event to begin.
5. For appointments and anniversaries enter the time and date your event finishes in the lower two time and date boxes.
6. If you would like to add a subject or a note to your event, touch **Note** and type in your note, followed by **Save**.
7. Set **Alarm** and **Repeat**.
8. Select **Save** and your event will be saved in the calendar. A square cursor will mark the day that any events have been saved to and a bell will ring at the start time of your event, so that you can stay organised.

You can set a holiday in your calendar. Touch each day you are on holiday one at time, then touch  and select **Set holiday**. Each day will be shaded red.



### Changing your default calendar view

1. From the standby screen select , then touch  **Utilities** and choose **Organiser**.  
Select **Settings**.
2. Touch **Calendar** and choose either **Month view** or **Week view in Default view menu**.
3. Set **Week starts on** to start the day of week.
4. Press **Save** to confirm your choice.

### Adding an item to your to do list

1. From the standby screen select , then touch **Utilities** and choose **Organiser**.
2. Select **Add to do**.
3. Set the date for the to do item, add notes and select a priority level: **High**, **Medium** or **Low**.
4. Save your to do list item by selecting **Save**.

## Sharing a to do item



1. From the standby screen select , then touch  **Utilities** and choose **Organiser**. Select **To do**.
2. Select the to do item you would like to share, then touch .
3. Select **Send**. You can choose to share your to do item by **Text message**, **Multimedia msg.**, **Email** or **Bluetooth**.

**Tip: You can back up and synchronise your calendar with your computer.**

## Using date finder

Date finder is a handy tool to help you calculate what the date will be after a certain amount of days has passed. For example, 60 days from 10.10.07 will be 09.12.2007.



This is great for keeping tabs on deadlines.

1. From the standby screen select , then touch  **Utilities** and choose **Organiser**.
2. Select **Date finder**.
3. In the **From** tab set your required date.
4. In the **After** tab set the number of days.
5. The **Target date** will be shown below.

## Setting your alarm

1. From the standby screen select , then touch  **Utilities** and choose **Alarms**.
2. Touch **Add alarm**.
3. Set the time you would like the alarm to sound and touch **Set time**.
4. Choose whether you would like your alarm to repeat Once, Daily, Mon - Fri, Mon - Sat, Sat - Sun, Except holiday or Choose weekday. The icons indicate the weekday you select.
5. Select **Set alarm type** to select a type for your alarm.
6. Touch **Alarm tone** then choose a sound from **My sounds** or **My memory card**. To listen to sounds touch the sound, followed by .
7. Add a memo for the alarm. Touch **Save** when you have finished typing the memo.
8. Finally you can set the snooze interval at 5, 10, 20, 30 minutes, 1hour or off.
9. Once you have set your alarm, touch **Save**.



## Adding a memo

1. From the standby screen select , then touch  **Utilities** and choose **Add Memo**.
2. Type your memo, followed by **Save**.
3. Your memo will appear on screen next time you open the **Memo** application.





**You can edit an existing memo. Select the one you want to edit and type your changes.**

## Voice recorder

Use your voice recorder to record voice memos or other sounds.

1. Touch , then touch  **Utilities**.
2. Touch **Voice recorder** then  and choose from:
  - **Settings**
    - **Duration:** Set the recording duration. Choose from **MMS message size**, **1 minute** or **No limit**.
    - **Quality:** Select the sound quality. Choose from Super Fine, Fine or Normal.
    - **Memory in use:** Check the current status of memory.
  - **Go to my sounds:** Open the Voice recordings folder in **My sounds**.

## Recording a sound or voice

1. Touch , then touch  **Utilities**.
2. Touch **Voice recorder**.
3. Touch  to begin recording.
4. Touch  to end recording.
5. Touch  to listen to your recording.

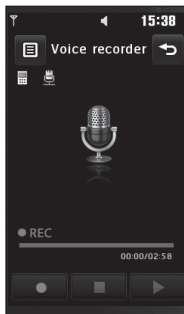



## Sending the voice recording



1. Once you have finished recording, touch  .
2. Touch **Send via** and choose from **Message, Email** or **Bluetooth**. If you choose **Message** or **Email**, the recording will be added to the message and you can write and send it as normal. If you choose **Bluetooth**, you will be prompted to turn Bluetooth on.

**After you have finished recording, touch  and choose Send via, File > Rename, Delete, Use as (to use the recording as your ringtone Settings) or Go to my sounds.**



## Using your calculator

1. From the standby screen select  , then touch  **Utilities** and choose **Tools**.
2. Select **Calculator**.
3. Touch the numeric keys to input numbers.
4. For simple calculations, touch the function you require (+, -, \*, /), followed by =.
5. For more complex calculations, touch  and choose from **sin, cos, tan, log, ln, exp, deg** or **rad** etc..



## Converting a unit

1. From the standby screen select  , then touch  **Utilities** and choose **Tools**.
2. Select **Converter**.
3. Choose whether you would like to convert **Currency, Surface, Length, Weight, Temperature, Volume** or **Velocity**.
4. You can then select the unit, and enter the value you would like to convert from, followed by the unit you would like to convert to.
5. The corresponding value will appear on the screen.

## Using the stopwatch

1. From the standby screen select  , then touch  **Utilities** and choose **Tools**.
2. Select **Stopwatch**.
3. Touch **Start** to begin the timer.
4. Touch **Lap** if you want to record a lap time.
5. Touch **Stop** to end the timer.
6. Touch **Resume** to restart the stopwatch at the time you stopped it at, or touch **Reset** to begin the time again.



## Adding a city to your world time

1. From the standby screen select , then touch  **Utilities** and choose **Tools**.
2. Select **World time**.
3. Touch the  icon, followed by **Add city**.  
Start searching the city you require.

## PC SYNC

You can synchronise your PC with your phone to make sure all your important details and dates match, but also to backup your files to put your mind at ease.

### Installing LG PC Suite on your computer

1. From the standby screen select , then  **Settings**.
2. Select **Connectivity**, then **USB connection mode**.
3. Touch **PC suite**.
4. Insert the supplied CD into your PC. Click on the LG PC suite Installer which will appear on your screen.
5. Select the language you would like the installer to run in and click **OK**.
6. Follow the instructions on screen to complete the LG PC Suite Installer wizard.
7. Once installation is complete, the LG PC Suite icon will appear on your desktop.

## Connecting your phone and PC

1. Connect the USB cable to your phone and your PC.
2. Double click on the **LG PC Suite** icon on your desktop.
3. Click on **Connection Wizard**, then **USB**.
4. Click on **Next**, then **Next** again, then **Finish**.  
Your phone and PC are now connected.

## Backing up and restoring your phone's information

1. Connect your phone to your PC as outlined above.
2. Click on the **Backup** icon, and select **Backup or Restore**.
3. Mark the contents you would like to back up or restore. Select the location you would like to backup information to, or restore information from. Click **OK**.
4. Your information will be backed up.

## Viewing your phone files on your PC

1. Connect your phone to your PC as outlined above.
2. Click on the **Contents** icon.
3. All of the documents, flash contents, images, sounds and videos you have saved onto your phone will be displayed on the screen in the LG Phone folder.

**Viewing the contents of your phone on your PC helps you to arrange files, organise documents and remove contents you no longer need.**

## Synchronising your contacts

1. Connect your phone to your PC.
2. Click on the **Contacts** icon.
3. Your PC will now import and display all contacts saved to your USIM card and handset.
4. Click on **File** and select **Save**. You can now select where you would like to save your contacts to.

**To backup contacts saved to your USIM card, click on the SIM card folder on the left side of your PC screen. Select Edit at the top of the screen, then Select all. Right-click your contacts and select Copy to contact. Now click on the Handset folder on the left of your screen and all your numbers will be displayed.**

## Synchronising your messages

1. Connect your phone to your PC.
2. Click on the **Messages** icon.
3. All of your PC and phone messages will be displayed in folders on your screen.
4. Use the tool bar at the top of your screen to edit and rearrange messages.

## Using your phone as a mass storage device

Your phone can only be used as a mass storage device if you have a memory card inserted.

1. Disconnect your phone from your PC.
2. From the standby screen select , then touch **Settings**.
3. Select **Connectivity**, then **USB connection mode**.
4. Touch **Mass storage**.
5. Connect your phone to your PC. Your phone will read: **Connecting as Mass Storage...** followed by **Connected as Mass Storage Mode**. Do not disconnect during transfer.
6. All of your phone files will automatically be stored onto your PC hard drive.

**Your phone must be unplugged from your PC to initiate Mass Storage.**

**Mass storage backs up content saved on your memory card only, not your handset memory. To transfer the content of your handset memory (e.g. contacts) you'll need to synchronise using PC Sync.**

## Using iSync

Install the iSync plug-in install file which is supported between Machintosh PC and phone via Bluetooth or USB. Use the KF900.pkg program is supplied on the CD. To synchronise via Bluetooth, you have to set up pairing between Machintosh PC and phone. If you want to set up via USB, select **iSync** menu in USB connection mode.

## DivX Converter

Install the DivX converter which is supplied on the same CD as the PC Sync software. Once installed select DivX from the Program Files on your PC, then DivX converter followed by Converter. This will open the Converter application. Use the arrows in the application to change the conversion format to Mobile. If you right click on the application box and select Preferences, you can change the location of where the converted files are saved.

Once you are ready to convert your files, simply drag and drop the files into the application, for initial analysis. Following this, you will need to select Convert for the process to begin. When the process is finished a Conversion complete pop up will be displayed.



The converted file can now be transferred to your phone, using the Mass Storage functionality (see page 77 for details) or Upload contents using the PC Sync software.

## THE WEB

### Browser

**Browser** gives you a fast, full colour world of games, music, news, sport, entertainment and loads more, straight to your mobile phone. Wherever you are and whatever you're into.



### Accessing the web

1. From the standby screen select , then touch  **Utilities** and choose **Browser**.
2. To access the browser homepage directly, select **Home**. Alternately select **Enter address** and type in your desired URL, followed by **Connect**.

An additional cost is incurred when connecting to this service and downloading content. Check your data charges with your network provider.

### Adding and accessing your bookmarks

For easy and fast access to your favourite websites, you can add bookmarks and save web pages.

1. From the standby screen select , then touch  **Utilities** and choose **Browser**.
2. Select **Bookmarks**. A list of your Bookmarks will appear on the screen.
3. To add a new bookmark, touch **Add bookmark**. Enter a name for your bookmark followed by the URL.
4. Touch **Save**. Your Bookmark will now appear in the list of bookmarks.
5. To access the bookmark simply touch the bookmark and then touch connect. You will be connected to your bookmark.

## Using RSS reader



RSS (Really Simple Syndication) is a family of web feed formats used to publish frequently updated content such as blog entries, news headlines or forecasts. An RSS document, which is called a feed, web feed, or channel, contains either a summary of content from an associated web site or the full text. RSS makes it possible for people to keep up with their favourite web sites in an automated manner that is easier than checking them manually.

The user subscribes to a feed by entering the feed's link into the reader or by clicking an RSS icon in a browser that initiates the subscription process. The reader checks the user's subscribed feeds regularly for new content, downloading any updates that it finds.



## Saving a page

1. Access your required webpage as described above.
2. Touch  and select **Save this page**.
3. Enter a name for the webpage so you can easily recognise it.
4. Touch **Save**.



## Accessing a saved page

1. From the standby screen select , then touch  **Utilities** and choose **Browser**.
2. Select **Saved pages**.
3. Select the required page and it will open.

## Viewing your browser history

1. From the standby screen select , then touch  **Utilities** and choose **Browser**. Select **History**.
2. A list of web page titles you have accessed recently will be displayed. To access one of these pages, simply select the required page.

## Changing the web browser settings

1. From the standby screen select , then touch  **Utilities** and choose **Browser**. Select **Settings**.
2. You can choose to edit **Profiles**, **Appearance settings**, **Cache**, **Cookies**, **Security**, or to reset all settings, select **Reset Settings**.
3. You can simply set these to on or off by touching the icon.

## Using your phone as a modem

Your KF900 can double as a modem for your PC, giving you email and internet access even when you can't connect using wires. You can use either the USB cable or Bluetooth.

### Using the USB cable:

1. Ensure you have the LG PC Suite installed on your PC.
2. Connect your KF900 and your PC using the USB cable and launch the LG PC Suite software.
3. Click **Communicate** on your PC. Then click **Settings** and select **Modem**.
4. Choose **LG Mobile USB Modem** and select **OK**. It will now appear on screen.
5. Click **Connect** and your PC will connect through your KF900.

**For more information on synchronising using the LG PC Suite see page 77.**

## Using Bluetooth:

1. Ensure Bluetooth is switched **On** and **Visible** for both your PC and KF900.
2. Pair your PC and KF900 so that a passcode is required for connection.
3. Use the **Connection wizard** on your LG PC Suite to create an active Bluetooth connection.
4. Click **Communicate** on your PC. Then click **Setting**.
5. Click **Modem**.
6. Choose **Standard Modem over Bluetooth link** and click **OK**. It will now appear on screen.
7. Click **Connect** and your PC will connect through your KF900.



**For more information on Bluetooth see page 85.**

## SETTINGS

Within this folder you can adapt your settings to make your KF900 personal to you.

**For information on call settings see page 28.**

### Changing your screen settings

1. Touch  then choose  **Settings**.
2. Touch **Screen settings** and then choose from:
  - **Wallpaper:** Choose the theme for your standby screen.
  - **Top menu:** Phone displays menu in standby.
  - **Dialling:** Adjust the number size and colour.
  - **Font:** Adjust the font size.



**The longer the backlight is on for, the more battery power is used and you may need to charge your phone more often.**

- **Backlight:** Choose how long the backlight remains on for.
  - **Brightness:** Adjust the screen brightness.
  - **Handset theme:** Quickly change the whole look of your screen.
  - **Greeting message:** Choose on or off and fill in the greeting message.
3. Touch **Save** to save your settings.

### Personalising your profiles

You can quickly change your profile on the standby screen. Simply touch the status summary bar on the top and touch the profile tab.



Using the settings menu you can personalise each profile setting.

1. Press  and then choose  **Settings**.
2. Touch **Profiles** and then choose the profile you want to edit.
3. You can then change all of the sounds and alert options available in the list, including your Voice/Video call ring tone and volume, message alerts, screen sound settings and more.

### Changing your phone settings

Enjoy the freedom of adapting how your KF900 works to your own preferences.

**To scroll through a list of options, touch the last item visible and slide your finger up the screen. The list will move up so more items are visible.**

1. Touch  then choose  **Settings**.
2. Touch **Phone settings** then choose from the list below.
  - **Date & Time:** Adjust your date and time settings or choose to auto update the time when you travel or for daylight saving.

- **Power save:** Choose to switch the factory set power saving settings **On, Off** and **Auto**.
- **Languages:** Change the language of your KF900's display.
- **Autokeylock:** Lock the keypad automatically in standby screen.
- **Security:** Adjust your security settings, including PIN codes and handset lock.
- **Memory manager:** See **Using memory manager** on page 84 for more information.
- **Reset settings:** Reset all the settings to their factory definitions.
- **Information:** View the technical information for your KF900.

## Changing the setting of touchpad

You can change the setting value of touchpad. Touch  and then choose **Touch settings**.

- **Touch type:** Change the touching type such as vibration, tone, vibration & tone, No feedback.
- **Touch tone:** Change the tone when touching the screen.
- **Tone volume:** Controls the volume of tone.
- **Touch vibration:** Change the type of vibration
- **Vibration volume:** Controls the strength of vibration.

## Changing your connectivity settings

Your connectivity settings have already been set up by your network operator, so you can enjoy your new phone from the off. If you want to change any settings, use this menu.

Touch  then  **Settings**. Touch **Connectivity**.

- **Network settings:** Your KF900 connects automatically to your preferred network. To change these settings use this menu.
- **Internet profiles:** Set the profiles to connect to the internet.
- **Access points:** Your network operator has already saved this information. You can add new access points using this menu.
- **Packet data conn.:** Set the packet data connection.
- **USB connection mode:** Choose PC suite and synchronise your KF900 using the LG PC Suite software to copy files from your phone. If you use Music sync with Windows Media Player, select Music sync in this menu. Music sync is only available for music content. You can synchronize data with external memory card or Phone Internal memory or both. Choose PictBridge to print out the data in My stuff menu. **Always ask** means that the menu will always offer a choice of USB connections.

- **TV out:** Choose PAL or NTSC for connecting your KF900 to a TV.
- **Synch service:** The Server sync function synchronises the data in a phone and the data on a server such as contact address information, schedule items, to do items and memo items via a wireless network.

**Synch service is dependent upon the network service.**

- **Streaming settings:** Your network operator has already saved this information. You may edit it if you'd like to make changes.
- **Divx VOD registration:** Install the DivX converter which is supplied on the same CD as the PC Sync software. Once installed select DivX from the Program Files on your PC, then DivX converter followed by Converter.

**The TV output cable is available for purchase separately.**

- **ABOUT DIVX VIDEO:** DivX® is a digital video format created by DivX, Inc. This is an official DivX Certified device that plays DivX video.
- **ABOUT DIVX VIDEO-ON-DEMAND:** This DivX® Certified device must be registered with DivX in order to play DivX Video-on-Demand (VOD) content. First generate the DivX VOD registration code for your device and submit it during the registration process. [Important: DivX VOD content is protected by a DivX DRM (Digital Rights Management) system that restricts playback to registered DivX Certified devices. If you try to play DivX VOD content not authorized for your device, the message "Authorization Error" will be displayed and your content will not play.] Learn more at [www.divx.com/vod](http://www.divx.com/vod).

## Using memory manager



Your KF900 has three memories available: the phone, the USIM Card and an external memory card (you may need to purchase the memory card separately).

You can use memory manager to determine how each memory is used and see how much space is available. Touch  followed by  **Settings**. Select **Phone settings** then **Memory Manager**.

- **Handset common memory:** View the memory available on your KF900 for Pictures, Sounds, Video, Flash, MMS, Email, Java applications and others.
- **Handset reserved memory:** View the memory available on your handset for SMS, Contacts, Calendar, To do list, Memo, Alarm, Call history, Bookmarks and Miscellaneous items.
- **SIM memory:** View the memory available on your USIM Card.
- **External memory:** View the memory available on your external memory card (you may need to purchase the memory card separately).
- **Primary storage settings:** Choose the location you prefer items to be saved to.

**See page 16 for information on Installing a memory card.**

## Using flight mode

Turn on flight mode by selecting  then  **Settings**. Touch **Profiles** and choose **Flight mode**.

Flight mode will not allow you to make calls, connect to the Internet, send messages or use Bluetooth.

## Sending and receiving your files using Bluetooth

Bluetooth is a great way to send and receive files as no wires are needed and connection is quick and easy. You can also connect to a Bluetooth headset to make and receive calls.

### To send a file:

1. Open the file you want to send, typically this will be a photo, video or music file.
2. Touch  and choose **Send**. Choose **Bluetooth**.
3. If you have already paired the Bluetooth device, your KF900 will not automatically search for other Bluetooth devices. If not, your KF900 will search for other Bluetooth enabled devices within range.
4. Choose the device you want to send the file to and touch **Select**.
5. Your file will be sent.



**Keep an eye on the progress bar to make sure your file is sent.**

### To receive a file:

1. To receive files your Bluetooth must be both **On** and **Visible**. See change your Bluetooth settings below for more information.
2. A message will prompt you to accept the file from the sender. Touch Yes to receive the file.

3. You will see where the file has been saved and you can choose to **View** the file or **Use as wallpaper**. Files will usually be saved to the appropriate folder in your Media Album.

### Changing your Bluetooth settings:

1. Touch  and choose  **Settings**.
2. Choose **Bluetooth** then touch  and choose **Settings**. Make your changes to:
  - **My device visibility:** Choose to be **Visible** or **Hidden** or **Visible for 1 min**.
  - **My device name:** Enter a name for your KF900.
  - **Supported services:** Choose how to use Bluetooth in association with different services.
  - **Remote SIM Mode:** On /Off
  - **My address:** Show your Bluetooth address.

### Pairing with another Bluetooth device

By pairing your KF900 and another device, you can set up a passcode protected connection. This means your pairing is more secure.

1. Check your Bluetooth is **On** and **Visible**.  
You can change your visibility in the **Settings** menu.
2. Touch **Search**.

3. Your KF900 will search for devices.  
When the search is completed **Refresh** will appear on screen.
4. Choose the device you want to pair with and enter the passcode, then touch **OK**.
5. Your phone will then connect to the other device, on which you should enter the same passcode.
6. You passcode protected Bluetooth connection is now ready.

### Using a Bluetooth headset

1. Check your Bluetooth is **On** and **Visible**.
2. Follow the instructions that came with your headset to place your headset in pairing mode and pair your devices.
3. Touch **Ask always** or **Allow without ask** and touch **Yes** to Connect now  
Your KF900 will automatically switch to Headset profile.

**See page 28 for details on BT answer mode so that you can control how you answer calls when your Bluetooth headset is connected.**

## WIFI

Wireless Manager allows you to manage Wi-Fi Internet on your device. It allows the phone to connect to local wireless networks, or access the Internet wirelessly. Wi-Fi is faster and has a greater range than Bluetooth wireless technology.

**KF900 supports WEP, WPA-PSK/2 encryption not EAP, WPS encryption. If your Wi-Fi service provider or network administrator sets the encryption for network security, you should fill in the key in the pop-up window. If the encryption is not set, this pop-up window is not shown. If you don't know the key, you need to ask for it from your Wi-Fi service provider or network administrator.**

## ANTI-THEFT MOBILE TRACK (ATMT)

The ATMT feature of this phone provides you with the ability to have a tracking system in place for your Mobile in case you lose or misplace it.

The moment an un-authorized user uses your phone, a SMS is triggered from your phone and the Message is sent to your pre-defined number.

- In case you want to use your phone with some other SIM card, make sure to set the ATMT feature OFF.
- It is recommended to enter the Number for ATMT with the country code.
- Default ATMT code is "000000".

## ACCESSORIES

These accessories were supplied with KF900.

### Charger



### Data cable and CD

Connect and synchronise your KF900 and PC.



### Battery



### User Guide

Learn more about your KF900.



### Stereo headset



- Always use genuine LG accessories.
- Failure to do this may invalidate your warranty.
- Accessories may be different in different regions; please check with our regional service company or agent for further inquires.

## NETWORK SERVICE

The wireless phone described in this guide is approved for use on the GSM 850, E-GSM 900, DCS 1800, PCS 1900 and W-CDMA network.

A number of features included in this guide are called Network Services. These are special services that you arrange through your wireless service provider. Before you can take advantage of any of these Network Services, you must subscribe to them through your service provider and obtain instructions for their use from your service provider.

## TECHNICAL DATA

### General

**Product name :** KF900

**System :** GSM 850 / E-GSM 900 / DCS 1800 / PCS 1900 / W-CDMA

### Ambient Temperatures

**Max. :** +55°C (discharging)

+45°C (charging)

**Min :** -10°C

## TROUBLESHOOTING

This chapter lists some problems that you might encounter while using your phone. Some problems require that you call your service provider, but most of problems you encounter are easy to correct yourself.

<b>Message</b>	<b>Possible causes</b>	<b>Possible Corrective measures</b>
SIM error	There is no SIM card in the phone or you may have inserted it incorrectly.	Make sure that the SIM card is correctly inserted.
No connection to the network	Signal weak Outside GSM network	Move higher to a window or open space. Check service provider coverage map.
Codes do not match	When you want to change a security code you have to confirm the new code by entering it again. The two codes that you have entered do not match.	Contact your Service Provider.
Function cannot be set	Not supported by Service Provider or registration required	Contact your Service Provider.
Calls not available	Dialling error New SIM card inserted Charge limit reached	New network not authorised. Check for new restrictions. Contact Service Provider or reset limit with PIN 2.
Phone cannot be switched on	On/Off key pressed too briefly Battery empty Battery contacts dirty	Press On/Off key for at least two seconds. Charge battery. Check charging indicator in the display. Clean contacts.

<b>Message</b>	<b>Possible causes</b>	<b>Possible Corrective measures</b>
Charging error	Battery totally empty	
	Temperature out of range	Charge battery.
	Contact problem	Make sure the ambient temperature is right, wait for a while, and then charge again.
	No mains voltage	Check power supply and connection to the phone. Check the battery contacts, clean them if necessary.
	Charger defective	Plug in to a different socket or check voltage. If the charger does not warm up, replace it.
	Wrong charger	Only use original LG accessories.
	Battery defective	Replace battery.
Phone loses network	Signal too weak	Reconnection to another service provider is automatic.
Number not permitted	The Fixed dial number function is on.	Check settings.

# Declaration of Conformity



LG Electronics

## Suppliers Details

Name

LG Electronics Inc

Address

LG Electronics Inc, LG Twin Towers 20,  
Yeouido-dong, Yeongdeungpo-gu, Seoul, Korea 150-721

## Product Details

Product Name

GSM 850 / E-GSM 900 / DCS 1800 / PCS 1900 / W-CDMA Terminal Equipment

Model Name

KF900

Trade Name

LG



## Applicable Standards Details

R&TTE Directive 1999/5/EC

EN 301 488-01 V1.6.1, EN 301 488-07 v1.3.1, EN 301 488-17 v1.2.1, EN 301 489-24 V1.3.1  
EN 301 511 V9.0.2  
EN 301 908-1 V3.2.1 EN 301 908-2 V3.2.1  
EN 50360/EN 50361:2001  
EN 60950-1:2001  
EN 300 328 V1.7.1

## Supplementary Information

The conformity to above standards is verified by the following Notified Body(BABT)

BABT, Balfour House, Churchfield Road, Walton-on-Thames, Surrey, KT12 2TD, United Kingdom  
Notified Body Identification Number : 0168

## Declaration

I hereby declare under our sole responsibility that the product mentioned above to which this declaration relates complies with the above mentioned standards and Directives

Name

Issued Date

Seung Hyoun, Ji / Director

15. Oct. 2008

LG Electronics Inc, Amsterdam Office  
Veluwezoom 15, 1327 AE Almere, The Netherlands  
Tel : +31 - 36-547 - 8940, e-mail : seokim @ lge.com

Signature of representative





