

ENGLISH



KG800 | USER GUIDE

# chocolate

## KG800

Some of contents in this manual may differ from your phone depending on the software of the phone or your service provider.



LG Electronics Inc

CE 0168



[www.lgmobile.com](http://www.lgmobile.com)

P/N : MMBB0228007(1.1) 

# | KG800 | User Guide

- English



# Table of Contents

How to Use Touch Button 5

Introduction 7

For Your Safety 8

Guidelines for safe and efficient use 9

KG800 features 16

Parts of the phone

Display information 20

On-Screen Icons

Installation 22

Installing the SIM card and the handset battery

Charging the battery 23

Disconnecting the charger 24

General functions 25

Making and answering calls

Entering text 27

Changing the text input mode

Contacts 30

Selecting Functions and Options 31

In-Call Menu 32

During a call

Multiparty or conference calls 33

Menu Tree 35

Profiles 37

Activate

Personalise

Rename 38

Call register 39

Missed calls

Received calls

Dialled calls

All calls 40

Delete recent calls

Call charges

Call duration

Call costs

Settings

GPRS information 41

Call duration

Data volume

Tools 42

Favourites

Alarm clock

Calculator

Unit converter 43

World time

SIM-Menu

<b>Organiser</b>	<b>44</b>	<b>Messages</b>	<b>50</b>	<b>Multimedia</b>	<b>60</b>
<b>Contacts</b>		<b>New message</b>		<b>Camera</b>	
Search contacts		Write text message	51	<b>Video camera</b>	<b>61</b>
Add new	45	Write multimedia message	51	<b>Voice recorder</b>	
Caller groups		<b>Inbox</b>	<b>53</b>	Record	
Speed dial	46	<b>Drafts</b>	<b>54</b>	View list	62
Own number		<b>Outbox</b>	<b>55</b>	<b>MP3</b>	
My business card		<b>Listen to voice mail</b>		<b>Photo album</b>	<b>64</b>
Settings		<b>Info message</b>	<b>56</b>	<b>Video album</b>	<b>65</b>
<b>Calendar</b>	<b>48</b>	Read		<b>Settings</b>	
Add new		Topics		Camera	
View daily schedules		<b>Templates</b>	<b>57</b>	Video camera	
Delete past		Text templates			
Delete all		Multimedia templates			
Go to date	49	<b>Settings</b>			
Set alarm tone		Text message			
<b>Memo</b>		Multimedia message	58		
		Voice mailbox number	59		
		Info message			
		Push message			

# Table of Contents

<b>Browser</b>	<b>66</b>	<b>Settings</b>	<b>78</b>	Call waiting	85
<b>Home</b>	<b>67</b>	<b>Date &amp; time</b>		Minute minder	
<b>Bookmarks</b>		Date		Auto redial	
<b>Go to URL</b>		Time		<b>Security</b>	
<b>Settings</b>		<b>Display</b>		PIN code request	
Profiles		Wallpaper		Handset lock	86
Cache	69	Menu colour		Call barring	
Cookie		Standby text		Fixed dial number	87
Clear cache		Backlight	79	Change codes	
Clear cookie		Brightness		Touchpad lock	
Security		Network name		<b>Memory status</b>	<b>88</b>
		Home screen shortcut		<b>Reset settings</b>	
<b>My stuff</b>	<b>70</b>	Dial font colour			
<b>Games &amp; apps</b>		<b>Power saving</b>		<b>Accessories</b>	<b>89</b>
Games & apps		<b>Language</b>		<b>Technical Data</b>	<b>90</b>
Profiles		<b>Connectivity</b>			
<b>Videos</b>	<b>74</b>	Bluetooth			
<b>Photos</b>		Modem	82		
<b>Music</b>	<b>75</b>	Network			
<b>Text</b>		GPRS attach	83		
<b>Images</b>	<b>76</b>	<b>Calling</b>			
<b>Sounds</b>		Call divert			
<b>Others</b>	<b>77</b>	Answer mode	84		
		Send my number			

# How to Use Touch Button

- ▶ This product's buttons on the slide are touch buttons.
- ▶ Be sure to read "Cautions for Touch Buttons" before using touch buttons.

## Cautions for Touch Buttons

1. Make sure your hands are clean and dry.
  - Remove all moisture from the surface of your hands or the touch buttons in a humid environment.

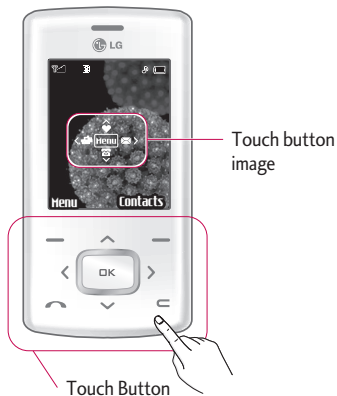

2. You do not need to press hard on the touch buttons to make it work normally. Keep product from severe impact, as sensors of the touch buttons may be damaged.
3. Use the **tip** of your finger to press exactly on the touch button you want, being careful not to touch the buttons for other functions.
4. When both the home screen and touch button lights are off, pressing a touch button will not turn on the home screen light. Press the End button and the home screen light will turn back on (touch buttons do not work when the touch button lights are off).
5. If the slide is closed and the **Touch Protection** function is on, during calls the **Touch button Lock** function is automatically enabled. (For details, see 'Touch Button Status When Using Mobile Phone'.)

# How to Use Touch Button

6. Touch buttons may not work normally if a mobile phone case or plastic is covering the touch buttons. Also, touch buttons may not work normally if you are using it wearing a glove.
7. Keep metal and other conductive material away from the surface of touch buttons, as contact with them may result in error.

## Touch Button Status When Using Mobile Phone



When the slide is closed, to prevent indiscreet action of the touch buttons whilst using the phone or during calls, the **Touch Protection** function is automatically enabled. (In this case, the touch buttons will not work even if they are pressed)

### 1. When slide is closed

- When the slide is closed, Touch Protection function is automatically enabled. (Opening the slide will automatically disable it.)

- To disable Touch Protection when slide is closed, press volume button twice.
- After disabling Touch Protection, if there is no button action for a certain duration (5 seconds), Touch Protection function is enabled again.

### 2. During calls

- During calls, regardless of slide status, Touch Protection function is automatically enabled.
- To disable Touch Protection, press the MP3 button or number button,  button, or  button.
- After disabling Touch button Lock, if there is no button action for a certain duration (5 seconds), the Touch Protection function is enable again.

### Note

- ▶ For user convenience, touch button image with functions of each touch button is shown on the home screen when purchasing products.

# Introduction

Congratulations on your purchase of the advanced and compact KG800 cellular phone, designed to operate with the latest digital mobile communication technology.

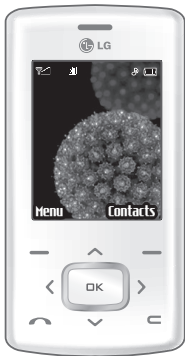

This user's guide contains important information on the use and operation of this phone. Please read all the information carefully for optimal performance and to prevent any damage to or misuse of the phone. Any changes or modifications not expressly approved in this user's guide could void your warranty for this equipment.

Use of phone cases with magnetic locks with slide type phones has caused problems such as loss of network signal and phones powering off.

Please note that your phone software capabilities may differ slightly from what is stated in this user manual due to customization to suit your operator's needs.

# For Your Safety

Please read these simple guidelines. Not following these guidelines may be dangerous or illegal. Further detailed information is given in this manual.

## WARNING!

- *Mobile Phones must be switched off at all times in aircrafts.*
- *Do not hold the phone in your hand while driving.*
- *Do not use your phone near petrol stations, fuel depots, chemical plants or blasting operations.*
- *For your safety, use ONLY specified ORIGINAL batteries and chargers.*
- *Do not handle the phone with wet hands while it is being charged. It may cause an electric shock or seriously damage your phone.*
- *Keep the phone in a safe place out of small children's reach. It includes small parts which, if detached, may cause a choking hazard.*

## CAUTION!

- *Switch off the phone in any area where required by special regulations. For example, do not use your phone in hospitals or it may affect sensitive medical equipment.*
- *Emergency calls may not be available under all mobile networks. Therefore, you should never depend solely on your mobile phone for emergency calls.*
- *Only use ORIGINAL accessories to avoid damage to your phone.*
- *All radio transmitters carry risks of interference with electronics in close proximity. Minor interference may affect TVs, radios, PCs, etc.*
- *Batteries should be disposed of in accordance with relevant legislation.*
- *Do not dismantle the phone or battery.*

# Guidelines for safe and efficient use

Please read these simple guidelines. Not following these guidelines may be dangerous or illegal. Further detailed information is given in this manual.

## Exposure to radio frequency energy

### Radio wave exposure and Specific Absorption Rate (SAR) information

This mobile phone model KG800 has been designed to comply with applicable safety requirement for exposure to radio waves. This requirement is based on scientific guidelines that include safety margins designed to assure this safety of all persons, regardless of age and health.

- ▶ The radio wave exposure guidelines employ a unit of measurement known as the Specific Absorption Rate, or SAR. Tests for SAR are conducted using standardized method with the phone transmitting at its highest certified power level in all used frequency bands.

- ▶ While there may be differences between the SAR levels of various LG phone models, they are all designed to meet the relevant guidelines for exposure to radio waves.
- ▶ The SAR limit recommended by the international Commission on Non-Ionizing Radiation Protection (ICNIRP), which is 2W/kg averaged over ten (10) gram of tissue.
- ▶ The highest SAR value for this model phone tested by DASY4 for use at the ear is 0.596 W/kg (10g).
- ▶ SAR data information for residents in countries/regions that have adopted the SAR limit recommended by the Institute of Electrical and Electronics Engineers (IEEE), which is 1.6 W/kg averaged over one (1) gram of tissue.

Before a phone model is available for sale to the public, it must be tested and certified to the FCC that it does not exceed the limit established by the government-adopted requirement for safe exposure. The tests are performed in positions and locations (e.g., at the ear and worn on the body) as required by

# Guidelines for safe and efficient use

the FCC for each model. The highest SAR value for this model phone when tested for use at the ear is 0.596 W/kg (1.0g) and when worn on the body, as described in this user's manual, is 0.176 W/kg (1.0g). (Body-worn measurements differ among phone models, depending upon available accessories and FCC requirements.) While there may be differences between SAR levels of various phones and at various positions, they all meet the government requirement for safe exposure.

## Body-worn Operation

This device was tested for typical body-worn operations with the back of the phone kept 0.6 inches (1.5cm) back of the phone between the user's body and the back of the phone. To comply with FCC RF exposure requirements, a minimum separation distance of 0.6 inches (1.5cm) between the user's body and the back of the phone must be maintained between the user's body and the back of the phone. Third-party belt-clips, holsters, and similar accessories containing metallic components should not be used. Body-worn accessories that cannot maintain be used. Body-worn maintain 0.6

inches (1.5cm) separation distance between the user's body and the back of the phone, and have not been tested for typical body-worn operations may not comply with FCC RF exposure limits and should be avoided.

## Product care and maintenance

### WARNING!

*Only use batteries, chargers and accessories approved for use with this particular phone model. The use of any other types may invalidate any approval or warranty applying to the phone, and may be dangerous.*

- ▶ Do not disassemble this unit. Take it to a qualified service technician when repair work is required.
- ▶ Keep away from electrical appliances such as a TV's, radios or personal computers.
- ▶ The unit should be kept away from heat sources such as radiators or cookers.
- ▶ Never place your phone in a microwave oven as it will cause battery to explode.

- ▶ Do not drop.
- ▶ Do not subject this unit to mechanical vibration or shock.
- ▶ The coating of the phone may be damaged if covered with wrap or vinyl wrapper.
- ▶ Do not use harsh chemicals (such as alcohol, benzene, thinners, etc.) or detergents to clean your phone. There is a risk of this causing a fire.
- ▶ Do not subject this unit to excessive smoke or dust.
- ▶ Do not keep the phone next to credit cards or transport tickets; it can affect the information on the magnetic strips.
- ▶ Do not tap the screen with a sharp object as it may damage the phone.
- ▶ Do not expose the phone to liquid or moisture.
- ▶ Use accessories, such as earphones and headsets, with caution. Ensure that cables are tucked away safely and do not touch the antenna unnecessarily.
- ▶ Please remove the data cable before powering on the handset.

## Efficient phone operation

To enjoy optimum performance with minimum power consumption please:

- ▶ Do not hold the antenna when the phone is in use. If you hold it, it can affect call quality, it may also cause the phone to operate at a higher power level than needed and shorten talk and standby times.

## Electronic devices

**All mobile phones may get interference, which could affect performance.**

- ▶ Do not use your mobile phone near medical equipment without requesting permission. Avoid placing the phone over pacemakers (i.e. in your breast pocket.)
- ▶ Some hearing aids might be disturbed by mobile phones.
- ▶ Minor interference may affect TVs, radios, PCs, etc.

# Guidelines for safe and efficient use

## Road safety

**Check the laws and regulations on the use of mobile phones in the areas when you drive.**

- ▶ Do not use a hand-held phone while driving.
- ▶ Give full attention to driving.
- ▶ Use a hands-free kit, if available.
- ▶ Pull off the road and park before making or answering a call if driving conditions so require.
- ▶ RF energy may affect some electronic systems in your motor vehicle such as a car stereo or safety equipment.
- ▶ If your vehicle is equipped with an air bag, do not obstruct it with installed or portable wireless equipment. It can cause serious injury due to improper performance.

**If you are listening to music whilst out and about, please ensure that the volume is at a reasonable level so that you are aware of your surroundings. This is particularly imperative when attempting to cross the street.**

## Avoid damage to your hearing

Damage to your hearing can occur if you are exposed to loud sound for long periods of time. We therefore recommend that you do not turn on or off the handset close to your ear. We also recommend that music and call volumes are set to a reasonable level.

## Blasting area

Do not use the phone where blasting is in progress. Observe restrictions, and follow any regulations or rules.

Potentially explosive atmospheres

- ▶ Do not use the phone at a refuelling point. Don't use near fuel or chemicals.
- ▶ Do not transport or store flammable gas, liquid, or explosives in the compartment of your vehicle, which contains your mobile phone and accessories.

## In aircraft

Wireless devices can cause interference in aircraft.

- ▶ Turn off your mobile phone before boarding any aircraft.
- ▶ Do not use it on the ground without crew permission.

## Children

Keep the phone in a safe place out of small children's reach. It includes small parts which if detached may cause a choking hazard.

## Emergency calls

Emergency calls may not be available under all mobile networks. Therefore, you should never depend solely on your mobile phone for emergency calls. Check with your local service provider.

## Battery information and care

- ▶ You do not need to completely discharge the battery before recharging. Unlike other battery systems, there is no memory effect that could compromise the battery's performance.
- ▶ Use only LG batteries and chargers. LG chargers are designed to maximize the battery life.
- ▶ Do not disassemble or short-circuit the battery pack.
- ▶ Keep the metal contacts of the battery pack clean.

# Guidelines for safe and efficient use

- ▶ Replace the battery when it no longer provides acceptable performance. The battery pack may be recharged hundreds of times until it needs replacing.
- ▶ Recharge the battery if it has not been used for a long time to maximize usability.
- ▶ Do not expose the battery charger to direct sunlight or use it in high humidity, such as in the bathroom.
- ▶ Do not leave the battery in hot or cold places, this may deteriorate the battery performance.

## Driver Safety Tips

**Your wireless telephone gives you the powerful ability to communicate by voice - almost anywhere, anytime. But an important responsibility accompanies the benefits of wireless phones, one that every user must uphold.**

**When driving a car, driving is your first responsibility. When using your wireless phone behind the wheel of a car, practice good common sense and remember the following tips:**

- ▶ Use a hands free device. If possible, add an additional layer of convenience and safety to your wireless phone with one of the many hands free accessories available today.
- ▶ Let the person you are speaking with know you are driving; if necessary, suspend the call in heavy traffic or hazardous weather conditions. Rain, sleet, snow, ice and even heavy traffic can be hazardous.

- ▶ Do not take notes or look up phone numbers while driving. Jotting down a “to do” list or flipping through your address book takes attention away from your primary responsibility, driving safely.
- ▶ If possible, place calls when you are not moving or before pulling into traffic. Try to plan calls when you will not be driving.
- ▶ Do not engage in stressful or emotional conversations that may be distracting. Make people you are talking with aware you are driving and suspend conversations that have the potential to divert your attention from the road.
- ▶ Use your wireless phone to call emergency services for yourself or others. Dial 0-0-0 local emergency number in the case of fire, traffic accident or medical emergencies. Remember, it is a free call on your wireless phone!
- ▶ Use your wireless phone to help others in emergencies, if you see an auto accident crime in progress or other serious emergency where lives are in danger, call 0-0-0 to call emergency number, as you would want others to do for you.
- ▶ Call roadside assistance or a special non-emergency wireless assistance number when necessary. If you see a broken down vehicle posing no serious hazard, a broken traffic signal, a minor traffic accident where no one appears injured, or a vehicle you know to be stolen, call roadside assistance or other special non-emergency wireless number.

# KG800 features

## Parts of the phone

### Open view

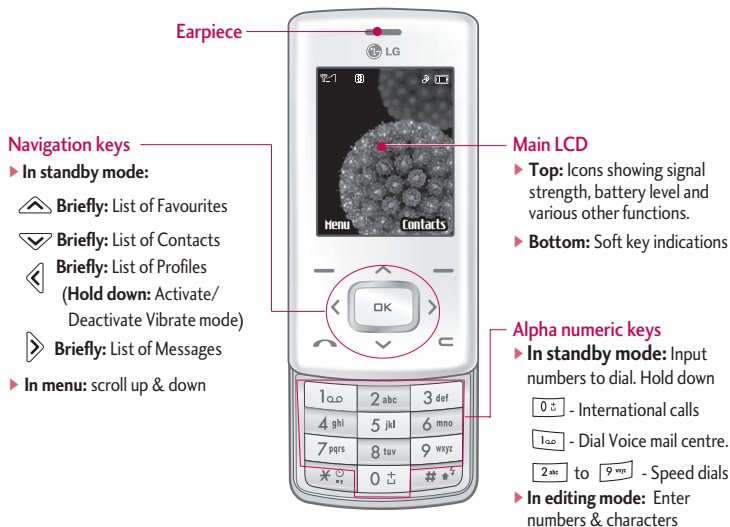

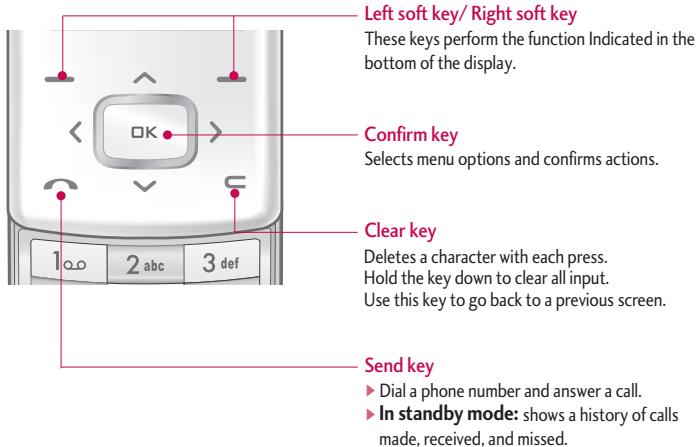

# KG800 features

## Left side view

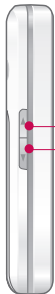

### Side keys

- ▶ **In standby mode (opened):**  
Volume of key tone
- ▶ **In standby mode (closed):**  
**Short press** - The main LCD light on.  
**Long press** - Only display a wallpaper.
- ▶ **In menu:** scroll up & down
- ▶ **During a call:** volume of the earpiece

### Note

- ▶ To protect the sense of hearing while Slide open, maximum volume level is 3.

## Right side view



### End key

- ▶ **Switch on/off**  
(hold down)
- ▶ **End or reject a call.**

### Camera/MP3 and Multimedia hot key

- ▶ Activates the MP3 player (long press) and Multimedia menu (short press) directly.

## Rear view

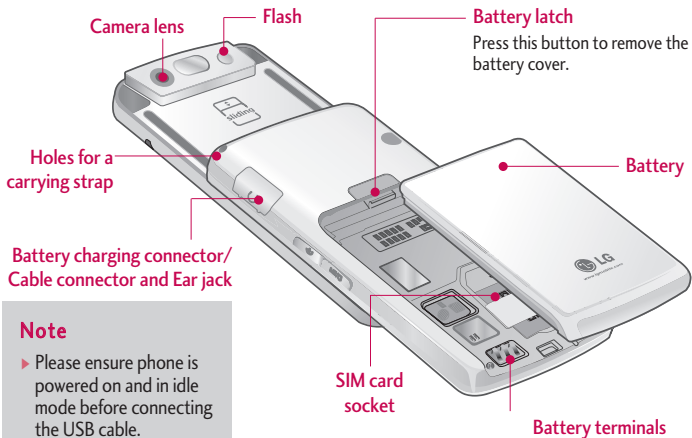

### Note

- ▶ Please ensure phone is powered on and in idle mode before connecting the USB cable.

# KG800 features

## Display Information

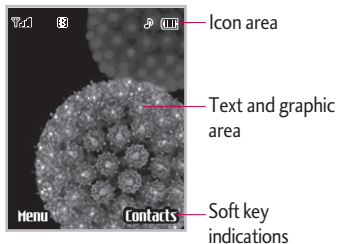

The screen displays several icons. These are described below.









## On-Screen Icons

Icon/Indicator	Description
	Tells you the strength of the network signal.
	Call is connected.
	You can use GPRS service.
	Shows that you are using a roaming service.
	The alarm has been set and is on.
	Tells you the status of the battery.
	You have received a text message.
	You have received a voice message.

Area	Description
<b>First line</b>	Displays various icons.
<b>Middle lines</b>	Display messages, instructions and any information that you enter, such as number to be dialed.
<b>Last line</b>	Shows the functions currently assigned to the two soft keys.

## Note

- ▶ The quality of the conversation may change depending on network coverage. When the signal strength is below 2 bars, you may experience muting, call drop and poor audio. Please refer to this signal as an indicator for your calls. When there are no bars, that means that there is no network coverage: in this case, you won't be able to access the network for any service (call, messages and so on).

Icon/Indicator	Description
	Vibrate only menu in profile.
	General menu in profile.
	Loud menu in profile.
	Silent menu in profile.
	Headset menu in profile.
	You can divert a call.
	Indicates that the phone is accessing the WAP.
	Indicates that you are using GPRS.
	You have activated Bluetooth menu.

# Installation

## Installing the SIM card and the handset battery

Make sure the power is off before you remove the battery.

### 1. Remove the battery.

Press and hold down the battery release button and slide the battery down.

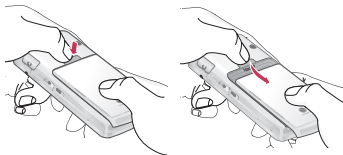

### 2. Install the SIM card.

Insert and slide the SIM card into the SIM card holder. Make sure that the SIM card is inserted properly and that the gold contact area on the card is facing downwards. To remove the SIM card, press down lightly and push it in the reverse direction.

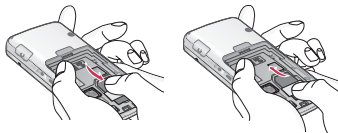

To insert the SIM card    To remove the SIM card

### Note

- ▶ The metal contact of the SIM card can be easily damaged by scratches. Pay special attention to the SIM card while handling. Follow the instructions supplied with the SIM card.

### 3. Install the battery.

Slide the battery upwards until it snaps back into place.

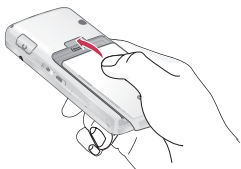

## Charging the Battery

Before connecting the travel adapter to the phone you must first install the battery.

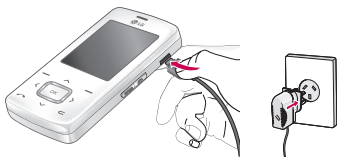

1. Ensure the battery is fully charged before using the phone for the first time.
2. With the arrow facing you as shown in the diagram push the plug on the battery adapter into the socket on the side of the phone until it clicks into place.
3. Connect the other end of the travel adapter to the mains socket. Use only the charger included in the box.
4. The moving bars of battery icon will stop after charging is complete.

# Installation

## CAUTION!

- Do not force the connector as this may damage the phone and/or the travel adapter.
- If you use the battery pack charger out of your own country, use an attachment plug adaptor for the proper configuration.
- Do not remove your battery or the SIM card while charging.

## WARNING!

- Unplug the power cord and charger during lightning storms to avoid electric shock or fire.
- Make sure that no sharp-edged items such as animal teeth or nails, come into contact with the battery.  
There is a risk of this causing a fire.
- Do not place or answer calls while charging the phone as it may short-circuit the phone and/or cause electric shock or fire.

## Disconnecting the charger



Disconnect the travel adapter from the phone as shown in the diagram below.





# General Functions

## Making and answering calls



### Making a call

1. Make sure your phone is switched on.
2. Enter a phone number, including the area code.
  - ▶ Press and hold the clear key  to erase the entire number.
3. Press the send key  to call the number.
4. To end the call, press the end key .

### Making a call from the call history list

1. In standby mode, press the send key , and the latest incoming, outgoing and missed phone numbers will be displayed.
2. Select the desired number by using the up/down navigation keys.
3. Press  to call the number.

### Making an international call

1. Press and hold the  key for the international prefix. The '+' character automatically selects the international access code.
2. Enter the country code, area code, and the phone number.
3. Press  to call the number.

### Ending a Call

When you have finished your call, press the end  key.

### Making a call from the phonebook

You can save the names and phone numbers dialled regularly in Contacts. You can save them to the SIM card and/or phone memory. You can dial a number by simply looking up the desired name in the phonebook and pressing the  key.

# General Functions

## Adjusting the volume

If you want to adjust the earpiece volume during a call, use the side keys . Press the up side key to increase and down side key to decrease the volume.

### Note



- ▶ In standby mode with the phone open, pressing the side keys adjusts the key tone volume.

## Answering a call

When you receive a call, the phone rings and the flashing phone icon appears on the screen. If the caller can be identified, the caller's phone number (or name/photo if saved in the phonebook) is displayed.

1. To answer an incoming call, open the phone. (When Slide open has been set as the answer mode. (Menu 9.6.2).)

### Note

- ▶ If Press any key has been set as the answer mode any key press will answer a call except for the  or the right soft key.
- ▶ You can answer a call while using the address book or other menu features.
  2. To end the call, close the phone or press the  key.

## Manner mode (Quick)

You can activate the manner mode by pressing and holding down the  key after opening the phone.

## Signal strength

You can check the strength of your signal by the signal indicator (  ) on the LCD screen of your phone. Signal strength can vary, particularly inside buildings. Moving near to a window may improve reception.

## Entering text

You can enter alphanumeric characters by using the phone's keypad. For example, storing names in the phonebook, writing a message, creating a personal greeting. The following text input methods are available in the phone.

### T9 mode

This mode lets you enter words with only one keystroke per letter. Each key on the keypad has more than one letter. The T9 mode automatically compares your keystrokes with an internal dictionary to determine the correct word, thus requiring far fewer keystrokes than the traditional ABC mode. This is sometimes known as predictive text.

### ABC mode

This mode lets you enter letters by pressing the key labelled with the required letter once, twice, three or four times until the letter is displayed.

### 123 mode (Number mode)

Type numbers using one keystroke per number. To change to 123 mode in a text entry field, press the  key until 123 mode is displayed.

## Changing the text input mode

1. When you are in a field that allows characters to be entered, you will notice the text input mode indicator in the top right corner of the LCD screen.

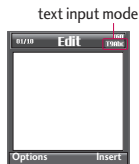



# General Functions

2. Change the text input mode by pressing . You can check the current text input mode in the top right corner of the LCD screen.

## Using the T9 mode

The T9 predictive text input mode lets you enter words easily with a minimum number of key presses. As you press each key, the phone begins to display the characters that it thinks you are typing based on the built-in dictionary.



You can also add new words in the dictionary. As new words are added, the word changes to reflect the most likely candidate from the dictionary. You can turn the T9 mode on or off, and change the T9 language by holding down the  key.

1. When you are in the T9 predictive text input mode, start entering a word by pressing keys  to . Press one key per letter.
  - ▶ The word changes as letters are typed. Ignore what's on the screen until the word is typed completely.

- ▶ If the word is still incorrect after typing completely, press the down navigation key once or more to cycle through the other word options.

**Example:** Press     to type **Good**.

Press      
[down navigation key] to type **Home**.



- ▶ If the desired word is missing from the word choice list, add it using the ABC mode.
  - ▶ You can select the language of the T9 mode. Press the left soft key [Option], then select T9 languages. Select the desired language of T9 mode. You can also turn off the T9 mode by selecting T9 off. The default setting on the phone is T9 enabled mode.
2. Enter the whole word before editing or deleting any keystrokes.
  3. Complete each word with a space by pressing the  key. To delete letters, press . Press and hold down  to erase entire words.

**Note**

- ▶ To exit from the text input mode without saving your input, press . The phone goes back to standby mode.











**Using the ABC mode**

Use the  to  keys to enter your text.

1. Press the key labelled with the required letter:
  - ▶ Once for the first letter.
  - ▶ Twice for the second letter.
  - ▶ And so on.
2. To insert a space, press the  key once. To delete letters, press the  key. Press and hold down the  key to clear the whole display.

**Note**

- ▶ Refer to the table below for more information on the characters available using the alphanumeric keys.

Key	Characters in the order display	
	Upper Case	Lower Case
	.,/?!-:'"1	.,/?!-:'"1
	A B C 2	a b c 2
	D E F 3	d e f 3
	G H I 4	g h i 4
	J K L 5	j k l 5
	M N O 6	m n o 6
	P Q R S 7	p q r s 7
	T U V 8	t u v 8
	W X Y Z 9	w x y z 9
	Space 0	Space 0

# General Functions

## Using the 123 (Number) mode

The 123 mode enables you to enter numbers in a text message (a telephone number, for example).

Press the keys corresponding to the required digits before manually switching back to the appropriate text entry mode. You can quickly switch from letters to numbers by pressing and holding down the  key.

## Using the Symbol Mode

Using the Symbol Mode The Symbol Mode enables you to enter various symbols or special characters.

To enter a symbol, press the  key. Use the navigation keys to scroll through the symbols and press the corresponding key and then press the [OK] key.



## Contacts

You can store phone numbers and their corresponding names in the memory of your SIM card.

In addition, you can store up to 1000 numbers and names in the phone memory.

The SIM card and phone are both used in the same way in the Contacts menu.

# Selecting Functions and Options

Your phone offers a set of functions that allow you to customise the phone. These functions are arranged in the menus and sub-menus, accessed via the two soft keys marked  and . Each menu and sub-menu lets you view and alter the settings of a particular function.

The role of the soft keys vary according to the current context or the label on the bottom line of the screen just above each key indicates its current role.

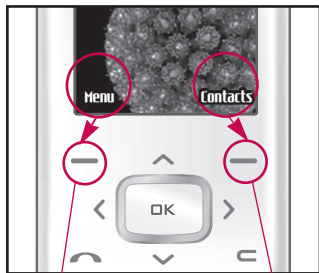

Press the left soft key to access the available menu.

Press the right soft key to access the available Contacts.

# In-call menu

Your phone provides a number of control functions that you can use during a call. To access these functions during a call, initially press the MP3 key to unlock the touch screen and then press the left soft key [Options].

## During a call

The menu displayed on the handset screen during a call is different to the default main menu displayed when in standby mode, and the options are described below.

### Making a second call

You can get a number you wish to dial from the phonebook to make a second call. Press the right soft key selecting **Contacts**. To save the dialled number into the phonebook during a call, press the right soft key then select **Add new**.

### Switching between two calls

To switch between two calls, press the left soft key then select **Swap**.

### Answering an incoming call

To answer an incoming call when the handset is ringing, slide open the phone then press the  key. The handset is also able to warn you of an incoming call while you are already on a call. A tone sounds in the earpiece, and the display will show that a second call is waiting.

This feature, known as **Call waiting**, is only available if your network supports it. For details of how to activate and deactivate it see **Call waiting** (Menu 9.6.4)

If **Call waiting** is activated, you can put the first call on hold and answer the second, by pressing or by selecting the left soft key, then Hold & Answer. You can end the current call and answer the waiting call by selecting the Right soft key and then **End & Answer**.

### Rejecting an incoming call

You can reject an incoming call without answering by simply pressing the  key.

During a call, you can reject an incoming call by pressing the Right soft key [Menu] key and selecting the **Conference/Reject** or by pressing the .

## Muting the microphone

You can mute the microphone during a call by pressing the [Options] key then selecting **Mute on**. The handset can be unmuted by selecting **Mute off**. When the handset is muted, the caller cannot hear you, but you can still hear them.

## Switching DTMF tones on during a call

To turn DTMF tones on during a call, press the left soft key, and then select DTMF on. DTMF tones can be turned off the same way. DTMF tones allow your phone to make use of an automated switchboard.

## Multiparty or conference calls

The multiparty or conference service provides you with the ability to have a simultaneous conversation with more than one caller, if your network operator supports this feature. A multiparty call can only be set up when you have one active call and one call

on hold, both calls having been answered. Once a multiparty call is set up, calls can be added, disconnected or separated (that is, removed from the multiparty call but still connected to you) by the person who set up the multiparty call. These options are all available from the In-Call menu. The maximum callers in a multiparty call are five. Once started, you are in control of the multiparty call, and only you can add callers to the multiparty call.

## Making a second call

You can make a second call while currently on a call. Enter the second number and press the  key. When the second call is connected, the first call is automatically placed on hold. You can swap between calls by pressing the left soft key then selecting **Swap**.

## Setting up a conference call

Place one call on hold and while the active call is on, press the left soft key and then select the **Conference/Join all**.

# In-call menu

## Putting a conference call on hold

Press the left soft key, then select the **Conference/Hold all**.

## Activate the conference call on hold

Press the left soft key, then select the **Conference/Join all**.

## Adding calls to the conference call

To add a call to an existing conference call, press the left soft key, then select the **Conference/Join all**.

## Displaying callers in a conference call

To scroll through the numbers of the callers who make up a conference call on the handset screen, use the up/down navigation keys.

## Taking a private call during a conference call

To have a private call with one caller from a conference call, display the number of the caller you wish to talk to on the screen, then press the left soft key. Select the **Conference/Private** to put all the other callers on hold.

## Ending a conference call

The currently displayed caller from a conference call can be disconnected by pressing the **[E]** key. To end a conference call, press the left soft key, then select the **Conference/End multiparty**.

After pressing the left soft key, selecting all will end all the active and onhold calls.

# Menu Tree

The following illustration shows the available menu structure and indicates the:

- ▶ Number assigned to each menu option, where applicable.

<b>1. Profiles</b>	<b>3. Tools</b>	<b>5. Messages</b>
1.X.1 Activate	3.1 Favourites	5.1 New message
1.X.2 Personalise	3.2 Alarm clock	5.2 Inbox
1.X.3 Rename	3.3 Calculator	5.3 Drafts
	3.4 Unit converter	5.4 Outbox
	3.5 World time	5.5 Listen to voice mail
	3.6 SIM-Menu	5.6 Info message
<b>2. Call register</b>	<b>4. Organiser</b>	5.7 Templates
2.1 Missed calls	4.1 Contacts	5.8 Settings
2.2 Received calls	4.2 Calendar	
2.3 Dialed calls	4.3 Memo	
2.4 All calls		
2.5 Delete recent calls		
2.6 Call charges		
2.7 GPRS information		

# Menu Tree

## 6. Multimedia

- 6.1 Camera
- 6.2 Video camera
- 6.3 Voice recorder
- 6.4 MP3
- 6.5 Photo album
- 6.6 Video album
- 6.7 Settings

## 7. Browser

- 7.1 Home
- 7.2 Bookmarks
- 7.3 Go to URL
- 7.4 Settings

## 8. My stuff

- 8.1 Games & apps
- 8.2 Videos
- 8.3 Photos
- 8.4 Music
- 8.5 Text
- 8.6 Images
- 8.7 Sounds
- 8.8 Others

## 9. Settings

- 9.1 Date & time
- 9.2 Display
- 9.3 Power saving
- 9.4 Language
- 9.5 Connectivity
- 9.6 Calling
- 9.7 Security
- 9.8 Memory status
- 9.9 Reset settings

In Profiles, you can adjust and customise the phone tones for different events, environments, or caller groups.

There are five preset profiles: **General**, **Silent**, **Vibrate only**, **Loud** and **Headset**. Each profile can be personalised. Press the left soft key [Menu] and select **Profiles** using up/down navigation keys.

## Activate (Menu 1.X.1)

1. A list of profiles is displayed.
2. In the Profiles list, scroll to the profile you want to activate and press the left soft key  OK key.
3. Then, select Activate.

## Personalise (Menu 1.X.2)

Scroll to the desired profile in the Profile list. After pressing the left soft key  or the OK key, select **Personalise**. The profile setting option opens. Set the option as required.

- ▶ **Call alert type:** Set the alert type for incoming calls.
- ▶ **Ring tone:** Select the desired ring tone from the list.
- ▶ **Ring volume:** Set the volume of the ringing tone.
- ▶ **Message alert type:** Set the alert type for messages.
- ▶ **Message tone:** Select the alert tone for messages.
- ▶ **Keypad tone:** Select the desired keypad tone.
- ▶ **Keypad volume:** Set the volume of keypad tone.
- ▶ **Slide tone:** Allows you to set the slide tone.
- ▶ **Effect sound volume:** Set the volume of effect sound.
- ▶ **Power on/off volume:** Set the volume of the ringing tone when switching the phone on/off.



# Profiles

## Rename (Menu 1.X.3)

You can rename a profile and give it any name you choose to.

### Note

▶ **Vibrate only, Silent and Headset** profiles cannot be renamed.

1. To change the name of a profile, scroll to the profile in the profile list and after pressing the left soft key  or the OK key, select **Rename**.
2. Key in the desired name and press the OK key or the left soft key  [OK].

# Call register

You can check the record of missed, received, and dialled calls only if the network supports the Calling Line Identification (CLI) within the service area.

The number and name (if available) are displayed together with the date and time at which the call was made. You can also view call times.

## Missed calls

Menu 2.1

This option lets you view the last 10 unanswered calls. You can also:

- ▶ View the number if available and call it, or save it in the Address Book
- ▶ Enter a new name for the number and save both in the Address Book
- ▶ Send a message to this number
- ▶ Delete the call from the list

## Received calls

Menu 2.2

This option lets you view the last 10 incoming calls. You can also:

- ▶ View the number if available and call it or save it in the Address Book
- ▶ Enter new name for the number and save both in the Address Book
- ▶ Send a message to this number
- ▶ Delete the call from the list

## Dialled calls

Menu 2.3

This option lets you view the last 20 outgoing calls (called or attempted).

You can also:

- ▶ View the number if available and call it or save it in the Address Book
- ▶ Enter new name for the number and save both in the Address Book
- ▶ Send a message to this number
- ▶ Delete the call from the list

# Call register

## All calls

Menu 2.4

You can view all lists of outgoing or incoming calls.

## Delete recent calls

Menu 2.5

Allows you to delete missed calls, received calls, dialled calls and all calls.

## Call charges

Menu 2.6

### Call duration (Menu 2.6.1)

Allows you to view the duration of your incoming and outgoing calls. You can also reset the call times.

The following timers are available:

- ▶ **Last call:** Length of the last call.
- ▶ **All calls:** Total length of all calls made and incoming calls since the timer was last reset.

- ▶ **Received calls:** Length of the incoming calls.
- ▶ **Dialled calls:** Length of the outgoing calls.
- ▶ **Reset all:** Allows you to reset the timers of all calls by pressing the left soft key  [Yes].

### Call costs (Menu 2.6.2)

Allows you to check the cost of your last call, all calls, remaining and reset the cost. To reset the cost, you need to know your PIN2 code.

### Settings (Menu 2.6.3) (SIM Dependent)

- ▶ **Set tariff:** You can set the currency type and the unit price. Contact your service providers to obtain charging unit prices. To select the currency or unit in this menu, you need the PIN2 code.
- ▶ **Set credit:** This network service allows you to limit the cost of your calls by selected charging units. If you select **Read**, the number of remaining unit is shown. If you select **Change**, you can change your change limit.

- ▶ **Auto display:** This network service allows you to automatically see the cost of your last calls. If set to **On**, you can see the last cost when the call is released.

## GPRS information Menu 2.7

You can check the amount of data transferred over the network through the GPRS information option. In addition, you can also view how much time you are online.

### Call duration (Menu 2.7.1)

You can check the duration of **Last call** and **All calls**. You can also reset the call timers.

### Data volume (Menu 2.7.2)

You can check The **Sent**, **Received** or **All** data volume. You can also reset all data volume records.

# Tools

## Favourites

Menu 3.1

This option allows you to add your own favourites to the list already provided. Once you create your own menu, you can access the desired function quickly in the idle screen by pressing the up navigation key.

### Note

- ▶ The menu of SMS, MMS, Games & apps, Connectivity, Alarm clock, MP3 and Camera is already provided in your own favourites.

## Alarm clock

Menu 3.2

You can set up to 5 alarm clocks to go off at a specified time.

1. Select **On** and enter the alarm time you want.
2. Select the repeat period: **Once, Mon.-Fri, Mon.-Sat, Everyday.**
3. Select the alarm tone you want and press  [OK].





4. Edit the alarm name and press  [OK].

## Calculator

Menu 3.3

This contains the standard functions such as +, -, x, ÷ : **Addition, Subtraction, Multiplication, and Division.**

Furthermore, you can use the various function of calculator such as +/-, **sin, cos, tan, log, IN, exp, sqrt.**





1. Input the numbers by pressing numeric keys.
2. Use a navigation key to select a sign for calculation.
3. Then input the numbers.
4. Press  key to view the result.
5. To input the decimal number, press  key. If you press  key, you can enter ( ).
6. To end **Calculator**, press the right soft key  [Back].

## Unit converter

Menu 3.4

This converts any measurement into a unit you want. There are 9 types that can be converted into units:

**Currency, Area, Length, Weight, Temperature, Volume, Velocity, Shoes and Clothes.**

1. You can select one of nine unit types by pressing  [OK] key.
2. Select the unit you want to convert by pressing  and . It's impossible to input "-" symbol in unit converter.
3. Select the standard value by using , .

## World time

Menu 3.5

You can check the current time of Greenwich Mean Time (GMT) and major cities around the world, using the left/right navigation keys.

The screen shows the city name, current date and time.

To select the time zone in which you are located, proceed as follows:

1. Select the city corresponding to your time zone by pressing the left/right navigation keys one or more times. The local date and time are displayed.
2. If you want to change the time display in standby mode to the selected time, press the left soft key and select **Set**.

## SIM-Menu

MENU 3.6

This menu depends on SIM and the network services.

### Note

- ▶ In case the SIM card support SAT (i.e. SIM Application Toolkit) services, this menu will be the operator specific service name stored on the SIM card.
- ▶ In case the SIM card does not support SAT services, this menu will be Profiles.

# Organiser

## Contacts

Menu 4.1

### Search contacts (Menu 4.1.1)

1. Select **Search** by pressing the left soft key  [Contacts] or [OK].
2. Enter the name that you want to search.

#### Note

- ▶ Instant searching is available by inputting the initial letter of the name or number you want to search.
- ▶ If your handset has been customized by the operator, (right soft key is not contacts), you can still access the contacts by pressing the menu key (left soft key) followed by Organizer and then press ok.

3. If you want to edit, delete or copy an entry, select the left soft key  [Options]. The following menu will be displayed.
- ▶ **Edit:** You can edit the name, number, group, character and picture by using the navigation key.

- ▶ **Write messages:** After you have found the number you want, you can send a text/multimedia message to the selected number.
- ▶ **Send via Bluetooth:** You can send the data of phone book to devices which is compatible with Bluetooth through Bluetooth.
- ▶ **Copy to handset:** You can copy an entry from SIM to phone or from phone to SIM.
- ▶ **Assign speed dial:** You can assign the entry as a speed dial.
- ▶ **View caller groups:** For further details see (Menu 4.1.3).
- ▶ **Delete:** You can delete an entry.

#### Note





- ▶ To use the Photo Caller ID feature, contacts must exist within the Phone Book and photos must be taken in 72x72 resolution. For more information about associating a photo to a contact please refer to the Camera section.

## Add new (Menu 4.1.2)

You can add a phonebook entry by using this function. Phone memory capacity is 1 000 entries. SIM card memory capacity depends on the mobile service provider. You can also save 40 characters of name in The Phone memory, and save characters in the SIM card. The number of characters is a SIM dependent feature.

### Note

▶ Maximum stored name and number length depends on SIM-card type.

1. Select **Add new** by pressing the left soft key  [OK] or [OK].
2. Select the memory you want to save: **SIM** or **Phone**. If you set to Phone, you need to select which number you want as a main number.
  - a. Press  [OK] to input a name.
  - b. Press  [Save], then you can input a number.
  - c. You can set a group for the entry by pressing , .



d. You can set a picture for the entry by pressing , .

## Caller groups (Menu 4.1.3)



You can add up to 20 members per group, with up to a maximum of 7 groups in total.

- ▶ **Member list:** Shows the group members you have selected.
- ▶ **Group ring tone:** Allows you to specify ring tone for the group members' call.
- ▶ **Group icon:** Allows you to select the icon dependent on Group.
- ▶ **Add member:** You can add group members. Each group should not exceed 20 members.
- ▶ **Remove member:** You can remove the member from the Group member list. But the name and the number will remain in the phonebook.
- ▶ **Rename:** You can change a group name.
- ▶ **Remove all:** Allows you to delete all the members in the group.

## Speed dial (Menu 4.1.4)

Assign contacts to any of the keys  to .

You can then call that contact by pressing the corresponding number key.

1. Open the phonebook first by pressing the right soft key  [Contacts] in standby mode.
2. Scroll to **Speed dial**, then press the left soft key  [OK].
3. If you want to add speed dial, select **(empty)**. Then, you can search the name in phonebook.
4. After assigning the number as speed dial, you can change and delete the entry. You can also make a call or send a message to this number.



## Own number (Menu 4.1.5) (Sim dependent)

You can save and check your own number in SIM card.

## My business card (Menu 4.1.6)

This option allows you to create your own business card featuring Name and a mobile phone number. To create a new business card, press the left soft key  [Add] and enter the information into the fields.

## Settings (Menu 4.1.7)

1. Press the right soft key  [Contacts] in standby mode.
2. Scroll to **Settings**, then press the left soft key  [OK].

### ▶ Default memory

Scroll to highlight **Default memory**, and then press the left soft key  [OK].

- If you select **Always ask**, when adding an entry, the phone will ask where to store it.

- If you select **SIM** or **Handset**, the phone will store an entry to the SIM or phone.



### ▶ View options

Scroll to highlight **View options**, and then press the left soft key  [OK].

- **Name only:** Set the phonebook list by displaying the name only.
- **Name & number:** Set the phonebook list by displaying the name and number.
- **With pictures:** Set the phonebook list with the information and picture of contact.

#### ▶ **Copy/Move all**





You can copy/move entries from SIM card memory to Phone memory and vice versa.

1. Open the Phonebook first by pressing the right soft key  [Contacts] in standby mode.
2. Scroll to **Copy/Move all**, and then press the left soft key  [OK] to enter this menu.
  - **SIM to Handset:** You can copy/move the entries from SIM Card to Phone memory.
  - **Handset to SIM:** You can copy/move the entries from Phone memory to SIM Card.

- ▶ **Memory in use:** This feature allows you to see how many entries are in use, or free in your phonebook.

#### ▶ **Clear contacts**

You can delete all the entries in the SIM and Phone. This function requires the Security code.

1. Scroll to highlight Clear contacts, and then press the left soft key  [OK].
2. Highlight the memory you wish to erase, and then press the left soft key  [OK].
3. Enter the security code and press the left soft key  [OK] or the right soft key  [Back].

#### ▶ **Service dial number**









Use this function to access a particular list of services provided by your network operator (if supported by the SIM card).

## Calendar

Menu 4.2

When you enter this menu a calendar will be displayed. The month and year are shown at the top of the screen. Whenever you change the date under the Settings menu, the calendar will update automatically. The current date will be highlighted in green and any schedule or memos will be indicated with a red triangle at the top left hand corner of the corresponding square. An audible alarm can be set for memo's and reminders.

To change the day, month and year.



Key	Description	Key	Description
 	Yearly	 	Weekly
 	Monthly	 	Daily



In calendar mode, press the left soft key  [Options] as follows;

## Add new (Menu 4.2.1)

Allows you to add a new schedule and memo for the chosen day. You can store up to 20 notes. Input the subject and then press left soft key  [OK]. You enter the appropriate information in the following section; **Time**, **Repeat** and **Alarm**.

## View daily schedules (Menu 4.2.2)

View all schedules and memo for the chosen day. Use  ,  to browse through the note lists. If you set the alarm for a note, the alarm icon is displayed.

If you want to view the note in detail, press the left soft key  [OK]. Press the left soft key  [Options] to delete or edit the note you have selected.

## Delete past (Menu 4.2.3)

You can delete the past schedule that you have already been notified of.

## Delete all (Menu 4.2.4)

You can delete all the notes.

## Go to date (Menu 4.2.5)



You can go the chosen date directly.

## Set alarm tone (Menu 4.2.6)

You can set the alarm tone of each chosen date.

## Memo

Menu 4.3

1. Select the **Memo** by pressing the left soft key  [OK].
2. If the entry is empty, press the left soft key  [Write].
3. Input the memo and then press the left soft key  [OK].

### Note

- ▶ If you want to change the text input mode, press the  in order.

# Messages

## New message

Menu 5.1

This menu includes functions related to SMS (Short Message Service), MMS (Multimedia Message Service), voice mail, as well as the network's service messages.

### Note

- ▶ Please contact your service provider for pricing details for various types (small and large) of messages.

## Write text message (Menu 5.1.1)

You can write and edit text message, checking the number of message pages.

1. Enter the **New messages** menu by pressing the left soft key  [OK].
2. If you want to write a new message, select new message and then write text message.
3. To make text input easier, use T9.
4. Press [Insert] to attach the following:

## Insert

- ▶ **Images:** You can insert the Default graphics or graphics in My pictures that are available for short messages.
- ▶ **Sounds:** You can insert sounds that are available for short messages.
- ▶ **Text templates:** You can use Text templates already set in the phone.
- ▶ **Contacts:** You can add phone numbers or e-mail addresses in the address book.
- ▶ **Symbol:** You can add special characters.
- ▶ **My business card:** You can add your Business card to the message.

5. After you complete the message, to select the required option, press the left soft key  [Options].

## Options

- ▶ **Send:** Sends text messages.
1. Enter numbers of recipient.
  2. Press  key to add more recipients.
  3. You can add phone numbers in the address book.

- Once the numbers have been entered, press the left soft key **[ ]** to send the message. All messages will automatically be saved in the outbox folder, even after a sending failure.
  - ▶ **Save to drafts:** Stores messages in the Drafts folder.
  - ▶ **Font & Alignment:** You can select the **Size** and **Style** of font, and the **Alignment** of text.
  - ▶ **Colour:** You can also set the **Colour** of the text (foreground) and the background.
  - ▶ **Add T9 dictionary:** You can add your own words. This menu will only be shown when the edit mode has been set to T9ABC/T9Abc/T9abc.
  - ▶ **T9 languages:** Select the desired language for T9 input mode. You can also deactivate the T9 input mode by selecting 'T9 off'.
  - ▶ **Exit:** If you press Exit whilst writing a message, you will be taken back to the message menu. Also the written message will not have been saved.

### Note

- ▶ This phone supports EMS release 5, so is available to send colour pictures, sounds, text styles, etc.. If the other parties handsets do not support such options, the pictures, sounds or texts sent may not be displayed correctly on their phones.

## Write multimedia message

(Menu 5.1.2)

A multimedia message can contain text, images, and/or sound clips. This feature can be used only if it is supported by your network operator or service provider. Only devices that offer compatible multimedia message or e-mail features can receive and send multimedia messages.

1. Enter the **New message** menu by pressing the left soft key **[ ]** [OK].
2. If you want to write a new message, select **Write multimedia message**.

# Messages

3. You can create a new message or choose one of the multimedia message templates already made.
4. Press **Insert** to add Image, Sound, Contacts, Symbol, New photo, New sound, Text templates, My business card.

Maximum available file size, that can be inserted to MMS-message, is 100 kb.

## Options

- ▶ **Send:** You can send multimedia messages to multiple recipients, as well as save it to send at a later time.

### Note

- ▶ All messages will be automatically saved in the outbox folder, even after a sending failure.
- ▶ **Preview:** You can preview multimedia messages you have created.
- ▶ **Save:** You can save multimedia messages **To drafts** or **As template**.
- ▶ **Edit subject:** Allows you to modify the multimedia message you have chosen.
- ▶ **Add slide:** You can add a slide before or after current slide.
- ▶ **Move to slide:** You can move to the previous or the next slide.
- ▶ **Delete slide:** You can delete current folders.
- ▶ **Set slide format**
  - **Set timer:** You can set a timer for slide, text, picture and sound.
  - **Swap text and picture:** You can switch the position of picture and text of the message.
- ▶ **Remove media:** You can remove a picture or sound in the slide. This option can be shown only when any media file has been added.
- ▶ **Add T9 dictionary:** You can add your own words. This menu will only be shown when the edit mode has been set to T9ABC/T9Abc/T9abc.

- ▶ **T9 languages:** Select the desired language for T9 input mode. You can also deactivate T9 input mode by selecting 'T9 off'.
- ▶ **Exit:** Will take you back to the Message menu.







### Note

- ▶ When creating a multimedia message, if you upload a picture (50K) you may find that whilst the picture is loading you will not be able to carry out any other actions until the picture has completed loading.

## Inbox

Menu 5.2

You will be alerted when you have received a message. They will be stored in the Inbox. In the Inbox, you can identify each message by icons. For detail, see the icon directive.

Icon	Icon directive
	Multimedia message
	Short message
	SIM message
	Read multimedia message
	Read text message
	Push message
	Notified multimedia message

If the phone shows 'No space for SIM message', you only have to delete the SIM messages from the Inbox. If the phone displays 'No space for message', you will then need to delete messages, media or applications to free up space.

# Messages

## \* SIM message

SIM message means that the message is exceptionally stored in the SIM card. You can move this message to the phone.

When you are notified that you have received a multimedia message, you have to wait for the message to be downloaded before you can view it.

To read a message, select one of the messages by pressing the left soft key [Options].

- ▶ **View:** You can view the received messages.
- ▶ **Reply:** You can reply to the sender.
- ▶ **Forward:** You can forward the selected message to another party.
- ▶ **Delete:** You can delete the current message.
- ▶ **Return call:** You can call back the sender.
- ▶ **Information:** You can view information about received messages; Sender's address, Subject (only for Multimedia message), Message date & time, Message type, Message size.
- ▶ **Delete all:** You can delete all messages.

## Drafts

Menu 5.3

Using this menu, you can preset up to five multimedia messages that you use most frequently. This menu shows the preset multimedia message list.







The following options are available.

- ▶ **View:** You can see the multimedia messages.
- ▶ **Edit:** Allows you to modify the chosen message.
- ▶ **Delete:** Deletes the message you choose.
- ▶ **Information:** To view the information of the message.
- ▶ **Delete all:** Deletes all of the messages in the slide.

## Outbox

Menu 5.4



This menu allows you to view the messages which you have sent, those that are currently sending or messages that have failed sending previously.

Icon	Icon directive
	MMS Unsent
	MMS sent
	MMS delivery confirmed
	SMS unsent
	SMS sent
	SMS delivery confirmed

- ▶ **View:** You can view the message.
- ▶ **Forward:** You can forward the selected message to another party.
- ▶ **Delete:** You can delete the message.
- ▶ **Information:** You can check the information of each message.
- ▶ **Delete all:** You can delete all the messages in the outbox.

## Listen to voice mail

Menu 5.5

Once this menu has been selected, simply press the left soft key  [OK] to listen to voice mail. You can also hold down the  key in standby mode to listen to voice mail.

### Note



- ▶ When you receive a voice mail, your phone will display an icon and you will hear an alert. Please check with your network provider for details of their service in order to configure the handset correctly.

## Info message (Dependent to network and subscription)

Menu 5.6

Info service messages are text messages delivered by the network to your handset. They provide general information such as weather reports, traffic news, taxis, pharmacies, and stock prices. When you receive an info service message, you will see a popup message show you that or the info service message is directly displayed. To view the message again follow the sequence shown below;

### Read (Menu 5.6.1)

1. When you have received an info service message and select Read to view the message, it will be displayed on the screen. You can read another message by scrolling ,  or  [OK].
2. The message will be shown until another message is selected.

## Topics (Menu 5.6.2) (Dependent to network and subscription)

- ▶ **Add new:** You can add Info service message numbers in the Phone memory with its nickname.
- ▶ **View list:** You can see Info service message numbers which you have added. If you press  [Options], you can edit and delete info message categories which you have added.
- ▶ **Active list:** You can select info service message numbers in the active list. if you activate an info service number, you can receive messages sent from the number.

## Templates

Menu 5.7

### Text templates (Menu 5.7.1)

You have 6 text templates as below;

- **Please call me back.**
- **I'm late. I will be there at**
- **Where are you now?**
- **I am on the way.**
- **Top urgent. Please contact.**
- **I love you.**

### Multimedia templates (Menu 5.7.2)

After you have saved a new template, you can use the following options.

- ▶ **View:** You can see multimedia templates.
- ▶ **Delete:** You can delete multimedia templates.
- ▶ **Add new:** Allows you to add new multimedia templates.
- ▶ **Write messages:** You can write and send multimedia messages.

- ▶ **Edit:** You can edit multimedia templates.
- ▶ **Delete all:** Allows you to delete all multimedia messages.

## Settings

Menu 5.8

### Note

- ▶ Feature provided here are network dependant. Fax is not supported.

### Text message (Menu 5.8.1)

- ▶ **Message types:**

**Text, Voice, Fax, Natl. paging, X.400, Email, ERMES**

Usually, the type of message is set to **Text**. You can convert your text into alternative formats. Contact your service provider for the availability of this function.

- ▶ **Validity period:** This network service allows you to set how long your text messages will be stored at the message centre.

# Messages

- ▶ **Delivery report:** If you set to **Yes**, you can check whether your message is sent successfully.
- ▶ **Reply charging:** When a message is sent, it allows the recipients to reply and charge the cost of the reply to your telephone bill.
- ▶ **SMS centre:** If you want to send the text message, you can receive the address of SMS centre through this menu.

## Multimedia message (Menu 5.8.2)

- ▶ **Priority:** You can set the priority of the message you choose.
  - ▶ **Validity period:** This network service allows you to set how long your text messages will be stored at the message centre.
  - ▶ **Subject:** You can enter multimedia messages subject when this menu is on.
- ▶ **Delivery report:** If it is set to **Yes** in this menu, you can check whether your message is sent successfully.
  - ▶ **Auto retrieve:** If you select **On**, you receive multimedia messages automatically. If you select **Off**, you receive only notification message in the inbox and then you can check this notification. If you select **Home network only**, you receive multimedia messages depends on your Home network.
  - ▶ **Network settings:** Your MMS profile details are kept here.
  - ▶ **Permitted message types**
    - Personal:** Personal message.
    - Advertisements:** Commercial message.
    - Information:** Necessary information.

## Voice mailbox number (Menu 5.8.3)

You can receive voicemail if your network service provider supports this feature. When a new voicemail has arrived, the symbol will be displayed on the screen. Please check with your network service provider for details of their service in order to configure the phone accordingly.

- ▶ **Home:** You can listen to voice mails by selecting Home.
- ▶ **Roaming:** Even when you are abroad, you can listen to voice mails if a roaming service is supported.

## Info message (Menu 5.8.4)

### ▶ Receive

**Yes:** If you select this menu, your phone will receive Info service messages.

**No:** If you select this menu, your phone will not receive Info service messages any more.

### ▶ Alert

**Yes:** Your phone will beep when you have received Info service message numbers.

**No:** Your phone will not beep even though you have received info service messages.

### ▶ Languages

You can select the language you want by pressing [On/Off]. Then, the info service message will be shown in the language that you selected.

## Push message (Menu 5.8.5)

You can set the option whether you will receive the message or not.

# Multimedia

## Camera

Menu 6.1

This application enables you to take a still picture. You can take a picture in your desired size, and use it for the contacts photo, home screen and other more general purposes. Once taken, a still image can be sent via Multimedia msg or Bluetooth.

Press the left soft key (☐) to display the following popup menu items.

- ▶ **Brightness:** Determines the brightness.
- ▶ **Size:** Determines the size of an image.
- ▶ **Timer:** Determines the delay time.
- ▶ **Quality:** Determines the quality of an image.
- ▶ **White Balance :** Allows you to change the settings according to the environment.
- ▶ **Album:** Shows the still images taken.
- ▶ **Exit:** To exit the Camera.
- ▶ **Mode:** Determines whether to take a single , multishot or frame shot photo.
- ▶ **Effect:** Determines the special effect to the picture.

- ▶ **Flash:** Determines the flash operation.
- ▶ **Zoom:** Determines the zoom rate.

### Note

- ▶ Frame shots are only available with the pixel resolution set to 176 x 220.
- ▶ Multi shots are only available when the pixel resolution is set to 320 x 240 or 640 x 480.
- ▶ To use the Photo Caller ID feature, you must take photos you wish to associate with your contacts in 72x72 resolution.
- ▶ Once the photo has been taken and saved, go to **Contacts** and select the contact you wish to associate the photo to or select **Add new** to create a new contact (please note that a photo can only be associated with a contact stored in the phone's memory and not on the SIM).
- ▶ Select **Edit**. Unless you wish to edit the name, press OK and then use the navigation keys to highlight the picture tab.

**Note**

- ▶ Use the ◀, ▶ keys to scroll through the photos (please note that only pictures taken in 72 × 72 resolution will be listed here).
- ▶ Once you have selected the photo you wish to use press the left soft key to save this in the contacts profile.
- ▶ The photo will be shown when this particular contact calls you (as long as the contact does not have their telephone number set to hidden).

## Video camera

Menu 6.2

This application enables you to record a video clip. You can play and watch a saved video file while using this function.

Press the left soft key  to display the following popup menu items.

- ▶ **Brightness:** Determines the brightness.
- ▶ **Size:** Determines the size of an image.
- ▶ **Timer:** Determines the delay time.

- ▶ **Quality:** Determines the quality of a video clip.

- ▶ **White Balance :** Allows you to change the settings according to the environment.

- ▶ **Record Time:** Determines the recording time.

- ▶ **Exit:** To exit the Video camera.

- ▶ **Effect:** Determines the special effect to the video clip.

- ▶ **Flash:** Determines the flash operation.

- ▶ **Zoom:** Determines the zoom rate.

## Voice recorder



Menu 6.3

With the voice memo feature you can record up to 20 voice messages and each memo can be up to 20 seconds long.

### Record (Menu 6.3.1)

You can record a voice memo in the Voice recorder menu.

# Multimedia

1. Once recording has started, the message Recording and the remaining time is displayed.
2. If you want to finish recording, press the left soft key  [Save].
3. Key in Voice memo title, press the left soft key  [OK].

## View list (Menu 6.3.2)

The list of voice memos are displayed. You can playback and delete the recorded voice memo.

## MP3

Menu 6.4

The KG800 has an integrated MP3 player built-in. You can enjoy listening to MP3 music files on your phone memory using a compatible headset.

### Note

- ▶ Because of the small dimension of the speaker, in some cases the audio could be distorted, especially at maximum volume and when there are lots of bass sounds. Therefore, we recommend you to use the stereo headset in order to appreciate the high quality of your music.

The music player supports the latest audio formats such as MP3, WMA and M4A.

- MPEG-1 Layer III, MPEG-2 Layer III, MPEG-2.5 Layer III Sampling frequency up from 8KHz to 48KHz. Bit rate up to 320Kbps, stereo.
- AAC: ADIF, ADTS formats (Sampling frequency from 8KHz to 48KHz)
- AAC+: V1 : (Bit rate 16-128Kbps)  
V2 : (Bit rate 16-48Kbps)  
(Sampling frequency from 8KHz to 48KHz)
- MP4, M4A: Sampling frequency up from 8KHz to 48KHz, Bit rate up to 320Kbps, stereo.

- **WMA:** Sampling frequency up from 8KHz to 48KHz, Bit rate up to 320Kbps, stereo.

### Note

- ▶ KG800 doesn't support the variable rate of MP3 and AAC file. Therefore, you can't change the file from VBR MP3 format to AAC.

You can transfer MP3 files from a compatible PC to the memory in your phone using the Mass Storage. When you connect the phone to a PC using the USB cable, this will be displayed as a removable disk through Windows Explorer. If you are using Win98 SE, you will have to install the Mass storage driver for Windows 98 on CD-ROM.

### Note

- ▶ You should copy MP3 to my media\Music folder. If you copy to another folder, you will not be able to view the MP3 files.
- ▶ The PC should run Windows 98 SE, Windows ME, Windows 2000, Windows XP operating system.

This menu allows you to view the whole play list. You can move through the tracks by pressing the navigation key. In addition, once you have selected the track, you can delete the file or view its information via the options menu.

1. **Go to MP3 player :** Move to MP3 player.

Press the left soft key  [Options] to access the following menus.

- ▶ **View play list:** You can view the play list on listening to the music.
- ▶ **Area repeat:** The special area part of the current music is repeated when you select ON of the menu.

# Multimedia

▶ **Set as ring tone:** This menu allows to set the MP3 file as a ring tone. You can also set it as a ring tone in Profile.

▶ **Setting**

- **Equalizer**

This menu helps you to adjust to a variety of environments when listening to music. This phone supports four preset menus. When you enter this menu, you can view current value of equalizer.

- **Playmode**

This menu allows to set the play mode.

- **Set shuffle**

You can listen to your MP3 music randomly.

- **Visual effect**

You can select the visual effect menus: Rainbow, Basic and Blue. This menu allows to change the background of the main LCD on playing MP3 file.

2. **Delete:** Deletes the file selected.

3. **View details:** To view the information of the file you selected.

4. **Delete all:** Deletes all of the files.

## Note

▶ Music is copyright protected in international treaties and national copyright laws. It may be necessary to obtain permission or a license to reproduce or copy music. In some countries national law prohibits private copying of copyrighted material. Please check the national legislation of the applicable country concerning the use of such material.

## Photo album

Menu 6.5

You can view and send a picture. In addition, you can set the picture as a wallpaper.

▶ **Multi view:** You can view the maximum of 9 thumbnails in a screen.

▶ **Send via Bluetooth:** You can send a picture by Bluetooth.

- ▶ **Write multimedia message:** You can write and edit multimedia messages, checking message size.
- ▶ **Set as wallpaper:** You can set a picture as a wallpaper.
- ▶ **Slide show:** You can view the pictures in a slide show.
- ▶ **Delete:** You can delete a picture.
- ▶ **Edit title:** You can edit the title of picture.
- ▶ **Information:** Displays information about the saved picture.

### Note

- ▶ The Photo Album will only display pictures taken by the handsets camera.

## Video album

Menu 6.6

You can view videos which have been saved in the memory.

- ▶ **Play:** You can play the video file when pressing the OK key or selecting Play menu of the Options menu.

- ▶ **Send via Bluetooth:** Send the selected file to another device via Bluetooth.
- ▶ **Rename:** Change the file name of selected file.
- ▶ **Delete:** Delete a file.
- ▶ **Delete all:** Delete all files in the list
- ▶ **Information:** Show the file information.

## Settings

Menu 6.7

### Camera (Menu 6.7.1)

- ▶ **Auto save:** If you set this feature to On, the images will be saved automatically without displaying the menu bar to save.
- ▶ **Delete all photos:** You can delete all the photos which have been saved in the memory.

### Video camera (Menu 6.7.2)

- ▶ **Delete all videos:** Allows you to delete all the videos which have been saved in the memory.

# Browser

## Note

- ▶ This name may be changed depending on your network's requirements.

You can access various WAP (Wireless Application Protocol) services such as banking, news, weather reports and flight information. These services are specially designed for mobile phones and they are maintained by WAP service providers.

Check the availability of WAP services, pricing and tariffs with your network operator and/or the service provider whose service you wish to use. Service providers will also give you instructions on how to use their services.



Once connected, the homepage is displayed. The content depends on the service provider. To exit the browser at any time, press the  key. The phone will return to the idle menu.

## Navigating with the WAP browser

You can surf the Internet using either the phone keys or the WAP browser menu.

## Using the phone keys

When surfing the Internet, the phone keys function differently to phone mode.

Key	Description
	Scrolls each line of the content area
	Returns to the previous page
	Selects options and confirmptions and confirms actions

## Using the WAP browser menu

There are various menu options available when surfing the Mobile Web.

## Note

- ▶ The WAP browser menus may vary, depending on your browser version.

## Home

Menu 7.1

Connects to a homepage. The homepage will be the site which is defined in the activated profile. It will be defined by the service provider if you have not defined it in the activated profile.

## Bookmarks

Menu 7.2

This menu allows you to store the URL of favourite web pages for easy access at a later time.

### To create a bookmark

1. Press the left soft key  [Options].
2. Select Add new and press the OK key.
3. After entering the desired URL and title, press the OK key.

After selecting a desired bookmark, the following options are available.

- ▶ **Connect:** Connects to the selected bookmark.
- ▶ **Add new:** Select this to create a new bookmark.

- ▶ **Edit:** You can edit the URL and/or the title of the selected bookmark.
- ▶ **Delete:** Deletes the selected bookmark.
- ▶ **Delete all:** Deletes all the bookmarks.

## Go to URL

Menu 7.3

You can connect directly to the site you want. After entering a specific URL, press the OK key.

## Settings

Menu 7.4

You can set the profile, cache, cookie and security related to internet service.

### Profiles (Menu 7.4.1)

A profile is the network information used to connect to the Internet. There are default profiles for some operators, stored in phone memory. It's impossible to rename default profiles.

Each profile has submenus as follows:

- ▶ **Activate:** Activates the selected profile.
- ▶ **Settings:** Use this to edit and change WAP settings for the selected profile.

- **Homepage:** This setting allows you to enter the address (URL) of a site you want to use as homepage. You do not need to type http:// at the front of each URL as the WAP Browser will automatically add it.

- **Bearer:** You can set the bearer data service. 1 Data/2 GPRS

- **Data settings:** Appears only if you select Data Settings as a Bearer/service.

**Dial number:** Enter the telephone number to dial to access your WAP gateway.

**User ID:** The users identity for your dial-up server (and NOT the WAP gateway).

**Password:** The password required by your dial-up server (and NOT the WAP gateway) to identify you.

**Call type:** Select the type of data call : Analogue of Digital (ISDN).

**Linger time:** You need to enter timeout period. After entering that, the WAP navigation service will be unavailable if any data is not input or transferred.

- **GPRS settings:** The service settings are only available when GPRS is chosen as a bearer service.

**APN:** Input the APN of the GPRS.

**User ID:** The users identify for your APN server.

**Password:** The password required by your APN server.

- **Proxy settings**

**Proxy:** Activates or cancels proxy.

**IP address:** Input the IP address of the Proxy server you access.

**Port number:** Input the Proxy Port.

- **DNS settings**

**Primary server:** Input the IP address of the primary DNS server you access.

**Secondary server:** Input the IP address of the secondary DNS server you access.

- ▶ **Rename:** You can change the profile name.
- ▶ **Add new:** You can add a new profile.
- ▶ **Delete:** Deletes the selected profile from the list.

### Cache (Menu 7.4.2)

The information or services you have accessed are saved in the cache memory of the phone.

### Cookie (Menu 7.4.3)

The information or services you have accessed are saved in the cache memory of the phone.

### Clear cache (Menu 7.4.4)

Removes all context saved in cache.

#### Note

- ▶ A cache is a buffer memory, which is used to save data temporarily.

### Clear cookie (Menu 7.4.5)

Removes all context saved in cookie.

### Security (Menu 7.4.6)

A list of the available certification is shown.

- ▶ **Authority:** You can see the list of authority certificates that have been stored in your phone.
- ▶ **Personal:** You can see the list of personal certificates that have been stored in your phone.

# My stuff

## Games & apps

Menu 8.1

### Games & apps (Menu 8.1.1)

- **Default Games:** In this menu, you can manage the Java applications installed in your phone. You can play or delete downloaded applications, or set the connect option. The downloaded applications are organised in folders. Press the left soft key [OK] to open the selected slide or launch the selected midlet.

After selecting a folder, press [Options] and then sub menus available to several options are displayed.

- ▶ **Open:** You can see the stored games.
- ▶ **New folder:** Create a new slide.

Java™, is a technology developed by Sun Microsystems. Similar to the way you would download the Java Applet using the standard MS Internet Explorer browsers, Java MIDlet can be downloaded using a WAP enabled phone. Depending on the service provider, all Java based programs such as Java games can be downloaded and run on a phone. Once downloaded, the Java program can be viewed in the **Games & Apps** menu where you can select, execute, or delete. The Java program files saved in the phone are in .JAD or .JAR format.

### Profiles (Menu 8.1.2)

A profile is the network information used to connect to the Internet.

If you want to see the details of a profile, please refer to Menu 7.4.1.

## Note

- ▶ The JAR file is a compressed format of the Java program and the JAD file is a description file that includes all detailed information. From the network, prior to download, you can view all detailed file descriptions from the JAD file.
- ▶ While being based on a standard language (J2ME), not all Java applications are compatible with all handsets on sale insofar as specific libraries may be used for a telephone model. The software may be blocked or switch itself on when Java applications not specifically developed for the phone this manual refers to are downloaded, making it necessary to “restart” the handset. We would like to point out that these problems are caused by incompatible applications and are not a product fault.

## CAUTION!

*Only J2ME(Java 2 Micro Edition) based programs will run in a phone environment. The J2SE(Java 2 Standard Edition) based programs will only run in a PC environment.*

There is Mass Storage function in the KG800. If you connect the USB cable, you can use the phone as a Removable Disk.

You can download MP3 files, and photos, video, txt files etc. this gives you fast access from PC to Phone, by just connecting the USB cable.

This function does not require the installation of additional software.

1. Whilst the phone is displaying the standby screen, connect the phone to the PC using the supplied USB cable. The PC should recognise the handset within a few seconds.
2. The phone will display « USB » on the screen.
3. The phone will be identified as « Removable disk » in My Computer. The PC should then treat the KG800 as a standard drive allowing you to place files to and from the handset's memory. You can either use Window's drag and drop or copy and paste methods to transfer content.

# My stuff

4. Double click on « Removable disk » and open. A folder called My media will be displayed. Within that folder there are a further 5 folders. Do not disconnect the phone whilst a file transfer is in progress, doing so may damage the memory and corrupt the file.
5. When you want to disconnect the phone from your PC, use Windows to safely remove the hardware and then disconnect the USB cable from the handset.

- ▶ If you receive a call whilst in mass storage mode, the call will be rejected. Once the handset is disconnected, the KG800 will display information about any calls missed.

## My media

In the My media folder you will find the following 5 folders; Music, Others, Photos, Text and Videos.

Do not change the names of these folders, doing so will cause content stored in them to not be seen by the handset.

## Music

- ▶ You can store music files in this folder.
- ▶ The supported formats are: MP3, AAC, AAC+, AAC++, WMA, MP4 (audio), Wav.
- ▶ The files in this folder can be played using the MP3 player and Playlist features of the phone.
- ▶ If you download an MP3 file to a different folder, it will be not be possible for the phone to locate and play the file.
- ▶ Do not create subfolders here because the MP3 files contained in that folder will not be found and, therefore, will unable to be played by the music player.
- ▶ To set an MP3 file as a ringtone then please do the following on the handset: options>Go to MP3 player>options>set as ringtone.

## Others

- ▶ Any type of file can be stored here. This folder is mainly used for transporting files from one PC to another.
- ▶ The handset can preview JPG (Max 460K), GIF (Max 160K).
- ▶ You can set an image file as wallpaper as long as it does not exceed 30k in size, for other formats please use the PC Suite.

## Photos

- ▶ This folder is reserved for pictures taken using the phone's digital camera.
- ▶ Even though photos can be uploaded to this folder from your PC, they will not be available on the phone's photo album or My photos folder. Therefore, we recommend that no photos are uploaded to this folder.

## Text

- ▶ This folder supports .txt files. If you place non .txt files here then the handset will not display them.

## Videos

- ▶ You can download videos taken with the phone's digital camera onto the PC and upload new videos onto the phone.
- ▶ This folder supports the 3GP file format.
- ▶ you can upload files and fill the memory.
- ▶ Files stored in this folder can be accessed by doing the following on the handset: Menu>Multimedia>Video album.

## Videos

Menu 8.2

Show the list of 3GP and MP4 files .

### Note

- ▶ MP4 files are not playable.

- ▶ **Play:** You can play the video file by pressing the OK key or selecting Play from the Option menu.
- ▶ **Send via Bluetooth:** Send the selected file to another device via Bluetooth.
- ▶ **Rename:** change the file name of the selected file. The maximum length of characters is 200. And You can not change the extension of file.

### WARNING!

*The following characters, \/: \* ? " < > | can not be used.*

- ▶ **Delete:** Delete a file.
- ▶ **Delete all:** Deletes all the files in the list
- ▶ **Information:** Shows the file information.

## Photos

Menu 8.3

Shows the list of JPG files.

- ▶ **View:** You can see the JPG file by pressing the OK key or selecting View from the Option menu.

### Note

- ▶ The maximum size of JPG file you can see is 460Kbytes.

- ▶ **Send via multimedia message:** You can write and send multimedia messages.
- ▶ **Send via Bluetooth:** Send the selected file to another device via Bluetooth.

### Note

- ▶ To setup .JPG (.JPEG) file from Photo slide as wallpaper, go to Menu-Multimedia-Photo album and then please select Set as wallpaper in Options menu.

- ▶ **Rename:** change the file name of selected file. The maximum length of characters is 200. And You can not change the extension of file.
- ▶ **Delete:** Delete a file.
- ▶ **Delete all:** Deletes all the files in the list
- ▶ **Information:** Shows the file information.

## Music

Menu 8.4

Shows the list of MP3, MP4, AAC, M4A and WMA files.

- ▶ **Play:** You can play the MP3 file by pressing the OK key or selecting Play from the Option menu.
- ▶ **Send via Bluetooth:** Send the selected file to another device via Bluetooth
- ▶ **Rename:** change the file name of selected file. The maximum length of characters is 100. And You can not change the extension of file.
- ▶ **Delete:** Delete a file.

- ▶ **Delete all:** Deletes all files in the list
- ▶ **Information:** Shows the file information.

## Text

Menu 8.5

Show the list of TXT files.

- ▶ **View:** You can see the TXT file by pressing the OK key or selecting View from the Option menu.

### Note

- ▶ The maximum size of TXT file you can see is 460Kbytes.

- ▶ **Send via Bluetooth:** Send the selected file to another device via Bluetooth.
- ▶ **Rename:** change the file name of selected file. The maximum length of characters is 100. And You can not change the extension of file.
- ▶ **Delete:** Delete a file.
- ▶ **Delete all:** Delete all files in the list
- ▶ **Information:** Show the file information.

## Images

Menu 8.6

After selecting a image, press the left key  [View] and then you can check the options as follow:

- ▶ **Set as wallpaper:** Currently selected image can be set as a wallpaper.
- ▶ **Write messages:** The images downloaded from the network can be sent by Multimedia MMS. Maximum message size is 100 kb for MMS message and bluetooth.
- ▶ **Send via Bluetooth:** The sound downloaded from network can be sent by Bluetooth.

## Sounds

Menu 8.7

After selecting a sound, press the left key [Options].

You can check the options as follow:

- ▶ **Set as ringtone:** Currently selected sound can be set as a ringtone.
- ▶ **Write messages:** The sound downloaded from network can be sent by SMS or MMS. Maximum MMS message is 100 kb.
- ▶ **Send via Bluetooth:** The sound downloaded from network can be sent by Bluetooth.

## Others

Menu 8.8

Any type of file can be stored here. This folder is mainly used for transporting files from one PC to another.

- ▶ **View:** You can view a file if it is one of the following types; JPG, GIF, WBMP, PNG and TXT. The handset can preview JPG (Max 460K), GIF (Max 100K).
- ▶ **Send via Bluetooth:** Send the selected file to another device via Bluetooth

# Settings

## Date & time

Menu 9.1

You can set functions relating to the date and time.

### Date (Menu 9.1.1)

#### Set date

You can enter the current date.

#### Date format

You can set the Date format such as DD/MM/YYYY, MM/DD/YYYY, YYYY/MM/DD.  
(D: Day / M: Month / Y: Year)

### Time (Menu 9.1.2)

#### Set time

You can enter the current time.

#### Time format



You can set the time format between 24-hour and 12-hour.

## Display

MENU 9.2

### Wallpaper (Menu 9.2.1)

You can select the background pictures in standby mode.

- ▶ **Default:** You can select a picture or an animation of wallpaper by pressing  or .
- ▶ **My folder:** You can select a picture or an animation as wallpaper.

### Menu colour (Menu 9.2.2)

Your phone provides you with 2 menu colour themes. Set the menu colour by scrolling and pressing the left soft key  [OK].

### Standby text (Menu 9.2.3)

If you select **On**, you can edit the text which is displayed in standby mode.

## Backlight (Menu 9.2.4)

You can set the light-up duration of the display.

## Brightness (Menu 9.2.5)

The screen brightness can be adjusted from 40% to 100%.

## Network name (Menu 9.2.6)

If this function is activated, network name will be displayed on main LCD.

## Home screen shortcut (Menu 9.2.7)

Selecting On displays the functionalities of 4 Navigation keys and Menu key as pictures on the middle of the idle window.

## Dial font colour (Menu 9.2.8)

You can set the colour of displayed number when press the number keys in idle state for call connection.

## Power saving

Menu 9.3

This function saves battery power by keeping backlight brightness to max 40%.

## Language

Menu 9.4

You can change the language for the display texts in your phone. This change will also affect the Language Input mode.

## Connectivity

Menu 9.5

### Bluetooth (Menu 9.5.1)

Bluetooth enables compatible mobile devices, peripherals and computers that are in close proximity to communicate directly with each other without wires. This handset supports built-in Bluetooth connectivity, which makes it possible to connect them with compatible Bluetooth headsets, computer applications and so on.

## Note

- ▶ When you receive data from another Bluetooth device, the phone requests confirmation. After confirming the transfer, the file will be copied on to your phone.
- ▶ Depending on the file type, it will be stored in the following folders:
  - **MP3 (.mp3, mp4, aac, m4a, wma):** Music folder.
  - **Video (.3GP, MP4):** video folder.
  - **Phonebook contacts (.VCF):** Phonebook.
  - **Text (.txt):** Text folder.
  - **Other files (\*.\*):** File storage folder.
- ▶ The handset normally operates with WIDCOMM driver(version 1.4.3.4) or WIDCOMM driver(version 1.4.2.10). And it does not support the LG Contents Bank with Bluetooth.

## Set Bluetooth

You can activate or cancel the Bluetooth function.

## Paired devices/Handsfree devices

You can view all devices which your KG800 is already paired to.

If you have entered Paired devices or Handsfree devices, you will see the following options in both those menus.

- ▶ **Connect/Disconnect:** Allows you to connect to your paired Bluetooth devices.
- ▶ **Add new:** Allows you to search for new Bluetooth devices and add them to your phone's list of paired devices. When you select **Add new** your handset will start to search for Bluetooth devices within range. Once the device you wish to pair appears on the list press the right soft key [Stop]. Scroll to the desired device and press the left soft key [Pair]. You will then be asked to enter a passcode. The passcode can be any code you wish to use (the same passcode must be used by both devices) or is one that is pre-determined by the

manufacturer of the device you are trying to pair with. Please check the User Manual of the device you are initiating the pair with to see if it already has a predetermined passcode in place.

- ▶ **Assign name:** Allows you to change the name of the paired Bluetooth device and how it is displayed on the handset.
- ▶ **Set as authorised/Set as unauthorised:** Allows you to set an authorised connection between each Bluetooth device. For example if you regularly use a Bluetooth headset with your phone then setting the connection as authorised will mean the headset will automatically connect to the handset each time the headset is powered on.
- ▶ **All services:** Allows you to view all services which are supported by a Bluetooth device.
- ▶ **Delete:** Allows you to delete a paired Bluetooth device.

- ▶ **Delete all:** Allows you to delete all paired Bluetooth devices.

## Settings

### ▶ My handset's visibility

This indicates whether or not your handset will be visible to other Bluetooth devices.

### ▶ My handset's name

You can set the name of your Bluetooth device. The default name is LG KG800.

## Supported services

Displays a list of Bluetooth services the handset supports.

- ▶ **Headset**
- ▶ **Handsfree kit**
- ▶ **File transfer**
- ▶ **Image printing**
- ▶ **Dial-up networking**
- ▶ **Business card transfer**
- ▶ **Browsing other device**
- ▶ **Serial Port Profile**

# Settings

## Modem (Menu 9.5.2)

You can access the network services through the Modem. If you want to use the LG PC Sync, Contents bank or Internet Cube, you should access the menu and activate the modem and then plug in the USB cable.

## Network (Menu 9.5.3)

You can select a network which will be registered either automatically or manually. Usually, the network selection is set to **Automatic**.

### Network selection

You can select a network type.

- ▶ **Automatic:** If you select Automatic mode, the phone will automatically search for and select a network for you. Once you have selected “Automatic”, the phone will be set to “Automatic” even though the power is off and on.

- ▶ **Manual:** The phone will find the list of available networks and show you them. Then you can select the network which you want to use if this network has a roaming agreement with your home network operator. The phone let you select another network if the phone fails to access the selected network.
- ▶ **Preferred:** You can set a list of preferred networks and the phone attempts to register with first, before attempting to register to any other networks. This list is set from the phone’s predefined list of known networks.

### Band selection

- ▶ **EGSM/DCS:** Depending on Network situation, you can select EGSM/DCS.
- ▶ **PCS only:** Depending on Network situation, you can select PCS only.

## GPRS attach (Menu 9.5.4)

You can set GPRS service depending on various situations.

### Switch on

If you select this menu, the phone is automatically registered to a GPRS network when you switch the phone on. Starting a WAP or PC dial-up application created the connection between phone and network and data transfer is possible. When you end the application, GPRS connection is ended but the registration to the GPRS network remains.

### When needed

If you select this menu, the GPRS connection is established when you connect a WAP service and closed when you end the WAP connection.

## Calling

Menu 9.6

### Call divert (Menu 9.6.1)

The Call divert service allows you to divert incoming voice calls, fax calls, and data calls to another number. For details, contact your service provider.

#### ▶ All voice calls

Diverts voice calls unconditionally.

#### ▶ If busy

Diverts voice calls when the phone is in use.

#### ▶ If no reply

Diverts voice calls which you do not answer.

#### ▶ If out of reach

Diverts voice calls when the phone is switched off or out of coverage.

#### ▶ All data calls

Diverts to a number with a PC connection unconditionally.

# Settings

## ▶ All fax calls

Diverts to a number with a fax connection unconditionally.

## ▶ Cancel all

Cancels all call divert service.

## The submenus

Call divert menus have the submenus shown below.

### • Activate

Activate the corresponding service.

### To voice mail centre

Forwards to message centre. This function is not shown at All data calls and All fax calls menus.

### To other number

Inputs the number for diverting.

### To favourite number

You can check back to last five diverted numbers.

### • Cancel

Deactivate the corresponding service.

### • View status

View the status of the corresponding service.

## Answer mode (Menu 9.6.2)

### ▶ Slide up

If you select this menu, you can receive an incoming call when you open the slide.

### ▶ Any key

If you select this menu, you can receive a call by pressing any key except  [End] key.

### ▶ Send key only

If you select this menu, you can receive a call by only pressing  [Send] key.

## Send my number (Menu 9.6.3) (network and subscription dependent)

### ▶ Set by network

If you select this, you can send your phone number depending on your network's default settings.

▶ **On**

You can send your phone number to another party. Your phone number will be shown on the receiver's phone.

▶ **Off**

Your phone number will not be shown.

## Call waiting (Menu 9.6.4) (network dependent)

▶ **Activate**

If you select Activate, you can accept a waiting (receiving) call.

▶ **Cancel**

If you select Cancel, you cannot recognize the waiting (receiving) call.

▶ **View status**

Shows the status of Call waiting.

## Minute minder (Menu 9.6.5)

If you select On, you can check the call duration by a beep sound given every minute during a call.

## Auto redial (Menu 9.6.6)

▶ **On**

When this function is activated, the phone will automatically try to redial in the case of failure to connect a call.

▶ **Off**

Your phone will not make any attempts to redial when the original call has not connected.

## Security

Menu 9.7

### PIN code request (Menu 9.7.1)

In this menu, you can set the phone to ask for the PIN code of your SIM card when the phone is switched on.

If this function is activated, you'll be requested to enter the PIN code.

1. Select PIN code request in the security settings menu, and then press  [OK].
2. Set **Enable/Disable**

3. If you want to change the setting, you need to enter PIN code when you switch on the phone.
4. If you enter wrong PIN code more than 3 times, the phone will lock out. If the PIN is blocked, you will need to key in PUK code.
5. You can enter your PUK code up to 10 times. If you put wrong PUK code more than 10 times, you can not unlock your phone. You will need to contact your service provider.

## Handset lock (Menu 9.7.2)

You can use a security code to avoid unauthorised use of the phone. Whenever you switch on the phone, the phone will request security code if you set phone lock to **When switch on**.

If you set phone lock to **When SIM changed**, your phone will request security code only when you change your SIM card.

### Note

- ▶ The phone must have the original network operator SIM card to unlock the handset.

## Call barring (Menu 9.7.3)

The Call barring service prevents your phone from making or receiving certain category of calls. This function requires the call barring password. You can view the following submenus.

- ▶ **All outgoing calls**  
The barring service for all outgoing calls.
- ▶ **Outgoing international**  
The barring service for all outgoing international calls.
- ▶ **Outgoing international when roaming**  
The barring service for all international outgoing calls except home network.
- ▶ **All incoming**  
The barring service for all incoming calls.
- ▶ **Incoming when roaming**  
The barring service for all incoming calls when roaming.
- ▶ **Cancel all**  
You can cancel all barring services.
- ▶ **Change password**  
You can change the password for Call Barring Service.

### The submenus:

- **Activate**

Allows to request the network to set call restriction on.

- **Cancel**

Set the selected call restriction off.

- **View status**

View the status whether the calls are barred or not.

### Fixed dial number (Menu 9.7.4) (SIM dependent)

You can restrict your outgoing calls to selected phone numbers. The numbers are protected by your PIN2 code. The numbers you wish to allow access to once this service has been enabled, must be added to the contacts after enabling Fixed dial number.

- ▶ **Enable**

You can restrict your outgoing calls to selected phone numbers.

- ▶ **Disable**

You can cancel fixed dialling function.

- ▶ **Number list**

You can view the number list saved as Fixed dial number.

### Change codes (Menu 9.7.5)

PIN is an abbreviation of Personal Identification Number to prevent use by unauthorised person. You can change the access codes: **Security code**, **PIN code**, **PIN2 code**.

1. If you want to change the Security code/PIN1 / PIN2 code input your original code, and then press  [OK].
2. Input new Security code/PIN1/PIN2 code and verify them.

### Touchpad lock (Menu 9.7.6)

Sets whether to use the touch pad when closing a slide.

**On:** It is impossible to activate the touch pad with slide closed. (You can use the touch pad only when slide opens.)

**Off:** It is possible to activate the touch pad using the Volume key even with slide closed.

# Settings

## Memory status

Menu 9.8

You can check free space and memory usage of each repository, internal memory and Multimedia memory. You can go to each repository menu.

## Reset settings

Menu 9.9

You can initialise all factory defaults. You will need the Security code to activate this function.

- ▶ **Restore default settings:** Allows you to restore the phone back to its default settings.
- ▶ **Clear multimedia memory:** Allows you to format the multimedia memory and create a default directory.

There are various accessories for your mobile phone. You can select these options according to your personal communication requirements.

## Travel Adapter

This charger allows you to charge the battery while away from home or your office.



## Standard Battery



## Data cable/CD

You can connect your phone to PC to exchange the data between them.



## Hands free ear-microphone and music player controller combo



### Stereo headset

**Controller:** Answer & End button, music player control, volume control, Hold button and microphone.

After connecting the headset and the controller, plug the end of controller into the headset jack on the right side of the phone.

### Note

- ▶ Always use genuine LG accessories.
- ▶ Failure to do so may invalidate your warranty.
- ▶ Accessories may vary in different regions; please check with our regional service company or agent for further information.

# Technical Data

## General

**Product name:** KG800

**System :** GSM 900 / DCS 1800 / PCS 1900

## Ambient Temperatures

**Max:** +55°C

**Min:** -10°C

# Declaration of Conformity



## Suppliers Details

### Name

LG Electronics Inc

### Address

: LG Twin Tower 20, Yeouido-dong, Yeongdeungpo-gu Seoul, Korea 150-721

## Product Details

### Product Name

E-GSM 900 / DCS 1800 / PCS 1900 TH Band Terminal Equipment

### Model Name

KG800/KG808/MG800C

### Trade Name

LG

CE 0168

## Applicable Standards Details

### R&TTE Directive 1999/5/EC

EN 301 489-01 v1.6.1 / EN 301 489-07 v1.3.1 / EN 301 489-17 v.1.2.1  
EN 300 328 V 1.6.1  
EN 60950-1 : 2001  
EN 60960/EN 60361 : 2001  
3GPP TS 51.010-1, EN 301 511 V9.0.2

## Supplementary Information

The conformity to above standards is verified by BABT.

## Declaration

I hereby declare under our sole responsibility that the product mentioned above to which this declaration relates complies with the above mentioned standards and Directives

### Name

Jin Seog, Kim / Director

### Issued Date

27.Feb. 2006

LG Electronics Inc. Amsterdam Office  
Veluwezoom 15, 1327 AE Almere, The Netherlands  
Tel : +31 - 36-547 - 8940, e-mail : eockim @ lge.com

  
Signature of representative

# Manufacturer's Warranty

## 1. WHAT THIS WARRANTY COVERS:

LG offers you a warranty that the enclosed Product and its enclosed accessories will be free from defects in material and workmanship according to the following terms and conditions:

- (1) The warranty for the Product is for ONE (1) year beginning on the date of purchase of the Product.
- (2) The warranty extends only to the original consumer purchaser of the Product ("Customer") and is not assignable or transferable to any subsequent customer. LG offers a warranty for genuine LG battery packs, extending SIX (6) months from the date of purchase.
- (3) This warranty is good only to the Customer during the warranty period as long as it is in AUSTRALIA.
- (4) During the warranty period, any defective LG Product or part will be repaired or replaced by LG or its authorised service centre, at LG's option, with new or factory rebuilt replacement items. LG or the authorised service centre will return the Product to the Customer in working condition. No charge for either parts or labour in repair or replacement of the Product will be incurred by the Customer. If parts, boards or equipment are replaced, they shall become the property of LG.
- (5) Upon request from LG, the Customer must provide LG with proof of the date of purchase.
- (6) The Customer will bear the cost of transporting, delivering and handling the Product to and from LG or its authorised service centre.
- (7) The benefits available from this warranty are in addition to all applicable statutory rights.

## 2. WHAT THIS WARRANTY DOES NOT COVER:

- (1) Defects or damage resulting from use of the Product in other than its normal and customary manner.
- (2) Defects or damage from abnormal use, abnormal conditions, improper storage, exposure to moisture or dampness, unauthorised modifications, unauthorised connections, unauthorised repair, misuse, neglect, abuse, accident, alteration, improper installation, or other acts which are not the fault of LG, including damage caused by shipping, blown fuses, spills of food or liquid.
- (3) Breakage or damage to antennas, unless caused directly by defects in material or workmanship.
- (4) If the Customer does not notify LG of the alleged defect or malfunction of the Product during the applicable warranty period, the Customer shall have no coverage or benefits under this warranty.
- (5) Products which have had the serial number removed or made illegible.

- (6) If the battery short circuits or the seals of the battery are broken or show evidence of tampering, or the battery was used in equipment in a manner other than that which has been specified, the Customer shall have no coverage or benefits under this warranty.
- (7) Damage resulting from use of non-LG approved accessories.
- (8) All plastic surfaces and all other externally exposed parts that are scratched or damaged due to normal use.
- (9) Products operated outside published maximum ratings.
- (10) Products used or obtained in a rental program.
- (11) Consumables (such as fuses.)
- (12) Defects or damage resulting from breakage of or tampering with the LCD screen.
- (13) Where applicable, Products that have been subject to an unauthorised removal or deactivation of the network operator lock function.

### **3. STATEMENT**

Except for those terms that cannot by law be excluded, all terms other than those expressly contained in this warranty statement are excluded. To the extent permitted by law, LG excludes all liability (whether in contract, tort or otherwise) for any consequential, special, incidental or indirect loss or damage including loss of profit, loss or impairment of privacy of conversations, work stoppage or loss or impairment of data arising out of the use or inability to use the Product.

### **4. HOW TO GET WARRANTY SERVICE:**

To obtain information regarding warranty service, please call the following telephone number from anywhere in AUSTRALIA:

LG Electronics Australia Pty Ltd  
2 Wonderland Drive  
Eastern Creek NSW 2766  
PO Box 212  
HORSLEY PARK NSW 2175  
Tel: 1800-638-080      Fax: 02-8805-4201



**LG Electronics Australia Pty Ltd.**





